



FCC RADIO TEST REPORT

FCC ID : A4RGR83Y
Equipment : Phone
Model Name : GR83Y
Applicant : Google LLC
1600 Amphitheatre Parkway,
Mountain View, California, 94043 USA
Standard : FCC Part 15 Subpart C §15.247

The product was received on Dec. 20, 2023 and testing was performed from Jan. 05, 2024 to May 04, 2024. We, Sporton International Inc. Wensan Laboratory, would like to declare that the tested sample has been evaluated in accordance with the test procedures and has been in compliance with the applicable technical standards.

The test results in this report apply exclusively to the tested model / sample. Without written approval from Sporton International Inc. Wensan Laboratory, the test report shall not be reproduced except in full.

Louis Wu

Approved by: Louis Wu

Sporton International Inc. Wensan Laboratory

No.58, Aly. 75, Ln. 564, Wenhua 3rd, Rd., Guishan Dist., Taoyuan City 333010, Taiwan (R.O.C.)



Table of Contents

History of this test report..... 3

Summary of Test Result..... 4

1 General Description 5

 1.1 Product Feature of Equipment Under Test.....5

 1.2 Modification of EUT7

 1.3 Testing Location7

 1.4 Applicable Standards.....7

2 Test Configuration of Equipment Under Test 8

 2.1 Carrier Frequency and Channel8

 2.2 Test Mode.....9

 2.3 Connection Diagram of Test System.....11

 2.4 Support Unit used in test configuration and system12

 2.5 EUT Operation Test Setup12

 2.6 Measurement Results Explanation Example.....13

3 Test Result 14

 3.1 6dB and 99% Bandwidth Measurement14

 3.2 Output Power Measurement.....15

 3.3 Power Spectral Density Measurement16

 3.4 Conducted Band Edges and Spurious Emission Measurement17

 3.5 Radiated Band Edges and Spurious Emission Measurement18

 3.6 AC Conducted Emission Measurement.....22

 3.7 Antenna Requirements24

4 List of Measuring Equipment.....25

5 Measurement Uncertainty27

Appendix A. Conducted Test Results

Appendix B. AC Conducted Emission Test Result

Appendix C. Radiated Spurious Emission

Appendix D. Radiated Spurious Emission Plots

Appendix E. Duty Cycle Plots

Appendix F. Setup Photographs



History of this test report

Report No.	Version	Description	Issue Date
FR3N2325C	01	Initial issue of report	Apr. 18, 2024
FR3N2325C	02	1. Revise Appendix A, Appendix C and Appendix D 2. Revise Test Mode This report is an updated version, replacing the report issued on Apr. 18, 2024.	May 09, 2024
FR3N2325C	03	Revise appendix C This report is an updated version, replacing the report issued on May 09, 2024.	May 09, 2024



Summary of Test Result

Report Clause	Ref Std. Clause	Test Items	Result (PASS/FAIL)	Remark
3.1	15.247(a)(2)	6dB Bandwidth	Pass	-
3.1	2.1049	99% Occupied Bandwidth	Reporting only	-
3.2	15.247(b)	Power Output Measurement	Pass	-
3.3	15.247(e)	Power Spectral Density	Pass	-
3.4	15.247(d)	Conducted Band Edges	Pass	-
		Conducted Spurious Emission	Pass	-
3.5	15.247(d)	Radiated Band Edges and Radiated Spurious Emission	Pass	1.69 dB under the limit at 2390.00 MHz
3.6	15.207	AC Conducted Emission	Pass	17.25 dB under the limit at 0.15 MHz
3.7	15.203	Antenna Requirement	Pass	-

Conformity Assessment Condition:

1. The test results (PASS/FAIL) with all measurement uncertainty excluded are presented against the regulation limits or in accordance with the requirements stipulated by the applicant/manufacturer who shall bear all the risks of non-compliance that may potentially occur if measurement uncertainty is taken into account.
2. The measurement uncertainty please refer to each test result in the section "Measurement Uncertainty".

Disclaimer:

The product specifications of the EUT presented in the test report that may affect the test assessments are declared by the manufacturer who shall take full responsibility for the authenticity.

Reviewed by: William Chen
Report Producer: Ming Chen



1 General Description

1.1 Product Feature of Equipment Under Test

Product Feature
<p>General Specs GSM/WCDMA/LTE/5G NR, Bluetooth, BLE, BLE channel sounding, Thread, Wi-Fi 802.11be, UWB, NFC, WPT, NTN and GNSS.</p> <p>Antenna Type WLAN: <Ant.3>: IFA Antenna <Ant.4>: ILA Antenna</p>

EUT Information List	
S/N	Performed Test Item
41101FDAP0002H	RF Conducted Measurement
3B131FDAP0007E 41051FDAP00024 41051FDAP0001R	Radiated Spurious Emission
3B131FDAP0007E	Conducted Emission

Antenna information		
2400 MHz ~ 2483.5 MHz	Peak Gain (dBi)	Ant.3: -0.10 Ant.4: -0.30

Remark: The EUT's information above is declared by manufacturer. Please refer to Disclaimer in report summary.

1.1.1 Antenna Directional Gain

<For CDD Mode>

Follows FCC KDB 662911 D01 Multiple Transmitter Output v02r01 F)2)f)ii)

Directional gain = G_{ANT} + Array Gain, where Array Gain is as follows:

For power measurements on IEEE 802.11 devices,

Array Gain = 0 dB (i.e., no array gain) for $N_{ANT} \leq 4$.

G_{ANT} is set equal to the gain of the antenna having the highest gain.

For PSD measurements, the directional gain calculation.

$$DirectionalGain = 10 \cdot \log \left[\frac{\sum_{j=1}^{N_{SS}} \left\{ \sum_{k=1}^{N_{ANT}} g_{j,k} \right\}^2}{N_{ANT}} \right]$$

where

Each antenna is driven by no more than one spatial stream;

N_{SS} = the number of independent spatial streams of data;

N_{ANT} = the total number of antennas

$g_{j,k} = 10^{G_k / 20}$ if the k th antenna is being fed by spatial stream j , or zero if it is not;
 G_k is the gain in dBi of the k th antenna.

As minimum $N_{SS}=1$ is supported by EUT, the formula can be simplified as:

$$Directional\ gain = 10 \cdot \log \left[\left(10^{G_1 / 20} + 10^{G_2 / 20} + \dots + 10^{G_N / 20} \right)^2 / N_{ANT} \right] \text{ dBi}$$

Where G_1, G_2, \dots, G_N denote single antenna gain.

The directional gain "DG" is calculated as following table.

			DG	DG	Power	PSD
			for	for	Limit	Limit
	Ant 3	Ant 4	Power	PSD	Reduction	Reduction
	(dBi)	(dBi)	(dBi)	(dBi)	(dB)	(dB)
2.4GHz	-0.10	-0.30	-0.10	2.81	0.00	0.00

Calculation example:

If a device has two antenna, $G_{ANT3} = -0.10\text{dBi}$; $G_{ANT4} = -0.30\text{dBi}$

Directional gain of power measurement = $\max(-0.10, -0.30) + 0 = -0.10 \text{ dBi}$

Directional gain of PSD derived from formula which is

$$10 \times \log \left\{ \left[10^{(-0.10 \text{ dBi} / 20)} + 10^{(-0.30 \text{ dBi} / 20)} \right]^2 / 2 \right\}$$

=2.81 dBi

Power and PSD limit reduction = Composite gain – 6dBi, (min = 0)



1.2 Modification of EUT

No modifications made to the EUT during the testing.

1.3 Testing Location

Test Site	Sporton International Inc. Wensan Laboratory
Test Site Location	No.58, Aly. 75, Ln. 564, Wenhua 3rd, Rd., Guishan Dist., Taoyuan City 333010, Taiwan (R.O.C.) TEL: +886-3-327-0868 FAX: +886-3-327-0855
Test Site No.	Sporton Site No. TH05-HY, CO07-HY, 03CH15-HY

Note: The test site complies with ANSI C63.4 2014 requirement.

FCC designation No.: TW3786

1.4 Applicable Standards

According to the specifications declared by the manufacturer, the EUT must comply with the requirements of the following standards:

- ♦ FCC Part 15 Subpart C §15.247
- ♦ FCC KDB Publication No. 558074 D01 15.247 Meas Guidance v05r02
- ♦ FCC KDB 414788 D01 Radiated Test Site v01r01.
- ♦ FCC KDB 662911 D01 Multiple Transmitter Output v02r01.
- ♦ ANSI C63.10-2013

Remark:

1. All the test items were validated and recorded in accordance with the standards without any modification during the testing.
2. The TAF code is not including all the FCC KDB listed without accreditation.



2 Test Configuration of Equipment Under Test

a. The EUT has been associated with peripherals and configuration operated in a manner tended to maximize its emission characteristics in a typical application. Frequency range investigated: conduction emission (150 kHz to 30 MHz), radiation emission (9 kHz to the 10th harmonic of the highest fundamental frequency or to 40 GHz, whichever is lower). For radiated measurement, the measured emission level of the EUT was maximized by rotating the EUT on a turntable, adjusting the orientation of the EUT and EUT antenna in three orthogonal axis (X: flat, Y: portrait, Z: landscape) and accessory (Adapter or Earphone), and adjusting the measurement antenna orientation, following C63.10 exploratory test procedures and find Z plane as worst plane.

b. AC power line Conducted Emission was tested under maximum output power.

2.1 Carrier Frequency and Channel

Frequency Band	Channel	Freq. (MHz)	Channel	Freq. (MHz)
2400-2483.5 MHz	1	2412	8	2447
	2	2417	9	2452
	3	2422	10	2457
	4	2427	11	2462
	5	2432	12	2467
	6	2437	13	2472
	7	2442		



2.2 Test Mode

This device supports WiFi 802.11be 20MHz bandwidth for 2.4GHz.

This device supports 26/52/106/242 single tone RU modes for 802.11ax/be modes and the 242-tone RU modes are covered by 20MHz channels.

The PSD of partial RU modes are reduced to be smaller than full RU according to TCB workshop interim guidance Oct. 2022.

The 802.11ax/be modes are investigated among full RU and single RU modes for emission spot check and the 11ax modes are covered by 11be modes.

The PSD and power of partial RU are less than full RU configurations so the full RU is chosen as main test configuration.

The power of 802.11n, 802.11ac and 802.11ax modes are less than 802.11be mode, so all conducted and radiated tests are covered by 802.11be mode.

The final test modes include the worst data rates for each modulation shown in the table below.

Single Antenna

Modulation	Data Rate
802.11b	1 Mbps

MIMO Antenna

Modulation	Data Rate
802.11g	6 Mbps
802.11n HT20 (Covered by EHT20)	MCS0
802.11ac VHT20 (Covered by EHT20)	MCS0
802.11ax HE20 (Covered by EHT20)	MCS0
802.11be EHT20	MCS0

Index of MRU mapping

Small MRU

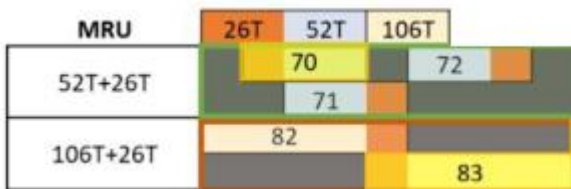



Test Cases	
AC Conducted Emission	Mode 1 :WLAN (2.4GHz) Link + USB cable 2 (Charging from Adapter 1)
Remark:	
<ol style="list-style-type: none"> For Radiated Test Cases, the tests were performed with Adapter 1 and USB Cable 2. During the preliminary test, both charging modes (Adapter mode and WPT Charging mode) were verified. It is determined that the adaptor mode is the worst case for official test. 	

<Ant. 3>

Ch. #	2400-2483.5 MHz
	802.11b
Low	01
Middle	06
High	11
	12
	13

<Ant. 4>

Ch. #	2400-2483.5 MHz
	802.11b
Low	01
Middle	06
High	11
	12
	13

MIMO <Ant. 3+4>

Ch. #	2400-2483.5 MHz	
	802.11g	802.11be EHT20
Low	01	01
	02	02
Middle	06	06
High	10	10
	11	11
	12	12
	13	13

Remark: For radiation spurious emission, the modulation and the data rate picked for testing are determined by the Max. RF conducted power.

2.3 Connection Diagram of Test System

<AC Conducted Emission Mode>

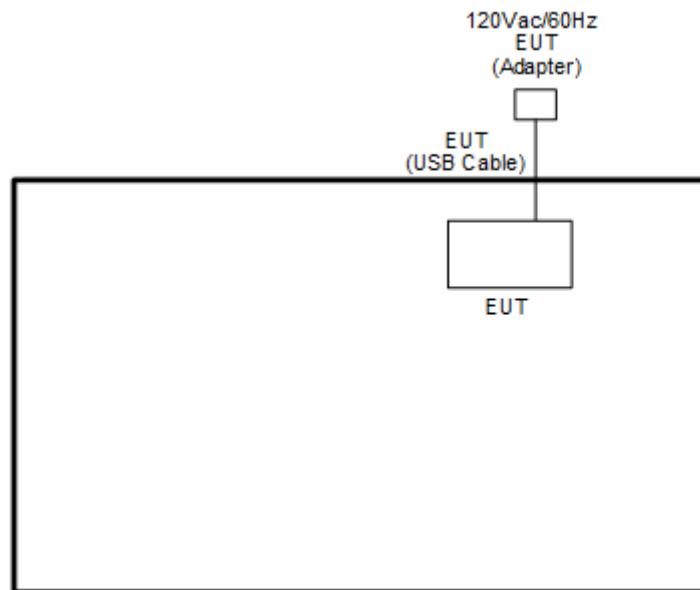

<WLAN Tx Mode>

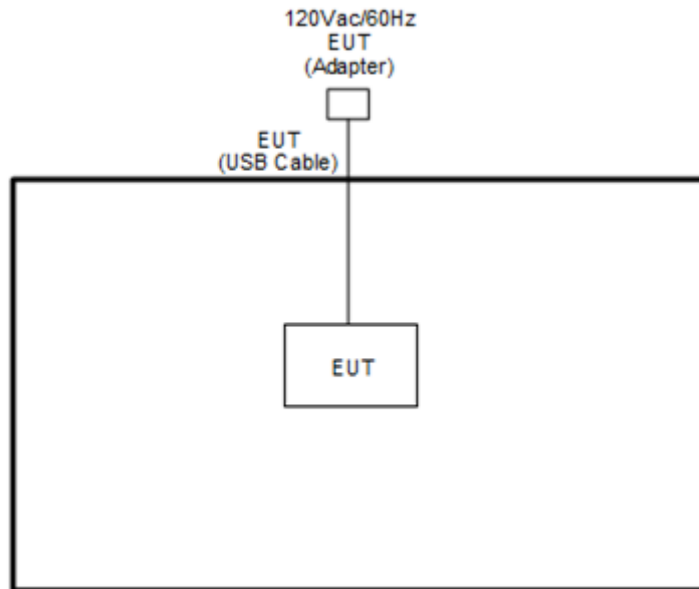

2.4 Support Unit used in test configuration and system

Item	Equipment	Brand Name	Model Name	FCC ID	Data Cable	Power Cord
1.	Notebook	DELL	Latitude 3400	FCC DoC	N/A	AC I/P: Unshielded, 1.2 m DC O/P: Shielded, 1.8 m

2.5 EUT Operation Test Setup

The RF test items, utility "WLAN_DUT_Control_GUI_11-29-23" was installed in Notebook which was programmed in order to make the EUT get into the engineering modes to provide channel selection, power level, data rate and the application type and for continuous transmitting signals.



2.6 Measurement Results Explanation Example

For all conducted test items:

The offset level is set in the spectrum analyzer to compensate the RF cable loss and attenuator factor between EUT conducted output port and spectrum analyzer. With the offset compensation, the spectrum analyzer reading level is exactly the EUT RF output level.

Example:

The spectrum analyzer offset is derived from RF cable loss and attenuator factor.

Offset = RF cable loss + attenuator factor.

Following shows an offset computation example with cable loss 4.2 dB and 10 dB attenuator.

Offset(dB) = RF cable loss(dB) + attenuator factor(dB).

= 4.2 + 10 = 14.2 (dB)

3 Test Result

3.1 6dB and 99% Bandwidth Measurement

3.1.1 Limit of 6dB and 99% Bandwidth

The minimum 6 dB bandwidth shall be at least 500 kHz.

3.1.2 Measuring Instruments

Please refer to the measuring equipment list in this test report.

3.1.3 Test Procedures

1. The testing follows the ANSI C63.10 Section 6.9.3 (OBW) and 11.8.1 (6dB BW).
2. The RF output of EUT is connected to the spectrum analyzer by RF cable and attenuator. The path loss is compensated to the results for each measurement.
3. Set the maximum power setting and enable the EUT to transmit continuously.
4. Make the measurement with the spectrum analyzer's resolution bandwidth (RBW) = 100 kHz. Set the Video bandwidth (VBW) = 300 kHz. In order to make an accurate measurement. The 6 dB bandwidth must be greater than 500 kHz.
5. For 99% Bandwidth Measurement, the spectrum analyzer's resolution bandwidth (RBW) is set 1-5% of the emission bandwidth and set the Video bandwidth (VBW) $\geq 3 * RBW$.
6. Measure and record the results in the test report.

3.1.4 Test Setup



3.1.5 Test Result of 6dB and 99% Occupied Bandwidth

Please refer to Appendix A.

3.2 Output Power Measurement

3.2.1 Limit of Output Power

For systems using digital modulation in the 2400-2483.5 MHz, the limit for output power is 30 dBm. If transmitting antenna with directional gain greater than 6 dBi is used, the peak output power from the intentional radiator shall be reduced below the above stated value by the amount in dB that the directional gain of the antenna exceeds 6 dBi. In case of point-to-point operation, the limit has to be reduced by 1 dB for every 3 dB that the directional gain of the antenna exceeds 6 dBi.

3.2.2 Measuring Instruments

Please refer to the measuring equipment list in this test report.

3.2.3 Test Procedures

1. For Average Power, the testing follows ANSI C63.10 Section 11.9.2.3.2 Method AVGPM-G
2. The RF output of EUT is connected to the power meter by RF cable and attenuator. The path loss is compensated to the results for each measurement.
3. Set the maximum power setting and enable the EUT to transmit continuously.
4. Measure the conducted output power and record the results in the test report.
5. For MIMO mode, calculation method follows FCC KDB 662911 D01 Multiple Transmitter Output v02r01.

3.2.4 Test Setup

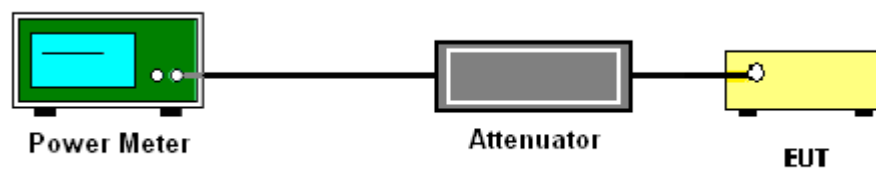

3.2.5 Test Result of Average Output Power

Please refer to Appendix A.

3.3 Power Spectral Density Measurement

3.3.1 Limit of Power Spectral Density

The peak power spectral density shall not be greater than 8 dBm in any 3 kHz band at any time interval of continuous transmission.

3.3.2 Measuring Instruments

Please refer to the measuring equipment list in this test report.

3.3.3 Test Procedures

1. The testing follows the ANSI C63.10 Section 11.10.2 Method PKPSD.
2. The RF output of EUT is connected to the spectrum analyzer by RF cable and attenuator. The path loss is compensated to the results for each measurement.
3. Set the maximum power setting and enable the EUT to transmit continuously.
4. Make the measurement with the spectrum analyzer's resolution bandwidth (RBW) = 3 kHz. Video bandwidth VBW = 10 kHz In order to make an accurate measurement, set the span to 1.5 times DTS Channel Bandwidth. (6dB BW)
5. Detector = peak, Sweep time = auto couple, Trace mode = max hold, Allow trace to fully stabilize. Use the peak marker function to determine the maximum power level.
6. Measure and record the results in the test report.
7. For MIMO mode, calculation method follows FCC KDB 662911 D01 Multiple Transmitter Output v02r01.

Method (c): Measure and add $10 \log(N_{ANT})$ dB.

With this technique, spectrum measurements are performed at each output of the device, but rather than summing the spectra or the spectral peaks across the outputs, the quantity $10 \log(N_{ANT})$ dB is added to each spectrum value before comparing to the emission limit. The addition of $10 \log(N_{ANT})$ dB serves to apportion the emission limit among the N_{ANT} outputs so that each output is permitted to contribute no more than $1/N_{ANT}^{th}$ of the PSD limit .

3.3.4 Test Setup

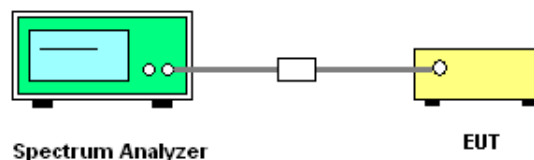

3.3.5 Test Result of Power Spectral Density

Please refer to Appendix A.

3.4 Conducted Band Edges and Spurious Emission Measurement

3.4.1 Limit of Conducted Band Edges and Spurious Emission Measurement

In any 100 kHz bandwidth outside of the authorized frequency band, the emissions which fall in the non-restricted bands shall be attenuated at least 20 dB / 30dB relative to the maximum PSD level in 100 kHz by RF conducted measurement.

3.4.2 Measuring Instruments

Please refer to the measuring equipment list in this test report.

3.4.3 Test Procedures

1. The testing follows the ANSI C63.10 Section 11.11.3 Emission level measurement.
2. The RF output of EUT is connected to the spectrum analyzer by RF cable and attenuator. The path loss is compensated to the results for each measurement.
3. Set the maximum power setting and enable the EUT to transmit continuously.
4. Set RBW = 100 kHz, VBW=300 kHz, Peak Detector. Unwanted Emissions measured in any 100 kHz bandwidth outside of the authorized frequency band shall be attenuated by at least 20 dB relative to the maximum in-band peak PSD level in 100 kHz when maximum peak conducted output power procedure is used. If the transmitter complies with the conducted power limits based on the use of RMS averaging over a time interval, the attenuation required under this paragraph shall be 30 dB instead of 20 dB per 15.247(d).
5. Measure and record the results in the test report.
6. The RF fundamental frequency should be excluded against the limit line in the operating frequency band.

3.4.4 Test Setup

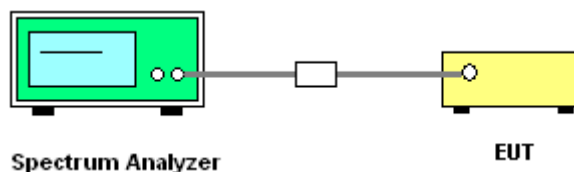

3.4.5 Test Result of Conducted Band Edges and Spurious Emission

Please refer to Appendix A.



3.5 Radiated Band Edges and Spurious Emission Measurement

3.5.1 Limit of Radiated band edge and Spurious Emission Measurement

In any 100 kHz bandwidth outside the intentional radiator frequency band, all harmonics/spurious must be at least 20 dB below the highest emission level within the authorized band. If the output power of this device is measured by spectrum analyzer, the attenuation under this paragraph shall be 30 dB instead of 20 dB. In addition, radiated emissions which fall in the restricted bands must also comply with the limits as below.

Frequency (MHz)	Field Strength (microvolts/meter)	Measurement Distance (meters)
0.009 – 0.490	2400/F(kHz)	300
0.490 – 1.705	24000/F(kHz)	30
1.705 – 30.0	30	30
30 – 88	100	3
88 – 216	150	3
216 - 960	200	3
Above 960	500	3

3.5.2 Measuring Instruments

Please refer to the measuring equipment list in this test report.

3.5.3 Test Procedures

1. The testing follows the ANSI C63.10 Section 11.12.1 Radiated emission measurements.
2. The EUT is arranged to its worst case and then tune the antenna tower (from 1 m to 4 m) and turntable (from 0 degree to 360 degrees) to find the maximum reading. A pre-amp and a high pass filter are used for the test in order to get better signal level.
3. The EUT is placed on a turntable with 0.8 meter for frequency below 1 GHz and 1.5 meter for frequency above 1 GHz respectively above ground.
4. The EUT is set 3 meters away from the receiving antenna, which is mounted on the top of a variable height antenna tower.
5. Corrected Reading: Antenna Factor + Cable Loss + Read Level - Preamp Factor = Level
6. Radiated testing below 1 GHz is performed by adjusting the antenna tower from 1 m to 4 m and by rotating the turn table from 0 degree to 360 degrees to find the peak maximum hold reading. When there is no suspected emission found and the emission level is with at least 6 dB margin against QP limit line, the position is marked as “-“.

7. Radiated testing above 1 GHz is performed by adjusting the antenna tower from 1 m to 4 m and by rotating the turn table from 0 degree to 360 degrees to find the peak maximum hold reading for scanning all frequencies. When there is no suspected emission found and the harmonic emission level is with at least 6 dB margin against average limit line, the position is marked as “-“.
8. Use the following spectrum analyzer settings:
 - (1) Span shall wide enough to fully capture the emission being measured;
 - (2) Set RBW = 100 kHz for $f < 1$ GHz; VBW \geq RBW; Sweep = auto; Detector function = peak; Trace = max hold;
 - (3) Set RBW = 1 MHz, VBW = 3 MHz for $f \geq 1$ GHz for peak measurement.For average measurement:
 - VBW = 10 Hz, when duty cycle is no less than 98 percent.
 - VBW $\geq 1/T$, when duty cycle is less than 98 percent where T is the minimum transmission duration over which the transmitter is on and is transmitting at its maximum power control level for the tested mode of operation.

3.5.4 Test Setup

For radiated emissions below 30MHz

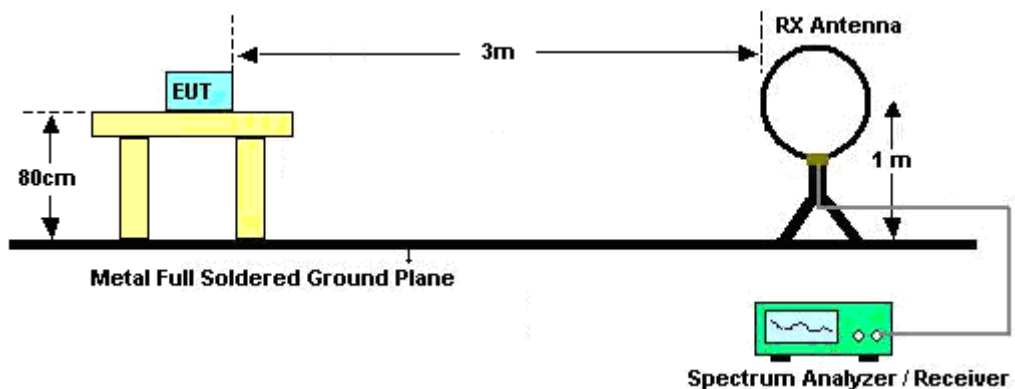

For radiated emissions from 30MHz to 1GHz

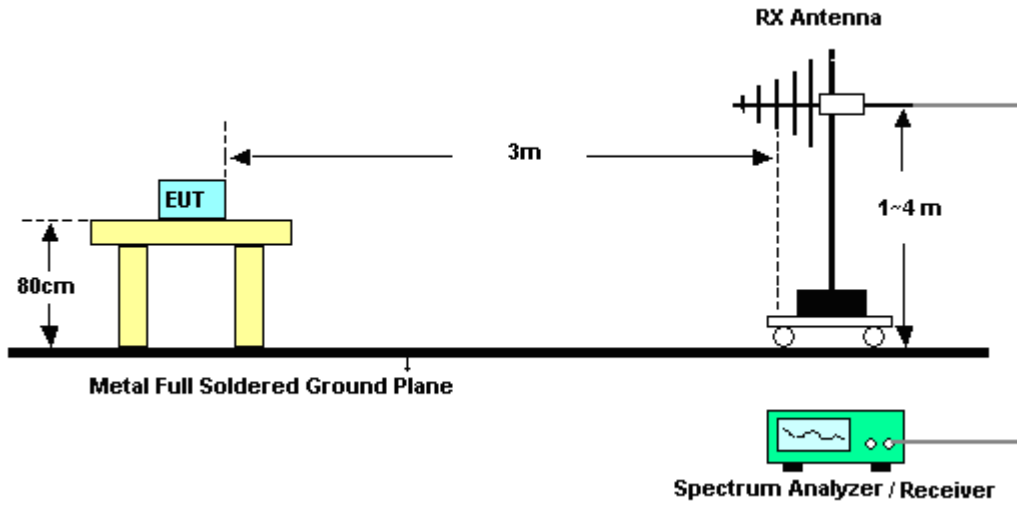

For radiated test from 1GHz to 18GHz

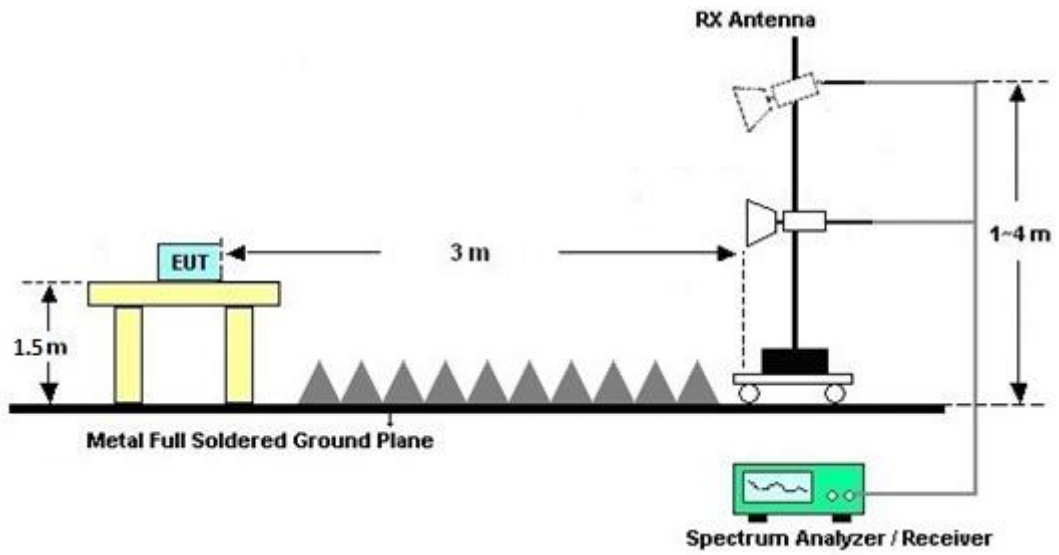

For radiated test above 18GHz

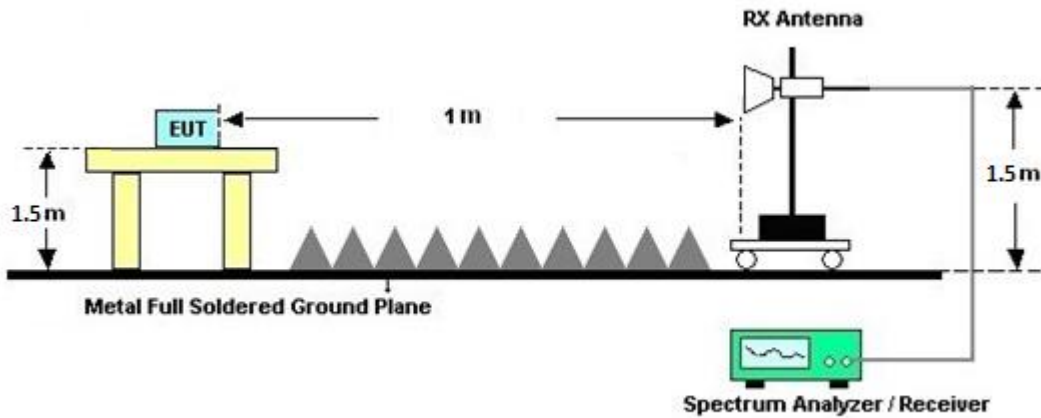

3.5.5 Test Results of Radiated Spurious Emissions (9kHz ~ 30MHz)

The low frequency, which starts from 9 kHz to 30 MHz, is pre-scanned and the result which is 20 dB lower than the limit line is not reported.

There is adequate comparison measurement of both open-field test site and alternative test site - semi-Anechoic chamber according to 414788 D01 Radiated Test Site v01r01, and the result comes out very similar.

3.5.6 Test Result of Radiated Spurious at Band Edges

Please refer to Appendix C and D.

3.5.7 Duty Cycle

Please refer to Appendix E.

3.5.8 Test Result of Radiated Spurious Emission (30MHz ~ 10th Harmonic)

Please refer to Appendix C and D.



3.6 AC Conducted Emission Measurement

3.6.1 Limit of AC Conducted Emission

For equipment that is designed to be connected to the public utility (AC) power line, the radio frequency voltage that is conducted back onto the AC power line on any frequency or frequencies within the band 150 kHz to 30 MHz shall not exceed the limits in the following table.

Frequency of Emission (MHz)	Conducted Limit (dBµV)	
	Quasi-Peak	Average
0.15-0.5	66 to 56*	56 to 46*
0.5-5	56	46
5-30	60	50

*Decreases with the logarithm of the frequency.

3.6.2 Measuring Instruments

Please refer to the measuring equipment list in this test report.

3.6.3 Test Procedures

1. The EUT is placed 0.4 meter away from the conducting wall of the shielding room, and is kept at least 80 centimeters from any other grounded conducting surface.
2. Connect EUT to the power mains through a line impedance stabilization network (LISN).
3. All the support units are connecting to the other LISN.
4. The LISN provides 50 ohm coupling impedance for the measuring instrument.
5. The FCC states that a 50 ohm, 50 microhenry LISN shall be used.
6. Both Line and Neutral shall be tested in order to find out the maximum conducted emission.
7. The frequency range from 150 kHz to 30 MHz is scanned.
8. Set the test-receiver system to Peak Detect Function and specified bandwidth (IF bandwidth = 9kHz) with Maximum Hold Mode.

3.6.4 Test Setup

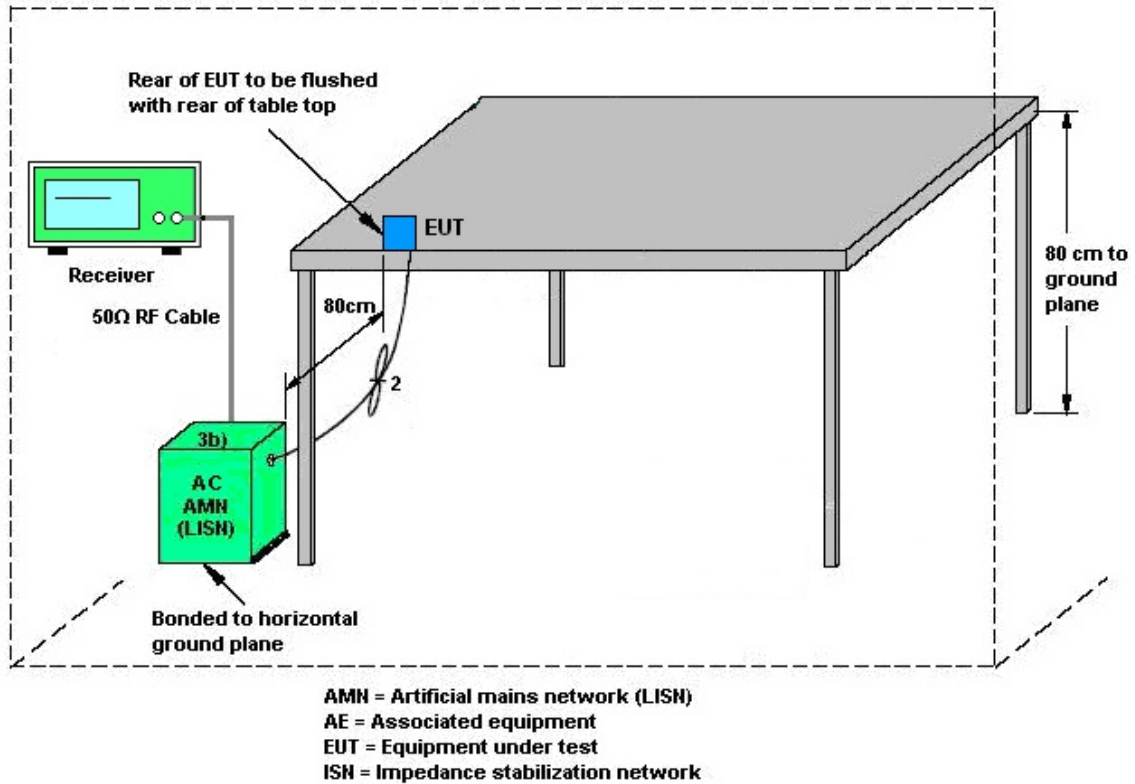

3.6.5 Test Result of AC Conducted Emission

Please refer to Appendix B.



3.7 Antenna Requirements

3.7.1 Standard Applicable

The use of a permanently attached antenna or of an antenna that uses a unique coupling to the intentional radiator shall be considered sufficient to comply with the rule.

3.7.2 Antenna Anti-Replacement Construction

An embedded-in antenna design is used.



4 List of Measuring Equipment

Instrument	Brand Name	Model No.	Serial No.	Characteristics	Calibration Date	Test Date	Due Date	Remark
Hygrometer	TECEPEL	DTM-303A	TP201996	N/A	Nov. 07, 2023	Jan. 05, 2024~ May 03, 2024	Nov. 06, 2024	Conducted (TH05-HY)
Power Sensor	DARE	RPR3006W	15I00041SNO 10 (NO:248)	10MHz~6GHz	Jun. 05, 2023	Jan. 05, 2024~ May 03, 2024	Jun. 04, 2024	Conducted (TH05-HY)
Signal Analyzer	Rohde & Schwarz	FSV3044	101468	10HZ~44GHZ	Mar. 13, 2023	Jan. 05, 2024~ May 03, 2024	Mar. 12, 2024	Conducted (TH05-HY)
AC Power Source	ACPOWER	AFC-11003G	F317040033	N/A	N/A	Mar. 23, 2024	N/A	Conduction (CO07-HY)
Software	Rohde & Schwarz	EMC32 V10.30	N/A	N/A	N/A	Mar. 23, 2024	N/A	Conduction (CO07-HY)
Pulse Limiter	SCHWARZBECK	VTSD 9561-F N	9561-F N00373	9kHz~200MHz	Oct. 20, 2023	Mar. 23, 2024	Oct. 19, 2024	Conduction (CO07-HY)
RF Cable	HUBER + SUHNER	RG 214/U	1358175	9kHz~30MHz	Mar. 14, 2024	Mar. 23, 2024	Mar. 13, 2025	Conduction (CO07-HY)
Two-Line V-Network	TESEQ	NNB 51	45051	N/A	Mar. 10, 2024	Mar. 23, 2024	Mar. 09, 2025	Conduction (CO07-HY)
Four-Line V-Network	TESEQ	NNB 52	36122	N/A	Mar. 07, 2024	Mar. 23, 2024	Mar. 06, 2025	Conduction (CO07-HY)
EMI Test Receiver	Rohde & Schwarz	ESR3	102317	9kHz~3.6GHz	Sep. 20, 2023	Mar. 23, 2024	Sep. 19, 2024	Conduction (CO07-HY)
Loop Antenna	Rohde & Schwarz	HFH2-Z2	100488	9kHz~30MHz	Sep. 12, 2023	Jan. 11, 2024~ May 04, 2024	Sep. 11, 2024	Radiation (03CH15-HY)
Bilog Antenna	TESEQ	CBL 6111D & 00800N1D01N -06	47020 & 06	30MHz~1GHz	Oct. 07, 2023	Jan. 11, 2024~ Feb. 03, 2024	Oct. 06, 2024	Radiation (03CH15-HY)
Bilog Antenna	TESEQ	CBL 6111D & 00800N1D01N -06	41912 & 05	30MHz~1GHz	Feb. 04, 2024	Feb. 04, 2024~ May 04, 2024	Feb. 03, 2025	Radiation (03CH15-HY)
Horn Antenna	SCHWARZBECK	BBHA 9120 D	9120D-02294	1GHz~18GHz	Jun. 30, 2023	Jan. 11, 2024~ May 04, 2024	Jun. 29, 2024	Radiation (03CH15-HY)
SHF-EHF Horn Antenna	SCHWARZBECK	BBHA 9170	1225	18GHz~40GHz	Jul. 10, 2023	Jan. 11, 2024~ May 04, 2024	Jul. 09, 2024	Radiation (03CH15-HY)
Amplifier	SONOMA	310N	363440	9kHz~1GHz	Dec. 26, 2023	Jan. 11, 2024~ May 04, 2024	Dec. 25, 2024	Radiation (03CH15-HY)
Preamplifier	EMEC	EM01G18G	060812	1GHz~18GHz	Dec. 25, 2023	Jan. 11, 2024~ Feb. 14, 2024	Dec. 24, 2024	Radiation (03CH15-HY)
Preamplifier	EMEC	EM01G18G	060837	1GHz~18GHz	Feb. 15, 2024	Feb. 15, 2024~ May 04, 2024	Feb. 14, 2025	Radiation (03CH15-HY)
Preamplifier	Keysight	83017A	MY53270264	1GHz~26.5GHz	Dec. 07, 2023	Jan. 11, 2024~ May 04, 2024	Dec. 06, 2024	Radiation (03CH15-HY)
Preamplifier	EM Electronics	EM01G18G	060802	1GHz~18GHz	Mar. 03, 2023	Jan. 11, 2024~ Feb. 28, 2024	Mar. 02, 2024	Radiation (03CH15-HY)
Preamplifier	EM Electronics	EM01G18G	060802	1GHz~18GHz	Feb. 29, 2024	Feb. 29, 2024~ May 04, 2024	Feb. 28, 2025	Radiation (03CH15-HY)
Preamplifier	EMEC	EM18G40G	060801	18GHz~40GHz	Jun. 27, 2023	Jan. 11, 2024~ May 04, 2024	Jun. 26, 2024	Radiation (03CH15-HY)
EMI Test Receiver	Keysight	N9038A(MXE)	MY53290045	20MHz~8.4GHz	Oct. 06, 2023	Jan. 11, 2024~ May 04, 2024	Oct. 05, 2024	Radiation (03CH15-HY)
Spectrum Analyzer	Keysight	N9010B	MY60241058	10Hz~44GHz	Jul. 06, 2023	Jan. 11, 2024~ May 04, 2024	Jul. 05, 2024	Radiation (03CH15-HY)
Antenna Mast	ChainTek	MBS-520-1	N/A	1m~4m	N/A	Jan. 11, 2024~ May 04, 2024	N/A	Radiation (03CH15-HY)
Turn Table	ChainTek	T-200-S-1	N/A	0~360 Degree	N/A	Jan. 11, 2024~ May 04, 2024	N/A	Radiation (03CH15-HY)
Software	Audix	E3 6.2009-8-24(k5)	RK-000451	N/A	N/A	Jan. 11, 2024~ May 04, 2024	N/A	Radiation (03CH15-HY)



Instrument	Brand Name	Model No.	Serial No.	Characteristics	Calibration Date	Test Date	Due Date	Remark
RF Cable	HUBER + SUHNER	SUCOFLEX 104, 102E	MY582185/4, 519228/2,803 950/2	N/A	Jun. 13, 2023	Jan. 11, 2024~ May 04, 2024	Jun. 12, 2024	Radiation (03CH15-HY)
RF Cable	HUBER + SUHNER	SUCOFLEX 102	804011/2,804 012/2	18-40G	Jan. 02, 2024	Jan. 11, 2024~ May 04, 2024	Jan. 01, 2025	Radiation (03CH15-HY)
Filter	Wainwright	WLJ4-1000-15 30-6000-40ST	SN4	1.53GHz Low Pass Filter	Jun. 14, 2023	Jan. 11, 2024~ May 04, 2024	Jun. 13, 2024	Radiation (03CH15-HY)
Filter	Wainwright	WHKX12-2700 -3000-18000-6 0ST	SN4	3GHz High Pass Filter	Jun. 14, 2023	Jan. 11, 2024~ May 04, 2024	Jun. 13, 2024	Radiation (03CH15-HY)
Hygrometer	TECPEL	DTM-302	SN4	N/A	Jul. 26, 2023	Jan. 11, 2024~ May 04, 2024	Jul. 25, 2024	Radiation (03CH15-HY)



5 Measurement Uncertainty

Uncertainty of Conducted Emission Measurement (150 kHz ~ 30 MHz)

Measuring Uncertainty for a Level of Confidence of 95% ($U = 2Uc(y)$)	3.44 dB
-------------------------------------------------------------------------	---------

Uncertainty of Radiated Emission Measurement (30 MHz ~ 1000 MHz)

Measuring Uncertainty for a Level of Confidence of 95% ($U = 2Uc(y)$)	6.30 dB
-------------------------------------------------------------------------	---------

Uncertainty of Radiated Emission Measurement (1000 MHz ~ 6000 MHz)

Measuring Uncertainty for a Level of Confidence of 95% ($U = 2Uc(y)$)	4.50 dB
-------------------------------------------------------------------------	---------

Uncertainty of Radiated Emission Measurement (6000 MHz ~ 18000 MHz)

Measuring Uncertainty for a Level of Confidence of 95% ($U = 2Uc(y)$)	5.50 dB
-------------------------------------------------------------------------	---------

Uncertainty of Radiated Emission Measurement (18000 MHz ~ 40000 MHz)

Measuring Uncertainty for a Level of Confidence of 95% ($U = 2Uc(y)$)	5.40 dB
-------------------------------------------------------------------------	---------

Appendix A. Test Result of Conducted Test Items

Test Engineer:	Willy Chang, Ju Chang and Henry Ke	Temperature:	21~25	°C
Test Date:	2024/01/05-2024/05/03	Relative Humidity:	51~54	%

TEST RESULTS DATA
6dB and 99% Occupied Bandwidth

2.4GHz Band Single Antenna										
Mod.	Data Rate	NTX	CH.	Freq. (MHz)	99% Occupied BW (MHz)		6dB BW (MHz)		6dB BW Limit (MHz)	Pass/Fail
					Ant3	Ant4	Ant3	Ant4		
11b	1Mbps	1	1	2412	13.09	12.99	9.06	8.60	0.50	Pass
11b	1Mbps	1	6	2437	13.11	12.99	9.08	9.08	0.50	Pass
11b	1Mbps	1	11	2462	13.48	12.98	9.10	8.62	0.50	Pass
11b	1Mbps	1	12	2467	13.17	12.91	9.06	8.60	0.50	Pass
11b	1Mbps	1	13	2472	12.80	12.91	8.55	8.54	0.50	Pass

2.4GHz Band MIMO										
Mod.	Data Rate	NTX	CH.	Freq. (MHz)	99% Occupied BW (MHz)		6dB BW (MHz)		6dB BW Limit (MHz)	Pass/Fail
					Ant3	Ant4	Ant3	Ant4		
11g	6Mbps	2	1	2412	16.70	16.55	15.22	15.22	0.50	Pass
11g	6Mbps	2	6	2437	17.16	17.30	15.22	15.22	0.50	Pass
11g	6Mbps	2	11	2462	16.82	16.53	15.43	15.14	0.50	Pass
11g	6Mbps	2	12	2467	16.65	16.41	15.36	15.14	0.50	Pass
11g	6Mbps	2	13	2472	16.55	16.50	15.13	15.66	0.50	Pass

TEST RESULTS DATA
Average Output Power

2.4GHz Band Single Antenna																
Mod.	Data Rate	NTX	CH.	Freq. (MHz)	Average Conducted Power (dBm)			Conducted Power Limit (dBm)		DG (dBi)		EIRP Power (dBm)		EIRP Power Limit (dBm)		Pass /Fail
					Ant3	Ant4	SUM	Ant3	Ant4	Ant3	Ant4	Ant3	Ant4	Ant3	Ant4	
11b	1Mbps	1	1	2412	22.45	22.48		30.00	30.00	-0.10	-0.30	22.35	22.18	36.00	36.00	Pass
11b	1Mbps	1	6	2437	22.25	22.48		30.00	30.00	-0.10	-0.30	22.15	22.18	36.00	36.00	Pass
11b	1Mbps	1	11	2462	22.45	22.38		30.00	30.00	-0.10	-0.30	22.35	22.08	36.00	36.00	Pass
11b	1Mbps	1	12	2467	22.45	22.48		30.00	30.00	-0.10	-0.30	22.35	22.18	36.00	36.00	Pass
11b	1Mbps	1	13	2472	19.25	19.98		30.00	30.00	-0.10	-0.30	19.15	19.68	36.00	36.00	Pass

2.4GHz Band MIMO																
Mod.	Data Rate	NTX	CH.	Freq. (MHz)	Average Conducted Power (dBm)			Conducted Power Limit (dBm)		DG (dBi)		EIRP Power (dBm)		EIRP Power Limit (dBm)		Pass /Fail
					Ant3	Ant4	SUM	Ant3	Ant4	Ant3	Ant4	Ant3	Ant4	Ant3	Ant4	
11g	6Mbps	2	1	2412	18.45	19.18	21.84	30.00		-0.10		21.74		36.00		Pass
11g	6Mbps	2	2	2417	20.75	20.88	23.83	30.00		-0.10		23.73		36.00		Pass
11g	6Mbps	2	6	2437	20.95	21.98	24.51	30.00		-0.10		24.41		36.00		Pass
11g	6Mbps	2	10	2457	19.95	19.98	22.98	30.00		-0.10		22.88		36.00		Pass
11g	6Mbps	2	11	2462	17.35	17.28	20.33	30.00		-0.10		20.23		36.00		Pass
11g	6Mbps	2	12	2467	14.85	15.28	18.08	30.00		-0.10		17.98		36.00		Pass
11g	6Mbps	2	13	2472	8.85	8.98	11.93	30.00		-0.10		11.83		36.00		Pass
HT20	MCS0	2	1	2412	15.75	16.88	19.36	30.00		-0.10		19.26		36.00		Pass
HT20	MCS0	2	2	2417	20.25	20.58	23.43	30.00		-0.10		23.33		36.00		Pass
HT20	MCS0	2	6	2437	19.65	20.78	23.26	30.00		-0.10		23.16		36.00		Pass
HT20	MCS0	2	10	2457	19.55	19.68	22.63	30.00		-0.10		22.53		36.00		Pass
HT20	MCS0	2	11	2462	15.45	15.78	18.63	30.00		-0.10		18.53		36.00		Pass
HT20	MCS0	2	12	2467	13.65	13.98	16.83	30.00		-0.10		16.73		36.00		Pass
HT20	MCS0	2	13	2472	8.95	9.08	12.03	30.00		-0.10		11.93		36.00		Pass
VHT20	MCS0	2	1	2412	15.75	16.88	19.36	30.00		-0.10		19.26		36.00		Pass
VHT20	MCS0	2	2	2417	20.25	20.58	23.43	30.00		-0.10		23.33		36.00		Pass
VHT20	MCS0	2	6	2437	19.65	20.78	23.26	30.00		-0.10		23.16		36.00		Pass
VHT20	MCS0	2	10	2457	19.55	19.68	22.63	30.00		-0.10		22.53		36.00		Pass
VHT20	MCS0	2	11	2462	15.45	15.78	18.63	30.00		-0.10		18.53		36.00		Pass
VHT20	MCS0	2	12	2467	13.65	13.98	16.83	30.00		-0.10		16.73		36.00		Pass
VHT20	MCS0	2	13	2472	8.95	9.08	12.03	30.00		-0.10		11.93		36.00		Pass

Note: Measured power (dBm) has offset with cable loss.

TEST RESULTS DATA
Peak Power Spectral Density

2.4GHz Band Single Antenna												
Mod.	Data Rate	NTX	CH.	Freq. (MHz)	Peak PSD (dBm/3kHz)			DG (dBi)		Peak PSD Limit (dBm/3kHz)		Pass/Fail
					Ant3	Ant4	Worse + 3.01	Ant3	Ant4	Ant3	Ant4	
11b	1Mbps	1	1	2412	1.20	1.26		-0.10	-0.30	8.00	8.00	Pass
11b	1Mbps	1	6	2437	0.34	1.21		-0.10	-0.30	8.00	8.00	Pass
11b	1Mbps	1	11	2462	0.89	1.04		-0.10	-0.30	8.00	8.00	Pass
11b	1Mbps	1	12	2467	0.26	1.06		-0.10	-0.30	8.00	8.00	Pass
11b	1Mbps	1	13	2472	-1.64	-2.23		-0.10	-0.30	8.00	8.00	Pass

2.4GHz Band MIMO												
Mod.	Data Rate	NTX	CH.	Freq. (MHz)	Peak PSD (dBm/3kHz)			DG (dBi)		Peak PSD Limit (dBm/3kHz)		Pass/Fail
					Ant3	Ant4	Worse + 3.01	Ant3	Ant4	Ant3	Ant4	
11g	6Mbps	2	1	2412	-5.74	-3.91	-0.90	2.81		8.00		Pass
11g	6Mbps	2	6	2437	-3.27	-1.22	1.79	2.81		8.00		Pass
11g	6Mbps	2	11	2462	-6.99	-6.92	-3.91	2.81		8.00		Pass
11g	6Mbps	2	12	2467	-8.13	-8.82	-5.12	2.81		8.00		Pass
11g	6Mbps	2	13	2472	-14.19	-14.99	-11.18	2.81		8.00		Pass

Measured power density (dBm) has offset with cable loss.

TEST RESULTS DATA
Average Output Power

2.4GHz Band MIMO																	
Mod.	Data Rate	NTX	CH.	Freq. (MHz)	RU Config	Average Conducted Power (dBm)			Conducted Power Limit (dBm)		DG (dBi)		EIRP Power (dBm)		EIRP Power Limit (dBm)		Pass /Fail
						Ant3	Ant4	SUM	Ant3	Ant4	Ant3	Ant4	Ant3	Ant4	Ant3	Ant4	
HE20	MCS0	2	1	2412	Full	15.85	16.98	19.46	30.00		-0.10	19.36		36.00		Pass	
HE20	MCS0	2	1	2412	26/0	9.15	9.18	12.18	30.00		-0.10	12.08		36.00		Pass	
HE20	MCS0	2	1	2412	52/37	11.55	11.98	14.78	30.00		-0.10	14.68		36.00		Pass	
HE20	MCS0	2	1	2412	106/53	13.15	13.48	16.33	30.00		-0.10	16.23		36.00		Pass	
HE20	MCS0	2	2	2417	Full	20.35	20.68	23.53	30.00		-0.10	23.43		36.00		Pass	
HE20	MCS0	2	6	2437	Full	19.75	20.88	23.36	30.00		-0.10	23.26		36.00		Pass	
HE20	MCS0	2	6	2437	26/4	12.95	13.58	16.29	30.00		-0.10	16.19		36.00		Pass	
HE20	MCS0	2	6	2437	52/38	14.35	15.48	17.96	30.00		-0.10	17.86		36.00		Pass	
HE20	MCS0	2	6	2437	106/53	16.95	18.28	20.68	30.00		-0.10	20.58		36.00		Pass	
HE20	MCS0	2	10	2457	Full	19.65	19.78	22.73	30.00		-0.10	22.63		36.00		Pass	
HE20	MCS0	2	11	2462	Full	15.55	15.88	18.73	30.00		-0.10	18.63		36.00		Pass	
HE20	MCS0	2	11	2462	26/8	7.45	6.98	10.23	30.00		-0.10	10.13		36.00		Pass	
HE20	MCS0	2	11	2462	52/40	10.25	9.98	13.13	30.00		-0.10	13.03		36.00		Pass	
HE20	MCS0	2	11	2462	106/54	12.55	12.78	15.68	30.00		-0.10	15.58		36.00		Pass	
HE20	MCS0	2	12	2467	Full	13.75	14.08	16.93	30.00		-0.10	16.83		36.00		Pass	
HE20	MCS0	2	12	2467	26/8	6.65	6.28	9.48	30.00		-0.10	9.38		36.00		Pass	
HE20	MCS0	2	12	2467	52/40	9.85	9.38	12.63	30.00		-0.10	12.53		36.00		Pass	
HE20	MCS0	2	12	2467	106/54	11.85	11.68	14.78	30.00		-0.10	14.68		36.00		Pass	
HE20	MCS0	2	13	2472	Full	9.05	9.18	12.13	30.00		-0.10	12.03		36.00		Pass	
HE20	MCS0	2	13	2472	26/8	2.25	2.28	5.28	30.00		-0.10	5.18		36.00		Pass	
HE20	MCS0	2	13	2472	52/40	4.45	3.88	7.18	30.00		-0.10	7.08		36.00		Pass	
HE20	MCS0	2	13	2472	106/54	7.35	7.18	10.28	30.00		-0.10	10.18		36.00		Pass	

Note: Measured power (dBm) has offset with cable loss.

TEST RESULTS DATA
6dB and 99% Occupied Bandwidth

2.4GHz Band MIMO											
Mod.	Data Rate	NTX	CH.	Freq. (MHz)	RU Config.	99% Occupied BW (MHz)		6dB BW (MHz)		6dB BW Limit (MHz)	Pass/Fail
						Ant3	Ant4	Ant3	Ant4		
EHT20	MCS0	2	1	2412	Full	18.95	18.94	18.55	18.98	0.50	Pass
EHT20	MCS0	2	6	2437	Full	19.17	19.15	18.55	18.70	0.50	Pass
EHT20	MCS0	2	11	2462	Full	19.03	18.96	18.77	18.76	0.50	Pass
EHT20	MCS0	2	12	2467	Full	18.97	18.90	18.83	18.31	0.50	Pass
EHT20	MCS0	2	13	2472	Full	18.91	18.92	18.61	18.46	0.50	Pass

TEST RESULTS DATA
Average Output Power

2.4GHz Band MIMO																
Mod.	Data Rate	NTx	CH.	Freq. (MHz)	RU Config.	Average Conducted Power (dBm)			Conducted Power Limit (dBm)		DG (dBi)		EIRP Power (dBm)		EIRP Power Limit (dBm)	Pass /Fail
						Ant3	Ant4	SUM	Ant3	Ant4	Ant3	Ant4	Ant3	Ant4		
EHT20	MCS0	2	1	2412	Full	15.95	16.98	19.51	30.00		-0.10	19.41	36.00	Pass		
EHT20	MCS0	2	1	2412	26/0	9.25	9.28	12.28	30.00		-0.10	12.18	36.00	Pass		
EHT20	MCS0	2	1	2412	52/37	11.65	12.08	14.88	30.00		-0.10	14.78	36.00	Pass		
EHT20	MCS0	2	1	2412	106/53	13.25	13.58	16.43	30.00		-0.10	16.33	36.00	Pass		
EHT20	MCS0	2	1	2412	52T+26T/70	12.15	13.38	15.82	30.00		-0.10	15.72	36.00	Pass		
EHT20	MCS0	2	1	2412	106T+26T/82	13.65	14.98	17.38	30.00		-0.10	17.28	36.00	Pass		
EHT20	MCS0	2	2	2417	Full	20.45	20.78	23.63	30.00		-0.10	23.53	36.00	Pass		
EHT20	MCS0	2	6	2437	Full	19.85	20.98	23.46	30.00		-0.10	23.36	36.00	Pass		
EHT20	MCS0	2	6	2437	26/4	13.05	13.68	16.39	30.00		-0.10	16.29	36.00	Pass		
EHT20	MCS0	2	6	2437	52/38	14.45	15.58	18.06	30.00		-0.10	17.96	36.00	Pass		
EHT20	MCS0	2	6	2437	106/53	17.05	18.38	20.78	30.00		-0.10	20.68	36.00	Pass		
EHT20	MCS0	2	6	2437	52T+26T/71	15.55	17.88	19.88	30.00		-0.10	19.78	36.00	Pass		
EHT20	MCS0	2	6	2437	106T+26T/83	17.45	19.28	21.47	30.00		-0.10	21.37	36.00	Pass		
EHT20	MCS0	2	10	2457	Full	19.75	19.88	22.83	30.00		-0.10	22.73	36.00	Pass		
EHT20	MCS0	2	11	2462	Full	15.65	15.98	18.83	30.00		-0.10	18.73	36.00	Pass		
EHT20	MCS0	2	11	2462	26/8	7.55	7.08	10.33	30.00		-0.10	10.23	36.00	Pass		
EHT20	MCS0	2	11	2462	52/40	10.35	10.08	13.23	30.00		-0.10	13.13	36.00	Pass		
EHT20	MCS0	2	11	2462	106/54	12.65	12.88	15.78	30.00		-0.10	15.68	36.00	Pass		
EHT20	MCS0	2	11	2462	52T+26T/72	11.25	11.88	14.59	30.00		-0.10	14.49	36.00	Pass		
EHT20	MCS0	2	11	2462	106T+26T/83	12.95	13.68	16.34	30.00		-0.10	16.24	36.00	Pass		
EHT20	MCS0	2	12	2467	Full	13.85	14.18	17.03	30.00		-0.10	16.93	36.00	Pass		
EHT20	MCS0	2	12	2467	26/8	6.75	6.38	9.58	30.00		-0.10	9.48	36.00	Pass		
EHT20	MCS0	2	12	2467	52/40	9.95	9.48	12.73	30.00		-0.10	12.63	36.00	Pass		
EHT20	MCS0	2	12	2467	106/54	11.95	11.78	14.88	30.00		-0.10	14.78	36.00	Pass		
EHT20	MCS0	2	12	2467	52T+26T/72	10.95	11.38	14.18	30.00		-0.10	14.08	36.00	Pass		
EHT20	MCS0	2	12	2467	106T+26T/83	12.25	12.78	15.53	30.00		-0.10	15.43	36.00	Pass		
EHT20	MCS0	2	13	2472	Full	9.15	9.28	12.23	30.00		-0.10	12.13	36.00	Pass		
EHT20	MCS0	2	13	2472	26/8	2.35	2.38	5.38	30.00		-0.10	5.28	36.00	Pass		
EHT20	MCS0	2	13	2472	52/40	4.55	3.98	7.28	30.00		-0.10	7.18	36.00	Pass		
EHT20	MCS0	2	13	2472	106/54	7.45	7.28	10.38	30.00		-0.10	10.28	36.00	Pass		
EHT20	MCS0	2	13	2472	52T+26T/72	5.95	6.38	9.18	30.00		-0.10	9.08	36.00	Pass		
EHT20	MCS0	2	13	2472	106T+26T/83	7.25	7.68	10.48	30.00		-0.10	10.38	36.00	Pass		

Note: Measured power (dBm) has offset with cable loss.

TEST RESULTS DATA
Peak Power Spectral Density

2.4GHz Band MIMO													
Mod.	Data Rate	NTX	CH.	Freq. (MHz)	RU Config.	Peak PSD (dBm/3kHz)			DG (dBi)		Peak PSD Limit (dBm/3kHz)		Pass/Fail
						Ant3	Ant4	Worse + 3.01	Ant3	Ant4	Ant3	Ant4	
EHT20	MCS0	2	1	2412	Full	-9.12	-7.80	-4.79	2.81		8.00		Pass
EHT20	MCS0	2	1	2412	26/0	-7.92	-9.13	-4.91	2.81		8.00		Pass
EHT20	MCS0	2	1	2412	52/37	-8.95	-7.90	-4.89	2.81		8.00		Pass
EHT20	MCS0	2	1	2412	106/53	-9.92	-8.25	-5.24	2.81		8.00		Pass
EHT20	MCS0	2	1	2412	52T+26T/70	-9.47	-8.08	-5.07	2.81		8.00		Pass
EHT20	MCS0	2	1	2412	106T+26T/82	-9.66	-7.99	-4.98	2.81		8.00		Pass
EHT20	MCS0	2	6	2437	Full	-3.98	-4.19	-0.97	2.81		8.00		Pass
EHT20	MCS0	2	6	2437	26/4	-4.87	-4.24	-1.23	2.81		8.00		Pass
EHT20	MCS0	2	6	2437	52/38	-5.15	-4.26	-1.25	2.81		8.00		Pass
EHT20	MCS0	2	6	2437	106/53	-5.43	-4.27	-1.26	2.81		8.00		Pass
EHT20	MCS0	2	6	2437	52T+26T/71	-6.37	-4.39	-1.38	2.81		8.00		Pass
EHT20	MCS0	2	6	2437	106T+26T/83	-6.58	-4.40	-1.39	2.81		8.00		Pass
EHT20	MCS0	2	11	2462	Full	-10.87	-9.69	-6.68	2.81		8.00		Pass
EHT20	MCS0	2	11	2462	26/8	-10.97	-10.12	-7.11	2.81		8.00		Pass
EHT20	MCS0	2	11	2462	52/40	-10.32	-9.92	-6.91	2.81		8.00		Pass
EHT20	MCS0	2	11	2462	106/54	-10.81	-9.95	-6.94	2.81		8.00		Pass
EHT20	MCS0	2	11	2462	52T+26T/72	-10.93	-9.71	-6.70	2.81		8.00		Pass
EHT20	MCS0	2	11	2462	106T+26T/83	-11.40	-10.02	-7.01	2.81		8.00		Pass
EHT20	MCS0	2	12	2467	Full	-11.60	-10.27	-7.26	2.81		8.00		Pass
EHT20	MCS0	2	12	2467	26/8	-10.62	-11.47	-7.61	2.81		8.00		Pass
EHT20	MCS0	2	12	2467	52/40	-10.79	-10.61	-7.60	2.81		8.00		Pass
EHT20	MCS0	2	12	2467	106/54	-11.28	-10.40	-7.39	2.81		8.00		Pass
EHT20	MCS0	2	12	2467	52T+26T/72	-11.06	-10.60	-7.59	2.81		8.00		Pass
EHT20	MCS0	2	12	2467	106T+26T/83	-11.96	-10.47	-7.46	2.81		8.00		Pass
EHT20	MCS0	2	13	2472	Full	-15.41	-15.94	-12.40	2.81		8.00		Pass
EHT20	MCS0	2	13	2472	26/8	-16.27	-15.56	-12.55	2.81		8.00		Pass
EHT20	MCS0	2	13	2472	52/40	-16.12	-15.92	-12.91	2.81		8.00		Pass
EHT20	MCS0	2	13	2472	106/54	-15.73	-15.94	-12.72	2.81		8.00		Pass
EHT20	MCS0	2	13	2472	52T+26T/72	-15.97	-15.62	-12.61	2.81		8.00		Pass
EHT20	MCS0	2	13	2472	106T+26T/83	-16.86	-15.79	-12.78	2.81		8.00		Pass

Measured power density (dBm) has offset with cable loss.



6dB and 99% Occupied Bandwidth

<802.11b>

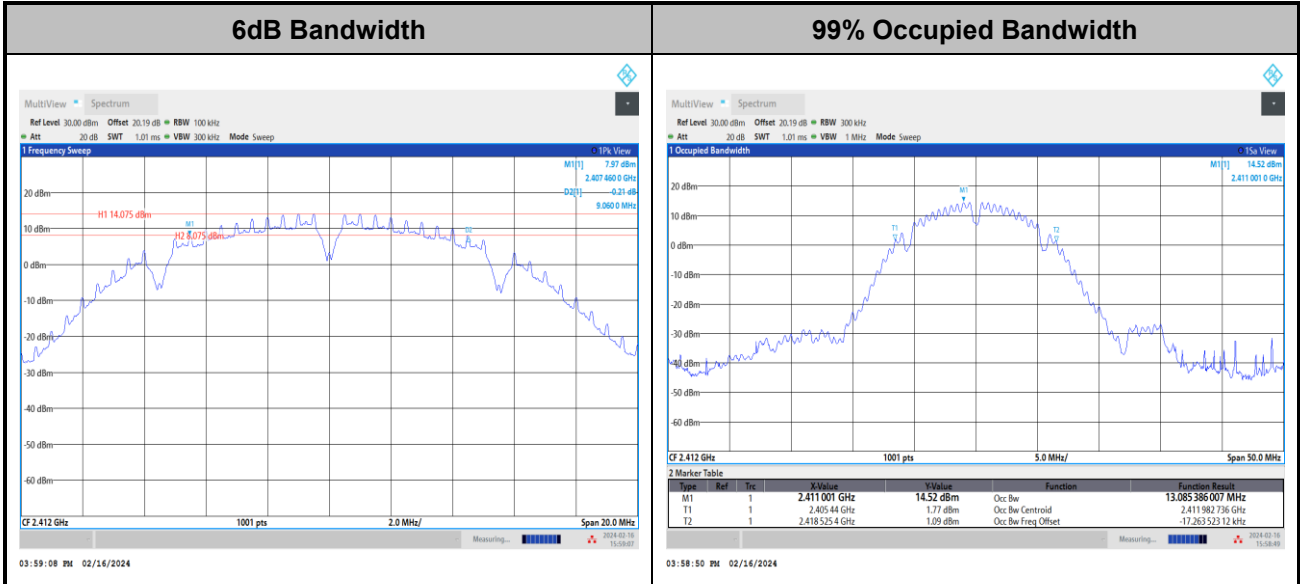

Note: The occupied channel bandwidth is maintained within the band of operation for all of the modulations.



Power Spectral Density(dBm/3kHz)

<802.11b>

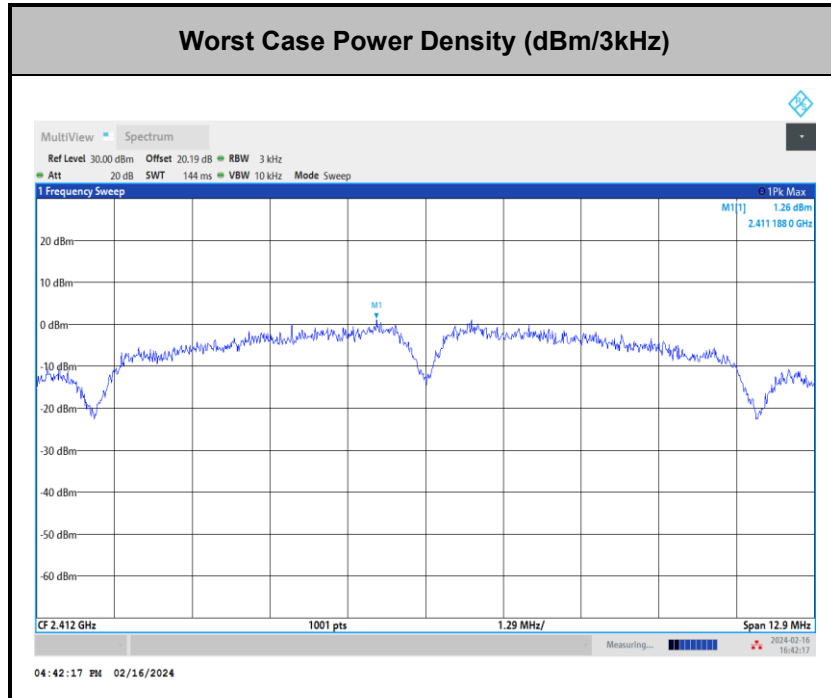



Band Edges and Spurious Emission

Number of TX = 1, Ant. 3 (Measured)

Test Mode :	802.11b	Test Channel :	01
-------------	---------	----------------	----

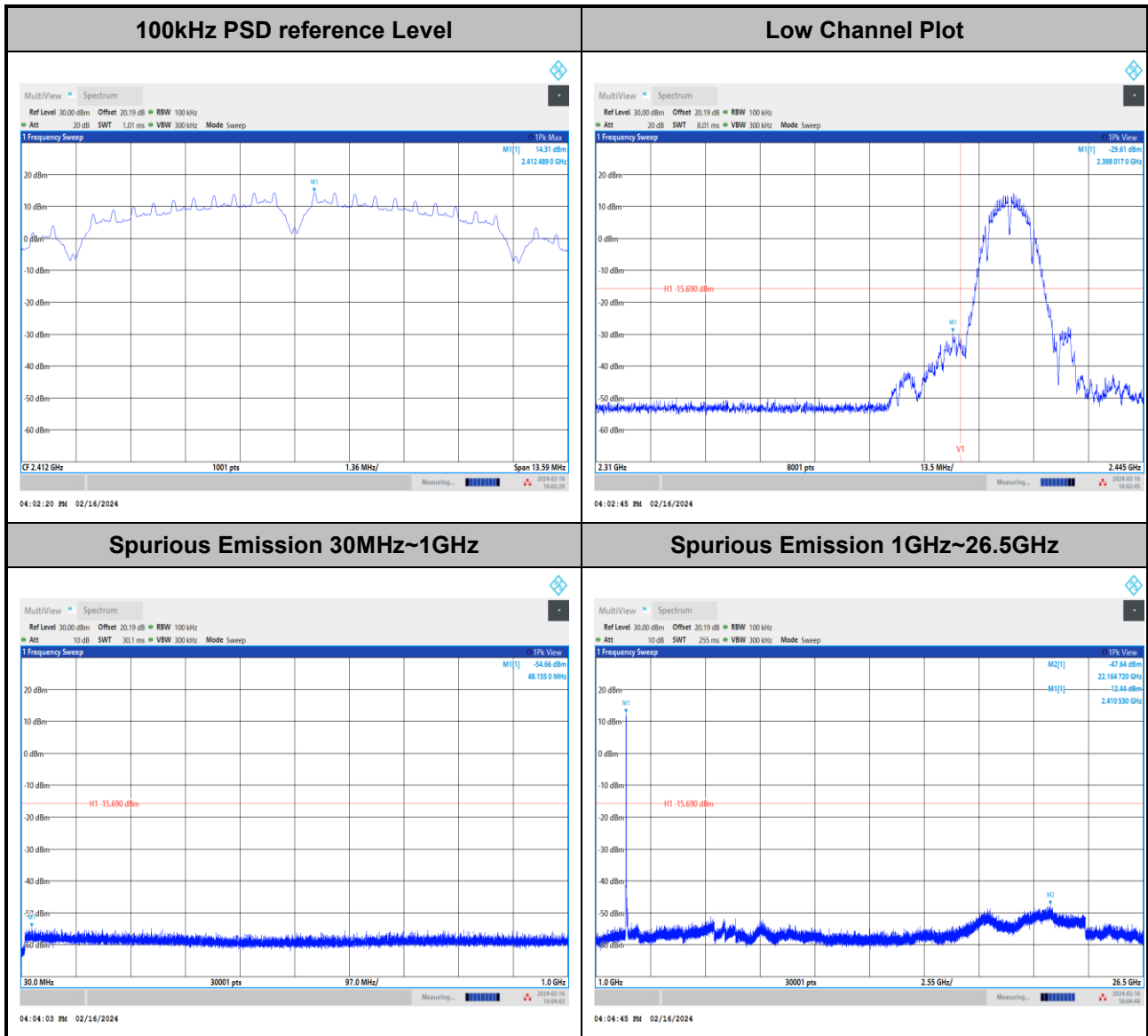



Test Mode :	802.11b	Test Channel :	06
-------------	---------	----------------	----

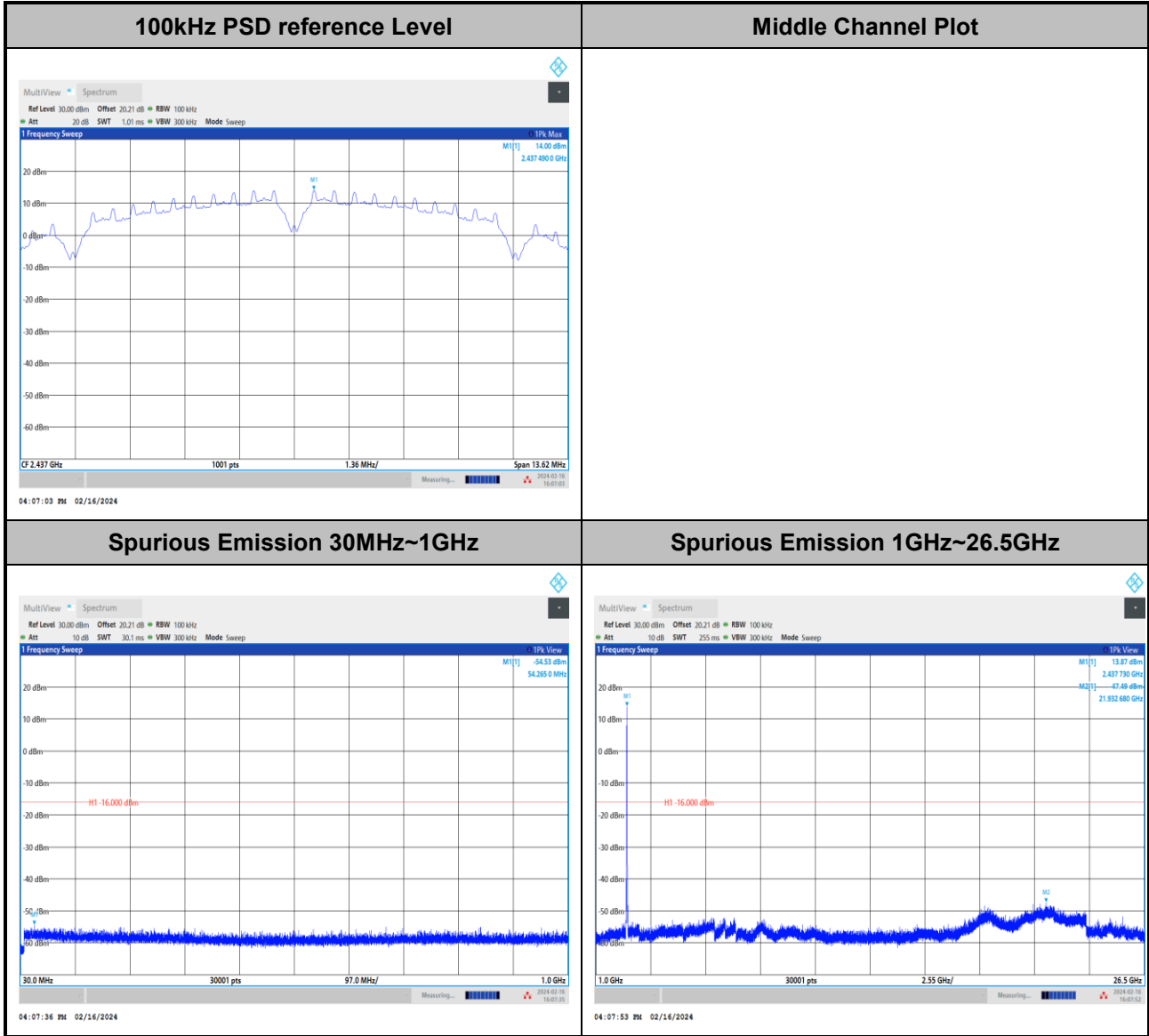



Test Mode :	802.11b	Test Channel :	11
-------------	---------	----------------	----

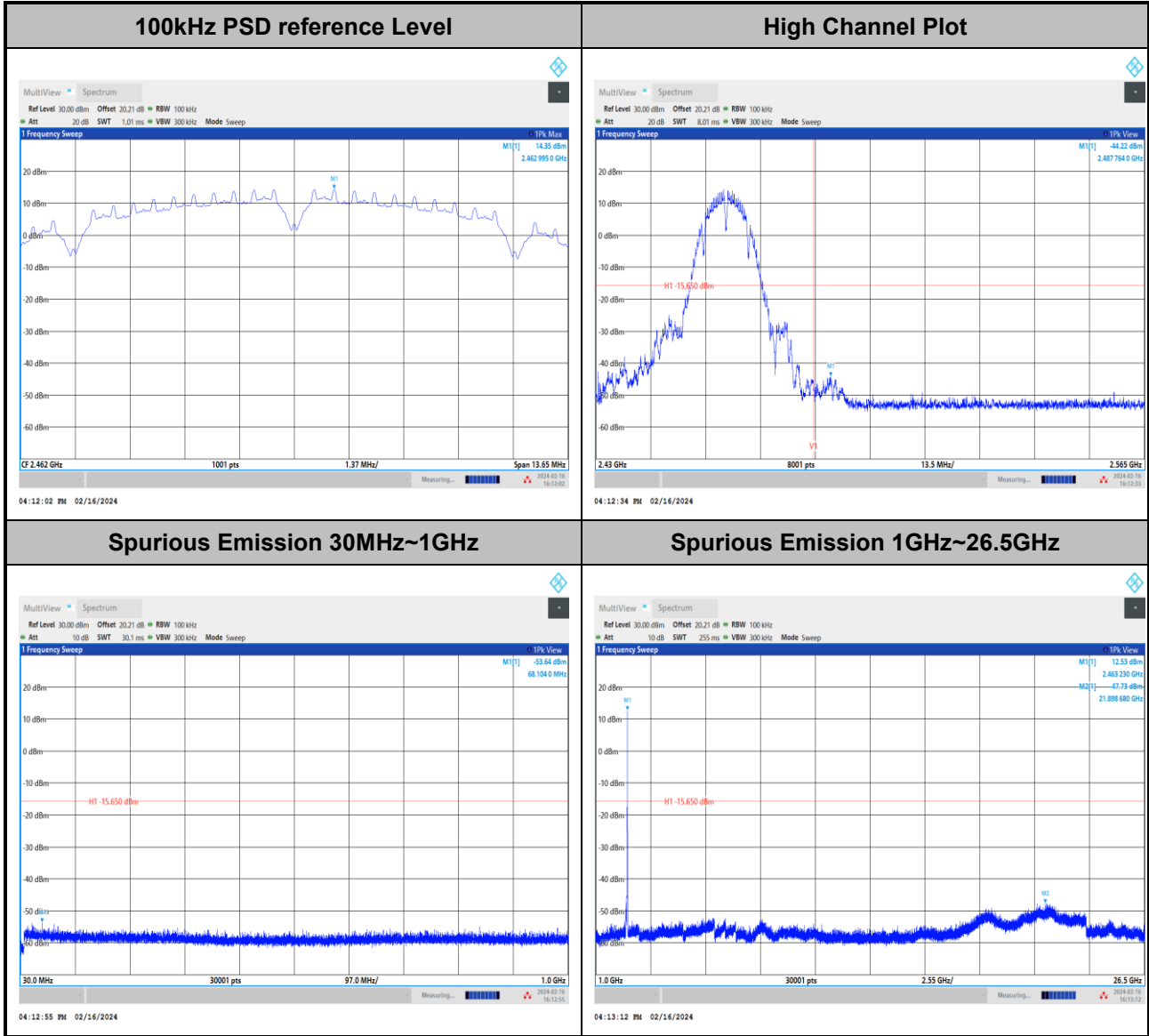



Test Mode :	802.11b	Test Channel :	12
-------------	---------	----------------	----

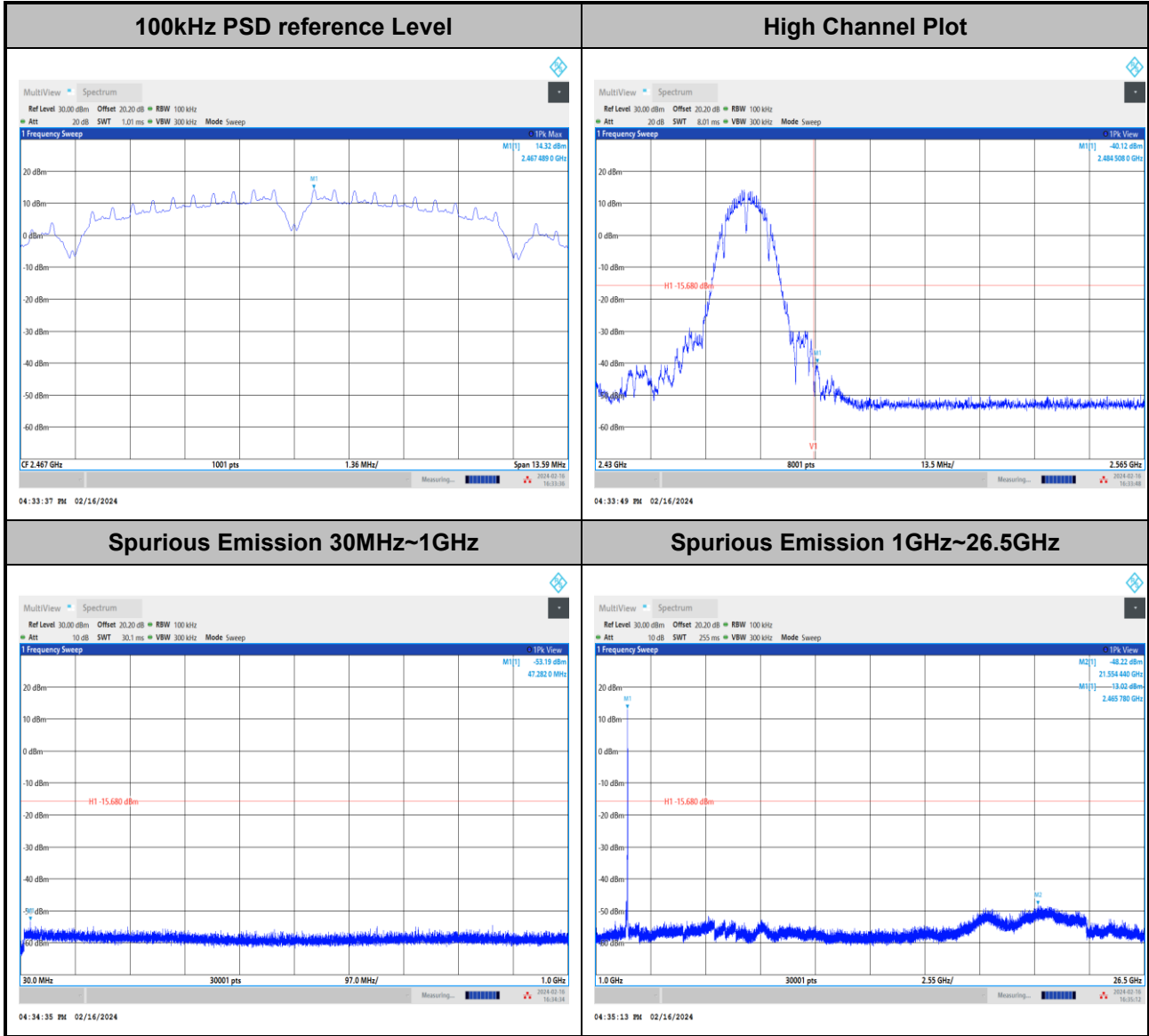



Test Mode :	802.11b	Test Channel :	13
-------------	---------	----------------	----

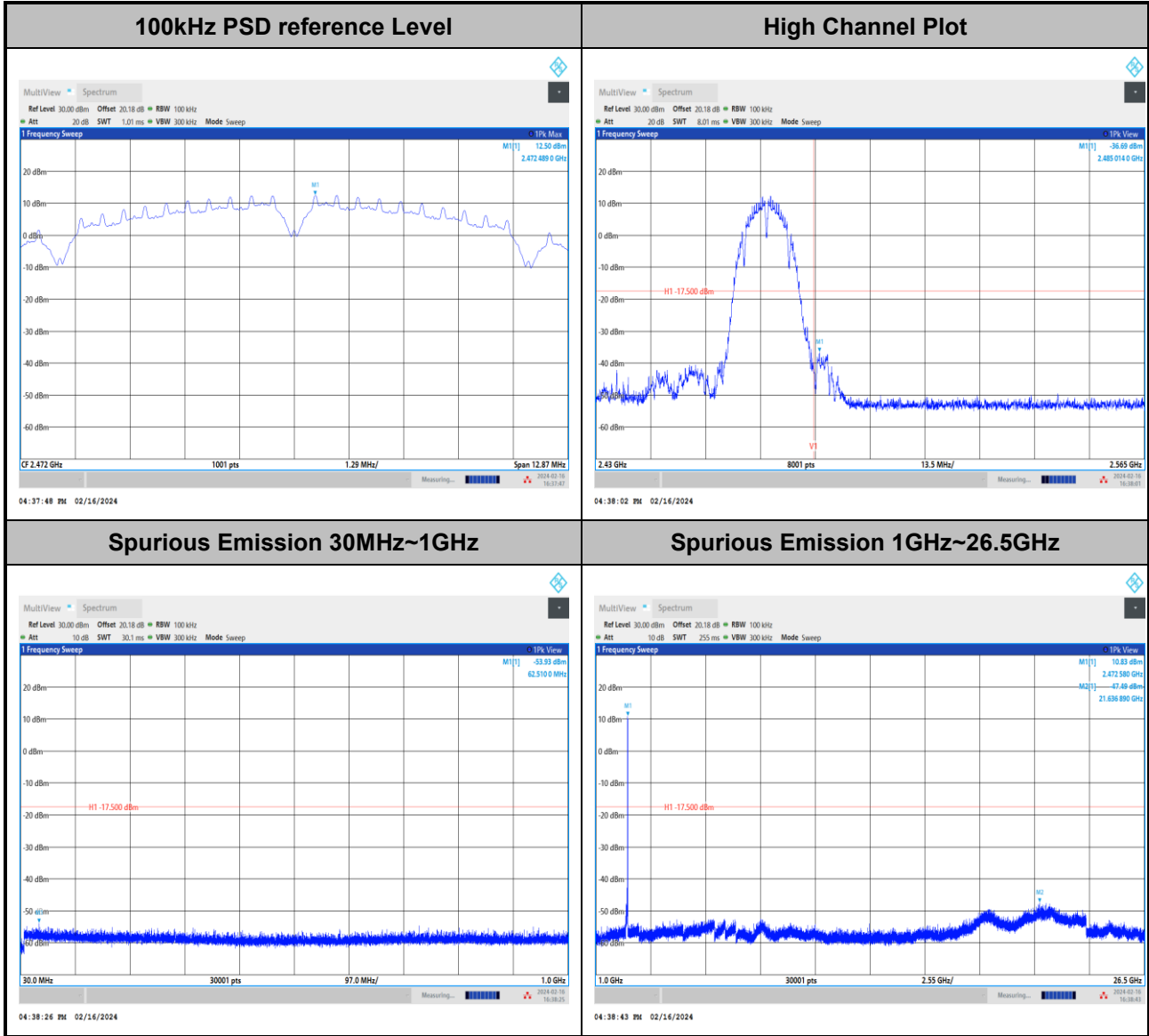



Number of TX = 1, Ant. 4 (Measured)

Test Mode :	802.11b	Test Channel :	01
-------------	---------	----------------	----

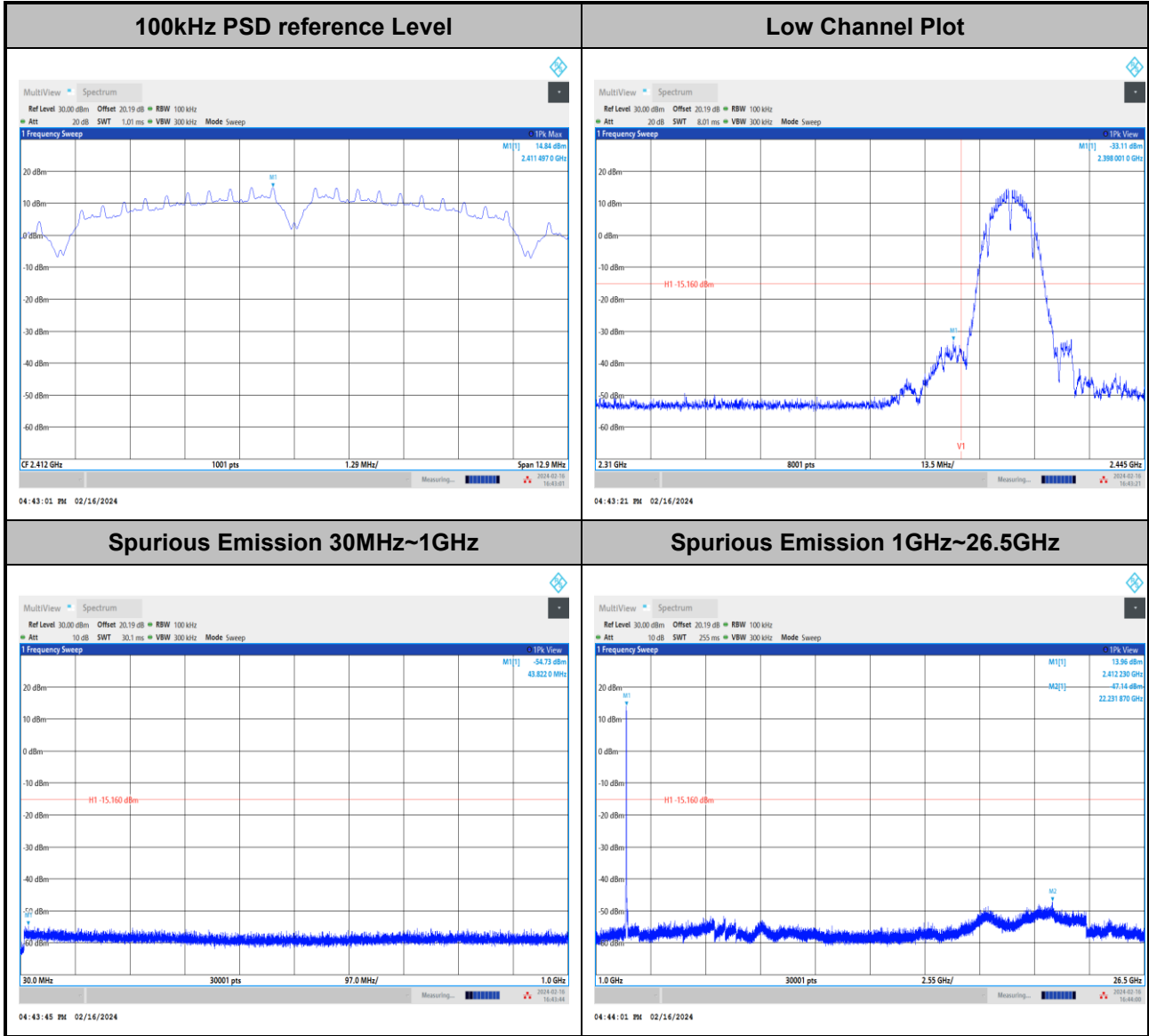



Test Mode :	802.11b	Test Channel :	06
-------------	---------	----------------	----

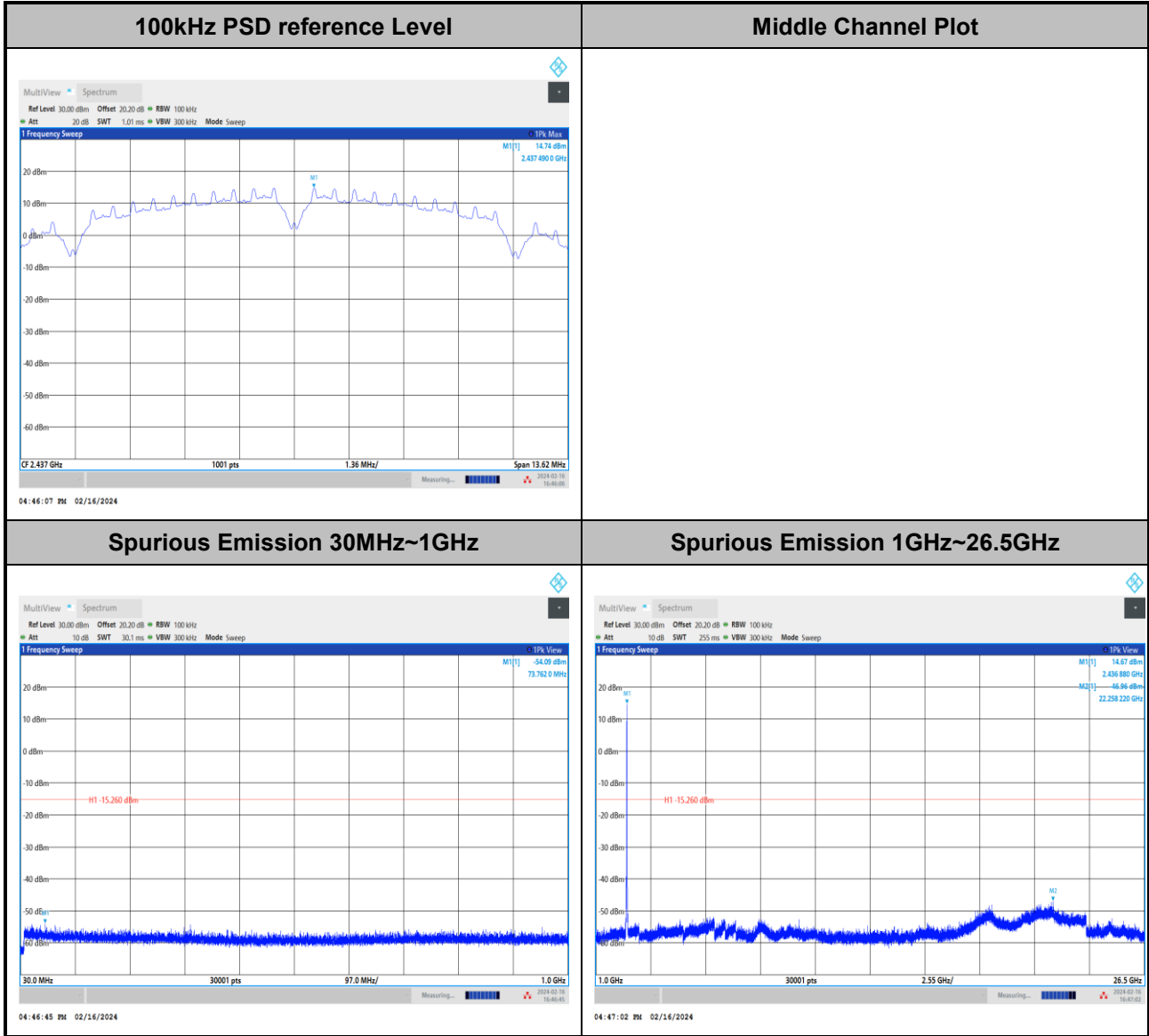



Test Mode :	802.11b	Test Channel :	11
-------------	---------	----------------	----

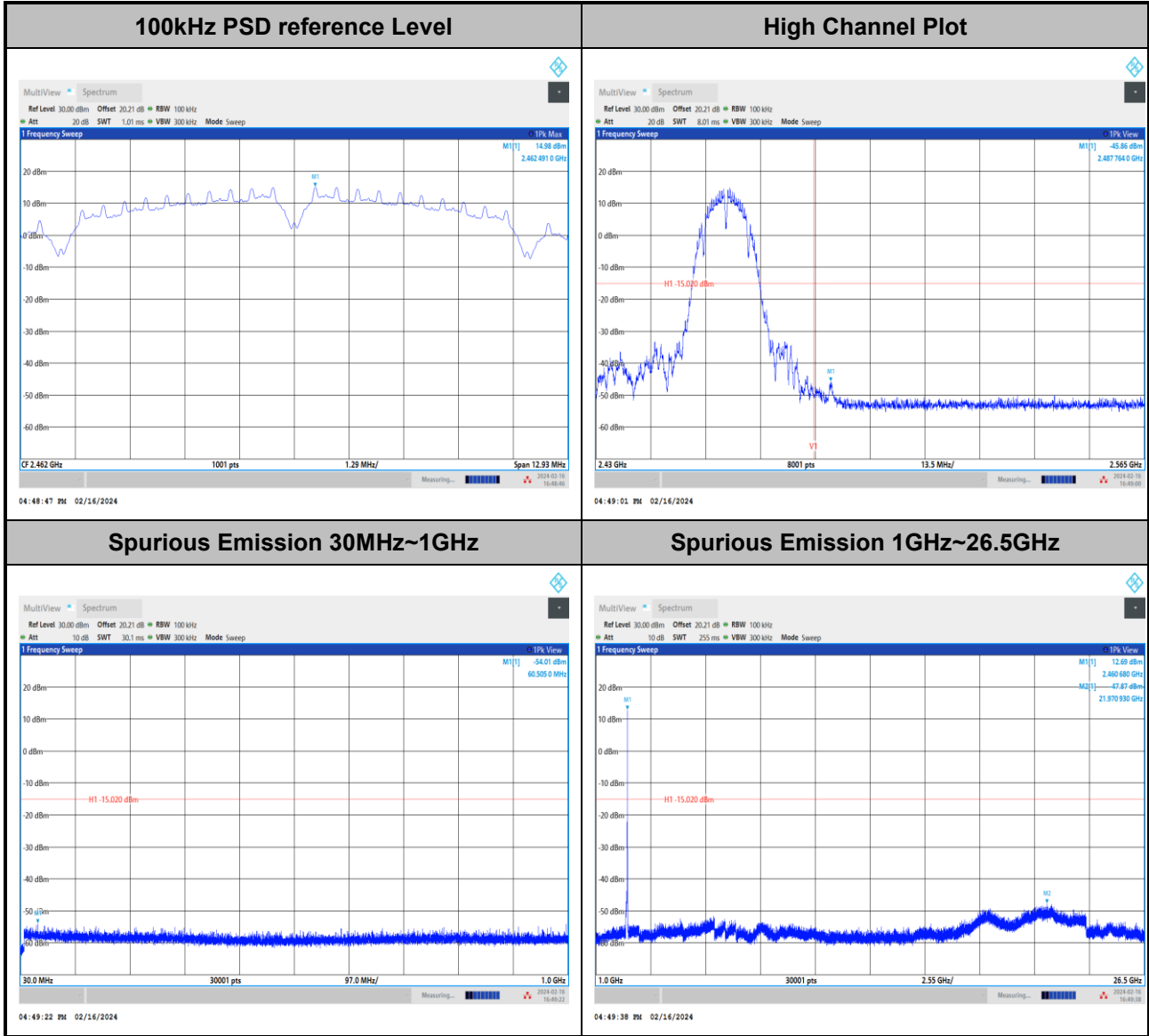



Test Mode :	802.11b	Test Channel :	12
-------------	---------	----------------	----

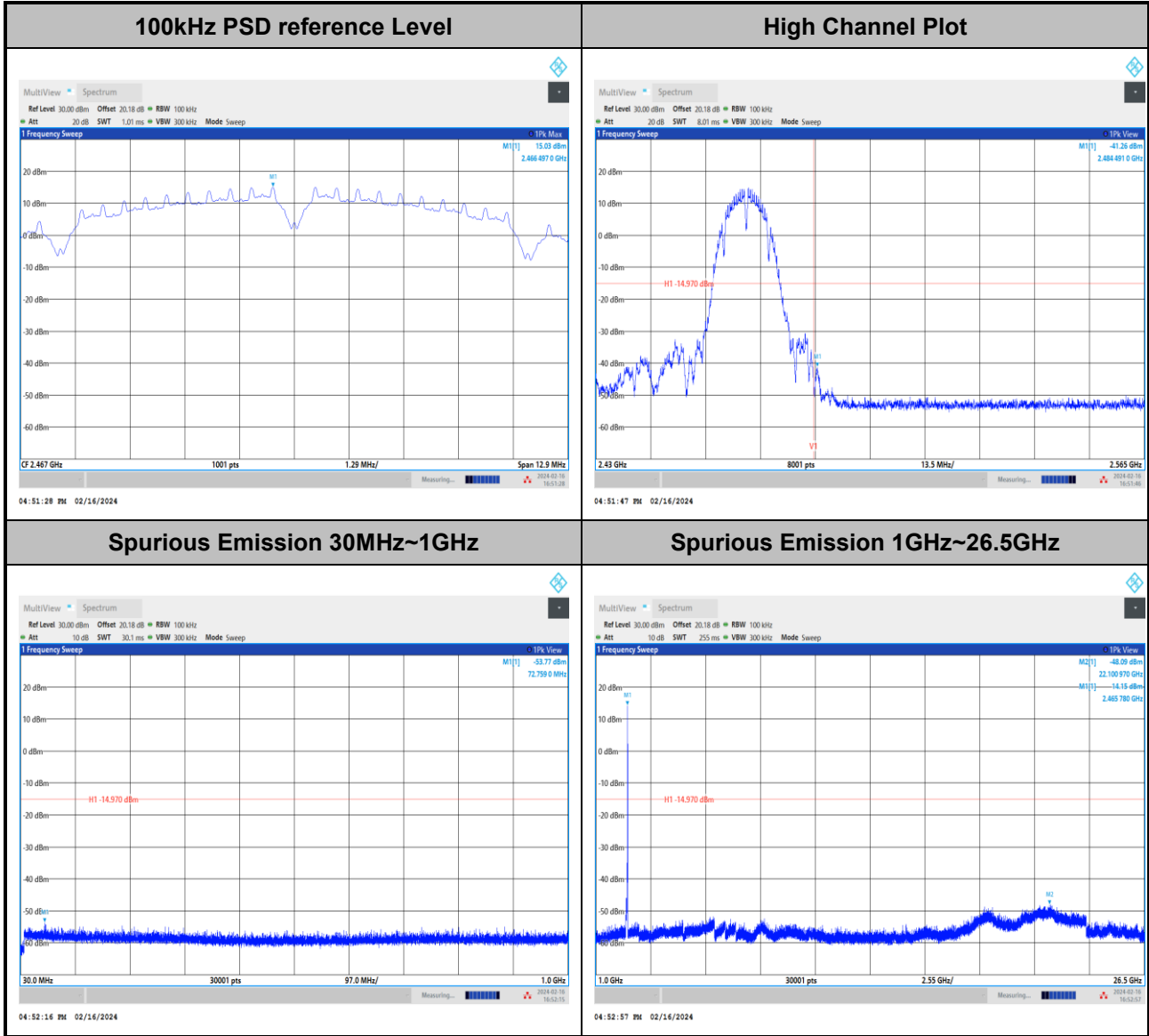



Test Mode :	802.11b	Test Channel :	13
-------------	---------	----------------	----

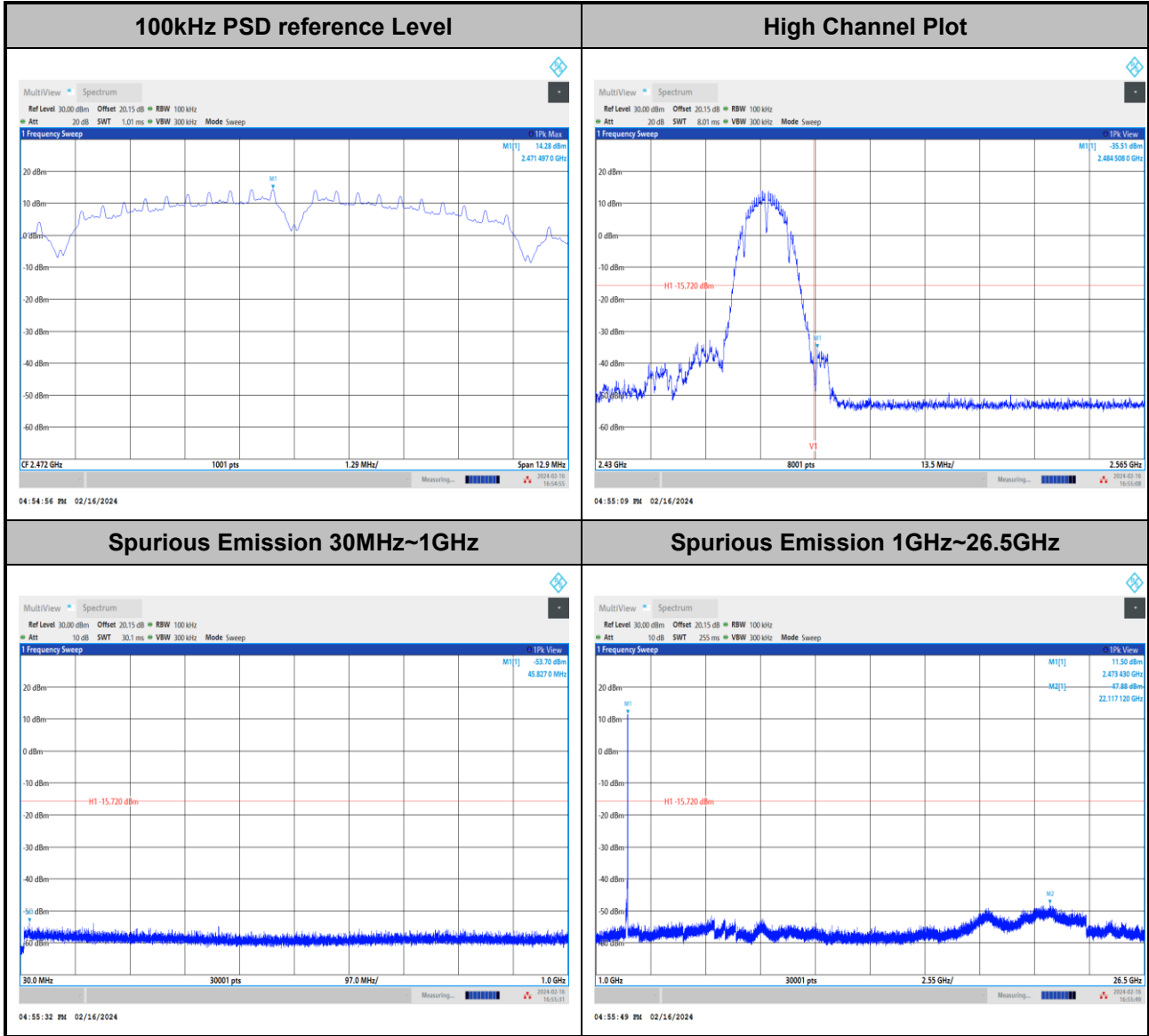



6dB and 99% Occupied Bandwidth

<802.11g>

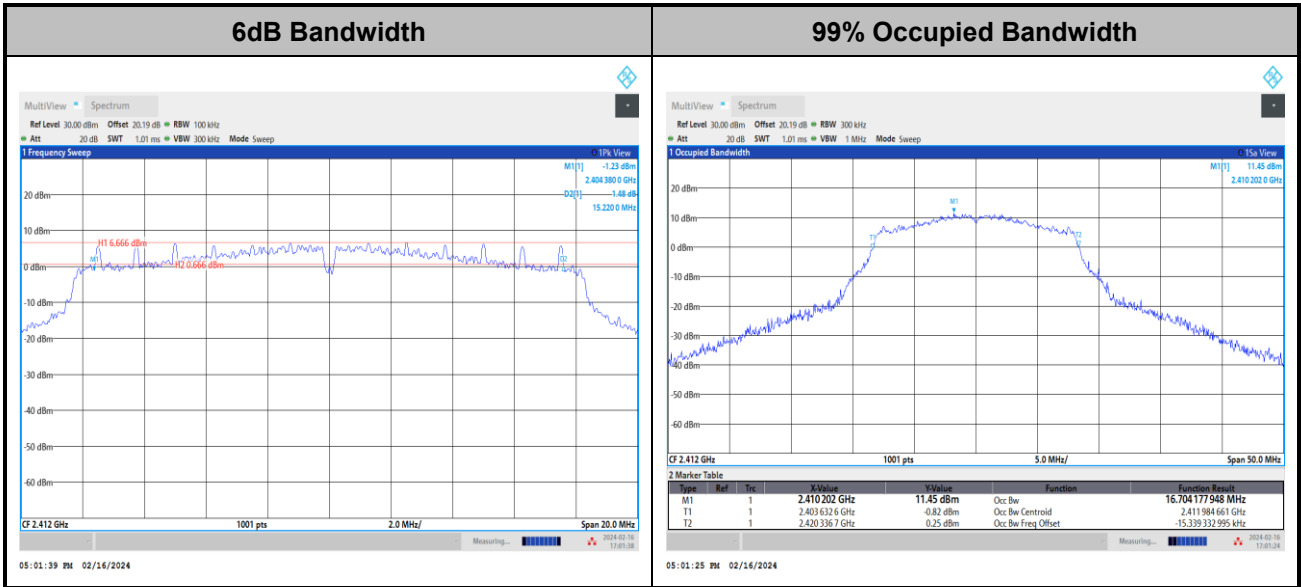

Note: The occupied channel bandwidth is maintained within the band of operation for all of the modulations.

<802.11be EHT20>

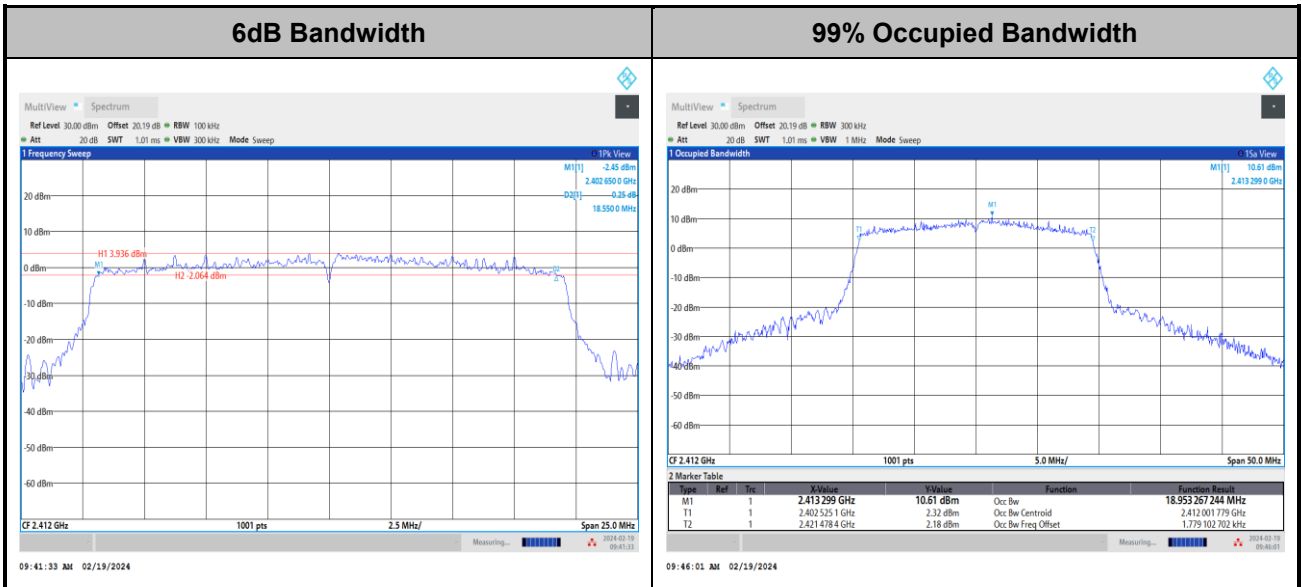

Note: The occupied channel bandwidth is maintained within the band of operation for all of the modulations.



Power Spectral Density(dBm/3kHz)

<802.11g>

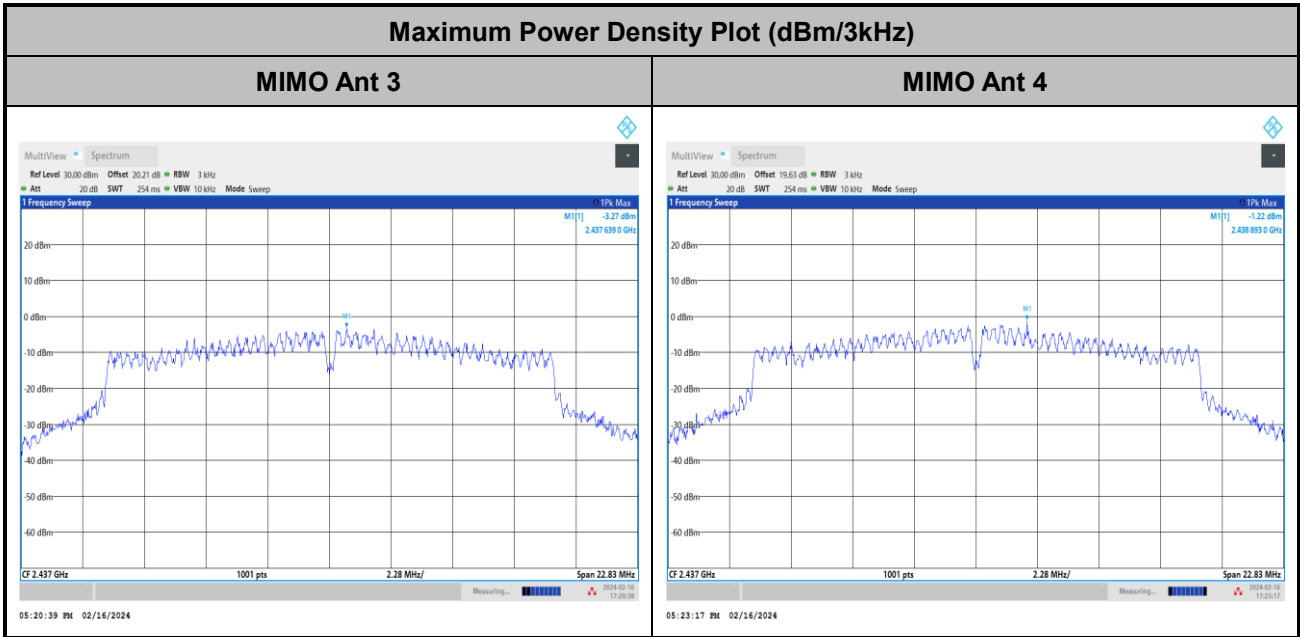

<802.11be EHT20>

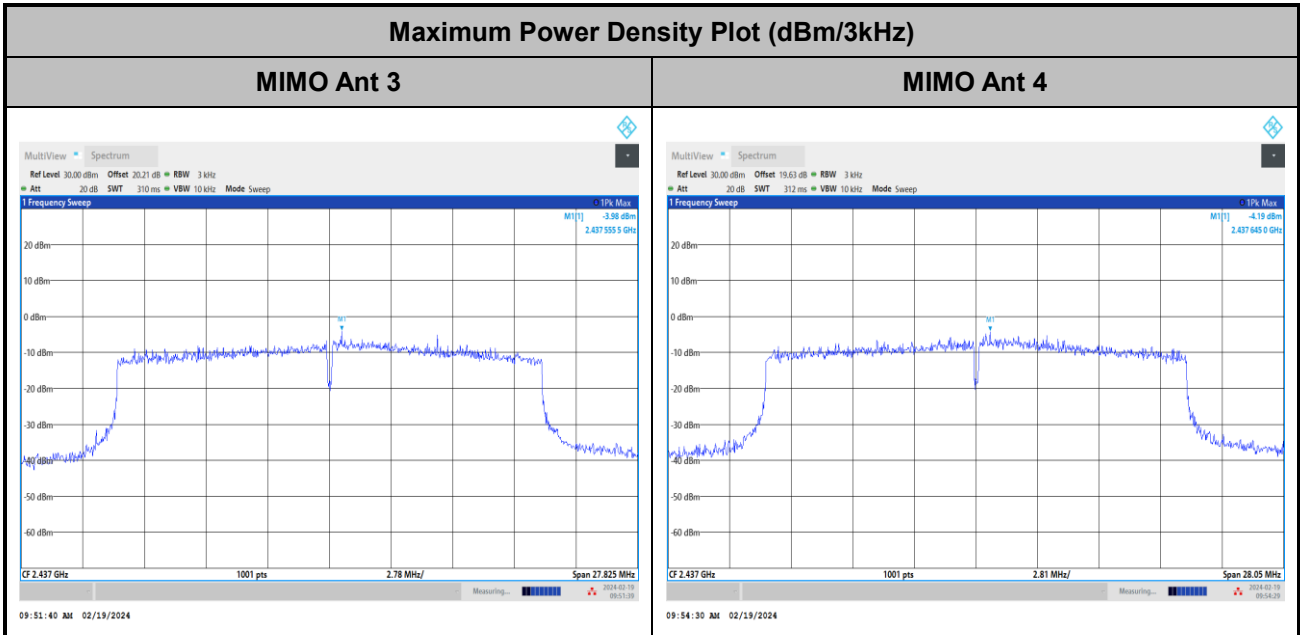



Band Edges and Spurious Emission

Number of TX = 2, Ant. 3 (Measured)

Test Mode :	802.11g	Test Channel :	01
-------------	---------	----------------	----

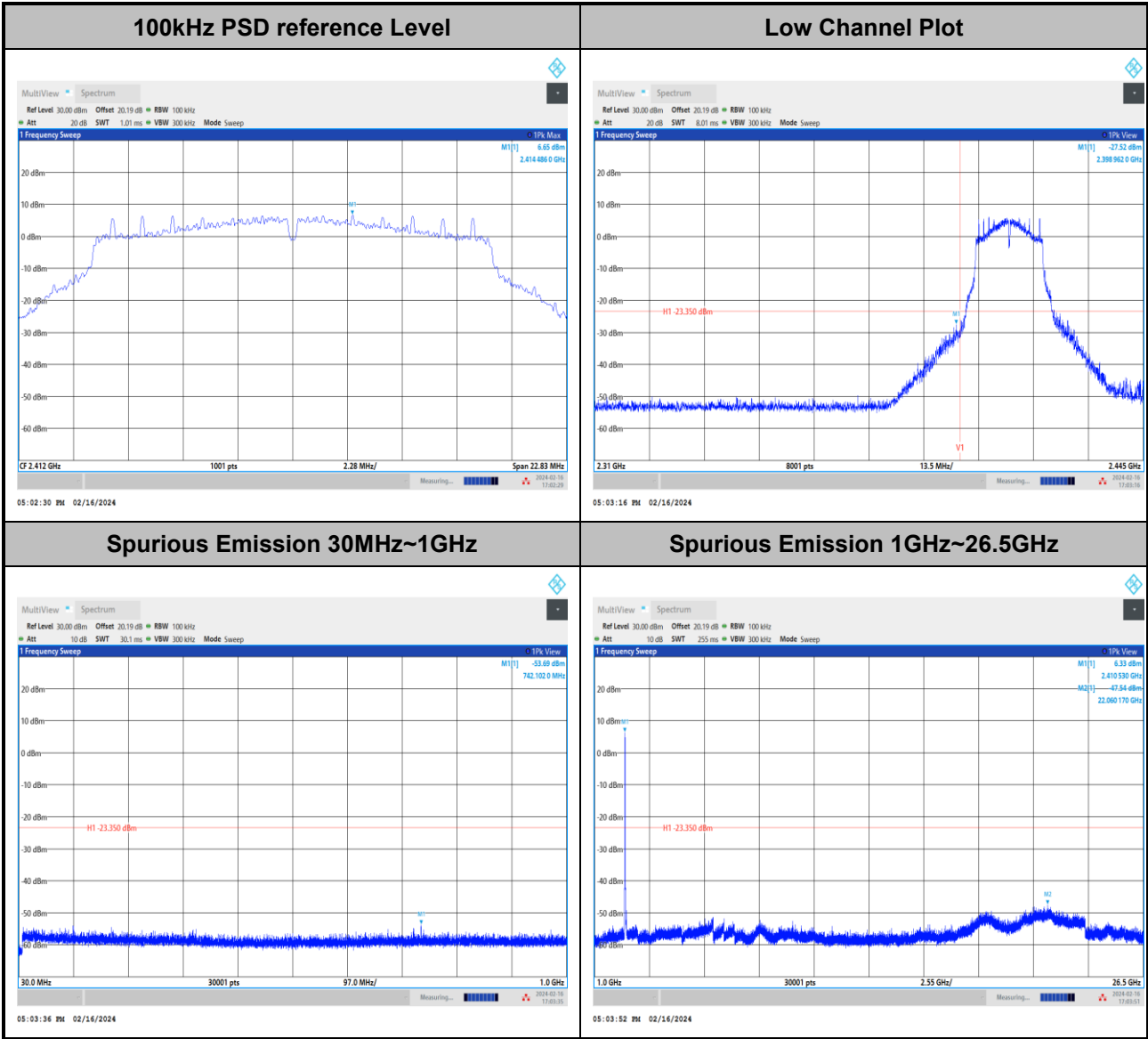



Test Mode :	802.11g	Test Channel :	06
--------------------	---------	-----------------------	----

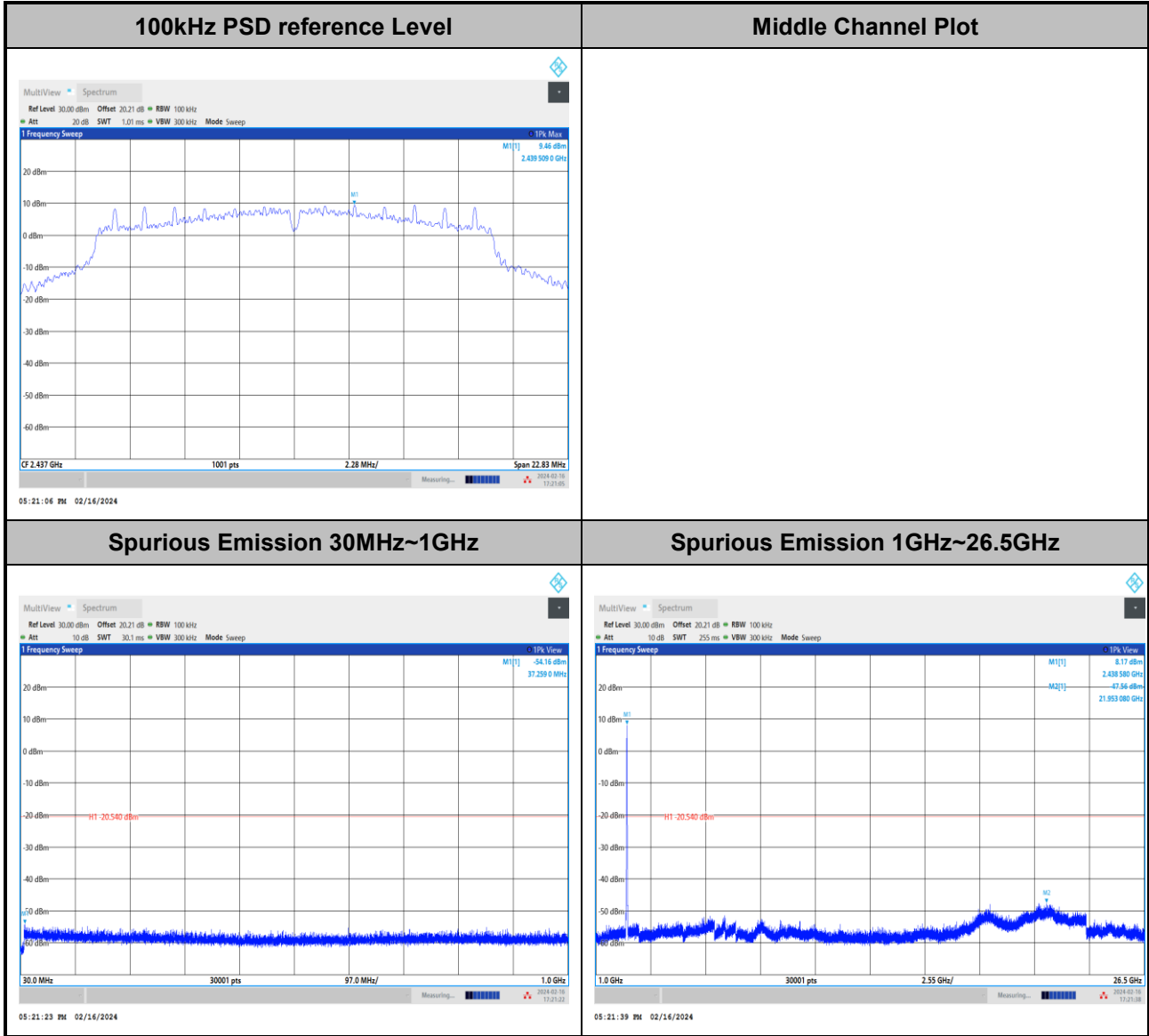



Test Mode :	802.11g	Test Channel :	11
-------------	---------	----------------	----

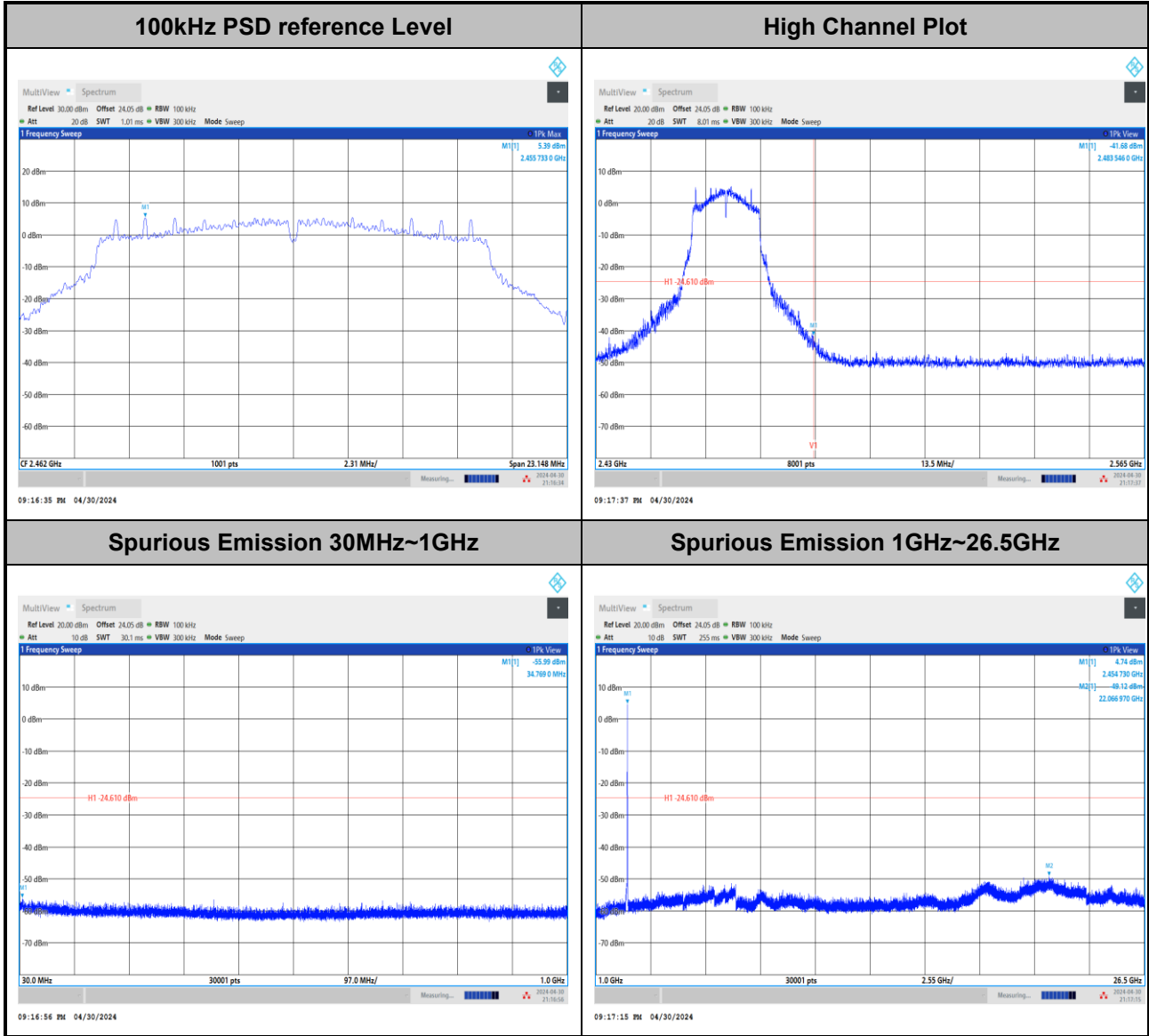



Test Mode :	802.11g	Test Channel :	12
-------------	---------	----------------	----

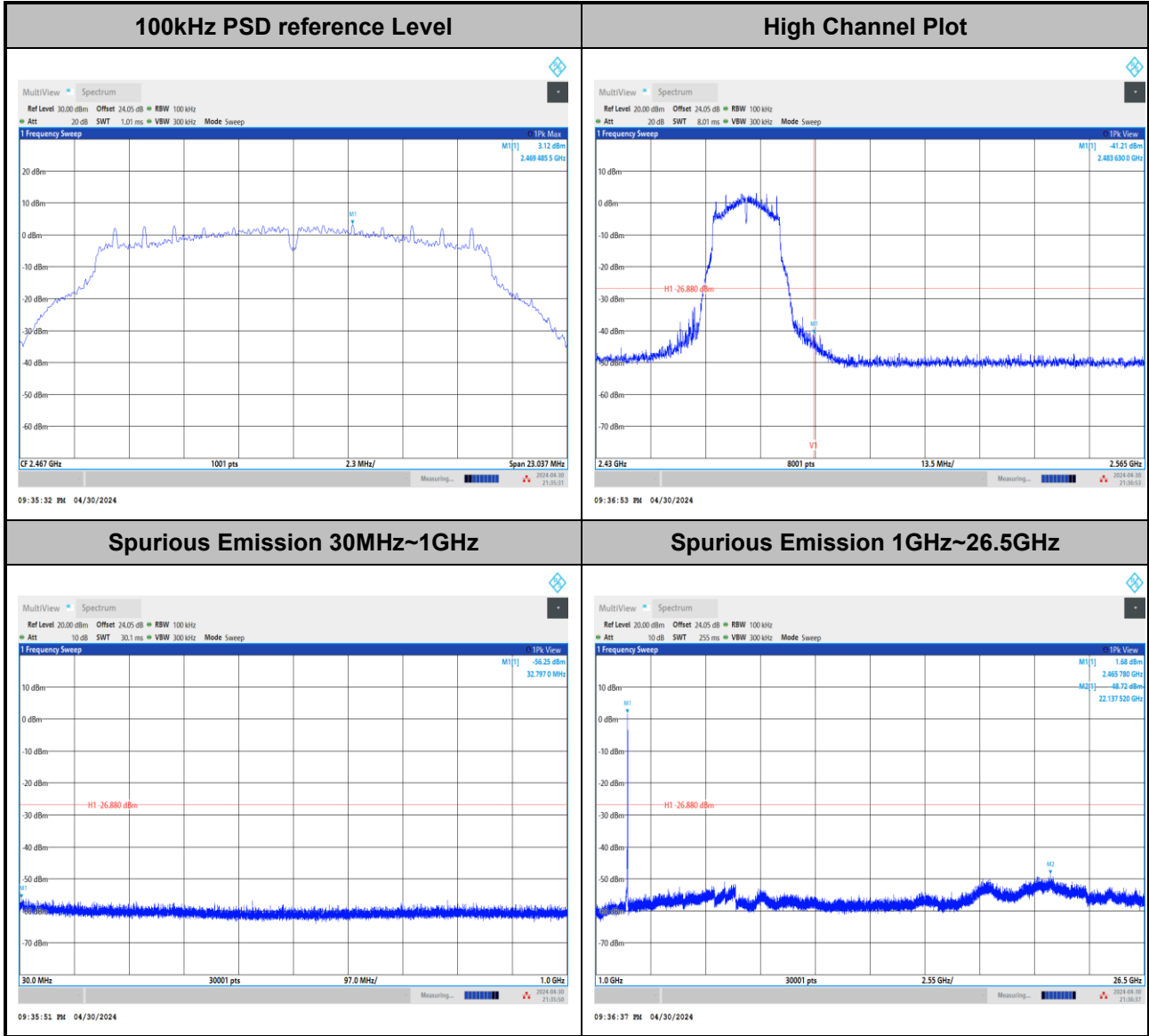



Test Mode :	802.11g	Test Channel :	13
-------------	---------	----------------	----

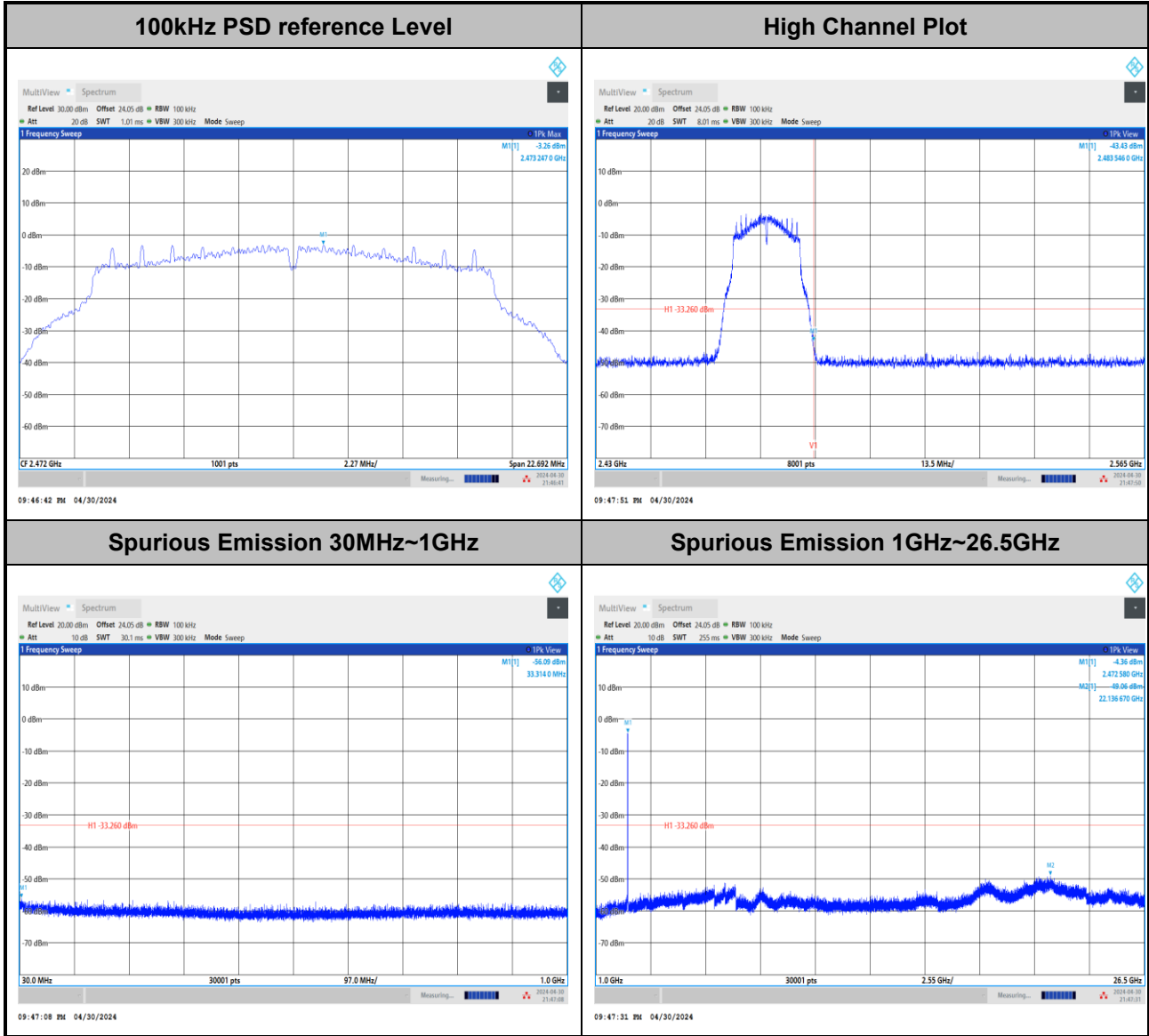



Test Mode :	802.11be EHT20	Test Channel :	01
-------------	----------------	----------------	----

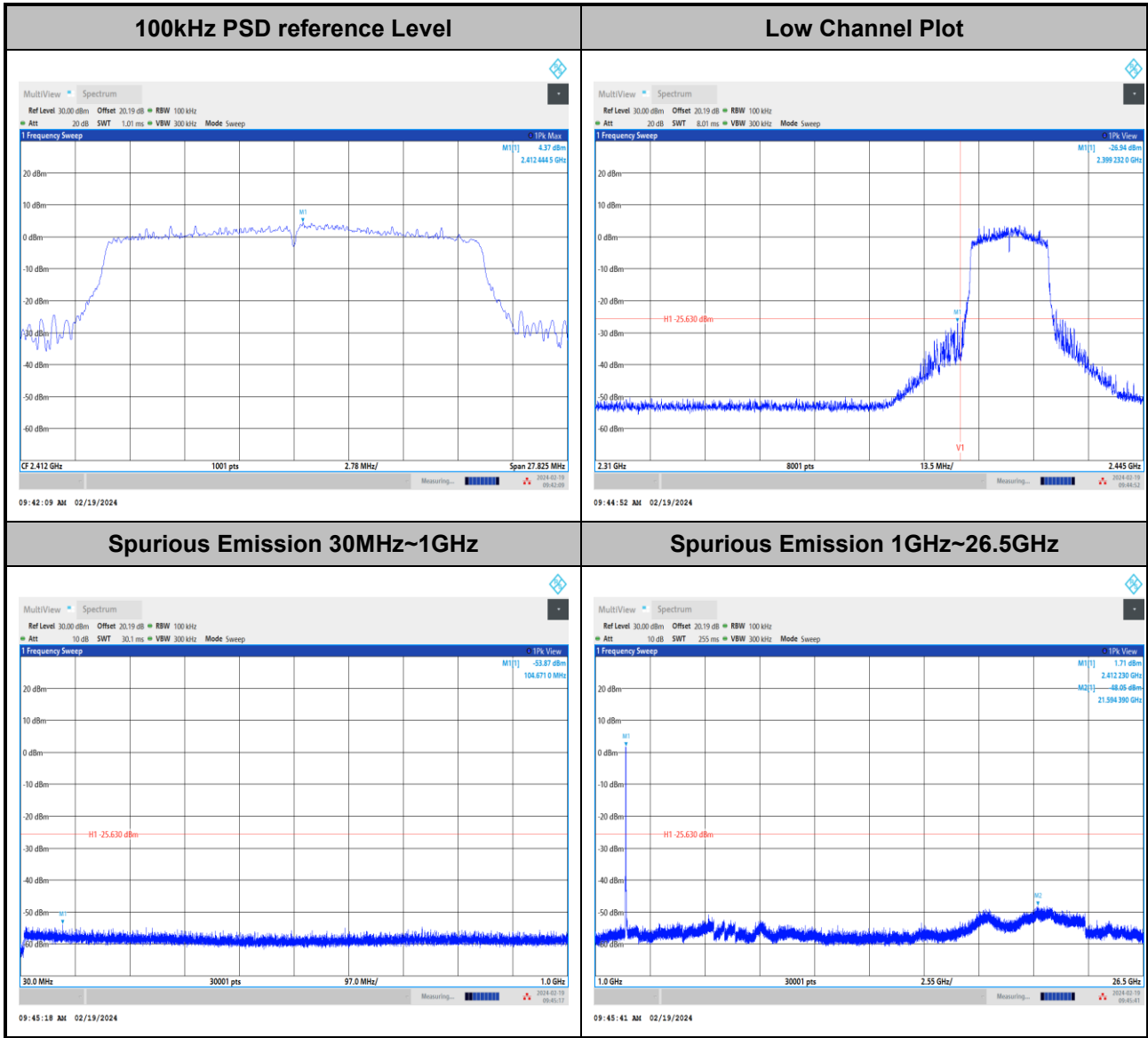



Test Mode :	802.11be EHT20	Test Channel :	06
--------------------	----------------	-----------------------	----

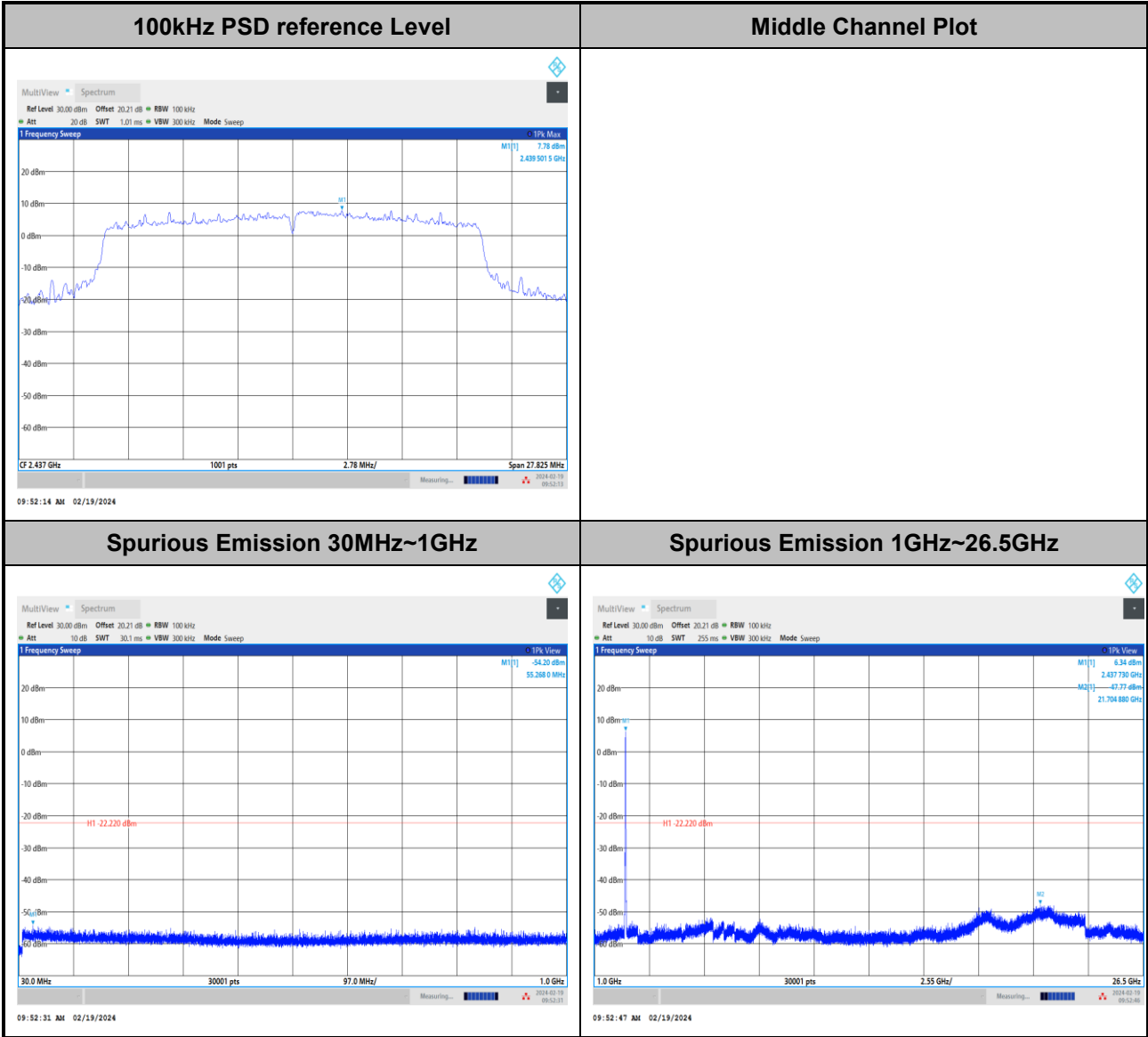



Test Mode :	802.11be EHT20	Test Channel :	11
--------------------	----------------	-----------------------	----

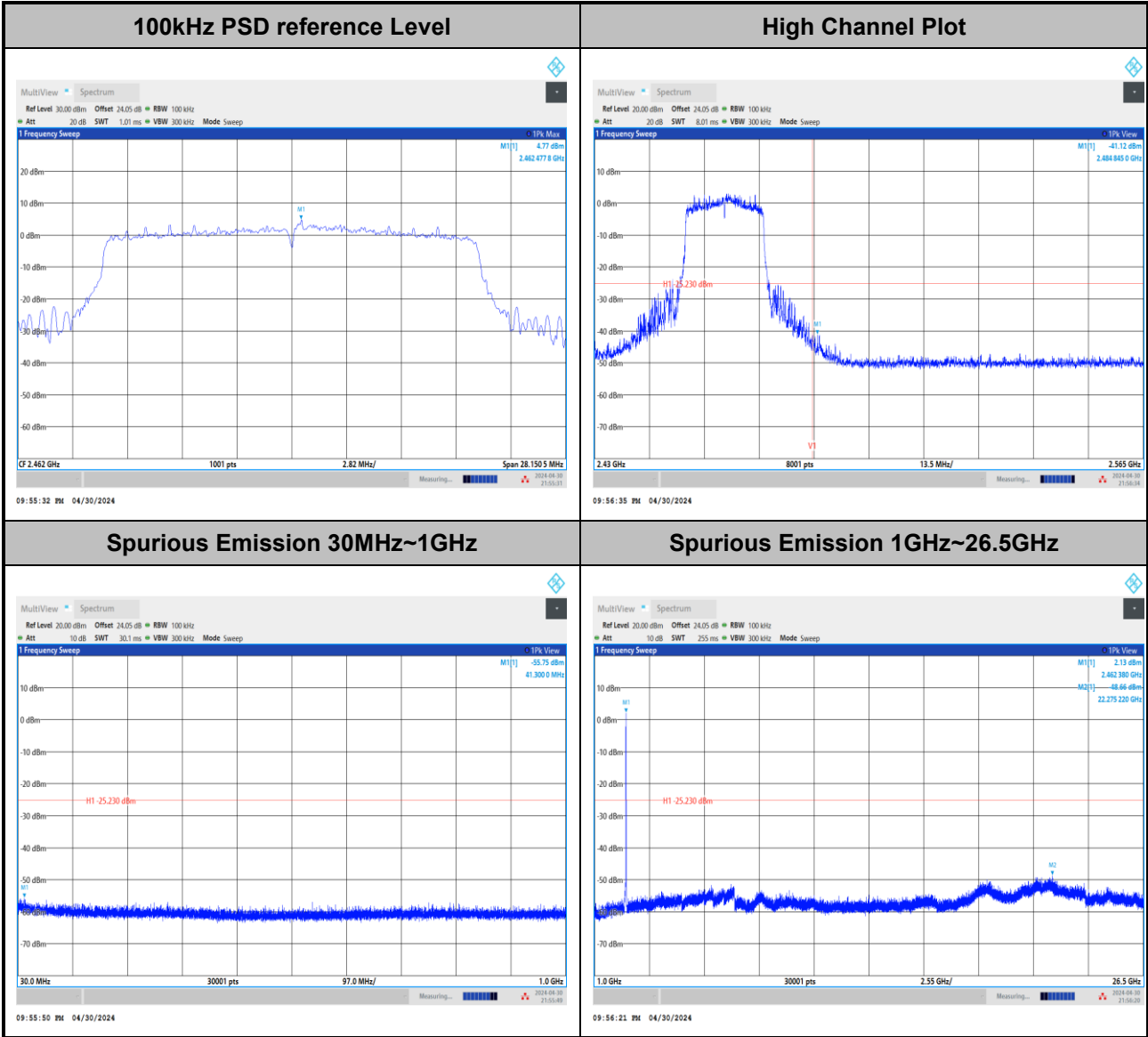



Test Mode :	802.11be EHT20	Test Channel :	12
-------------	----------------	----------------	----

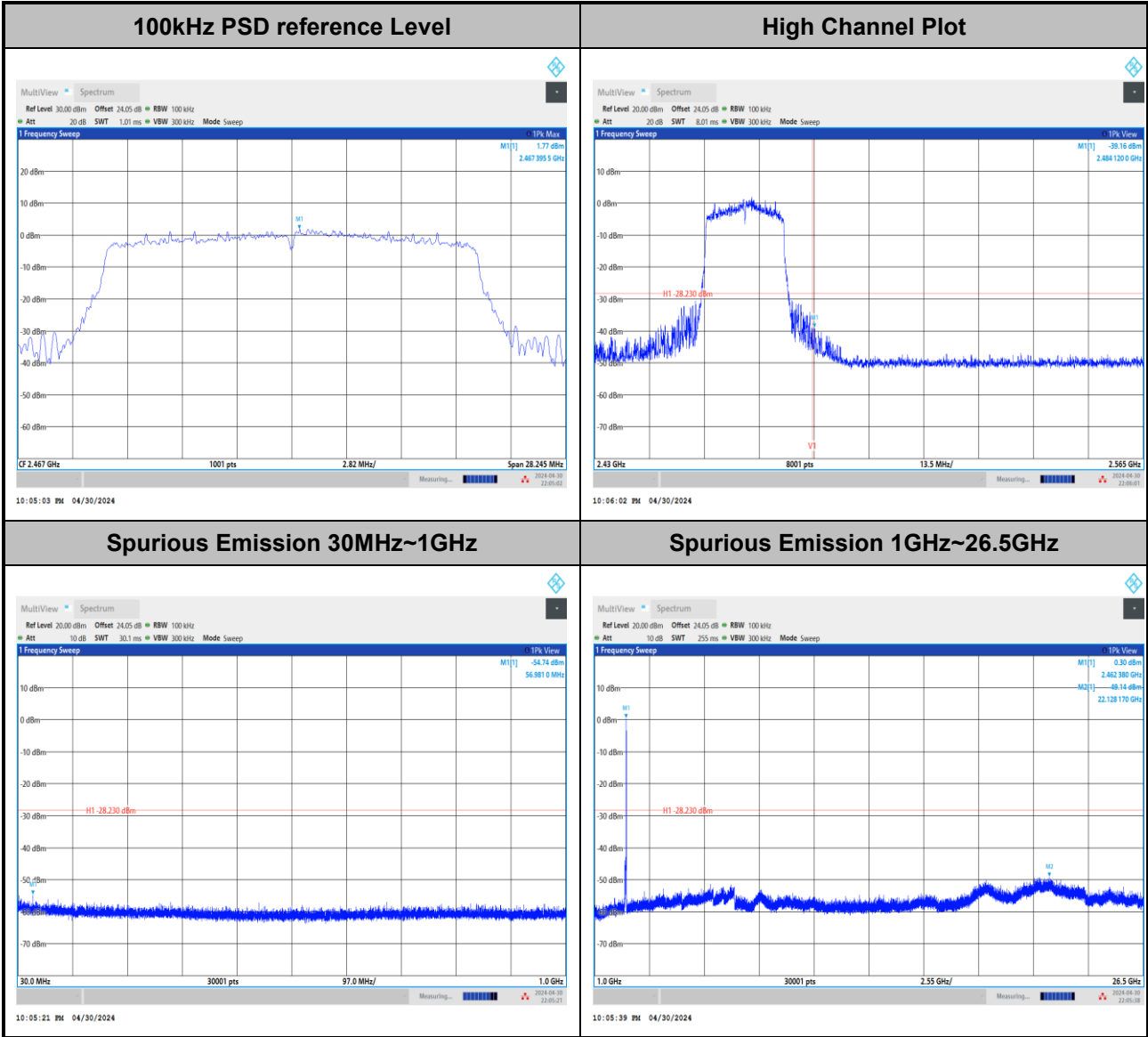



Test Mode :	802.11be EHT20	Test Channel :	13
-------------	----------------	----------------	----

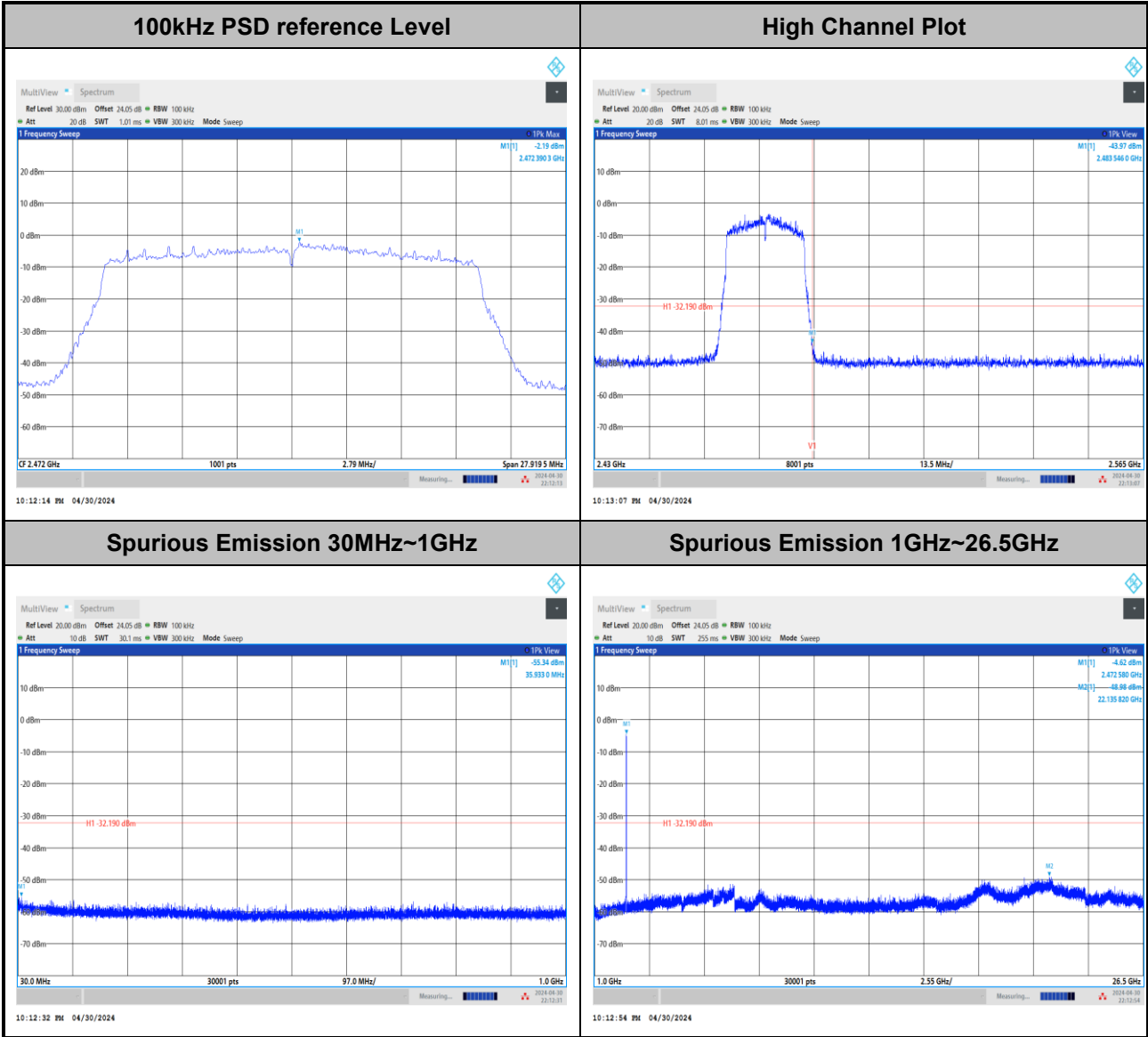



Number of TX = 2, Ant. 4 (Measured)

Test Mode :	802.11g	Test Channel :	01
-------------	---------	----------------	----

