



FCC RADIO TEST REPORT

FCC ID : A4RGR83Y
Equipment : Phone
Model Name : GR83Y
Applicant : Google LLC
1600 Amphitheatre Parkway,
Mountain View, California, 94043 USA
Standard : FCC Part 15 Subpart C §15.247

The product was received on Dec. 20, 2023 and testing was performed from Jan. 11, 2024 to Mar. 27, 2024. We, Sporton International Inc. Wensan Laboratory, would like to declare that the tested sample has been evaluated in accordance with the test procedures and has been in compliance with the applicable technical standards.

The test results in this report apply exclusively to the tested model / sample. Without written approval from Sporton International Inc. Wensan Laboratory, the test report shall not be reproduced except in full.

Approved by: Louis Wu

Sporton International Inc. Wensan Laboratory

No.58, Aly. 75, Ln. 564, Wenhua 3rd, Rd., Guishan Dist., Taoyuan City 333010, Taiwan (R.O.C.)



Table of Contents

History of this test report..... 3

Summary of Test Result..... 4

1 General Description..... 5

 1.1 Product Feature of Equipment Under Test..... 5

 1.2 Modification of EUT 5

 1.3 Testing Location 6

 1.4 Applicable Standards..... 6

2 Test Configuration of Equipment Under Test 7

 2.1 Carrier Frequency Channel 7

 2.2 Test Mode..... 8

 2.3 Connection Diagram of Test System..... 9

 2.4 Support Unit used in test configuration and system 10

 2.5 EUT Operation Test Setup 11

 2.6 Measurement Results Explanation Example..... 11

3 Test Result..... 12

 3.1 Number of Channel Measurement 12

 3.2 Hopping Channel Separation Measurement 13

 3.3 Dwell Time Measurement..... 14

 3.4 20dB and 99% Bandwidth Measurement 15

 3.5 Output Power Measurement..... 16

 3.6 Conducted Band Edges Measurement..... 17

 3.7 Conducted Spurious Emission Measurement 18

 3.8 Radiated Band Edges and Spurious Emission Measurement 19

 3.9 AC Conducted Emission Measurement..... 23

 3.10 Antenna Requirements..... 25

4 List of Measuring Equipment 26

5 Measurement Uncertainty 28

Appendix A. Conducted Test Results

Appendix B. AC Conducted Emission Test Result

Appendix C. Radiated Spurious Emission

Appendix D. Radiated Spurious Emission Plots

Appendix E. Duty Cycle Plots

Appendix F. Setup Photographs



History of this test report

Report No.	Version	Description	Issue Date
FR3N2325L	01	Initial issue of report	Apr. 13, 2024
FR3N2325L	02	1. Revise Appendix A 2. Revise List of Measuring Equipment This report is an updated version, replacing the report issued on Apr. 13, 2024.	May 06, 2024



Summary of Test Result

Report Clause	Ref Std. Clause	Test Items	Result (PASS/FAIL)	Remark
3.1	15.247(a)(1)	Number of Channels	Pass	-
3.2	15.247(a)(1)	Hopping Channel Separation	Pass	-
3.3	15.247(a)(1)	Dwell Time of Each Channel	Pass	-
3.4	15.247(a)(1)	20dB Bandwidth	Pass	-
3.4	2.1049	99% Occupied Bandwidth	Reporting only	-
3.5	15.247(b)(1) 15.247(b)(4)	Peak Output Power	Pass	-
3.6	15.247(d)	Conducted Band Edges	Pass	-
3.7	15.247(d)	Conducted Spurious Emission	Pass	-
3.8	15.247(d)	Radiated Band Edges and Radiated Spurious Emission	Pass	6.22 dB under the limit at 51.42 MHz
3.9	15.207	AC Conducted Emission	Pass	9.26 dB under the limit at 0.16 MHz
3.10	15.203	Antenna Requirement	Pass	-

Conformity Assessment Condition:

1. The test results (PASS/FAIL) with all measurement uncertainty excluded are presented against the regulation limits or in accordance with the requirements stipulated by the applicant/manufacturer who shall bear all the risks of non-compliance that may potentially occur if measurement uncertainty is taken into account.
2. The measurement uncertainty please refer to each test result in the section "Measurement Uncertainty".

Disclaimer:

The product specifications of the EUT presented in the test report that may affect the test assessments are declared by the manufacturer who shall take full responsibility for the authenticity.

Reviewed by: William Chen
Report Producer: Lilian Hou



1 General Description

1.1 Product Feature of Equipment Under Test

Product Feature
<p>General Specs GSM/WCDMA/LTE/5G NR, Bluetooth, BLE, BLE channel sounding, Thread, Wi-Fi 802.11be, UWB, NFC, WPT, NTN and GNSS.</p> <p>Antenna Type Bluetooth: <Ant.3>: IFA Antenna <Ant.4>: ILA Antenna</p>

EUT Information List	
S/N	Performed Test Item
41101FDAP0002H	RF Conducted Measurement
41051FDAP0001R	Radiated Spurious Emission
3B131FDAP0007E	Conducted Emission

Antenna information		
2400 MHz ~ 2483.5 MHz	Peak Gain (dBi)	Ant.3: -0.10 Ant.4: -0.30

Remark: The EUT's information above is declared by manufacturer. Please refer to Disclaimer in report summary.

1.2 Modification of EUT

No modifications made to the EUT during the testing.



1.3 Testing Location

Test Site	Sporton International Inc. Wensan Laboratory
Test Site Location	No.58, Aly. 75, Ln. 564, Wenhua 3rd, Rd., Guishan Dist., Taoyuan City 333010, Taiwan (R.O.C.) TEL: +886-3-327-0868 FAX: +886-3-327-0855
Test Site No.	Sporton Site No. TH05-HY, CO07-HY, 03CH15-HY

Note: The test site complies with ANSI C63.4 2014 requirement.

FCC designation No.: TW3786

1.4 Applicable Standards

According to the specifications declared by the manufacturer, the EUT must comply with the requirements of the following standards:

- ♦ FCC Part 15 Subpart C §15.247
- ♦ FCC KDB Publication No. 558074 D01 15.247 Meas Guidance v05r02
- ♦ FCC KDB 414788 D01 Radiated Test Site v01r01
- ♦ ANSI C63.10-2013

Remark:

1. All the test items were validated and recorded in accordance with the standards without any modification during the testing.
2. The TAF code is not including all the FCC KDB listed without accreditation.



2 Test Configuration of Equipment Under Test

2.1 Carrier Frequency Channel

Frequency Band	Channel	Freq. (MHz)	Channel	Freq. (MHz)	Channel	Freq. (MHz)
2404-2478 MHz	2	2404	32	2434	59	2461
	3	2405	33	2435	60	2462
	4	2406	34	2436	61	2463
	5	2407	35	2437	62	2464
	6	2408	36	2438	63	2465
	7	2409	37	2439	64	2466
	8	2410	38	2440	65	2467
	9	2411	39	2441	66	2468
	10	2412	40	2442	67	2469
	11	2413	41	2443	68	2470
	12	2414	42	2444	69	2471
	13	2415	43	2445	70	2472
	14	2416	44	2446	71	2473
	15	2417	45	2447	72	2474
	16	2418	46	2448	73	2475
	17	2419	47	2449	74	2476
	18	2420	48	2450	75	2477
	19	2421	49	2451	76	2478
	20	2422	50	2452	-	-
	21	2423	51	2453	-	-
	22	2424	52	2454	-	-
	26	2428	53	2455	-	-
	27	2429	54	2456	-	-
	28	2430	55	2457	-	-
	29	2431	56	2458	-	-
	30	2432	57	2459	-	-
	31	2433	58	2460	-	-



2.2 Test Mode

- a. The EUT has been associated with peripherals and configuration operated in a manner tended to maximize its emission characteristics in a typical application. Frequency range investigated: conduction emission (150 kHz to 30 MHz), radiation emission (9 kHz to the 10th harmonic of the highest fundamental frequency or to 40 GHz, whichever is lower). For radiated measurement, the measured emission level of the EUT was maximized by rotating the EUT on a turntable, adjusting the orientation of the EUT and EUT antenna in three orthogonal axis (X: flat, Y: portrait, Z: landscape) and accessory (Adapter or Earphone), and adjusting the measurement antenna orientation, following C63.10 exploratory test procedures and only the worst case emissions were reported in this report, and the worst mode of radiated spurious emissions is X plane with Adapter and recorded in this report.
- b. AC power line Conducted Emission was tested under maximum output power.

The following summary table is showing all test modes to demonstrate in compliance with the standard.

Summary table of Test Cases		
Test Item	Data Rate / Modulation	
Conducted Test Cases	Bluetooth LE 1Mbps CS ASK	Bluetooth LE 2Mbps CS ASK
	Mode 1: CH02_2404 MHz	Mode 4: CH02_2404 MHz
	Mode 2: CH38_2440 MHz	Mode 5: CH38_2440 MHz
	Mode 3: CH76_2478 MHz	Mode 6: CH76_2478 MHz
Radiated Test Cases	Bluetooth LE CS ASK	
	<Ant.3>	
	Mode 1: CH02_2404 MHz_1Mbps	
	Mode 2: CH38_2440 MHz_1Mbps	
	Mode 3: CH76_2478 MHz_1Mbps	
	Mode 4: CH02_2404 MHz_2Mbps	
	Mode 5: CH38_2440 MHz_2Mbps	
	Mode 6: CH76_2478 MHz_2Mbps	
	<Ant.4>	
	Mode 1: CH02_2404 MHz_1Mbps	
	Mode 2: CH38_2440 MHz_1Mbps	
	Mode 3: CH76_2478 MHz_1Mbps	
	Mode 4: CH02_2404 MHz_2Mbps	
	Mode 5: CH38_2440 MHz_2Mbps	
Mode 6: CH76_2478 MHz_2Mbps		

Summary table of Test Cases	
Test Item	Data Rate / Modulation
AC Conducted Emission	Mode 1 :Bluetooth-LE CS Link + USB cable 2 (Charging from AC Adapter)
Remark: 1. For Radiated Test Cases, the worst mode data rate 2Mbps was reported only since the highest RF output power in the preliminary tests. The conducted spurious emissions and conducted band edge measurement for other data rates were not worse than 2Mbps, and no other significantly frequencies found in conducted spurious emission. 2. For Radiated Test Cases, the tests were performed with USB Cable 2. 3. During the preliminary test, both charging modes (Adapter mode and WPT Charging mode) were verified. It is determined that the adaptor mode is the worst case for official test.	

2.3 Connection Diagram of Test System

<AC Conducted Emission Mode>

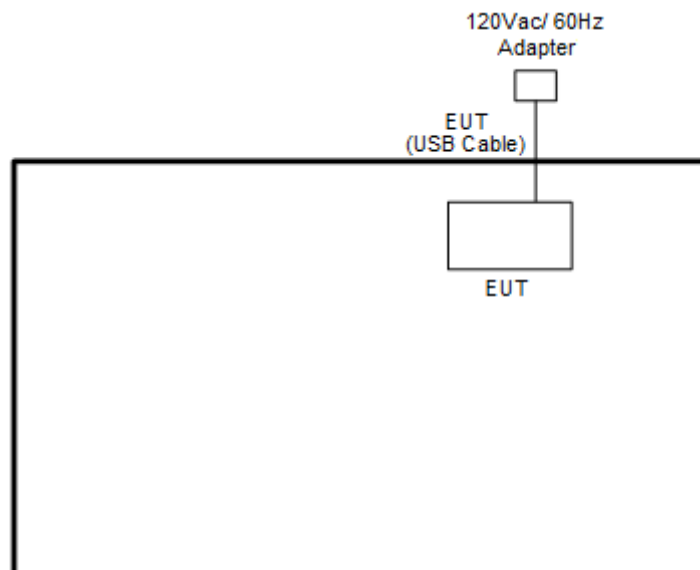

<Bluetooth-LE CS Tx Mode>

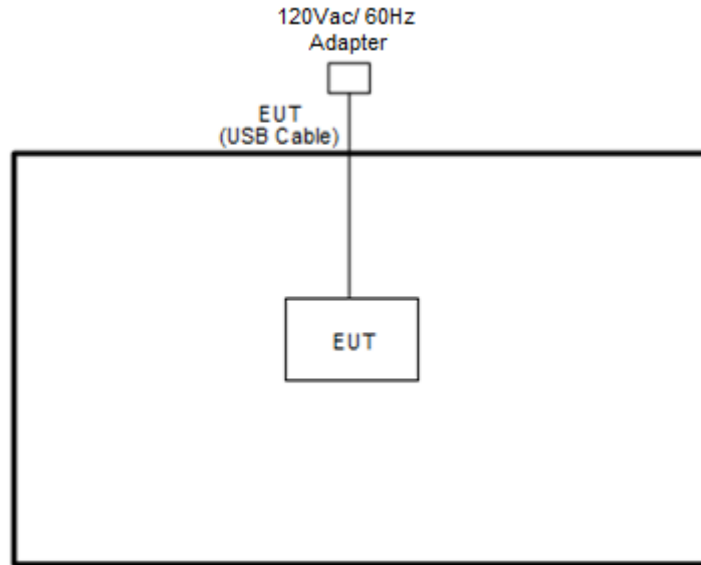

2.4 Support Unit used in test configuration and system

Item	Equipment	Brand Name	Model Name	FCC ID	Data Cable	Power Cord
1.	Notebook	DELL	Latitude 3400	FCC DoC	N/A	AC I/P: Unshielded, 1.2 m DC O/P: Shielded, 1.8 m
2.	AC Adapter	Aohai	G9BR1	N/A	N/A	N/A



2.5 EUT Operation Test Setup

The RF test items, utility “Broadcom HCI Test Tool(Ver1.4)” was installed in Notebook which was programmed in order to make the EUT get into the engineering modes to provide channel selection, power level, data rate and the application type and for continuous transmitting signals.

2.6 Measurement Results Explanation Example

For all conducted test items:

The offset level is set in the spectrum analyzer to compensate the RF cable loss and attenuator factor between EUT conducted output port and spectrum analyzer. With the offset compensation, the spectrum analyzer reading level is exactly the EUT RF output level.

Example:

The spectrum analyzer offset is derived from RF cable loss and attenuator factor.

Offset = RF cable loss + attenuator factor.

Following shows an offset computation example with cable loss 4.2 dB and 10 dB attenuator.

$$\begin{aligned} \text{Offset(dB)} &= \text{RF cable loss(dB)} + \text{attenuator factor(dB)}. \\ &= 4.2 + 10 = 14.2 \text{ (dB)} \end{aligned}$$

3 Test Result

3.1 Number of Channel Measurement

3.1.1 Limits of Number of Hopping Frequency

Frequency hopping systems in the 2400-2483.5 MHz band shall use at least 15 channels.

3.1.2 Measuring Instruments

Please refer to the measuring equipment list in this test report.

3.1.3 Test Procedure

1. The testing follows ANSI C63.10-2013 clause 7.8.3.
2. The RF output of EUT is connected to the spectrum analyzer by RF cable and attenuator. The path loss is compensated to the results for each measurement.
3. Set the maximum power setting and enable the EUT to transmit continuously.
4. Enable the EUT hopping function.
5. Use the following spectrum analyzer settings: Span = the frequency band of operation; RBW = 300 kHz; VBW \geq RBW; Sweep = auto; Detector function = peak; Trace = max hold.
6. The number of hopping frequency used is defined as the number of total channel.
7. Record the measurement data derived from spectrum analyzer.

3.1.4 Test Setup

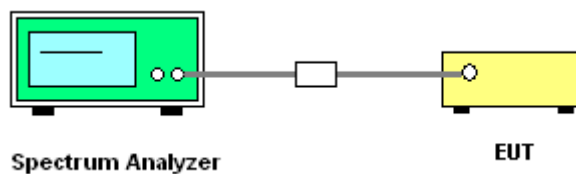

3.1.5 Test Result of Number of Hopping Frequency

Please refer to Appendix A.

3.2 Hopping Channel Separation Measurement

3.2.1 Limit of Hopping Channel Separation

Frequency hopping systems operating in the 2400-2483.5 MHz band may have hopping channel carrier frequencies that are separated by 25 kHz or two-thirds of the 20 dB bandwidth of the hopping channel, whichever is greater.

3.2.2 Measuring Instruments

Please refer to the measuring equipment list in this test report.

3.2.3 Test Procedures

1. The testing follows ANSI C63.10-2013 clause 7.8.2.
2. The RF output of EUT is connected to the spectrum analyzer by RF cable and attenuator. The path loss is compensated to the results for each measurement.
3. Set the maximum power setting and enable the EUT to transmit continuously.
4. Enable the EUT hopping function.
5. Use the following spectrum analyzer settings:
Span = wide enough to capture the peaks of two adjacent channels;
RBW = 300 kHz; VBW \geq RBW; Sweep = auto; Detector function = peak; Trace = max hold.
6. Measure and record the results in the test report.

3.2.4 Test Setup

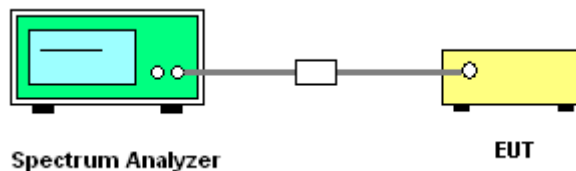

3.2.5 Test Result of Hopping Channel Separation

Please refer to Appendix A.

3.3 Dwell Time Measurement

3.3.1 Limit of Dwell Time

The average time of occupancy on any channel shall not be greater than 0.4 seconds within a period of 0.4 seconds multiplied by the number of hopping channels employed.

3.3.2 Measuring Instruments

Please refer to the measuring equipment list in this test report.

3.3.3 Test Procedures

1. The testing follows ANSI C63.10-2013 clause 7.8.4.
2. The RF output of EUT is connected to the spectrum analyzer by RF cable and attenuator. The path loss is compensated to the results for each measurement.
3. Set the maximum power setting and enable the EUT to transmit continuously.
4. Enable the EUT hopping function.
5. Use the following spectrum analyzer settings: Span = zero span, centered on a hopping channel; RBW = 1 MHz; VBW \geq RBW; Sweep = as necessary to capture the entire dwell time per hopping channel; Detector function = peak; Trace = max hold.
6. Measure and record the results in the test report.

3.3.4 Test Setup

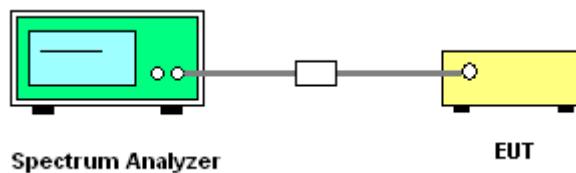

3.3.5 Test Result of Dwell Time

Please refer to Appendix A.

3.4 20dB and 99% Bandwidth Measurement

3.4.1 Limit of 20dB and 99% Bandwidth

Reporting only

3.4.2 Measuring Instruments

Please refer to the measuring equipment list in this test report.

3.4.3 Test Procedures

1. The testing follows ANSI C63.10-2013 clause 6.9.2 and 6.9.3.
2. The RF output of EUT is connected to the spectrum analyzer by RF cable and attenuator. The path loss is compensated to the results for each measurement.
3. Set the maximum power setting and enable the EUT to transmit continuously.
4. Use the following spectrum analyzer settings for 20 dB Bandwidth measurement.
Span = approximately 2 to 5 times the 20 dB bandwidth, centered on a hopping channel;
RBW \geq 1% of the 20 dB bandwidth; VBW \geq RBW; Sweep = auto; Detector function = peak;
Trace = max hold.
5. Use the following spectrum analyzer settings for 99 % Bandwidth measurement.
Span = approximately 1.5 to 5 times the 99% bandwidth, centered on a hopping channel;
RBW \geq 1-5% of the 99% bandwidth; VBW \geq 3 * RBW; Sweep = auto; Detector function = peak;
Trace = max hold.
6. Measure and record the results in the test report.

3.4.4 Test Setup



3.4.5 Test Result of 20dB Bandwidth

Please refer to Appendix A.

3.4.6 Test Result of 99% Occupied Bandwidth

Please refer to Appendix A.

3.5 Output Power Measurement

3.5.1 Limit of Output Power

The maximum peak conducted output power of the intentional radiator shall not exceed the following:
For frequency hopping systems operating in the 2400-2483.5 MHz band employing at least 75 non-overlapping hopping channels, and all frequency hopping systems in the 5725-5850 MHz band: 1 watt. For all other frequency hopping systems in the 2400-2483.5 MHz band 0.125 watts.
If directional gain of transmitting antennas is greater than 6 dBi, the power shall be reduced by the same level in dB comparing to gain minus 6 dBi.

3.5.2 Measuring Instruments

Please refer to the measuring equipment list in this test report.

3.5.3 Test Procedures

1. The testing follows ANSI C63.10-2013 clause 7.8.5.
2. The RF output of EUT is connected to the power meter by RF cable and attenuator. The path loss is compensated to the results for each measurement.
3. Set the maximum power setting and enable the EUT to transmit continuously.
4. Measure the conducted output power with cable loss and record the results in the test report.
5. The average power is compensated with duty factor.
6. Record the results in the test report.

3.5.4 Test Setup

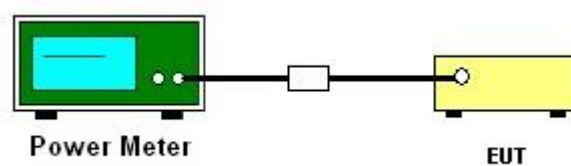

3.5.5 Test Result of Peak Output Power

Please refer to Appendix A.

3.5.6 Test Result of Average Output Power (Reporting Only)

Please refer to Appendix A.

3.6 Conducted Band Edges Measurement

3.6.1 Limit of Band Edges

In any 100 kHz bandwidth outside the intentional radiation frequency band, the radio frequency power shall be at least 20 dB below the highest level of the radiated power. In addition, radiated emissions which fall in the restricted bands must also comply with the radiated emission limits.

3.6.2 Measuring Instruments

Please refer to the measuring equipment list in this test report.

3.6.3 Test Procedures

1. The testing follows ANSI C63.10-2013 clause 7.8.6.
2. Set the maximum power setting and enable the EUT to transmit continuously.
3. Set RBW = 100 kHz, VBW = 300 kHz. Band edge emissions must be at least 20 dB down from the highest emission level within the authorized band as measured with a 100 kHz RBW. The attenuation shall be 30 dB instead of 20 dB when RMS conducted output power procedure is used.
4. Enable hopping function of the EUT and then repeat step 2 and 3.
5. Measure and record the results in the test report.

3.6.4 Test Setup



3.6.5 Test Result of Conducted Band Edges

Please refer to Appendix A.

3.6.6 Test Result of Conducted Hopping Mode Band Edges

Please refer to Appendix A.

3.7 Conducted Spurious Emission Measurement

3.7.1 Limit of Spurious Emission Measurement

In any 100 kHz bandwidth outside the intentional radiation frequency band, the radio frequency power shall be at least 20 dB below the highest level of the radiated power. In addition, radiated emissions which fall in the restricted bands must also comply with the radiated emission limits.

3.7.2 Measuring Instruments

Please refer to the measuring equipment list in this test report.

3.7.3 Test Procedure

1. The testing follows ANSI C63.10-2013 clause 7.8.8.
2. The RF output of EUT is connected to the spectrum analyzer by RF cable and attenuator. The path loss is compensated to the results for each measurement.
3. Set the maximum power setting and enable the EUT to transmit continuously.
4. Set RBW = 100 kHz, VBW = 300 kHz, scan up through 10th harmonic. All harmonics / spurious must be at least 20 dB down from the highest emission level within the authorized band as measured with a 100 kHz RBW.
5. Measure and record the results in the test report.
6. The RF fundamental frequency should be excluded against the limit line in the operating frequency band.

3.7.4 Test Setup



3.7.5 Test Result of Conducted Spurious Emission

Please refer to Appendix A.



3.8 Radiated Band Edges and Spurious Emission Measurement

3.8.1 Limit of Radiated Band Edges and Spurious Emission

In any 100 kHz bandwidth outside the intentional radiator frequency band, all harmonics / spurious must be at least 20 dB below the highest emission level within the authorized band. In addition, radiated emissions which fall in the restricted bands must also comply with the limits as below.

Frequency (MHz)	Field Strength (microvolts/meter)	Measurement Distance (meters)
0.009 – 0.490	2400/F(kHz)	300
0.490 – 1.705	24000/F(kHz)	30
1.705 – 30.0	30	30
30 – 88	100	3
88 – 216	150	3
216 - 960	200	3
Above 960	500	3

3.8.2 Measuring Instruments

Please refer to the measuring equipment list in this test report.

**3.8.3 Test Procedures**

1. The EUT is placed on a turntable with 0.8 meter for frequency below 1 GHz and 1.5 meter for frequency above 1 GHz respectively above ground.
2. The EUT is set 3 meters away from the receiving antenna, which is mounted on the top of a variable height antenna tower.
3. For each suspected emission, the EUT is arranged to its worst case and then tune the Antenna tower (from 1 m to 4 m) and turntable (from 0 degree to 360 degrees) to find the maximum reading. A pre-amp and a high pass filter are used for the test in order to get better signal level to comply with the guidelines.
4. Set the maximum power setting and enable the EUT to transmit continuously.
5. Use the following spectrum analyzer settings:
 - (1) Span shall wide enough to fully capture the emission being measured;
 - (2) Set RBW = 100 kHz for $f < 1$ GHz, RBW = 1 MHz for $f > 1$ GHz ; VBW \geq RBW; Sweep = auto; Detector function = peak; Trace = max hold for peak
 - (3) For average measurement: Set RBW = 100 kHz for $f < 1$ GHz, RBW = 1 MHz for $f > 1$ GHz ; VBW \geq 10Hz; Sweep = auto; Detector function = peak; Trace = max hold for average
6. Corrected Reading: Antenna Factor + Cable Loss + Read Level - Preamp Factor = Level
7. Radiated testing below 1 GHz is performed by adjusting the antenna tower from 1 m to 4 m and by rotating the turn table from 0 degree to 360 degrees to find the peak maximum hold reading. When there is no suspected emission found and the emission level is with at least 6 dB margin against QP limit line, the position is marked as “-“.
8. Radiated testing above 1 GHz is performed by adjusting the antenna tower from 1 m to 4 m and by rotating the turn table from 0 degree to 360 degrees to find the peak maximum hold reading for scanning all frequencies. When there is no suspected emission found and the harmonic emission level is with at least 6 dB margin against average limit line, the position is marked as “-“.

3.8.4 Test Setup

For radiated test below 30MHz

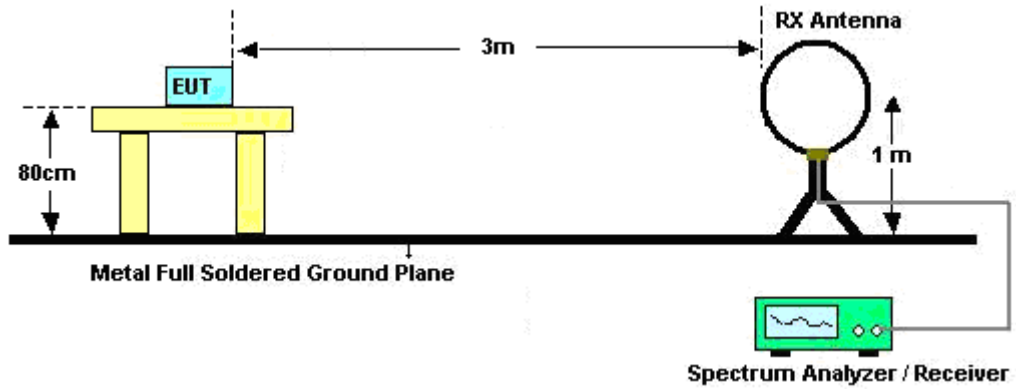

For radiated test from 30MHz to 1GHz

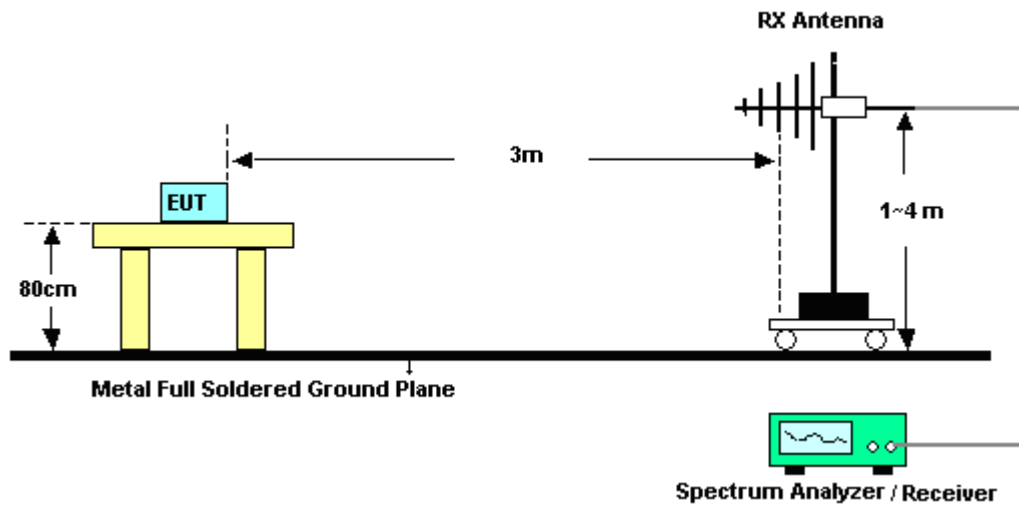

For radiated test from 1GHz to 18GHz

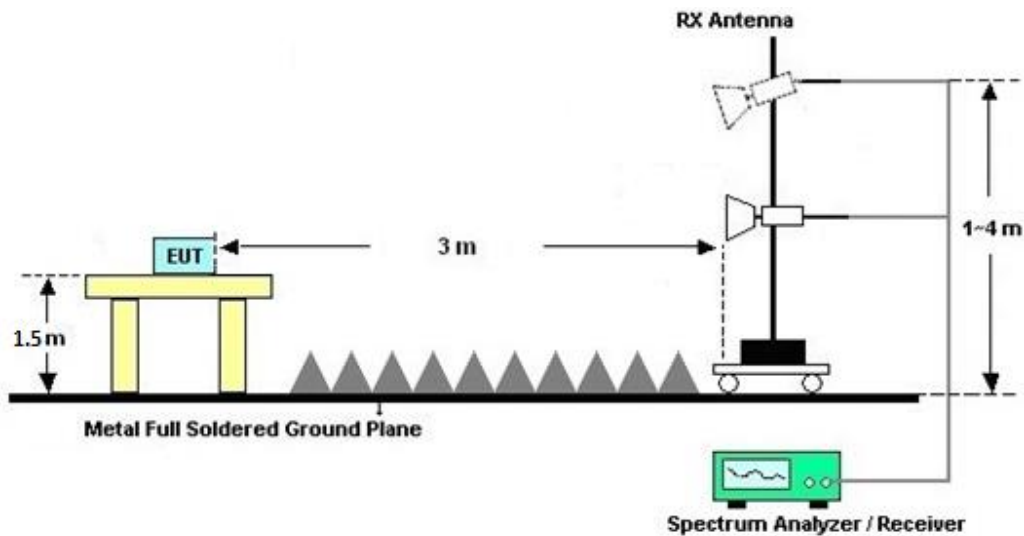

For radiated test above 18GHz

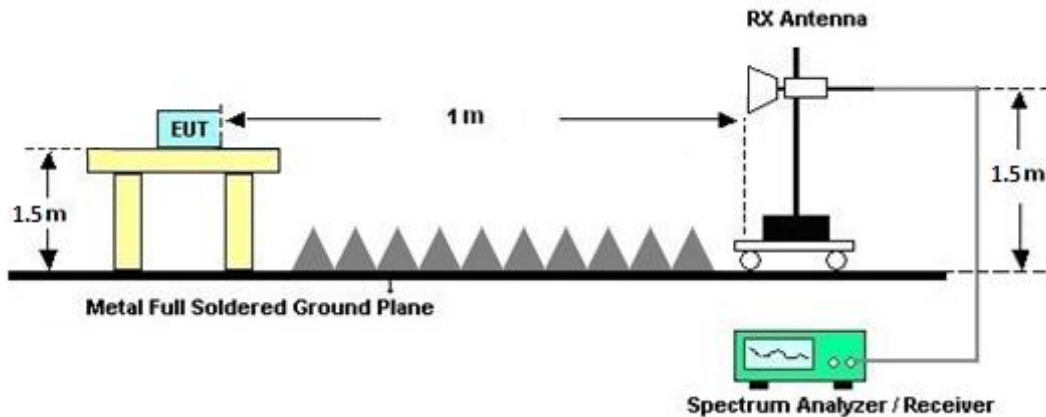

3.8.5 Test Results of Radiated Spurious Emissions (9 kHz ~ 30 MHz)

The low frequency, which starts from 9 kHz to 30 MHz, is pre-scanned and the result which is 20 dB lower than the limit line is not reported.

There is adequate comparison measurement of both open-field test site and alternative test site - semi-Anechoic chamber according to 414788 D01 Radiated Test Site v01r01, and the result comes out very similar.

3.8.6 Test Result of Radiated Spurious at Band Edges

Please refer to Appendix C and D.

3.8.7 Duty Cycle

Please refer to Appendix E.

3.8.8 Test Result of Radiated Spurious Emission (30MHz ~ 10th Harmonic)

Please refer to Appendix C and D.



3.9 AC Conducted Emission Measurement

3.9.1 Limit of AC Conducted Emission

For equipment that is designed to be connected to the public utility (AC) power line, the radio frequency voltage that is conducted back onto the AC power line on any frequency or frequencies within the band 150 kHz to 30 MHz shall not exceed the limits in the following table.

Frequency of emission (MHz)	Conducted limit (dBµV)	
	Quasi-peak	Average
0.15-0.5	66 to 56*	56 to 46*
0.5-5	56	46
5-30	60	50

*Decreases with the logarithm of the frequency.

3.9.2 Measuring Instruments

Please refer to the measuring equipment list in this test report.

3.9.3 Test Procedures

1. The EUT is placed 0.4 meter away from the conducting wall of the shielding room, and is kept at least 80 centimeters from any other grounded conducting surface.
2. Connect EUT to the power mains through a line impedance stabilization network (LISN).
3. All the support units are connecting to the other LISN.
4. The LISN provides 50 ohm coupling impedance for the measuring instrument.
5. The FCC states that a 50 ohm, 50 microhenry LISN shall be used.
6. Both Line and Neutral shall be tested in order to find out the maximum conducted emission.
7. The frequency range from 150 kHz to 30 MHz is scanned.
8. Set the test-receiver system to Peak Detect Function and specified bandwidth (IF Bandwidth = 9 kHz) with Maximum Hold Mode. Then measurement is also conducted by Average Detector and Quasi-Peak Detector Function respectively.

3.9.4 Test Setup

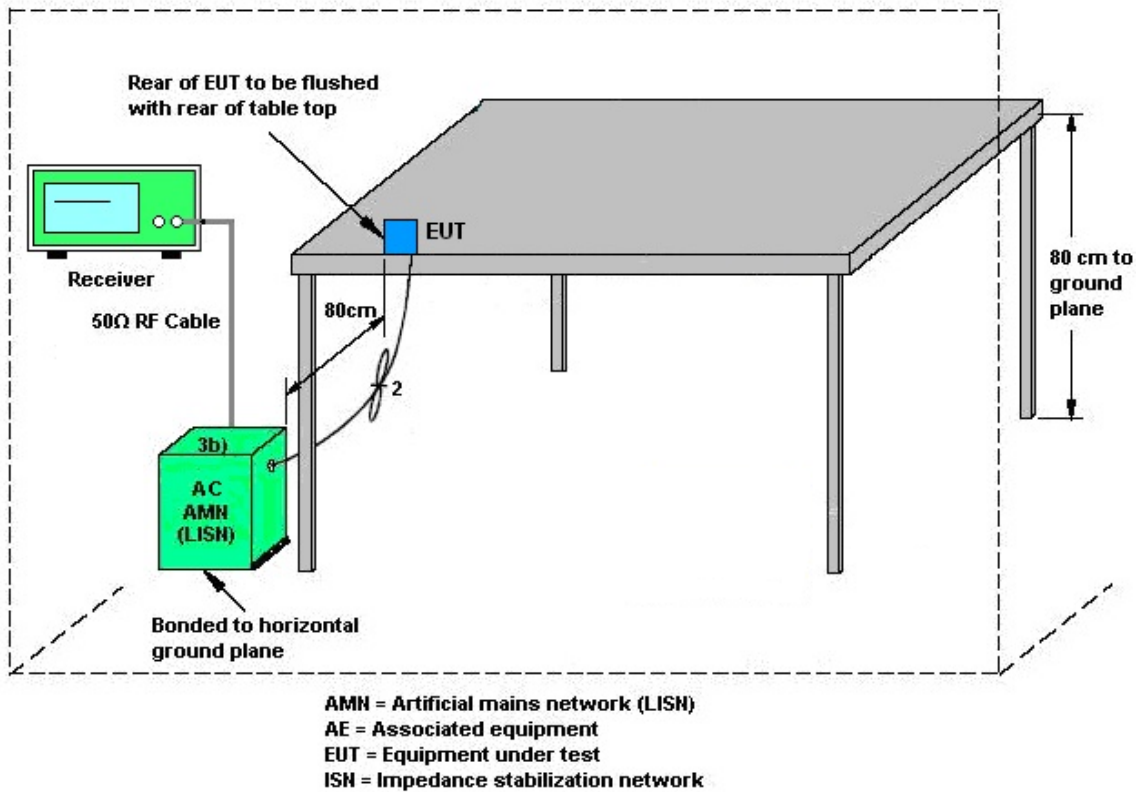

3.9.5 Test Result of AC Conducted Emission

Please refer to Appendix B.



3.10 Antenna Requirements

3.10.1 Standard Applicable

The use of a permanently attached antenna or of an antenna that uses a unique coupling to the intentional radiator shall be considered sufficient to comply with the rule.

3.10.2 Antenna Anti-Replacement Construction

An embedded-in antenna design is used.



4 List of Measuring Equipment

Instrument	Brand Name	Model No.	Serial No.	Characteristics	Calibration Date	Test Date	Due Date	Remark
Loop Antenna	Rohde & Schwarz	HFH2-Z2	100488	9kHz~30MHz	Sep. 12, 2023	Jan. 11, 2024~ May 04, 2024	Sep. 11, 2024	Radiation (03CH15-HY)
Bilog Antenna	TESEQ	CBL 6111D & 00800N1D01N- 06	47020 & 06	30MHz~1GHz	Oct. 07, 2023	Jan. 11, 2024~ Feb. 03, 2024	Oct. 06, 2024	Radiation (03CH15-HY)
Bilog Antenna	TESEQ	CBL 6111D & 00800N1D01N- 06	41912 & 05	30MHz~1GHz	Feb. 04, 2024	Feb. 04, 2024~ May 04, 2024	Feb. 03, 2025	Radiation (03CH15-HY)
Horn Antenna	SCHWARZBE CK	BBHA 9120 D	9120D-02294	1GHz~18GHz	Jun. 30, 2023	Jan. 11, 2024~ May 04, 2024	Jun. 29, 2024	Radiation (03CH15-HY)
SHF-EHF Horn Antenna	SCHWARZBE CK	BBHA 9170	1225	18GHz~40GHz	Jul. 10, 2023	Jan. 11, 2024~ May 04, 2024	Jul. 09, 2024	Radiation (03CH15-HY)
Amplifier	SONOMA	310N	363440	9kHz~1GHz	Dec. 26, 2023	Jan. 11, 2024~ May 04, 2024	Dec. 25, 2024	Radiation (03CH15-HY)
Preamplifier	EMEC	EM01G18G	060812	1GHz~18GHz	Dec. 25, 2023	Jan. 11, 2024~ Feb. 14, 2024	Dec. 24, 2024	Radiation (03CH15-HY)
Preamplifier	EMEC	EM01G18G	060837	1GHz~18GHz	Feb. 15, 2024	Feb. 15, 2024~ May 04, 2024	Feb. 14, 2025	Radiation (03CH15-HY)
Preamplifier	Keysight	83017A	MY53270264	1GHz~26.5GHz	Dec. 07, 2023	Jan. 11, 2024~ May 04, 2024	Dec. 06, 2024	Radiation (03CH15-HY)
Preamplifier	EM Electronics	EM01G18G	060802	1GHz~18GHz	Mar. 03, 2023	Jan. 11, 2024~ Feb. 28, 2024	Mar. 02, 2024	Radiation (03CH15-HY)
Preamplifier	EM Electronics	EM01G18G	060802	1GHz~18GHz	Feb. 29, 2024	Feb. 29, 2024~ May 04, 2024	Feb. 28, 2025	Radiation (03CH15-HY)
Preamplifier	EMEC	EM18G40G	060801	18GHz~40GHz	Jun. 27, 2023	Jan. 11, 2024~ May 04, 2024	Jun. 26, 2024	Radiation (03CH15-HY)
EMI Test Receiver	Keysight	N9038A(MXE)	MY53290045	20MHz~8.4GHz	Oct. 06, 2023	Jan. 11, 2024~ May 04, 2024	Oct. 05, 2024	Radiation (03CH15-HY)
Spectrum Analyzer	Keysight	N9010B	MY60241058	10Hz~44GHz	Jul. 06, 2023	Jan. 11, 2024~ May 04, 2024	Jul. 05, 2024	Radiation (03CH15-HY)
Antenna Mast	ChainTek	MBS-520-1	N/A	1m~4m	N/A	Jan. 11, 2024~ May 04, 2024	N/A	Radiation (03CH15-HY)
Turn Table	ChainTek	T-200-S-1	N/A	0~360 Degree	N/A	Jan. 11, 2024~ May 04, 2024	N/A	Radiation (03CH15-HY)
Software	Audix	E3 6.2009-8-24(k5)	RK-000451	N/A	N/A	Jan. 11, 2024~ May 04, 2024	N/A	Radiation (03CH15-HY)
RF Cable	HUBER + SUHNER	SUCOFLEX 104, 102E	MY582185/4,5 19228/2,80395 0/2	N/A	Jun. 13, 2023	Jan. 11, 2024~ May 04, 2024	Jun. 12, 2024	Radiation (03CH15-HY)
RF Cable	HUBER + SUHNER	SUCOFLEX 102	804011/2,8040 12/2	18-40G	Jan. 02, 2024	Jan. 11, 2024~ May 04, 2024	Jan. 01, 2025	Radiation (03CH15-HY)
Filter	Wainwright	WLJ4-1000-153 0-6000-40ST	SN4	1.53GHz Low Pass Filter	Jun. 14, 2023	Jan. 11, 2024~ May 04, 2024	Jun. 13, 2024	Radiation (03CH15-HY)
Filter	Wainwright	WHKX12-2700- 3000-18000-60 ST	SN4	3GHz High Pass Filter	Jun. 14, 2023	Jan. 11, 2024~ May 04, 2024	Jun. 13, 2024	Radiation (03CH15-HY)
Hygrometer	TECPEL	DTM-302	SN4	N/A	Jul. 26, 2023	Jan. 11, 2024~ May 04, 2024	Jul. 25, 2024	Radiation (03CH15-HY)



Instrument	Brand Name	Model No.	Serial No.	Characteristics	Calibration Date	Test Date	Due Date	Remark
Hygrometer	TECPEL	DTM-303A	TP201996	N/A	Nov. 07, 2023	Feb. 26, 2024~ May 03, 2024	Nov. 06, 2024	Conducted (TH05-HY)
Power Meter	Anritsu	ML2495A	1036004	N/A	Jul. 27, 2023	Feb. 26, 2024~ May 03, 2024	Jul. 26, 2024	Conducted (TH05-HY)
Power Sensor	Anritsu	MA2411B	1027253	300MHz~40GHz	Jul. 27, 2023	Feb. 26, 2024~ May 03, 2024	Jul. 26, 2024	Conducted (TH05-HY)
Signal Analyzer	Rohde & Schwarz	FSV3044	101466	10HZ~44GHZ	Jan. 24, 2024	Feb. 26, 2024~ May 03, 2024	Jan. 23, 2025	Conducted (TH05-HY)
AC Power Source	ACPOWER	AFC-11003G	F317040033	N/A	N/A	Mar. 23, 2024	N/A	Conduction (CO07-HY)
Software	Rohde & Schwarz	EMC32 V10.30	N/A	N/A	N/A	Mar. 23, 2024	N/A	Conduction (CO07-HY)
Pulse Limiter	SCHWARZBECK	VTSD 9561-F N	9561-F N00373	9kHz-200MHz	Oct. 20, 2023	Mar. 23, 2024	Oct. 19, 2024	Conduction (CO07-HY)
RF Cable	HUBER + SUHNER	RG 214/U	1358175	9kHz~30MHz	Mar. 14, 2024	Mar. 23, 2024	Mar. 13, 2025	Conduction (CO07-HY)
Two-Line V-Network	TESEQ	NNB 51	45051	N/A	Mar. 10, 2024	Mar. 23, 2024	Mar. 09, 2025	Conduction (CO07-HY)
Four-Line V-Network	TESEQ	NNB 52	36122	N/A	Mar. 07, 2024	Mar. 23, 2024	Mar. 06, 2025	Conduction (CO07-HY)
EMI Test Receiver	Rohde & Schwarz	ESR3	102317	9kHz~3.6GHz	Sep. 20, 2023	Mar. 23, 2024	Sep. 19, 2024	Conduction (CO07-HY)



5 Measurement Uncertainty

Uncertainty of Conducted Emission Measurement (150 kHz ~ 30 MHz)

Measuring Uncertainty for a Level of Confidence of 95% ($U = 2Uc(y)$)	3.44 dB
---	---------

Uncertainty of Radiated Emission Measurement (30 MHz ~ 1000 MHz)

Measuring Uncertainty for a Level of Confidence of 95% ($U = 2Uc(y)$)	6.30 dB
---	---------

Uncertainty of Radiated Emission Measurement (1000 MHz ~ 6000 MHz)

Measuring Uncertainty for a Level of Confidence of 95% ($U = 2Uc(y)$)	4.50 dB
---	---------

Uncertainty of Radiated Emission Measurement (6000 MHz ~ 18000 MHz)

Measuring Uncertainty for a Level of Confidence of 95% ($U = 2Uc(y)$)	5.50 dB
---	---------

Uncertainty of Radiated Emission Measurement (18000 MHz ~ 40000 MHz)

Measuring Uncertainty for a Level of Confidence of 95% ($U = 2Uc(y)$)	5.40 dB
---	---------

Appendix A. Test Result of Conducted Test Items

Test Engineer:	Derek Hsu	Temperature:	21~25	°C
Test Date:	2024/02/26 ~ 2024/05/03	Relative Humidity:	51~54	%

<Ant. 3>

TEST RESULTS DATA									
20dB and 99% Occupied Bandwidth and Hopping Channel Separation									
Mod.	Data Rate	NTX	CH.	Freq. (MHz)	20dB BW (MHz)	99% Bandwidth (MHz)	Hopping Channel Separation Measurement (MHz)	Hopping Channel Separation Limit (MHz)	Pass/Fail
ASK	1Mbps	1	02	2404	0.125	0.273	1.012	0.0835	Pass
ASK	1Mbps	1	38	2440	0.125	0.270	1.007	0.0836	Pass
ASK	1Mbps	1	76	2478	0.126	0.270	1.003	0.0837	Pass
ASK	2Mbps	1	02	2404	0.123	0.261	1.007	0.0817	Pass
ASK	2Mbps	1	38	2440	0.123	0.261	1.016	0.0817	Pass
ASK	2Mbps	1	76	2478	0.122	0.261	0.994	0.0816	Pass

TEST RESULTS DATA						
Dwell Time						
Mod.	Hopping Channel Number Rate	Hops Over Occupancy Time (hops)	Package Transfer Time (msec)	Dwell Time (sec)	Limits (sec)	Pass/Fail
ASK	72	1750	0.044	0.077	0.400	Pass

TEST RESULTS DATA					
Peak Power Table					
DH	CH.	NTX	Peak Power (dBm)	Power Limit (dBm)	Test Result
ASK 1Mbps	02	1	20.05	20.97	Pass
	38	1	19.89	20.97	Pass
	76	1	20.19	20.97	Pass
ASK 2Mbps	02	1	20.10	20.97	Pass
	38	1	19.93	20.97	Pass
	76	1	20.20	20.97	Pass

TEST RESULTS DATA				
Average Power Table				
(Reporting Only)				
DH	CH.	NTX	Average Power (dBm)	Duty Factor (dB)
ASK 1Mbps	02	1	19.80	8.01
	38	1	19.66	8.01
	76	1	19.93	8.01
ASK 2Mbps	02	1	19.92	8.01
	38	1	19.67	8.01
	76	1	19.98	8.01

TEST RESULTS DATA			
Number of Hopping Frequency			
Number of Hopping (Channel)	Adaptive Frequency Hopping (Channel)	Limits (Channel)	Pass/Fail
72	20	> 15	Pass

<Ant. 4>

TEST RESULTS DATA**20dB and 99% Occupied Bandwidth and Hopping Channel Separation**

Mod.	Data Rate	NTX	CH.	Freq. (MHz)	20dB BW (MHz)	99% Bandwidth (MHz)	Hopping Channel Separation Measurement (MHz)	Hopping Channel Separation Measurement Limit (MHz)	Pass/Fail
ASK	1Mbps	1	02	2404	0.125	0.269	1.016	0.0836	Pass
ASK	1Mbps	1	38	2440	0.125	0.269	1.003	0.0836	Pass
ASK	1Mbps	1	76	2478	0.125	0.270	0.994	0.0835	Pass
ASK	2Mbps	1	02	2404	0.123	0.264	1.007	0.0817	Pass
ASK	2Mbps	1	38	2440	0.123	0.263	1.007	0.0817	Pass
ASK	2Mbps	1	76	2478	0.123	0.263	1.003	0.0817	Pass

TEST RESULTS DATA**Dwell Time**

Mod.	Hopping Channel Number Rate	Hops Over Occupancy Time (hops)	Package Transfer Time (msec)	Dwell Time (sec)	Limits (sec)	Pass/Fail
ASK	72	1742	0.044	0.077	0.400	Pass

TEST RESULTS DATA**Peak Power Table**

DH	CH.	NTX	Peak Power (dBm)	Power Limit (dBm)	Test Result
ASK 1Mbps	02	1	20.46	20.97	Pass
	38	1	20.18	20.97	Pass
	76	1	20.28	20.97	Pass
ASK 2Mbps	02	1	20.50	20.97	Pass
	38	1	20.20	20.97	Pass
	76	1	20.30	20.97	Pass

TEST RESULTS DATA**Average Power Table****(Reporting Only)**

DH	CH.	NTX	Average Power (dBm)	Duty Factor (dB)
ASK 1Mbps	02	1	19.98	8.01
	38	1	19.85	8.01
	76	1	19.93	8.01
ASK 2Mbps	02	1	19.99	8.01
	38	1	19.91	8.01
	76	1	19.96	8.01

TEST RESULTS DATA**Number of Hopping Frequency**

Number of Hopping (Channel)	Adaptive Frequency Hopping (Channel)	Limits (Channel)	Pass/Fail
72	20	> 15	Pass



<Ant.3>

Number of Hopping Frequency

<1Mbps>

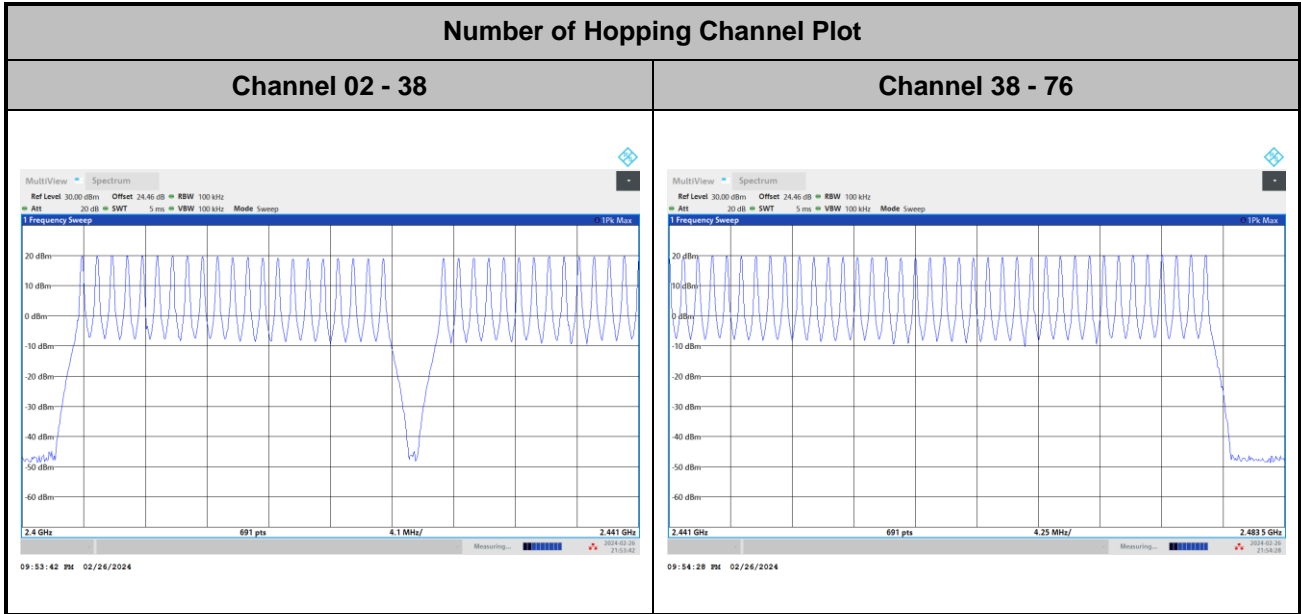

<2Mbps>

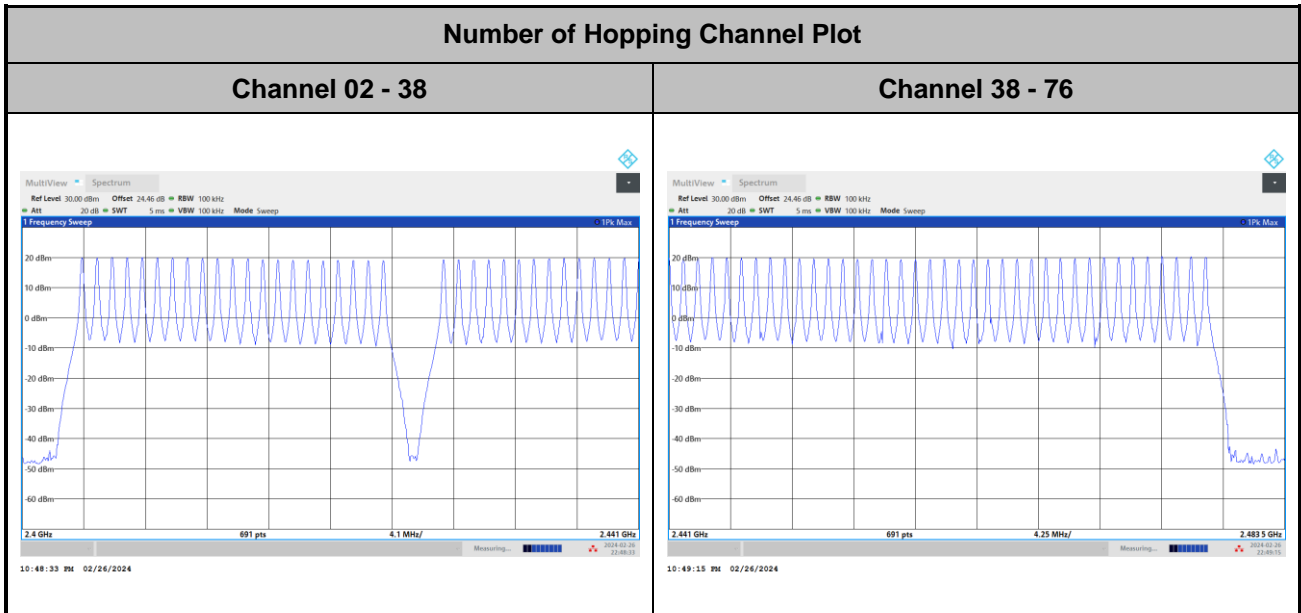



Hopping Channel Separation

<1Mbps>

Channel Separation Plot on Channel 02 - 03

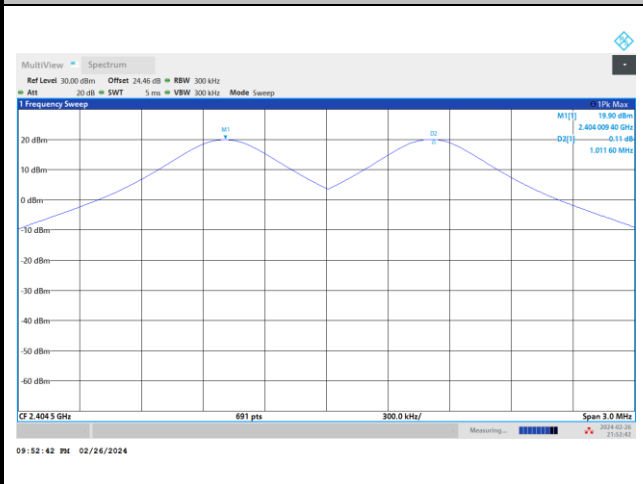

Channel Separation Plot on Channel 38 - 39

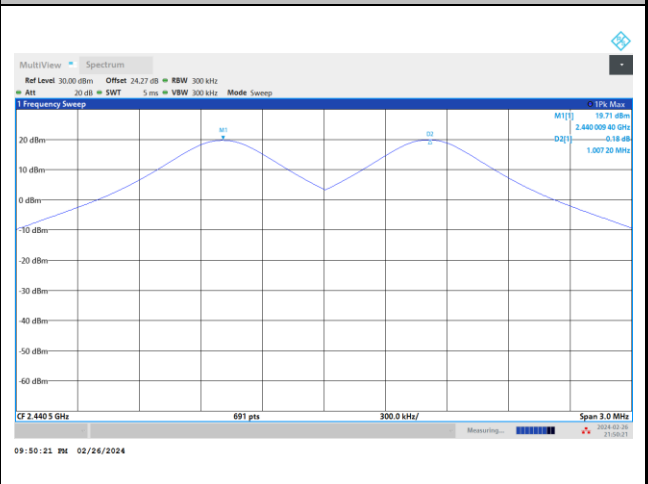

Channel Separation Plot on Channel 75 - 76

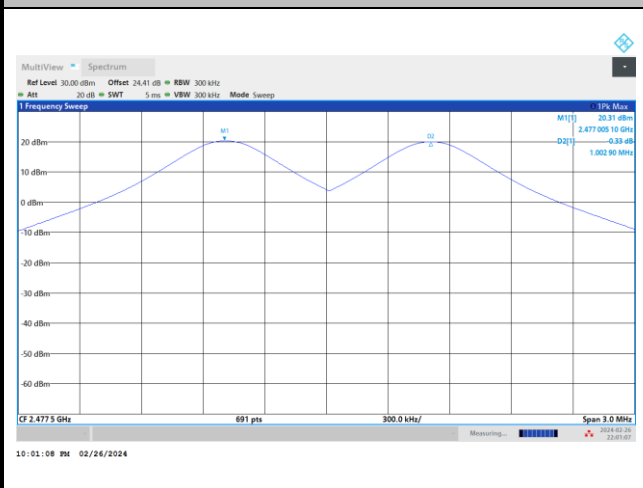



<2Mbps>

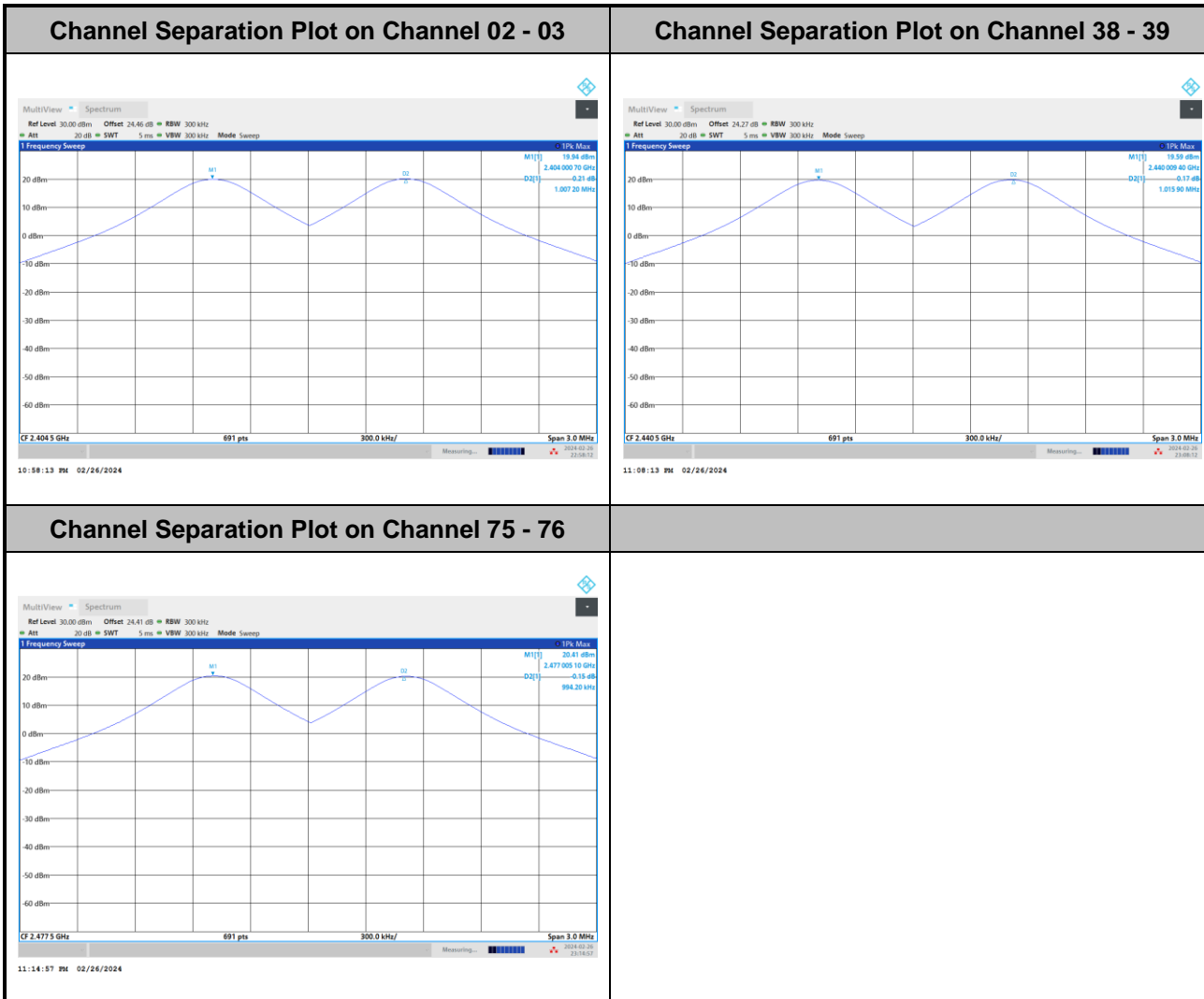



Dwell Time

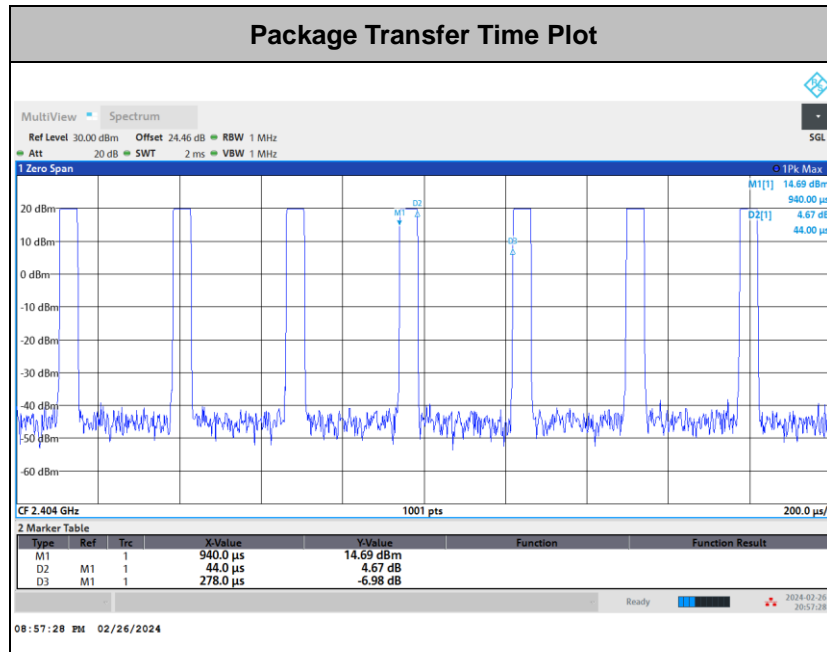

Remark:

1. Dwell Time(s) = Hops Over Occupancy Time (hops) x Package Transfer Time
2. The observation Occupancy time is hopping channel 72 channels x 400ms = 28.8sec using sweep point 30,000. This shows that 1ms per on-time contains 1 hop. The total hops is finally counted via computer analysis.

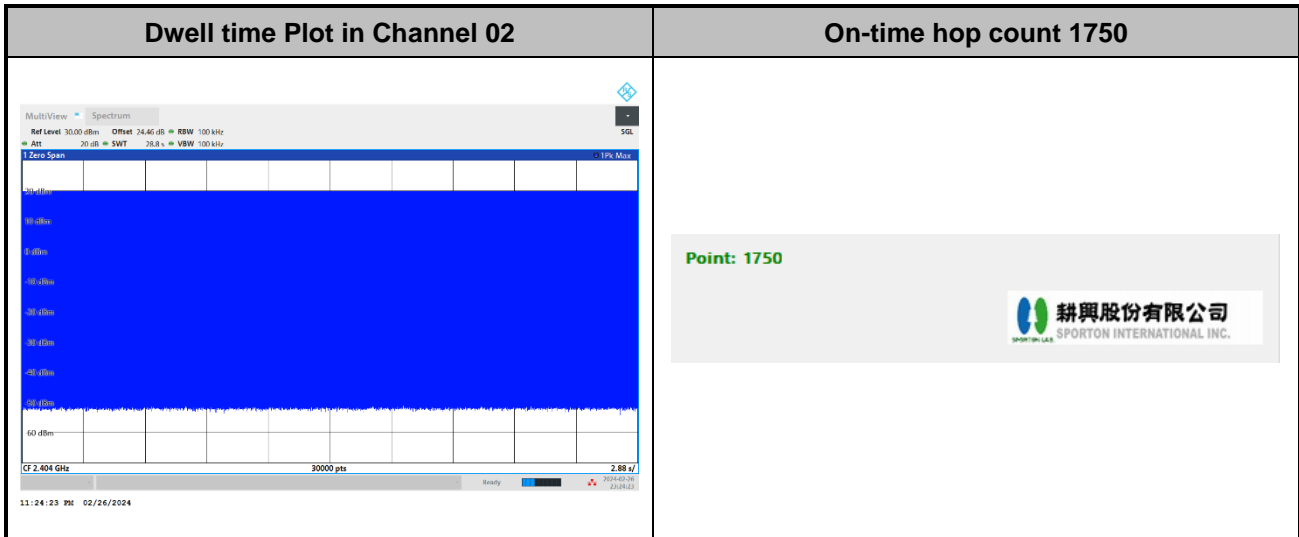



20dB Bandwidth

<1Mbps>

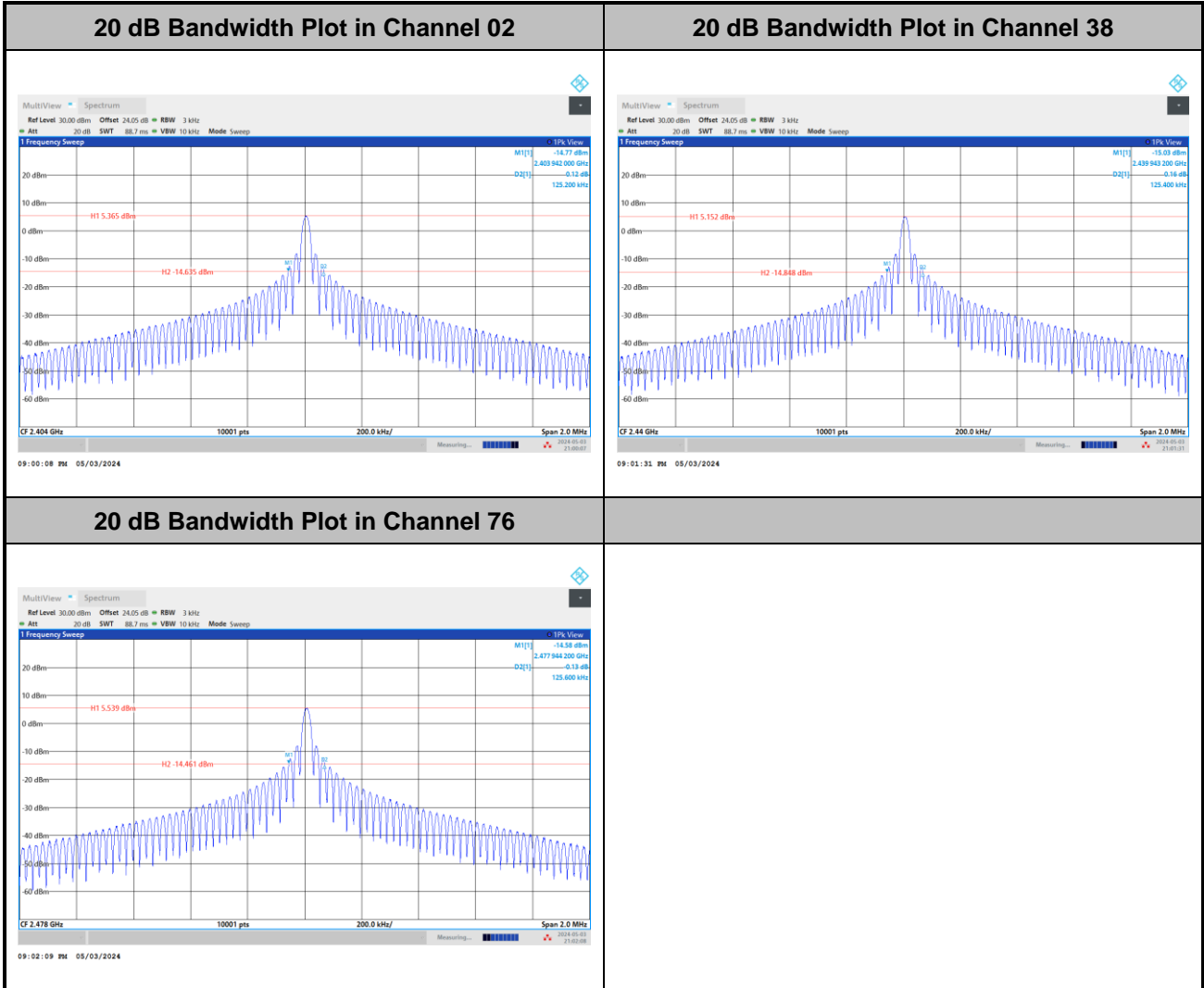



<2Mbps>

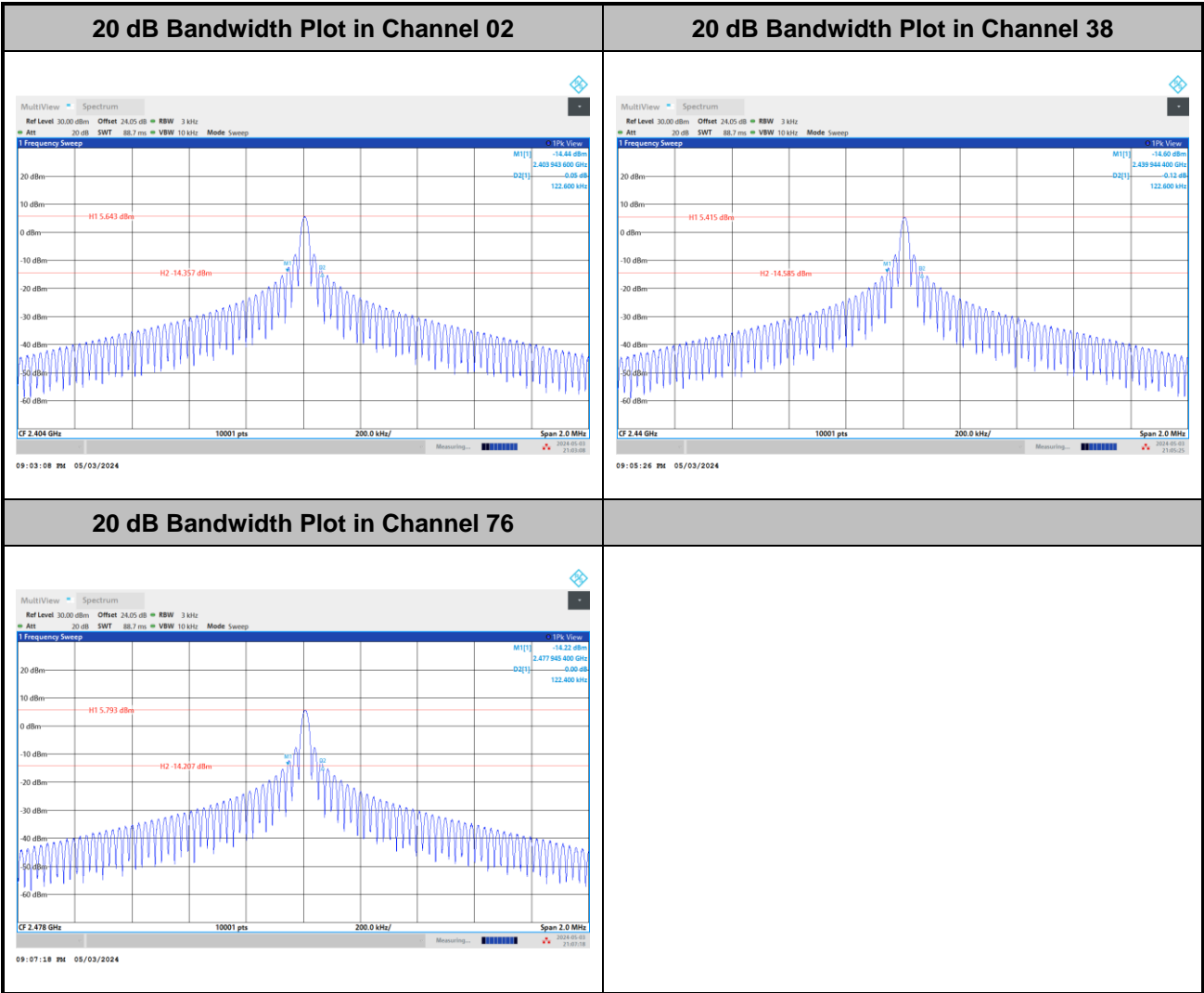



99% Occupied Bandwidth

<1Mbps>

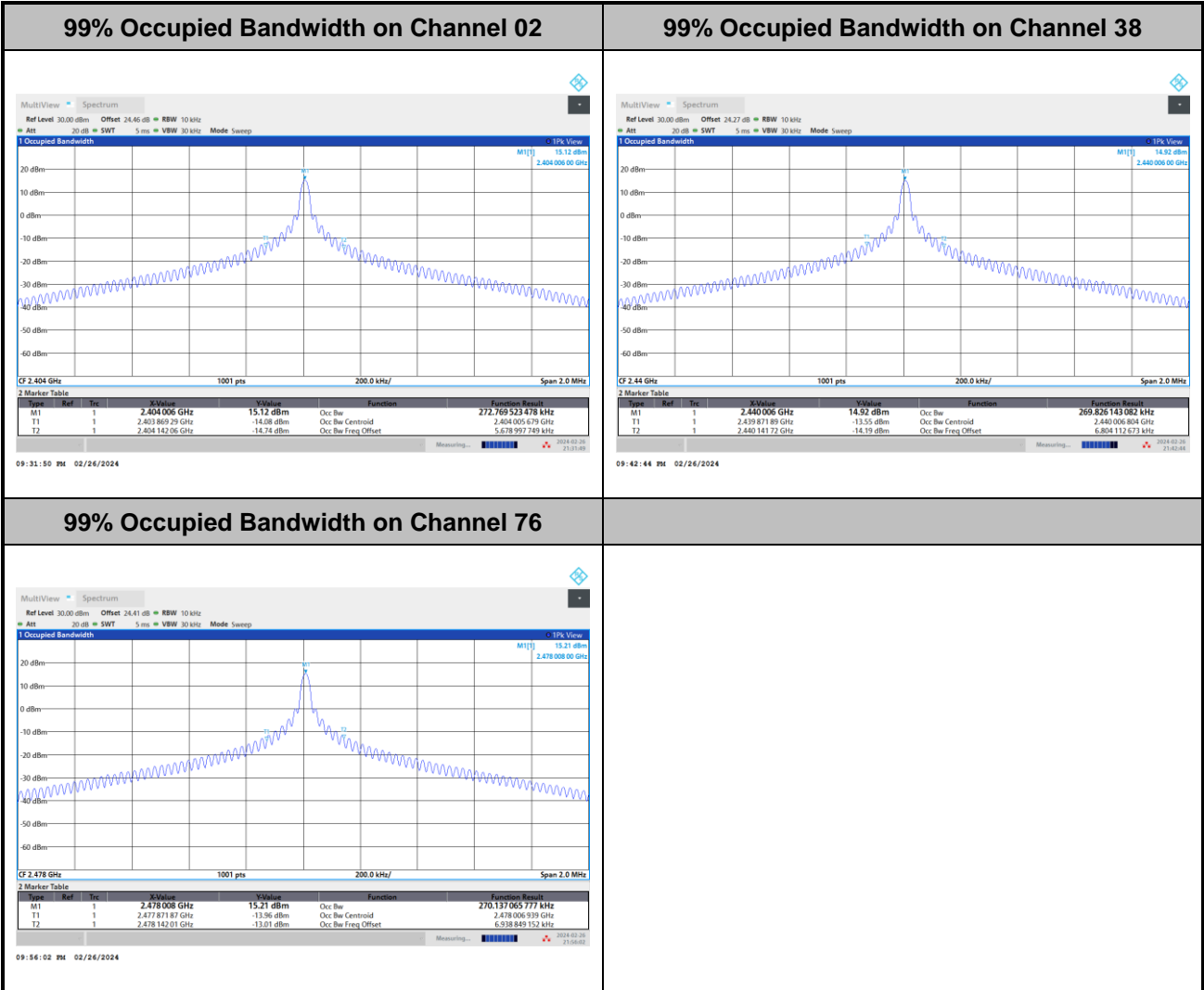



<2Mbps>

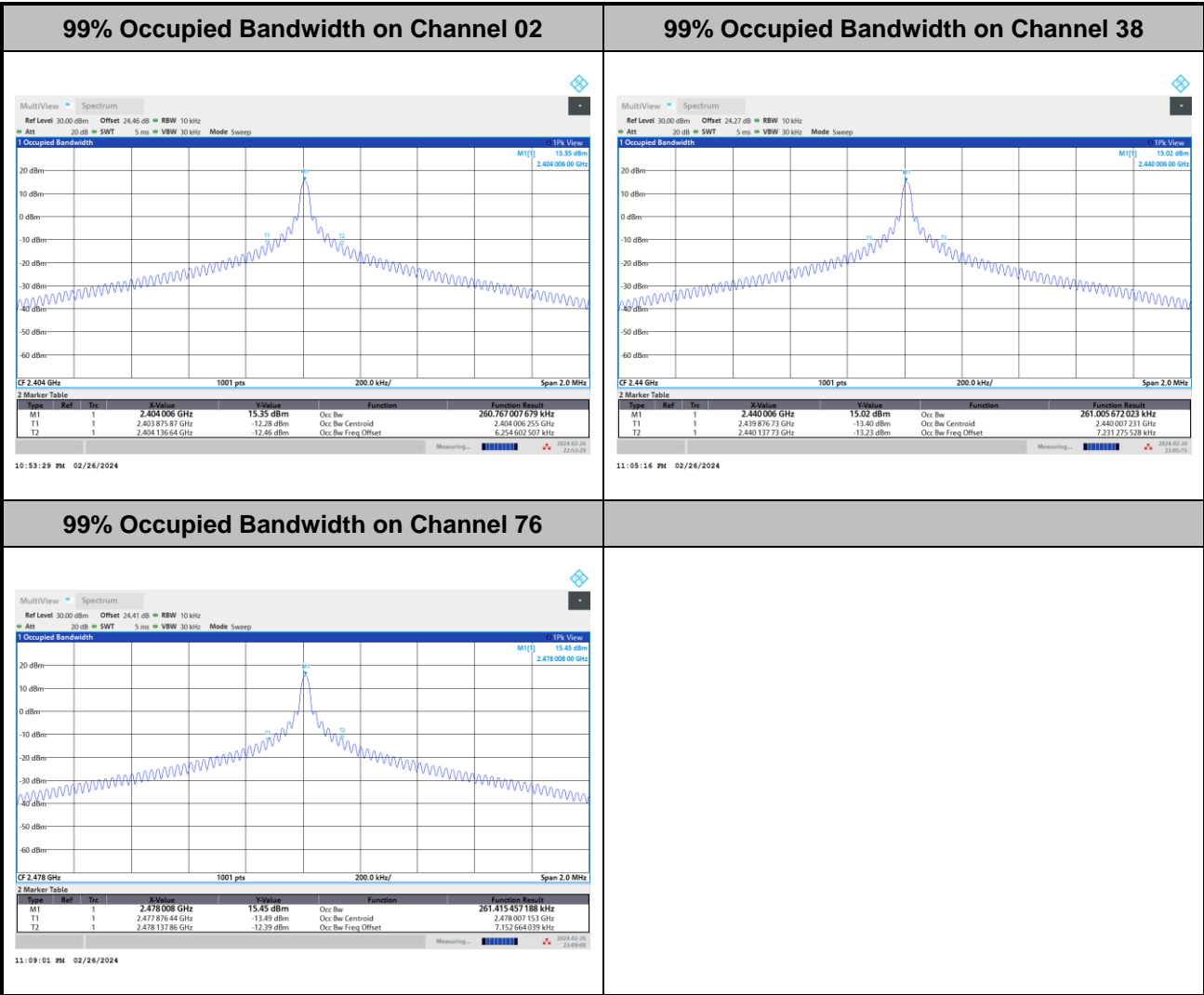



Band Edges

<1Mbps>

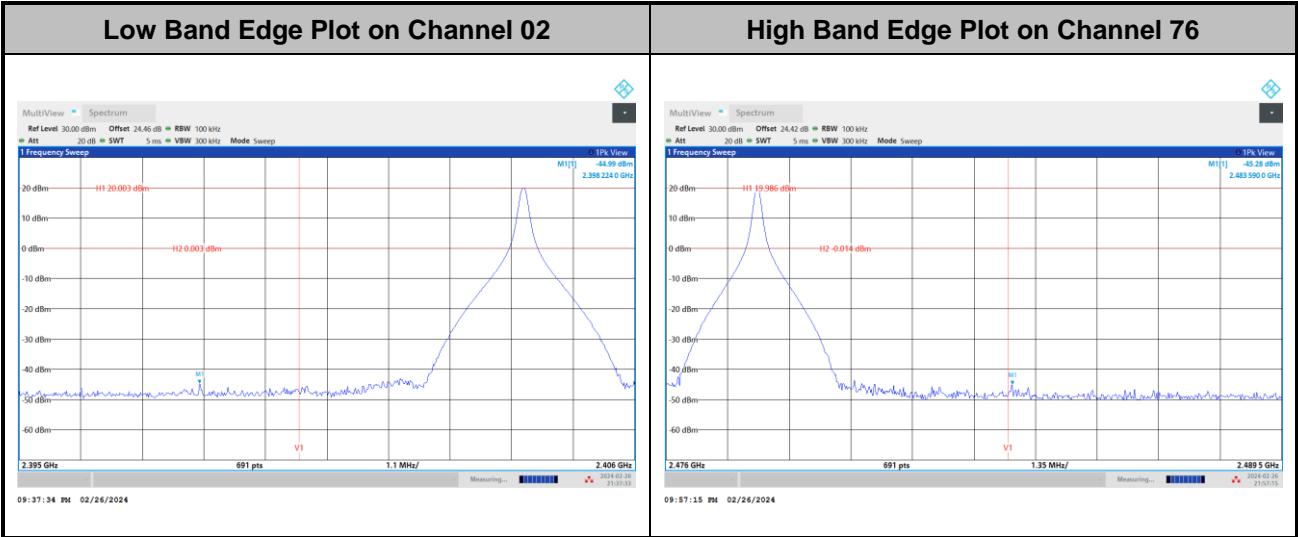

<2Mbps>

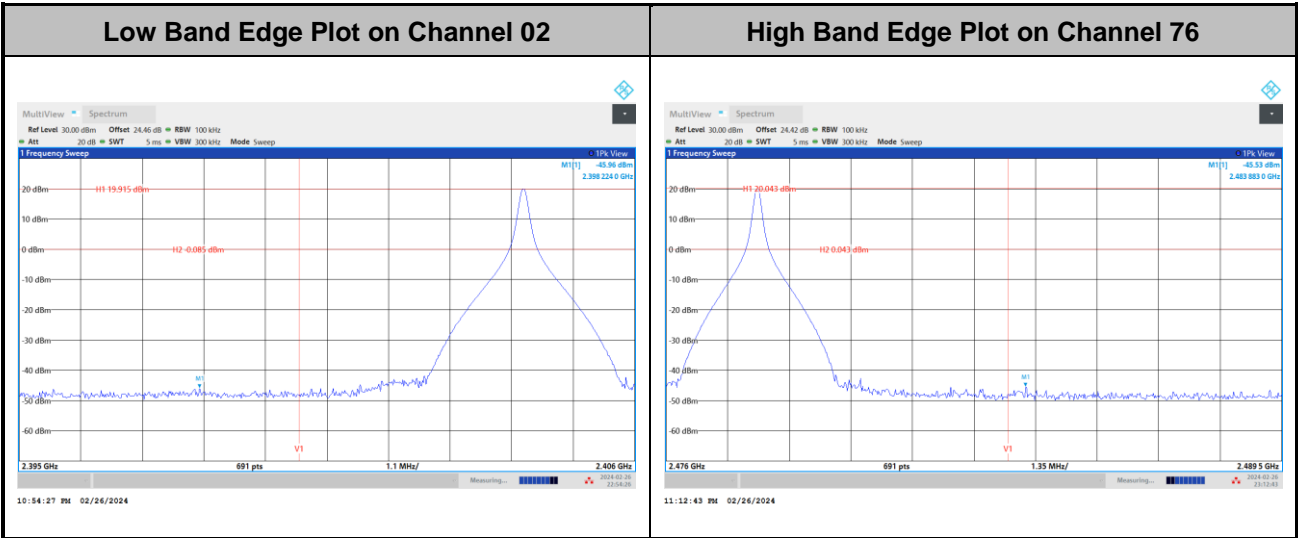



Hopping Mode Band Edges

<1Mbps>

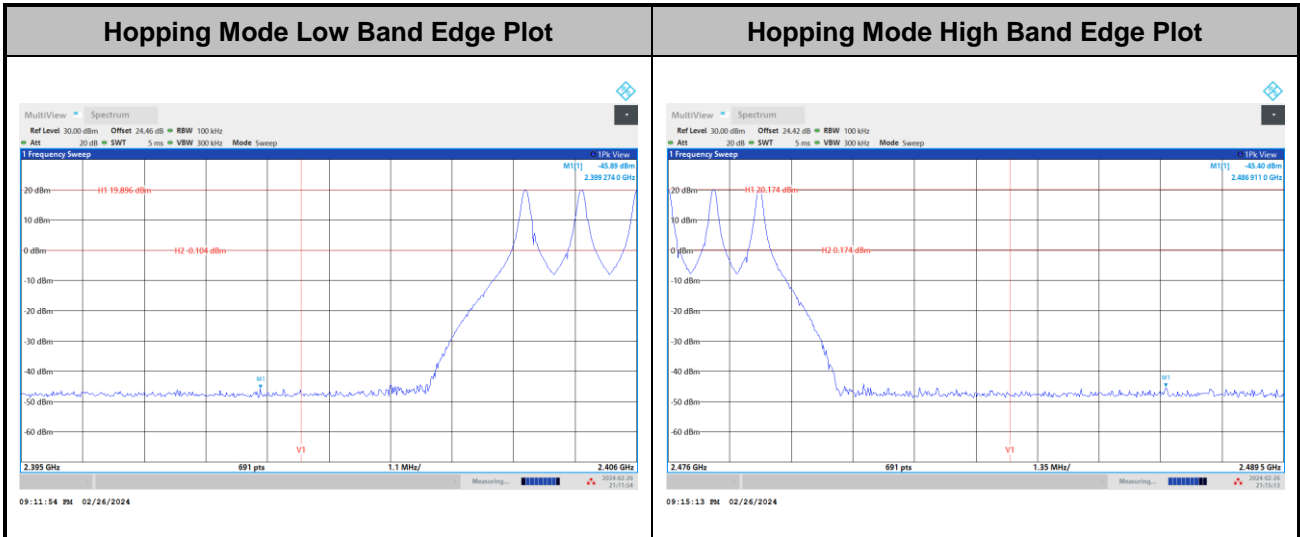

<2Mbps>

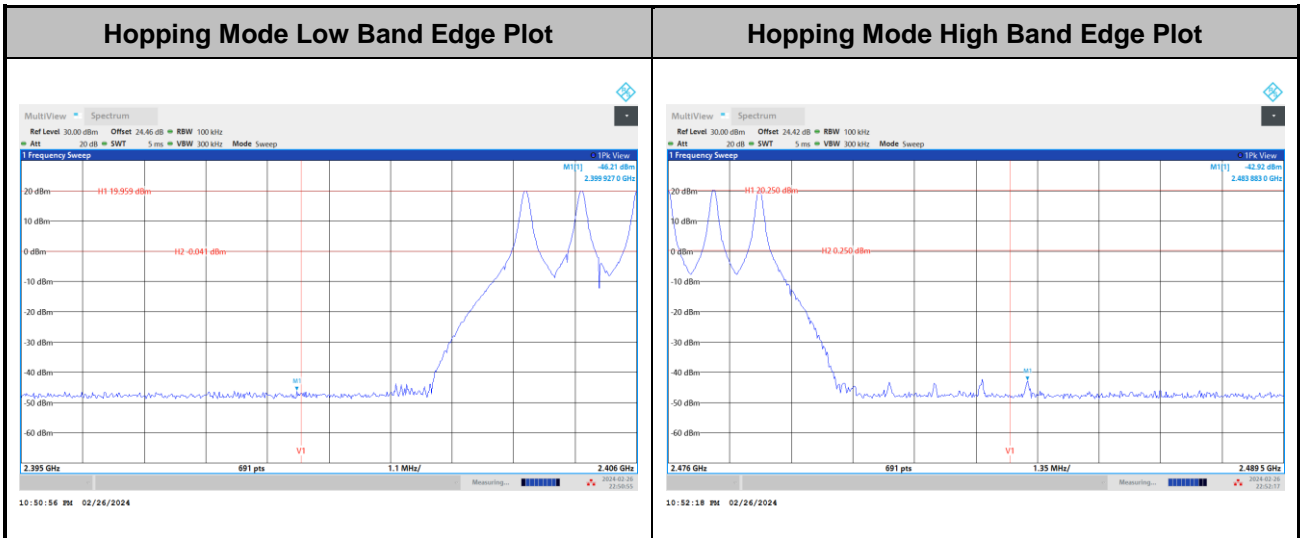



Conducted Spurious Emission

<1Mbps>

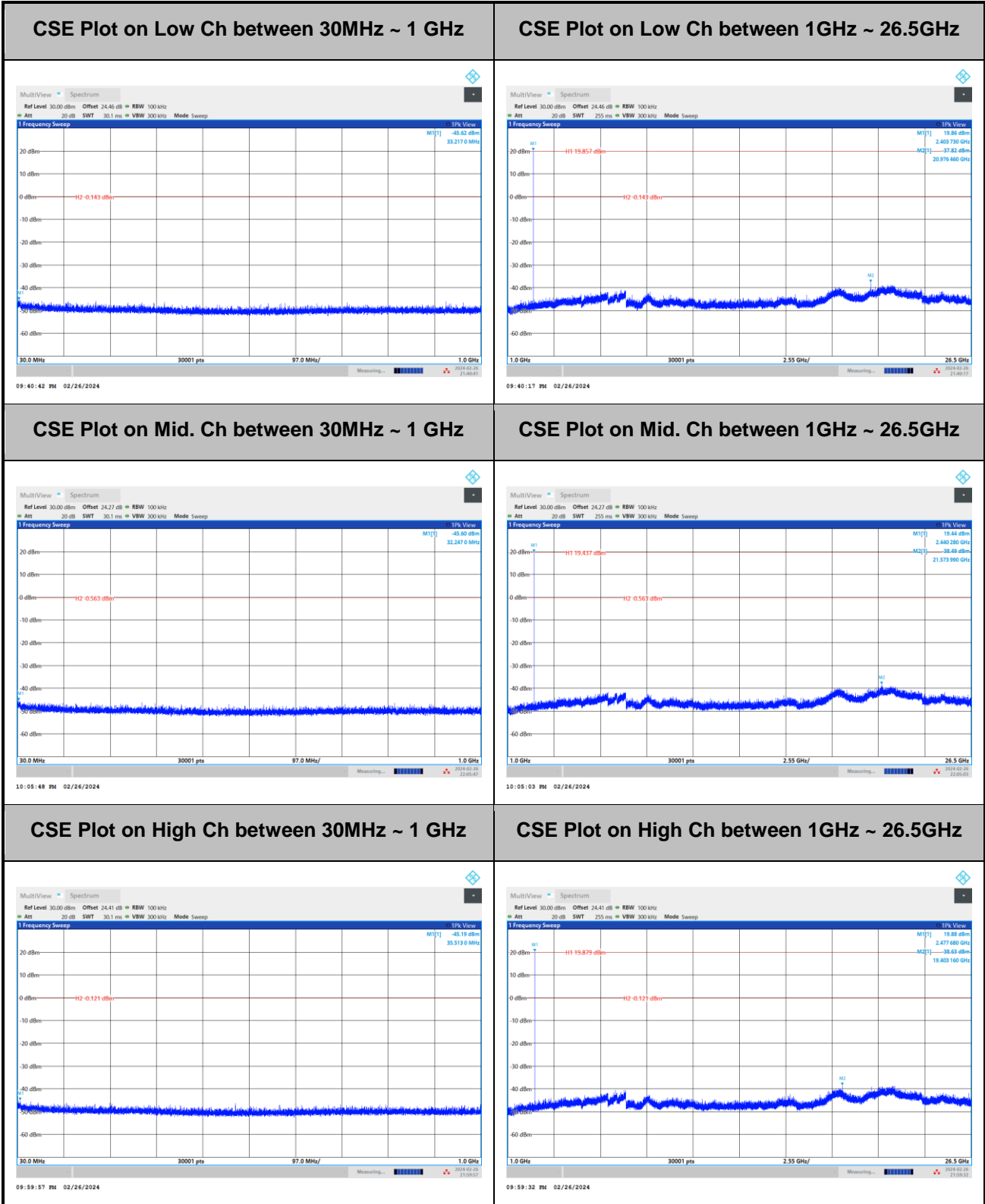



<2Mbps>

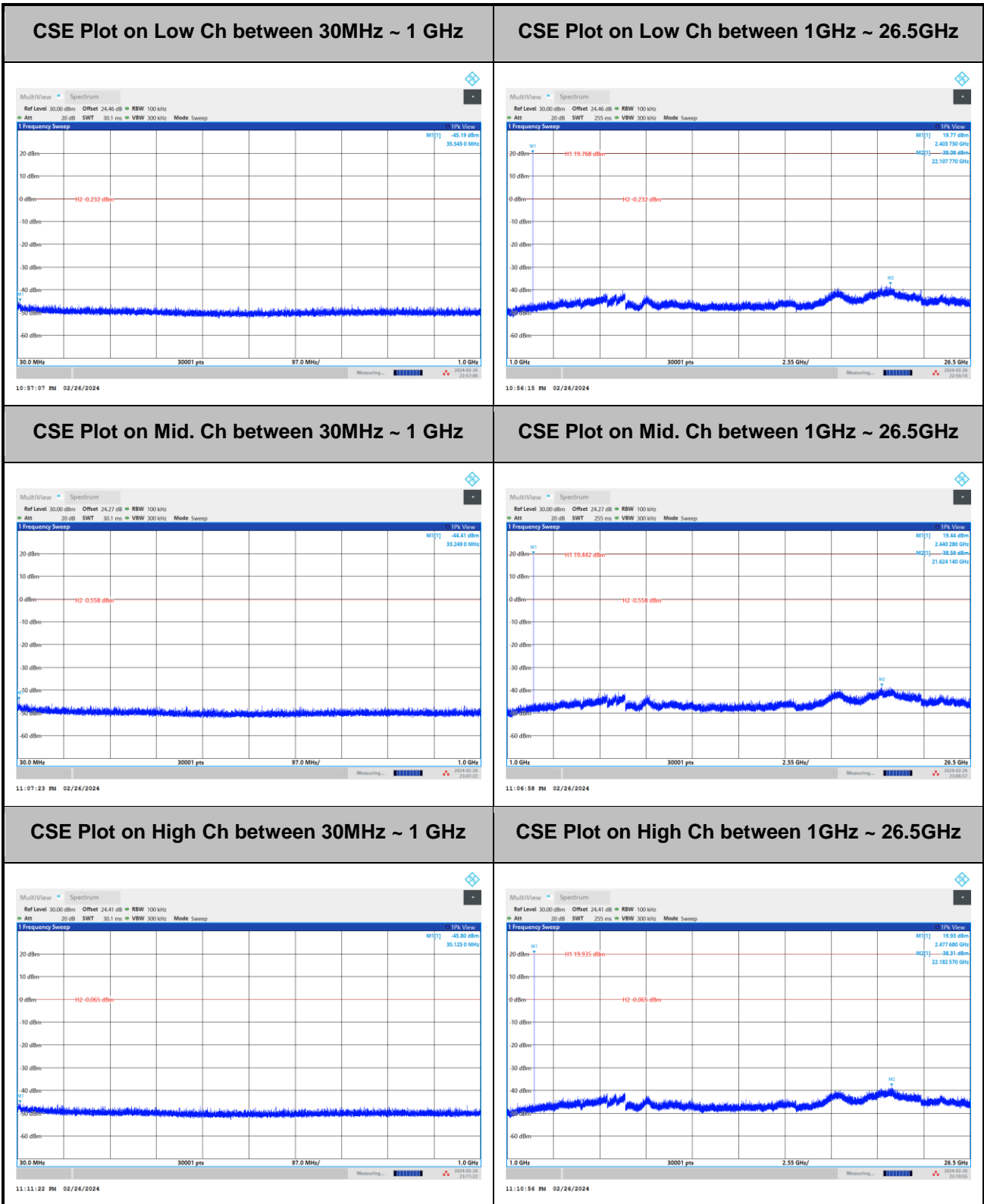



<Ant.4>

Number of Hopping Frequency

<1Mbps>

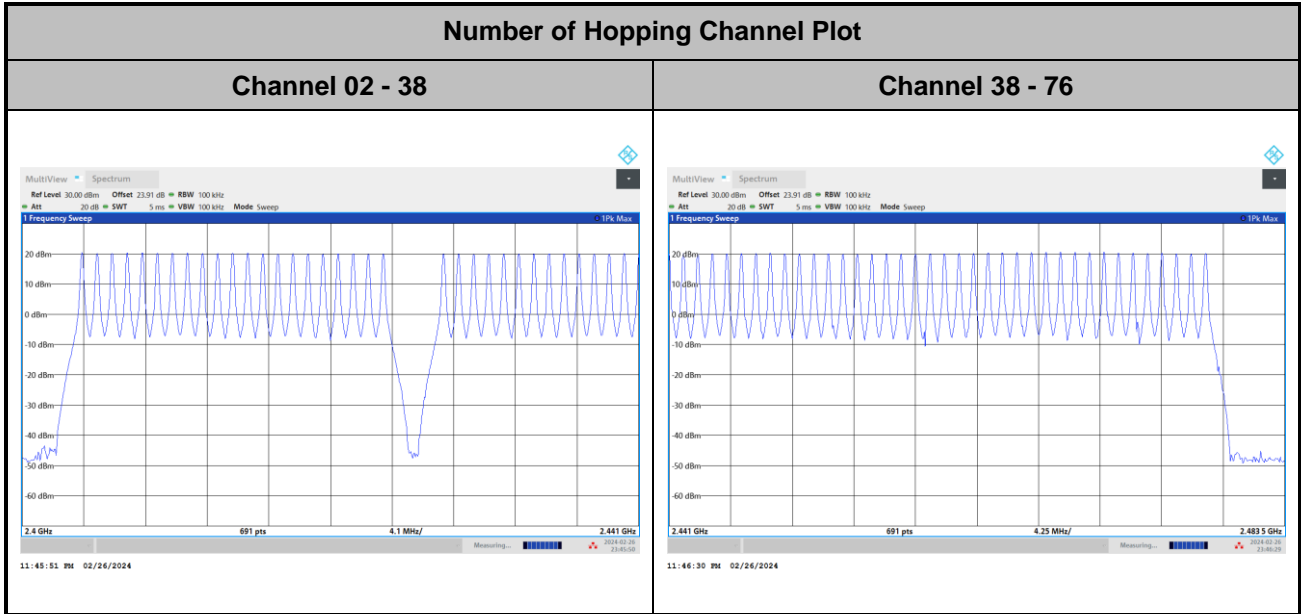

<2Mbps>

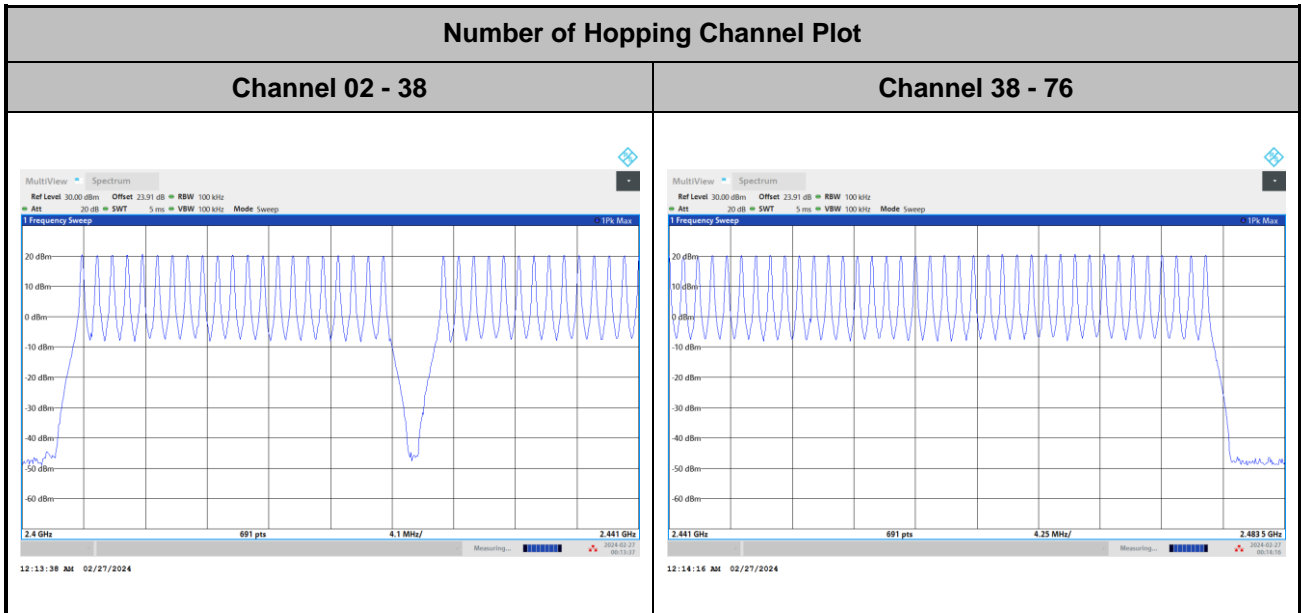



Hopping Channel Separation

<1Mbps>

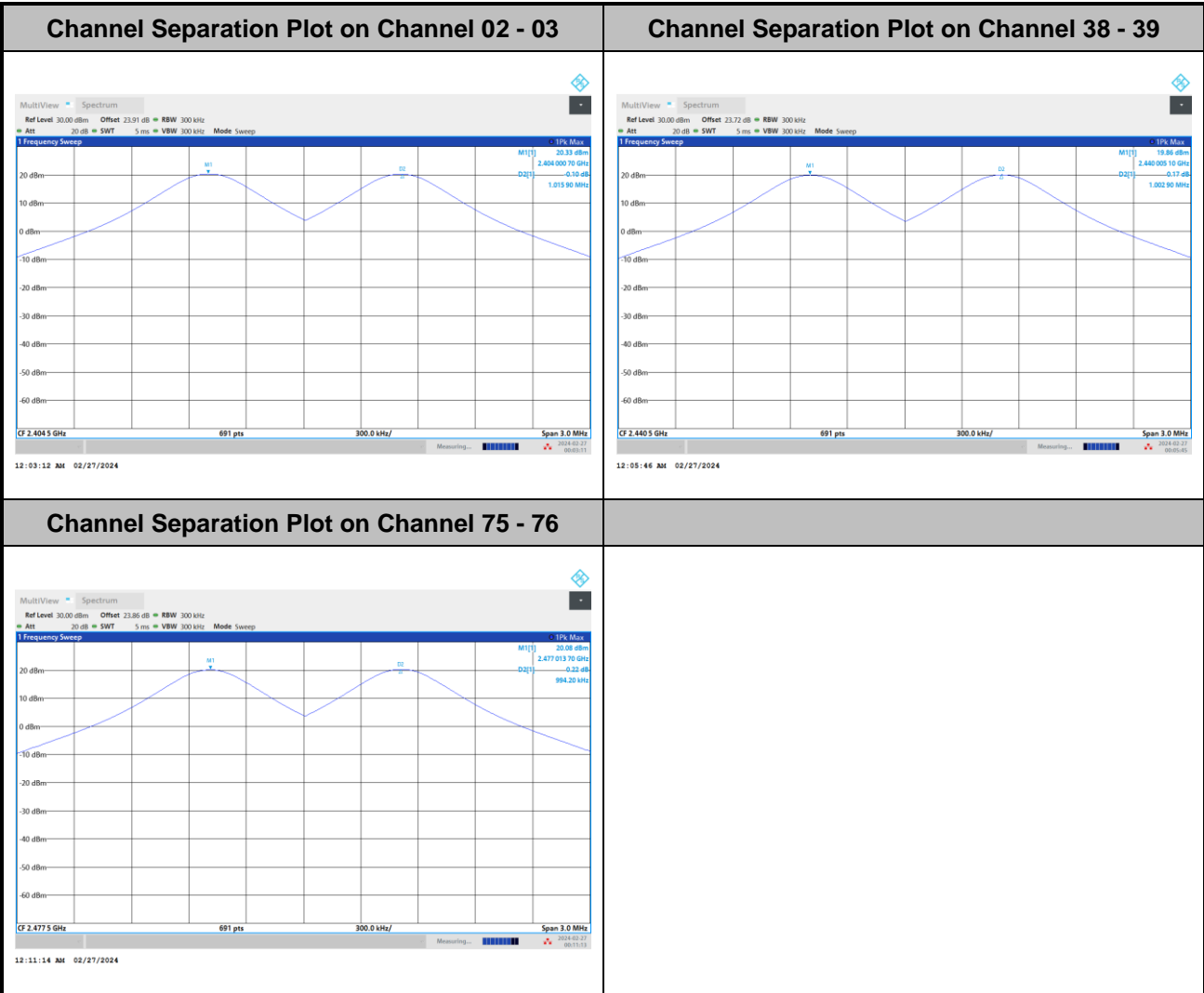



<2Mbps>

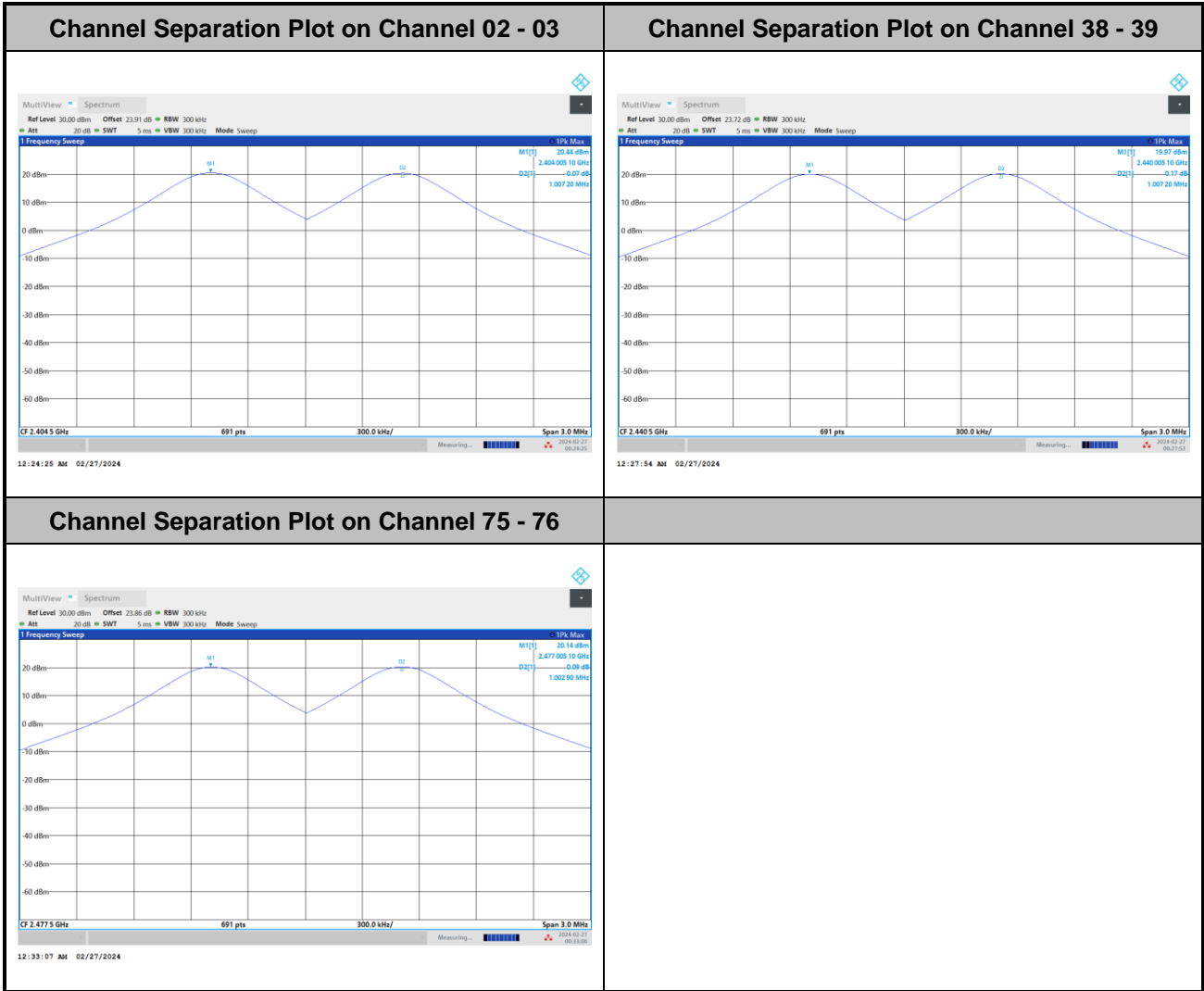

Dwell Time

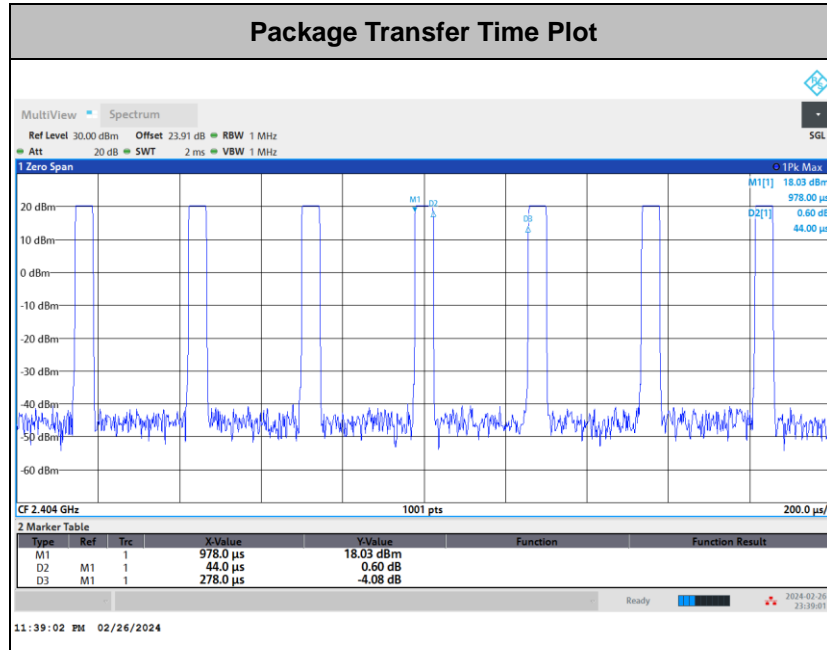

Remark:

1. Dwell Time(s) = Hops Over Occupancy Time (hops) x Package Transfer Time
2. The observation Occupancy time is hopping channel 72 channels x 400ms = 28.8sec using sweep point 30,000. This shows that 1ms per on-time contains 1 hop. The total hops is finally counted via computer analysis.

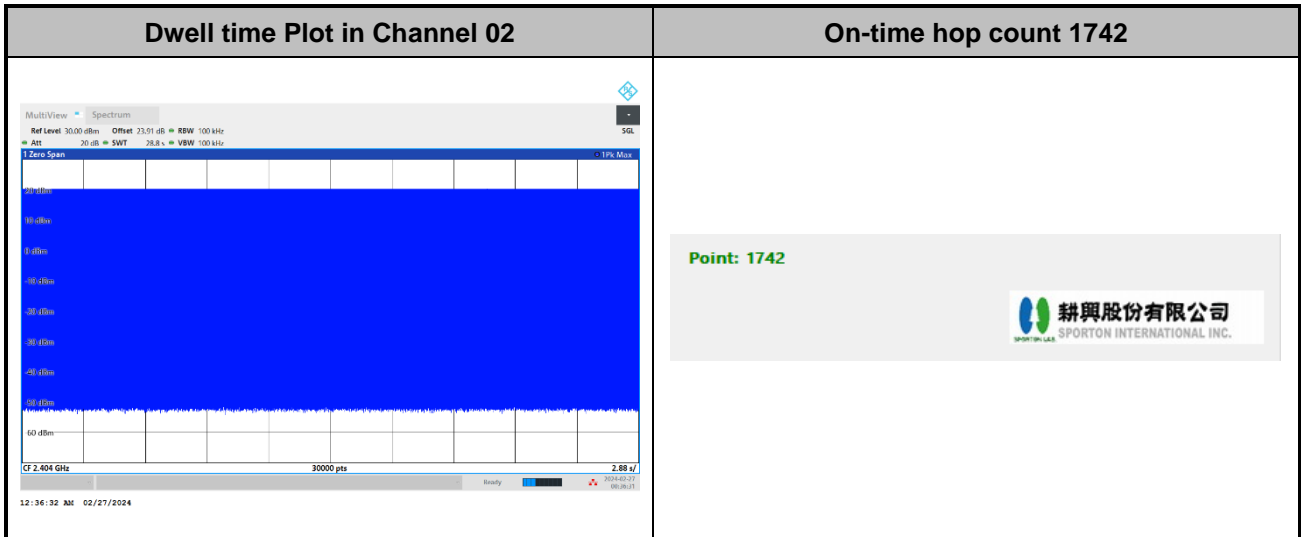



20dB Bandwidth

<1Mbps>

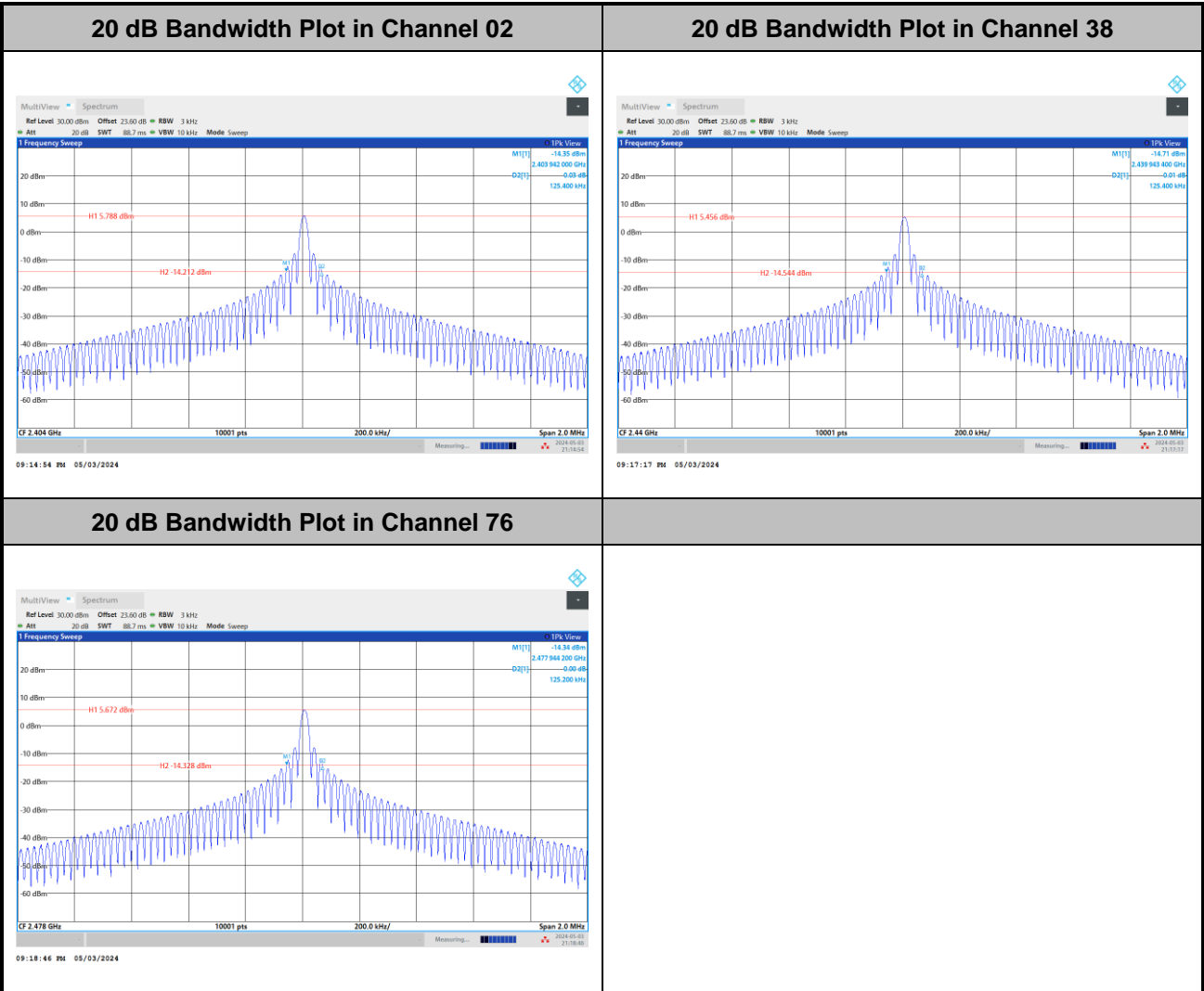



<2Mbps>

20 dB Bandwidth Plot in Channel 02

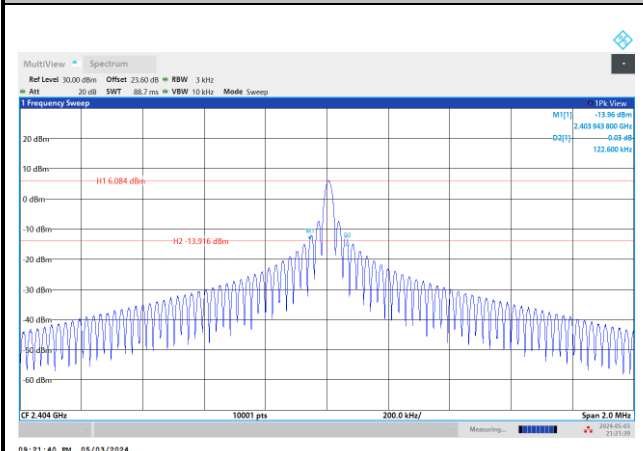

20 dB Bandwidth Plot in Channel 38

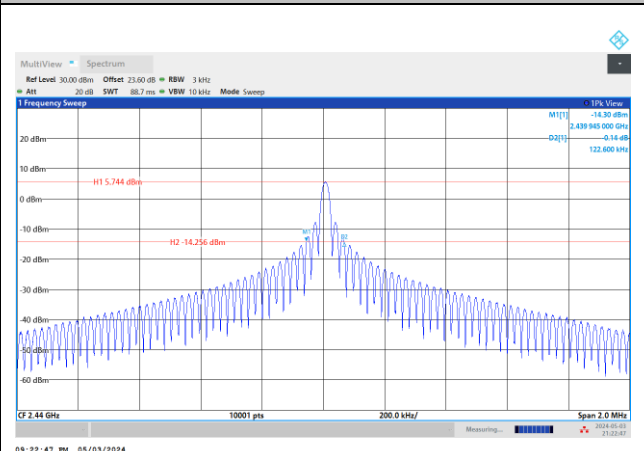

20 dB Bandwidth Plot in Channel 76

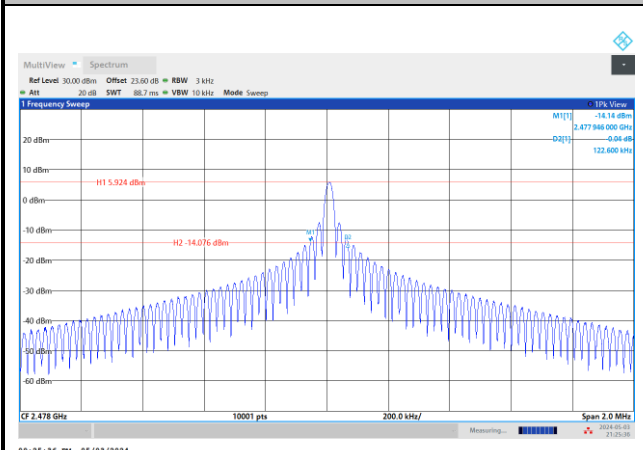



99% Occupied Bandwidth

<1Mbps>

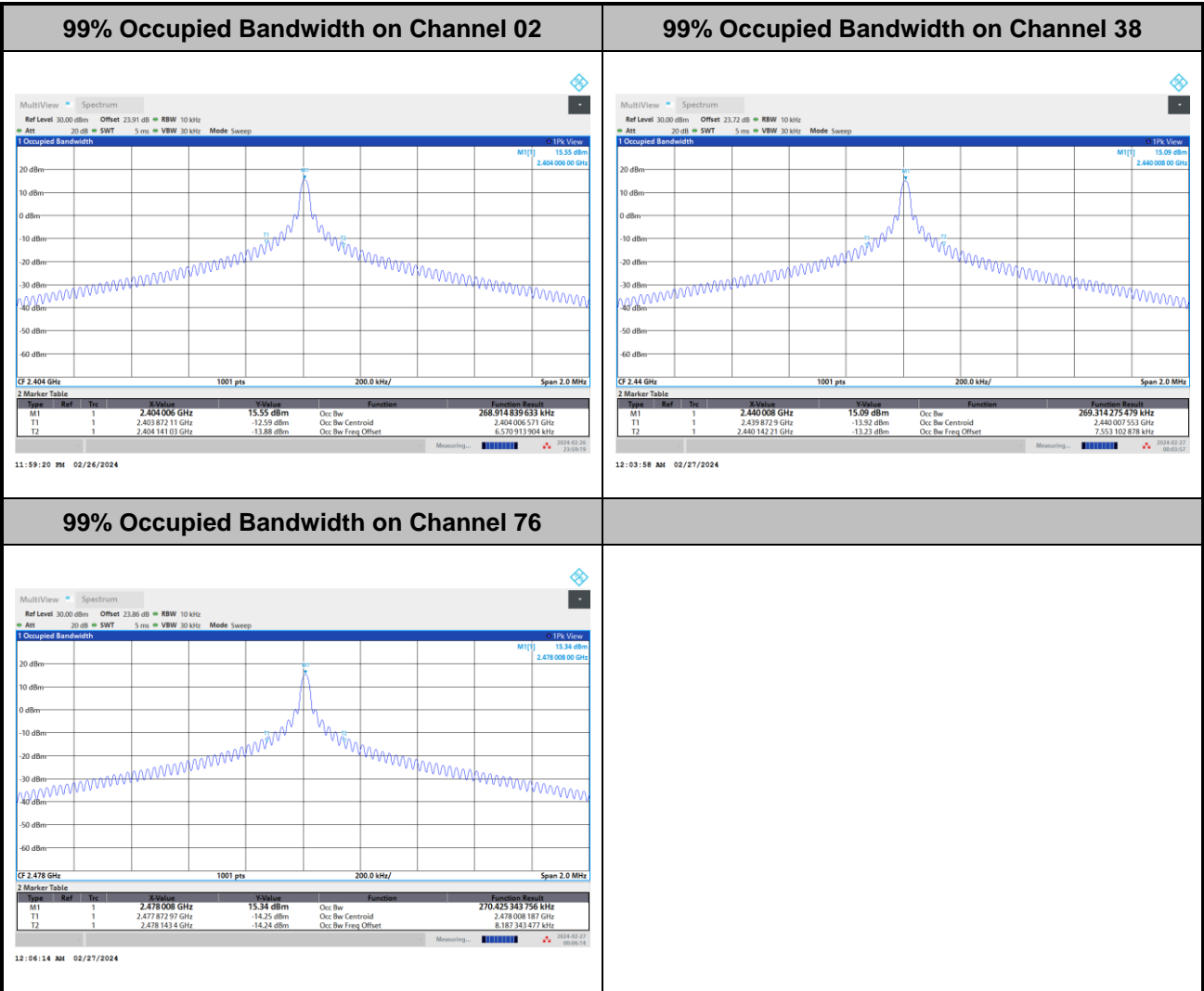



<2Mbps>

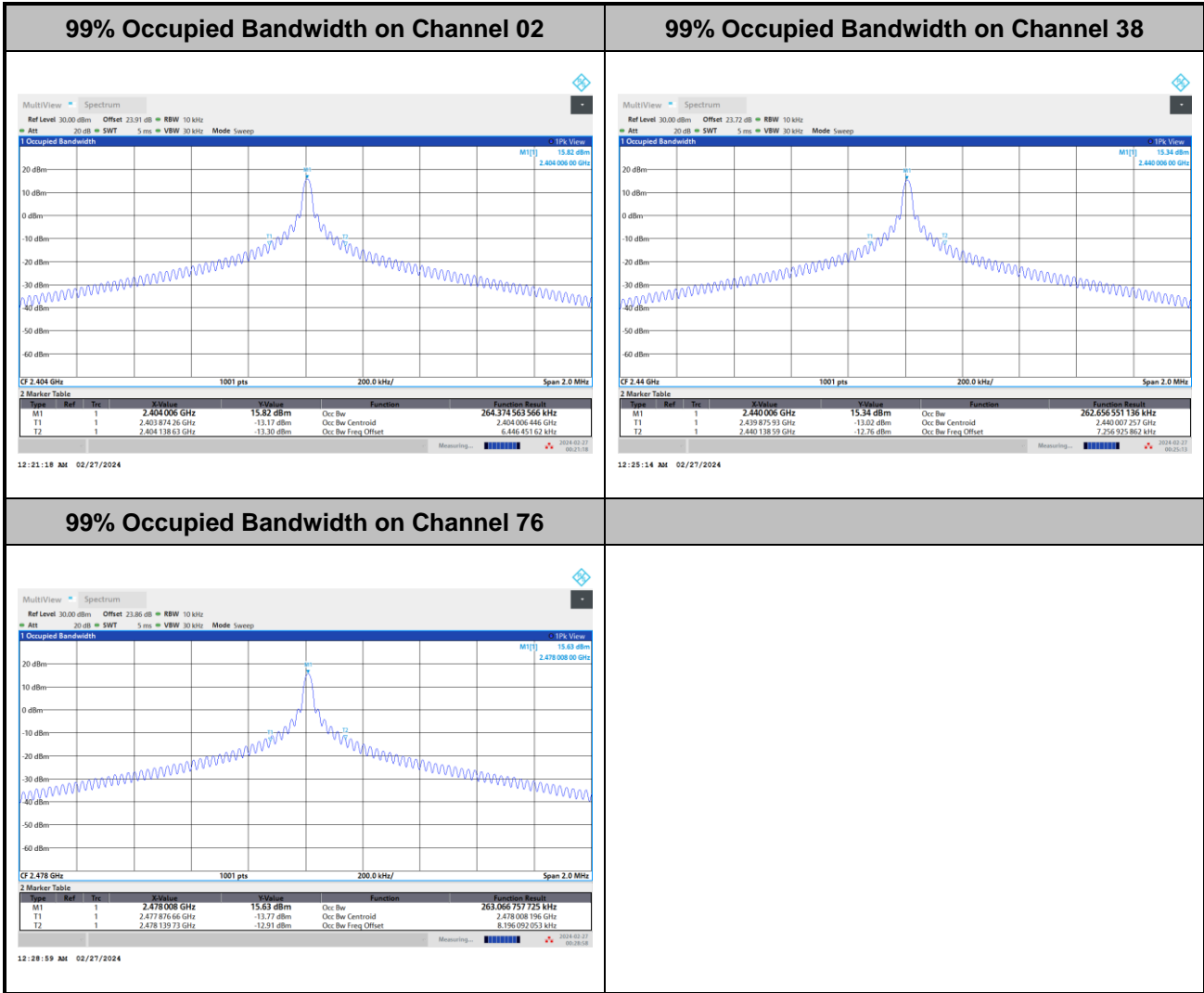



Band Edges

<1Mbps>

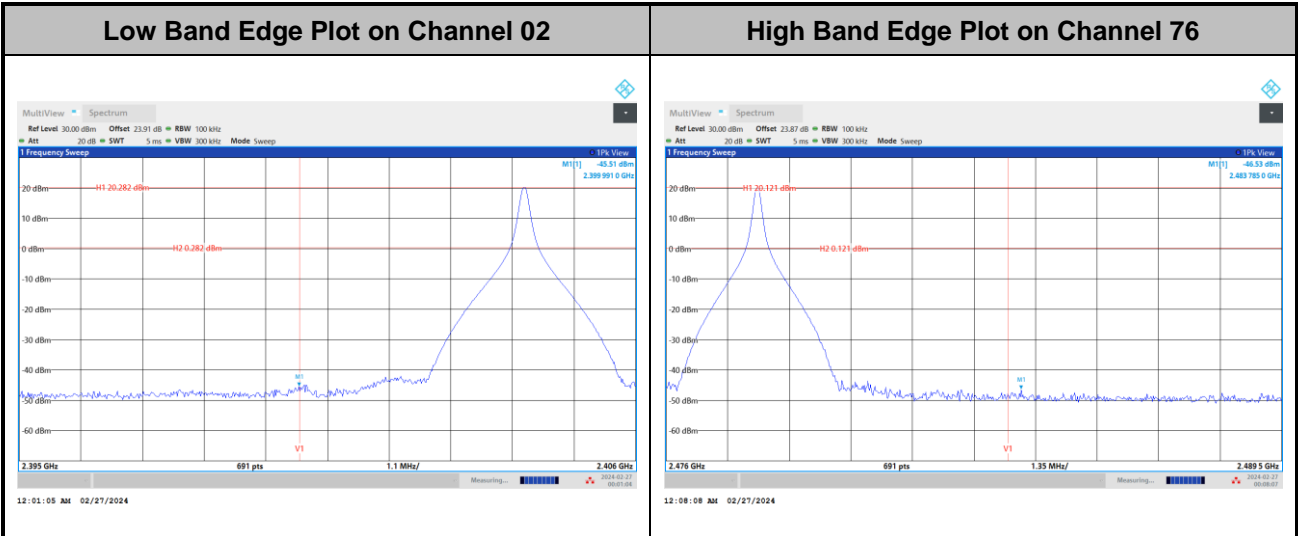

<2Mbps>

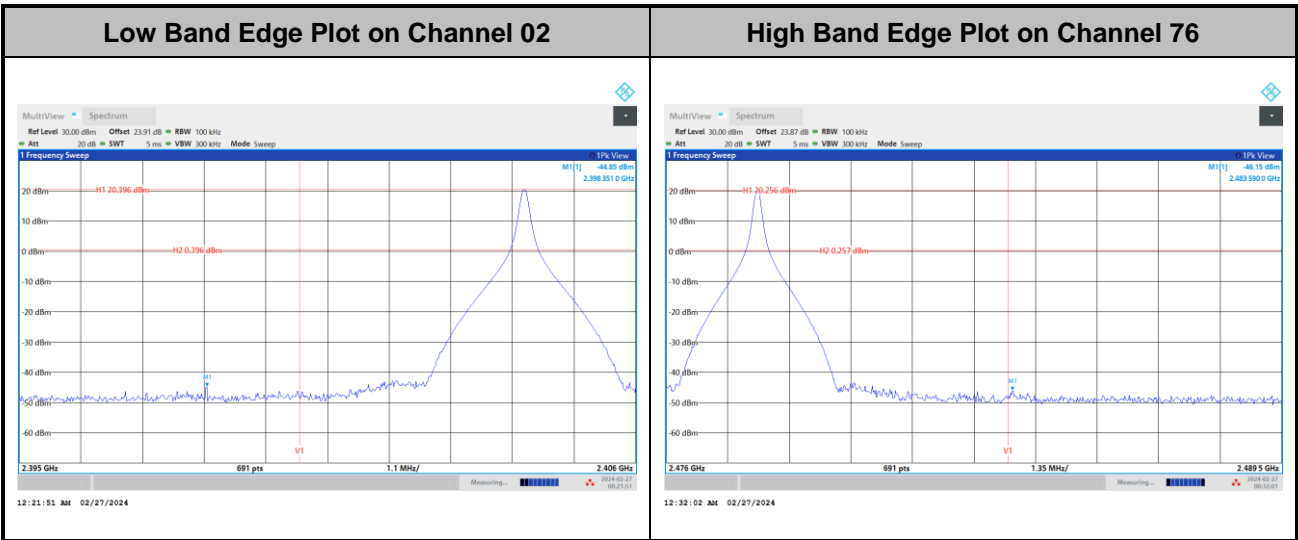



Hopping Mode Band Edges

<1Mbps>



<2Mbps>

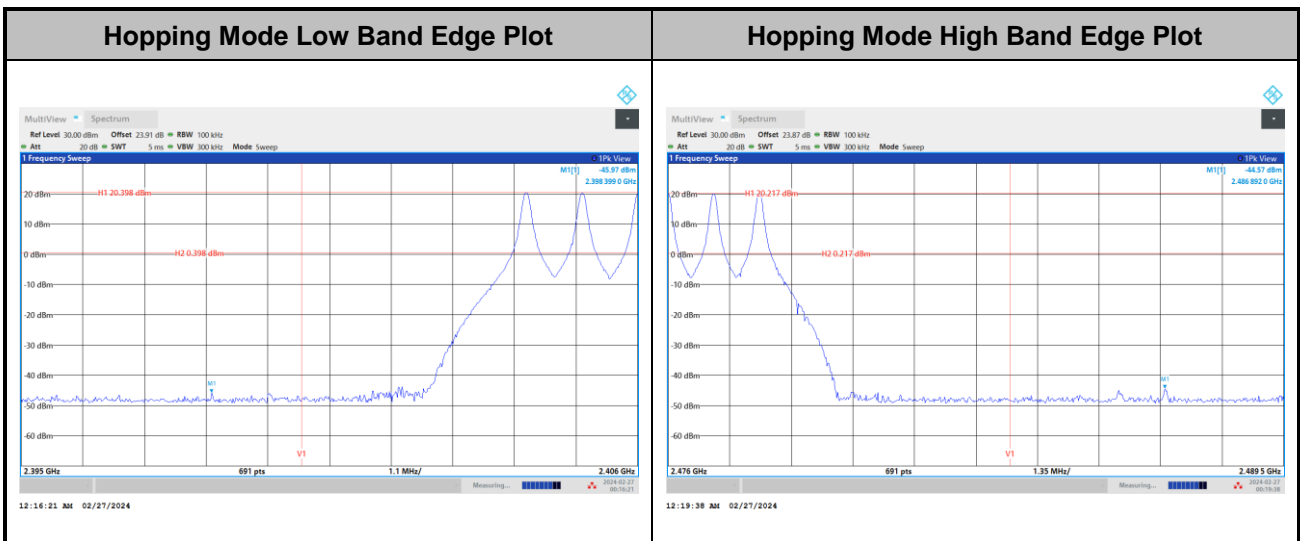



Conducted Spurious Emission

<1Mbps>

CSE Plot on Low Ch between 30MHz ~ 1 GHz

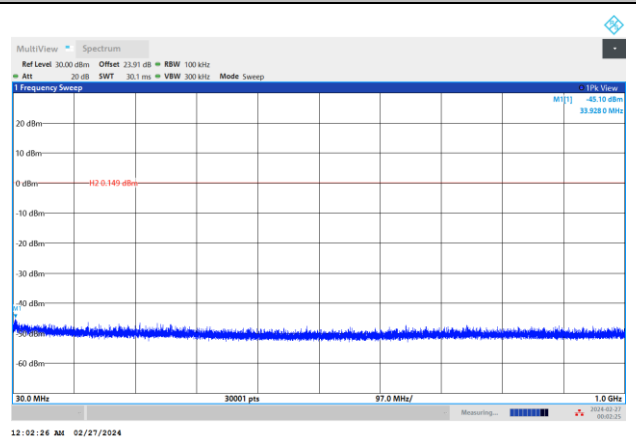

CSE Plot on Low Ch between 1GHz ~ 26.5GHz

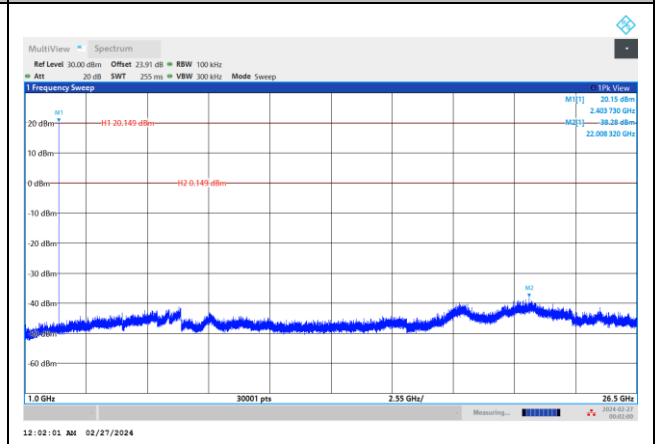

CSE Plot on Mid. Ch between 30MHz ~ 1 GHz

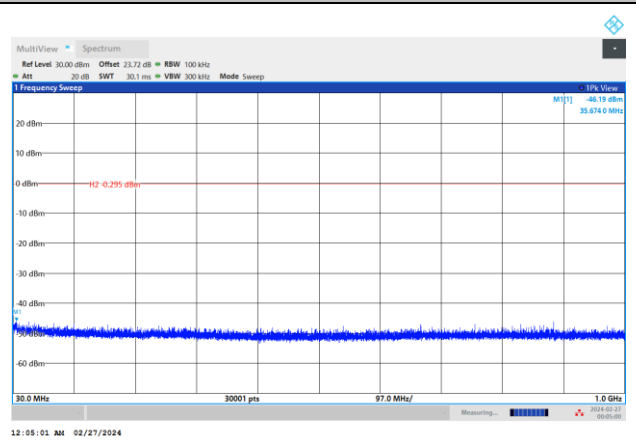

CSE Plot on Mid. Ch between 1GHz ~ 26.5GHz

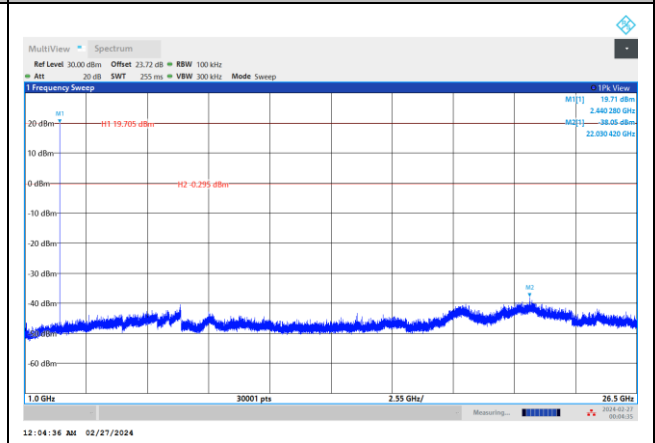

CSE Plot on High Ch between 30MHz ~ 1 GHz

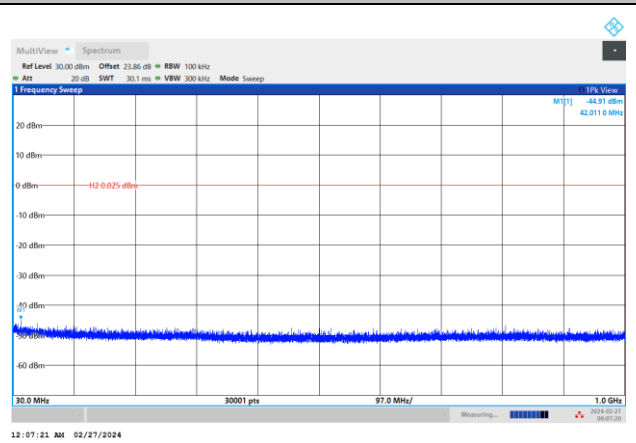

CSE Plot on High Ch between 1GHz ~ 26.5GHz

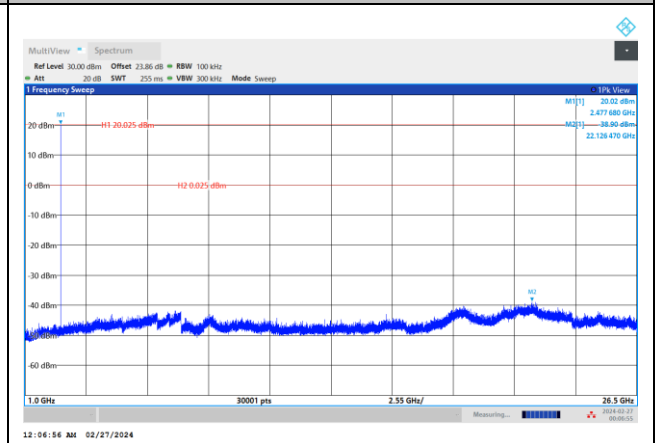

<2Mbps>



CSE Plot on Low Ch between 30MHz ~ 1 GHz

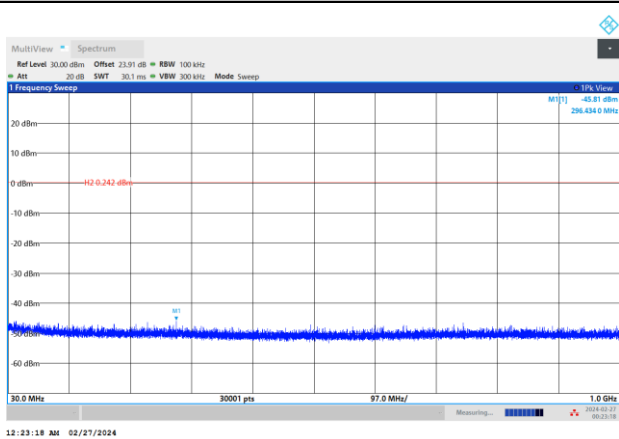

CSE Plot on Low Ch between 1GHz ~ 26.5GHz

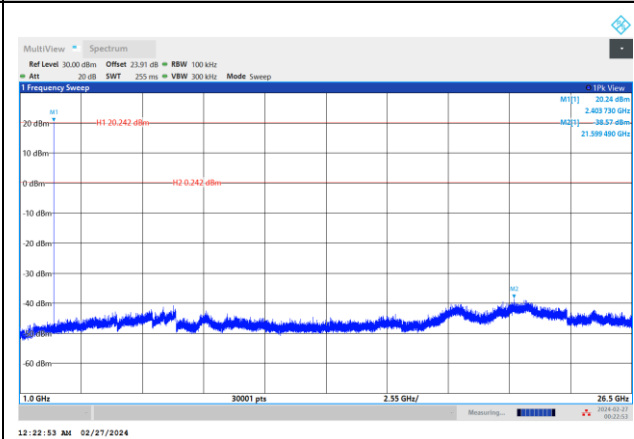

CSE Plot on Mid. Ch between 30MHz ~ 1 GHz

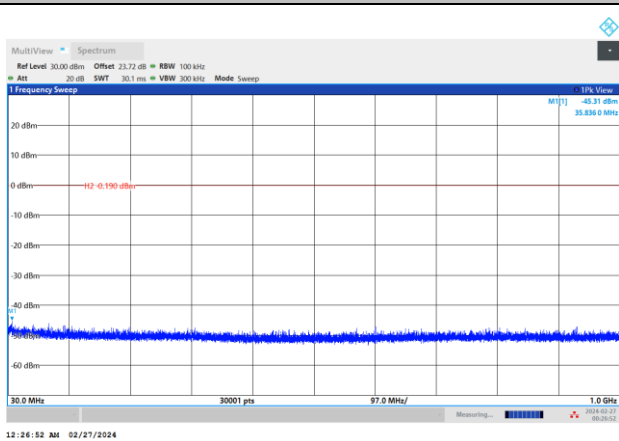

CSE Plot on Mid. Ch between 1GHz ~ 26.5GHz

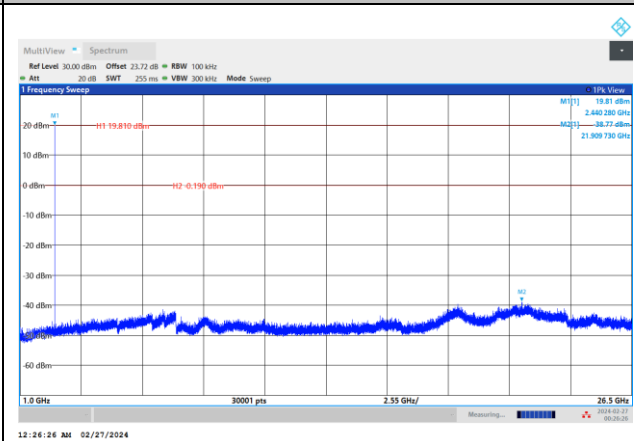

CSE Plot on High Ch between 30MHz ~ 1 GHz

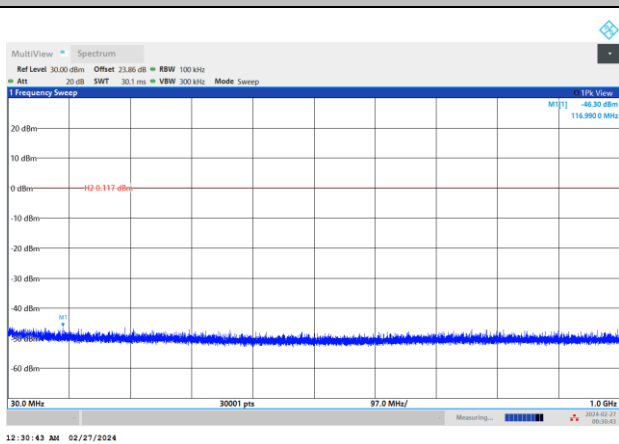

CSE Plot on High Ch between 1GHz ~ 26.5GHz

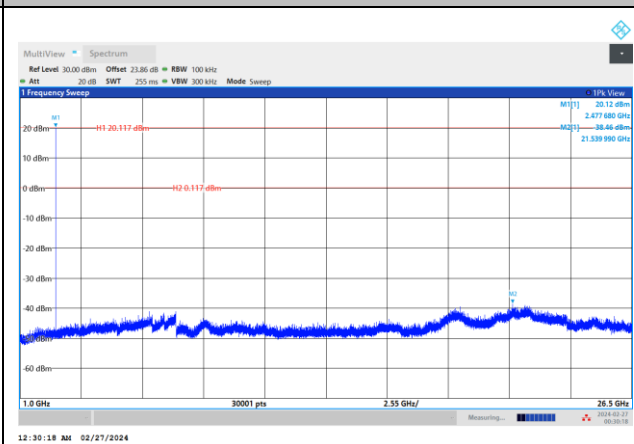



Appendix B. AC Conducted Emission Test Results

Test Engineer :	Louis Chung	Temperature :	19.2~23.3°C
		Relative Humidity :	49.5~53.6%

EUT Information

Report NO : 3N2325

Test Voltage : 120Vac/60Hz
Phase : Line

Full Spectrum

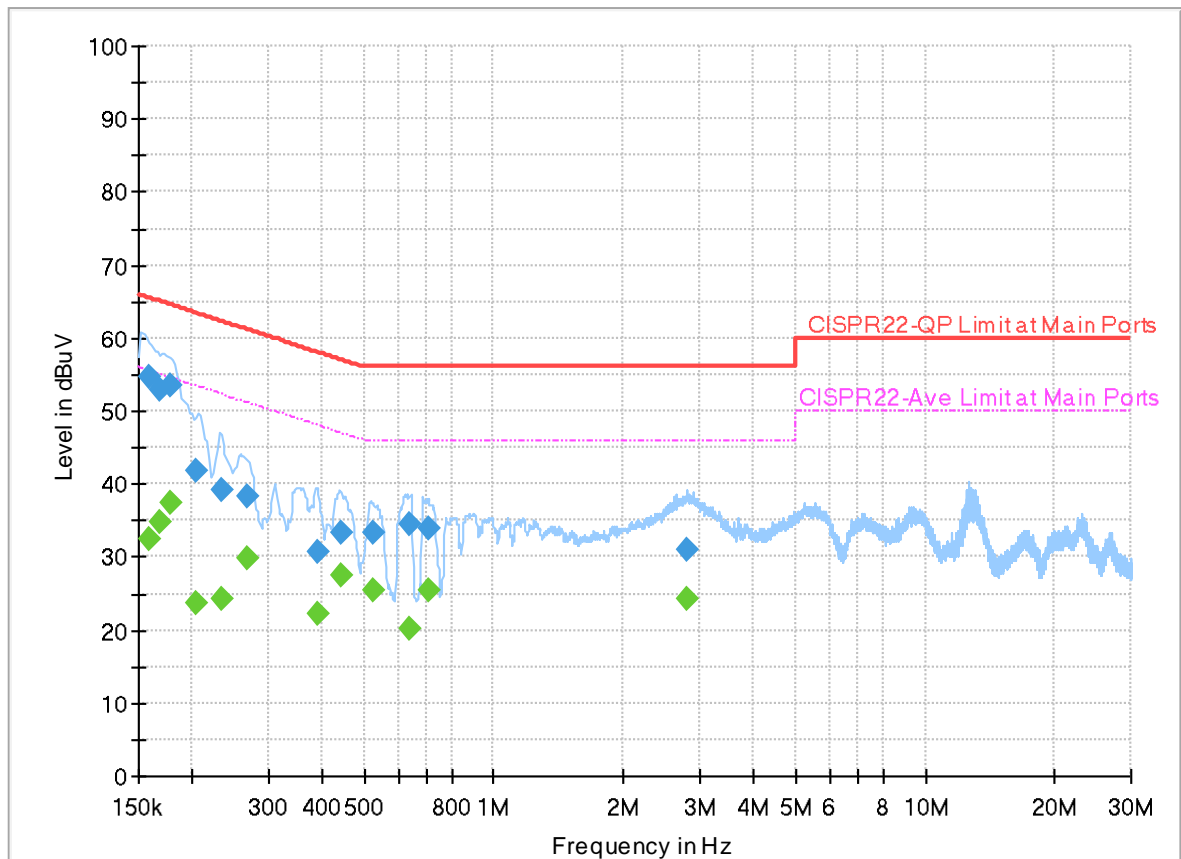

Final_Result

Frequency (MHz)	QuasiPeak (dBuV)	CAverage (dBuV)	Limit (dBuV)	Margin (dB)	Line	Filter	Corr. (dB)
0.159000	---	32.59	55.52	22.93	L1	OFF	19.9
0.159000	54.68	---	65.52	10.84	L1	OFF	19.9
0.167370	---	34.77	55.09	20.32	L1	OFF	19.9
0.167370	53.02	---	65.09	12.07	L1	OFF	19.9
0.177000	---	37.29	54.63	17.34	L1	OFF	19.9
0.177000	53.42	---	64.63	11.21	L1	OFF	19.9
0.203820	---	23.58	53.45	29.87	L1	OFF	19.9
0.203820	41.80	---	63.45	21.65	L1	OFF	19.9
0.234420	---	24.17	52.29	28.12	L1	OFF	19.9
0.234420	39.05	---	62.29	23.24	L1	OFF	19.9
0.267000	---	29.95	51.21	21.26	L1	OFF	19.9
0.267000	38.29	---	61.21	22.92	L1	OFF	19.9
0.392550	---	22.15	48.01	25.86	L1	OFF	19.9
0.392550	30.78	---	58.01	27.23	L1	OFF	19.9
0.442500	---	27.47	47.02	19.55	L1	OFF	19.9
0.442500	33.27	---	57.02	23.75	L1	OFF	19.9
0.524310	---	25.58	46.00	20.42	L1	OFF	19.9
0.524310	33.31	---	56.00	22.69	L1	OFF	19.9
0.638250	---	20.29	46.00	25.71	L1	OFF	19.9

0.638250	34.64	---	56.00	21.36	L1	OFF	19.9
0.708000	---	25.40	46.00	20.60	L1	OFF	19.9
0.708000	34.03	---	56.00	21.97	L1	OFF	19.9
2.816250	---	24.21	46.00	21.79	L1	OFF	20.0
2.816250	30.96	---	56.00	25.04	L1	OFF	20.0

EUT Information

Report NO : 3N2325

Test Voltage : 120Vac/60Hz

Phase : Neutral

Full Spectrum

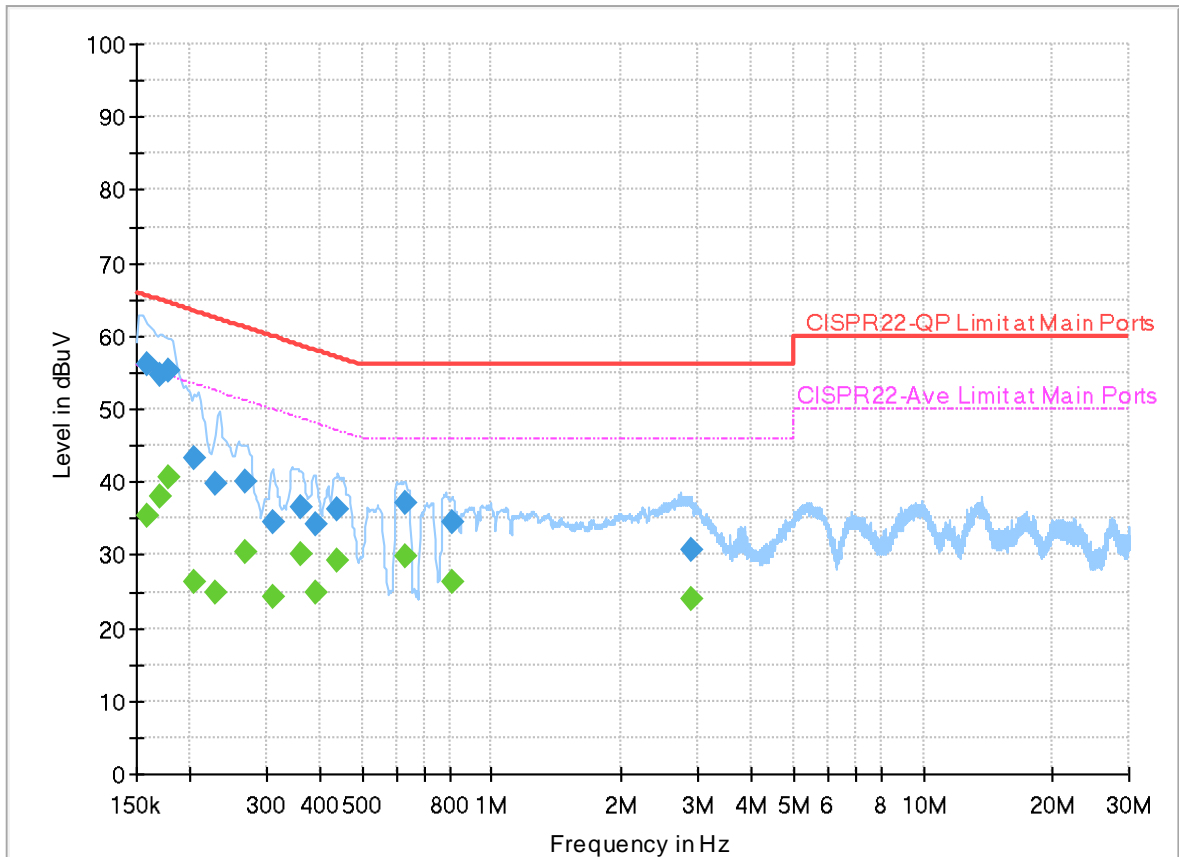

Final_Result

Frequency (MHz)	QuasiPeak (dBuV)	CAverage (dBuV)	Limit (dBuV)	Margin (dB)	Line	Filter	Corr. (dB)
0.159000	---	35.42	55.52	20.10	N	OFF	19.9
0.159000	56.26	---	65.52	9.26	N	OFF	19.9
0.169170	---	37.89	55.00	17.11	N	OFF	19.9
0.169170	54.66	---	65.00	10.34	N	OFF	19.9
0.177720	---	40.63	54.59	13.96	N	OFF	19.9
0.177720	55.25	---	64.59	9.34	N	OFF	19.9
0.204000	---	26.32	53.45	27.13	N	OFF	19.9
0.204000	43.41	---	63.45	20.04	N	OFF	19.9
0.228750	---	24.78	52.50	27.72	N	OFF	19.9
0.228750	39.81	---	62.50	22.69	N	OFF	19.9
0.267000	---	30.50	51.21	20.71	N	OFF	19.9
0.267000	39.96	---	61.21	21.25	N	OFF	19.9
0.311100	---	24.25	49.94	25.69	N	OFF	19.9
0.311100	34.36	---	59.94	25.58	N	OFF	19.9
0.359070	---	30.11	48.75	18.64	N	OFF	19.9
0.359070	36.53	---	58.75	22.22	N	OFF	19.9
0.389580	---	24.72	48.07	23.35	N	OFF	19.9
0.389580	34.15	---	58.07	23.92	N	OFF	19.9
0.439800	---	29.23	47.07	17.84	N	OFF	19.9

0.439800	36.14	---	57.07	20.93	N	OFF	19.9
0.628440	---	29.77	46.00	16.23	N	OFF	19.9
0.628440	37.16	---	56.00	18.84	N	OFF	19.9
0.809250	---	26.24	46.00	19.76	N	OFF	19.9
0.809250	34.36	---	56.00	21.64	N	OFF	19.9
2.892390	---	23.89	46.00	22.11	N	OFF	20.0
2.892390	30.58	---	56.00	25.42	N	OFF	20.0



Appendix C. Radiated Spurious Emission

Test Engineer :	Daniel Lee, Quentin Liu and Bigshow Wang	Temperature :	22.1~22.6°C
		Relative Humidity :	55~57%

<ASK 1Mbps>

<Ant.3>

2.4GHz 2400~2483.5MHz

BLE (Band Edge @ 3m)

BLE	Note	Frequency	Level	Margin	Limit Line	Read Level	Antenna Factor	Path Loss	Preamp Factor	Ant Pos	Table Pos	Peak Avg.	Pol.	
		(MHz)	(dBμV/m)	(dB)	(dBμV/m)	(dBμV)	(dB/m)	(dB)	(dB)	(cm)	(deg)	(P/A)	(H/V)	
BLE CH02 2404MHz		2386.335	50.24	-23.76	74	43.84	27.37	5.6	36.49	100	211	P	H	
		2386.335	-4.85	-58.85	54	-	-	-	-	-	-	A	H	
	*	2404	110.59	-	-	104.11	27.42	5.62	36.48	100	211	P	H	
	*	2404	55.5	-	-	-	-	-	-	-	-	A	H	
													H	
			2353.155	50.51	-23.49	74	44.21	27.31	5.56	36.49	298	298	P	V
			2353.155	-4.58	-58.58	54	-	-	-	-	-	-	A	V
	*		2404	108.88	-	-	102.4	27.42	5.62	36.48	298	298	P	V
	*		2404	53.79	-	-	-	-	-	-	-	-	A	V
													V	
BLE CH 38 2440MHz		2347.38	50.66	-23.34	74	44.39	27.29	5.55	36.49	137	220	P	H	
		2347.38	-4.43	-58.43	54	-	-	-	-	-	-	A	H	
	*	2440	113.34	-	-	106.66	27.56	5.67	36.47	137	220	P	H	
	*	2440	58.25	-	-	-	-	-	-	-	-	A	H	
			2486.56	50.53	-23.47	74	43.6	27.75	5.72	36.46	137	220	P	H
			2486.56	-4.56	-58.56	54	-	-	-	-	-	-	A	H
			2372.02	50.32	-23.68	74	43.97	27.34	5.58	36.49	370	296	P	V
			2372.02	-4.77	-58.77	54	-	-	-	-	-	-	A	V
	*		2440	111.57	-	-	104.89	27.56	5.67	36.47	370	296	P	V
	*		2440	56.48	-	-	-	-	-	-	-	-	A	V
			2491.04	50.5	-23.5	74	43.56	27.76	5.72	36.46	370	296	P	V
			2491.04	-4.59	-58.59	54	-	-	-	-	-	-	A	V



BLE	Note	Frequency (MHz)	Level (dBμV/m)	Margin (dB)	Limit Line (dBμV/m)	Read Level (dBμV)	Antenna Factor (dB/m)	Path Loss (dB)	Preamp Factor (dB)	Ant Pos (cm)	Table Pos (deg)	Peak Avg. (P/A)	Pol. (H/V)	
BLE CH 76 2478MHz	*	2478	110.97	-	-	104.09	27.71	5.71	36.46	100	211	P	H	
	*	2478	55.88	-	-	-	-	-	-	-	-	A	H	
		2483.56	54.83	-19.17	74	47.92	27.73	5.72	36.46	100	211	P	H	
		2483.56	-0.26	-54.26	54	-	-	-	-	-	-	A	H	
													H	
													H	
	*	2478	112.03	-	-	105.15	27.71	5.71	36.46	400	294	P	V	
	*	2478	56.94	-	-	-	-	-	-	-	-	-	A	V
		2483.76	56.34	-17.66	74	49.42	27.74	5.72	36.46	400	294	P	V	
		2483.76	1.25	-52.75	54	-	-	-	-	-	-	A	V	
													V	
													V	
Remark	1. No other spurious found. 2. All results are PASS against Peak and Average limit line.													



2.4GHz 2400~2483.5MHz
BLE (Harmonic @ 3m)

BLE	Note	Frequency (MHz)	Level (dBμV/m)	Margin (dB)	Limit Line (dBμV/m)	Read Level (dBμV)		Antenna Factor (dB/m)	Path Loss (dB)	Preamp Factor (dB)	Ant Pos (cm)	Table Pos (deg)	Peak Avg. (P/A)	Pol. (H/V)
BLE CH 00 2404MHz		4808	37.45	-36.55	74	55.96		32.15	8.5	59.16	-	-	P	H
		4808	-17.64	-71.64	54	-		-	-	-	-	-	P	H
														H
														H
														H
														H
														H
														H
														H
														H
														H
														H
														H
														H
														H
														H
														H
														H
														H
			4808	37.11	-36.89	74	55.62		32.15	8.99	59.16	-	-	P
		4808	-17.98	-71.98	54	-		-	-	-	-	-	P	V
														V
														V
														V
														V
														V
														V
														V
														V
														V
														V
														V
														V
														V
														V



BLE	Note	Frequency (MHz)	Level (dBμV/m)	Margin (dB)	Limit Line (dBμV/m)	Read Level (dBμV)	Antenna Factor (dB/m)	Path Loss (dB)	Preamp Factor (dB)	Ant Pos (cm)	Table Pos (deg)	Peak Avg. (P/A)	Pol. (H/V)	
BLE CH 38 2440MHz		4880	37.78	-36.22	74	55.83	32.58	8.56	59.19	-	-	P	H	
		4880	-17.31	-71.31	54	-	-	-	-	-	-	A	H	
		7320	43.4	-30.6	74	56.22	36.68	10.34	59.84	-	-	P	H	
		7320	-11.69	-65.69	54	-	-	-	-	-	-	A	H	
													H	
													H	
													H	
													H	
													H	
													H	
													H	
													H	
			4880	37.19	-36.81	74	55.24	32.58	8.56	59.19	-	-	P	V
			4880	-17.9	-71.9	54	-	-	-	-	-	-	A	V
			7320	42.98	-31.02	74	55.8	36.68	10.34	59.84	-	-	P	V
			7320	-12.11	-66.11	54	-	-	-	-	-	-	A	V
														V
														V
													V	
													V	
													V	
													V	



BLE	Note	Frequency (MHz)	Level (dBµV/m)	Margin (dB)	Limit Line (dBµV/m)	Read Level (dBµV)	Antenna Factor (dB/m)	Path Loss (dB)	Preamp Factor (dB)	Ant Pos (cm)	Table Pos (deg)	Peak Avg. (P/A)	Pol. (H/V)	
BLE CH 76 2478MHz		4956	38.08	-35.92	74	55.69	32.98	8.63	59.22	-	-	P	H	
		4956	-17.01	-71.01	54	-	-	-	-	-	-	A	H	
		7434	42.64	-31.36	74	56.01	36.13	10.47	59.97	-	-	P	H	
		7434	-12.45	-66.45	54	-	-	-	-	-	-	A	H	
													H	
													H	
													H	
													H	
													H	
													H	
													H	
			4956	37.94	-36.06	74	55.55	32.98	8.63	59.22	-	-	P	V
			4956	-17.15	-71.15	54	-	-	-	-	-	-	A	V
			7434	42.52	-31.48	74	55.89	36.13	10.47	59.97	-	-	P	V
			7434	-12.57	-66.57	54	-	-	-	-	-	-	A	V
														V
														V
														V
													V	
													V	
													V	
Remark	<p>1. No other spurious found.</p> <p>2. All results are PASS against Peak and Average limit line.</p> <p>3. The emission position marked as "-" means no suspected emission found with sufficient margin against limit line or noise floor only.</p>													



Emission above 18GHz

2.4GHz BLE (SHF)

BLE	Note	Frequency	Level	Margin	Limit	Read	Antenna	Path	Preamp	Ant	Table	Peak	Pol.
		(MHz)	(dBμV/m)	(dB)	(dBμV/m)	(dBμV)	(dB/m)	(dB)	(dB)	(cm)	(deg)	(P/A)	(H/V)
2.4GHz BLE SHF		24256	40.43	-33.57	74	58.03	38.62	-2.52	53.7	-	-	P	H
													H
													H
													H
													H
													H
													H
													H
													H
													H
													H
													H
													H
													H
													H
													H
													H
													H
													H
			24715	40.65	-33.35	74	57.23	39.24	-2.41	53.41	-	-	P
													V
													V
													V
													V
													V
													V
													V
													V
													V
													V
													V
													V
													V
													V
Remark	1. No other spurious found. 2. All results are PASS against limit line. 3. The emission position marked as "-" means no suspected emission found with sufficient margin against limit line or noise floor only.												



Emission below 1GHz

2.4GHz BLE (LF)

BLE	Note	Frequency	Level	Margin	Limit	Read	Antenna	Path	Preamp	Ant	Table	Peak	Pol.	
		(MHz)	(dBμV/m)	(dB)	(dBμV/m)	(dBμV)	(dB/m)	(dB)	(dB)	(cm)	(deg)	(P/A)	(H/V)	
2.4GHz BLE LF		30.54	22.97	-17.03	40	30.12	24.45	0.72	32.32	-	-	P	H	
		51.42	24.17	-15.83	40	41.59	14	0.94	32.36	-	-	P	H	
		88.68	23.13	-20.37	43.5	39.67	14.57	1.25	32.36	-	-	P	H	
		718.4	34.71	-11.29	46	37.58	26.21	3.2	32.28	-	-	P	H	
		838.4	30.79	-15.21	46	30.98	28.23	3.45	31.87	-	-	P	H	
		944	32.82	-13.18	46	30.86	29.28	3.74	31.06	-	-	P	H	
														H
														H
														H
														H
														H
														H
			46.92	26.15	-13.85	40	41.72	15.98	0.9	32.45	-	-	P	V
			51.42	33.78	-6.22	40	51.3	14	0.94	32.46	-	-	P	V
			112.26	24.54	-18.96	43.5	38.73	16.91	1.34	32.44	-	-	P	V
			708	31.92	-14.08	46	34.7	26.34	3.18	32.3	-	-	P	V
			842.4	31.09	-14.91	46	31.23	28.25	3.46	31.85	-	-	P	V
			900.8	34.18	-11.82	46	33.67	28.35	3.61	31.45	-	-	P	V
														V
														V
													V	
													V	
													V	

Remark

- No other spurious found.
- All results are PASS against limit line.
- The emission position marked as "-" means no suspected emission found and emission level has at least 6dB margin against limit or emission is noise floor only.



<Ant.4>

2.4GHz 2400~2483.5MHz

BLE (Band Edge @ 3m)

BLE	Note	Frequency	Level	Margin	Limit Line	Read Level	Antenna Factor	Path Loss	Preamp Factor	Ant Pos	Table Pos	Peak Avg.	Pol.	
		(MHz)	(dBμV/m)	(dB)	(dBμV/m)	(dBμV)	(dB/m)	(dB)	(dB)	(cm)	(deg)	(P/A)	(H/V)	
BLE CH02 2404MHz		2350.845	50.66	-23.34	74	44.38	27.3	15.47	36.49	100	325	P	H	
		2350.845	-4.43	-58.43	54	-	-	-	-	-	-	A	H	
	*	2404	111.7	-	-	105.22	27.42	15.54	36.48	100	325	P	H	
	*	2404	56.61	-	-	-	-	-	-	-	-	A	H	
													H	
													H	
			2331	50.5	-23.5	74	44.29	27.26	15.47	36.5	298	248	P	V
			2331	-4.59	-58.59	54	-	-	-	-	-	-	A	V
	*		2404	109.21	-	-	102.73	27.42	15.54	36.48	298	248	P	V
	*		2404	54.12	-	-	-	-	-	-	-	-	A	V
														V
														V
BLE CH 38 2440MHz		2370.62	50.03	-23.97	74	43.68	27.34	15.5	36.49	100	326	P	H	
		2370.62	-5.06	-59.06	54	-	-	-	-	-	-	A	H	
	*	2440	113.64	-	-	106.96	27.56	15.59	36.47	100	326	P	H	
	*	2440	58.55	-	-	-	-	-	-	-	-	A	H	
			2491.53	50.51	-23.49	74	43.55	27.77	15.65	36.46	100	326	P	H
			2491.53	-4.58	-58.58	54	-	-	-	-	-	-	A	H
			2314.06	50.03	-23.97	74	43.88	27.23	15.42	36.5	367	245	P	V
			2314.06	-5.06	-59.06	54	-	-	-	-	-	-	A	V
	*		2440	109.05	-	-	102.37	27.56	15.59	36.47	367	245	P	V
	*		2440	53.96	-	-	-	-	-	-	-	-	A	V
			2494.75	50.14	-23.86	74	43.17	27.78	15.65	36.46	367	245	P	V
			2494.75	-4.95	-58.95	54	-	-	-	-	-	-	A	V



BLE	Note	Frequency (MHz)	Level (dBμV/m)	Margin (dB)	Limit Line (dBμV/m)	Read Level (dBμV)	Antenna Factor (dB/m)	Path Loss (dB)	Preamp Factor (dB)	Ant Pos (cm)	Table Pos (deg)	Peak Avg. (P/A)	Pol. (H/V)	
BLE CH 76 2478MHz	*	2478	109.97	-	-	103.09	27.71	15.63	36.46	100	323	P	H	
	*	2478	54.88	-	-	-	-	-	-	-	-	A	H	
		2483.64	53.51	-20.49	74	46.6	27.73	15.64	36.46	100	323	P	H	
		2483.64	-1.58	-55.58	54	-	-	-	-	-	-	A	H	
													H	
													H	
	*	2478	103.13	-	-	96.25	27.71	15.63	36.46	400	323	P	V	
	*	2478	48.04	-	-	-	-	-	-	-	-	-	A	V
		2483.52	51.27	-22.73	74	44.36	27.73	15.64	36.46	400	323	P	V	
		2483.52	-3.82	-57.82	54	-	-	-	-	-	-	A	V	
													V	
													V	
	Remark	1. No other spurious found. 2. All results are PASS against Peak and Average limit line.												



2.4GHz 2400~2483.5MHz
BLE (Harmonic @ 3m)

BLE	Note	Frequency (MHz)	Level (dBμV/m)	Margin (dB)	Limit Line (dBμV/m)	Read Level (dBμV)	Antenna Factor (dB/m)	Path Loss (dB)	Preamp Factor (dB)	Ant Pos (cm)	Table Pos (deg)	Peak Avg. (P/A)	Pol. (H/V)
BLE CH 02 2404MHz		4808	37.29	-36.71	74	55.8	32.15	8.5	59.16	-	-	P	H
		4808	-17.8	-71.8	54	-	-	-	-	-	-	P	H
													H
													H
													H
													H
													H
													H
													H
													H
													H
													H
													H
													H
													H
													H
													H
													H
													H
			4808	37.27	-36.73	74	55.78	32.15	8.99	59.16	-	-	P
		4808	-17.82	-71.82	54	-	-	-	-	-	-	P	V
													V
													V
													V
													V
													V
													V
													V
													V
													V
													V
													V



BLE	Note	Frequency (MHz)	Level (dBμV/m)	Margin (dB)	Limit Line (dBμV/m)	Read Level (dBμV)	Antenna Factor (dB/m)	Path Loss (dB)	Preamp Factor (dB)	Ant Pos (cm)	Table Pos (deg)	Peak Avg. (P/A)	Pol. (H/V)	
BLE CH 38 2440MHz		4880	37.84	-36.16	74	55.89	32.58	8.56	59.19	-	-	P	H	
		4880	-17.25	-71.25	54	-	-	-	-	-	-	A	H	
		7320	43.65	-30.35	74	56.47	36.68	10.34	59.84	-	-	P	H	
		7320	-11.44	-65.44	54	-	-	-	-	-	-	A	H	
													H	
													H	
													H	
													H	
													H	
													H	
													H	
													H	
			4880	37.09	-36.91	74	55.14	32.58	8.56	59.19	-	-	P	V
			4880	-18	-72	54	-	-	-	-	-	-	A	V
			7320	43.01	-30.99	74	55.83	36.68	10.34	59.84	-	-	P	V
			7320	-12.08	-66.08	54	-	-	-	-	-	-	A	V
														V
														V
													V	
													V	
													V	
													V	



BLE	Note	Frequency (MHz)	Level (dB μ V/m)	Margin (dB)	Limit Line (dB μ V/m)	Read Level (dB μ V)	Antenna Factor (dB/m)	Path Loss (dB)	Preamp Factor (dB)	Ant Pos (cm)	Table Pos (deg)	Peak Avg. (P/A)	Pol. (H/V)	
BLE CH 76 2478MHz		4956	38.15	-35.85	74	55.76	32.98	8.63	59.22	-	-	P	H	
		4956	-16.94	-70.94	54	-	-	-	-	-	-	A	H	
		7434	42.15	-31.85	74	55.52	36.13	10.47	59.97	-	-	P	H	
		7434	-12.94	-66.94	54	-	-	-	-	-	-	A	H	
													H	
													H	
													H	
													H	
													H	
													H	
													H	
													H	
			4956	37.78	-36.22	74	55.39	32.98	8.63	59.22	-	-	P	V
			4956	-17.31	-71.31	54	-	-	-	-	-	-	A	V
			7434	43.61	-30.39	74	56.98	36.13	10.47	59.97	-	-	P	V
			7434	-11.48	-65.48	54	-	-	-	-	-	-	A	V
														V
														V
														V
														V
														V
														V
													V	
Remark	1. No other spurious found. 2. All results are PASS against Peak and Average limit line. 3. The emission position marked as "-" means no suspected emission found with sufficient margin against limit line or noise floor only.													



Emission above 18GHz

2.4GHz BLE(SHF)

BLE	Note	Frequency	Level	Margin	Limit	Read	Antenna	Path	Preamp	Ant	Table	Peak	Pol.
		(MHz)	(dBμV/m)	(dB)	(dBμV/m)	(dBμV)	(dB/m)	(dB)	(dB)	(cm)	(deg)	(P/A)	(H/V)
2.4GHz BLE SHF		24706.5	41.42	-32.58	74	57.98	39.27	-2.41	53.42	-	-	P	H
													H
													H
													H
													H
													H
													H
													H
													H
													H
													H
													H
													H
													H
													H
													H
													H
													H
													H
			24120	41.56	-32.44	74	59.19	38.76	-2.59	53.8	-	-	P
													V
													V
													V
													V
													V
													V
													V
													V
													V
													V
													V
													V
													V
Remark	1. No other spurious found. 2. All results are PASS against limit line. 3. The emission position marked as "-" means no suspected emission found with sufficient margin against limit line or noise floor only.												



Emission below 1GHz

2.4GHz BLE (LF)

BLE	Note	Frequency	Level	Margin	Limit	Read	Antenna	Path	Preamp	Ant	Table	Peak	Pol.	
		(MHz)	(dBμV/m)	(dB)	(dBμV/m)	(dBμV)	(dB/m)	(dB)	(dB)	(cm)	(deg)	(P/A)	(H/V)	
2.4GHz BLE LF		30	23.79	-16.21	40	30.75	24.64	0.72	32.32	-	-	P	H	
		51.24	24.09	-15.91	40	41.43	14.08	0.93	32.35	-	-	P	H	
		89.58	23.24	-20.26	43.5	39.67	14.67	1.26	32.36	-	-	P	H	
		718.4	34.49	-11.51	46	37.36	26.21	3.2	32.28	-	-	P	H	
		871.2	30.83	-15.17	46	30.64	28.32	3.53	31.66	-	-	P	H	
		960	32.93	-13.07	46	30.14	29.95	3.77	30.93	-	-	P	H	
														H
														H
														H
														H
														H
														H
			34.32	25.1	-14.9	40	34.03	22.73	0.75	32.41	-	-	P	V
			51.24	32.91	-7.09	40	50.36	14.08	0.93	32.46	-	-	P	V
			111.36	23.03	-20.47	43.5	37.25	16.88	1.34	32.44	-	-	P	V
			721.6	33.06	-12.94	46	35.76	26.37	3.21	32.28	-	-	P	V
			917.6	32	-14	46	31.11	28.53	3.66	31.3	-	-	P	V
			956	33.04	-12.96	46	30.48	29.76	3.76	30.96	-	-	P	V
														V
														V
													V	
													V	
													V	

Remark

- No other spurious found.
- All results are PASS against limit line.
- The emission position marked as "-" means no suspected emission found and emission level has at least 6dB margin against limit or emission is noise floor only.



<ASK 2Mbps>

<Ant.3>

2.4GHz 2400~2483.5MHz

BLE (Band Edge @ 3m)

BLE	Note	Frequency	Level	Margin	Limit Line	Read Level	Antenna Factor	Path Loss	Preamp Factor	Ant Pos	Table Pos	Peak Avg.	Pol.	
		(MHz)	(dBμV/m)	(dB)	(dBμV/m)	(dBμV)	(dB/m)	(dB)	(dB)	(cm)	(deg)	(P/A)	(H/V)	
BLE CH 02 2404MHz		2345.28	50.94	-23.06	74	44.67	27.29	15.47	36.49	100	311	P	H	
		2345.28	-4.15	-58.15	54	-	-	-	-	-	-	A	H	
	*	2404	107.8	-	-	101.32	27.42	15.54	36.48	100	311	P	H	
	*	2404	52.71	-	-	-	-	-	-	-	-	A	H	
													H	
														H
			2350.53	50.6	-23.4	74	44.32	27.3	15.47	36.49	338	316	P	V
			2350.53	-4.49	-58.49	54	-	-	-	-	-	-	A	V
	*	2404	111.05	-	-	-	104.57	27.42	15.54	36.48	338	316	P	V
	*	2404	55.96	-	-	-	-	-	-	-	-	-	A	V
														V
														V
BLE CH 38 2440MHz		2356.48	50.03	-23.97	74	43.73	27.31	15.48	36.49	156	226	P	H	
		2356.48	-5.06	-59.06	54	-	-	-	-	-	-	A	H	
	*	2440	112.25	-	-	105.57	27.56	15.59	36.47	156	226	P	H	
	*	2440	57.16	-	-	-	-	-	-	-	-	A	H	
			2488.73	50.61	-23.39	74	43.68	27.75	15.64	36.46	156	226	P	H
			2488.73	-4.48	-58.48	54	-	-	-	-	-	-	A	H
			2357.18	50.62	-23.38	74	44.32	27.31	15.48	36.49	100	273	P	V
			2357.18	-4.47	-58.47	54	-	-	-	-	-	-	A	V
	*	2440	112.46	-	-	-	105.78	27.56	15.59	36.47	100	273	P	V
	*	2440	57.37	-	-	-	-	-	-	-	-	-	A	V
			2492.79	50.83	-23.17	74	43.87	27.77	15.65	36.46	100	273	P	V
			2492.79	-4.26	-58.26	54	-	-	-	-	-	-	A	V



BLE	Note	Frequency (MHz)	Level (dBμV/m)	Margin (dB)	Limit Line (dBμV/m)	Read Level (dBμV)	Antenna Factor (dB/m)	Path Loss (dB)	Preamp Factor (dB)	Ant Pos (cm)	Table Pos (deg)	Peak Avg. (P/A)	Pol. (H/V)	
BLE CH 76 2478MHz	*	2478	111.5	-	-	104.62	27.71	15.63	36.46	100	299	P	H	
	*	2478	56.41	-	-	-	-	-	-	-	-	A	H	
		2483.72	55	-19	74	48.09	27.73	15.64	36.46	100	299	P	H	
		2483.72	-0.09	-54.09	54	-	-	-	-	-	-	A	H	
													H	
													H	
	*	2478	112.94	-	-	106.06	27.71	15.63	36.46	322	310	P	V	
	*	2478	57.85	-	-	-	-	-	-	-	-	-	A	V
		2483.76	55.79	-18.21	74	48.87	27.74	15.64	36.46	322	310	P	V	
		2483.76	0.7	-53.3	54	-	-	-	-	-	-	A	V	
													V	
													V	
	Remark	1. No other spurious found. 2. All results are PASS against Peak and Average limit line.												



2.4GHz 2400~2483.5MHz
BLE (Harmonic @ 3m)

BLE	Note	Frequency (MHz)	Level (dBμV/m)	Margin (dB)	Limit Line (dBμV/m)	Read Level (dBμV)	Antenna Factor (dB/m)	Path Loss (dB)	Preamp Factor (dB)	Ant Pos (cm)	Table Pos (deg)	Peak Avg. (P/A)	Pol. (H/V)
BLE CH 02 2404MHz		4808	37.68	-36.32	74	56.19	32.15	8.5	59.16	-	-	P	H
		4808	-17.41	-71.41	54	-	-	-	-	-	-	P	H
													H
													H
													H
													H
													H
													H
													H
													H
													H
													H
													H
													H
													H
													H
													H
													H
													H
			4808	36.87	-37.13	74	55.38	32.15	8.5	59.16	-	-	P
		4808	-18.22	-72.22	54	-	-	-	-	-	-	P	V
													V
													V
													V
													V
													V
													V
													V
													V
													V
													V
													V
													V
													V
													V



BLE	Note	Frequency (MHz)	Level (dBμV/m)	Margin (dB)	Limit Line (dBμV/m)	Read Level (dBμV)	Antenna Factor (dB/m)	Path Loss (dB)	Preamp Factor (dB)	Ant Pos (cm)	Table Pos (deg)	Peak Avg. (P/A)	Pol. (H/V)	
BLE CH 38 2440MHz		4880	38.64	-35.36	74	56.69	32.58	8.56	59.19	-	-	P	H	
		4880	-16.45	-70.45	54	-	-	-	-	-	-	A	H	
		7320	43.43	-30.57	74	56.25	36.68	10.34	59.84	-	-	P	H	
		7320	-11.66	-65.66	54	-	-	-	-	-	-	A	H	
													H	
													H	
													H	
													H	
													H	
													H	
													H	
													H	
			4880	37.6	-36.4	74	55.65	32.58	8.56	59.19	-	-	P	V
			4880	-17.49	-71.49	54	-	-	-	-	-	-	A	V
			7320	43.46	-30.54	74	56.28	36.68	10.34	59.84	-	-	P	V
			7320	-11.63	-65.63	54	-	-	-	-	-	-	A	V
														V
														V
														V
														V
													V	
													V	
													V	
													V	
													V	



BLE	Note	Frequency (MHz)	Level (dBμV/m)	Margin (dB)	Limit Line (dBμV/m)	Read Level (dBμV)	Antenna Factor (dB/m)	Path Loss (dB)	Preamp Factor (dB)	Ant Pos (cm)	Table Pos (deg)	Peak Avg. (P/A)	Pol. (H/V)	
BLE CH 76 2478MHz		4956	37.9	-36.1	74	55.51	32.98	8.63	59.22	-	-	P	H	
		4956	-17.19	-71.19	54	-	-	-	-	-	-	A	H	
		7434	42.26	-31.74	74	55.63	36.13	10.47	59.97	-	-	P	H	
		7434	-12.83	-66.83	54	-	-	-	-	-	-	A	H	
													H	
													H	
													H	
													H	
													H	
													H	
													H	
			4956	37.64	-36.36	74	55.25	32.98	8.63	59.22	-	-	P	V
			4956	-17.45	-71.45	54	-	-	-	-	-	-	A	V
			7434	42.08	-31.92	74	55.45	36.13	10.47	59.97	-	-	P	V
			7434	-13.01	-67.01	54	-	-	-	-	-	-	A	V
														V
														V
														V
														V
														V
													V	
Remark	1. No other spurious found. 2. All results are PASS against Peak and Average limit line. 3. The emission position marked as "-" means no suspected emission found with sufficient margin against limit line or noise floor only.													



<Ant.4>

2.4GHz 2400~2483.5MHz

BLE (Band Edge @ 3m)

BLE	Note	Frequency	Level	Margin	Limit Line	Read Level	Antenna Factor	Path Loss	Preamp Factor	Ant Pos	Table Pos	Peak Avg.	Pol.	
		(MHz)	(dBμV/m)	(dB)	(dBμV/m)	(dBμV)	(dB/m)	(dB)	(dB)	(cm)	(deg)	(P/A)	(H/V)	
BLE CH 02 2404MHz		2365.86	50.11	-23.89	74	43.78	27.33	15.49	36.49	100	319	P	H	
		2365.86	-4.98	-58.98	54	-	-	-	-	-	-	A	H	
	*	2404	115.65	-	-	109.17	27.42	15.54	36.48	100	319	P	H	
	*	2404	60.56	-	-	-	-	-	-	-	-	A	H	
													H	
													H	
			2352.525	50.49	-23.51	74	44.19	27.31	15.48	36.49	376	299	P	V
			2352.525	-4.6	-58.6	54	-	-	-	-	-	-	A	V
	*		2404	110.44	-	-	103.96	27.42	15.54	36.48	376	299	P	V
	*		2404	55.35	-	-	-	-	-	-	-	-	A	V
													V	
													V	
BLE CH 38 2440MHz		2352.98	50.25	-23.75	74	43.95	27.31	15.48	36.49	100	326	P	H	
		2352.98	-4.84	-58.84	54	-	-	-	-	-	-	A	H	
	*	2440	113.69	-	-	107.01	27.56	15.59	36.47	100	326	P	H	
	*	2440	58.6	-	-	-	-	-	-	-	-	A	H	
			2490.76	53.44	-20.56	74	46.5	27.76	15.64	36.46	100	326	P	H
			2490.76	-1.65	-55.65	54	-	-	-	-	-	-	A	H
			2317.84	49.66	-24.34	74	43.49	27.24	15.43	36.5	362	248	P	V
			2317.84	-5.43	-59.43	54	-	-	-	-	-	-	A	V
	*		2440	109.06	-	-	102.38	27.56	15.59	36.47	362	248	P	V
	*		2440	53.97	-	-	-	-	-	-	-	-	A	V
			2490.69	51.28	-22.72	74	44.34	27.76	15.64	36.46	362	248	P	V
			2490.69	-3.81	-57.81	54	-	-	-	-	-	-	A	V



BLE	Note	Frequency (MHz)	Level (dBμV/m)	Margin (dB)	Limit Line (dBμV/m)	Read Level (dBμV)	Antenna Factor (dB/m)	Path Loss (dB)	Preamp Factor (dB)	Ant Pos (cm)	Table Pos (deg)	Peak Avg. (P/A)	Pol. (H/V)	
BLE CH 76 2478MHz	*	2478	112.59	-	-	105.71	27.71	15.63	36.46	100	334	P	H	
	*	2478	57.5	-	-	-	-	-	-	-	-	A	H	
		2483.68	54.77	-19.23	74	47.86	27.73	15.64	36.46	100	334	P	H	
		2483.68	-0.32	-54.32	54	-	-	-	-	-	-	A	H	
													H	
													H	
	*	2478	110.13	-	-	103.25	27.71	15.63	36.46	400	294	P	V	
	*	2478	55.04	-	-	-	-	-	-	-	-	-	A	V
		2484.01	53.37	-20.63	74	46.45	27.74	15.64	36.46	400	294	P	V	
		2484.01	-1.72	-55.72	54	-	-	-	-	-	-	A	V	
													V	
													V	
Remark	1. No other spurious found. 2. All results are PASS against Peak and Average limit line.													



2.4GHz 2400~2483.5MHz
BLE (Harmonic @ 3m)

BLE	Note	Frequency (MHz)	Level (dBμV/m)	Margin (dB)	Limit Line (dBμV/m)	Read Level (dBμV)	Antenna Factor (dB/m)	Path Loss (dB)	Preamp Factor (dB)	Ant Pos (cm)	Table Pos (deg)	Peak Avg. (P/A)	Pol. (H/V)
BLE CH 02 2404MHz		4808	37.05	-36.95	74	55.56	32.15	8.5	59.16	-	-	P	H
		4808	-18.04	-72.04	54	-	-	-	-	-	-	P	H
													H
													H
													H
													H
													H
													H
													H
													H
													H
													H
													H
													H
													H
													H
													H
													H
													H
			4808	37.64	-36.36	74	56.15	32.15	8.5	59.16	-	-	P
		4808	-17.45	-71.45	54	-	-	-	-	-	-	P	V
													V
													V
													V
													V
													V
													V
													V
													V
													V
													V
													V
													V
													V
													V



BLE	Note	Frequency (MHz)	Level (dBμV/m)	Margin (dB)	Limit Line (dBμV/m)	Read Level (dBμV)	Antenna Factor (dB/m)	Path Loss (dB)	Preamp Factor (dB)	Ant Pos (cm)	Table Pos (deg)	Peak Avg. (P/A)	Pol. (H/V)	
BLE CH 38 2440MHz		4880	37.91	-36.09	74	55.96	32.58	8.56	59.19	-	-	P	H	
		4880	-17.18	-71.18	54	-	-	-	-	-	-	A	H	
		7320	43.98	-30.02	74	56.8	36.68	10.34	59.84	-	-	P	H	
		7320	-11.11	-65.11	54	-	-	-	-	-	-	A	H	
													H	
													H	
													H	
													H	
													H	
													H	
													H	
													H	
			4880	37.43	-36.57	74	55.48	32.58	8.56	59.19	-	-	P	V
			4880	-17.66	-71.66	54	-	-	-	-	-	-	A	V
			7320	43.92	-30.08	74	56.74	36.68	10.34	59.84	-	-	P	V
			7320	-11.17	-65.17	54	-	-	-	-	-	-	A	V
														V
														V
													V	
													V	
													V	
													V	



BLE	Note	Frequency (MHz)	Level (dBμV/m)	Margin (dB)	Limit Line (dBμV/m)	Read Level (dBμV)	Antenna Factor (dB/m)	Path Loss (dB)	Preamp Factor (dB)	Ant Pos (cm)	Table Pos (deg)	Peak Avg. (P/A)	Pol. (H/V)	
BLE CH 76 2478MHz		4956	38.05	-35.95	74	55.66	32.98	8.63	59.22	-	-	P	H	
		4956	-17.04	-71.04	54	-	-	-	-	-	-	A	H	
		7434	42.24	-31.76	74	55.61	36.13	10.47	59.97	-	-	P	H	
		7434	-12.85	-66.85	54	-	-	-	-	-	-	A	H	
													H	
													H	
													H	
													H	
													H	
													H	
													H	
													H	
			4956	37.59	-36.41	74	55.2	32.98	8.63	59.22	-	-	P	V
			4956	-17.5	-71.5	54	-	-	-	-	-	-	A	V
			7434	41.95	-32.05	74	55.32	36.13	10.47	59.97	-	-	P	V
			7434	-13.14	-67.14	54	-	-	-	-	-	-	A	V
														V
														V
													V	
													V	
													V	
													V	
													V	
Remark	1. No other spurious found. 2. All results are PASS against Peak and Average limit line. 3. The emission position marked as "-" means no suspected emission found with sufficient margin against limit line or noise floor only.													



Note symbol

*	Fundamental Frequency which can be ignored. However, the level of any unwanted emissions shall not exceed the level of the fundamental frequency.
!	Test result is over limit line.
P/A	Peak or Average
H/V	Horizontal or Vertical



A calculation example for radiated spurious emission is shown as below:

BLE	Note	Frequency	Level	Margin	Limit	Read	Antenna	Path	Preamp	Ant	Table	Peak	Pol.
		(MHz)	(dBμV/m)	(dB)	(dBμV/m)	(dBμV)	(dB/m)	(dB)	(dB)	(cm)	(deg)	(P/A)	(H/V)
BLE CH 00 2404MHz		2390	55.45	-18.55	74	54.51	32.22	4.58	35.86	103	308	P	H
		2390	43.54	-10.46	54	42.6	32.22	4.58	35.86	103	308	A	H

- Path Loss(dB) = Cable loss(dB) + Filter loss(dB) + Attenuator loss(dB)
- Level(dBμV/m) =
Antenna Factor(dB/m) + Path Loss(dB) + Read Level(dBμV) - Preamp Factor(dB)
- Over Limit(dB) = Level(dBμV/m) – Limit Line(dBμV/m)

For Peak Limit @ 2390MHz:

- Level(dBμV/m)
= Antenna Factor(dB/m) + Path Loss(dB) + Read Level(dBμV) - Preamp Factor(dB)
= 32.22(dB/m) + 4.58(dB) + 54.51(dBμV) – 35.86 (dB)
= 55.45 (dBμV/m)
- Over Limit(dB)
= Level(dBμV/m) – Limit Line(dBμV/m)
= 55.45(dBμV/m) – 74(dBμV/m)
= -18.55(dB)

For Average Limit @ 2390MHz:

- Level(dBμV/m)
= Antenna Factor(dB/m) + Path Loss(dB) + Read Level(dBμV) - Preamp Factor(dB)
= 32.22(dB/m) + 4.58(dB) + 42.6(dBμV) – 35.86 (dB)
= 43.54 (dBμV/m)
- Over Limit(dB)
= Level(dBμV/m) – Limit Line(dBμV/m)
= 43.54(dBμV/m) – 54(dBμV/m)
= -10.46(dB)

Both peak and average measured complies with the limit line, so test result is "PASS".



Appendix D. Radiated Spurious Emission Plots

Test Engineer :	Daniel Lee, Quentin Liu and Bigshow Wang	Temperature :	22.1~22.6°C
		Relative Humidity :	55~57%

Note symbol

-L	Low channel location
-R	High channel location



<1Mbps>

2.4GHz 2400~2483.5MHz

BLE (Band Edge @ 3m)

BLE	2.4GHz 2400~2483.5MHz Band Edge @ 3m	
ANT	BLE CH02 2404MHz	
3	Horizontal	Fundamental
Peak	<p>Site : 03CH15-HY Condition : PEAK_BE 74 3m 91200_02294_230630 HORIZONTAL : RBW:1000.000kHz VBW:3000.000kHz SWT:Auto</p>	<p>Site : 03CH15-HY Condition : PEAK_74 3m 91200_02294_230630 HORIZONTAL : RBW:1000.000kHz VBW:3000.000kHz SWT:Auto</p>



BLE	2.4GHz 2400~2483.5MHz Band Edge @ 3m	
ANT	BLE CH02 2404MHz	
3	Vertical	Fundamental
Peak	<p>Site : 03CH15-HY Condition : PEAK_06_74 3m 91200_02294_230630 VERTICAL : RBW:1000.000kHz VBW:3000.000kHz SWT:Auto</p>	<p>Site : 03CH15-HY Condition : PEAK_74 3m 91200_02294_230630 VERTICAL : RBW:1000.000kHz VBW:3000.000kHz SWT:Auto</p>



BLE	2.4GHz 2400~2483.5MHz Band Edge @ 3m	
ANT	BLE CH38 2440MHz	
3	Horizontal	Fundamental
Peak	<p>Date: 2024-03-25</p> <p>Site : 03CH15-HY Condition : PEAK_BE_74 3m 91200_02294_230630 HORIZONTAL : RBW:1000.000kHz VBW:3000.000kHz SWT:Auto</p>	<p>Date: 2024-03-25</p> <p>Site : 03CH15-HY Condition : PEAK_74 3m 91200_02294_230630 HORIZONTAL : RBW:1000.000kHz VBW:3000.000kHz SWT:Auto</p>
Peak	<p>Date: 2024-03-25</p> <p>Site : 03CH15-HY Condition : PEAK_BE_74 3m 91200_02294_230630 HORIZONTAL : RBW:1000.000kHz VBW:3000.000kHz SWT:Auto</p>	Left blank

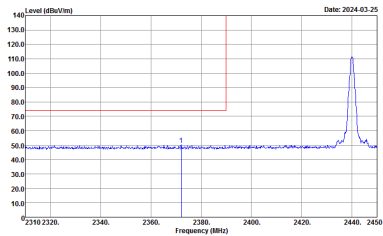
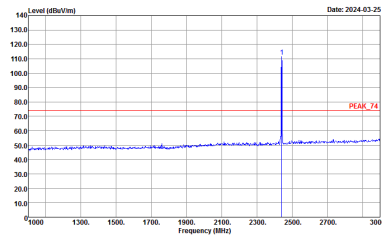
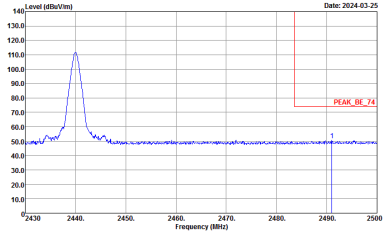

BLE	2.4GHz 2400~2483.5MHz Band Edge @ 3m	
ANT	BLE CH38 2440MHz	
3	Vertical	Fundamental
Peak	 <p>Date: 2024-03-25</p> <p>Site : 03CH15-HY Condition : PEAK_BE_74 3m 91200_02294_230630 VERTICAL : RBW:1000.000KHz VBW:3000.000KHz SWT:Auto</p>	 <p>Date: 2024-03-25</p> <p>Site : 03CH15-HY Condition : PEAK_74 3m 91200_02294_230630 VERTICAL : RBW:1000.000KHz VBW:3000.000KHz SWT:Auto</p>
Peak	 <p>Date: 2024-03-25</p> <p>Site : 03CH15-HY Condition : PEAK_BE_74 3m 91200_02294_230630 VERTICAL : RBW:1000.000KHz VBW:3000.000KHz SWT:Auto</p>	Left blank

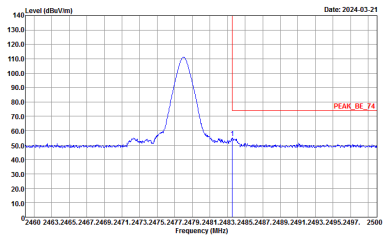
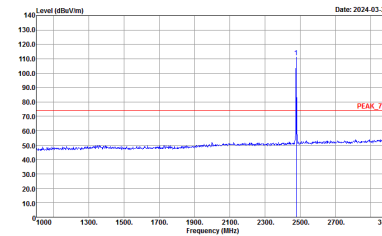

BLE	2.4GHz 2400~2483.5MHz Band Edge @ 3m	
ANT	BLE CH76 2478MHz	
3	Horizontal	Fundamental
Peak	 <p>Site : 03CH15-HY Condition : :PEAK_BC_74 3m 91200_02294_230630 HORIZONTAL :RBW:1000.000KHz VBW:3000.000KHz SWT:Auto</p>	 <p>Site : 03CH15-HY Condition : :PEAK_74 3m 91200_02294_230630 HORIZONTAL :RBW:1000.000KHz VBW:3000.000KHz SWT:Auto</p>

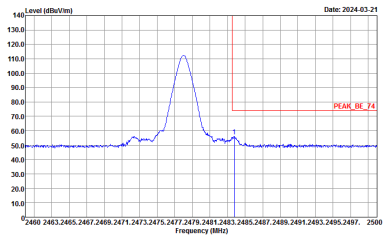
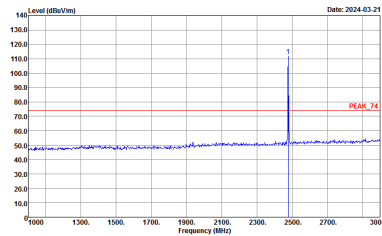

BLE	2.4GHz 2400~2483.5MHz Band Edge @ 3m	
ANT	BLE CH76 2478MHz	
3	Vertical	Fundamental
Peak	 <p>Date: 2024-03-21</p> <p>Site : 03CH15-HY Condition : PEAK_BC_74 3m 91200_02294_230630 VERTICAL : RBW:1000.000KHz VBW:3000.000KHz SWT:Auto</p>	 <p>Date: 2024-03-21</p> <p>Site : 03CH15-HY Condition : PEAK_74 3m 91200_02294_230630 VERTICAL : RBW:1000.000KHz VBW:3000.000KHz SWT:Auto</p>



2.4GHz 2400~2483.5MHz

BLE (Harmonic @ 3m)

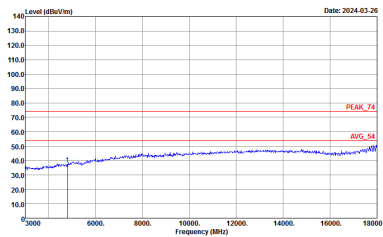
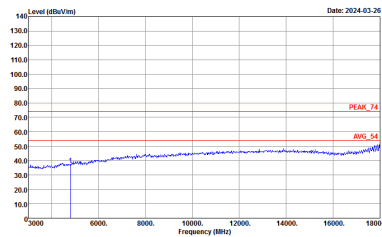
BLE	2.4GHz 2400~2483.5MHz Harmonic @ 3m	
ANT	BT CH02 2404MHz	
3	Horizontal	Vertical
Peak Avg.	 <p>Site : 03CH15-HY Condition : PEAK_74 3m 91200_02294_230630 HORIZONTAL</p>	 <p>Site : 03CH15-HY Condition : PEAK_74 3m 91200_02294_230630 VERTICAL</p>



BLE	2.4GHz 2400~2483.5MHz Harmonic @ 3m	
ANT	BLE CH02 2404MHz	
3	Horizontal	Vertical
<p>14.47G ~14.5G Avg.</p>	<p>Date: 2024-03-26</p> <p>Site : 03CH15-HY Condition : AV6_54 3m 91200_02294_230630 HORIZONTAL</p>	<p>Date: 2024-03-26</p> <p>Site : 03CH15-HY Condition : AV6_54 3m 91200_02294_230630 VERTICAL</p>
<p>17.7G ~18G Avg.</p>	<p>Date: 2024-03-26</p> <p>Site : 03CH15-HY Condition : AV6_54 3m 91200_02294_230630 HORIZONTAL</p>	<p>Date: 2024-03-26</p> <p>Site : 03CH15-HY Condition : AV6_54 3m 91200_02294_230630 VERTICAL</p>



BLE	2.4GHz 2400~2483.5MHz Harmonic @ 3m	
ANT	BLE CH38 2440MHz	
3	Horizontal	Vertical
Peak Avg.	<p>Site : 03CH15-HY Condition : PEAK_74 3m 91200_02294_230630 HORIZONTAL</p>	<p>Site : 03CH15-HY Condition : PEAK_74 3m 91200_02294_230630 VERTICAL</p>

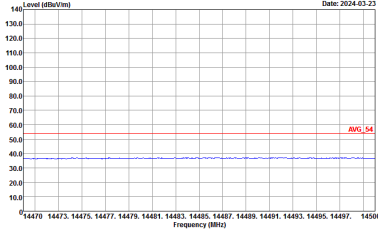
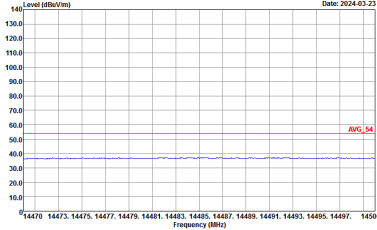
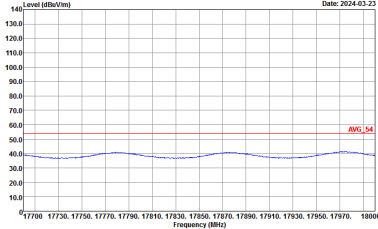
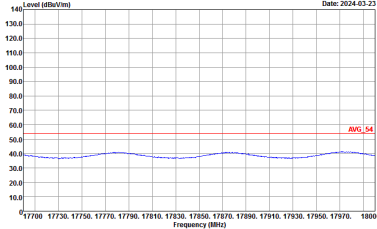

BLE	2.4GHz 2400~2483.5MHz Harmonic @ 3m	
ANT	BLE CH38 2440MHz	
3	Horizontal	Vertical
<p>14.47G ~14.5G Avg.</p>	 <p>Date: 2024-03-23</p> <p>Site : 03CH15-HY Condition : AV6_54 3m 91200_02294_230630 HORIZONTAL</p>	 <p>Date: 2024-03-23</p> <p>Site : 03CH15-HY Condition : AV6_54 3m 91200_02294_230630 VERTICAL</p>
<p>17.7G ~18G Avg.</p>	 <p>Date: 2024-03-23</p> <p>Site : 03CH15-HY Condition : AV6_54 3m 91200_02294_230630 HORIZONTAL</p>	 <p>Date: 2024-03-23</p> <p>Site : 03CH15-HY Condition : AV6_54 3m 91200_02294_230630 VERTICAL</p>

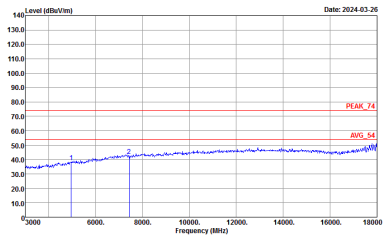
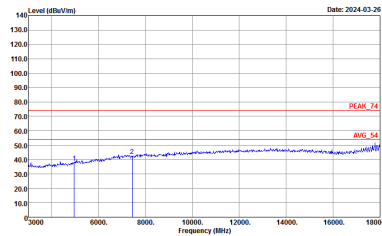

BLE	2.4GHz 2400~2483.5MHz Harmonic @ 3m	
ANT	BLE CH76 2478MHz	
3	Horizontal	Vertical
<p>Peak Avg.</p>	 <p>Site : 03CH15-HY Condition : PEAK_74 3m 91200_02294_230630 HORIZONTAL</p>	 <p>Site : 03CH15-HY Condition : PEAK_74 3m 91200_02294_230630 VERTICAL</p>