



# FCC RADIO TEST REPORT

**FCC ID** : A4RGR83Y  
**Equipment** : Phone  
**Model Name** : GR83Y  
**Applicant** : Google LLC  
1600 Amphitheatre Parkway,  
Mountain View, California, 94043 USA  
**Standard** : FCC Part 15 Subpart C §15.209

The product was received on Nov. 28, 2023 and testing was performed from Jan. 19, 2024 to May 03, 2024. We, Sporton International Inc. EMC & Wireless Communications Laboratory, would like to declare that the tested sample has been evaluated in accordance with the test procedures and has been in compliance with the applicable technical standards.

The test results in this report apply exclusively to the tested model / sample. Without written approval from Sporton International Inc. EMC & Wireless Communications Laboratory, the test report shall not be reproduced except in full.

Approved by: Louis Wu

**Sporton International Inc. EMC & Wireless Communications Laboratory**  
No. 52, Huaya 1st Rd., Guishan Dist., Taoyuan City 333, Taiwan (R.O.C.)



# Table of Contents

**History of this test report..... 3**

**Summary of Test Result..... 4**

**1. General Description ..... 5**

    1.1 Product Feature of Equipment Under Test ..... 5

    1.2 Modification of EUT ..... 5

    1.3 Testing Location ..... 5

    1.4 Applicable Standards..... 6

**2. Test Configuration of Equipment Under Test..... 7**

    2.1 Descriptions of Test Mode ..... 7

    2.2 Connection Diagram of Test System ..... 7

    2.3 Support Unit used in test configuration and system ..... 8

    2.4 EUT Operation Test Setup ..... 8

**3. Test Results ..... 9**

    3.1 AC Power Line Conducted Emissions Measurement ..... 9

    3.2 20dB and 99% OBW Spectrum Bandwidth Measurement..... 11

    3.3 Radiated Emissions Measurement ..... 12

    3.4 Antenna Requirements..... 15

**4. List of Measuring Equipment ..... 16**

**5. Measurement Uncertainty..... 17**

**Appendix A. Test Results of Conducted Emission Test**

**Appendix B. Test Results of RF Near Field Test Items**

**Appendix C. Test Results of Radiated Test Items**

    C2. Results of Radiated Emissions (9 kHz~30MHz)

    C3. Results of Radiated Emissions (30MHz~1GHz)

**Appendix D. Setup Photographs**





### Summary of Test Result

Report Clause	Ref Std. Clause	Test Items	Result (PASS/FAIL)	Remark
3.1	15.207	AC Power Line Conducted Emissions	Pass	12.53 dB under the limit at 0.49MHz
3.2	15.215(c)	20dB Spectrum Bandwidth	Reporting only	-
	2.1049	99% OBW Spectrum Bandwidth	Reporting only	-
3.3	15.209	Field Strength of Fundamental Emissions	Pass	Max level -13.87 dB $\mu$ V/m at 0.145 MHz
		Radiated Spurious Emissions	Pass	10.68 dB under the limit at 30.00MHz
3.4	15.203	Antenna Requirements	Pass	-

<b>Conformity Assessment Condition:</b>
1. The test results (PASS/FAIL) with all measurement uncertainty excluded are presented against the regulation limits or in accordance with the requirements stipulated by the applicant/manufacture who shall bear all the risks of non-compliance that may potentially occur if measurement uncertainty is taken into account.
2. The measurement uncertainty please refer to each test result in the section "Measurement Uncertainty".
<b>Disclaimer:</b>
The product specifications of the EUT presented in the test report that may affect the test assessments are declared by the manufacturer who shall take full responsibility for the authenticity.

Reviewed by: William Chen

Report Producer: Lucy Wu



# 1. General Description

## 1.1 Product Feature of Equipment Under Test

Product Feature
<p><b>General Specs</b> GSM/WCDMA/LTE/5G NR, Bluetooth, BLE, BLE channel sounding, Thread, Wi-Fi 802.11be, UWB, NFC, WPT, NTN and GNSS.</p> <p><b>Antenna Type</b> WPT: Coil Antenna</p>

**Remark:** The above EUT's information was declared by manufacturer. Please refer to Disclaimer in report summary.

EUT Information List	
S/N	Performed Test Item
3B131FDAP0006Y	Conducted Emission
3B131FDAP0006Y	Radiated Spurious Emission
3B131FDAP0006F	RF Near Field

## 1.2 Modification of EUT

No modifications are made to the EUT during all test items.

## 1.3 Testing Location

<b>Test Site</b>	Sporton International Inc. EMC & Wireless Communications Laboratory		
<b>Test Site Location</b>	No.52, Huaya 1st Rd., Guishan Dist., Taoyuan City 333, Taiwan (R.O.C.) TEL: +886-3-327-3456 FAX: +886-3-328-4978		
<b>Test Site No.</b>	<b>Sporton Site No.</b>		
	TH03-HY	CO05-HY	03CH07-HY
<b>Test Engineer</b>	Eric Wu	Tom Lee	Jesse Wang, Stan Hsieh and Ken Wu
<b>Temperature (°C)</b>	20.7~22.7	23~26	22.1~24.5
<b>Relative Humidity (%)</b>	46.4~48.4	45~55	56.5~63.5

Note: The test site complies with ANSI C63.4 2014 requirement.

FCC designation No.: TW1190



## **1.4 Applicable Standards**

According to the specifications of the manufacturer, the EUT must comply with the requirements of the following standards:

- ♦ FCC Part 15 Subpart C §15.209
- ♦ FCC KDB 414788 D01 Radiated Test Site v01r01
- ♦ ANSI C63.10-2013

**Remark:**

1. All the test items were validated and recorded in accordance with the standards without any modification during the testing.
2. The TAF code is not including all the FCC KDB listed without accreditation.

## 2. Test Configuration of Equipment Under Test

### 2.1 Descriptions of Test Mode

Investigation has been done on all the possible configurations.

The following table is a list of the test modes shown in this test report.

Test Items	
AC Power Line Conducted Emissions	20dB Spectrum Bandwidth
Field Strength of Fundamental Emissions	
Radiated Emissions 9kHz~30MHz	Radiated Emissions 30MHz~1GHz

The measured emission level of the EUT was maximized by rotating the EUT on a turntable, adjusting the orientation of the EUT and EUT antenna in three orthogonal axis (X: flat, Y: portrait, Z: landscape), Accessory (Adapter or Earphone) and three receiving antenna orientations (parallel, perpendicular, and ground-parallel) for Loop Antenna, and adjusting the measurement antenna orientation, following C63.10 exploratory test procedures and find X Plane with Adapter as worst plane.

Test Cases	
<b>AC Conducted Emission</b>	Mode 1 : WPT Charging with Charging Pad + USB Cable (Charging from AC Adapter 1)
<b>Remark:</b> For Radiated Test Cases, the tests were performed with Adapter 1 and USB Cable 2.	

### 2.2 Connection Diagram of Test System

<AC Conducted Emission Mode>

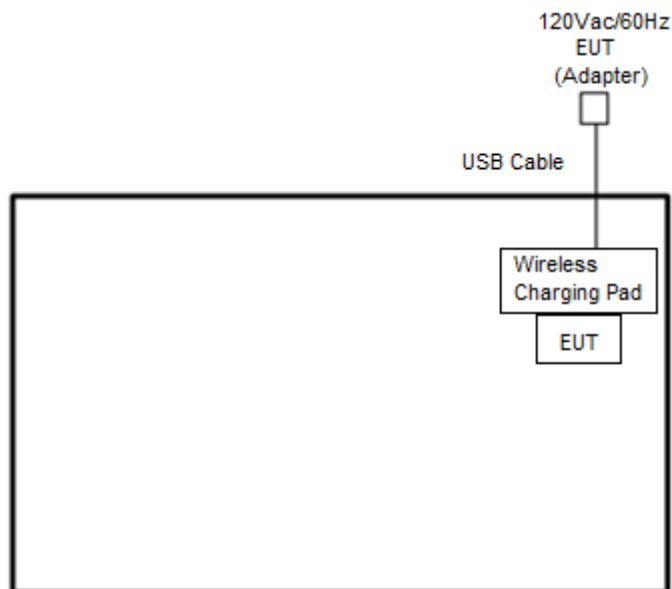

<WPT Mode with Adapter Mode>

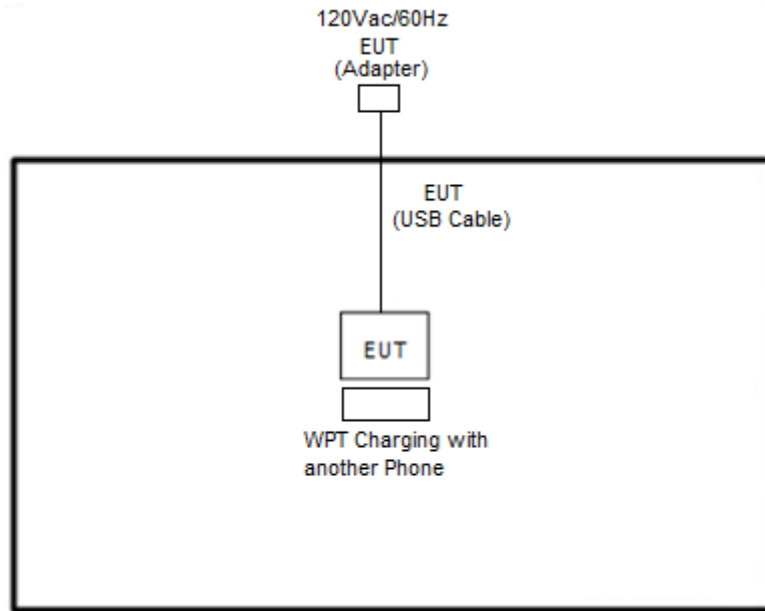

**2.3 Support Unit used in test configuration and system**

Item	Equipment	Brand Name	Model Name	FCC ID	Data Cable	Power Cord
1.	Wireless Charging Pad	Google	G454V	NA	N/A	N/A
2.	USB Cable	Google	NA	NA	N/A	Unshielded, 1.5m
3.	Phone	Google	GR83Y	N/A	N/A	N/A

**2.4 EUT Operation Test Setup**

The Wireless Charging with Wireless Charging Pad or another Phone via wireless power transfer function.





### 3. Test Results

#### 3.1 AC Power Line Conducted Emissions Measurement

##### 3.1.1 Limit of AC Conducted Emission

For equipment that is designed to be connected to the public utility (AC) power line, the radio frequency voltage that is conducted back onto the AC power line on any frequency or frequencies within the band 150 kHz to 30 MHz shall not exceed the limits in the following table.

Frequency of Emission (MHz)	Conducted Limit (dB $\mu$ V)	
	Quasi-Peak	Average
0.15-0.5	66 to 56*	56 to 46*
0.5-5	56	46
5-30	60	50

\*Decreases with the logarithm of the frequency.

##### 3.1.2 Measuring Instruments

See list of measuring equipment of this test report.

##### 3.1.3 Test Procedures

1. The EUT was placed 0.4 meter from the conducting wall of the shielding room, and it was kept at least 80 centimeters from any other grounded conducting surface.
2. Connect EUT to the power mains through a line impedance stabilization network (LISN).
3. All the support units are connecting to the other LISN.
4. The LISN provides 50 ohm coupling impedance for the measuring instrument.
5. The FCC states that a 50 ohm, 50 microhenry LISN should be used.
6. Both sides of AC line were checked for maximum conducted interference.
7. The frequency range from 150 kHz to 30 MHz was searched.
8. Set the test-receiver system to Peak Detect Function and specified bandwidth (IF Bandwidth = 9kHz) with Maximum Hold Mode. Then measurement is also conducted by Average Detector and Quasi-Peak Detector Function respectively.

### 3.1.4 Test setup

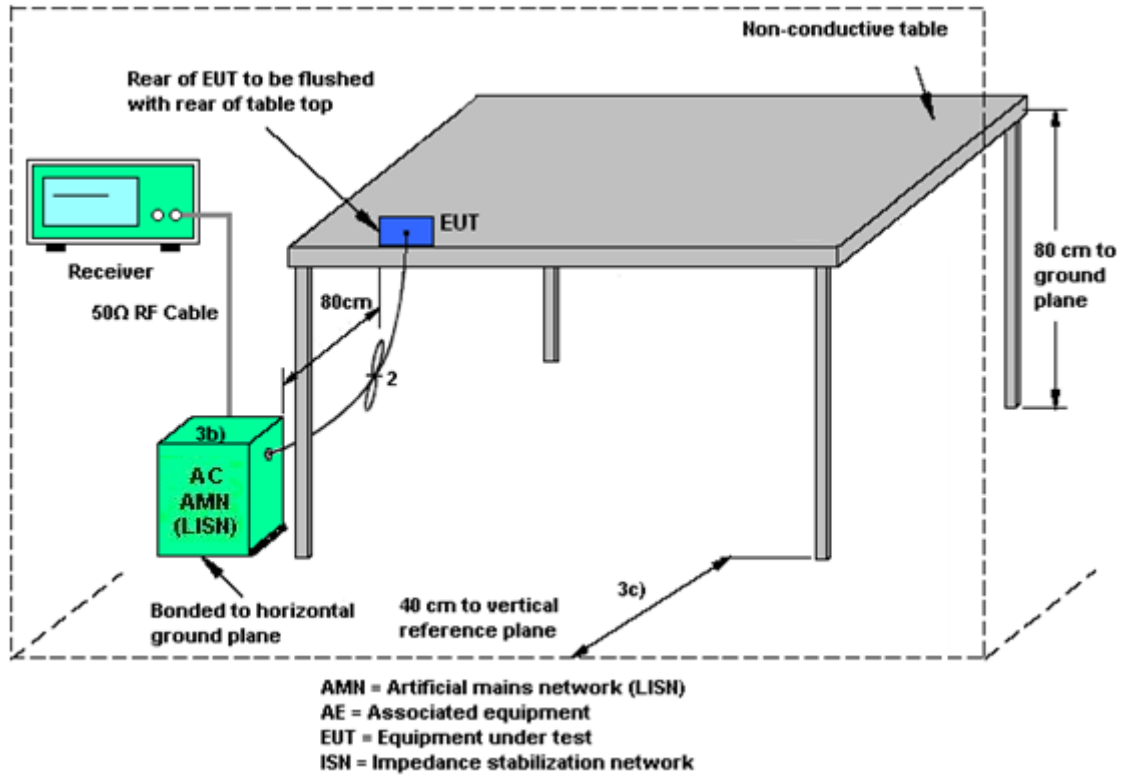

### 3.1.5 Test Result of AC Conducted Emission

Please refer to Appendix A.

## 3.2 20dB and 99% OBW Spectrum Bandwidth Measurement

### 3.2.1 Limit

Reporting only

### 3.2.2 Measuring Instruments

See list of measuring instruments of this test report.

### 3.2.3 Test Procedures

1. The spectrum analyzer connected via a receive antenna placed near the EUT in peak Max hold mode.
2. The resolution bandwidth of 300 Hz and the video bandwidth of 1 kHz were used.
3. Measured the spectrum width with power higher than 20dB below carrier.
4. Measured the 99% OBW.

### 3.2.4 Test Setup

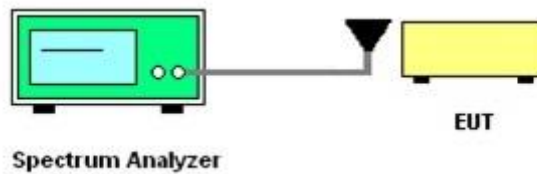

### 3.2.5 Test Result of RF Near Field Test Items

Please refer to Appendix B.

### 3.3 Radiated Emissions Measurement

#### 3.3.1 Limit

The field strength of any emissions which appear band shall not exceed the general radiated emissions limits.

Frequencies (MHz)	Field Strength ( $\mu\text{V/m}$ )	Measurement Distance (meters)
0.009~0.490	2400/F(kHz)	300
0.490~1.705	24000/F(kHz)	30
1.705~30.0	30	30
30~88	100	3
88~216	150	3
216~960	200	3
Above 960	500	3

#### 3.3.2 Measuring Instruments

See list of measuring instruments of this test report.

#### 3.3.3 Measuring Instrument Setting

The following table is the setting of receiver:

Receiver Parameter	Setting
Attenuation	Auto
Frequency Range: 9kHz~150kHz	RBW 200Hz for QP
Frequency Range: 150kHz~30MHz	RBW 9kHz for QP
Frequency Range: 30MHz~1000MHz	RBW 120kHz for Peak

**Note:** The emission limits shown in the above table are based on measurements employing a CISPR quasi-peak detector except for the frequency bands 9-90 kHz and 110-490 kHz. Radiated emission limits in these two bands are based on measurements employing an average detector.



### 3.3.4 Test Procedures

1. Configure the EUT according to ANSI C63.10. The EUT was placed on the top of the turntable 0.8 meter above ground. The phase center of the receiving antenna mounted on the top of a height-variable antenna tower was placed 3 meters far away from the turntable.
2. Power on the EUT and all the supporting units. The turntable was rotated by 360 degrees to determine the position of the highest radiation.
3. The height of the broadband receiving antenna was varied between one meter and four meters above ground to find the maximum emissions field strength of both horizontal and vertical polarization.
4. For each suspected emissions, the antenna tower was scan (from 1 M to 4 M) and then the turntable was rotated (from 0 degree to 360 degrees) to find the maximum reading.
5. Set the test-receiver system to Peak or CISPR quasi-peak Detect Function with specified bandwidth under Maximum Hold Mode.
6. When the radiated emissions limits are expressed in terms of the average value of the emissions, and pulsed operation is employed, the measurement field strength shall be determined by averaging over one complete pulse train, including blanking intervals, as long as the pulse train does not exceed 0.1 seconds. As an alternative (provided the transmitter operates for longer than 0.1 seconds) or in cases where the pulse train exceeds 0.1 seconds, the measured field strength shall be determined from the average absolute voltage during a 0.1 second interval during which the field strength is at its maximum value.
7. In case the emission is lower than 30MHz, loop antenna has to be used for measurement and the recorded data should be QP measured by receiver.
8. Radiated testing below 1 GHz is performed by adjusting the antenna tower from 1 m to 4 m and by rotating the turn table from 0 degree to 360 degrees to find the peak maximum hold reading. When there is no suspected emission found and the emission level is with at least 6 dB margin against QP limit line, the position is marked as “-“.

### 3.3.5 Test Setup

For radiated emissions below 30MHz

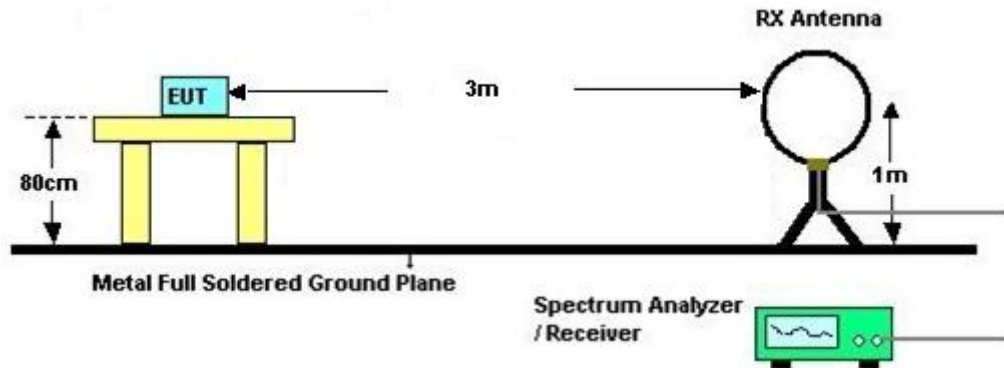

For radiated emissions above 30MHz

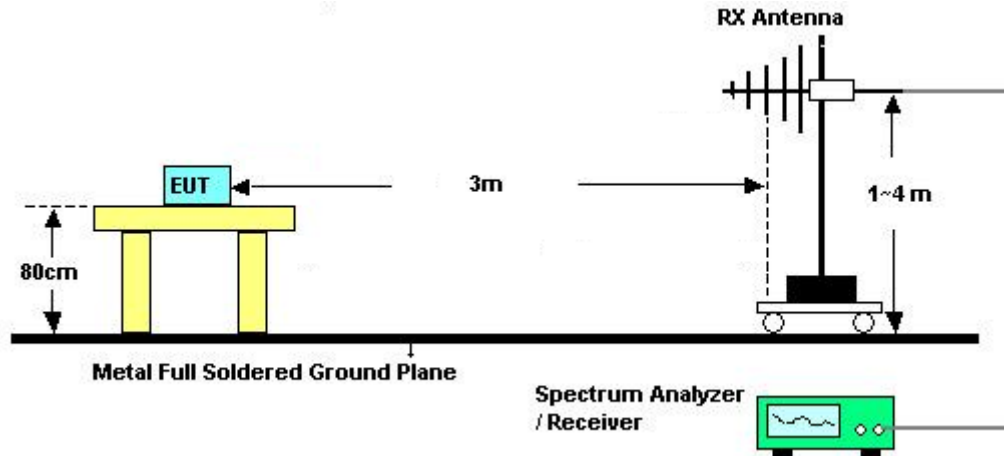

### 3.3.6 Test Result of Radiated Emissions Measurement

Please refer to Appendix C.

**Remark:**

1. There is adequate comparison measurement of both open-field test site and alternative test site - semi-Anechoic chamber according to 414788 D01 Radiated Test Site v01r01, and the result came out very similar.
2. According to C63.10 radiated test, the EUT pre-scanned horizontal, vertical, and ground-parallel three polarization's, the worst case is horizontal & vertical polarization, test data of two mode was reported.



## **3.4 Antenna Requirements**

### **3.4.1 Standard Applicable**

Except for special regulations, the Low-power Radio-frequency Devices must not be equipped with any jacket for installing an antenna with extension cable. An intentional radiator shall be designed to ensure that no antenna other than that furnished by the responsible party shall be used with the device. The use of a permanently attached antenna or of an antenna that uses a unique coupling to the intentional radiator shall be considered sufficient to comply with the provisions of this Section. The manufacturer may design the unit so that the user can replace a broken antenna, but the use of a standard antenna jack or electrical connector is prohibited.

The use of a permanently attached antenna or of an antenna that uses a unique coupling to the intentional radiator shall be considered sufficient to comply with the rule.

### **3.4.2 Antenna Anti-Replacement Construction**

An embedded-in antenna design is used.



### 4. List of Measuring Equipment

Instrument	Brand Name	Model No.	Serial No.	Characteristics	Calibration Date	Test Date	Due Date	Remark
Hygrometer	TECEPEL	DTM-303A	TP201996	N/A	Nov. 07, 2023	Feb. 05, 2024	Nov. 06, 2024	Near Field (TH03-HY)
Spectrum Analyzer	Rohde & Schwarz	FSP30	101329	9kHz~30GHz	Sep. 20, 2023	Feb. 05, 2024	Sep. 19, 2024	Near Field (TH03-HY)
AC Power Source	ChainTek	APC-1000W	N/A	N/A	N/A	Mar. 27, 2024	N/A	Conduction (CO05-HY)
EMI Test Receiver	Rohde & Schwarz	ESR3	102388	9kHz~3.6GHz	Dec. 06, 2023	Mar. 27, 2024	Dec. 05, 2024	Conduction (CO05-HY)
Hygrometer	Testo	608-H1	34913912	N/A	Oct. 26, 2023	Mar. 27, 2024	Oct. 25, 2024	Conduction (CO05-HY)
LISN	Rohde & Schwarz	ENV216	100081	9kHz~30MHz	Nov. 22, 2023	Mar. 27, 2024	Nov. 21, 2024	Conduction (CO05-HY)
Software	Rohde & Schwarz	EMC32	N/A	N/A	N/A	Mar. 27, 2024	N/A	Conduction (CO05-HY)
Pulse Limiter	SCHWARZBECK	VTSD 9561-F N	00691	N/A	Jul. 28, 2023	Mar. 27, 2024	Jul. 27, 2024	Conduction (CO05-HY)
LISN Cable	MVE	RG-400	260260	N/A	Dec. 28, 2023	Mar. 27, 2024	Dec. 27, 2024	Conduction (CO05-HY)
EMI Test Receiver	Rohde & Schwarz	ESU26	100472	20Hz~26.5GHz	Feb. 13, 2023	Jan. 19, 2024~Jan. 31, 2024	Feb. 12, 2024	Radiation (03CH07-HY)
EMI Test Receiver	Rohde & Schwarz	ESU26	100472	20Hz~26.5GHz	Feb. 01, 2024	Feb. 01, 2024~May 03, 2024	Jan. 31, 2025	Radiation (03CH07-HY)
Bilog Antenna	TESEQ	CBL 6111D & 00800N1D01N-06	35419 & 03	30MHz~1GHz	Apr. 23, 2023	Jan. 19, 2024~Apr. 21, 2024	Apr. 22, 2024	Radiation (03CH07-HY)
Bilog Antenna	TESEQ	CBL 6111D & 00800N1D01N-06	35419 & 03	30MHz~1GHz	Apr. 22, 2024	Apr. 22, 2024~May 03, 2024	Apr. 21, 2025	Radiation (03CH07-HY)
Loop Antenna	Rohde & Schwarz	HFH2-Z2	100315	9 kHz~30 MHz	Feb. 28, 2023	Jan. 19, 2024~Feb. 22, 2024	Feb. 27, 2024	Radiation (03CH07-HY)
Loop Antenna	Rohde & Schwarz	HFH2-Z2	100315	9 kHz~30 MHz	Feb. 23, 2024	Feb. 23, 2024~May 03, 2024	Feb. 22, 2025	Radiation (03CH07-HY)
Preamplifier	COM-POWER	PA-103A	161241	10MHz~1GHz	Oct. 02, 2023	Jan. 19, 2024~May 03, 2024	Oct. 01, 2024	Radiation (03CH07-HY)
RF Cable	HUBER + SUHNER	SUCOFLEX 104	MY15682/4	30MHz to 18GHz	Feb. 22, 2023	Jan. 19, 2024~Feb. 20, 2024	Feb. 21, 2024	Radiation (03CH07-HY)
RF Cable	HUBER + SUHNER	SUCOFLEX 104	MY28655/4 MY24971/4 MY15682/4	30MHz to 18GHz	Feb. 21, 2024	Feb. 21, 2024~May 03, 2024	Feb. 20, 2025	Radiation (03CH07-HY)
RF Cable	HUBER + SUHNER	SUCOFLEX 104	MY24971/4	9kHz to 18GHz	Feb. 22, 2023	Jan. 19, 2024~Feb. 20, 2024	Feb. 21, 2024	Radiation (03CH07-HY)
RF Cable	HUBER + SUHNER	SUCOFLEX 104	MY28655/4	9kHz to 18GHz	Feb. 22, 2023	Jan. 19, 2024~Feb. 20, 2024	Feb. 21, 2024	Radiation (03CH07-HY)
RF Cable	HUBER + SUHNER	SUCOFLEX 104	MY28655/4 MY24971/4	9kHz to 30MHz	Feb. 21, 2024	Feb. 21, 2024~May 03, 2024	Feb. 20, 2025	Radiation (03CH07-HY)
USB Data Logger	TECEPEL	TR-32	HE17XB2495	N/A	Mar. 14, 2023	Jan. 19, 2024~Feb. 28, 2024	Mar. 13, 2024	Radiation (03CH07-HY)
USB Data Logger	TECEPEL	TR-32	HE17XB2495	N/A	Mar. 01, 2024	Mar. 01, 2024~May 03, 2024	Feb. 28, 2025	Radiation (03CH07-HY)
Controller	EMEC	EM1000	N/A	Control Ant Mast	N/A	Jan. 19, 2024~May 03, 2024	N/A	Radiation (03CH07-HY)
Controller	MF	MF-7802	N/A	Control Turn table	N/A	Jan. 19, 2024~May 03, 2024	N/A	Radiation (03CH07-HY)
Antenna Mast	EMEC	AM-BS-4500E	N/A	Boresight mast 1M~4M	N/A	Jan. 19, 2024~May 03, 2024	N/A	Radiation (03CH07-HY)
Turn Table	ChainTek	Chaintek 3000	N/A	0~360 Degree	N/A	Jan. 19, 2024~May 03, 2024	N/A	Radiation (03CH07-HY)
Software	Audix	E3	N/A	N/A	N/A	Jan. 19, 2024~May 03, 2024	N/A	Radiation (03CH07-HY)





## 5. Measurement Uncertainty

### Uncertainty of Conducted Emission Measurement (150 kHz ~ 30 MHz)

Measuring Uncertainty for a Level of Confidence of 95% ( $U = 2Uc(y)$ )	3.5 dB
---	--------

### Uncertainty of Radiated Emission Measurement (9 kHz ~ 30 MHz)

Measuring Uncertainty for a Level of Confidence of 95% ( $U = 2Uc(y)$ )	3.8 dB
---	--------

### Uncertainty of Radiated Emission Measurement (30 MHz ~ 1000 MHz)

Measuring Uncertainty for a Level of Confidence of 95% ( $U = 2Uc(y)$ )	6.3 dB
---	--------



## **Appendix A. Test Results of Conducted Emission Test**

# EUT Information

Report NO : 3N2325  
 Test Mode : Mode 1  
 Test Voltage : Power From WPC  
 Phase : Line

Full Spectrum

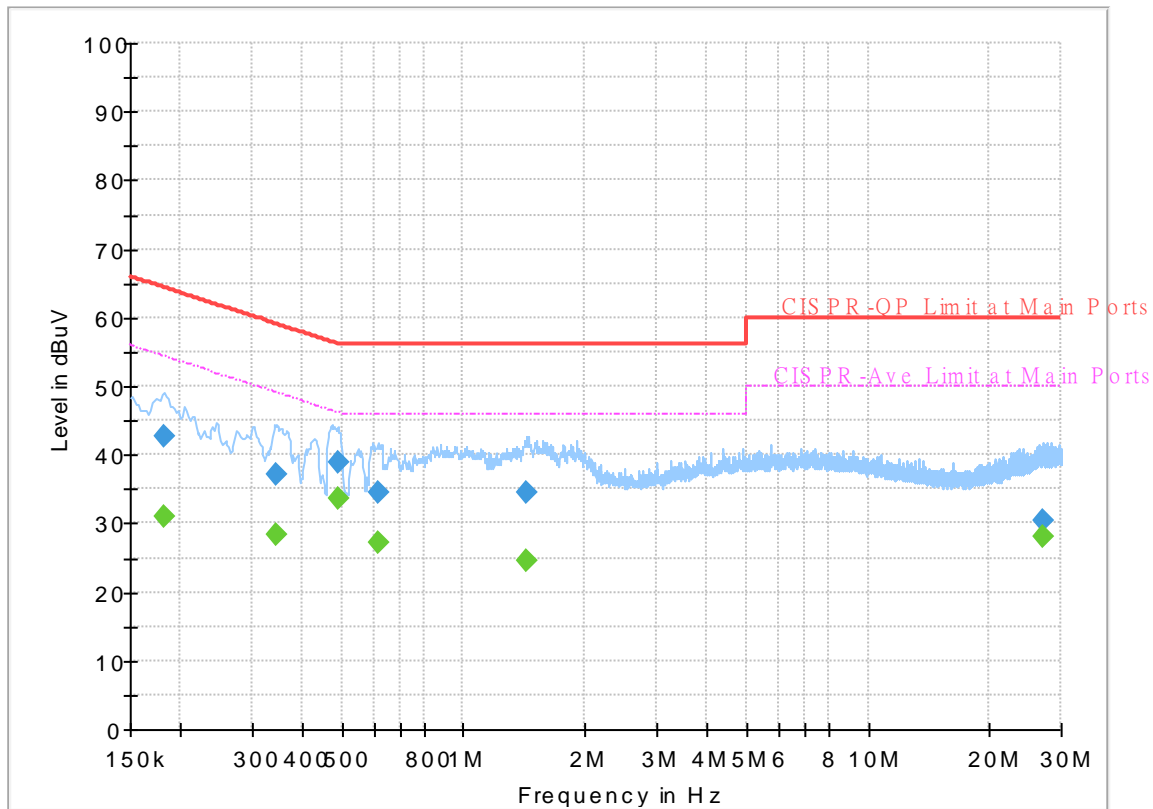

## Final Result

Frequency (MHz)	QuasiPeak (dBuV)	CAverage (dBuV)	Limit (dBuV)	Margin (dB)	Line	Filter	Corr. (dB)
0.181500	---	31.04	54.42	23.38	L1	OFF	19.8
0.181500	42.65	---	64.42	21.77	L1	OFF	19.8
0.345750	---	28.41	49.06	20.65	L1	OFF	19.8
0.345750	37.09	---	59.06	21.97	L1	OFF	19.8
0.489750	---	33.64	46.17	12.53	L1	OFF	19.8
0.489750	38.88	---	56.17	17.29	L1	OFF	19.8
0.613500	---	27.24	46.00	18.76	L1	OFF	19.8
0.613500	34.41	---	56.00	21.59	L1	OFF	19.8
1.434750	---	24.53	46.00	21.47	L1	OFF	19.8
1.434750	34.36	---	56.00	21.64	L1	OFF	19.8
27.102750	---	27.99	50.00	22.01	L1	OFF	20.6
27.102750	30.44	---	60.00	29.56	L1	OFF	20.6

# EUT Information

Report NO : 3N2325  
 Test Mode : Mode 1  
 Test Voltage : Power From WPC  
 Phase : Neutral

Full Spectrum

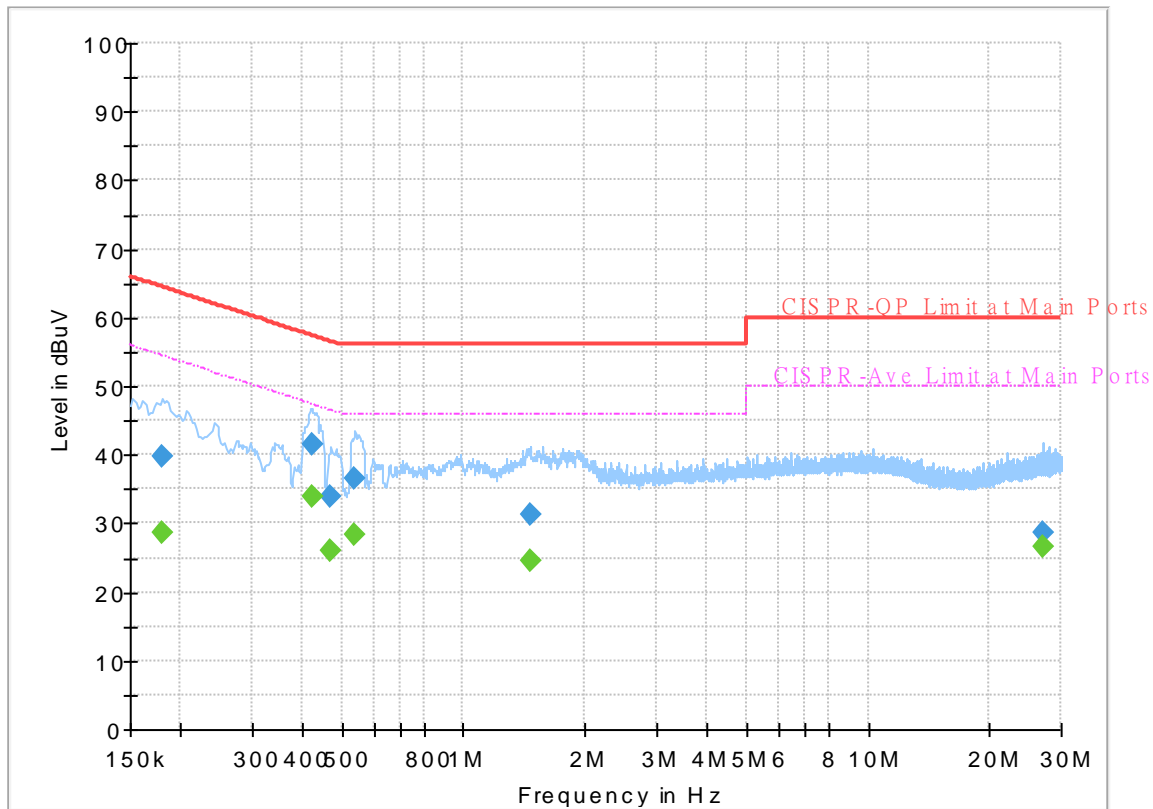

## Final Result

Frequency (MHz)	QuasiPeak (dBuV)	CAverage (dBuV)	Limit (dBuV)	Margin (dB)	Line	Filter	Corr. (dB)
0.179250	---	28.78	54.52	25.74	N	OFF	19.8
0.179250	39.72	---	64.52	24.80	N	OFF	19.8
0.422250	---	34.03	47.40	13.37	N	OFF	19.8
0.422250	41.41	---	57.40	15.99	N	OFF	19.8
0.469500	---	25.97	46.52	20.55	N	OFF	19.8
0.469500	33.82	---	56.52	22.70	N	OFF	19.8
0.539250	---	28.31	46.00	17.69	N	OFF	19.8
0.539250	36.66	---	56.00	19.34	N	OFF	19.8
1.468500	---	24.49	46.00	21.51	N	OFF	19.9
1.468500	31.24	---	56.00	24.76	N	OFF	19.9
27.024000	---	26.65	50.00	23.35	N	OFF	20.8
27.024000	28.53	---	60.00	31.47	N	OFF	20.8



## Appendix B. Test Results of RF Near Field Test Items

Test mode		WPT Charging with Another Phone	
<b>20dB Bandwidth (kHz)</b>	0.786	<b>99% Occupied BW(kHz)</b>	0.660

**Remark:** Because the measured signal is CW adjusting the RBW per C63.10 would not be practical since measured bandwidth will always follow the RBW and the result will be approximately twice the RBW.



## Appendix C. Test Results of Radiated Test Items

### C1. Test Result of Field Strength of Fundamental Emissions

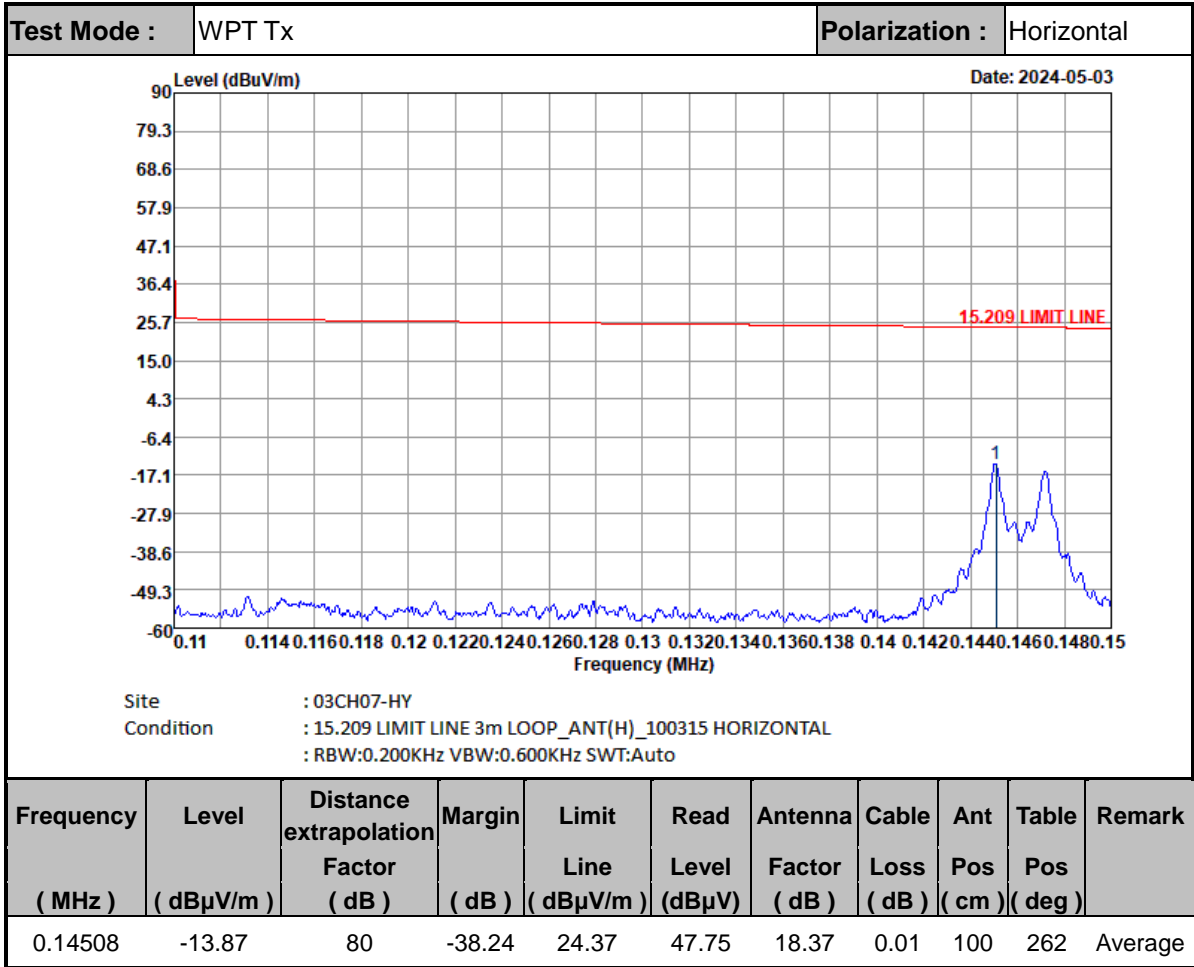

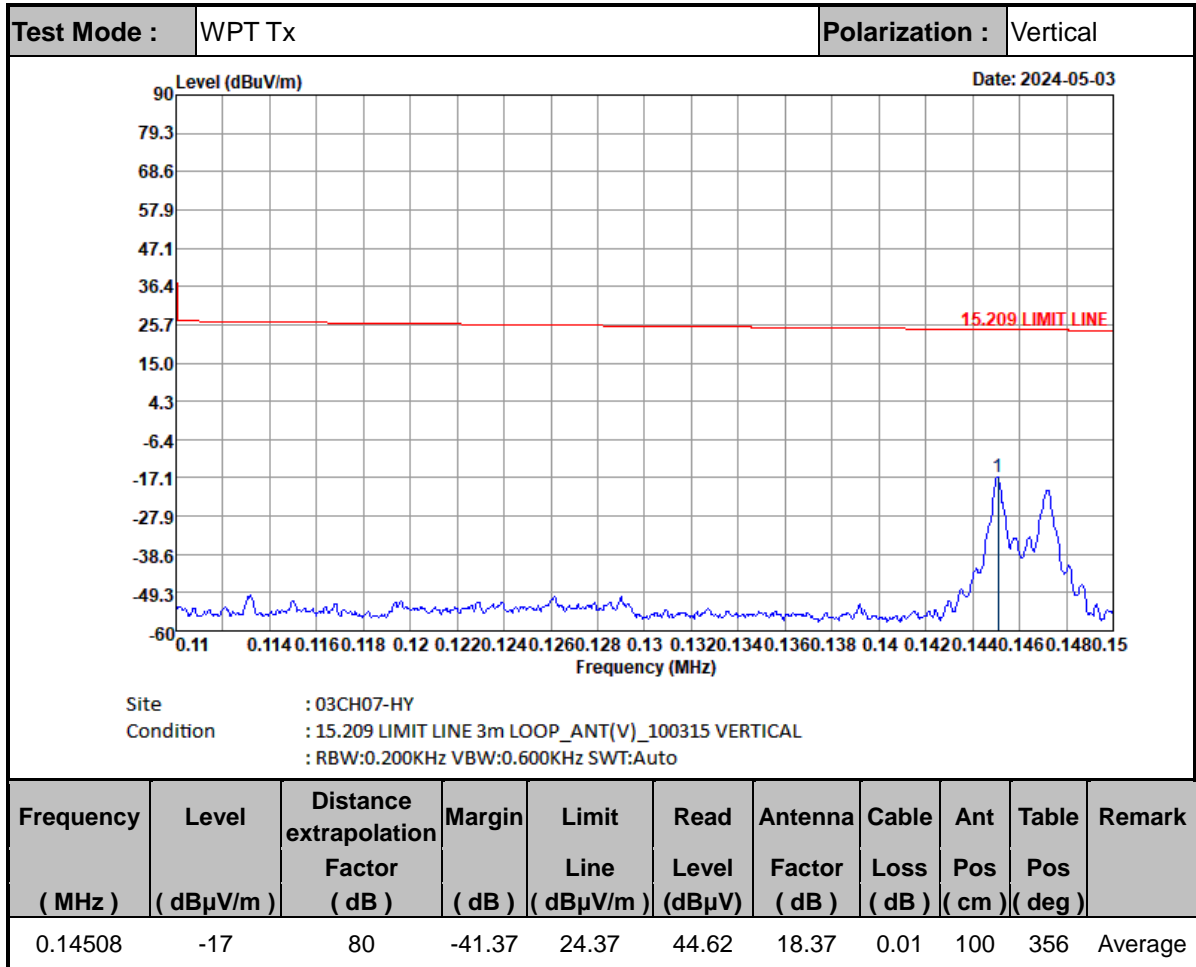

**Note:**

1. Distance extrapolation factor = 40 log (specific distance / test distance) (dB);
2. Level= Read Level + Antenna Factor + Cable loss - distance extrapolation factor.



C2. Results of Radiated Spurious Emissions (9 kHz~30MHz)

Test Mode :	WPT Tx	Polarization :	Horizontal
-------------	--------	----------------	------------

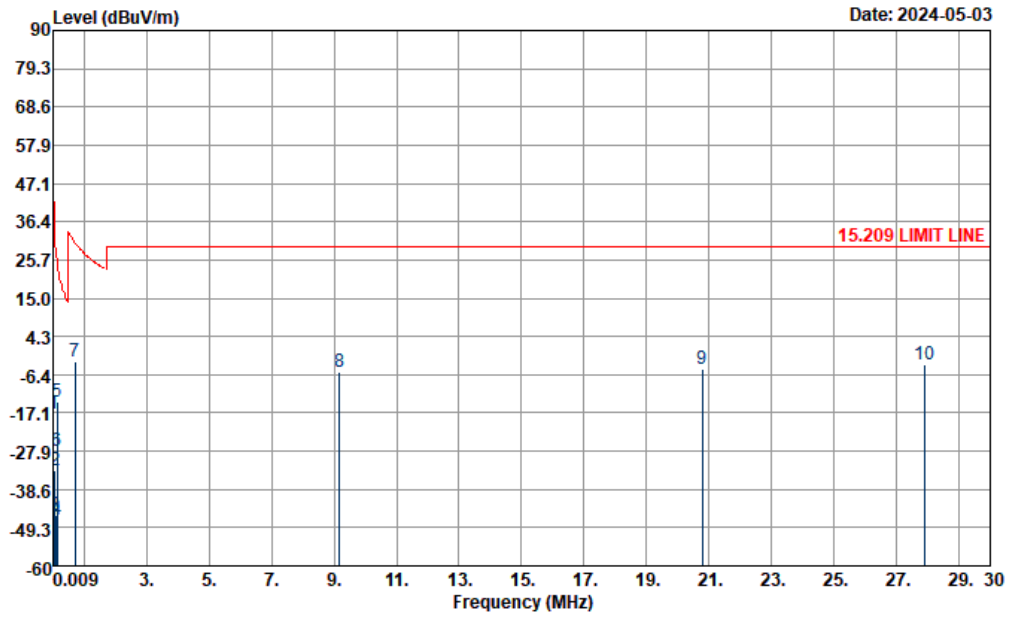

Site : 03CH07-HY  
 Condition : 15.209 LIMIT LINE 3m LOOP\_ANT(H)\_100315 HORIZONTAL

Frequency ( MHz )	Level ( dBμV/m )	Distance extrapolation Factor ( dB )	Margin ( dB )	Limit Line ( dBμV/m )	Read Level ( dBμV )	Antenna Factor ( dB )	Cable Loss ( dB )	Ant Pos ( cm )	Table Pos ( deg )	Remark
0.02048	-17.55	80	-58.93	41.38	43.5	18.93	0.02	-	-	Average
0.06717	-33.15	80	-64.21	31.06	28.14	18.68	0.03	-	-	Average
0.09166	-45.86	80	-74.22	28.36	15.47	18.63	0.04	-	-	QP
0.11556	-46.9	80	-73.25	26.35	14.47	18.59	0.04	-	-	Average
0.14508	-13.87	80	-38.24	24.37	47.75	18.37	0.01	-	-	Average
0.15034	-27.76	80	-51.82	24.06	33.62	18.57	0.05	-	-	Average
0.7153	-2.82	40	-33.33	30.51	18.65	18.48	0.05	-	-	QP
9.184	-5.68	40	-35.18	29.5	15.47	18.52	0.33	-	-	QP
20.788	-4.7	40	-34.2	29.5	15.54	19.24	0.52	-	-	QP
27.9	-3.68	40	-33.18	29.5	15.72	19.76	0.84	-	-	QP





Test Mode : WPT Tx Polarization : Vertical

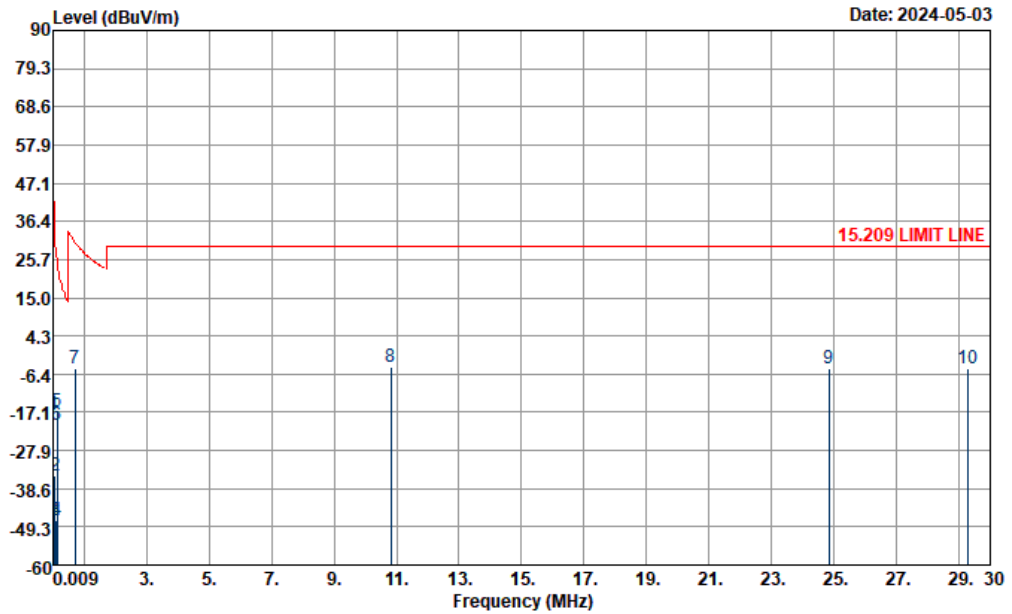

Site : 03CH07-HY  
 Condition : 15.209 LIMIT LINE 3m LOOP\_ANT(V)\_100315 VERTICAL

Frequency ( MHz )	Level ( dBμV/m )	Distance extrapolation Factor ( dB )	Margin ( dB )	Limit Line ( dBμV/m )	Read Level ( dBμV )	Antenna Factor ( dB )	Cable Loss ( dB )	Ant Pos ( cm )	Table Pos ( deg )	Remark
0.02048	-17.6	80	-58.98	41.38	43.45	18.93	0.02	-	-	Average
0.06729	-34.97	80	-66.02	31.05	26.32	18.68	0.03	-	-	Average
0.09166	-47.51	80	-75.87	28.36	13.82	18.63	0.04	-	-	QP
0.11248	-47.49	80	-74.07	26.58	13.87	18.6	0.04	-	-	Average
0.14508	-17	80	-41.37	24.37	44.62	18.37	0.01	-	-	Average
0.15034	-20.58	80	-44.64	24.06	40.8	18.57	0.05	-	-	Average
0.72281	-4.82	40	-35.24	30.42	16.65	18.48	0.05	-	-	QP
10.816	-4.43	40	-33.93	29.5	16.67	18.55	0.35	-	-	QP
24.838	-4.93	40	-34.43	29.5	14.78	19.69	0.6	-	-	QP
29.285	-4.66	40	-34.16	29.5	14.72	19.67	0.95	-	-	QP

Note:

1. The amplitude of spurious emissions which are attenuated by more than 20dB below the permissible value has no need to be reported.
2. Distance extrapolation factor = 40 log (specific distance / test distance) (dB);
3. Level= Read Level + Antenna Factor + Cable loss - distance extrapolation factor.



C3. Results of Radiated Spurious Emissions (30MHz~1GHz)

Test Mode :	WPT Tx	Polarization :	Horizontal
-------------	--------	----------------	------------

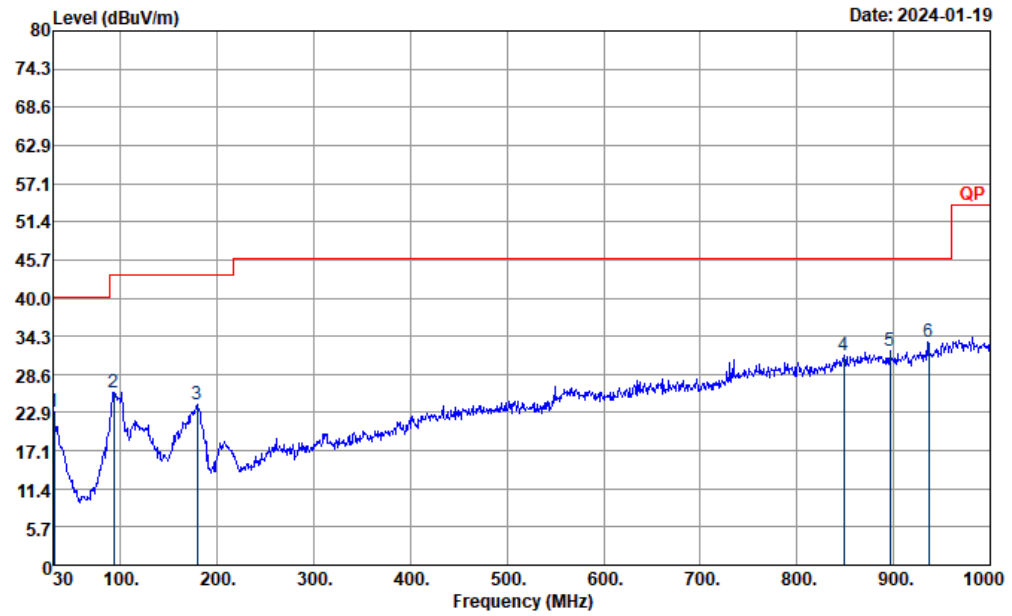

Site : 03CH07-HY  
 Condition : QP 3m LF-ANT-35419(6)\_H HORIZONTAL

Frequency ( MHz )	Level ( dBμV/m )	Margin ( dB )	Limit Line ( dBμV/m )	Read Level ( dBμV )	Antenna Factor ( dB )	Cable Loss ( dB )	Preamp Factor ( dB )	Ant Pos ( cm )	Table Pos ( deg )	Remark
31.08	22.91	-17.09	40	28	23.82	1.03	29.94	-	-	Peak
92.91	25.89	-17.61	43.5	39.07	15.14	1.58	29.9	-	-	Peak
179.58	23.98	-19.52	43.5	36.56	15.07	2.18	29.83	-	-	Peak
848.8	31.4	-14.6	46	26.85	28.86	4.86	29.17	-	-	Peak
896.4	32.1	-13.9	46	27.23	28.71	5.02	28.86	-	-	Peak
936.3	33.37	-12.63	46	27.49	29.49	5.11	28.72	-	-	Peak



Test Mode :	WPT Tx	Polarization :	Vertical
-------------	--------	----------------	----------

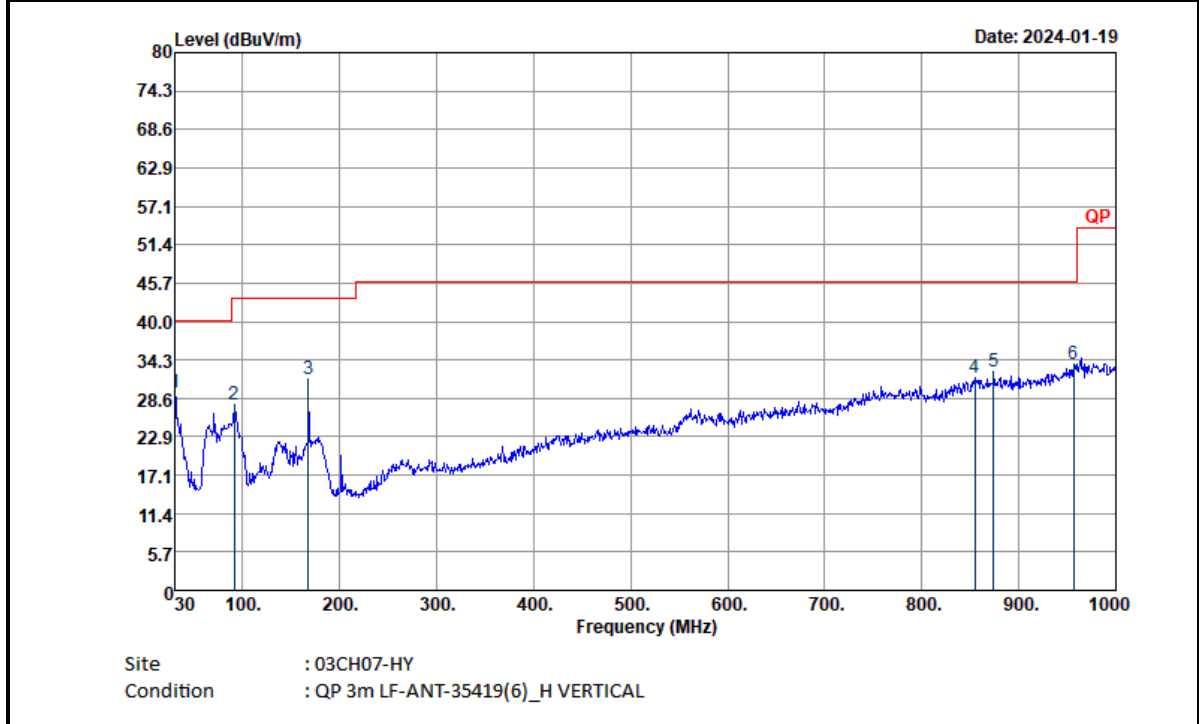

Frequency (MHz)	Level (dBμV/m)	Margin (dB)	Limit Line (dBμV/m)	Read Level (dBμV)	Antenna Factor (dB)	Cable Loss (dB)	Preamp Factor (dB)	Ant Pos (cm)	Table Pos (deg)	Remark
30	29.32	-10.68	40	34.14	24.11	1.01	29.94	-	-	Peak
91.02	27.59	-15.91	43.5	41.01	14.94	1.55	29.91	-	-	Peak
167.43	31.34	-12.16	43.5	43.2	15.86	2.12	29.84	-	-	Peak
854.4	31.69	-14.31	46	27.04	28.92	4.87	29.14	-	-	Peak
874	32.64	-13.36	46	27.76	28.95	4.94	29.01	-	-	Peak
956.6	33.57	-12.43	46	26.57	30.46	5.16	28.62	-	-	Peak

**Note:**

1. The amplitude of spurious emissions which are attenuated by more than 20dB below the permissible value has no need to be reported.
2. Emission level (dBμV/m) = 20 log Emission level (μV/m).
3. Corrected Reading: Antenna Factor + Cable Loss + Read Level - Preamp Factor= Level.

————THE END————