



FCC RADIO TEST REPORT

FCC ID : A4RGQML3
Equipment : Phone
Applicant : Google LLC
1600 Amphitheatre Parkway,
Mountain View, California, 94043 USA
Standard : FCC 47 CFR Part 2, 27

The product was received on Feb. 07, 2023 and testing was performed from Feb. 10, 2023 to Feb. 13, 2023. We, Sporton International Inc. EMC & Wireless Communications Laboratory, would like to declare that the tested sample has been evaluated in accordance with the test procedures given in ANSI / TIA-603-E and has been in compliance with the applicable technical standards.

The test results in this variant report apply exclusively to the tested model / sample. Without written approval of Sporton International Inc. EMC & Wireless Communications Laboratory, the test report shall not be reproduced except in full.

Approved by: Louis Wu

Sporton International Inc. EMC & Wireless Communications Laboratory

No. 52, Huaya 1st Rd., Guishan Dist., Taoyuan City 333, Taiwan (R.O.C.)



Table of Contents

History of this test report..... 3

Summary of Test Result..... 4

1 General Description 5

 1.1 Product Feature of Equipment Under Test..... 5

 1.2 Product Specification of Equipment Under Test..... 6

 1.3 Modification of EUT 6

 1.4 Testing Location 7

 1.5 Applicable Standards..... 7

2 Test Configuration of Equipment Under Test 8

 2.1 Test Mode..... 8

 2.2 Measurement Results Explanation Example..... 8

 2.3 Frequency List of Low/Middle/High Channels 9

3 Conducted Test Items 10

 3.1 Measuring Instruments 10

 3.2 Conducted Output Power and EIRP 11

 3.3 Occupied Bandwidth..... 12

 3.4 Conducted Band Edge 13

4 List of Measuring Equipment..... 14

Appendix A. Test Results of Conducted Test



History of this test report

Report No.	Version	Description	Issue Date
FG1O2843-21	01	Initial issue of report	Feb. 24, 2023



Summary of Test Result

Report Clause	Ref Std. Clause	Test Items	Result (PASS/FAIL)	Remark
3.2	§2.1046	Conducted Output Power	Reporting only	-
	§27.50 (h)(2)	Equivalent Isotropic Radiated Power (n41)	Pass	
-	§27.50 (d)(5)	Peak-to-Average Ratio	Not Required	Refer to FG1O2843-05C
3.3	§2.1049	Occupied Bandwidth	Reporting only	-
3.4	§2.1051	Conducted Band Edge Measurement (n41)	Pass	-
	§27.53 (m)(4)			
-	§2.1051 §27.53 (m)(4)	Conducted Spurious Emission (n41)	Not Required	Refer to FG1O2843-05C
-	§2.1055 §27.54	Frequency Stability Temperature & Voltage	Not Required	Refer to FG1O2843-05C
-	§2.1051 §27.53 (m)(4)	Radiated Spurious Emission (n41)	Not Required	Refer to FG1O2843-05C

Remark:

1. Not required means after assessing, test items are not necessary to carry out.
2. This is a variant report with adding n41 BW 70MHz. The other n41 bandwidths were performed on original report which can be referred to Sporton Report Number FG1O2843-05C. Based on the original report, only the necessary items are verified.

Declaration of Conformity:
The test results (PASS/FAIL) with all measurement uncertainty excluded are presented in accordance with the regulation limits or requirements declared by manufacturers. It's means measurement values may risk exceeding the limit of regulation standards, if measurement uncertainty is include in test results.
Comments and Explanations:
The product specifications of the EUT presented in the report are declared by the manufacturer who shall take full responsibility for the authenticity.

Reviewed by: William Chen

Report Producer: Michelle Chen



1 General Description

1.1 Product Feature of Equipment Under Test

Product Feature	
Equipment	Phone
FCC ID	A4RGQML3
EUT supports Radios application	GSM/EGPRS/WCDMA/HSPA/LTE/5G NR/NFC/GNSS/WPC/WPT WLAN 11b/g/n HT20 WLAN 11a/n HT20/HT40 WLAN 11ac VHT20/VHT40/VHT80/VHT160 WLAN 11ax HE20/HE40/HE80/HE160 Bluetooth BR/EDR/LE

Remark: The above EUT's information was declared by manufacturer.

EUT Information List	
S/N	Performed Test Item
24191FDH2000JC	Conducted Measurement EIRP

1.2 Product Specification of Equipment Under Test

Product Specification is subject to this standard	
Tx Frequency	5G NR n41: 2501.01 MHz ~ 2685.00 MHz
Rx Frequency	5G NR n41: 2501.01 MHz ~ 2685.00 MHz
Bandwidth	5G NR n41: 10MHz / 15MHz / 20MHz / 30MHz / 40MHz / 50MHz / 60MHz / 70MHz / 80MHz / 90MHz / 100MHz
Maximum Output Power to Antenna <DFT-s-OFDM>	<Primary Antenna> <Ant. 2> 5G NR n41 : 27.20 dBm <ASDIV Antenna> <Ant. 0> 5G NR n41 : 26.53 dBm
Maximum Output Power to Antenna <CP OFDM>	MIMO n41 <Ant. 2+1>: 28.43 dBm MIMO n41 <Ant. 0+5>: 27.78 dBm MIMO n41 <Ant. 2+5>: 27.99 dBm MIMO n41 <Ant. 0+1>: 27.57 dBm
Antenna Type	<Primary Antenna> <Ant. 1> : ILA Antenna <Ant. 2> : IFA Antenna <ASDIV Antenna> <Ant. 0> : ILA Antenna <Ant. 5> : Loop Antenna
Type of Modulation	PI/2 BPSK / QPSK / 16QAM / 64QAM / 256QAM

<Primary Antenna>

Radio Tech	Band Number	Antenna name	Gain
5G NR	n41	Ant. 1	-5.0
		Ant. 2	-1.9

<ASDIV Antenna>

Radio Tech	Band Number	Antenna name	Gain
5G NR	n41	Ant. 0	-1.1
		Ant. 5	-3.9

Remark: The above EUT's information was declared by manufacturer. Please refer to Comments and Explanations in report summary.

1.3 Modification of EUT

No modifications are made to the EUT during all test items.



1.4 Testing Location

Test Site	Sporton International Inc. EMC & Wireless Communications Laboratory
Test Site Location	No.52, Huaya 1st Rd., Guishan Dist., Taoyuan City 333, Taiwan (R.O.C.) TEL: +886-3-327-3456 FAX: +886-3-328-4978
Test Site No.	Sporton Site No. TH03-HY
Test Engineer	George Chen
Temperature (°C)	21.7~23.5
Relative Humidity (%)	44.0~57.0

FCC Designation No.: TW1190

1.5 Applicable Standards

According to the specifications of the manufacturer, the EUT must comply with the requirements of the following standards:

- ♦ ANSI C63.26-2015
- ♦ ANSI / TIA-603-E
- ♦ FCC 47 CFR Part 2,
- ♦ FCC KDB 971168 D01 Power Meas. License Digital Systems v03r01
- ♦ FCC KDB 412172 D01 Determining ERP and EIRP v01r01
- ♦ FCC KDB 662911 D01 Multiple Transmitter Output v02r01.

Remark:

1. All test items were verified and recorded according to the standards and without any deviation during the test.
2. The TAF code is not including all the FCC KDB listed without accreditation.



2 Test Configuration of Equipment Under Test

2.1 Test Mode

Antenna port conducted and radiated test items listed below are performed according to KDB 971168 D01 Power Meas. License Digital Systems v03r01 with maximum output power.

Test Items	NR Band	Bandwidth (MHz)											Modulation					RB #			Test Channel				
		10	15	20	30	40	50	60	70	80	90	100	PI/2 BPSK	QPSK	16QAM	64QAM	256QAM	1	Half	Full	L	M	H		
Max. Output Power	n41								v				v	v	v	v	v	v	v	v	v	v	v	v	v
26dB and 99% Bandwidth	n41								v				v	v	v	v	v			v				v	
Conducted Band Edge	n41								v				v	v	v	v	v	v		v	v			v	
E.I.R.P	n41								v				v	v	v	v	v	Max. Power							
Remark	1. The mark "v " means that this configuration is chosen for testing 2. The mark "- " means that this bandwidth is not supported.																								

2.2 Measurement Results Explanation Example

For all conducted test items:

The offset level is set in the spectrum analyzer to compensate the RF cable loss and attenuator factor between EUT conducted output port and spectrum analyzer. With the offset compensation, the spectrum analyzer reading level is exactly the EUT RF output level.

The spectrum analyzer offset is derived from RF cable loss and attenuator factor.

Offset = RF cable loss + attenuator factor.

Following shows an offset computation example with cable loss 4.2 dB and 10dB attenuator.

Example :

Offset(dB) = RF cable loss(dB) + attenuator factor(dB).

= 4.2 + 10 = 14.2 (dB)



2.3 Frequency List of Low/Middle/High Channels

5G NR n41 Channel and Frequency List				
BW [MHz]	Channel/Frequency(MHz)	Lowest	Middle	Highest
100	Channel	509202	518598	528000
	Frequency	2546.01	2592.99	2640
90	Channel	508200	518598	528996
	Frequency	2541	2592.99	2644.98
80	Channel	507204	518598	529998
	Frequency	2536.02	2592.99	2649.99
70	Channel	506202	518598	531000
	Frequency	2531.01	2592.99	2655
60	Channel	505200	518598	531996
	Frequency	2526	2592.99	2659.98
50	Channel	504204	518598	532998
	Frequency	2521.02	2592.99	2664.99
40	Channel	503202	518598	534000
	Frequency	2516.01	2592.99	2670
30	Channel	502200	518598	534996
	Frequency	2511	2592.99	2674.98
20	Channel	501204	518598	535998
	Frequency	2506.02	2592.99	2679.99
15	Channel	500700	518598	536496
	Frequency	2503.5	2592.99	2682.48
10	Channel	500202	518598	537000
	Frequency	2501.01	2592.99	2685

3 Conducted Test Items

3.1 Measuring Instruments

See list of measuring instruments of this test report.

3.1.1 Test Setup

3.1.2 Conducted Output Power

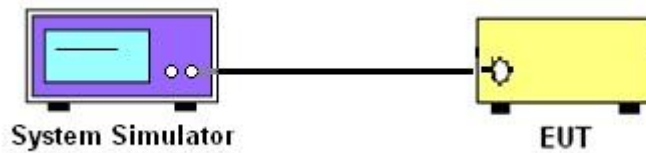

3.1.3 Occupied Bandwidth and Conducted Band-Edge

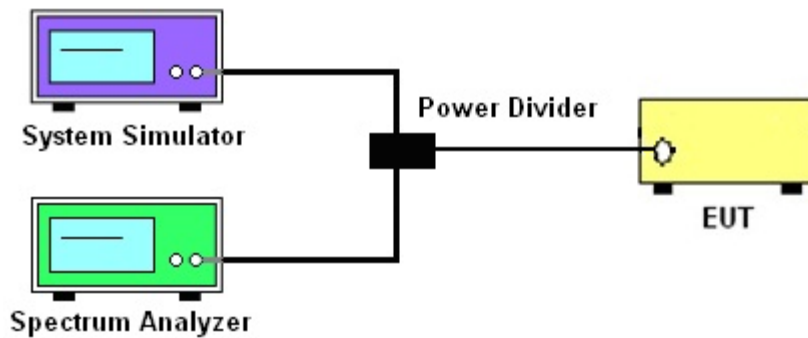

3.1.4 Test Result of Conducted Test

Please refer to Appendix A.



3.2 Conducted Output Power and EIRP

3.2.1 Description of the Conducted Output Power Measurement and EIRP Measurement

A system simulator was used to establish communication with the EUT. Its parameters were set to force the EUT transmitting at maximum output power. The measured power in the radio frequency on the transmitter output terminals shall be reported.

The EIRP of mobile transmitters must not exceed 2 Watts for 5G NR n41.

According to KDB 412172 D01 Power Approach,

$EIRP = P_T + G_T - L_C$, $ERP = EIRP - 2.15$, where

P_T = transmitter output power in dBm

G_T = gain of the transmitting antenna in dBi

L_C = signal attenuation in the connecting cable between the transmitter and antenna in dB

3.2.2 Test Procedures

1. The transmitter output port was connected to the system simulator.
2. Set EUT at maximum power through the system simulator.
3. Select lowest, middle, and highest channels for each band and different modulation.
4. Measure and record the power level from the system simulator.
5. The MIMO mode is completely uncorrelated, so the directional gain is selected the maximum gain among all antennas.



3.3 Occupied Bandwidth

3.3.1 Description of Occupied Bandwidth Measurement

The occupied bandwidth is the width of a frequency band such that, below the lower and above the upper frequency limits, the mean powers emitted are each equal to a specified percentage 0.5% of the total mean transmitted power.

The 26 dB emission bandwidth is defined as the frequency range between two points, one above and one below the carrier frequency, at which the spectral density of the emission is attenuated 26 dB below the maximum in-band spectral density of the modulated signal. Spectral density (power per unit bandwidth) is to be measured with a detector of resolution bandwidth equal to approximately 1.0% of the emission bandwidth.

3.3.2 Test Procedures

The testing follows ANSI C63.26-2015 Section 5.4.3 (26dB) and Section 5.4.4 (99OB)

1. The EUT was connected to spectrum analyzer and system simulator via a power divider.
2. The spectrum analyzer center frequency is set to the nominal EUT channel center frequency. The span range for the spectrum analyzer shall be between two and five times the anticipated OBW.
3. The nominal resolution bandwidth (RBW) shall be in the range of 1 to 5 % of the anticipated OBW, and the VBW shall be at least 3 times the RBW.
4. Set the detection mode to peak, and the trace mode to max hold.
5. Determine the reference value: Set the EUT to transmit a modulated signal. Allow the trace to stabilize. Set the spectrum analyzer marker to the highest level of the displayed trace.
(this is the reference value)
6. Determine the “-26 dB down amplitude” as equal to (Reference Value – X).
7. Place two markers, one at the lowest and the other at the highest frequency of the envelope of the spectral display such that each marker is at or slightly below the “-X dB down amplitude” determined in step 6. If a marker is below this “-X dB down amplitude” value it shall be placed as close as possible to this value. The OBW is the positive frequency difference between the two markers.
8. Use the 99 % power bandwidth function of the spectrum analyzer and report the measured bandwidth.



3.4 Conducted Band Edge

3.4.1 Description of Conducted Band Edge Measurement

27.53(m)(4)

For mobile digital stations, the attenuation factor shall be not less than $40 + 10 \log (P)$ dB on all frequencies between the channel edge and 5 megahertz from the channel edge, $43 + 10 \log (P)$ dB on all frequencies between 5 megahertz and X megahertz from the channel edge, and $55 + 10 \log (P)$ dB on all frequencies more than X megahertz from the channel edge, where X is the greater of 6 megahertz or the actual emission bandwidth as defined in paragraph (m)(6) of this section. In addition, the attenuation factor shall not be less that $43 + 10 \log (P)$ dB on all frequencies between 2490.5 MHz and 2496 MHz and $55 + 10 \log (P)$ dB at or below 2490.5 MHz. Mobile Satellite Service licensees operating on frequencies below 2495 MHz may also submit a documented interference complaint against BRS licensees operating on channel BRS Channel 1 on the same terms and conditions as adjacent channel BRS or EBS licensees.

3.4.2 Test Procedures

The testing follows FCC KDB 971168 D01 v03r01 Section 6.1.

1. The EUT was connected to spectrum analyzer and system simulator via a power divider.
2. The band edges of low and high channels for the highest RF powers were measured.
3. Set RBW \geq 1% EBW in the 1MHz band immediately outside and adjacent to the band edge.
4. Beyond the 1 MHz band from the band edge, RBW=1MHz was used.
5. Set spectrum analyzer with RMS detector.
6. The RF fundamental frequency should be excluded against the limit line in the operating frequency band.
7. Checked that all the results comply with the emission limit line.

The limit line is derived from $43 + 10\log(P)$ dB below the transmitter power P(Watts)

For 5G NR n41

The other $40 + 10\log(P)$ dB and $55 + 10\log(P)$ dB below the transmitter power P(Watts) applied.

8. For MIMO mode, add additional MIMO factor $10\log(NTX=2) = 3.01$ dB into the spectrum analyzer offset.



4 List of Measuring Equipment

Instrument	Brand Name	Model No.	Serial No.	Characteristics	Calibration Date	Test Date	Due Date	Remark
Programmable Power Supply	GW Instek	PSS-2005	EL890001	50Hz~60Hz	Sep. 29, 2022	Feb. 10, 2023~ Feb. 13, 2023	Sep. 28, 2023	Conducted (TH03-HY)
Signal Analyzer	Rohde & Schwarz	FSV3044	101102	10Hz~44GHz	Feb. 02, 2023	Feb. 10, 2023~ Feb. 13, 2023	Feb. 01, 2024	Conducted (TH03-HY)
Base Station (Measure)	Anritsu	MT8000A	6261940327	FR1	Dec. 09, 2022	Feb. 10, 2023~ Feb. 13, 2023	Dec. 08, 2023	Conducted (TH03-HY)



Appendix A. Test Results of Conducted Test

Conducted Output Power(Average power) and EIRP

<SISO Mode>
 <DFT-s-OFDM>
 <Primary Antenna>

NR n41 PC2 Maximum Average Power [dBm] (GT - LC = -1.9 dB)										
BW [MHz]	RB Size	RB Offset	Mod	Lowest	Middle	Highest	EIRP (dBm)	EIRP(W)		
70	1	1	PI/2 BPSK	27.19	27.08	26.87	25.30	0.3388		
70	1	187		27.06	27.14	26.87				
70	90	45		26.68	26.64	26.61				
70	1	0		23.56	23.45	23.28				
70	1	188		23.51	23.72	23.40				
70	180	0		26.34	26.12	26.23				
70	1	1	QPSK	27.18	26.99	26.93			25.30	0.3388
70	1	187		27.07	27.20	27.02				
70	90	45		26.70	26.73	26.71				
70	1	0		23.54	23.50	23.38				
70	1	188		23.46	23.73	23.46				
70	180	0		25.75	25.77	25.75				
70	1	1	16-QAM	26.16	25.96	25.93	24.26	0.2667		
70	1	1	64-QAM	24.68	24.51	24.31				
70	1	1	256-QAM	22.53	22.29	22.35				
Limit	EIRP < 2W			Result			Pass			



<ASDIV Antenna>

NR n41 PC2 Maximum Average Power [dBm] (GT - LC = -1.1 dB)								
BW [MHz]	RB Size	RB Offset	Mod	Lowest	Middle	Highest	EIRP (dBm)	EIRP(W)
70	1	1	PI/2 BPSK	25.75	25.51	25.64	25.43	0.3491
70	1	187		25.75	25.91	26.44		
70	90	45		25.26	25.37	25.57		
70	1	0		25.69	25.63	25.69		
70	1	188		25.66	26.03	26.45		
70	180	0		25.37	25.86	25.74		
70	1	1	QPSK	25.74	25.62	25.71		
70	1	187		25.72	26.03	26.51		
70	90	45		25.28	25.44	25.64		
70	1	0		25.66	25.60	25.70		
70	1	188		25.70	26.09	26.53		
70	180	0		25.37	25.57	25.79		
70	1	1	16-QAM	25.69	25.75	25.90	24.80	0.3020
70	1	1	64-QAM	25.81	25.89	25.75		
70	1	1	256-QAM	25.74	25.62	25.79		
Limit	EIRP < 2W			Result			Pass	



<MIMO Mode>

<CP OFDM>

NR n41 PC1.5 Maximum Average Power [dBm], DG = -1.9 dBi														
BW (MHz)	RB Size	RB Offset	Mod	Antenna 2			Antenna 1			Combine			EIRP (dBm)	EIRP (W)
				Lowest	Middle	Highest	Lowest	Middle	Highest	Lowest	Middle	Highest		
70	1	1	QPSK	25.57	25.65	25.39	25.25	24.83	24.96	28.42	28.27	28.19	26.53	0.4498
70	1	187		25.55	25.54	25.71	24.71	24.86	25.11	28.16	28.22	28.43		
70	95	47		25.35	25.07	25.33	24.50	24.52	24.70	27.96	27.81	28.04		
70	1	0		21.86	22.13	21.87	21.76	21.44	21.39	24.82	24.81	24.65		
70	1	188		21.95	22.00	22.10	21.20	21.36	21.59	24.60	24.70	24.86		
70	189	0		22.26	22.14	22.35	21.68	21.56	21.67	24.99	24.87	25.03		
70	1	1	16-QAM	25.03	25.03	24.88	24.50	24.54	24.39	27.78	27.80	27.65	25.90	0.3890
70	1	1	64-QAM	23.43	23.55	23.31	23.35	23.04	22.86	26.40	26.31	26.10		
70	1	1	256-QAM	18.87	19.04	18.84	18.61	18.46	18.30	21.75	21.77	21.59		
Limit	EIRP < 2W			Result									Pass	



NR n41 PC1.5 Maximum Average Power [dBm], DG = -1.1 dBi														
BW (MHz)	RB Size	RB Offset	Mod	Antenna 0			Antenna 5			Combine			EIRP (dBm)	EIRP (W)
				Lowest	Middle	Highest	Lowest	Middle	Highest	Lowest	Middle	Highest		
70	1	1	QPSK	24.10	24.15	24.10	24.63	24.13	24.37	27.38	27.15	27.25	26.68	0.4656
70	1	187		24.18	24.55	25.16	24.17	24.32	24.35	27.19	27.45	27.78		
70	95	47		23.95	23.91	24.27	24.01	24.02	24.02	26.99	26.98	27.16		
70	1	0		20.54	20.66	20.89	21.11	20.75	20.53	23.84	23.72	23.72		
70	1	188		20.71	21.04	21.59	20.63	20.80	20.83	23.68	23.93	24.24		
70	189	0		20.91	20.96	21.27	21.01	21.03	21.10	23.97	24.01	24.20		
70	1	1	16-QAM	23.52	23.63	23.59	24.07	23.67	23.88	26.81	26.66	26.75	25.71	0.3724
70	1	1	64-QAM	21.82	22.01	22.04	22.59	22.22	22.23	25.23	25.13	25.15		
70	1	1	256-QAM	17.41	17.60	17.54	18.19	17.88	17.67	20.83	20.75	20.62		
Limit	EIRP < 2W			Result									Pass	



NR n41 PC1.5 Maximum Average Power [dBm], DG = -1.9 dBi														
BW (MHz)	RB Size	RB Offset	Mod	Antenna 2			Antenna 5			Combine			EIRP (dBm)	EIRP (W)
				Lowest	Middle	Highest	Lowest	Middle	Highest	Lowest	Middle	Highest		
70	1	1	QPSK	24.75	25.42	25.07	24.03	24.07	24.13	27.42	27.81	27.64	26.09	0.4064
70	1	187		24.49	25.54	25.50	25.42	24.24	24.30	27.99	27.95	27.95		
70	95	47		25.23	24.94	25.17	24.05	23.91	23.93	27.69	27.47	27.60		
70	1	0		21.90	21.82	21.55	20.93	20.67	20.74	24.45	24.29	24.17		
70	1	188		21.88	21.92	21.96	20.52	20.55	20.72	24.26	24.30	24.39		
70	189	0		22.17	21.93	21.92	20.93	20.96	20.97	24.60	24.48	24.48		
70	1	1	16-QAM	24.87	24.71	24.58	23.79	23.68	23.76	27.37	27.24	27.20	25.47	0.3524
70	1	1	64-QAM	23.28	23.11	22.97	22.19	22.07	22.17	25.78	25.63	25.60		
70	1	1	256-QAM	18.57	18.62	18.48	17.76	17.57	17.65	21.19	21.14	21.10		
Limit	EIRP < 2W			Result									Pass	



NR n41 PC1.5 Maximum Average Power [dBm], DG = -1.1 dBi														
BW (MHz)	RB Size	RB Offset	Mod	Antenna 0			Antenna 1			Combine			EIRP (dBm)	EIRP (W)
				Lowest	Middle	Highest	Lowest	Middle	Highest	Lowest	Middle	Highest		
70	1	1	QPSK	24.09	24.07	23.89	24.96	24.64	24.62	27.56	27.37	27.28	26.47	0.4436
70	1	187		24.05	24.06	24.33	24.55	24.69	24.77	27.32	27.40	27.57		
70	95	47		23.90	23.69	23.96	24.27	24.24	24.34	27.10	26.98	27.16		
70	1	0		20.50	20.70	20.41	21.54	21.04	21.06	24.06	23.88	23.76		
70	1	188		20.47	20.53	20.89	20.91	21.10	21.28	23.71	23.83	24.10		
70	189	0		20.88	20.75	21.02	21.32	21.32	21.29	24.12	24.05	24.17		
70	1	1	16-QAM	23.67	23.77	23.37	24.42	24.11	24.22	27.07	26.95	26.83	25.97	0.3954
70	1	1	64-QAM	22.15	22.25	21.69	22.96	22.61	22.70	25.58	25.44	25.23		
70	1	1	256-QAM	17.45	17.57	17.17	18.42	17.96	18.09	20.97	20.78	20.66		
Limit	EIRP < 2W			Result									Pass	



FR1 n41 PC2

<SISO Mode>

26dB Bandwidth

Mode	FR1 n41 : 26dB BW(MHz) / DFT-S OFDM							
BW	20MHz	25MHz	30MHz	40MHz	50MHz	60MHz	70MHz	80MHz
Mod.	PI/2 BPSK	PI/2 BPSK	PI/2 BPSK	PI/2 BPSK	PI/2 BPSK	PI/2 BPSK	PI/2 BPSK	PI/2 BPSK
Middle CH	-	-	-	-	-	-	67.27	-
BW	90MHz	100MHz						
Mod.	PI/2 BPSK	PI/2 BPSK						
Middle CH	-	-						

Mode	FR1 n41 : 26dB BW(MHz) / CP OFDM							
BW	20MHz		25MHz		30MHz		40MHz	
Mod.	QPSK	16QAM	QPSK	16QAM	QPSK	16QAM	QPSK	16QAM
Middle CH	-	-	-	-	-	-	-	-
Mod.	64QAM	256QAM	64QAM	256QAM	64QAM	256QAM	64QAM	256QAM
Middle CH	-	-	-	-	-	-	-	-
BW	50MHz		60MHz		70MHz		80MHz	
Mod.	QPSK	16QAM	QPSK	16QAM	QPSK	16QAM	QPSK	16QAM
Middle CH	-	-	-	-	71.05	70.49	-	-
Mod.	64QAM	256QAM	64QAM	256QAM	64QAM	256QAM	64QAM	256QAM
Middle CH	-	-	-	-	70.49	70.63	-	-
BW	90MHz		100MHz					
Mod.	QPSK	16QAM	QPSK	16QAM				
Middle CH	-	-	-	-				
Mod.	64QAM	256QAM	64QAM	256QAM				
Middle CH	-	-	-	-				



FR1 n41 / 70MHz / DFT-S OFDM / Middle Channel / Full RB

PI/2 BPSK

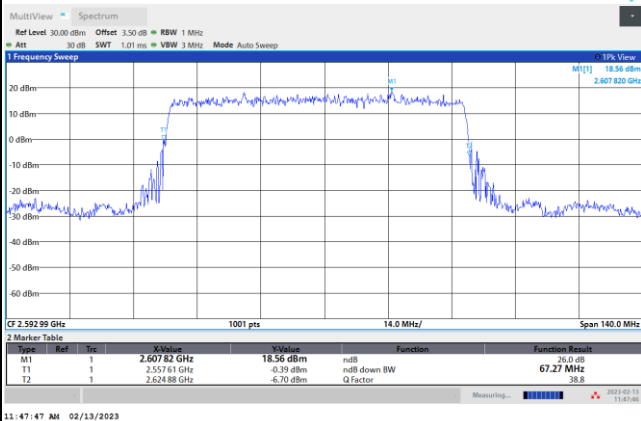

FR1 n41 / 70MHz / CP OFDM / Middle Channel / Full RB

QPSK

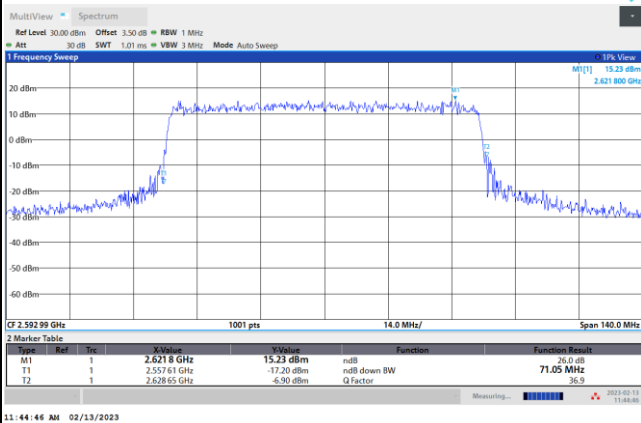

16QAM

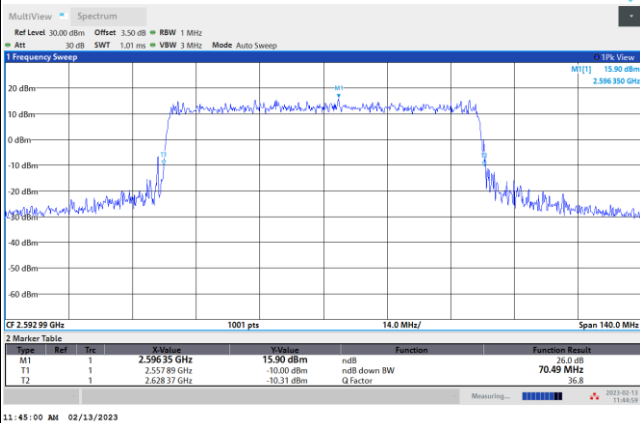

64QAM

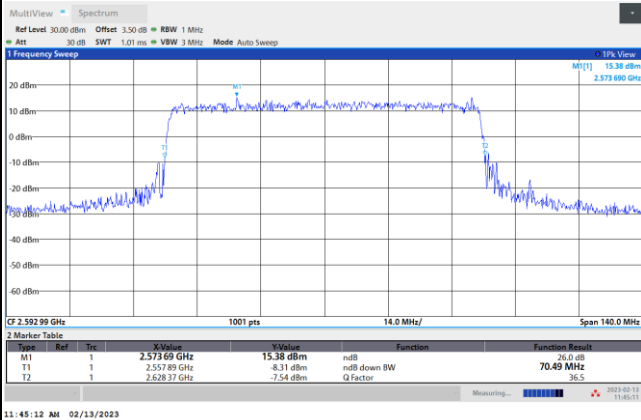

256QAM

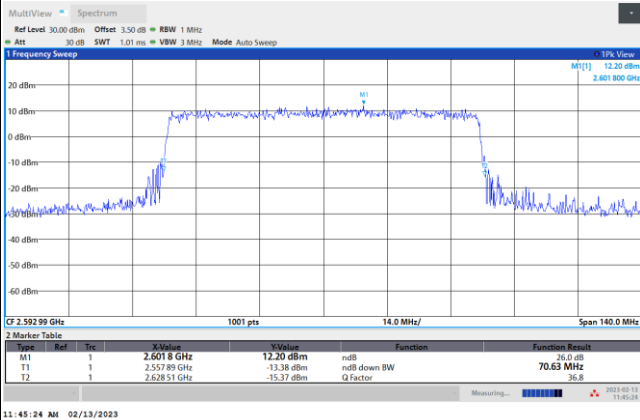



Occupied Bandwidth

Mode	FR1 n41 : OB BW(MHz) / DFT-S OFDM							
BW	20MHz	25MHz	30MHz	40MHz	50MHz	60MHz	70MHz	80MHz
Mod.	PI/2 BPSK	PI/2 BPSK	PI/2 BPSK	PI/2 BPSK	PI/2 BPSK	PI/2 BPSK	PI/2 BPSK	PI/2 BPSK
Middle CH	-	-	-	-	-	-	64.19	-
BW	90MHz	100MHz						
Mod.	PI/2 BPSK	PI/2 BPSK						
Middle CH	-	-						

Mode	FR1 n41 : OB BW(MHz) / CP OFDM							
BW	20MHz		25MHz		30MHz		40MHz	
Mod.	QPSK	16QAM	QPSK	16QAM	QPSK	16QAM	QPSK	16QAM
Middle CH	-	-	-	-	-	-	-	-
Mod.	64QAM	256QAM	64QAM	256QAM	64QAM	256QAM	64QAM	256QAM
Middle CH	-	-	-	-	-	-	-	-
BW	50MHz		60MHz		70MHz		80MHz	
Mod.	QPSK	16QAM	QPSK	16QAM	QPSK	16QAM	QPSK	16QAM
Middle CH	-	-	-	-	67.33	67.32	-	-
Mod.	64QAM	256QAM	64QAM	256QAM	64QAM	256QAM	64QAM	256QAM
Middle CH	-	-	-	-	67.50	67.43	-	-
BW	90MHz		100MHz					
Mod.	QPSK	16QAM	QPSK	16QAM				
Middle CH	-	-	-	-				
Mod.	64QAM	256QAM	64QAM	256QAM				
Middle CH	-	-	-	-				



FR1 n41 / 70MHz / DFT-S OFDM / Middle Channel / Full RB

PI/2 BPSK

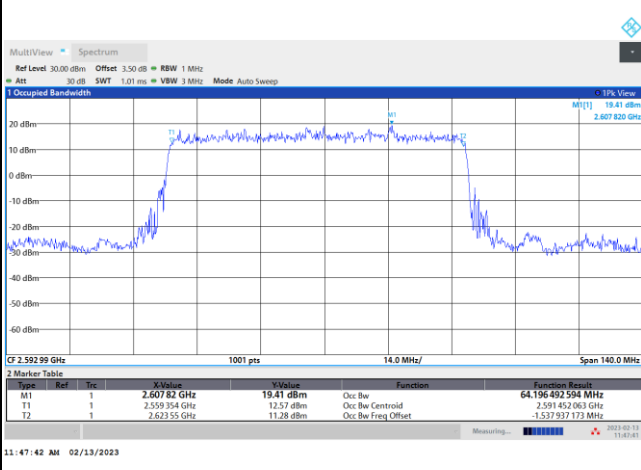

FR1 n41 / 70MHz / CP OFDM / Middle Channel / Full RB

QPSK

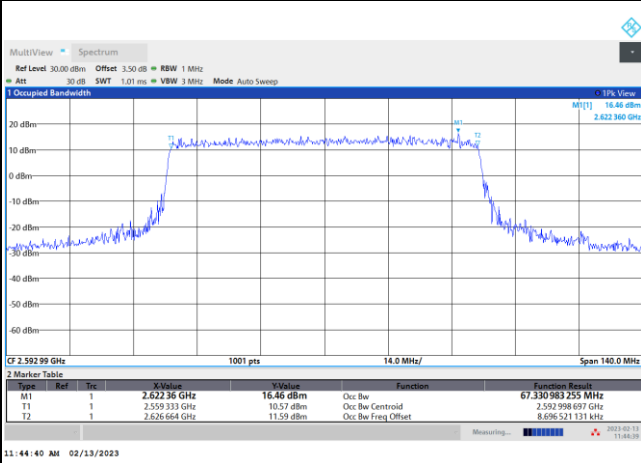

16QAM

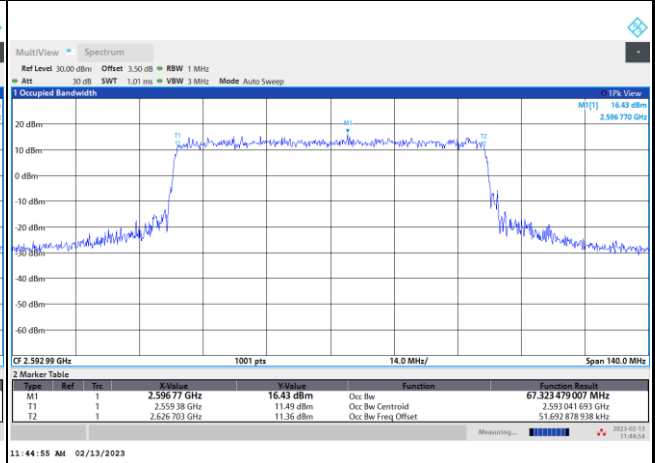

64QAM

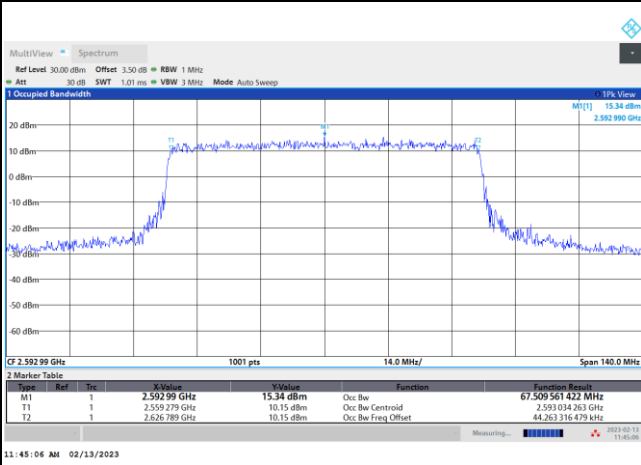

256QAM

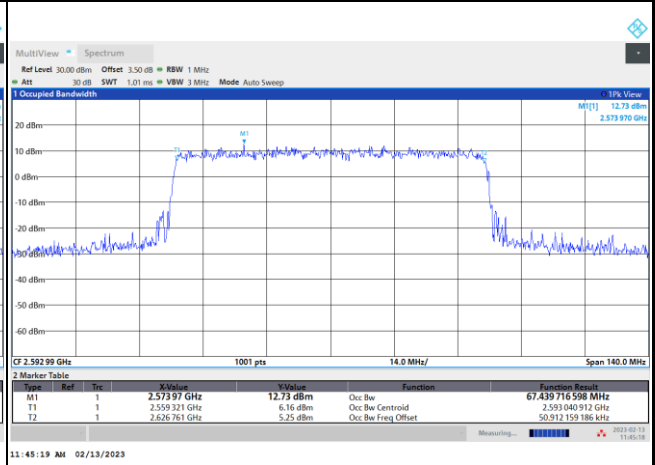



Conducted Band Edge

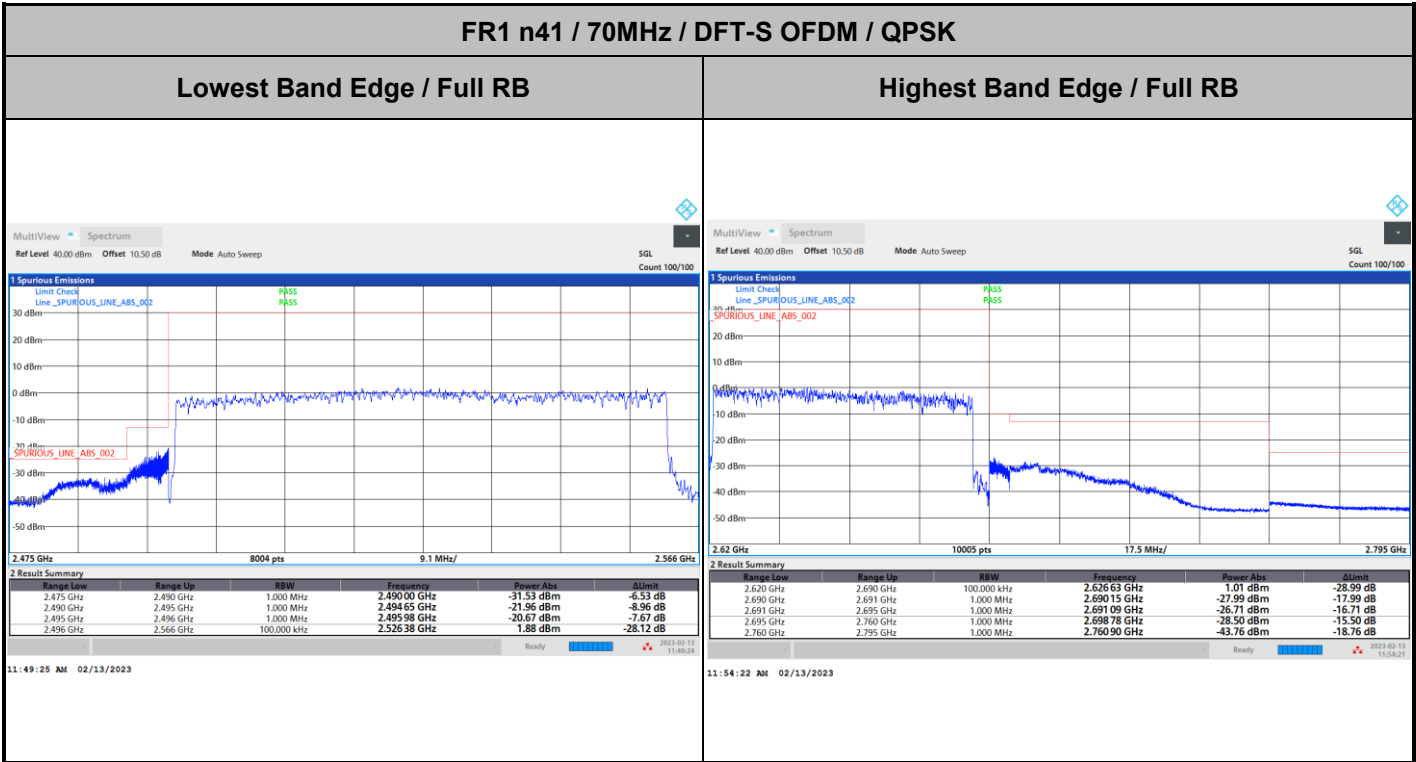
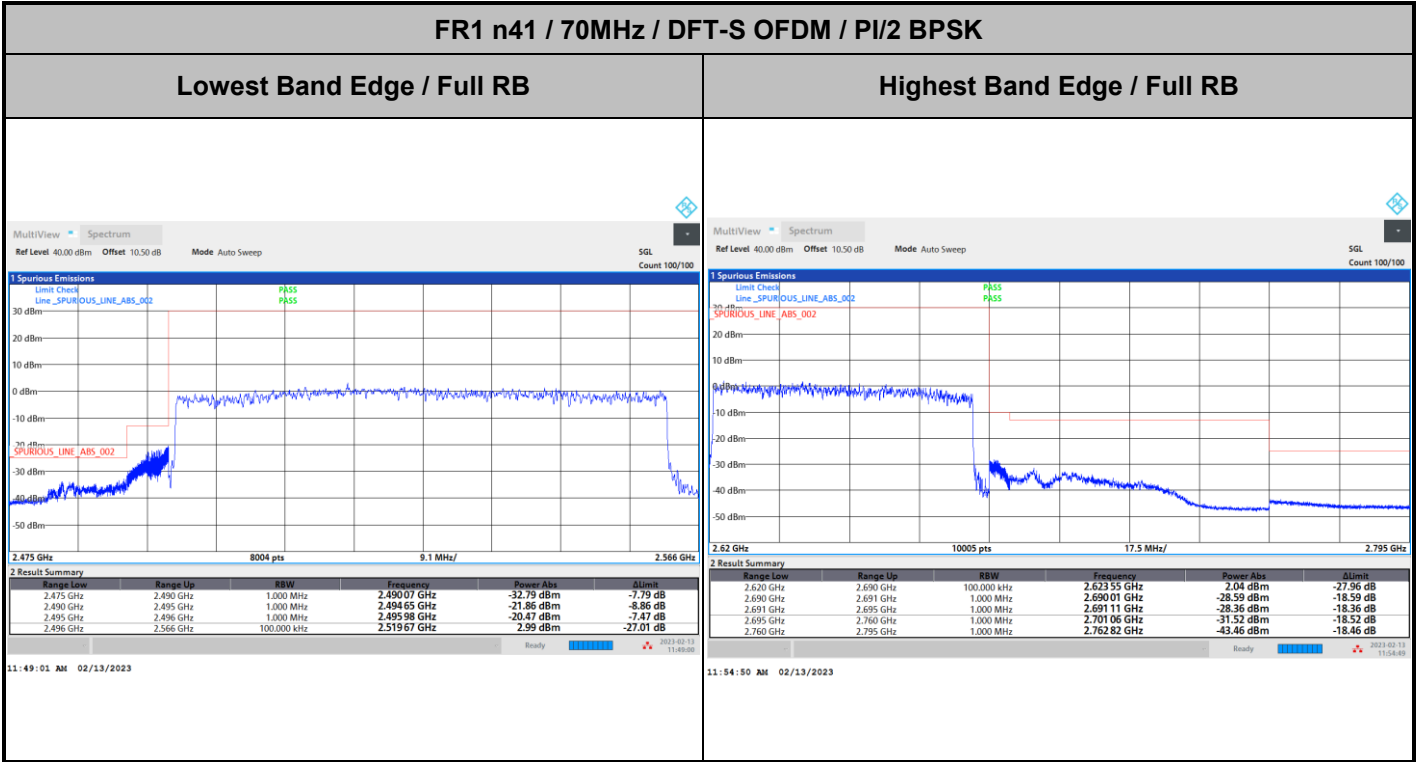



FR1 n41 / 70MHz / DFT-S OFDM / 16QAM

Lowest Band Edge / Full RB

Highest Band Edge / Full RB

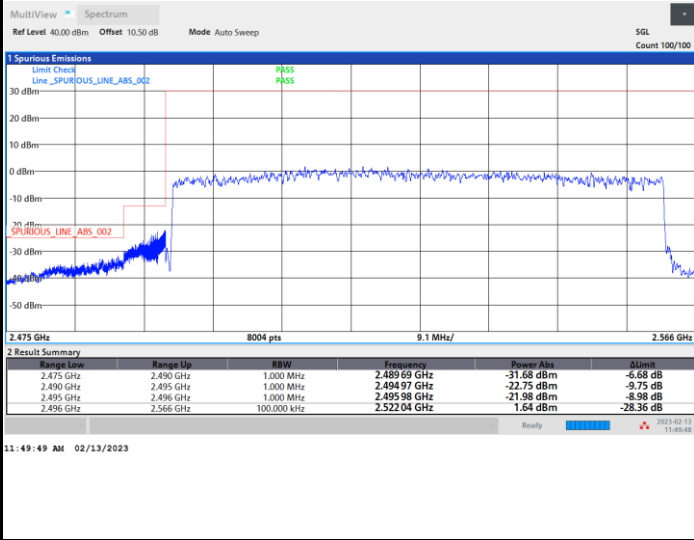

FR1 n41 / 70MHz / DFT-S OFDM / 64QAM

Lowest Band Edge / Full RB

Highest Band Edge / Full RB

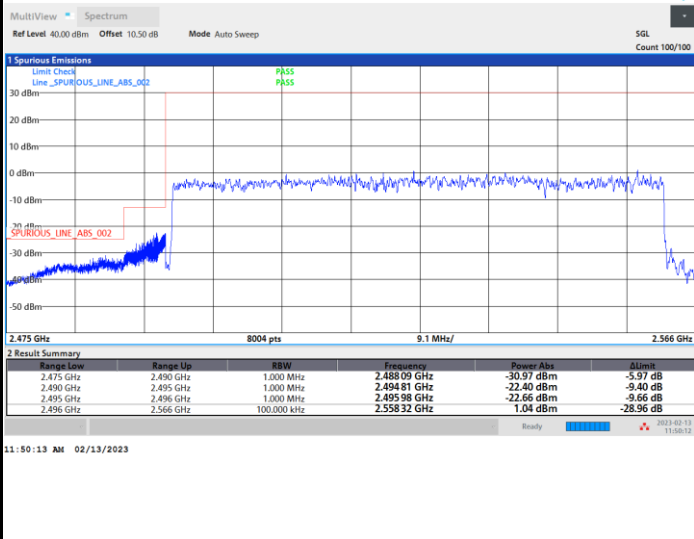



FR1 n41 / 70MHz / DFT-S OFDM / 256QAM

Lowest Band Edge / Full RB

Highest Band Edge / Full RB

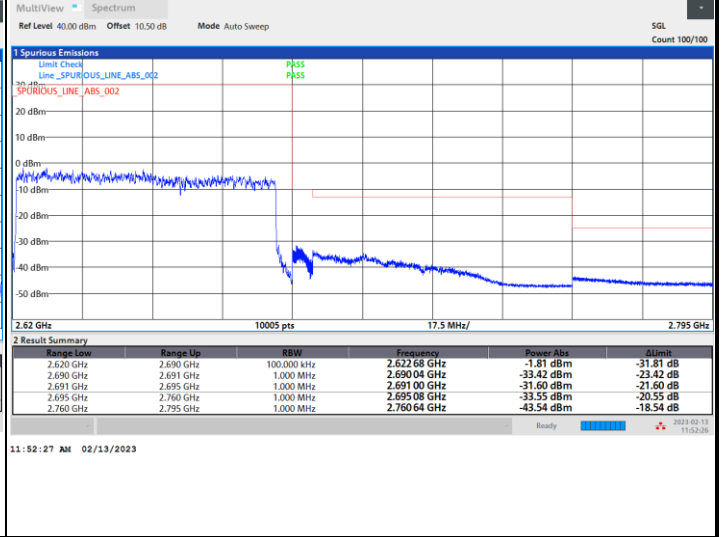
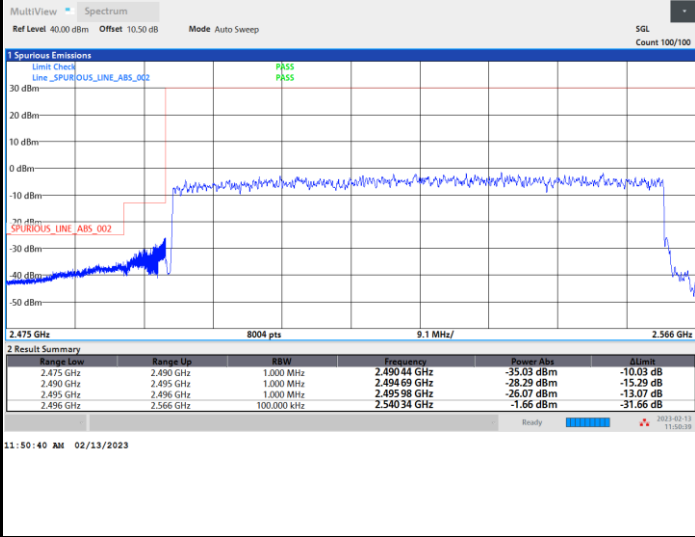

FR1 n41 / 70MHz / CP OFDM / QPSK / Full RB

Lowest Band Edge

Highest Band Edge

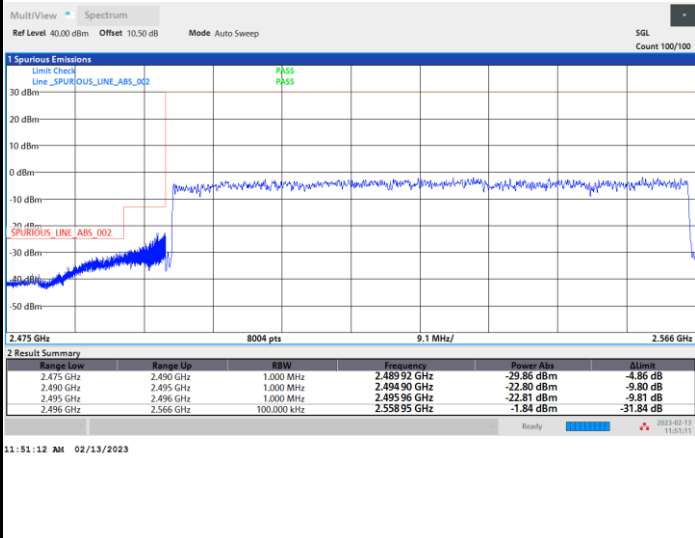



FR1 n41 PC1.5

<MIMO Mode>

MIMO <Ant. 1>

26dB Bandwidth

Mode	FR1 n41 : 26dB BW(MHz) / CP OFDM							
BW	10MHz		15MHz		20MHz		25MHz	
Mod.	QPSK	16QAM	QPSK	16QAM	QPSK	16QAM	QPSK	16QAM
Middle CH	-	-	-	-	-	-	-	-
Mod.	64QAM	256QAM	64QAM	256QAM	64QAM	256QAM	64QAM	256QAM
Middle CH	-	-	-	-	-	-	-	-
BW	30MHz		40MHz		50MHz		60MHz	
Mod.	QPSK	16QAM	QPSK	16QAM	QPSK	16QAM	QPSK	16QAM
Middle CH	-	-	-	-	-	-	-	-
Mod.	64QAM	256QAM	64QAM	256QAM	64QAM	256QAM	64QAM	256QAM
Middle CH	-	-	-	-	-	-	-	-
BW	70MHz		80MHz		90MHz		100MHz	
Mod.	QPSK	16QAM	QPSK	16QAM	QPSK	16QAM	QPSK	16QAM
Middle CH	70.77	71.19	-	-	-	-	-	-
Mod.	64QAM	256QAM	64QAM	256QAM	64QAM	256QAM	64QAM	256QAM
Middle CH	70.63	71.61	-	-	-	-	-	-



FR1 n41 / 70MHz / CP OFDM / Middle Channel / Full RB

QPSK

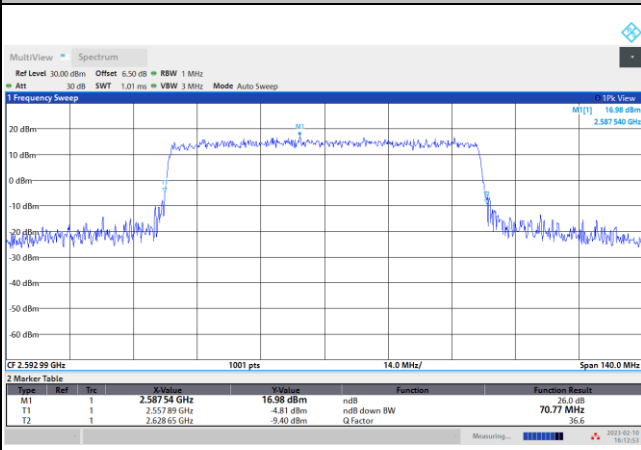

04:12:53 PM 02/10/2023

16QAM

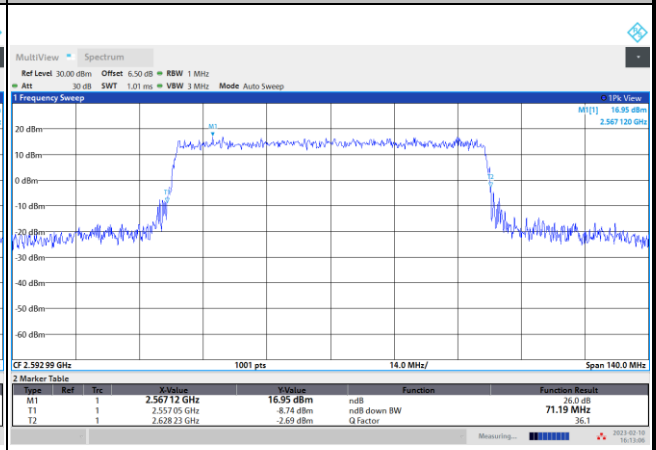

04:13:07 PM 02/10/2023

64QAM

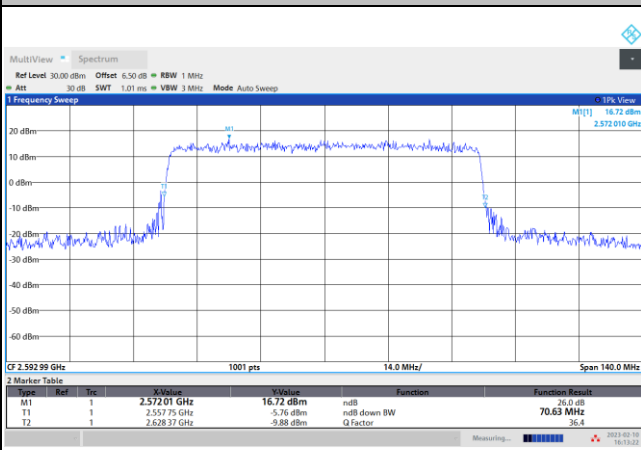

04:13:23 PM 02/10/2023

256QAM

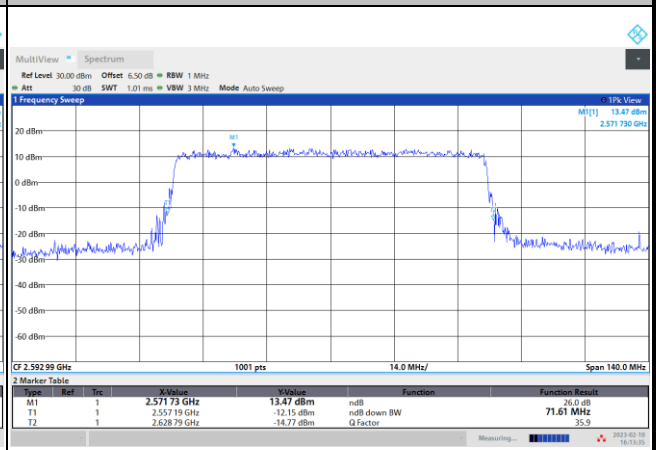

04:13:36 PM 02/10/2023



Occupied Bandwidth

Mode	FR1 n41 : OB BW(MHz) / CP OFDM							
BW	10MHz		15MHz		20MHz		25MHz	
Mod.	QPSK	16QAM	QPSK	16QAM	QPSK	16QAM	QPSK	16QAM
Middle CH	-	-	-	-	-	-	-	-
Mod.	64QAM	256QAM	64QAM	256QAM	64QAM	256QAM	64QAM	256QAM
Middle CH	-	-	-	-	-	-	-	-
BW	30MHz		40MHz		50MHz		60MHz	
Mod.	QPSK	16QAM	QPSK	16QAM	QPSK	16QAM	QPSK	16QAM
Middle CH	-	-	-	-	-	-	-	-
Mod.	64QAM	256QAM	64QAM	256QAM	64QAM	256QAM	64QAM	256QAM
Middle CH	-	-	-	-	-	-	-	-
BW	70MHz		80MHz		90MHz		100MHz	
Mod.	QPSK	16QAM	QPSK	16QAM	QPSK	16QAM	QPSK	16QAM
Middle CH	67.42	67.49	-	-	-	-	-	-
Mod.	64QAM	256QAM	64QAM	256QAM	64QAM	256QAM	64QAM	256QAM
Middle CH	67.49	67.60	-	-	-	-	-	-



FR1 n41 / 70MHz / CP OFDM / Middle Channel / Full RB

QPSK

16QAM

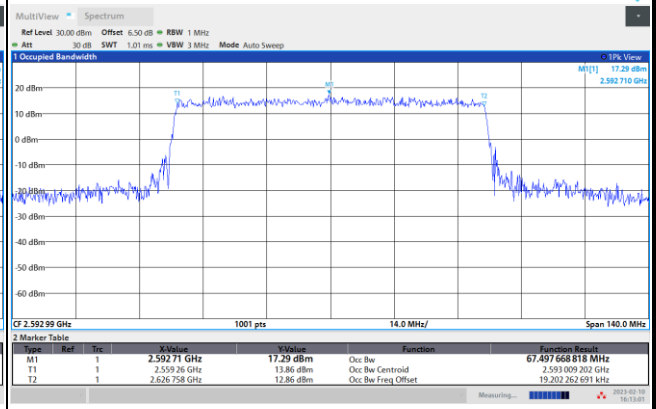
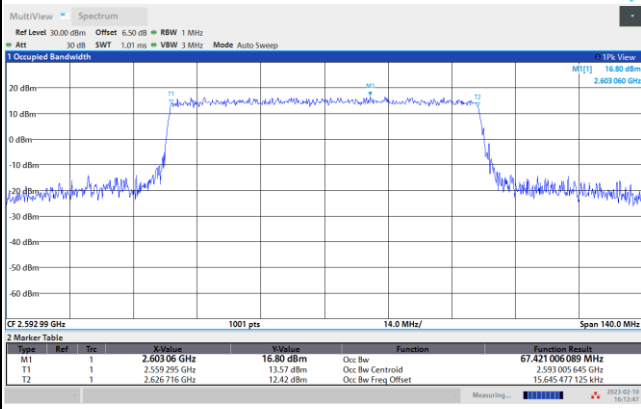

64QAM

256QAM

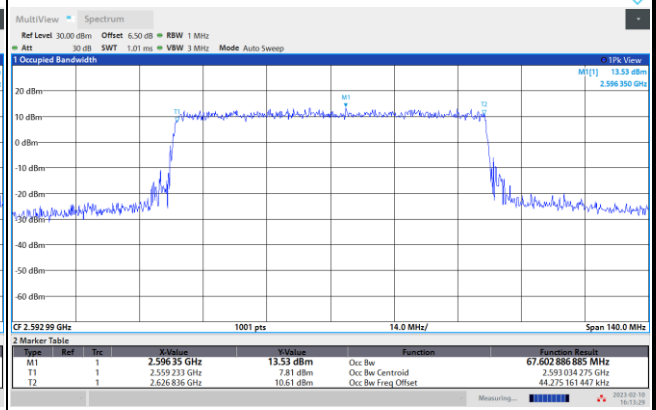
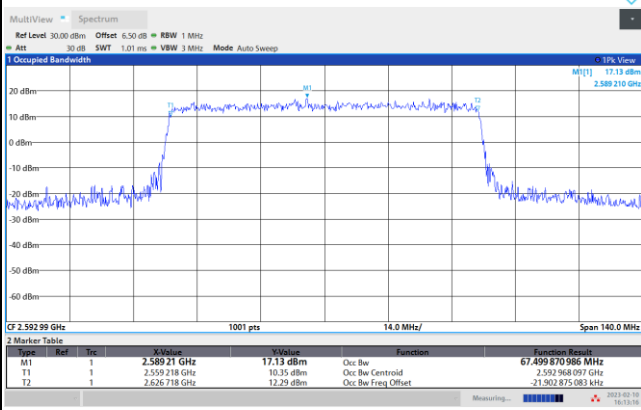



Conducted Band Edge

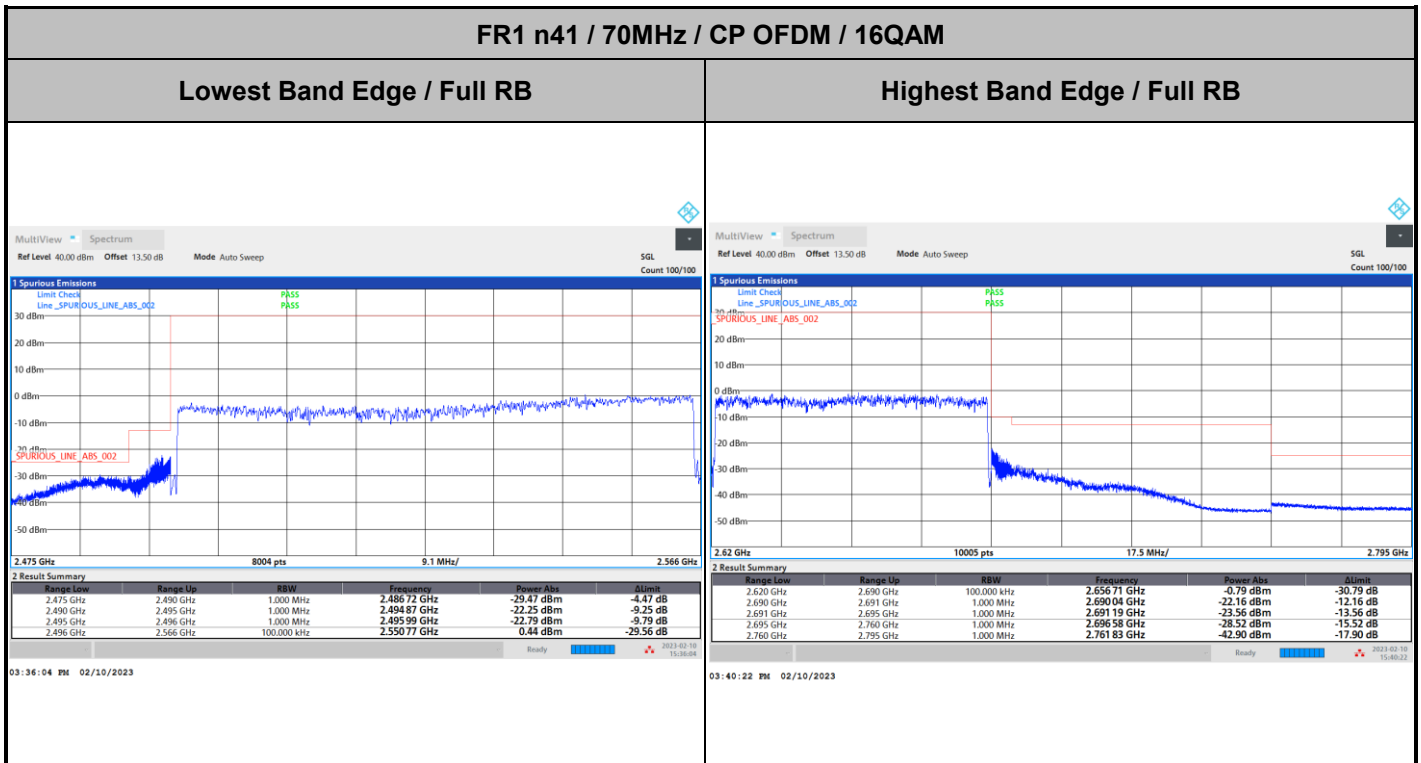
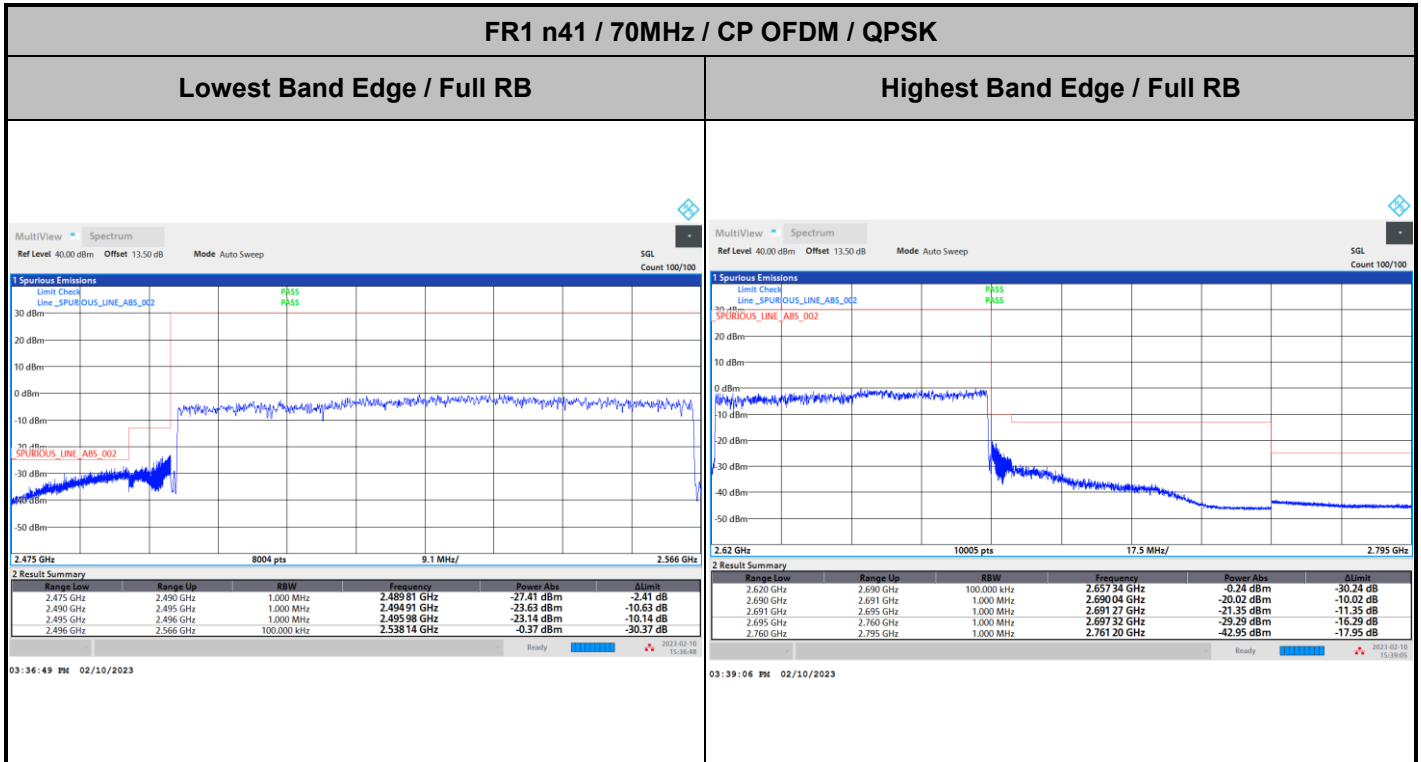



FR1 n41 / 70MHz / CP OFDM / 64QAM

Lowest Band Edge / Full RB

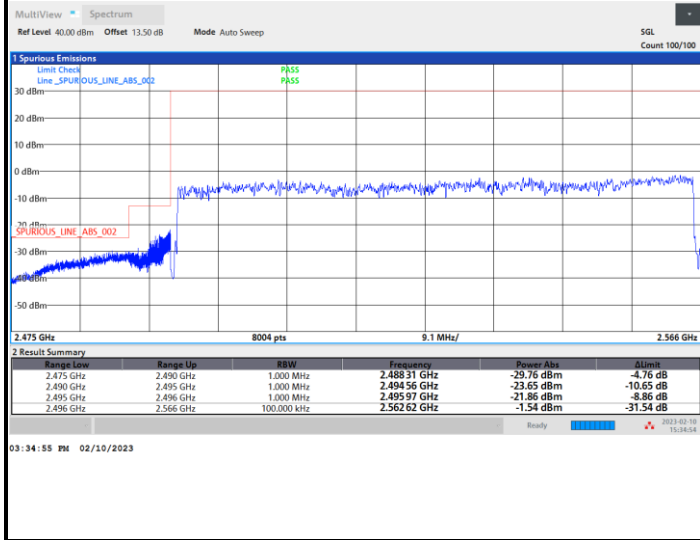

Highest Band Edge / Full RB

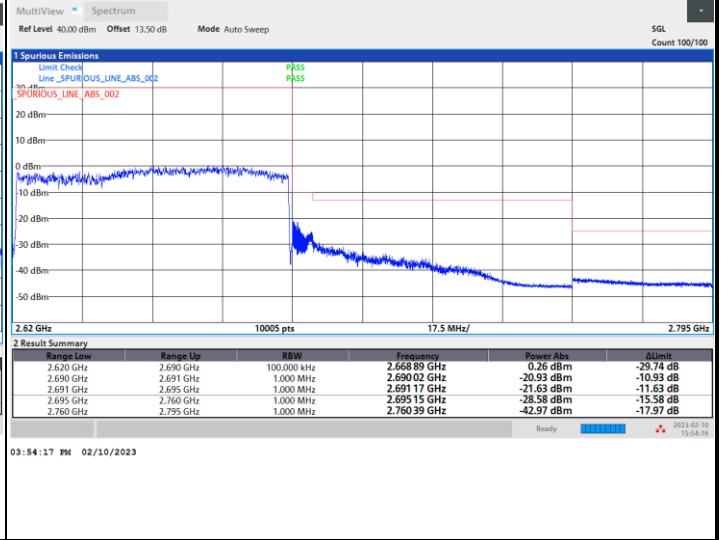

FR1 n41 / 70MHz / CP OFDM / 256QAM

Lowest Band Edge / Full RB

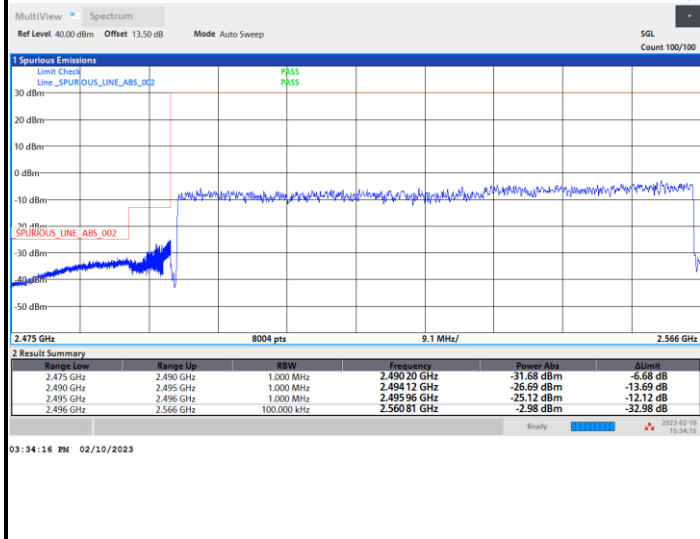

Highest Band Edge / Full RB

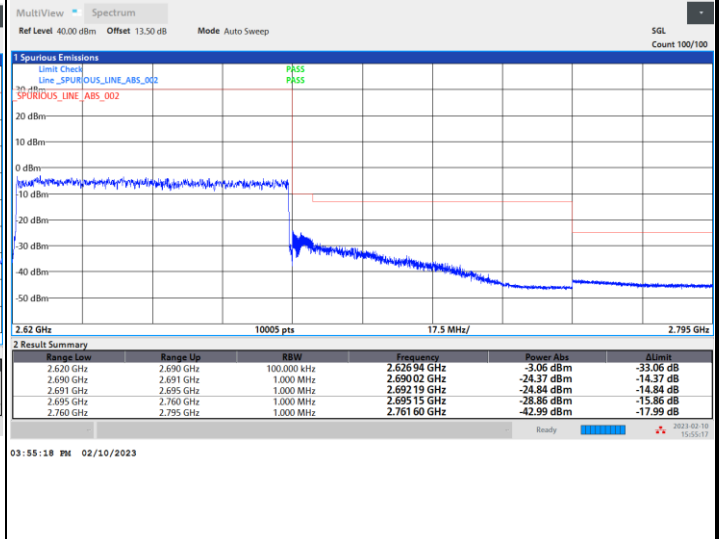



MIMO <Ant. 2>

26dB Bandwidth

Mode	FR1 n41 : 26dB BW(MHz) / CP OFDM							
BW	10MHz		15MHz		20MHz		25MHz	
Mod.	QPSK	16QAM	QPSK	16QAM	QPSK	16QAM	QPSK	16QAM
Middle CH	-	-	-	-	-	-	-	-
Mod.	64QAM	256QAM	64QAM	256QAM	64QAM	256QAM	64QAM	256QAM
Middle CH	-	-	-	-	-	-	-	-
BW	30MHz		40MHz		50MHz		60MHz	
Mod.	QPSK	16QAM	QPSK	16QAM	QPSK	16QAM	QPSK	16QAM
Middle CH	-	-	-	-	-	-	-	-
Mod.	64QAM	256QAM	64QAM	256QAM	64QAM	256QAM	64QAM	256QAM
Middle CH	-	-	-	-	-	-	-	-
BW	70MHz		80MHz		90MHz		100MHz	
Mod.	QPSK	16QAM	QPSK	16QAM	QPSK	16QAM	QPSK	16QAM
Middle CH	71.33	70.91	-	-	-	-	-	-
Mod.	64QAM	256QAM	64QAM	256QAM	64QAM	256QAM	64QAM	256QAM
Middle CH	70.91	71.61	-	-	-	-	-	-



FR1 n41 / 70MHz / CP OFDM / Middle Channel / Full RB

QPSK

16QAM

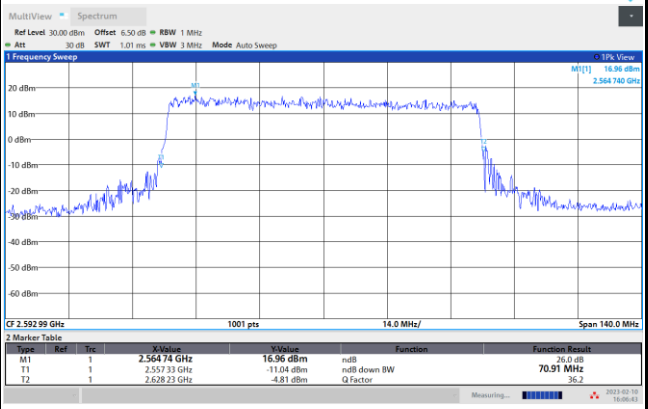
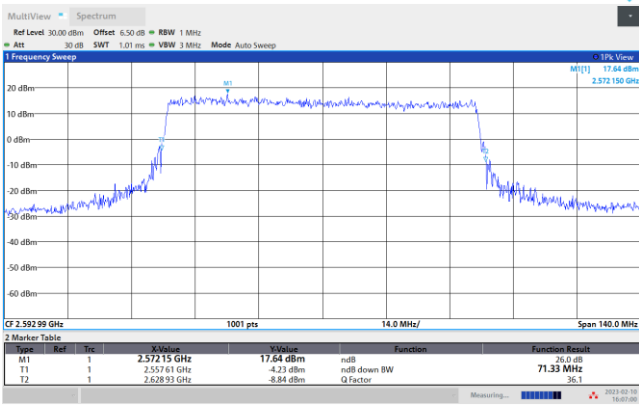

64QAM

256QAM

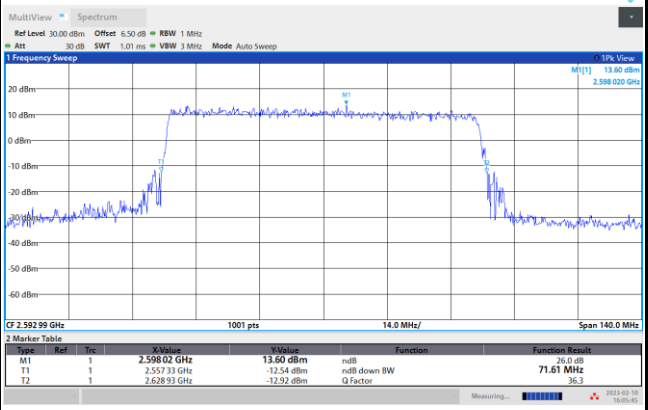
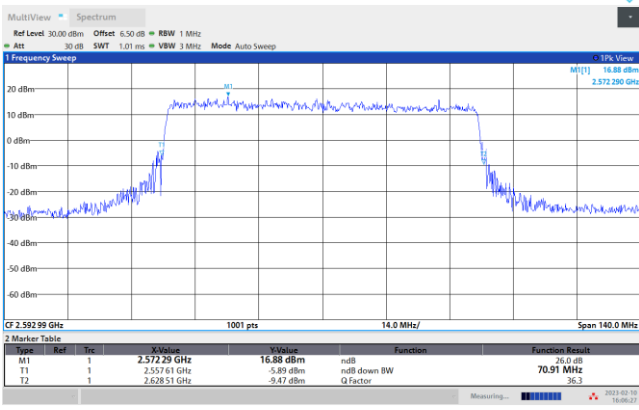



Occupied Bandwidth

Mode	FR1 n41 : OB BW(MHz) / CP OFDM							
BW	10MHz		15MHz		20MHz		25MHz	
Mod.	QPSK	16QAM	QPSK	16QAM	QPSK	16QAM	QPSK	16QAM
Middle CH	-	-	-	-	-	-	-	-
Mod.	64QAM	256QAM	64QAM	256QAM	64QAM	256QAM	64QAM	256QAM
Middle CH	-	-	-	-	-	-	-	-
BW	30MHz		40MHz		50MHz		60MHz	
Mod.	QPSK	16QAM	QPSK	16QAM	QPSK	16QAM	QPSK	16QAM
Middle CH	-	-	-	-	-	-	-	-
Mod.	64QAM	256QAM	64QAM	256QAM	64QAM	256QAM	64QAM	256QAM
Middle CH	-	-	-	-	-	-	-	-
BW	70MHz		80MHz		90MHz		100MHz	
Mod.	QPSK	16QAM	QPSK	16QAM	QPSK	16QAM	QPSK	16QAM
Middle CH	67.46	67.47	-	-	-	-	-	-
Mod.	64QAM	256QAM	64QAM	256QAM	64QAM	256QAM	64QAM	256QAM
Middle CH	67.48	67.37	-	-	-	-	-	-



FR1 n41 / 70MHz / CP OFDM / Middle Channel / Full RB

QPSK

16QAM

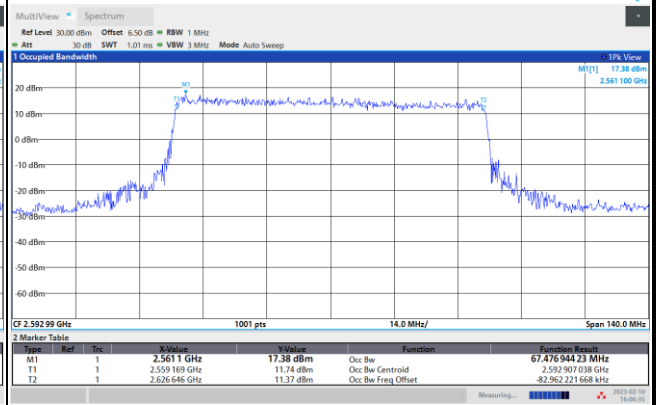
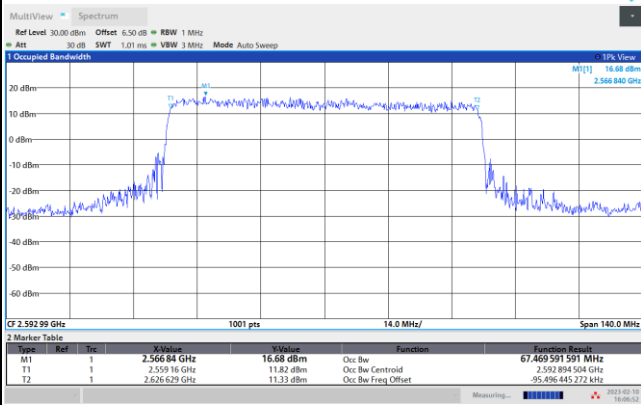

64QAM

256QAM

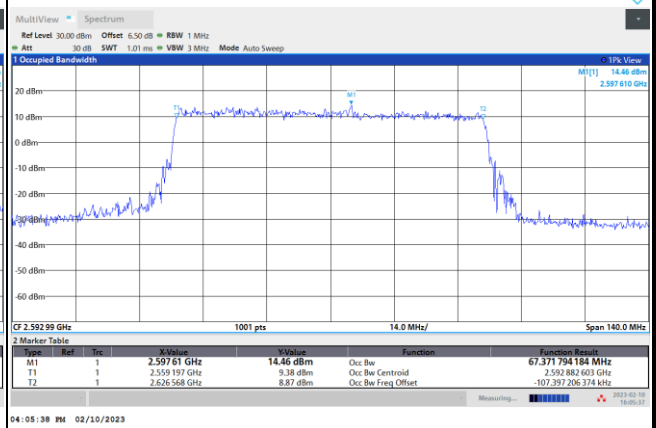
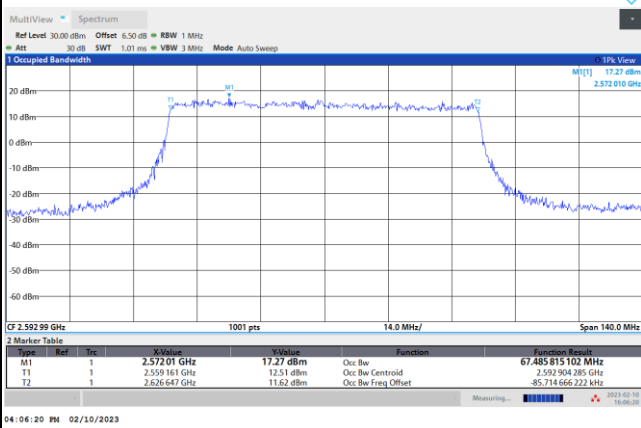



Conducted Band Edge

FR1 n41 / 70MHz / CP OFDM / QPSK

Lowest Band Edge / Full RB

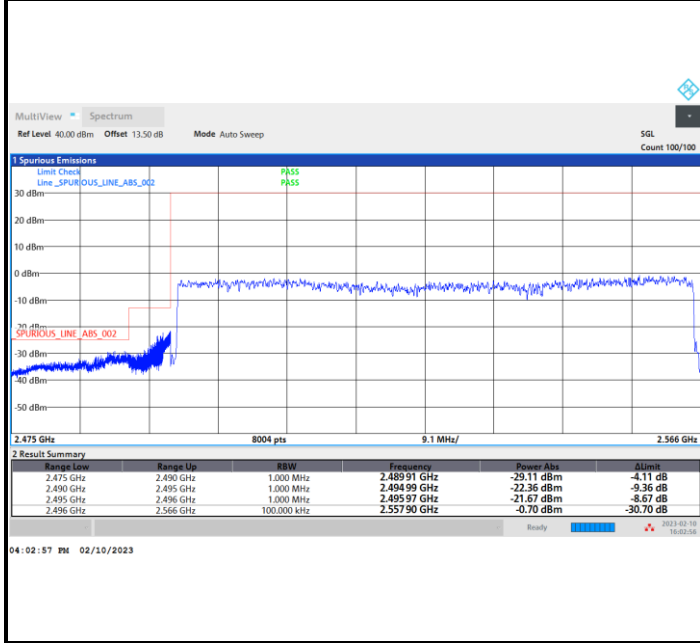

Highest Band Edge / Full RB

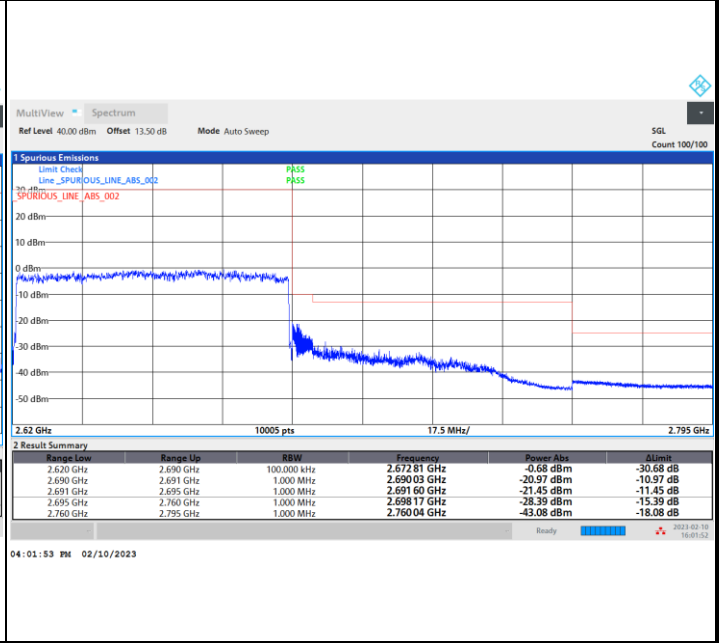

FR1 n41 / 70MHz / CP OFDM / 16QAM

Lowest Band Edge / Full RB

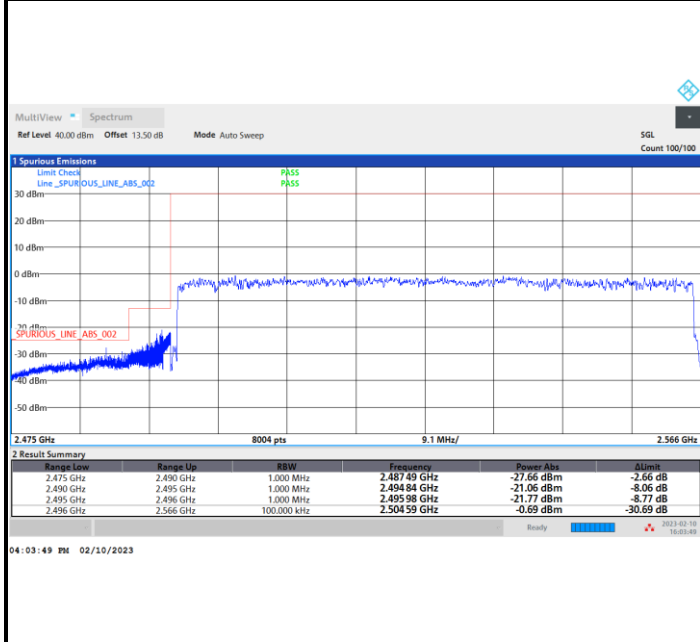

Highest Band Edge / Full RB





FR1 n41 / 70MHz / CP OFDM / 64QAM

Lowest Band Edge / Full RB

Highest Band Edge / Full RB

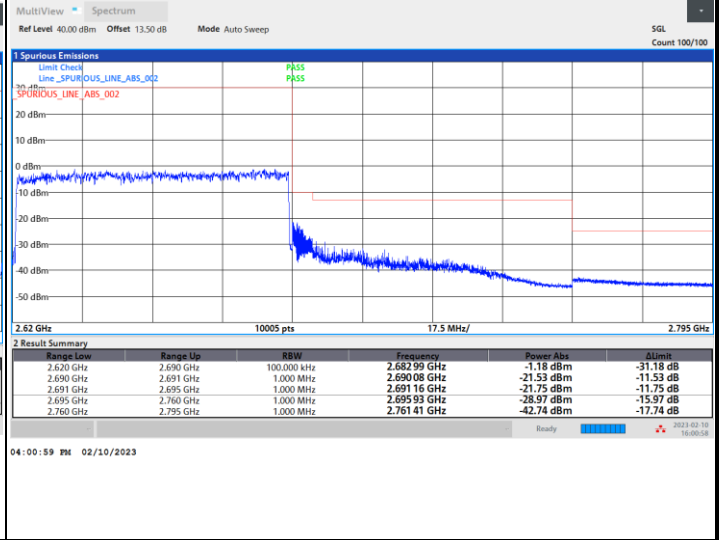
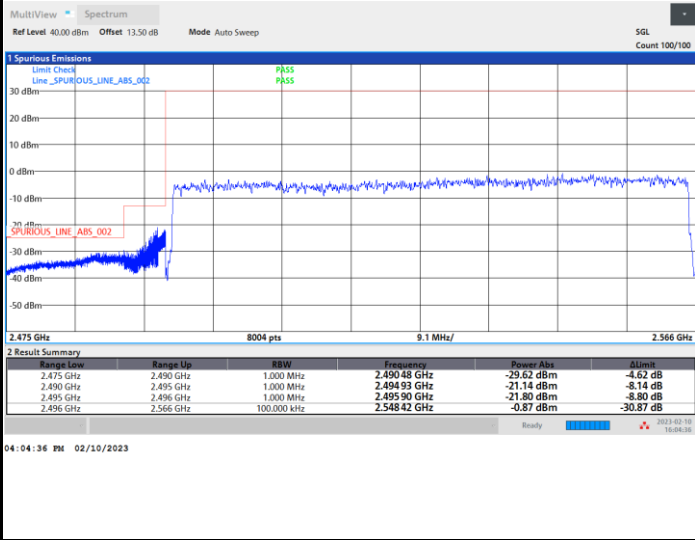

FR1 n41 / 70MHz / CP OFDM / 256QAM

Lowest Band Edge / Full RB

Highest Band Edge / Full RB

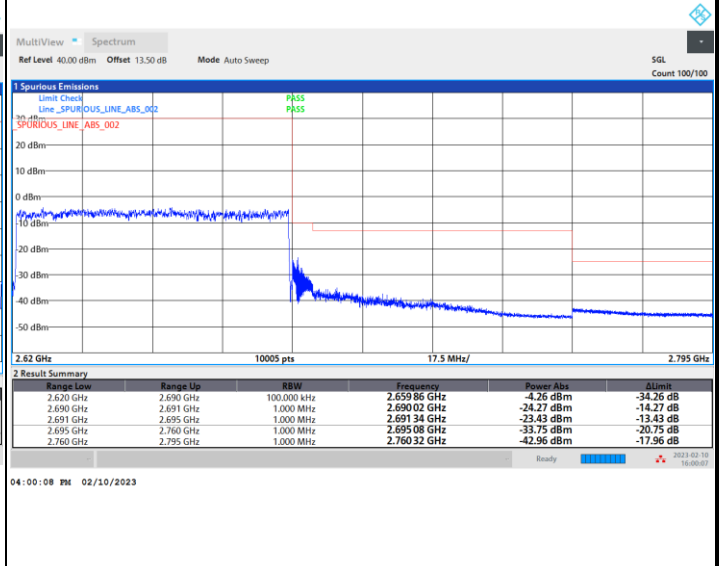
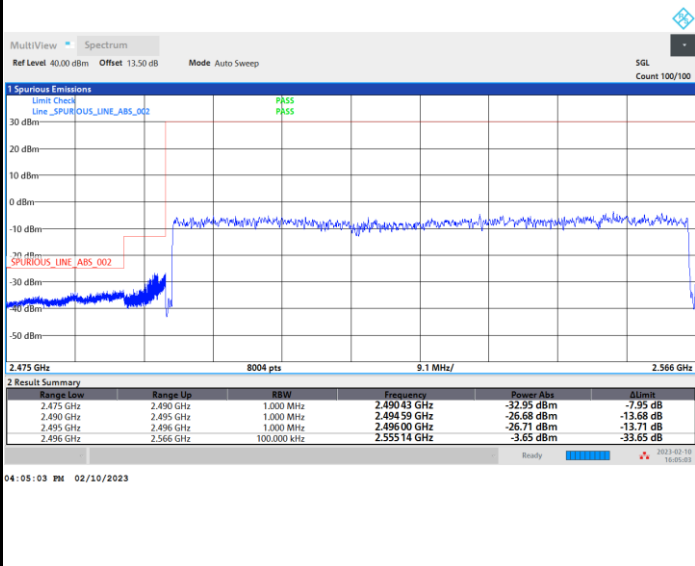

—THE END—