



FCC RADIO TEST REPORT

FCC ID : A4RGQML3
Equipment : Phone
Applicant : Google LLC
1600 Amphitheatre Parkway,
Mountain View, California, 94043 USA
Standard : FCC Part 15 Subpart E §15.407

The product was received on Mar. 17, 2022 and testing was started from Mar. 29, 2022 to May 21, 2022. We, Sporton International Inc. Wensan Laboratory, would like to declare that the tested sample has been evaluated in accordance with the test procedures and has been in compliance with the applicable technical standards.

The test results in this report apply exclusively to the tested model / sample. Without written approval of Sporton International Inc. Wensan Laboratory, the test report shall not be reproduced except in full.

Louis Wu

Approved by: Louis Wu

Sporton International Inc. Wensan Laboratory

No.58, Aly. 75, Ln. 564, Wenhua 3rd, Rd., Guishan Dist., Taoyuan City 333010, Taiwan (R.O.C)



Table of Contents

History of this test report.....	3
Summary of Test Result.....	4
1 General Description	5
1.1 Product Feature of Equipment Under Test.....	5
1.2 Product Specification of Equipment Under Test.....	6
1.3 Modification of EUT	6
1.4 Testing Location	7
1.5 Applicable Standards.....	7
2 Test Configuration of Equipment Under Test	8
2.1 Carrier Frequency and Channel	8
2.2 Test Mode.....	9
2.3 Connection Diagram of Test System.....	10
2.4 Support Unit used in test configuration and system	11
2.5 EUT Operation Test Setup	11
2.6 Measurement Results Explanation Example.....	12
3 Test Result	13
3.1 6dB and 26dB and 99% Occupied Bandwidth Measurement	13
3.2 Maximum E.I.R.P Output Power Measurement	19
3.3 Power Spectral Density Measurement	20
3.4 Unwanted Emissions Measurement.....	27
3.5 AC Conducted Emission Measurement.....	32
3.6 Antenna Requirements	34
4 List of Measuring Equipment.....	36
5 Uncertainty of Evaluation	38
Appendix A. Conducted Test Results	
Appendix B. AC Conducted Emission Test Result	
Appendix C. Radiated Spurious Emission	
Appendix D. Radiated Spurious Emission Plots	
Appendix E. Duty Cycle Plots	
Appendix F. Setup Photographs	



History of this test report

Report No.	Version	Description	Issue Date
FR1O2843-05J	01	Initial issue of report	Jun. 10, 2022
FR1O2843-05J	02	Revise Power Spectral Density Data	Jul. 06, 2022
FR1O2843-05J	03	Revise Power Spectral Density Test Procedures	Jul. 08, 2022
FR1O2843-05J	04	Removed antenna standard typo.	Jul. 15, 2022



Summary of Test Result

Report Clause	Ref Std. Clause	Test Items	Result (PASS/FAIL)	Remark
3.1	15.407(e)	6dB & 26dB Bandwidth	Pass	-
3.1	2.1049	99% Occupied Bandwidth	Reporting only	-
3.2	15.407(a)	Maximum E.I.R.P Output Power	Pass	-
3.3	15.407(a)	Power Spectral Density	Pass	-
3.4	15.407(b)	Unwanted Emissions	Pass	2.46 dB under the limit at 5925.500 MHz
3.5	15.207	AC Conducted Emission	Pass	21.09 dB under the limit at 1.473 MHz
3.6	15.203 15.407(a)	Antenna Requirement	Pass	-

Declaration of Conformity:

1. The test results (PASS/FAIL) with all measurement uncertainty excluded are presented in accordance with the regulation limits or requirements declared by manufacturers. It's means measurement values may risk exceeding the limit of regulation standards, if measurement uncertainty is include in test results.
2. The measurement uncertainty please refer to this report "Uncertainty of Evaluation".

Comments and Explanations:

The product specifications of the EUT presented in the report are declared by the manufacturer who shall take full responsibility for the authenticity.

Reviewed by: William Chen

Report Producer: Clio Lo



1 General Description

1.1 Product Feature of Equipment Under Test

Product Feature	
Equipment	Phone
FCC ID	A4RGQML3
EUT supports Radios application	GSM/EGPRS/WCDMA/HSPA/LTE/5G NR/NFC/GNSS/ WPC/WPT WLAN 11b/g/n HT20 WLAN 11a/n HT20/HT40 WLAN 11ac VHT20/VHT40/VHT80/VHT160 WLAN 11ax HE20/HE40/HE80/HE160 Bluetooth BR/EDR/LE

Remark: The above EUT's information was declared by manufacturer.

EUT Information List	
S/N	Performed Test Item
23031FDH20007N	RF Conducted Measurement
23121FDH20002A	Radiated Spurious Emission
23121FDH20005C	Conducted Emission

1.2 Product Specification of Equipment Under Test

Product Specification is subject to this standard							
Tx/Rx Frequency Range	5850 MHz ~ 5895 MHz						
Maximum Output Power	MIMO <Ant. 4+3> 802.11a: 24.17 dBm / 0.2611 W 802.11n HT20: 24.47 dBm / 0.2797 W 802.11n HT40: 24.56 dBm / 0.2859 W 802.11ac VHT20: 24.57 dBm / 0.2863 W 802.11ac VHT40: 24.66 dBm / 0.2926 W 802.11ac VHT80: 23.27 dBm / 0.2122 W 802.11ac VHT160: 22.01 dBm / 0.1589 W 802.11ax HE20: 24.67 dBm / 0.2929 W 802.11ax HE40: 24.76 dBm / 0.2994 W 802.11ax HE80: 23.37 dBm / 0.2171 W 802.11ax HE160: 22.11 dBm / 0.1626 W						
99% Occupied Bandwidth	MIMO <Ant. 4> 802.11a: 22.23 MHz 802.11ax HE20: 23.98 MHz 802.11ax HE40: 52.45 MHz 802.11ax HE80: 77.56 MHz 802.11ax HE160: 156.80 MHz MIMO <Ant. 3> 802.11a: 20.58 MHz 802.11ax HE20: 22.78 MHz 802.11ax HE40: 46.85 MHz 802.11ax HE80: 77.44 MHz 802.11ax HE160: 156.80 MHz						
Antenna Type / Gain	<Ant. 4> : IFA Antenna with gain -0.5 dBi <Ant. 3> : IFA Antenna with gain -2.1 dBi						
Type of Modulation	802.11a/n : OFDM (BPSK / QPSK / 16QAM / 64QAM) 802.11ac : OFDM (BPSK / QPSK / 16QAM / 64QAM / 256QAM) 802.11ax : OFDMA (BPSK / QPSK / 16QAM / 64QAM / 256QAM / 1024QAM)						
Antenna Function Description	<table border="1"> <thead> <tr> <th></th> <th>Ant. 4</th> <th>Ant. 3</th> </tr> </thead> <tbody> <tr> <td>802.11 a/n/ac/ax MIMO</td> <td>V</td> <td>V</td> </tr> </tbody> </table>		Ant. 4	Ant. 3	802.11 a/n/ac/ax MIMO	V	V
	Ant. 4	Ant. 3					
802.11 a/n/ac/ax MIMO	V	V					

Remark:

- MIMO Ant. 4+3 Directional Gain is a calculated result from MIMO Ant. 4 and MIMO Ant. 3. The formula used in calculation is documented in section 3.6.
- Power of MIMO Ant. 4 + Ant. 3 is a calculated result from sum of the power MIMO Ant. 4 and MIMO Ant. 3.
- The above EUT's information was declared by manufacturer. Please refer to Comments and Explanations in report summary.

1.3 Modification of EUT

No modifications are made to the EUT during all test items.



1.4 Testing Location

Test Site	Sporton International Inc. EMC & Wireless Communications Laboratory
Test Site Location	No.52, Huaya 1st Rd., Guishan Dist., Taoyuan City 333, Taiwan (R.O.C.) TEL: +886-3-327-3456 FAX: +886-3-328-4978
Test Site No.	Sporton Site No. CO05-HY (TAF Code: 1190)
Remark	The Conducted Emission test item subcontracted to Sporton International Inc. EMC & Wireless Communications Laboratory.

Note: The test site complies with ANSI C63.4 2014 requirement.

Test Site	Sporton International Inc. Wensan Laboratory
Test Site Location	No.58, Aly. 75, Ln. 564, Wenhua 3rd, Rd., Guishan Dist., Taoyuan City 333010, Taiwan (R.O.C.) TEL: +886-3-327-0868 FAX: +886-3-327-0855
Test Site No.	Sporton Site No. TH05-HY, 03CH16-HY

Note: The test site complies with ANSI C63.4 2014 requirement.

FCC designation No.: TW1190 and TW3786

1.5 Applicable Standards

According to the specifications of the manufacturer, the EUT must comply with the requirements of the following standards:

- ♦ FCC Part 15 Subpart E
- ♦ FCC KDB 789033 D02 General UNII Test Procedures New Rules v02r01.
- ♦ FCC KDB 414788 D01 Radiated Test Site v01r01.
- ♦ FCC KDB 662911 D01 Multiple Transmitter Output v02r01.
- ♦ FCC KDB 291074 D02 EMC Measurement v01 (Draft)
- ♦ ANSI C63.10-2013

Remark:

1. All the test items were validated and recorded in accordance with the standards without any modification during the testing.
2. The TAF code is not including all the FCC KDB listed without accreditation.



2 Test Configuration of Equipment Under Test

- a. The EUT has been associated with peripherals and configuration operated in a manner tended to maximize its emission characteristics in a typical application. Frequency range investigated: conduction emission (150 kHz to 30 MHz), radiation emission (9 kHz to the 10th harmonic of the highest fundamental frequency or to 40 GHz, whichever is lower). For radiated measurement, the measured emission level of the EUT was maximized by rotating the EUT on a turntable, adjusting the orientation of the EUT and EUT antenna in three orthogonal axis (X: flat, Y: portrait, Z: landscape) and accessory (Adapter or Earphone), and adjusting the measurement antenna orientation, following C63.10 exploratory test procedures and find X plane with Adapter as worst plane.

- b. AC power line Conducted Emission was tested under maximum output power.

2.1 Carrier Frequency and Channel

Frequency Band	Bandwidth	Channel	Frequency (MHz)	Note
5850-5895 MHz (U-NII-4)	20 MHz	169	5845	Straddle
		173	5865	
		177	5885	
	40 MHz	167	5835	Straddle
		175	5875	
	80 MHz	171	5855	Straddle
160 MHz	163	5815	Straddle	

Note: The channel noted with "straddle" spans 5.725-5.850 GHz and 5.850-5.895 GHz.



2.2 Test Mode

This device support 26/52/106/242/484/996-tone RU but does not support 2x996-tone RU on 160MHz channel.

The PSD of partial RU is reduced to be smaller than full RU according to TCB workshop interim guidance Oct., 2018.

The 242-tone RU is covered by 20MHz channel, 484-tone RU is covered by 40MHz channel and 996-tone RU is covered by 80MHz channel.

The 802.11ax mode is investigated among different tones, full resource units (RU), partial resource units. The partial RU has no higher power than full RU's, thus the full RU is chosen as main test configuration.

The CDD mode is chosen as worst case configuration for all test cases due to higher power than SISO mode.

The 802.11n/ac mode has no higher power and PSD than 802.11ax mode, thus the 802.11ax mode is chosen as main test configuration, and the 802.11n/ac mode is verified the power.

Final test modes are considering the modulation and worse data rates as below table.

Specification	MCS index /Data Rate
802.11a	6 Mbps
802.11n HT20 (Covered by HE20)	MCS0
802.11n HT40 (Covered by HE40)	MCS0
802.11ac VHT20 (Covered by HE20)	MCS0
802.11ac VHT40 (Covered by HE40)	MCS0
802.11ac VHT80 (Covered by HE80)	MCS0
802.11ac VHT160 (Covered by HE160)	MCS0
802.11ax HE20	MCS0
802.11ax HE40	MCS0
802.11ax HE80	MCS0
802.11ax HE160	MCS0

Remark: The conducted power level of each chain in MIMO mode is equal or higher than SISO mode.

Test Cases	
AC Conducted Emission	Mode 1 : GSM850 Idle + WLAN (5GHz) Link + Bluetooth Link + USB Cable 1 (Charging from Adapter 2)
Remark:	
<ol style="list-style-type: none"> For Radiated Test Cases, the tests were performed with Adapter 2 and USB Cable 1. During the preliminary test, both charging modes (Adapter mode and WPT Charging mode) were verified. It is determined that the adaptor mode is the worst case for official test. 	

Ch. #		RF test channel of UNII-4 and UNII-3 &-4 span channels				
		802.11a	802.11ax HE20	802.11ax HE40	802.11ax HE80	802.11ax HE160
L	Low	169	169	167	-	-
M	Middle	173	173	-	171	163
H	High	177	177	175	-	-

Remark: For radiation spurious emission, the modulation and the data rate picked for testing are determined by the Max. RF conducted power.

2.3 Connection Diagram of Test System

<AC Conducted Emission Mode>

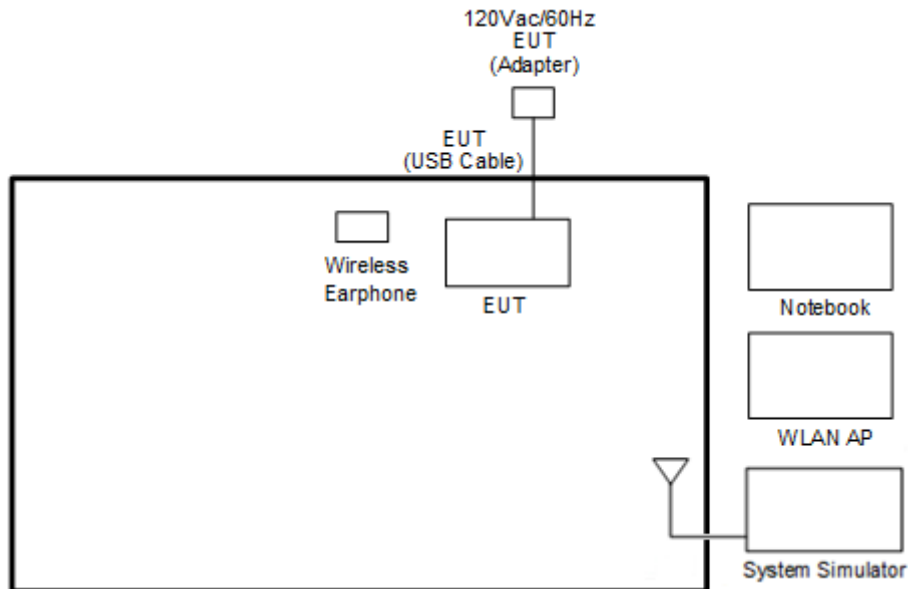

<WLAN Tx Mode>

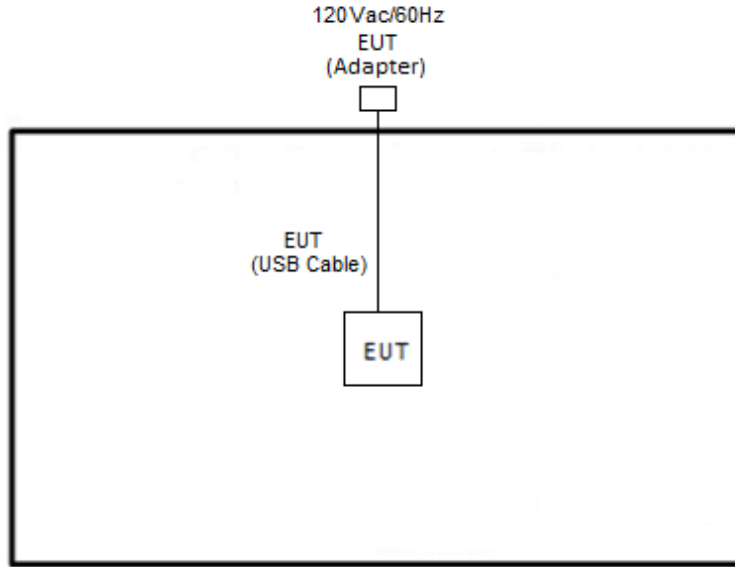

2.4 Support Unit used in test configuration and system

Item	Equipment	Brand Name	Model Name	FCC ID	Data Cable	Power Cord
1.	System Simulator	Anritsu	MT8820C	N/A	N/A	Unshielded, 1.8 m
2.	Wireless Earphone	Google	G1007/G1008	A4RG1007/ A4RG1008	N/A	N/A
3.	WLAN AP	ASUS	RT-AC66U	MSQ-RTAC66U	N/A	Unshielded,1.8m
4.	Notebook	DELL	Latitude 3400	FCC DoC	N/A	AC I/P: Unshielded, 1.2 m DC O/P: Shielded, 1.8 m

2.5 EUT Operation Test Setup

The RF test items, utility “adb Command 1.0.36” was installed in Notebook which was programmed in order to make the EUT get into the engineering modes to provide channel selection, power level, data rate and the application type and for continuous transmitting signals.



2.6 Measurement Results Explanation Example

For all conducted test items:

The offset level is set in the spectrum analyzer to compensate the RF cable loss and attenuator factor between EUT conducted output port and spectrum analyzer. With the offset compensation, the spectrum analyzer reading level is exactly the EUT RF output level.

Example :

The spectrum analyzer offset is derived from RF cable loss and attenuator factor.

Offset = RF cable loss + attenuator factor.

Following shows an offset computation example with cable loss 4.2 dB and 10 dB attenuator.

$$\begin{aligned} \text{Offset(dB)} &= \text{RF cable loss(dB)} + \text{attenuator factor(dB)}. \\ &= 4.2 + 10 = 14.2 \text{ (dB)} \end{aligned}$$

3 Test Result

3.1 6dB and 26dB and 99% Occupied Bandwidth Measurement

3.1.1 Description of 6dB and 26dB and 99% Occupied Bandwidth

The minimum 6 dB bandwidth shall be at least 500 kHz.

26dB and 99% Occupied bandwidth are reporting only.

3.1.2 Measuring Instruments

See list of measuring equipment of this test report.

3.1.3 Test Procedures

The testing follows FCC KDB 291074 D02 EMC Measurement v01 (Draft) Section 2.11 Minimum Emission bandwidth

1. Set RBW = 100 kHz.
2. Set the VBW $\geq 3 \times$ RBW.
3. Detector = Peak.
4. Trace mode = max hold
5. Measure the maximum width of the emission that is 6 dB down from the peak of the emission.
6. Measure and record the results in the test report.

3.1.4 Test Setup

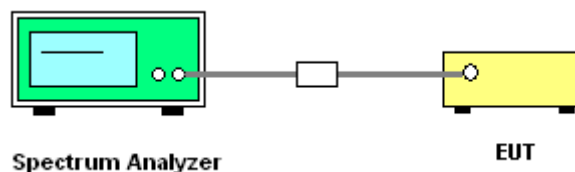

3.1.5 Test Result of 6dB and 26dB and 99% Occupied Bandwidth

Please refer to Appendix A.



MIMO <Ant. 4+3>

<802.11a Mode>

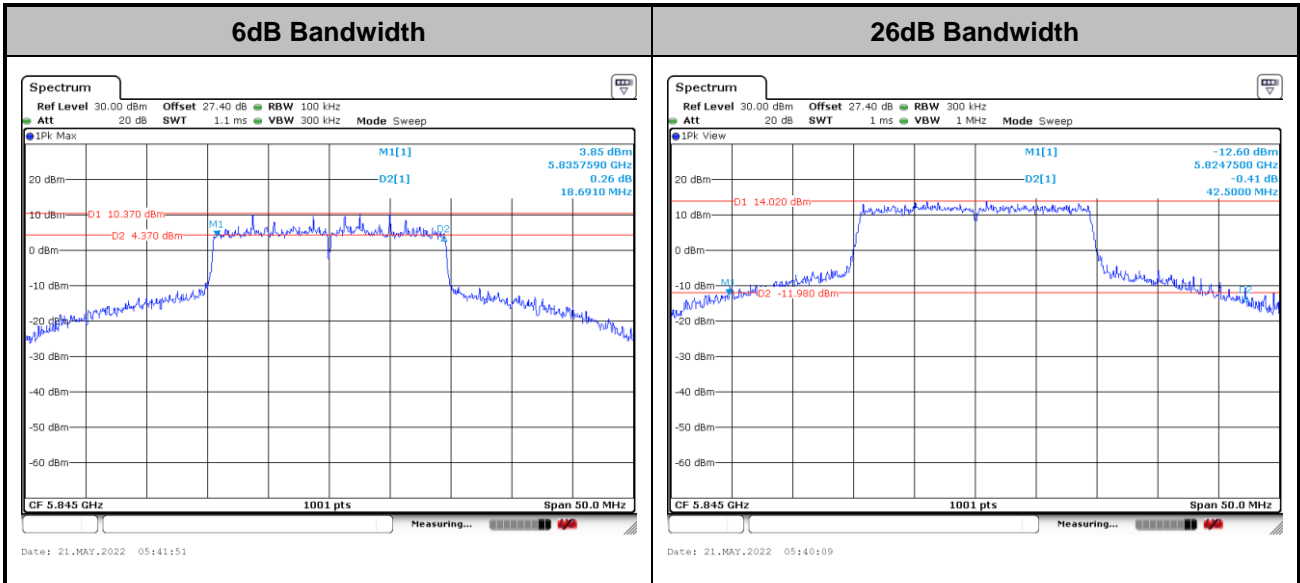

Occupied Bandwidth

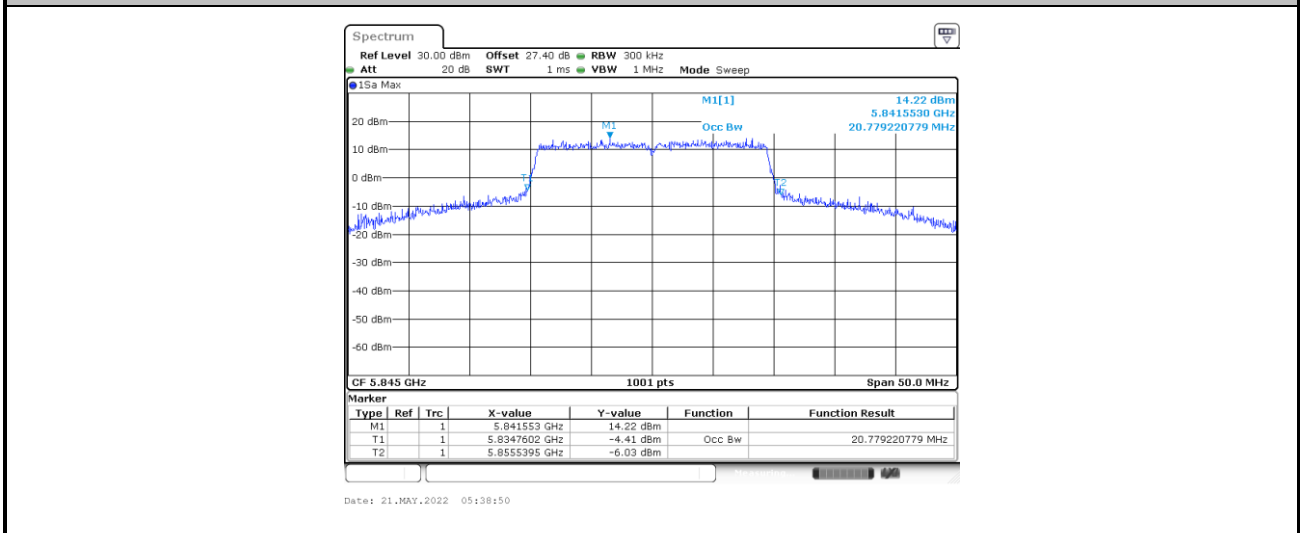

Note: The occupied channel bandwidth is maintained within the band of operation.



<802.11ax HE20 Mode>

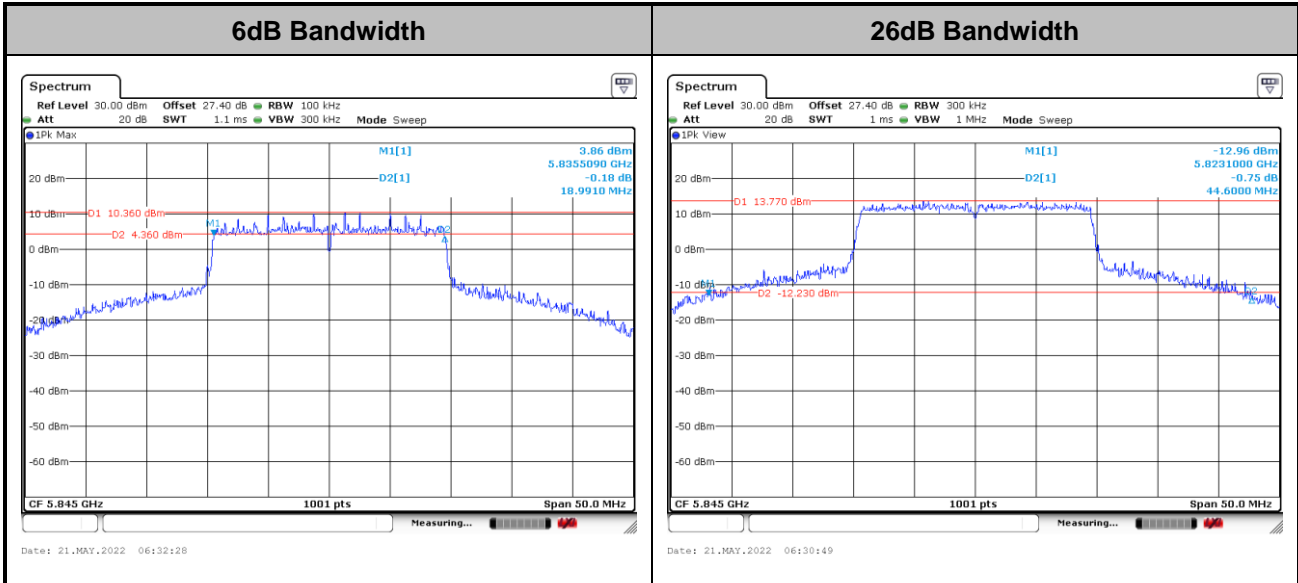

Occupied Bandwidth

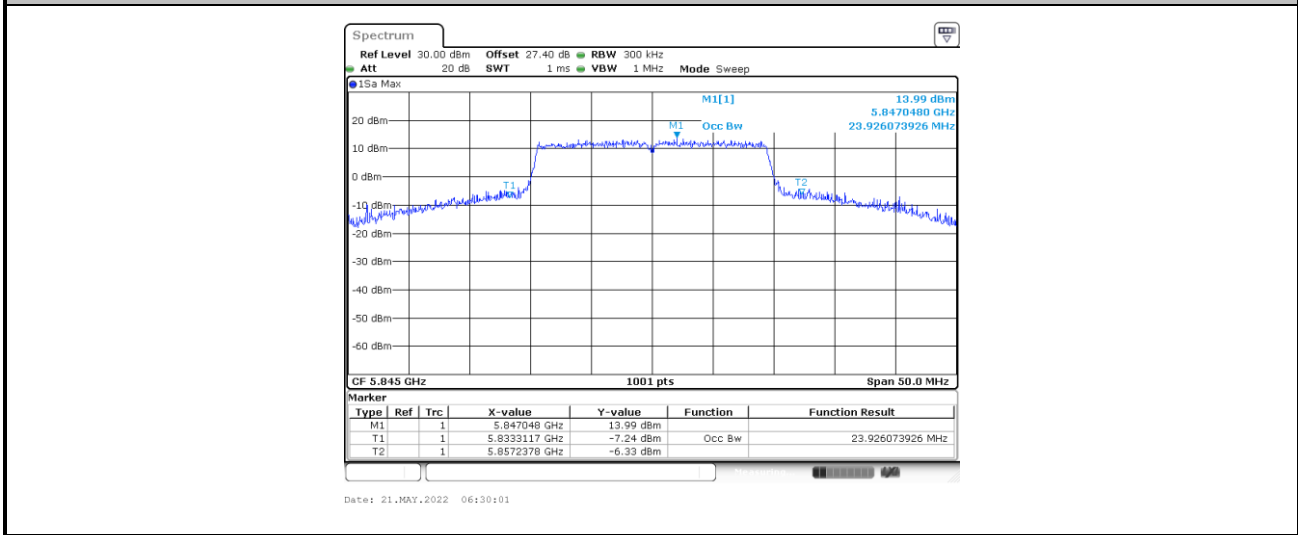

Note: The occupied channel bandwidth is maintained within the band of operation.



<802.11ax HE40 Mode>

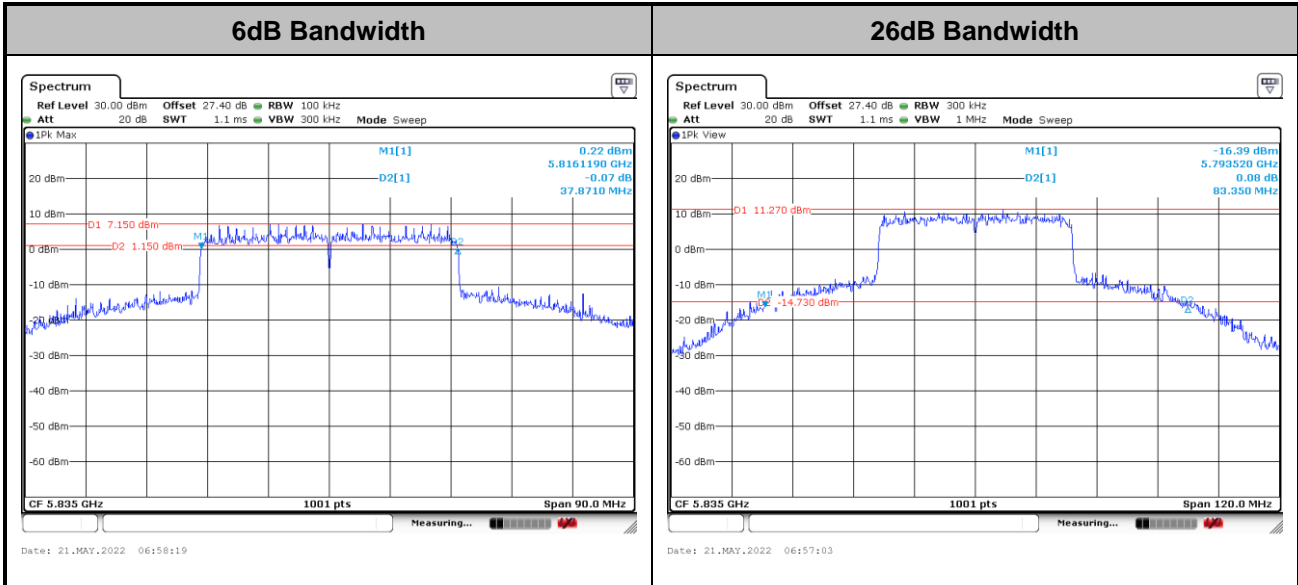

Occupied Bandwidth

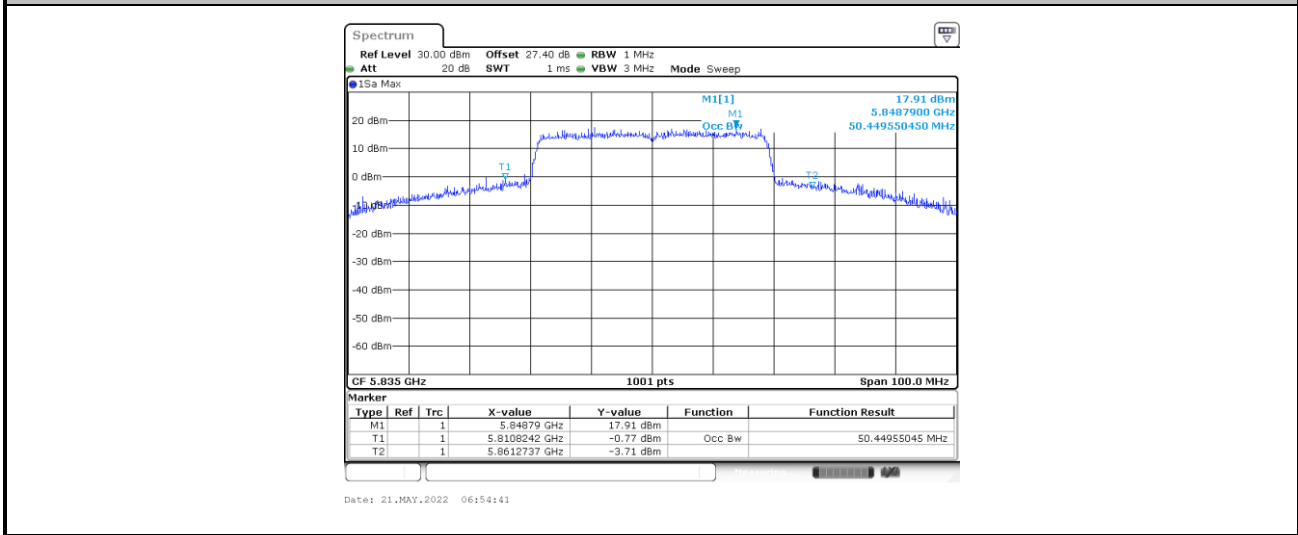

Note: The occupied channel bandwidth is maintained within the band of operation.



<802.11ax HE80 Mode>

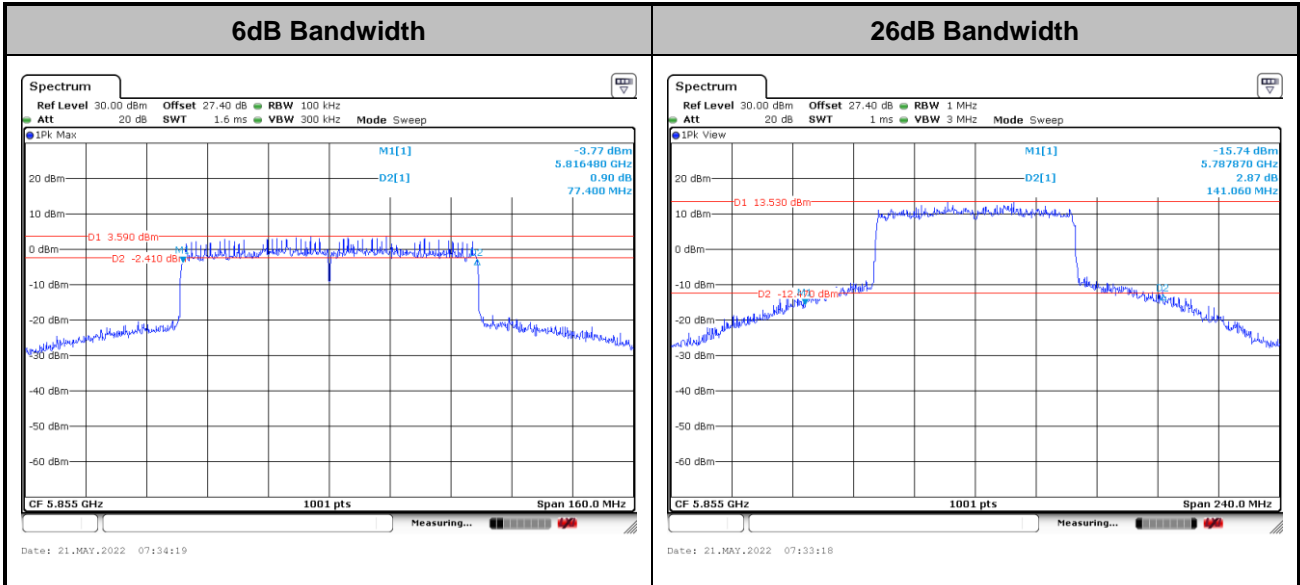

Occupied Bandwidth

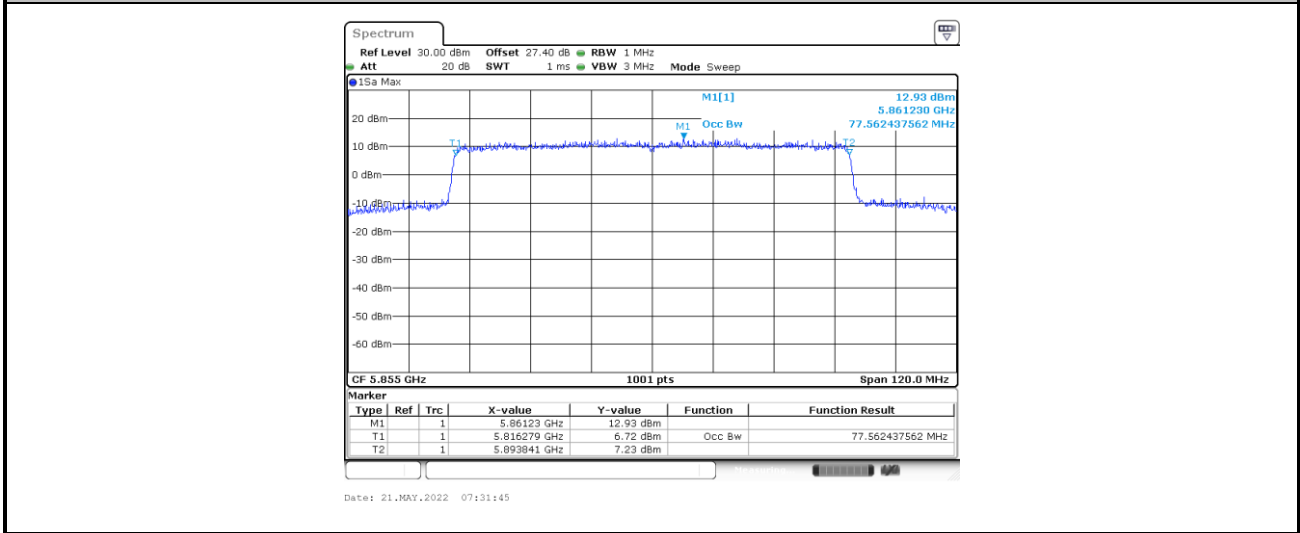

Note: The occupied channel bandwidth is maintained within the band of operation.



<802.11ax HE160 Mode>

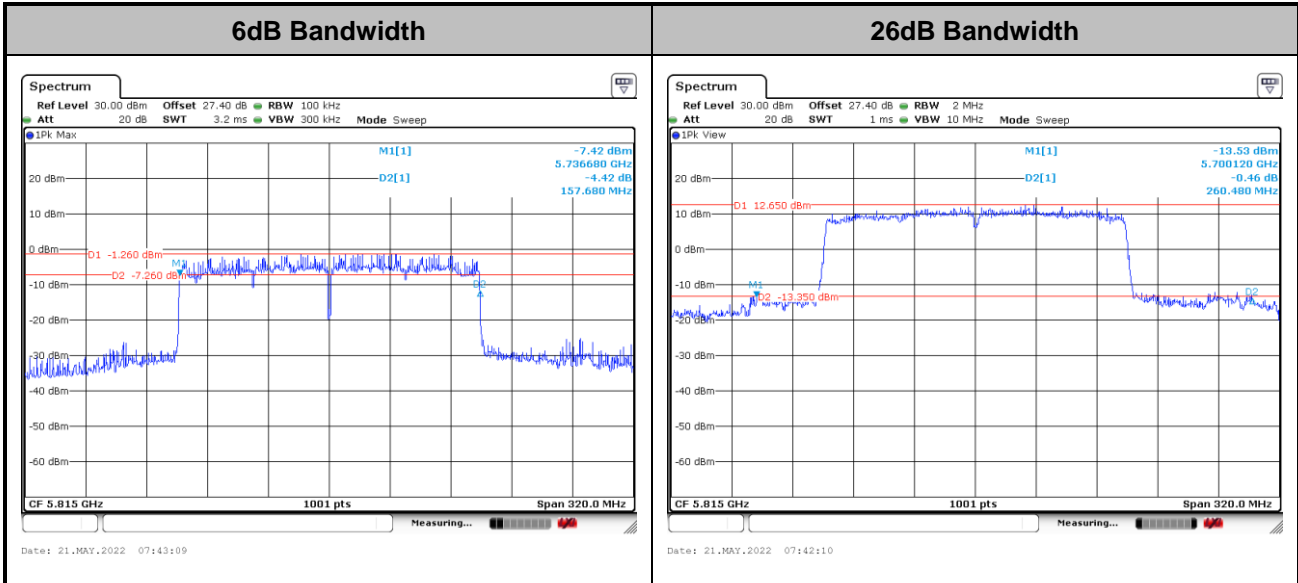

Occupied Bandwidth

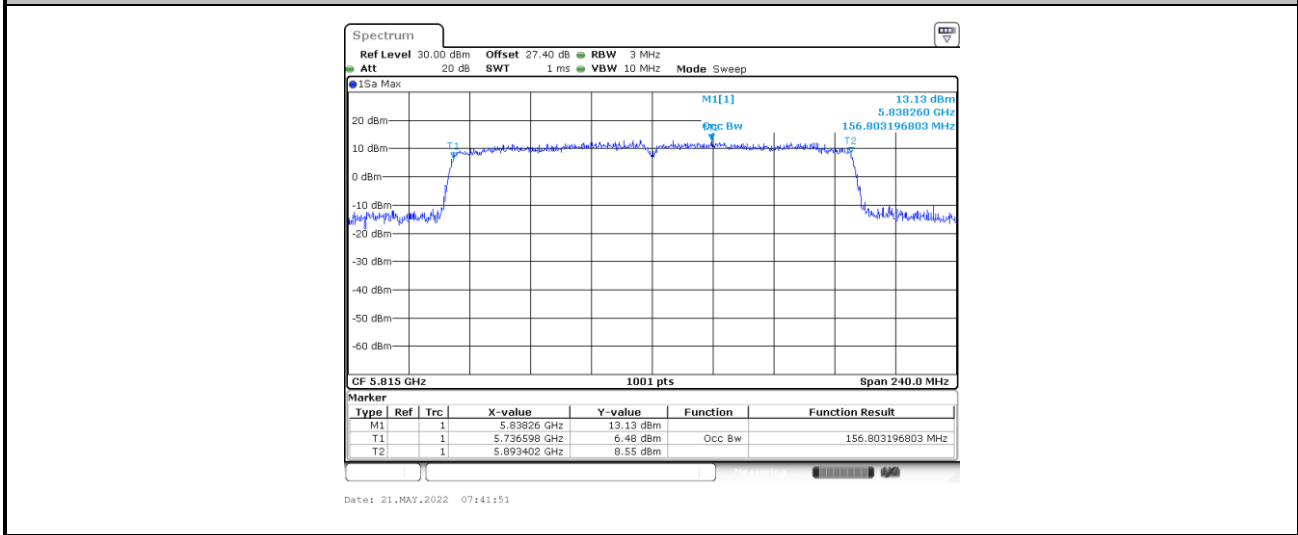

Note: The occupied channel bandwidth is maintained within the band of operation.

3.2 Maximum E.I.R.P Output Power Measurement

3.2.1 Limit of Maximum E.I.R.P Output Power

For client devices operating under the control of an indoor access point in the 5.850-5.895 GHz band, the maximum power spectral density must not exceed 14 dBm e.i.r.p. in any 1-megahertz band, and the maximum e.i.r.p. over the frequency band of operation must not exceed 30 dBm. Client devices operating on a channel that spans the 5.725-5.850 GHz and 5.850-5.895 GHz bands must not exceed an e.i.r.p. of 30 dBm.

3.2.2 Measuring Instruments

See list of measuring equipment of this test report.

3.2.3 Test Procedures

The testing follows Method PM-G of FCC KDB 789033 D02 General UNII Test Procedures New Rules v02r01.

Method PM-G (Measurement using a gated RF average power meter):

1. Measurement is performed using a wideband RF power meter.
2. The EUT is configured to transmit at its maximum power control level.
3. Measure the average power of the transmitter.
4. Since the measurement is made only during the ON time of the transmitter, no duty cycle correction factor is required.
5. For MIMO mode, calculation method follows FCC KDB 662911 D01 Multiple Transmitter Output v02r01.

3.2.4 Test Setup

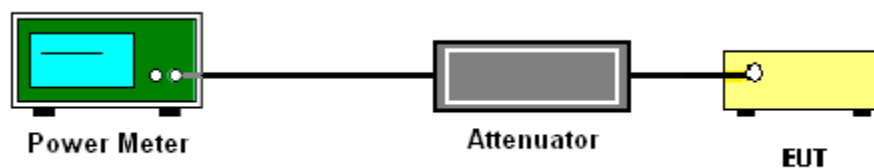

3.2.5 Test Result of Maximum Conducted Output Power

Please refer to Appendix A.



3.3 Power Spectral Density Measurement

3.3.1 Limit of Power Spectral Density

1. For client devices operating under the control of an indoor access point in the 5.850-5.895 GHz band, the maximum power spectral density must not exceed 14 dBm e.i.r.p. in any 1-megahertz band.
2. For client devices operating on a channel that spans the 5.725-5.850 GHz and 5.850-5.895 GHz bands shall meet both 15.407(a)(3)(i) 30dBm/500kHz and 15.407(a)(3)(iii) 14dBm/MHz limit, where the stringent limit 14dBm/MHz is applied.

3.3.2 Measuring Instruments

See list of measuring equipment of this test report.

3.3.3 Test Procedures

The testing follows FCC KDB 789033 D02 General UNII Test Procedures New Rules v02r01.

Section F) Maximum power spectral density.

Method SA-2

(trace averaging across on and off times of the EUT transmissions, followed by duty cycle correction).

- Measure the duty cycle.
 - Set span to encompass the entire emission bandwidth (EBW) of the signal.
 - Set RBW = 1 MHz.
 - Set VBW \geq 3 MHz.
 - Number of points in sweep \geq 2 Span / RBW.
 - Sweep time = auto.
 - Detector = RMS
 - Trace average at least 100 traces in power averaging mode.
 - Add $10 \log(1/x)$, where x is the duty cycle, to the measured power in order to compute the average power during the actual transmission times. For example, add $10 \log(1/0.25) = 6$ dB if the duty cycle is 25 percent.
1. The RF output of EUT is connected to the spectrum analyzer by a low loss cable.
 2. Each plot has already offset with cable loss, and attenuator loss. Measure the PPSD and record it.
 3. For MIMO mode, calculation method follows FCC KDB 662911 D01 Multiple Transmitter Output v02r01.

Method (a): Measure and sum the spectra across the outputs.

The total final Power Spectral Density is from a device with 2 transmitter outputs. The spectrum measurements of the individual outputs are all performed with the same span and number of points; the spectrum value in the first spectral bin of output 1 is summed with that in the first spectral bin of output 2 to obtain the value for the first frequency bin of the summed spectrum.

3.3.4 Test Setup

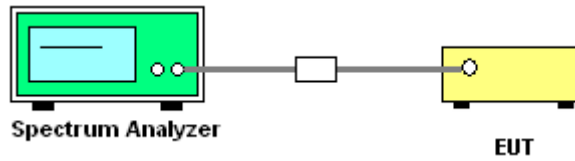

3.3.5 Test Result of Power Spectral Density

Please refer to Appendix A.



<802.11a>

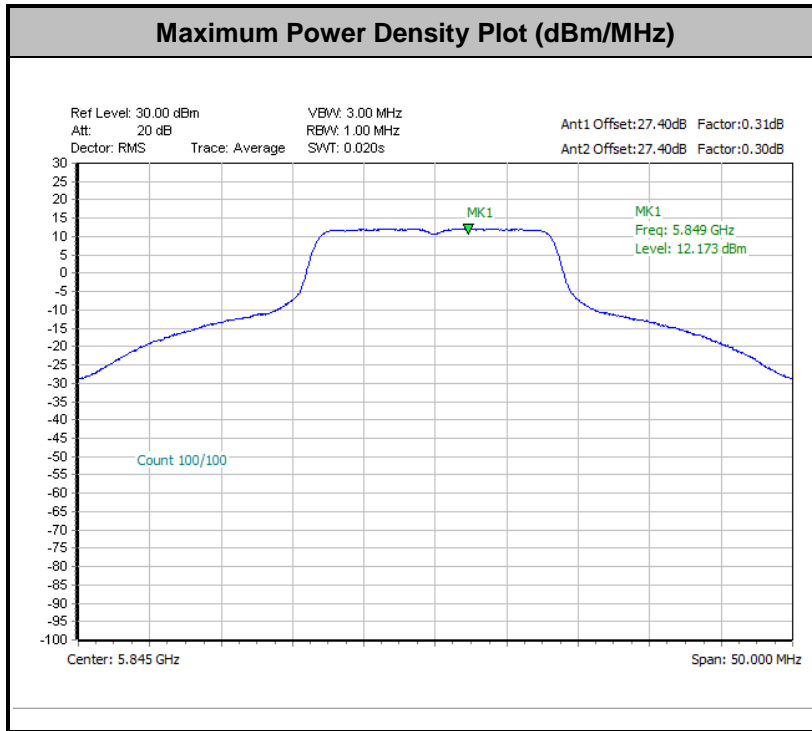

Remark: The test plot is showing a bin by bin combined result mathematically adds two traces.

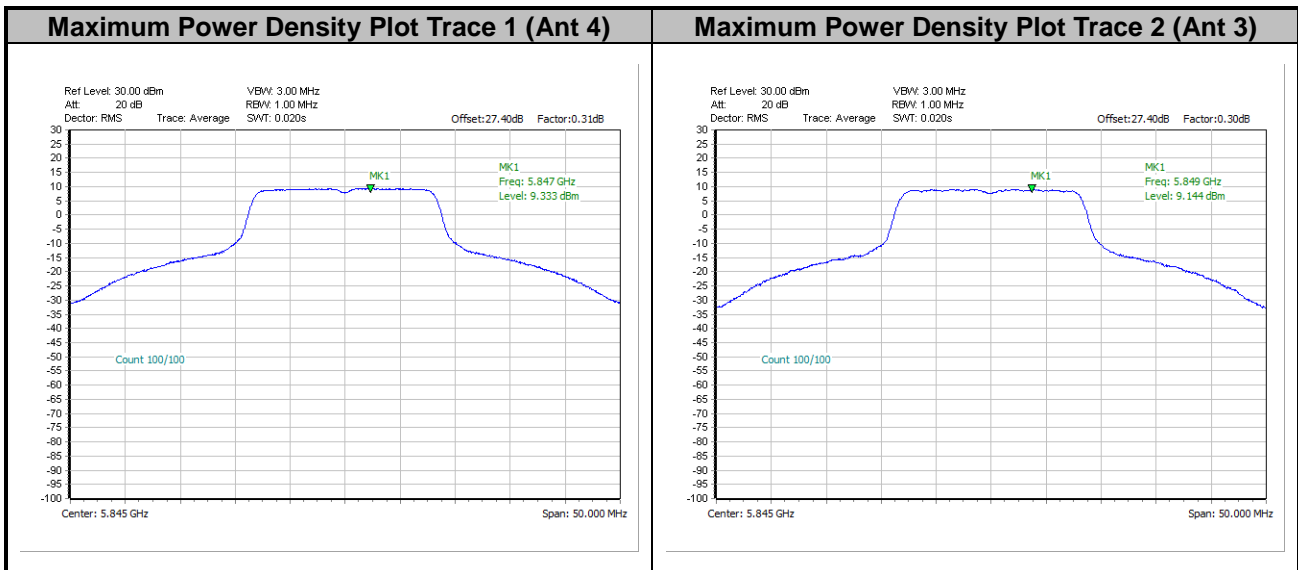



<802.11ax HE20>

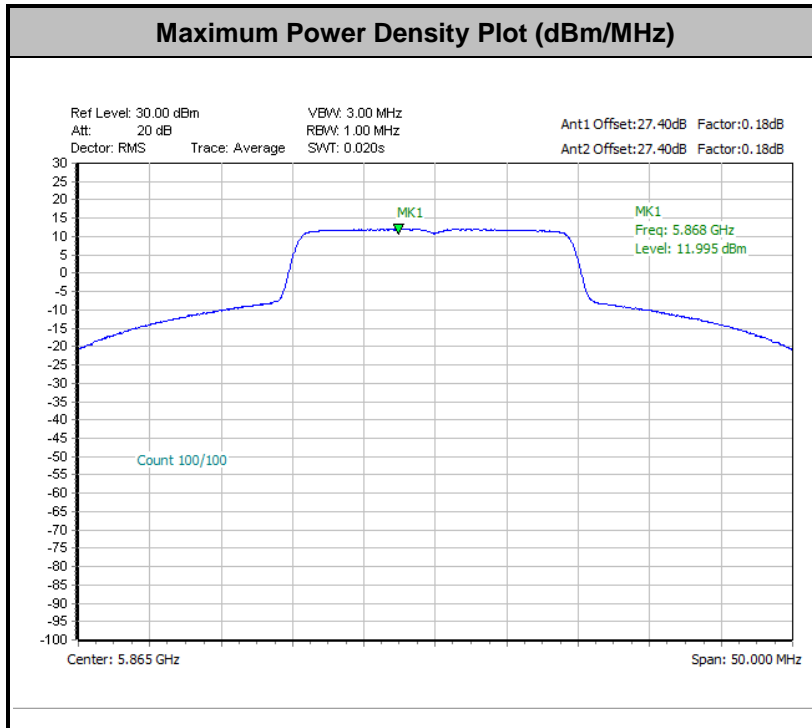

Remark: The test plot is showing a bin by bin combined result mathematically adds two traces.

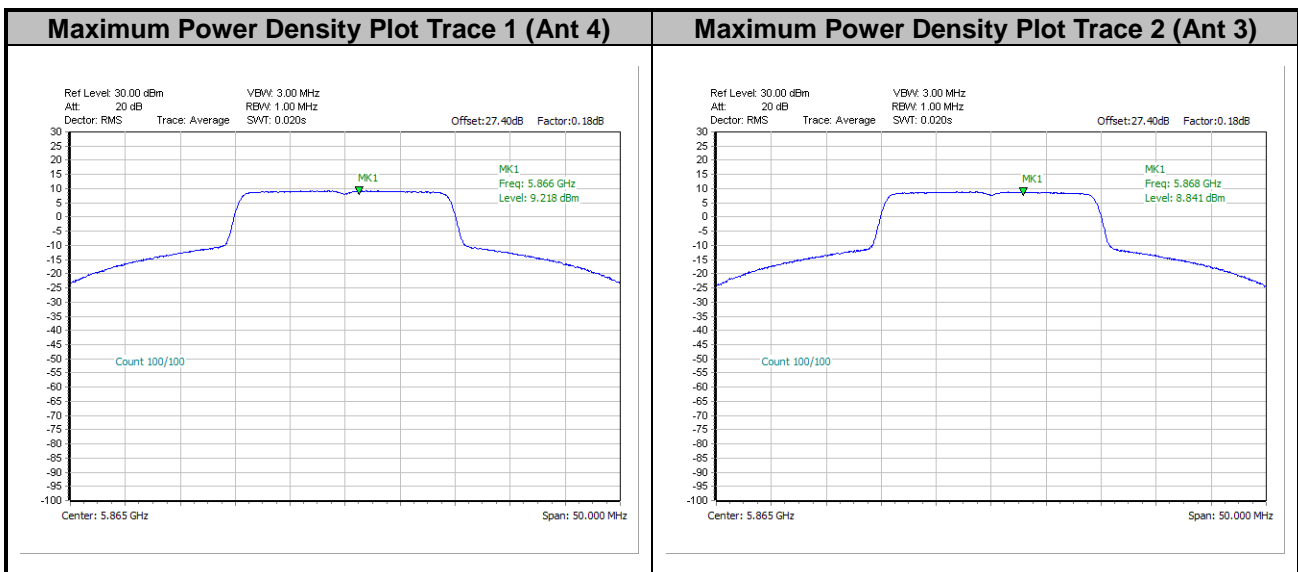



<802.11ax HE40>

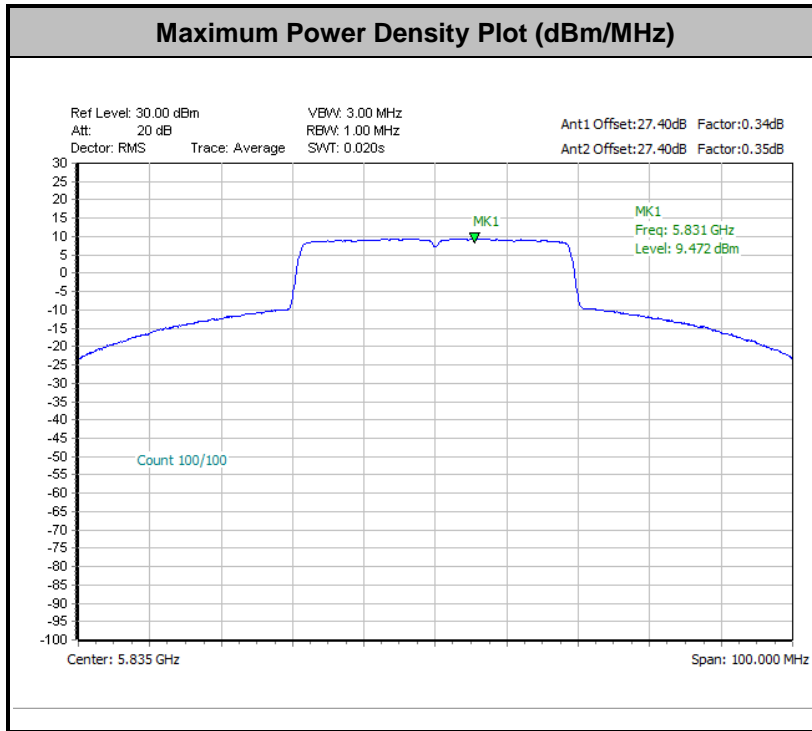

Remark: The test plot is showing a bin by bin combined result mathematically adds two traces.

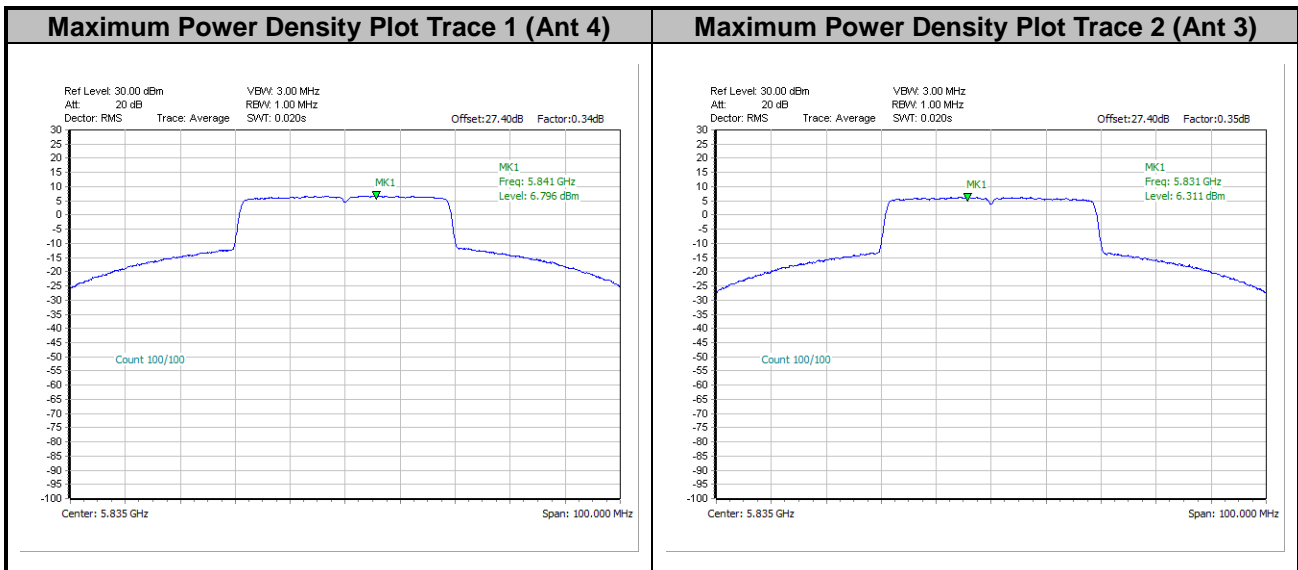



<802.11ax HE80>

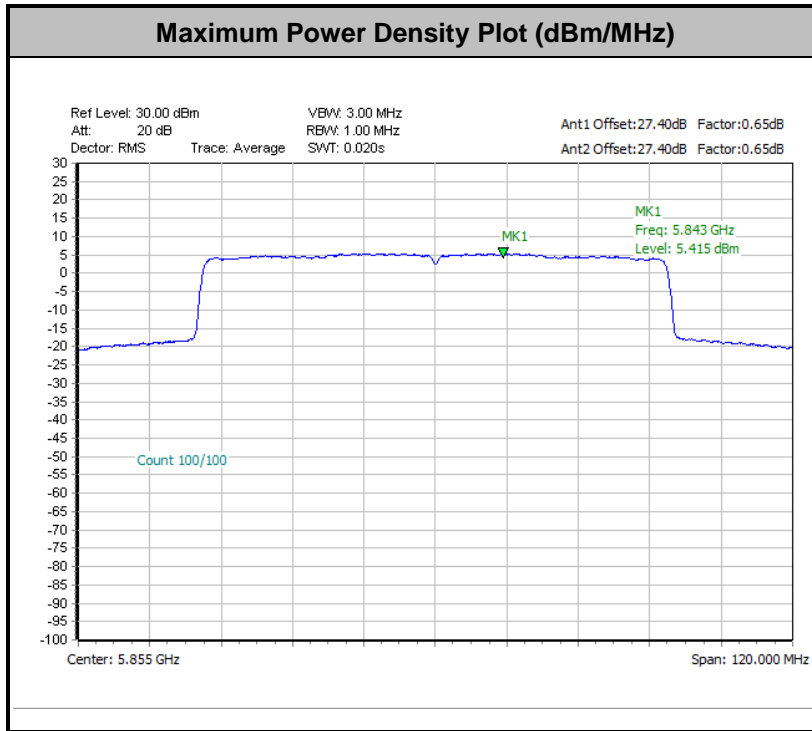

Remark: The test plot is showing a bin by bin combined result mathematically adds two traces.

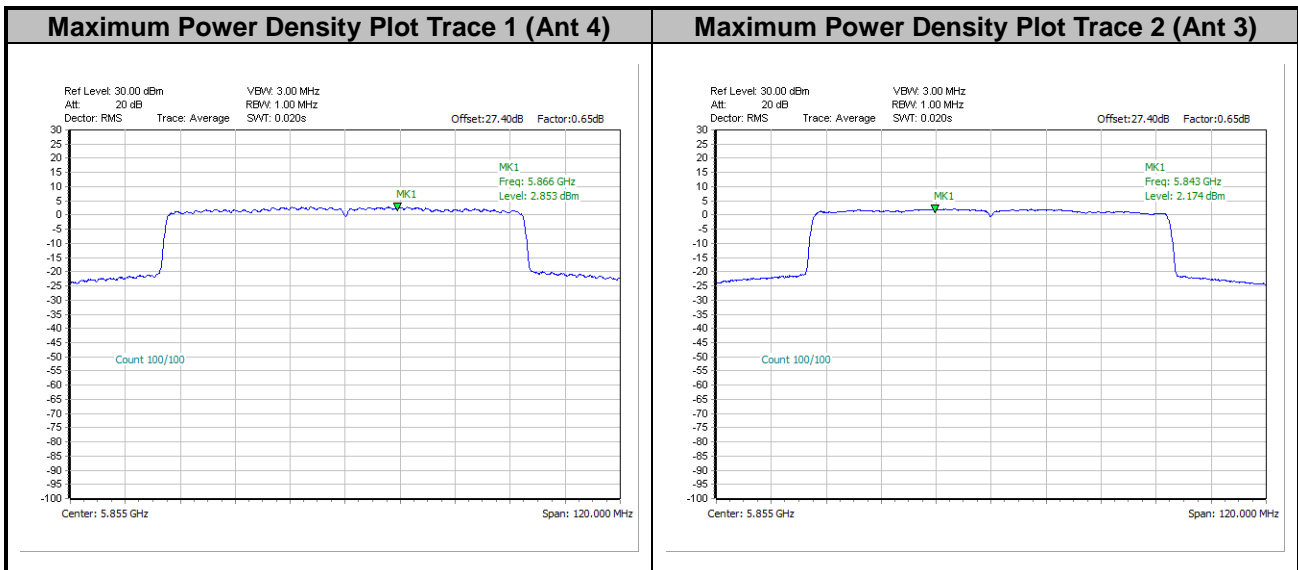



<802.11ax HE160>

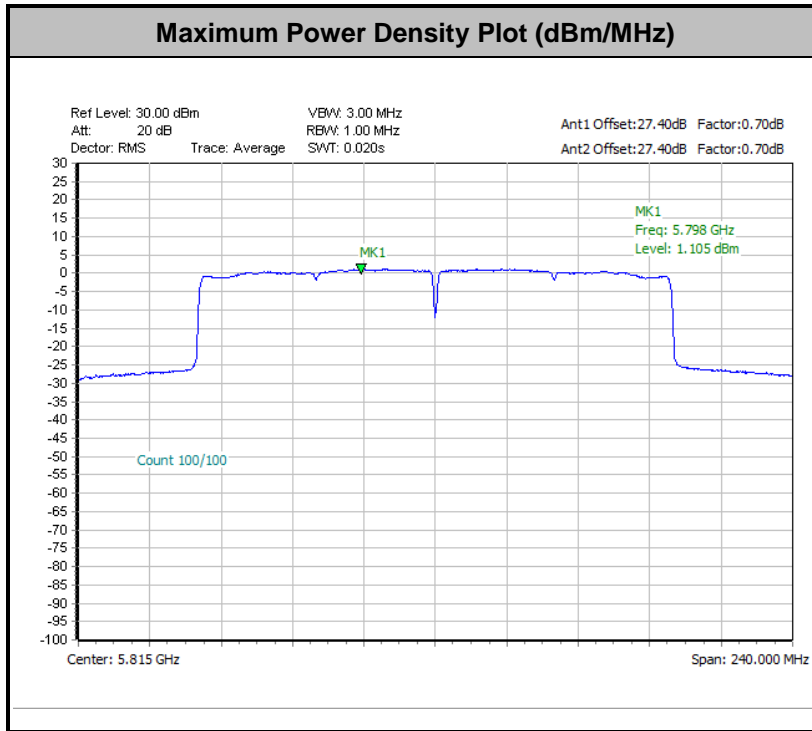

Remark: The test plot is showing a bin by bin combined result mathematically adds two traces.

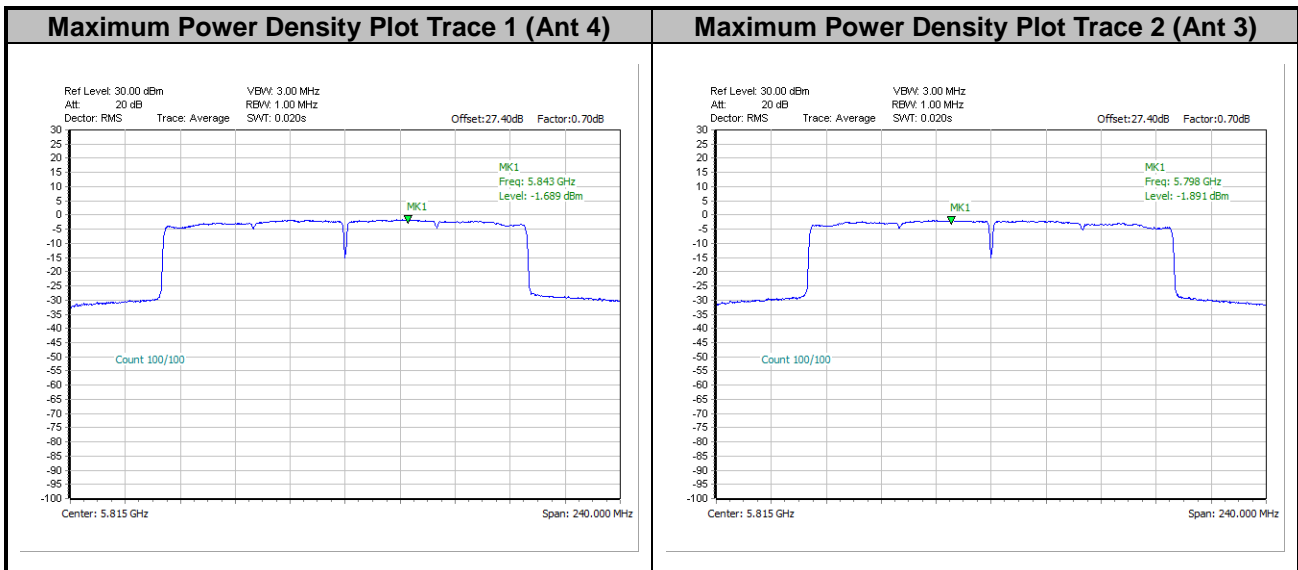



3.4 Unwanted Emissions Measurement

This section is to measure unwanted emissions through radiated measurement for band edge spurious emissions and out of band emissions measurement.

3.4.1 Limit of Unwanted Emissions

(1) Unwanted spurious emissions fallen in restricted bands shall comply with the general field strength limits as the following table:

Frequency (MHz)	Field Strength (microvolts/meter)	Measurement Distance (meters)
0.009 – 0.490	2400/F(kHz)	300
0.490 – 1.705	24000/F(kHz)	30
1.705 – 30.0	30	30
30 – 88	100	3
88 – 216	150	3
216 - 960	200	3
Above 960	500	3

Note: The following formula is used to convert the EIRP to field strength.

$$E = \frac{1000000\sqrt{30P}}{3} \text{ } \mu\text{V/m, where P is the eirp (Watts)}$$

(2) For transmitters operating solely in the 5.850-5.895 GHz band or operating on a channel that spans across 5.725-5.895 GHz:

15.407(b)(5)(ii), all emissions at or above 5.895 GHz shall not exceed an e.i.r.p. of -5 dBm/MHz and shall decrease linearly to an e.i.r.p. of -27 dBm/MHz at or above 5.925 GHz.

All emissions below 5.725 GHz shall not exceed an e.i.r.p. of -27 dBm/MHz at 5.65 GHz increasing linearly to 10 dBm/MHz at 5.7 GHz, and from 5.7 GHz increasing linearly to a level of 15.6 dBm/MHz at 5.72 GHz, and from 5.72 GHz increasing linearly to a level of 27 dBm/MHz at 5.725 GHz.

(3) KDB789033 D02 v02r01 G)2)c)

Use guidance in KDB Publication 789033 for all measurements. Unwanted emissions outside of restricted bands are measured with an RMS detector. In addition, 15.35(b) applies where the peak emissions must be limited to no more than 20 dB above the average limit.

Unwanted band-edge emissions may be measured using the integration method as described in KDB Publication 789033 3. d) (ii). Emissions below 5725 MHz should be measured using peak-detection while emission above 5895 MHz should be measured using average.



Frequency(GHz)	EIRP (dBm)	Field Strength @3m distance (dBuV/m)	Note
Below 5.65	-27dBm/MHz	68.2	Peak
5.7	10dBm/MHz	105.2	Peak
5.72	15.6dBm/MHz	110.8	Peak
5.725	27dBm/MHz	122.2	Peak
5.895	-5dBm/MHz	90.2	Average
5.895	15dBm/MHz	110.2	Peak
Above 5.925	-27dBm/MHz	68.2	Average
Above 5.925	-7dBm/MHz	88.2	Peak

Note: Field strength at 3 m distance is converted to EIRP as the following equation:
 $EIRP[dBm] = E[dB\mu V/m] - 95.2$

3.4.2 Measuring Instruments

See list of measuring equipment of this test report.

3.4.3 Test Procedures

- The testing follows FCC KDB 789033 D02 General UNII Test Procedures New Rules v02r01. Section G) Unwanted emissions measurement.
 - Procedure for Unwanted Emissions Measurements Below 1000 MHz
 - RBW = 120 kHz
 - VBW = 300 kHz
 - Detector = Peak
 - Trace mode = max hold
 - Procedure for Peak Unwanted Emissions Measurements Above 1000 MHz
 - RBW = 1 MHz
 - VBW ≥ 3 MHz
 - Detector = Peak
 - Sweep time = auto
 - Trace mode = max hold
 - Procedures for Average Unwanted Emissions Measurements Above 1000 MHz
 - RBW = 1 MHz
 - VBW = 10 Hz, when duty cycle is no less than 98 percent.
 - VBW ≥ 1/T, when duty cycle is less than 98 percent where T is the minimum transmission duration over which the transmitter is on and is transmitting at its maximum power control level for the tested mode of operation.

2. The EUT was placed on a turntable with 0.8 meter for frequency below 1 GHz and 1.5 meter for frequency above 1 GHz respectively above ground.
3. The EUT was placed at distance 3 meter from measurement antenna which was mounted on the top of a variable height antenna tower.
4. The measurement antenna is a broadband antenna and its height is adjusted between one meter and four meters above ground to find the maximum value of the field strength for both horizontal polarization and vertical polarization.
5. For each suspected emission, the EUT was arranged to its worst case and then adjust the antenna tower (from 1 m to 4 m) and turntable (from 0 degree to 360 degrees) to find the maximum reading.
6. Radiated testing below 1GHz was performed by adjusting the antenna tower from 1m to 4m and by rotating the turn table from 0 degree to 360 degree to find the peak maximum hold reading. When there is no suspected emission found and the emission level is with at least 6dB margin against QP limit line, the position is marked as “-“.
7. Radiated testing above 1GHz was performed by adjusting the antenna tower from 1m to 4m and by rotating the turn table from 0 degree to 360 degree to find the peak maximum hold reading for scanning all frequencies. When there is no suspected emission found and the harmonic emission level is with at least 6dB margin against average limit line, the position is marked as “-“.

3.4.4 Test Setup

For radiated emissions below 30MHz

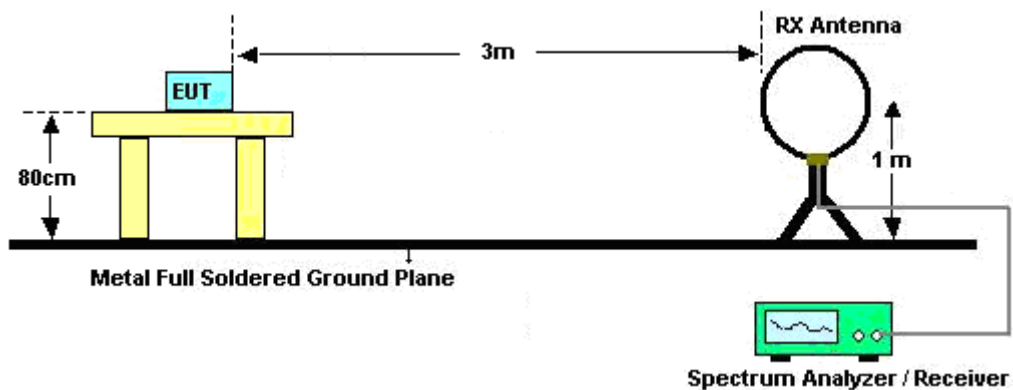

For radiated emissions from 30MHz to 1GHz

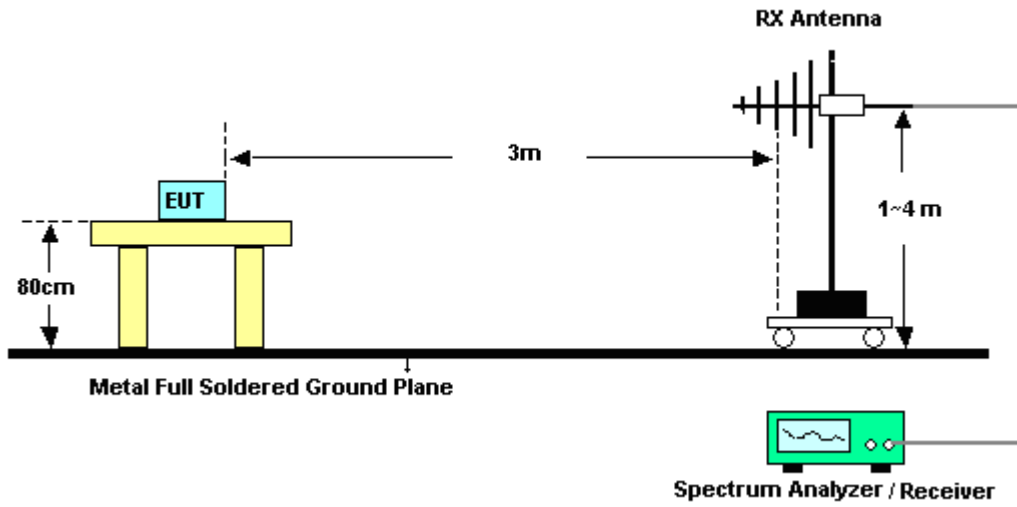

For radiated test from 1GHz to 18GHz

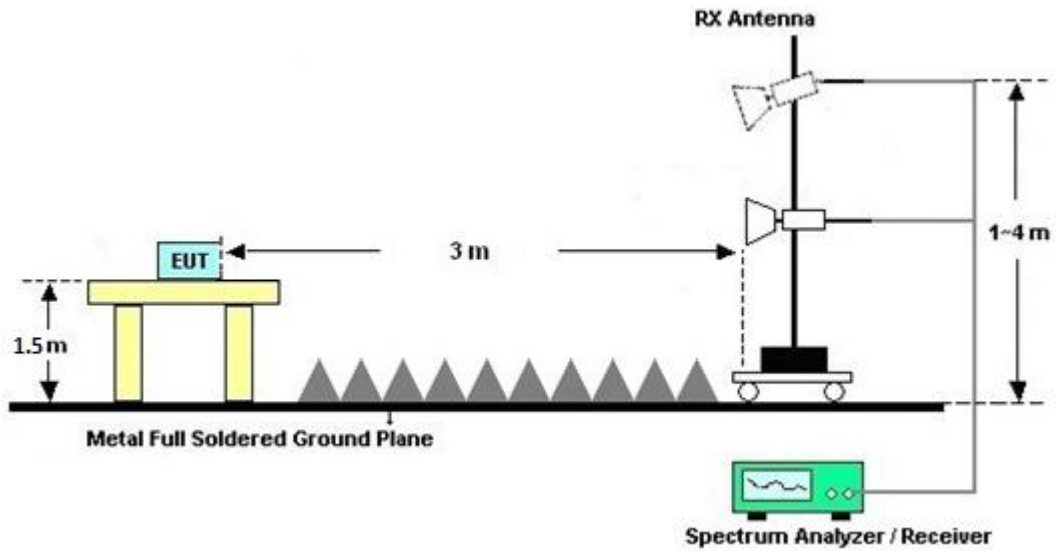

For radiated test above 18GHz

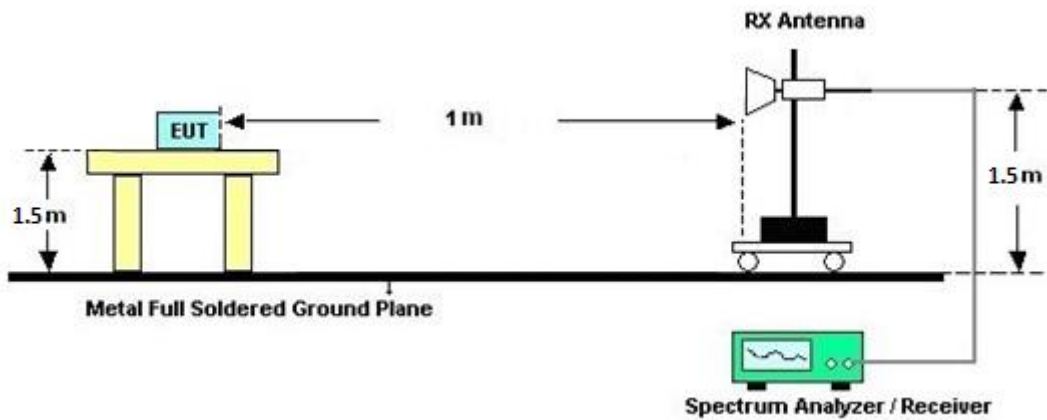

3.4.5 Test Results of Radiated Emissions (9 kHz ~ 30 MHz)

The low frequency, which started from 9 kHz to 30MHz, was pre-scanned and the result which was 20dB lower than the limit line was not reported.

There is adequate comparison measurement of both open-field test site and alternative test site - semi-Anechoic chamber according to 414788 D01 Radiated Test Site v01r01, and the result came out very similar.

3.4.6 Test Results of Radiated Spurious Emissions (above 18 GHz)

For frequency above 18GHz, the pre-scanned result is 20dB lower than the limit line is not reported.

3.4.7 Test Result of Radiated Band Edges

Please refer to Appendix C and D.

3.4.8 Duty Cycle

Please refer to Appendix E.

3.4.9 Test Result of Unwanted Radiated Emission (30MHz ~ 10th Harmonic)

Please refer to Appendix C and D.



3.5 AC Conducted Emission Measurement

3.5.1 Limit of AC Conducted Emission

For equipment that is designed to be connected to the public utility (AC) power line, the radio frequency voltage that is conducted back onto the AC power line on any frequency or frequencies within the band 150 kHz to 30 MHz shall not exceed the limits in the following table.

Frequency of emission (MHz)	Conducted limit (dBµV)	
	Quasi-peak	Average
0.15-0.5	66 to 56*	56 to 46*
0.5-5	56	46
5-30	60	50

*Decreases with the logarithm of the frequency.

3.5.2 Measuring Instruments

See list of measuring equipment of this test report.

3.5.3 Test Procedures

1. The EUT was placed 0.4 meter from the conducting wall of the shielding room was kept at least 80 centimeters from any other grounded conducting surface.
2. Connect EUT to the power mains through a line impedance stabilization network (LISN).
3. All the support units are connecting to the other LISN.
4. The LISN provides 50 ohm coupling impedance for the measuring instrument.
5. The FCC states that a 50 ohm, 50 microhenry LISN shall be used.
6. Both sides of AC line were checked for maximum conducted interference.
7. The frequency range from 150 kHz to 30 MHz was searched.
8. Set the test-receiver system to Peak Detect Function and specified bandwidth with Maximum Hold Mode.

3.5.4 Test Setup

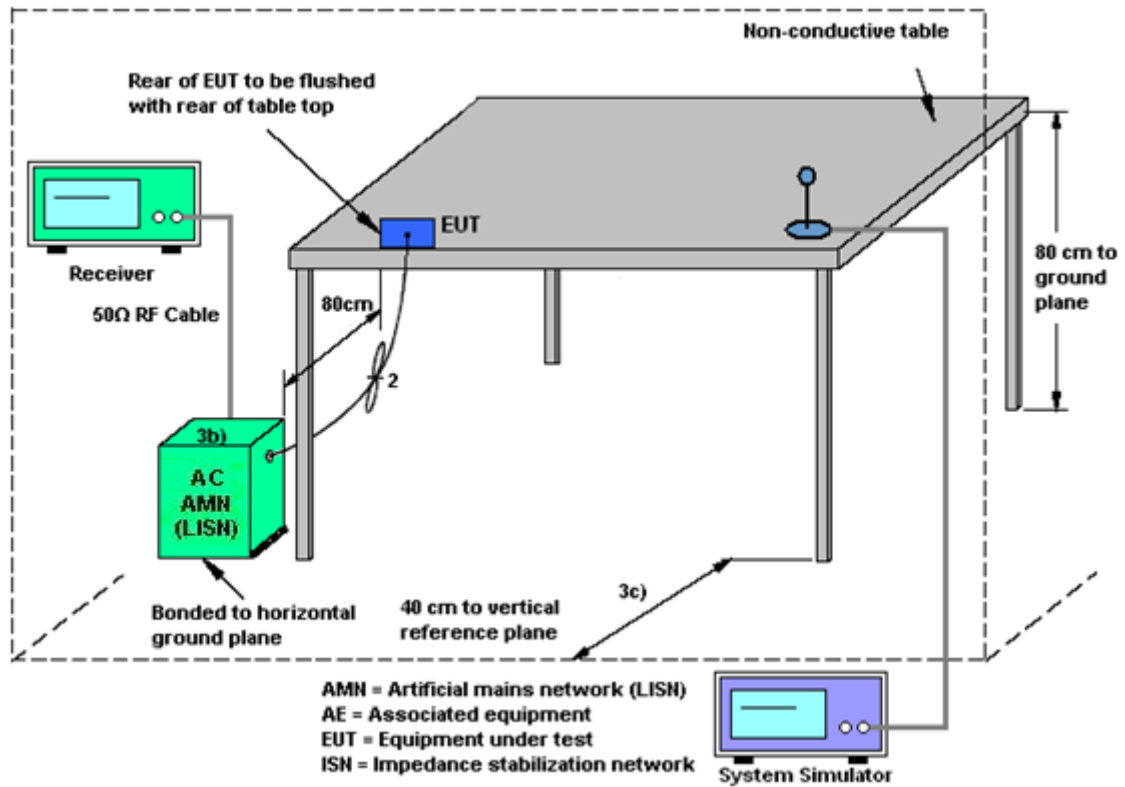

3.5.5 Test Result of AC Conducted Emission

Please refer to Appendix B.

3.6 Antenna Requirements

3.6.1 Antenna Anti-Replacement Construction

An embedded-in antenna design is used.

3.6.2 Antenna Gain

Refer to FCC KDB 662911 D01 Multiple Transmitter Output v02r01

<CDD Modes>

For power measurements on IEEE 802.11 devices,

Directional gain = G_{ANT} + Array Gain, where Array Gain is as follows:

Array Gain = 0 dB (i.e., no array gain) for $N_{ANT} \leq 4$.

G_{ANT} is set equal to the gain of the antenna having the highest gain.

For PSD measurements, the directional gain calculation follows F)2)f)ii) of KDB 662911 D01 v02r01.

$$DirectionalGain = 10 \cdot \log \left[\frac{\sum_{j=1}^{N_{SS}} \left\{ \sum_{k=1}^{N_{ANT}} g_{j,k} \right\}^2}{N_{ANT}} \right]$$

where

Each antenna is driven by no more than one spatial stream;

N_{SS} = the number of independent spatial streams of data;

N_{ANT} = the total number of antennas

$g_{j,k} = 10^{G_k/20}$ if the k th antenna is being fed by spatial stream j , or zero if it is not;
 G_k is the gain in dBi of the k th antenna.

As minimum $N_{SS}=1$ is supported by EUT, the formula can be simplified as:

$$Directional\ gain = 10 \cdot \log \left[\left(10^{G_1/20} + 10^{G_2/20} + \dots + 10^{G_N/20} \right)^2 / N_{ANT} \right] \text{ dBi}$$

Where G_1, G_2, \dots, G_N denote single antenna gain.

For example: If a device has two antenna, $G_{ANT1}= 3.6\text{dBi}$; $G_{ANT2}=4.2\text{dBi}$

Directional gain of power measurement = $\max(3.6, 4.2) + 0 = 4.2 \text{ dBi}$

Directional gain of PSD measurement = $10 \cdot \log \left[\left(10^{3.6/20} + 10^{4.2/20} \right)^2 / 2 \right] = 6.92 \text{ dBi}$



The directional gain of EUT is listed in the following table.

UNII-4	Ant 4 (dBi)	Ant 3 (dBi)	DG for Power (dBi)	DG for PSD (dBi)
	-0.50	-2.10	-0.50	1.75

Calculation example:

The DG for PSD is derived from formula is

$$10 \times \log \left\{ \left[10^{(-0.5 \text{ dBi} / 20)} + 10^{(-2.1 \text{ dBi} / 20)} \right]^2 / 2 \right\}$$

= 1.75 dBi



4 List of Measuring Equipment

Instrument	Brand Name	Model No.	Serial No.	Characteristics	Calibration Date	Test Date	Due Date	Remark
Loop Antenna	Rohde & Schwarz	HFH2-Z2	100488	9 kHz~30 MHz	Sep. 07, 2021	Apr. 13, 2022~ May 18, 2022	Sep. 06, 2022	Radiation (03CH16-HY)
Bilog Antenna	TESEQ	CBL 6111D & 00802N1D01N -06	47020 & 06	30MHz to 1GHz	Oct. 09, 2021	Apr. 13, 2022~ May 18, 2022	Oct. 08, 2022	Radiation (03CH16-HY)
Horn Antenna	SCHWARZBE CK	BBHA 9120 D	9120D-02114	1G~18GHz	Aug. 04, 2021	Apr. 13, 2022~ May 18, 2022	Aug. 03, 2022	Radiation (03CH16-HY)
SHF-EHF Horn Antenna	SCHWARZBE CK	BBHA 9170	00993	18GHz ~40GHz	Nov. 30, 2021	Apr. 13, 2022~ May 18, 2022	Nov. 29, 2022	Radiation (03CH16-HY)
Amplifier	SONOMA	310N	371607	9kHz~1G	Jul. 05, 2021	Apr. 13, 2022~ May 18, 2022	Jul. 04, 2022	Radiation (03CH16-HY)
Amplifier	EMCI	EMC051845S E	980729	1-18GHz	Jul. 09, 2021	Apr. 13, 2022~ May 18, 2022	Jul. 08, 2022	Radiation (03CH16-HY)
Preamplifier	EMEC	EM18G40G	060801	18GHz~40GHz	Jun. 22, 2021	Apr. 13, 2022~ May 18, 2022	Jun. 21, 2022	Radiation (03CH16-HY)
Preamplifier	Keysight	83017A	MY53270264	1GHz~26.5GHz	Dec. 09, 2021	Apr. 13, 2022~ May 18, 2022	Dec. 08, 2022	Radiation (03CH16-HY)
EMI Test Receiver	Keysight	N9038A	MY59053012	3Hz~26.5GHz	Nov. 18, 2021	Apr. 13, 2022~ May 18, 2022	Nov. 17, 2022	Radiation (03CH16-HY)
RF Cable	HUBER + SUHNER	SUCOFLEX 104	MY11680/4P E	NA	Aug. 28, 2021	Apr. 13, 2022~ May 18, 2022	Aug. 27, 2022	Radiation (03CH16-HY)
RF Cable	HUBER + SUHNER	SUCOFLEX 104	MY11688/4P E	NA	Aug. 28, 2021	Apr. 13, 2022~ May 18, 2022	Aug. 27, 2022	Radiation (03CH16-HY)
RF Cable	HUBER + SUHNER	SUCOFLEX 102	EC-A5-300-5 757	NA	Aug. 28, 2021	Apr. 13, 2022~ May 18, 2022	Aug. 27, 2022	Radiation (03CH16-HY)
Software	Audix	E3 6.2009-8-24	RK-001136	N/A	N/A	Apr. 13, 2022~ May 18, 2022	N/A	Radiation (03CH16-HY)
Antenna Mast	ChainTek	MBS-520-1	N/A	1m~4m	N/A	Apr. 13, 2022~ May 18, 2022	N/A	Radiation (03CH16-HY)
Turn Table	ChainTek	T-200-S-1	N/A	0~360 Degree	N/A	Apr. 13, 2022~ May 18, 2022	N/A	Radiation (03CH16-HY)
AC Power Source	ChainTek	APC-1000W	N/A	N/A	N/A	Apr. 20, 2022	N/A	Conduction (CO05-HY)
EMI Test Receiver	Rohde & Schwarz	ESR3	102388	9kHz~3.6GHz	Dec. 01, 2021	Apr. 20, 2022	Nov. 30, 2022	Conduction (CO05-HY)
Hygrometer	Testo	608-H1	34913912	N/A	Nov. 17, 2021	Apr. 20, 2022	Nov. 16, 2022	Conduction (CO05-HY)
LISN	Rohde & Schwarz	ENV216	100080	9kHz~30MHz	Dec. 03, 2021	Apr. 20, 2022	Dec. 02, 2022	Conduction (CO05-HY)
Software	Rohde & Schwarz	EMC32	N/A	N/A	N/A	Apr. 20, 2022	N/A	Conduction (CO05-HY)
Pulse Limiter	SCHWARZBE CK	VTSD 9561-F N	00691	N/A	Jul. 28, 2021	Apr. 20, 2022	Jul. 27, 2022	Conduction (CO05-HY)
LISN Cable	MVE	RG-400	260260	N/A	Dec. 30, 2021	Apr. 20, 2022	Dec. 29, 2022	Conduction (CO05-HY)



Instrument	Brand Name	Model No.	Serial No.	Characteristics	Calibration Date	Test Date	Due Date	Remark
Hygrometer	TECPEL	DTM-303A	TP201996	N/A	Nov. 16, 2021	Mar. 29, 2022~ May 21, 2022	Nov. 15, 2022	Conducted (TH05-HY)
Power Sensor	DARE	RPR3006W	16I00054SNO 12 (NO:113)	10MHz~6GHz	Dec. 16, 2021	Mar. 29, 2022~ May 21, 2022	Dec. 15, 2022	Conducted (TH05-HY)
Signal Analyzer	Rohde & Schwarz	FSV40	101566	10Hz~40GHz	Aug. 30, 2021	Mar. 29, 2022~ May 21, 2022	Aug. 29, 2022	Conducted (TH05-HY)
Switch Control Mainframe	E-IUSTRUMENT	ETF-1405-0	EC1900067 (BOX7)	N/A	Aug. 12, 2021	Mar. 29, 2022~ May 21, 2022	Aug. 11, 2022	Conducted (TH05-HY)



5 Uncertainty of Evaluation

Uncertainty of Conducted Emission Measurement (150kHz ~ 30MHz)

Measuring Uncertainty for a Level of Confidence of 95% ($U = 2Uc(y)$)	3.1 dB
---	--------

Uncertainty of Radiated Emission Measurement (30 MHz ~ 1000 MHz)

Measuring Uncertainty for a Level of Confidence of 95% ($U = 2Uc(y)$)	5.8 dB
---	--------

Uncertainty of Radiated Emission Measurement (1000 MHz ~ 18000 MHz)

Measuring Uncertainty for a Level of Confidence of 95% ($U = 2Uc(y)$)	5.2 dB
---	--------

Uncertainty of Radiated Emission Measurement (18000 MHz ~ 40000 MHz)

Measuring Uncertainty for a Level of Confidence of 95% ($U = 2Uc(y)$)	5.8 dB
---	--------

Appendix A. Test Result of Conducted Test Items

Test Engineer:	Shiming Liu	Temperature:	21~25	°C
Test Date:	2022/3/29~2022/5/21	Relative Humidity:	51~54	%

TEST RESULTS DATA
6dB and 26dB EBW and 99% OBW

UNII-4 MIMO												
Mod.	Data Rate	NTX	CH.	Freq. (MHz)	99% Bandwidth (MHz)		26dB Bandwidth (MHz)		6 dB Bandwidth (MHz)		6 dB Bandwidth Min. Limit (MHz)	Pass/Fail
					Ant 4	Ant 3	Ant 4	Ant 3	Ant 4	Ant 3		
11a	6Mbps	2	169	5845	20.78	20.48	42.50	39.40	18.69	19.04	0.5	Pass
11a	6Mbps	2	173	5865	21.28	20.13	43.25	37.05	18.79	19.04	0.5	Pass
11a	6Mbps	2	177	5885	22.23	20.58	45.05	41.60	18.99	18.84	0.5	Pass

TEST RESULTS DATA
Average Power Table

UNII-4 MIMO										
Mod.	Data Rate	NTX	CH.	Freq. (MHz)	Average Conducted Power (dBm)			DG (dBi)	E.I.R.P Power (dBm)	E.I.R.P Limit (dBm)
					Ant 4	Ant 3	SUM	Ant 4 + Ant 3	Ant 4 + Ant 3	Ant 4 + Ant 3
11a	6Mbps	2	169	5845	21.30	20.80	24.07	-0.50	23.57	30
11a	6Mbps	2	173	5865	21.30	20.80	24.07	-0.50	23.57	30
11a	6Mbps	2	177	5885	21.40	20.90	24.17	-0.50	23.67	30
HT20	MCS0	2	169	5845	21.50	21.10	24.31	-0.50	23.81	30
HT20	MCS0	2	173	5865	21.70	21.20	24.47	-0.50	23.97	30
HT20	MCS0	2	177	5885	21.70	21.20	24.47	-0.50	23.97	30
HT40	MCS0	2	167	5835	21.70	21.30	24.51	-0.50	24.01	30
HT40	MCS0	2	175	5875	21.70	21.40	24.56	-0.50	24.06	30
VHT20	MCS0	2	169	5845	21.60	21.20	24.41	-0.50	23.91	30
VHT20	MCS0	2	173	5865	21.80	21.30	24.57	-0.50	24.07	30
VHT20	MCS0	2	177	5885	21.80	21.30	24.57	-0.50	24.07	30
VHT40	MCS0	2	167	5835	21.80	21.40	24.61	-0.50	24.11	30
VHT40	MCS0	2	175	5875	21.80	21.50	24.66	-0.50	24.16	30
VHT80	MCS0	2	171	5855	20.50	20.00	23.27	-0.50	22.77	30
VHT160	MCS0	2	163	5815	19.10	18.90	22.01	-0.50	21.51	30

TEST RESULTS DATA
Power Spectral Density

UNII-4 MIMO													
Mod.	Data Rate	N _{TX}	CH.	Freq. (MHz)	Duty Factor (dB)		Average Power Density with Duty Factor (dBm/MHz)			DG (dBi)	EIRP PSD (dBm/MHz)	EIRP PSD Limit (dBm/MHz)	Pass /Fail
					Ant 4	Ant 3	Ant 4	Ant 3	SUM				
11a	6Mbps	2	169	5845	0.31	0.30			12.17	1.75	13.92	14.00	Pass
11a	6Mbps	2	173	5865	0.31	0.30			12.14	1.75	13.89	14.00	Pass
11a	6Mbps	2	177	5885	0.31	0.30			12.05	1.75	13.80	14.00	Pass

Note: PSD Sum = Max PSD(Ant. 1, Ant. 2) + 10 log (n)

TEST RESULTS DATA
6dB and 26dB EBW and 99% OBW

UNII-4 MIMO													
Mod.	Data Rate	NTX	CH.	Freq. (MHz)	RU Config	99% Bandwidth (MHz)		26dB Bandwidth (MHz)		6 dB Bandwidth (MHz)		6 dB Bandwidth Min. Limit (MHz)	Pass/Fail
						Ant 4	Ant 3	Ant 4	Ant 3	Ant 4	Ant 3		
HE20	MCS0	2	169	5845	Full	23.93	22.23	44.60	44.90	18.99	19.04	0.5	Pass
HE20	MCS0	2	173	5865	Full	23.38	22.63	46.60	43.80	18.79	18.99	0.5	Pass
HE20	MCS0	2	177	5885	Full	23.98	22.78	45.55	44.10	18.84	18.94	0.5	Pass
HE40	MCS0	2	167	5835	Full	50.45	46.85	83.35	79.01	37.87	37.69	0.5	Pass
HE40	MCS0	2	175	5875	Full	52.45	46.35	83.51	81.26	37.15	37.42	0.5	Pass
HE80	MCS0	2	171	5855	Full	77.56	77.44	141.06	124.10	77.40	75.96	0.5	Pass
HE160	MCS0	2	163	5815	Full	156.80	156.80	260.48	256.96	157.68	156.40	0.5	Pass

TEST RESULTS DATA
Average Power Table

UNII-4 MIMO											
Mod.	Data Rate	NTX	CH.	Freq. (MHz)	RU Config	Average Conducted Power (dBm)			DG (dBi)	E.I.R.P Power (dBm)	E.I.R.P Limit (dBm)
						Ant 4	Ant 3	SUM			
HE20	MCS0	2	169	5845	Full	21.70	21.30	24.51	-0.50	24.01	30
HE20	MCS0	2	169	5845	26/0	12.00	12.10	15.06	-0.50	14.56	30
HE20	MCS0	2	169	5845	52/37	15.10	14.80	17.96	-0.50	17.46	30
HE20	MCS0	2	169	5845	106/53	18.00	18.00	21.01	-0.50	20.51	30
HE20	MCS0	2	173	5865	Full	21.90	21.40	24.67	-0.50	24.17	30
HE20	MCS0	2	173	5865	26/4	12.60	11.70	15.18	-0.50	14.68	30
HE20	MCS0	2	173	5865	52/38	15.20	14.50	17.87	-0.50	17.37	30
HE20	MCS0	2	173	5865	106/53	18.20	17.90	21.06	-0.50	20.56	30
HE20	MCS0	2	177	5885	Full	21.90	21.40	24.67	-0.50	24.17	30
HE20	MCS0	2	177	5885	26/8	12.20	11.50	14.87	-0.50	14.37	30
HE20	MCS0	2	177	5885	52/40	15.20	14.60	17.92	-0.50	17.42	30
HE20	MCS0	2	177	5885	106/54	18.00	17.80	20.91	-0.50	20.41	30
HE40	MCS0	2	167	5835	Full	21.90	21.50	24.71	-0.50	24.21	30
HE40	MCS0	2	175	5875	Full	21.90	21.60	24.76	-0.50	24.26	30
HE80	MCS0	2	171	5855	Full	20.60	20.10	23.37	-0.50	22.87	30
HE160	MCS0	2	163	5815	Full	19.20	19.00	22.11	-0.50	21.61	30

TEST RESULTS DATA
Power Spectral Density

UNII-4 MIMO														
Mod.	Data Rate	NTx	CH.	Freq. (MHz)	RU Config	Duty Factor (dB)		Average Power Density with Duty Factor (dBm/MHz)			DG (dBi)	EIRP PSD (dBm/MHz)	EIRP PSD Limit (dBm/MHz)	Pass /Fail
						Ant 4	Ant 3	Ant 4	Ant 3	SUM				
HE20	MCS0	2	169	5845	Full	0.18	0.18			11.99	1.75	13.74	14.00	Pass
HE20	MCS0	2	169	5845	26/0	0.48	0.49			11.79	1.75	13.53	14.00	Pass
HE20	MCS0	2	169	5845	52/37	0.52	0.52			11.81	1.75	13.55	14.00	Pass
HE20	MCS0	2	169	5845	106/53	0.58	0.60			11.81	1.75	13.56	14.00	Pass
HE20	MCS0	2	173	5865	Full	0.18	0.18			12.00	1.75	13.74	14.00	Pass
HE20	MCS0	2	173	5865	26/4	0.48	0.49			11.32	1.75	13.07	14.00	Pass
HE20	MCS0	2	173	5865	52/38	0.52	0.52			11.76	1.75	13.51	14.00	Pass
HE20	MCS0	2	173	5865	106/53	0.58	0.60			11.83	1.75	13.58	14.00	Pass
HE20	MCS0	2	177	5885	Full	0.18	0.18			11.97	1.75	13.72	14.00	Pass
HE20	MCS0	2	177	5885	26/8	0.48	0.49			11.54	1.75	13.29	14.00	Pass
HE20	MCS0	2	177	5885	52/40	0.52	0.52			11.56	1.75	13.30	14.00	Pass
HE20	MCS0	2	177	5885	106/54	0.58	0.60			11.80	1.75	13.55	14.00	Pass
HE40	MCS0	2	167	5835	Full	0.34	0.35			9.47	1.75	11.22	14.00	Pass
HE40	MCS0	2	175	5875	Full	0.34	0.35			9.44	1.75	11.19	14.00	Pass
HE80	MCS0	2	171	5855	Full	0.65	0.65			5.42	1.75	7.16	14.00	Pass
HE160	MCS0	2	163	5815	Full	0.70	0.70			1.11	1.75	2.85	14.00	Pass

Note: PSD Sum = Max PSD(Ant. 1, Ant. 2) + 10 log (n)



Appendix B. AC Conducted Emission Test Results

Test Engineer :	Tom Lee	Temperature :	23~26°C
		Relative Humidity :	45~55%

EUT Information

Report NO : 1O2843-05
 Test Mode : Mode 1
 Test Voltage : 120Vac/60Hz
 Phase : Line

Full Spectrum

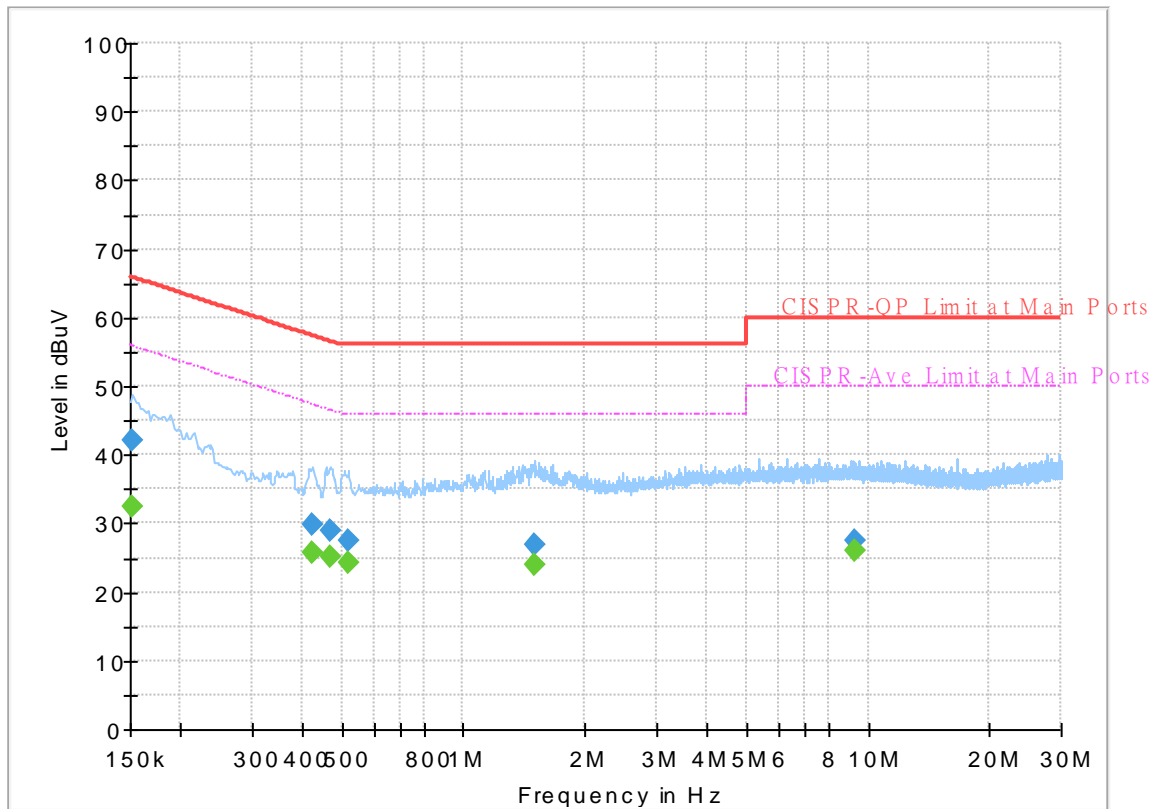

Final_Result

Frequency (MHz)	QuasiPeak (dBuV)	CAverage (dBuV)	Limit (dBuV)	Margin (dB)	Line	Filter	Corr. (dB)
0.152250	---	32.54	55.88	23.34	L1	OFF	19.6
0.152250	42.16	---	65.88	23.72	L1	OFF	19.6
0.424500	---	25.87	47.36	21.49	L1	OFF	19.6
0.424500	29.80	---	57.36	27.56	L1	OFF	19.6
0.467250	---	25.16	46.56	21.40	L1	OFF	19.6
0.467250	28.84	---	56.56	27.72	L1	OFF	19.6
0.519000	---	24.31	46.00	21.69	L1	OFF	19.6
0.519000	27.61	---	56.00	28.39	L1	OFF	19.6
1.493250	---	23.95	46.00	22.05	L1	OFF	19.7
1.493250	26.98	---	56.00	29.02	L1	OFF	19.7
9.330000	---	25.96	50.00	24.04	L1	OFF	20.0
9.330000	27.52	---	60.00	32.48	L1	OFF	20.0

EUT Information

Report NO : 1O2843-05
 Test Mode : Mode 1
 Test Voltage : 120Vac/60Hz
 Phase : Neutral

Full Spectrum

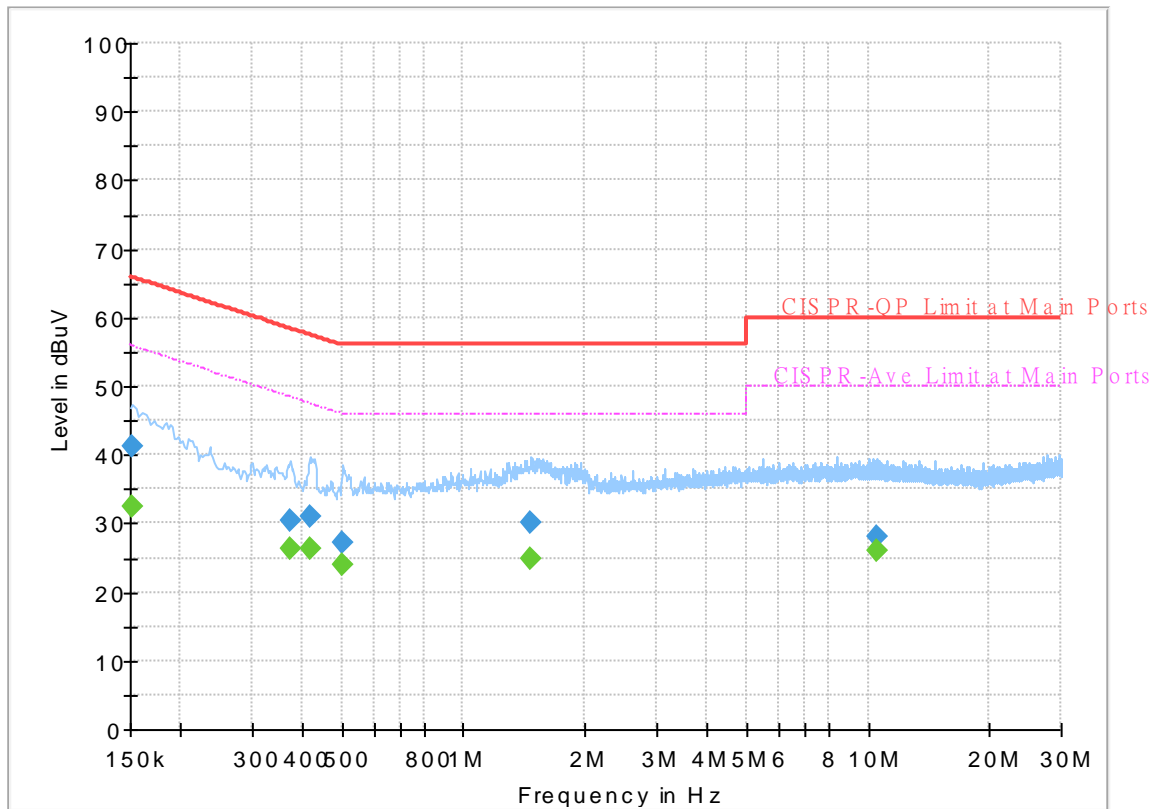

Final_Result

Frequency (MHz)	QuasiPeak (dBuV)	CAverage (dBuV)	Limit (dBuV)	Margin (dB)	Line	Filter	Corr. (dB)
0.152250	---	32.41	55.88	23.47	N	OFF	19.6
0.152250	41.09	---	65.88	24.79	N	OFF	19.6
0.372750	---	26.29	48.44	22.15	N	OFF	19.6
0.372750	30.35	---	58.44	28.09	N	OFF	19.6
0.417750	---	26.38	47.49	21.11	N	OFF	19.6
0.417750	31.02	---	57.49	26.47	N	OFF	19.6
0.503250	---	23.94	46.00	22.06	N	OFF	19.6
0.503250	27.12	---	56.00	28.88	N	OFF	19.6
1.473000	---	24.91	46.00	21.09	N	OFF	19.7
1.473000	30.22	---	56.00	25.78	N	OFF	19.7
10.473000	---	26.13	50.00	23.87	N	OFF	20.1
10.473000	27.96	---	60.00	32.04	N	OFF	20.1



Appendix C. Radiated Spurious Emission

Test Engineer :	Karl Hou and Andy Yang	Temperature :	20~25°C
		Relative Humidity :	50~60%

UNII-4 - 5735~5895MHz

WIFI 802.11a (Band Edge @ 3m)

WIFI Ant.	Note	Frequency (MHz)	Level (dBμV/m)	Margin Limit (dB)	Limit Line (dBμV/m)	Read Level (dBμV)	Antenna Factor (dB/m)	Path Loss (dB)	Preamp Factor (dB)	Ant Pos (cm)	Table Pos (deg)	Peak Avg. (P/A)	Pol. (H/V)
802.11a CH 169 5845MHz		5604.13	54.41	-13.79	68.2	37.91	33.21	12.88	29.59	100	61	P	H
		5678.47	55.08	-34.23	89.31	38.46	33.3	12.92	29.6	100	61	P	H
		5718	53.91	-56.33	110.24	37.17	33.41	12.94	29.61	100	61	P	H
		5724.785	55.3	-66.41	121.71	38.51	33.45	12.95	29.61	100	61	P	H
	*	5845	112.43	-	-	95.25	33.97	12.84	29.63	100	61	P	H
	*	5845	104.35	-	-	87.17	33.97	12.84	29.63	100	61	A	H
		5912.25	60.74	-36.8	97.54	43.73	34.02	12.63	29.64	100	61	P	H
		5925.75	58.1	-30.1	88.2	41.12	34.05	12.58	29.65	100	61	P	H
		5896.75	46.19	-42.72	88.91	29.15	34	12.68	29.64	100	61	A	H
		5935.25	44.9	-23.3	68.2	27.93	34.07	12.55	29.65	100	61	A	H
		5628.615	54.53	-13.67	68.2	37.96	33.26	12.9	29.59	319	16	P	V
		5680.535	55.08	-35.75	90.83	38.46	33.3	12.92	29.6	319	16	P	V
		5703.84	56.14	-50.14	106.28	39.49	33.32	12.94	29.61	319	16	P	V
		5720.065	54.1	-56.85	110.95	37.34	33.42	12.95	29.61	319	16	P	V
	*	5845	112.07	-	-	94.89	33.97	12.84	29.63	319	16	P	V
	*	5845	104.13	-	-	86.95	33.97	12.84	29.63	319	16	A	V
		5895.5	60.42	-49.41	109.83	43.38	34	12.68	29.64	319	16	P	V
		5951	56.46	-31.74	88.2	39.52	34.09	12.5	29.65	319	16	P	V
		5895.5	47.12	-42.71	89.83	30.08	34	12.68	29.64	319	16	A	V
		5925.5	45	-23.2	68.2	28.02	34.05	12.58	29.65	319	16	A	V



WiFi Ant. 4+3	Note	Frequency (MHz)	Level (dBμV/m)	Margin Limit (dB)	Limit Line (dBμV/m)	Read Level (dBμV)	Antenna Factor (dB/m)	Path Loss (dB)	Preamp Factor (dB)	Ant Pos (cm)	Table Pos (deg)	Peak Avg. (P/A)	Pol. (H/V)	
802.11a CH 173 5865MHz		5638.35	54.79	-13.41	68.2	38.2	33.28	12.9	29.59	100	59	P	H	
		5658.705	56.28	-18.39	74.67	39.67	33.3	12.91	29.6	100	59	P	H	
		5711.215	54.95	-53.39	108.34	38.25	33.37	12.94	29.61	100	59	P	H	
		5720.95	53.3	-59.67	112.97	36.53	33.43	12.95	29.61	100	59	P	H	
	*	5865	112.69	-	-	95.55	34	12.78	29.64	100	59	P	H	
	*	5865	104.79	-	-	87.65	34	12.78	29.64	100	59	A	H	
		5898	69.52	-38.47	107.99	52.49	34	12.67	29.64	100	59	P	H	
		5926.5	59.94	-28.26	88.2	42.96	34.05	12.58	29.65	100	59	P	H	
		5897	55.47	-33.26	88.73	38.44	34	12.67	29.64	100	59	A	H	
		5927.5	45.8	-22.4	68.2	28.81	34.06	12.58	29.65	100	59	A	H	
														H
														H
			5631.86	54.75	-13.45	68.2	38.18	33.26	12.9	29.59	320	136	P	V
			5676.7	55.47	-32.53	88	38.85	33.3	12.92	29.6	320	136	P	V
			5701.48	54.38	-51.24	105.62	37.74	33.31	12.94	29.61	320	136	P	V
			5721.54	55.61	-58.7	114.31	38.84	33.43	12.95	29.61	320	136	P	V
	*		5865	112.1	-	-	94.96	34	12.78	29.64	320	136	P	V
	*		5865	104.39	-	-	87.25	34	12.78	29.64	320	136	A	V
			5902.25	68.29	-36.58	104.87	51.27	34	12.66	29.64	320	136	P	V
			5932.75	60.29	-27.91	88.2	43.31	34.07	12.56	29.65	320	136	P	V
		5895	56.99	-33.21	90.2	39.95	34	12.68	29.64	320	136	A	V	
		5929.5	45.6	-22.6	68.2	28.62	34.06	12.57	29.65	320	136	A	V	
													V	
													V	



WiFi Ant. 4+3	Note	Frequency (MHz)	Level (dBμV/m)	Margin Limit (dB)	Limit Line (dBμV/m)	Read Level (dBμV)	Antenna Factor (dB/m)	Path Loss (dB)	Preamp Factor (dB)	Ant Pos (cm)	Table Pos (deg)	Peak Avg. (P/A)	Pol. (H/V)
802.11a CH 177 5885MHz		5609.735	54.9	-13.3	68.2	38.38	33.22	12.89	29.59	100	60	P	H
		5667.85	55.81	-25.64	81.45	39.19	33.3	12.92	29.6	100	60	P	H
		5718.885	55.44	-55.05	110.49	38.69	33.41	12.95	29.61	100	60	P	H
		5720.655	53.54	-58.75	112.29	36.78	33.42	12.95	29.61	100	60	P	H
	*	5885	112.4	-	-	95.33	34	12.71	29.64	100	60	P	H
	*	5885	104.95	-	-	87.88	34	12.71	29.64	100	60	A	H
		5895	94.67	-15.53	110.2	77.63	34	12.68	29.64	100	60	P	H
		5926	66.07	-22.13	88.2	49.09	34.05	12.58	29.65	100	60	P	H
		5895	82.15	-8.05	90.2	65.11	34	12.68	29.64	100	60	A	H
		5927.5	49.08	-19.12	68.2	32.09	34.06	12.58	29.65	100	60	A	H
		5635.695	53.9	-14.3	68.2	37.32	33.27	12.9	29.59	387	17	P	V
		5677.29	54.47	-33.97	88.44	37.85	33.3	12.92	29.6	387	17	P	V
		5700.3	54.94	-50.34	105.28	38.31	33.3	12.94	29.61	387	17	P	V
		5722.72	53.7	-63.3	117	36.92	33.44	12.95	29.61	387	17	P	V
	*	5885	112.33	-	-	95.26	34	12.71	29.64	387	17	P	V
	*	5885	104.51	-	-	87.44	34	12.71	29.64	387	17	A	V
		5895	93.56	-16.64	110.2	76.52	34	12.68	29.64	387	17	P	V
		5926	64.67	-23.53	88.2	47.69	34.05	12.58	29.65	387	17	P	V
		5897.25	81.84	-6.71	88.55	64.81	34	12.67	29.64	387	17	A	V
	5925.5	49.85	-18.35	68.2	32.87	34.05	12.58	29.65	387	17	A	V	
Remark	1. No other spurious found. 2. All results are PASS against Peak and Average limit line.												



UNII-4 - 5735~5895MHz

WIFI 802.11a (Harmonic @ 3m)

WIFI Ant. 4+3	Note	Frequency (MHz)	Level (dBμV/m)	Margin Limit (dB)	Limit Line (dBμV/m)	Read Level (dBμV)	Antenna Factor (dB/m)	Path Loss (dB)	Preamp Factor (dB)	Ant Pos (cm)	Table Pos (deg)	Peak Avg. (P/A)	Pol. (H/V)
		10751	48.76	-25.24	74	46.13	39.1	18.96	55.43	-	-	P	H
		10751	38.08	-15.92	54	35.45	39.1	18.96	55.43	-	-	A	H
		11690	46.51	-27.49	74	43.5	38.62	19.33	54.94	-	-	P	H
		14471	49.43	-24.57	74	41.62	40.4	21.73	54.32	-	-	P	H
		14471	42.47	-11.53	54	34.66	40.4	21.73	54.32	-	-	A	H
		17535	48.45	-39.75	88.2	40.74	38.74	25.25	56.28	-	-	P	H
		17989	53.71	-20.29	74	41.91	42.91	25.48	56.59	-	-	P	H
		17989	43.48	-10.52	54	31.68	42.91	25.48	56.59	-	-	A	H
													H
													H
													H
													H
802.11a													
CH 169													
5845MHz		11257	49.07	-24.93	74	46.02	39.11	19.12	55.18	-	-	P	V
		11257	38.69	-15.31	54	35.64	39.11	19.12	55.18	-	-	A	V
		11690	46.6	-27.4	74	43.59	38.62	19.33	54.94	-	-	P	V
		14471	48.22	-25.78	74	40.41	40.4	21.73	54.32	-	-	P	V
		14471	42.38	-11.62	54	34.57	40.4	21.73	54.32	-	-	A	V
		17535	49.7	-38.5	88.2	41.99	38.74	25.25	56.28	-	-	P	V
		17967	53.39	-20.61	74	41.77	42.74	25.46	56.58	-	-	P	V
		17967	43.15	-10.85	54	31.53	42.74	25.46	56.58	-	-	A	V
													V
													V
													V
													V



WIFI Ant. 4+3	Note	Frequency (MHz)	Level (dBμV/m)	Margin Limit (dB)	Limit Line (dBμV/m)	Read Level (dBμV)	Antenna Factor (dB/m)	Path Loss (dB)	Preamp Factor (dB)	Ant Pos (cm)	Table Pos (deg)	Peak Avg. (P/A)	Pol. (H/V)
		10905	49.25	-24.75	74	46.84	38.81	18.99	55.39	-	-	P	H
		10905	37.85	-16.15	54	35.44	38.81	18.99	55.39	-	-	A	H
		11730	46.15	-27.85	74	43.16	38.57	19.34	54.92	-	-	P	H
		14471	48.04	-25.96	74	40.23	40.4	21.73	54.32	-	-	P	H
		14471	42.66	-11.34	54	34.85	40.4	21.73	54.32	-	-	A	H
		17595	49.11	-39.09	88.2	40.98	39.17	25.28	56.32	-	-	P	H
		17967	53.64	-20.36	74	42.02	42.74	25.46	56.58	-	-	P	H
		17967	43.21	-10.79	54	31.59	42.74	25.46	56.58	-	-	A	H
													H
													H
													H
													H
802.11a													
CH 173													
5865MHz		11356	48.5	-25.5	74	45.24	39.2	19.17	55.11	-	-	P	V
		11356	39.2	-14.8	54	35.94	39.2	19.17	55.11	-	-	A	V
		11730	46.57	-27.43	74	43.58	38.57	19.34	54.92	-	-	P	V
		14471	49.93	-24.07	74	42.12	40.4	21.73	54.32	-	-	P	V
		14471	42.32	-11.68	54	34.51	40.4	21.73	54.32	-	-	A	V
		17595	49.56	-38.64	88.2	41.43	39.17	25.28	56.32	-	-	P	V
		17967	53.73	-20.27	74	42.11	42.74	25.46	56.58	-	-	P	V
		17967	43	-11	54	31.38	42.74	25.46	56.58	-	-	A	V
													V
													V
													V
													V



WiFi Ant. 4+3	Note	Frequency (MHz)	Level (dBμV/m)	Margin Limit (dB)	Limit Line (dBμV/m)	Read Level (dBμV)	Antenna Factor (dB/m)	Path Loss (dB)	Preamp Factor (dB)	Ant Pos (cm)	Table Pos (deg)	Peak Avg. (P/A)	Pol. (H/V)	
802.11a CH 177 5885MHz		10652	49.24	-24.76	74	46.74	39	18.95	55.45	-	-	P	H	
		10652	37.96	-16.04	54	35.46	39	18.95	55.45	-	-	A	H	
		11770	46.45	-27.55	74	43.47	38.53	19.36	54.91	-	-	P	H	
		14471	48.56	-25.44	74	40.75	40.4	21.73	54.32	-	-	P	H	
		14471	42.55	-11.45	54	34.74	40.4	21.73	54.32	-	-	A	H	
		17655	49.46	-38.74	88.2	40.88	39.64	25.31	56.37	-	-	P	H	
		17978	53.86	-20.14	74	42.16	42.82	25.47	56.59	-	-	P	H	
		17978	43.27	-10.73	54	31.57	42.82	25.47	56.59	-	-	A	H	
														H
														H
														H
														H
			10674	48.73	-25.27	74	46.23	39	18.95	55.45	-	-	P	V
			10674	38.17	-15.83	54	35.67	39	18.95	55.45	-	-	A	V
			11770	46.82	-27.18	74	43.84	38.53	19.36	54.91	-	-	P	V
			14471	48.51	-25.49	74	40.7	40.4	21.73	54.32	-	-	P	V
			14471	42.39	-11.61	54	34.58	40.4	21.73	54.32	-	-	A	V
			17655	50.4	-37.8	88.2	41.82	39.64	25.31	56.37	-	-	P	V
			17956	53.42	-20.58	74	41.88	42.65	25.46	56.57	-	-	P	V
			17956	42.98	-11.02	54	31.44	42.65	25.46	56.57	-	-	A	V
													V	
													V	
													V	
													V	
Remark	<ol style="list-style-type: none"> No other spurious found. All results are PASS against Peak and Average limit line. The emission position marked as "-" means no suspected emission found with sufficient margin against limit line or noise floor only. The emission level close to 18GHz is checked that the average emission level is noise floor only. 													



UNII-4 - 5735~5895MHz
WIFI 802.11ax HE20 (Band Edge @ 3m)

WIFI Ant. 4+3	Note	Frequency (MHz)	Level (dBμV/m)	Margin Limit (dB)	Limit Line (dBμV/m)	Read Level (dBμV)	Antenna Factor (dB/m)	Path Loss (dB)	Preamp Factor (dB)	Ant Pos (cm)	Table Pos (deg)	Peak Avg. (P/A)	Pol. (H/V)
		5648.5	55.92	-12.28	68.2	39.31	33.3	12.91	29.6	100	60	P	H
		5659.25	55.08	-19.99	75.07	38.47	33.3	12.91	29.6	100	60	P	H
		5705.25	58.62	-48.05	106.67	41.96	33.33	12.94	29.61	100	60	P	H
		5724.5	54.81	-66.25	121.06	38.02	33.45	12.95	29.61	100	60	P	H
	*	5845	112.59	-	-	95.41	33.97	12.84	29.63	100	60	P	H
	*	5845	103.01	-	-	85.83	33.97	12.84	29.63	100	60	A	H
		5906.75	62.15	-39.42	101.57	45.14	34.01	12.64	29.64	100	60	P	H
		5976.75	59.36	-28.84	88.2	42.66	33.94	12.42	29.66	100	60	P	H
802.11n		5895.75	47.98	-41.67	89.65	30.94	34	12.68	29.64	100	60	A	H
HE20		5996	45.13	-23.07	68.2	28.62	33.82	12.35	29.66	100	60	A	H
CH 169		5634.25	55.69	-12.51	68.2	39.11	33.27	12.9	29.59	337	354	P	V
5845MHz		5693.5	54.81	-45.6	100.41	38.18	33.3	12.93	29.6	337	354	P	V
		5703.75	54.83	-51.42	106.25	38.18	33.32	12.94	29.61	337	354	P	V
		5722	54.52	-60.84	115.36	37.75	33.43	12.95	29.61	337	354	P	V
	*	5845	111.83	-	-	94.65	33.97	12.84	29.63	337	354	P	V
	*	5845	101.8	-	-	84.62	33.97	12.84	29.63	337	354	A	V
		5898.5	58.53	-49.1	107.63	41.5	34	12.67	29.64	337	354	P	V
		5958	55.81	-32.39	88.2	38.93	34.05	12.48	29.65	337	354	P	V
		5895.5	48.47	-41.36	89.83	31.43	34	12.68	29.64	337	354	A	V
		5930.5	44.9	-23.3	68.2	27.92	34.06	12.57	29.65	337	354	A	V



WiFi Ant. 4+3	Note	Frequency (MHz)	Level (dBµV/m)	Margin Limit (dB)	Limit Line (dBµV/m)	Read Level (dBµV)	Antenna Factor (dB/m)	Path Loss (dB)	Preamp Factor (dB)	Ant Pos (cm)	Table Pos (deg)	Peak Avg. (P/A)	Pol. (H/V)
		5620.945	55.01	-13.19	68.2	38.47	33.24	12.89	29.59	106	61	P	H
		5699.12	55.09	-49.46	104.55	38.47	33.3	12.93	29.61	106	61	P	H
		5719.77	55.41	-55.33	110.74	38.65	33.42	12.95	29.61	106	61	P	H
		5721.835	54.35	-60.63	114.98	37.58	33.43	12.95	29.61	106	61	P	H
	*	5865	112.92	-	-	95.78	34	12.78	29.64	106	61	P	H
	*	5865	103.31	-	-	86.17	34	12.78	29.64	106	61	A	H
		5898.25	70.59	-37.22	107.81	53.56	34	12.67	29.64	106	61	P	H
		5929.25	61.43	-26.77	88.2	44.45	34.06	12.57	29.65	106	61	P	H
		5895.25	58.26	-31.76	90.02	41.22	34	12.68	29.64	106	61	A	H
		5925.75	46.28	-21.92	68.2	29.3	34.05	12.58	29.65	106	61	A	H
802.11n													H
HE20													H
CH 173		5641.89	54.13	-14.07	68.2	37.55	33.28	12.9	29.6	335	12	P	V
5865MHz		5696.465	54.87	-47.72	102.59	38.25	33.3	12.93	29.61	335	12	P	V
		5701.775	54.29	-51.41	105.7	37.65	33.31	12.94	29.61	335	12	P	V
		5724.785	54.48	-67.23	121.71	37.69	33.45	12.95	29.61	335	12	P	V
	*	5865	111.71	-	-	94.57	34	12.78	29.64	335	12	P	V
	*	5865	102.21	-	-	85.07	34	12.78	29.64	335	12	A	V
		5895.5	69.56	-40.27	109.83	52.52	34	12.68	29.64	335	12	P	V
		5932.75	57.49	-30.71	88.2	40.51	34.07	12.56	29.65	335	12	P	V
		5895.25	58.71	-31.31	90.02	41.67	34	12.68	29.64	335	12	A	V
		5925.25	45.99	-22.21	68.2	29.01	34.05	12.58	29.65	335	12	A	V
													V
													V



WIFI Ant. 4+3	Note	Frequency (MHz)	Level (dBμV/m)	Margin Limit (dB)	Limit Line (dBμV/m)	Read Level (dBμV)	Antenna Factor (dB/m)	Path Loss (dB)	Preamp Factor (dB)	Ant Pos (cm)	Table Pos (deg)	Peak Avg. (P/A)	Pol. (H/V)
802.11n HE20 CH 177 5885MHz		5614.16	54.31	-13.89	68.2	37.78	33.23	12.89	29.59	100	61	P	H
		5680.83	55.01	-36.04	91.05	38.39	33.3	12.92	29.6	100	61	P	H
		5712.69	54.55	-54.21	108.76	37.84	33.38	12.94	29.61	100	61	P	H
		5721.54	53.43	-60.88	114.31	36.66	33.43	12.95	29.61	100	61	P	H
	*	5885	112.42	-	-	95.35	34	12.71	29.64	100	61	P	H
	*	5885	102.18	-	-	85.11	34	12.71	29.64	100	61	A	H
		5895.5	95.09	-14.74	109.83	78.05	34	12.68	29.64	100	61	P	H
		5928	63.45	-24.75	88.2	46.47	34.06	12.57	29.65	100	61	P	H
		5895	81.43	-8.77	90.2	64.22	34	12.85	29.64	100	61	A	H
		5925	51.19	-17.01	68.2	34.21	34.05	12.58	29.65	100	61	A	H
		5603.54	54.67	-13.53	68.2	38.17	33.21	12.88	29.59	316	16	P	V
		5684.37	54.56	-39.11	93.67	37.93	33.3	12.93	29.6	316	16	P	V
		5707.38	54.02	-53.25	107.27	37.35	33.34	12.94	29.61	316	16	P	V
		5722.72	52.78	-64.22	117	36	33.44	12.95	29.61	316	16	P	V
	*	5885	111.53	-	-	94.46	34	12.71	29.64	316	16	P	V
	*	5885	101.95	-	-	84.88	34	12.71	29.64	316	16	A	V
		5895.25	96.87	-13.15	110.02	79.83	34	12.68	29.64	316	16	P	V
		5928.5	62.47	-25.73	88.2	45.49	34.06	12.57	29.65	316	16	P	V
	5895	81.94	-8.26	90.2	64.73	34	12.85	29.64	316	16	A	V	
	5925	51.73	-16.47	68.2	34.75	34.05	12.58	29.65	316	16	A		
Remark	1. No other spurious found. 2. All results are PASS against Peak and Average limit line.												



UNII-4 - 5735~5895MHz

WIFI 802.11ax HE20 (Harmonic @ 3m)

WIFI Ant. 4+3	Note	Frequency (MHz)	Level (dBμV/m)	Margin Limit (dB)	Limit Line (dBμV/m)	Read Level (dBμV)	Antenna Factor (dB/m)	Path Loss (dB)	Preamp Factor (dB)	Ant Pos (cm)	Table Pos (deg)	Peak Avg. (P/A)	Pol. (H/V)	
802.11n HE20 CH 169 5845MHz		10880	48.11	-25.89	74	45.64	38.88	18.99	55.4	-	-	P	H	
		10880	38.69	-15.31	54	36.22	38.88	18.99	55.4	-	-	A	H	
		11690	46.57	-27.43	74	43.56	38.62	19.33	54.94	-	-	P	H	
		14491	49.75	-24.25	74	41.93	40.4	21.75	54.33	-	-	P	H	
		14491	40.27	-13.73	54	32.45	40.4	21.75	54.33	-	-	A	H	
		17535	49.21	-38.99	88.2	41.5	38.74	25.25	56.28	-	-	P	H	
		17956	54.03	-19.97	74	42.49	42.65	25.46	56.57	-	-	P	H	
		17956	43.92	-10.08	54	32.38	42.65	25.46	56.57	-	-	A	H	
														H
														H
														H
														H
			10880	48.35	-25.65	74	45.88	38.88	18.99	55.4	-	-	P	V
			10880	38.86	-15.14	54	36.39	38.88	18.99	55.4	-	-	A	V
			11690	46.96	-27.04	74	43.95	38.62	19.33	54.94	-	-	P	V
			14491	49.28	-24.72	74	41.46	40.4	21.75	54.33	-	-	P	V
			14491	40.46	-13.54	54	32.64	40.4	21.75	54.33	-	-	A	V
			17535	49.53	-38.67	88.2	41.82	38.74	25.25	56.28	-	-	P	V
		17967	54.11	-19.89	74	42.49	42.74	25.46	56.58	-	-	P	V	
		17967	44.07	-9.93	54	32.45	42.74	25.46	56.58	-	-	A	V	
													V	
													V	
													V	
													V	



WIFI Ant. 4+3	Note	Frequency (MHz)	Level (dBμV/m)	Margin Limit (dB)	Limit Line (dBμV/m)	Read Level (dBμV)	Antenna Factor (dB/m)	Path Loss (dB)	Preamp Factor (dB)	Ant Pos (cm)	Table Pos (deg)	Peak Avg. (P/A)	Pol. (H/V)	
802.11n HE20 CH 173 5865MHz		10880	48.38	-25.62	74	45.91	38.88	18.99	55.4	-	-	P	H	
		10880	38.76	-15.24	54	36.29	38.88	18.99	55.4	-	-	A	H	
		11730	46.83	-27.17	74	43.84	38.57	19.34	54.92	-	-	P	H	
		14491	48.63	-25.37	74	40.81	40.4	21.75	54.33	-	-	P	H	
		14491	40.23	-13.77	54	32.41	40.4	21.75	54.33	-	-	A	H	
		17595	49.3	-38.9	88.2	41.17	39.17	25.28	56.32	-	-	P	H	
		17967	54.09	-19.91	74	42.47	42.74	25.46	56.58	-	-	P	H	
		17967	43.97	-10.03	54	32.35	42.74	25.46	56.58	-	-	A	H	
														H
														H
														H
														H
			10883	50.69	-23.31	74	48.23	38.87	18.99	55.4	-	-	P	V
			10883	39.08	-14.92	54	36.62	38.87	18.99	55.4	-	-	A	V
			11730	46.26	-27.74	74	43.27	38.57	19.34	54.92	-	-	P	V
			14491	48.67	-25.33	74	40.85	40.4	21.75	54.33	-	-	P	V
			14491	40.2	-13.8	54	32.38	40.4	21.75	54.33	-	-	A	V
			17595	49.81	-38.39	88.2	41.68	39.17	25.28	56.32	-	-	P	V
			17989	54.06	-19.94	74	42.26	42.91	25.48	56.59	-	-	P	V
		17989	43.96	-10.04	54	32.16	42.91	25.48	56.59	-	-	A	V	
													V	
													V	
													V	
													V	



WIFI Ant. 4+3	Note	Frequency (MHz)	Level (dBμV/m)	Margin Limit (dB)	Limit Line (dBμV/m)	Read Level (dBμV)	Antenna Factor (dB/m)	Path Loss (dB)	Preamp Factor (dB)	Ant Pos (cm)	Table Pos (deg)	Peak Avg. (P/A)	Pol. (H/V)	
802.11n HE20 CH 177 5885MHz		10883	48.21	-25.79	74	45.75	38.87	18.99	55.4	-	-	P	H	
		10883	38.83	-15.17	54	36.37	38.87	18.99	55.4	-	-	A	H	
		11770	46.19	-27.81	74	43.21	38.53	19.36	54.91	-	-	P	H	
		14491	48.27	-25.73	74	40.45	40.4	21.75	54.33	-	-	P	H	
		14491	40.07	-13.93	54	32.25	40.4	21.75	54.33	-	-	A	H	
		17655	48.95	-39.25	88.2	40.37	39.64	25.31	56.37	-	-	P	H	
		17967	54.61	-19.39	74	42.99	42.74	25.46	56.58	-	-	P	H	
		17967	44.01	-9.99	54	32.39	42.74	25.46	56.58	-	-	A	H	
														H
														H
														H
														H
			10880	48.33	-25.67	74	45.86	38.88	18.99	55.4	-	-	P	V
			10880	38.95	-15.05	54	36.48	38.88	18.99	55.4	-	-	A	V
			11770	46.02	-27.98	74	43.04	38.53	19.36	54.91	-	-	P	V
			14491	49.23	-24.77	74	41.41	40.4	21.75	54.33	-	-	P	V
			14491	40.23	-13.77	54	32.41	40.4	21.75	54.33	-	-	A	V
			17655	50.3	-37.9	88.2	41.72	39.64	25.31	56.37	-	-	P	V
			17945	54.66	-19.34	74	43.21	42.56	25.45	56.56	-	-	P	V
		17945	43.81	-10.19	54	32.36	42.56	25.45	56.56	-	-	A	V	
													V	
													V	
													V	
													V	
Remark	<ol style="list-style-type: none"> No other spurious found. All results are PASS against Peak and Average limit line. The emission position marked as "-" means no suspected emission found with sufficient margin against limit line or noise floor only. The emission level close to 18GHz is checked that the average emission level is noise floor only. 													



UNII-4 - 5735~5895MHz
WIFI 802.11ax HE40 (Band Edge @ 3m)

WIFI Ant. 4+3	Note	Frequency (MHz)	Level (dBμV/m)	Margin Limit (dB)	Limit Line (dBμV/m)	Read Level (dBμV)	Antenna Factor (dB/m)	Path Loss (dB)	Preamp Factor (dB)	Ant Pos (cm)	Table Pos (deg)	Peak Avg. (P/A)	Pol. (H/V)
		5648.75	55.58	-12.62	68.2	38.97	33.3	12.91	29.6	100	60	P	H
		5663	55.42	-22.43	77.85	38.81	33.3	12.91	29.6	100	60	P	H
		5713.25	55.57	-53.34	108.91	38.86	33.38	12.94	29.61	100	60	P	H
		5720	54.29	-56.51	110.8	37.53	33.42	12.95	29.61	100	60	P	H
	*	5835	109.63	-	-	92.47	33.91	12.88	29.63	100	60	P	H
	*	5835	99.45	-	-	82.29	33.91	12.88	29.63	100	60	A	H
		5896.5	64.16	-44.94	109.1	47.12	34	12.68	29.64	100	60	P	H
		5926	57.62	-30.58	88.2	40.64	34.05	12.58	29.65	100	60	P	H
		5896.25	54.28	-35	89.28	37.24	34	12.68	29.64	100	60	A	H
		5927.25	47.21	-20.99	68.2	30.23	34.05	12.58	29.65	100	60	A	H
802.11n													H
HE40													H
CH 167		5627.75	54.81	-13.39	68.2	38.24	33.26	12.9	29.59	319	355	P	V
5835MHz		5682.5	55.45	-36.84	92.29	38.82	33.3	12.93	29.6	319	355	P	V
		5716.5	54.84	-54.98	109.82	38.11	33.4	12.94	29.61	319	355	P	V
		5723.25	55.83	-62.38	118.21	39.05	33.44	12.95	29.61	319	355	P	V
	*	5835	109.15	-	-	91.99	33.91	12.88	29.63	319	355	P	V
	*	5835	98.72	-	-	81.56	33.91	12.88	29.63	319	355	A	V
		5898.5	68.79	-38.84	107.63	51.76	34	12.67	29.64	319	355	P	V
		5925.75	57.07	-31.13	88.2	40.09	34.05	12.58	29.65	319	355	P	V
		5895.25	56.82	-33.2	90.02	39.78	34	12.68	29.64	319	355	A	V
		5926	48.18	-20.02	68.2	31.2	34.05	12.58	29.65	319	355	A	V
													V
													V



WIFI Ant. 4+3	Note	Frequency (MHz)	Level (dBμV/m)	Margin Limit (dB)	Limit Line (dBμV/m)	Read Level (dBμV)	Antenna Factor (dB/m)	Path Loss (dB)	Preamp Factor (dB)	Ant Pos (cm)	Table Pos (deg)	Peak Avg. (P/A)	Pol. (H/V)
		5620.25	55.4	-12.8	68.2	38.86	33.24	12.89	29.59	100	62	P	H
		5693.5	55.92	-44.49	100.41	39.29	33.3	12.93	29.6	100	62	P	H
		5719.5	56.56	-54.1	110.66	39.8	33.42	12.95	29.61	100	62	P	H
		5725	55.13	-67.07	122.2	38.34	33.45	12.95	29.61	100	62	P	H
	*	5875	109.31	-	-	92.2	34	12.75	29.64	100	62	P	H
	*	5875	99.29	-	-	82.18	34	12.75	29.64	100	62	A	H
		5908.75	86.07	-14.03	100.1	69.05	34.02	12.64	29.64	100	62	P	H
		5925.75	72.94	-15.26	88.2	55.96	34.05	12.58	29.65	100	62	P	H
		5895.25	77.19	-12.83	90.02	60.15	34	12.68	29.64	100	62	A	H
		5925	62.19	-6.01	68.2	45.21	34.05	12.58	29.65	100	62	A	H
802.11n													H
HE40													H
CH 175		5643.75	55.36	-12.84	68.2	38.77	33.29	12.9	29.6	352	13	P	V
5875MHz		5673.5	54.69	-30.94	85.63	38.07	33.3	12.92	29.6	352	13	P	V
		5713	54.44	-54.4	108.84	37.73	33.38	12.94	29.61	352	13	P	V
		5725	54.45	-67.75	122.2	37.66	33.45	12.95	29.61	352	13	P	V
	*	5875	109.1	-	-	91.99	34	12.75	29.64	352	13	P	V
	*	5875	98.92	-	-	81.81	34	12.75	29.64	352	13	A	V
		5895.25	86.9	-23.12	110.02	69.86	34	12.68	29.64	352	13	P	V
		5925	73.85	-14.35	88.2	56.87	34.05	12.58	29.65	352	13	P	V
		5895.25	77.75	-12.27	90.02	60.71	34	12.68	29.64	352	13	A	V
		5925	62.82	-5.38	68.2	45.84	34.05	12.58	29.65	352	13	A	V
													V
													V
Remark	1. No other spurious found. 2. All results are PASS against Peak and Average limit line.												



UNII-4 - 5735~5895MHz
WIFI 802.11ax HE40 (Harmonic @ 3m)

WIFI Ant. 4+3	Note	Frequency (MHz)	Level (dBµV/m)	Margin Limit (dB)	Limit Line (dBµV/m)	Read Level (dBµV)	Antenna Factor (dB/m)	Path Loss (dB)	Preamp Factor (dB)	Ant Pos (cm)	Table Pos (deg)	Peak Avg. (P/A)	Pol. (H/V)
		10883	48.24	-25.76	74	45.78	38.87	18.99	55.4	-	-	P	H
		10883	38.63	-15.37	54	36.17	38.87	18.99	55.4	-	-	A	H
		11670	46.24	-27.76	74	43.21	38.66	19.31	54.94	-	-	P	H
		14491	48.6	-25.4	74	40.78	40.4	21.75	54.33	-	-	P	H
		14491	40.47	-13.53	54	32.65	40.4	21.75	54.33	-	-	A	H
		17505	47.59	-40.61	88.2	40.09	38.53	25.23	56.26	-	-	P	H
		17945	54.06	-19.94	74	42.61	42.56	25.45	56.56	-	-	P	H
		17945	43.61	-10.39	54	32.16	42.56	25.45	56.56	-	-	A	H
													H
													H
													H
													H
802.11n													
HE40													
CH 167		10880	48.29	-25.71	74	45.82	38.88	18.99	55.4	-	-	P	V
5835MHz		10880	38.81	-15.19	54	36.34	38.88	18.99	55.4	-	-	A	V
		11670	47.59	-26.41	74	44.56	38.66	19.31	54.94	-	-	P	V
		14491	48.85	-25.15	74	41.03	40.4	21.75	54.33	-	-	P	V
		14491	40.43	-13.57	54	32.61	40.4	21.75	54.33	-	-	A	V
		17505	47.78	-40.42	88.2	40.28	38.53	25.23	56.26	-	-	P	V
		17945	53.8	-20.2	74	42.35	42.56	25.45	56.56	-	-	P	V
		17945	43.69	-10.31	54	32.24	42.56	25.45	56.56	-	-	A	V
													V
													V
													V
													V



WIFI Ant. 4+3	Note	Frequency (MHz)	Level (dBμV/m)	Margin Limit (dB)	Limit Line (dBμV/m)	Read Level (dBμV)	Antenna Factor (dB/m)	Path Loss (dB)	Preamp Factor (dB)	Ant Pos (cm)	Table Pos (deg)	Peak Avg. (P/A)	Pol. (H/V)	
802.11n HE40 CH 175 5875MHz		10880	48.33	-25.67	74	45.86	38.88	18.99	55.4	-	-	P	H	
		10880	38.96	-15.04	54	36.49	38.88	18.99	55.4	-	-	A	H	
		11750	46.29	-27.71	74	43.32	38.55	19.34	54.92	-	-	P	H	
		14491	47.92	-26.08	74	40.1	40.4	21.75	54.33	-	-	P	H	
		14491	40.12	-13.88	54	32.3	40.4	21.75	54.33	-	-	A	H	
		17625	49.4	-38.8	88.2	41.05	39.4	25.29	56.34	-	-	P	H	
		17901	53.57	-20.43	74	42.46	42.21	25.43	56.53	-	-	P	H	
		17901	43.62	-10.38	54	32.51	42.21	25.43	56.53	-	-	A	H	
														H
														H
														H
														H
			10880	48.47	-25.53	74	46	38.88	18.99	55.4	-	-	P	V
			10880	38.77	-15.23	54	36.3	38.88	18.99	55.4	-	-	A	V
			11750	45.91	-28.09	74	42.94	38.55	19.34	54.92	-	-	P	V
			14491	48.97	-25.03	74	41.15	40.4	21.75	54.33	-	-	P	V
			14491	40.16	-13.84	54	32.34	40.4	21.75	54.33	-	-	A	V
			17625	49.6	-38.6	88.2	41.25	39.4	25.29	56.34	-	-	P	V
		17956	53.87	-20.13	74	42.33	42.65	25.46	56.57	-	-	P	V	
		17956	43.99	-10.01	54	32.45	42.65	25.46	56.57	-	-	A	V	
													V	
													V	
													V	
													V	
Remark	<ol style="list-style-type: none"> No other spurious found. All results are PASS against Peak and Average limit line. The emission position marked as "-" means no suspected emission found with sufficient margin against limit line or noise floor only. The emission level close to 18GHz is checked that the average emission level is noise floor only. 													



UNII-4 - 5735~5895MHz
WIFI 802.11ax HE80 (Band Edge @ 3m)

WIFI Ant. 4+3	Note	Frequency (MHz)	Level (dBμV/m)	Margin Limit (dB)	Limit Line (dBμV/m)	Read Level (dBμV)	Antenna Factor (dB/m)	Path Loss (dB)	Preamp Factor (dB)	Ant Pos (cm)	Table Pos (deg)	Peak Avg. (P/A)	Pol. (H/V)
		5600.25	55.36	-12.84	68.2	38.87	33.2	12.88	29.59	105	61	P	H
		5697.25	57.67	-45.5	103.17	41.05	33.3	12.93	29.61	105	61	P	H
		5715.75	58.13	-51.48	109.61	41.41	33.39	12.94	29.61	105	61	P	H
		5721.25	56.47	-57.18	113.65	39.7	33.43	12.95	29.61	105	61	P	H
	*	5855	105.79	37.59	68.2	88.61	34	12.81	29.63	105	61	P	H
	*	5855	96.12	42.12	54	78.94	34	12.81	29.63	105	61	A	H
		5895.25	79.49	-30.53	110.02	62.45	34	12.68	29.64	105	61	P	H
		5928	73.46	-14.74	88.2	56.48	34.06	12.57	29.65	105	61	P	H
		5895.25	71.6	-18.42	90.02	54.56	34	12.68	29.64	105	61	A	H
		5925	64.76	-3.44	68.2	47.78	34.05	12.58	29.65	105	61	A	H
802.11ax													H
HE80													H
CH 171		5621.25	55.06	-13.14	68.2	38.52	33.24	12.89	29.59	368	15	P	V
5855MHz		5662.25	56.8	-20.5	77.3	40.19	33.3	12.91	29.6	368	15	P	V
		5711.75	56.36	-52.13	108.49	39.66	33.37	12.94	29.61	368	15	P	V
		5725	57.42	-64.78	122.2	40.63	33.45	12.95	29.61	368	15	P	V
	*	5855	103.81	35.61	68.2	86.63	34	12.81	29.63	368	15	P	V
	*	5855	95.21	41.21	54	78.03	34	12.81	29.63	368	15	A	V
		5895.25	81.71	-28.31	110.02	64.67	34	12.68	29.64	368	15	P	V
		5926.5	75.35	-12.85	88.2	58.37	34.05	12.58	29.65	368	15	P	V
		5895.25	72.26	-17.76	90.02	55.22	34	12.68	29.64	368	15	A	V
		5925.5	65.74	-2.46	68.2	48.76	34.05	12.58	29.65	368	15	A	V
													V
													V
Remark	1. No other spurious found. 2. All results are PASS against Peak and Average limit line.												



UNII-4 - 5735~5895MHz

WIFI 802.11ax HE80 (Harmonic @ 3m)

WIFI Ant. 4+3	Note	Frequency (MHz)	Level (dBμV/m)	Margin Limit (dB)	Limit Line (dBμV/m)	Read Level (dBμV)	Antenna Factor (dB/m)	Path Loss (dB)	Preamp Factor (dB)	Ant Pos (cm)	Table Pos (deg)	Peak Avg. (P/A)	Pol. (H/V)
		10608	48.76	-25.24	74	46.28	39	18.94	55.46	-	-	P	H
		10608	38.34	-15.66	54	35.86	39	18.94	55.46	-	-	A	H
		11710	47.17	-26.83	74	44.18	38.59	19.33	54.93	-	-	P	H
		14471	48.5	-25.5	74	40.69	40.4	21.73	54.32	-	-	P	H
		14471	42.36	-11.64	54	34.55	40.4	21.73	54.32	-	-	A	H
		17565	49.07	-39.13	88.2	41.15	38.96	25.26	56.3	-	-	P	H
		17890	53.88	-20.12	74	42.91	42.08	25.42	56.53	-	-	P	H
		17890	42.61	-11.39	54	31.64	42.08	25.42	56.53	-	-	A	H
													H
													H
													H
													H
802.11ax HE80 CH 171		10916	48.92	-25.08	74	46.49	38.82	19	55.39	-	-	P	V
5855MHz		10916	38.2	-15.8	54	35.77	38.82	19	55.39	-	-	A	V
		11710	46.98	-27.02	74	43.99	38.59	19.33	54.93	-	-	P	V
		14480	49.6	-24.4	74	41.78	40.4	21.74	54.32	-	-	P	V
		14480	42.8	-11.2	54	34.98	40.4	21.74	54.32	-	-	A	V
		17565	49.25	-38.95	88.2	41.33	38.96	25.26	56.3	-	-	P	V
		17945	53.53	-20.47	74	42.08	42.56	25.45	56.56	-	-	P	V
		17945	43.14	-10.86	54	31.69	42.56	25.45	56.56	-	-	A	V
													V
													V
													V
													V

Remark	<ol style="list-style-type: none"> No other spurious found. All results are PASS against Peak and Average limit line. The emission position marked as "-" means no suspected emission found with sufficient margin against limit line or noise floor only. The emission level close to 18GHz is checked that the average emission level is noise floor only.
---------------	--



UNII-4 - 5735~5895MHz
WIFI 802.11ax HE160 (Band Edge @ 3m)

WIFI Ant. 4+3	Note	Frequency (MHz)	Level (dBμV/m)	Margin Limit (dB)	Limit Line (dBμV/m)	Read Level (dBμV)	Antenna Factor (dB/m)	Path Loss (dB)	Preamp Factor (dB)	Ant Pos (cm)	Table Pos (deg)	Peak Avg. (P/A)	Pol. (H/V)
		5641.25	66.11	-2.09	68.2	49.53	33.28	12.9	29.6	106	60	P	H
		5699.75	73.71	-31.31	105.02	57.09	33.3	12.93	29.61	106	60	P	H
		5704	74.07	-32.25	106.32	57.42	33.32	12.94	29.61	106	60	P	H
		5720	73.77	-37.03	110.8	57.01	33.42	12.95	29.61	106	60	P	H
	*	5815	103.16	34.96	68.2	86.06	33.79	12.94	29.63	106	60	P	H
	*	5815	92.79	38.79	54	75.69	33.79	12.94	29.63	106	60	A	H
		5895.25	78.83	-31.19	110.02	61.79	34	12.68	29.64	106	60	P	H
		5946.25	73.36	-14.84	88.2	56.41	34.09	12.51	29.65	106	60	P	H
		5895.25	67.16	-22.86	90.02	50.12	34	12.68	29.64	106	60	A	H
		5946.5	63.31	-4.89	68.2	46.36	34.09	12.51	29.65	106	60	A	H
802.11ax													H
HE160													H
CH 163		5650	64.08	-4.12	68.2	47.47	33.3	12.91	29.6	313	1	P	V
5815MHz		5697.75	71.57	-31.97	103.54	54.95	33.3	12.93	29.61	313	1	P	V
		5706.75	72.77	-34.32	107.09	56.1	33.34	12.94	29.61	313	1	P	V
		5723	68.96	-48.68	117.64	52.18	33.44	12.95	29.61	313	1	P	V
	*	5815	100.94	32.74	68.2	83.84	33.79	12.94	29.63	313	1	P	V
	*	5815	90.96	36.96	54	73.86	33.79	12.94	29.63	313	1	A	V
		5895.25	79.44	-30.58	110.02	62.4	34	12.68	29.64	313	1	P	V
		5946.5	73.85	-14.35	88.2	56.9	34.09	12.51	29.65	313	1	P	V
		5895.25	67.91	-22.11	90.02	50.87	34	12.68	29.64	313	1	A	V
		5946.5	62.93	-5.27	68.2	45.98	34.09	12.51	29.65	313	1	A	V
													V
													V
Remark	1. No other spurious found. 2. All results are PASS against Peak and Average limit line.												



UNII-4 - 5735~5895MHz
WIFI 802.11ax HE160 (Harmonic @ 3m)

WIFI Ant. 4+3	Note	Frequency (MHz)	Level (dBμV/m)	Margin Limit (dB)	Limit Line (dBμV/m)	Read Level (dBμV)	Antenna Factor (dB/m)	Path Loss (dB)	Preamp Factor (dB)	Ant Pos (cm)	Table Pos (deg)	Peak Avg. (P/A)	Pol. (H/V)
		10850	49.2	-24.8	74	46.63	39	18.57	55.41	-	-	P	H
		10850	38.4	-15.6	54	35.83	39	18.57	55.41	-	-	A	H
		11630	46.67	-27.33	74	43.59	38.74	19.15	54.96	-	-	P	H
		14471	49.44	-24.56	74	41.63	40.4	21.46	54.32	-	-	P	H
		14471	42.39	-11.61	54	34.58	40.4	21.46	54.32	-	-	A	H
		17455	48.78	-39.42	88.2	41.32	38.41	24.61	56.16	-	-	P	H
		17945	53.84	-20.16	74	42.39	42.56	24.76	56.56	-	-	P	H
		17945	43.29	-10.71	54	31.84	42.56	24.76	56.56	-	-	A	H
													H
													H
													H
													H
802.11ax													H
HE160													H
CH 163		11070	48.79	-25.21	74	46.16	38.9	18.71	55.32	-	-	P	V
5815MHz		11070	38.05	-15.95	54	35.42	38.9	18.71	55.32	-	-	A	V
		11630	47.06	-26.94	74	43.98	38.74	19.15	54.96	-	-	P	V
		14475	49.13	-24.87	74	41.31	40.4	21.47	54.32	-	-	P	V
		14475	42.5	-11.5	54	34.68	40.4	21.47	54.32	-	-	A	V
		17445	48.1	-40.1	88.2	40.65	38.39	24.6	56.14	-	-	P	V
		17967	54.56	-19.44	74	42.94	42.74	24.77	56.58	-	-	P	V
		17967	42.9	-11.1	54	31.28	42.74	24.77	56.58	-	-	A	V
													V
													V
													V
													V

Remark	<ol style="list-style-type: none"> No other spurious found. All results are PASS against Peak and Average limit line. The emission position marked as "-" means no suspected emission found with sufficient margin against limit line or noise floor only. The emission level close to 18GHz is checked that the average emission level is noise floor only.
---------------	--



Emission above 18GHz

5GHz WIFI 802.11ax HE160 Full (SHF @ 1m)

WIFI	Note	Frequency	Level	Over	Limit	Read	Antenna	Path	Preamp	Ant	Table	Peak	Pol.
Ant.				Limit	Line	Level	Factor	Loss	Factor	Pos	Pos	Avg.	
4+3		(MHz)	(dBμV/m)	(dB)	(dBμV/m)	(dBμV)	(dB/m)	(dB)	(dB)	(cm)	(deg)	(P/A)	(H/V)
802.11ax HE160 Full SHF		22800	36.62	-37.38	74	55.51	38.58	-3.21	54.26	-	-	P	H
		37732	44.52	-23.68	68.2	60.26	42.86	-1.05	57.55	-	-	P	H
													H
													H
													H
													H
													H
													H
													H
													H
													H
													H
													H
													H
													H
													H
													H
													H
													H
			23880	37.42	-36.58	74	55.28	38.8	-2.89	53.77	-	-	P
		34022	41.34	-26.86	68.2	59.97	41.11	-1.82	57.92	-	-	P	V
													V
													V
													V
													V
													V
													V
													V
													V
													V
													V
													V
													V
													V
													V
													V

Remark

- No other spurious found.
- All results are PASS against limit line.
- The emission position marked as "-" means no suspected emission found with sufficient margin against limit line or noise floor only.



Emission below 1GHz

WIFI 802.11ax HE160 Full (LF @ 3m)

WIFI	Note	Frequency	Level	Margin	Limit	Read	Antenna	Path	Preamp	Ant	Table	Peak	Pol.	
Ant.				Limit	Line	Level	Factor	Loss	Factor	Pos	Pos	Avg.		
4+3		(MHz)	(dBμV/m)	(dB)	(dBμV/m)	(dBμV)	(dB/m)	(dB)	(dB)	(cm)	(deg)	(P/A)	(H/V)	
802.11ax HE160 Full LF		94.99	24.72	-18.78	43.5	40.07	15.2	1.76	32.31	-	-	P	H	
		186.17	22.24	-21.26	43.5	37.14	14.86	2.47	32.23	-	-	P	H	
		259.89	20.07	-25.93	46	29.46	20.01	2.85	32.25	-	-	P	H	
		532.46	25.92	-20.08	46	30.17	24.07	4.06	32.38	-	-	P	H	
		658.56	28.75	-17.25	46	30.54	26.2	4.48	32.47	-	-	P	H	
		785.63	32.35	-13.65	46	31.72	28.02	4.89	32.28	-	-	P	H	
														H
														H
														H
														H
														H
														H
			36.79	26.26	-13.74	40	36.26	21.33	0.97	32.3	-	-	P	V
			94.99	24.35	-19.15	43.5	39.7	15.2	1.76	32.31	-	-	P	V
			131.85	21.14	-22.36	43.5	33.69	17.65	2.07	32.27	-	-	P	V
			179.38	25.88	-17.62	43.5	40.59	15.08	2.43	32.22	-	-	P	V
			418	24.63	-21.37	46	30.66	22.76	3.61	32.4	-	-	P	V
			642.07	28.86	-17.14	46	30.62	26.3	4.45	32.51	-	-	P	V
													V	
													V	
													V	
													V	
													V	
													V	
													V	
													V	
Remark	1. No other spurious found. 2. All results are PASS against limit line. 3. The emission position marked as "-" means no suspected emission found and emission level has at least 6dB margin against limit or emission is noise floor only.													



Note symbol

*	Fundamental Frequency which can be ignored. However, the level of any unwanted emissions shall not exceed the level of the fundamental frequency.
!	Test result is Margin limit line.
P/A	Peak or Average
H/V	Horizontal or Vertical



A calculation example for radiated spurious emission is shown as below:

WIFI	Note	Frequency	Level	Margin	Limit	Read	Antenna	Path	Preamp	Ant	Table	Peak	Pol.
Ant.				Limit	Line	Level	Factor	Loss	Factor	Pos	Pos	Avg.	
4+3		(MHz)	(dBμV/m)	(dB)	(dBμV/m)	(dBμV)	(dB/m)	(dB)	(dB)	(cm)	(deg)	(P/A)	(H/V)
802.11b		2390	55.45	-18.55	74	54.51	32.22	4.58	35.86	103	308	P	H
CH 01													
2412MHz		2390	43.54	-10.46	54	42.6	32.22	4.58	35.86	103	308	A	H

1. Path Loss(dB) = Cable loss(dB) + Filter loss(dB) + Attenuator loss(dB)
2. Level(dBμV/m) = Antenna Factor(dB/m) + Path Loss(dB) + Read Level(dBμV) - Preamp Factor(dB)
3. Margin Limit(dB) = Level(dBμV/m) – Limit Line(dBμV/m)

For Peak Limit @ 2390MHz:

1. Level(dBμV/m)
= Antenna Factor(dB/m) + Path Loss(dB) + Read Level(dBμV) - Preamp Factor(dB)
= 32.22(dB/m) + 4.58(dB) + 54.51(dBμV) – 35.86 (dB)
= 55.45 (dBμV/m)
2. Margin Limit(dB)
= Level(dBμV/m) – Limit Line(dBμV/m)
= 55.45(dBμV/m) – 74(dBμV/m)
= -18.55(dB)

For Average Limit @ 2390MHz:

1. Level(dBμV/m)
= Antenna Factor(dB/m) + Path Loss(dB) + Read Level(dBμV) - Preamp Factor(dB)
= 32.22(dB/m) + 4.58(dB) + 42.6(dBμV) – 35.86 (dB)
= 43.54 (dBμV/m)
2. Margin Limit(dB) = Level(dBμV/m) – Limit Line(dBμV/m)
= 43.54(dBμV/m) – 54(dBμV/m)
= -10.46(dB)

Both peak and average measured complies with the limit line, so test result is "PASS".



Appendix D. Radiated Spurious Emission Plots

Test Engineer :	Karl Hou and Andy Yang	Temperature :	20~25°C
		Relative Humidity :	50~60%

Note symbol

-L	Low channel location
-R	High channel location



UNII-4 - 5735~5895MHz
 WIFI 802.11a (Band Edge @ 3m)

WIFI	UNII-4 5735~5895MHz Band Edge @ 3m	
ANT	802.11a CH169 5845MHz - L	
4+3	Horizontal	Fundamental
Peak	<p>Site : 03CH16-HY Condition : PEAK_BE(UNII-4)_16-24 3m 9120D_0214_210804 HORIZONTAL : RBW:1000.000KHz VBW:3000.000KHz SWT:Auto</p>	<p>Site : 03CH16-HY Condition : PEAK(UNII-4) 3m 9120D_0214_210804 HORIZONTAL : RBW:1000.000KHz VBW:3000.000KHz SWT:Auto</p>

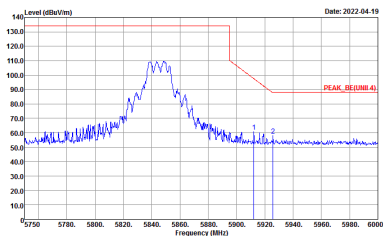
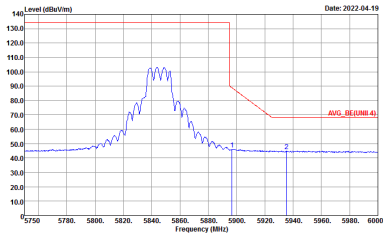

WIFI	UNII-4 5735~5895MHz Band Edge @ 3m	
ANT	802.11a CH169 5845MHz - R	
4+3	Horizontal	Fundamental
<p>Peak</p>	 <p>Site : 03CH16-HY Condition : PEAK_BE(UNII 4) 3m 9120D_02114_210804 HORIZONTAL : RBW:1000.000KHz VBW:3000.000KHz SWT:Auto</p>	<p>Left blank</p>
<p>Avg.</p>	 <p>Site : 03CH16-HY Condition : AVG_BE(UNII 4) 3m 9120D_02114_210804 HORIZONTAL : RBW:1000.000KHz VBW:1000KHz SWT:Auto</p>	<p>Left blank</p>

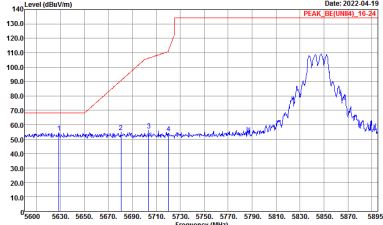
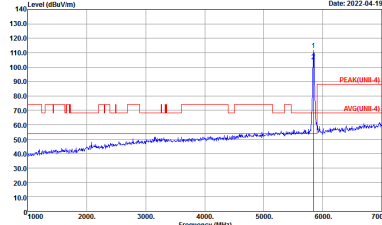

WIFI	UNII-4 5735~5895MHz Band Edge @ 3m	
ANT	802.11a CH169 5845MHz - L	
4+3	Vertical	Fundamental
Peak	 <p>Date: 2022-04-19 PEAK: 5845MHz_75.20</p> <p>Site : 03CH16-HY Condition : PEAK_BE(UNII4)_16-24 3m 9120D_02114_210804 VERTICAL : RBW:1000.000KHz VBW:3000.000KHz SWT:Auto</p>	 <p>Date: 2022-04-19 PEAK(UNI-4)</p> <p>Site : 03CH16-HY Condition : PEAK(UNI-4) 3m 9120D_02114_210804 VERTICAL : RBW:1000.000KHz VBW:3000.000KHz SWT:Auto</p>

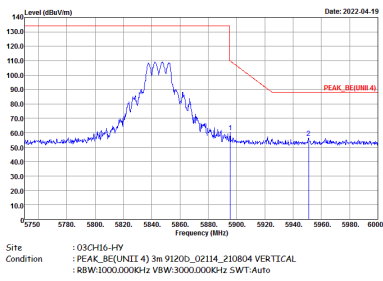
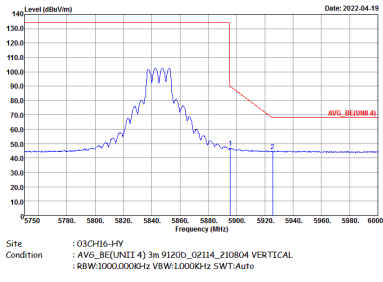

WIFI	UNII-4 5735~5895MHz Band Edge @ 3m	
ANT	802.11a CH169 5845MHz - R	
4+3	Vertical	Fundamental
Peak		Left blank
Avg.		Left blank



WIFI	UNII-4 5735~5895MHz Band Edge @ 3m	
ANT	802.11a CH173 5865MHz - L	
4+3	Horizontal	Fundamental
Peak	<p>Date: 2022-04-19 PEAK_BE (UNII4)_16-24</p> <p>Site : 03CH16-HY Condition : PEAK_BE(UNII4)_16-24 3m 9120D_02114_210804 HORIZONTAL</p>	<p>Date: 2022-04-19 PEAK(UNII-4) AVG(UNII-4)</p> <p>Site : 03CH16-HY Condition : PEAK(UNII-4) 3m 9120D_02114_210804 HORIZONTAL</p>

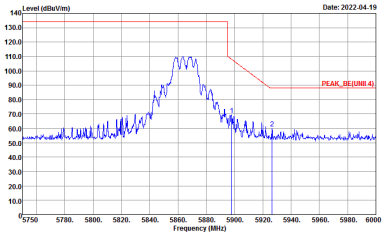
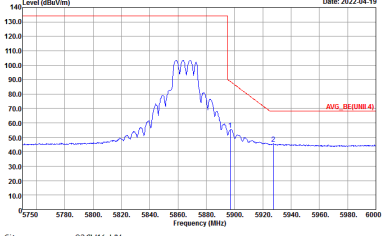

WIFI	UNII-4 5735~5895MHz Band Edge @ 3m	
ANT	802.11a CH173 5865MHz - R	
4+3	Horizontal	Fundamental
<p>Peak</p>	 <p>Site : 03CH16-HY Condition : PEAK_BE(UNII 4) 3m 9120D_02114_210804 HORIZONTAL</p>	<p>Left blank</p>
<p>Avg.</p>	 <p>Site : 03CH16-HY Condition : AVG_BE(UNII 4) 3m 9120D_02114_210804 HORIZONTAL</p>	<p>Left blank</p>



WIFI	UNII-4 5735~5895MHz Band Edge @ 3m	
ANT	802.11a CH173 5865MHz - L	
4+3	Vertical	Fundamental
Peak	<p>Site : 03CH16-HY Condition : PEAK_BE(UNII-4)_16-24 3m 9120D_02114_210804 VERTICAL</p>	<p>Site : 03CH16-HY Condition : PEAK(UNII-4) 3m 9120D_02114_210804 VERTICAL</p>



WIFI	UNII-4 5735~5895MHz Band Edge @ 3m	
ANT	802.11a CH173 5865MHz - R	
4+3	Vertical	Fundamental
<p>Peak</p>		<p>Left blank</p>
<p>Avg.</p>		<p>Left blank</p>



WIFI	UNII-4 5735~5895MHz Band Edge @ 3m	
ANT	802.11a CH177 5885MHz - L	
4+3	Horizontal	Fundamental
Peak	<p>Site : 03CH16-HY Condition : PEAK_BE(UNII4)_16-24 3m 9120D_02114_210804 HORIZONTAL : RBW:1000.000KHz VBW:3000.000KHz SWT:Auto</p>	<p>Site : 03CH16-HY Condition : PEAK(UNII-4) 3m 9120D_02114_210804 HORIZONTAL : RBW:1000.000KHz VBW:3000.000KHz SWT:Auto</p>



WIFI	UNII-4 5735~5895MHz Band Edge @ 3m	
ANT	802.11a CH177 5885MHz - R	
4+3	Horizontal	Fundamental
<p>Peak</p>		<p>Left blank</p>
<p>Avg.</p>		<p>Left blank</p>



WIFI	UNII-4 5735~5895MHz Band Edge @ 3m	
ANT	802.11a CH177 5885MHz - L	
4+3	Vertical	Fundamental
Peak	<p>Site : 03CH16-HY Condition : PEAK_BE(UNII4)_16-24 3m 9120D_02114_210804 VERTICAL : RBW:1000.000KHz VBW:3000.000KHz SWT:Auto</p>	<p>Site : 03CH16-HY Condition : PEAK(UNII-4) 3m 9120D_02114_210804 VERTICAL : RBW:1000.000KHz VBW:3000.000KHz SWT:Auto</p>

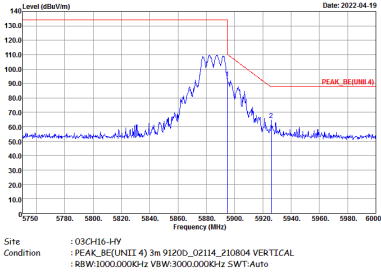
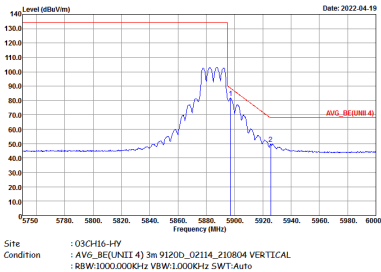

WIFI	UNII-4 5735~5895MHz Band Edge @ 3m	
ANT	802.11a CH177 5885MHz - R	
4+3	Vertical	Fundamental
Peak		Left blank
Avg.		Left blank



UNII-4 - 5735~5895MHz
WIFI 802.11ax HE20 (Band Edge @ 3m)

Table with 2 columns: WIFI (UNII-4 5735~5895MHz Band Edge @ 3m), ANT (802.11ax HE20 CH169 5845MHz - L). Rows include '4+3' (Horizontal/Fundamental) and 'Peak' (two spectral plots with site/condition details).

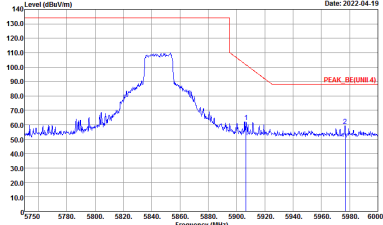
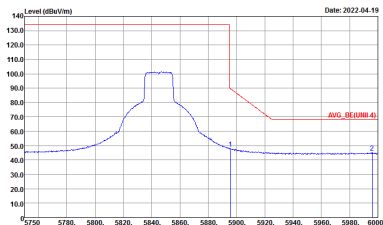

WIFI	UNII-4 5735~5895MHz Band Edge @ 3m	
ANT	802.11ax HE20 CH169 5845MHz - R	
4+3	Horizontal	Fundamental
Peak	 <p>Site : 03CH16-HY Condition : PEAK_BE(UNII 4) 3m 9120D_02114_210804 HORIZONTAL RBW:1000.000KHz VBW:3000.000KHz SWT:Auto</p>	Left blank
Avg.	 <p>Site : 03CH16-HY Condition : AVG_BE(UNII 4) 3m 9120D_02114_210804 HORIZONTAL RBW:1000.000KHz VBW:1000KHz SWT:Auto</p>	Left blank

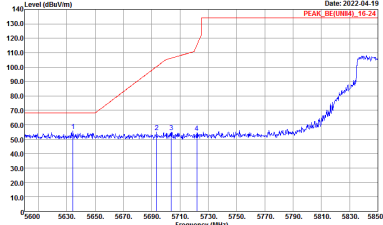
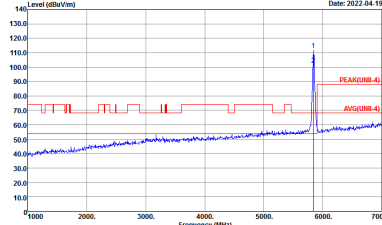

WIFI	UNII-4 5735~5895MHz Band Edge @ 3m	
ANT	802.11ax HE20 CH169 5845MHz - L	
4+3	Vertical	Fundamental
Peak	 <p>Site : 03CH16-HY Condition : PEAK_SE(UNII4)_16-24 3m 9120D_02114_210804 VERTICAL : RBW:1000.000KHz VBW:3000.000KHz SWT:Auto</p>	 <p>Site : 03CH16-HY Condition : PEAK(UNII-4) 3m 9120D_02114_210804 VERTICAL : RBW:1000.000KHz VBW:3000.000KHz SWT:Auto</p>



WIFI	UNII-4 5735~5895MHz Band Edge @ 3m	
ANT	802.11ax HE20 CH169 5845MHz - R	
4+3	Vertical	Fundamental
Peak	<p>Site : 03CH16-HY Condition : PEAK_BE(UNII 4) 3m 9120D_02114_210804 VERTICAL RBW:1000.000kHz VBW:3000.000kHz SWT:Auto</p>	Left blank
Avg.	<p>Site : 03CH16-HY Condition : AVG_BE(UNII 4) 3m 9120D_02114_210804 VERTICAL RBW:1000.000kHz VBW:1000.000kHz SWT:Auto</p>	Left blank



WIFI	UNII-4 5735~5895MHz Band Edge @ 3m	
ANT	802.11ax HE20 CH173 5865MHz - L	
4+3	Horizontal	Fundamental
Peak	<p>Site : 03CH16-HY Condition : PEAK_BE(UNII4)_16-24 3m 9120D_02114_210804 HORIZONTAL : RBW:1000.000KHz VBW:3000.000KHz SWT:Auto</p>	<p>Site : 03CH16-HY Condition : PEAK(UNII-4) 3m 9120D_02114_210804 HORIZONTAL : RBW:1000.000KHz VBW:3000.000KHz SWT:Auto</p>

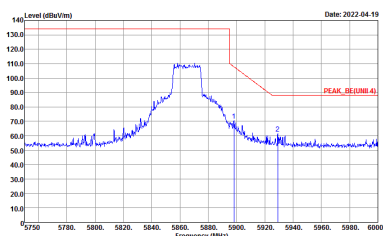
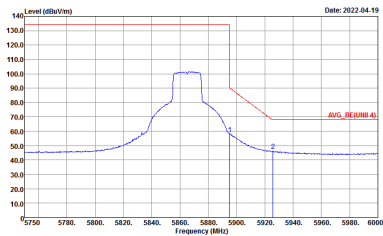

WIFI	UNII-4 5735~5895MHz Band Edge @ 3m	
ANT	802.11ax HE20 CH173 5865MHz - R	
4+3	Horizontal	Fundamental
<p>Peak</p>	 <p>Site : 03CH16-HY Condition : PEAK_BE(UNII 4) 3m 9120D_02114_210804 HORIZONTAL RBW:1000.000KHz VBW:3000.000KHz SWT:Auto</p>	<p>Left blank</p>
<p>Avg.</p>	 <p>Site : 03CH16-HY Condition : AVG_BE(UNII 4) 3m 9120D_02114_210804 HORIZONTAL RBW:1000.000KHz VBW:1000KHz SWT:Auto</p>	<p>Left blank</p>

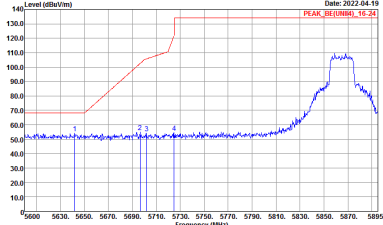
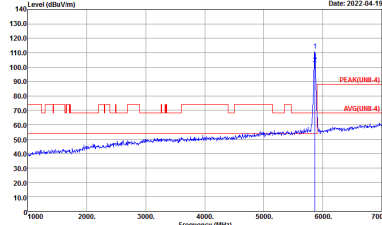

WIFI	UNII-4 5735~5895MHz Band Edge @ 3m	
ANT	802.11ax HE20 CH173 5865MHz - L	
4+3	Vertical	Fundamental
Peak	 <p>Site : 03CH16-HY Condition : PEAK_BE(UNII4)_16-24 3m 9120D_02114_210804 VERTICAL : RBW:1000.000KHz VBW:3000.000KHz SWT:Auto</p>	 <p>Site : 03CH16-HY Condition : PEAK(UNII-4) 3m 9120D_02114_210804 VERTICAL : RBW:1000.000KHz VBW:3000.000KHz SWT:Auto</p>

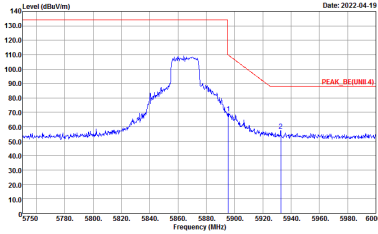
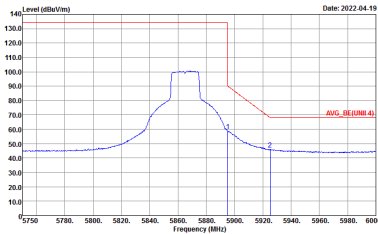

WIFI	UNII-4 5735~5895MHz Band Edge @ 3m	
ANT	802.11ax HE20 CH173 5865MHz - R	
4+3	Vertical	Fundamental
Peak	 <p>Site : 03CH16-HY Condition : PEAK_BE(UNII 4) 3m 9120D_02114_210804 VERTICAL : RBW:1000.000kHz VBW:3000.000kHz SWT:Auto</p>	Left blank
Avg.	 <p>Site : 03CH16-HY Condition : AVG_BE(UNII 4) 3m 9120D_02114_210804 VERTICAL : RBW:1000.000kHz VBW:1000.000kHz SWT:Auto</p>	Left blank



WIFI	UNII-4 5735~5895MHz Band Edge @ 3m	
ANT	802.11ax HE20 CH177 5885MHz - L	
4+3	Horizontal	Fundamental
Peak	<p>Site : 03CH16-HY Condition : PEAK_SE(UNII-4)_16-24 3m 91200_02114_210804 HORIZONTAL : RBW:1000.000KHz VBW:3000.000KHz SWT:Auto</p>	<p>Site : 03CH16-HY Condition : PEAK_UNII-4) 3m 91200_02114_210804 HORIZONTAL : RBW:1000.000KHz VBW:3000.000KHz SWT:Auto</p>



WIFI	UNII-4 5735~5895MHz Band Edge @ 3m	
ANT	802.11ax HE20 CH177 5885MHz - R	
4+3	Horizontal	Fundamental
<p>Peak</p>		<p>Left blank</p>
<p>Avg.</p>		<p>Left blank</p>

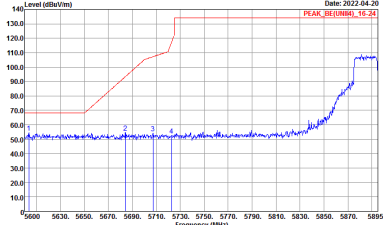
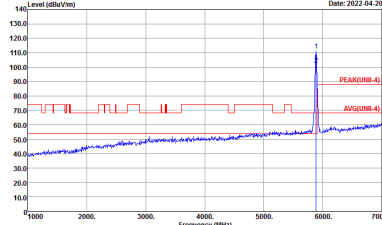

WIFI	UNII-4 5735~5895MHz Band Edge @ 3m	
ANT	802.11ax HE20 CH177 5885MHz - L	
4+3	Vertical	Fundamental
Peak	 <p>Site : 03CH16-HY Condition : PEAK_BE(UNII4)_16-24 3m 9120D_02114_210804 VERTICAL : RBW:1000.000KHz VBW:3000.000KHz SWT:Auto</p>	 <p>Site : 03CH16-HY Condition : PEAK(UNII-4) 3m 9120D_02114_210804 VERTICAL : RBW:1000.000KHz VBW:3000.000KHz SWT:Auto</p>

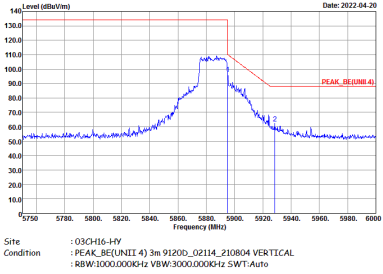
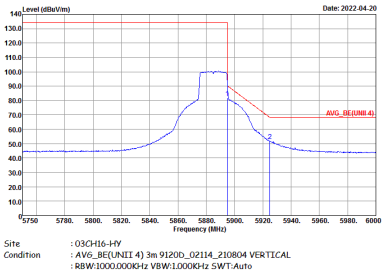

WIFI	UNII-4 5735~5895MHz Band Edge @ 3m	
ANT	802.11ax HE20 CH177 5885MHz - R	
4+3	Vertical	Fundamental
<p>Peak</p>		<p>Left blank</p>
<p>Avg.</p>		<p>Left blank</p>



UNII-4 - 5735~5895MHz
WIFI 802.11ax HE40 (Band Edge @ 3m)

WIFI	UNII-4 5735~5895MHz Band Edge @ 3m	
ANT	802.11ax HE40 CH167 5835MHz - L	
4+3	Horizontal	Fundamental
Peak	<p>Site : 03CH16-HY Condition : PEAK_BE(UNII4)_16-24 3m 91200_02114_210804 HORIZONTAL REW:3000.000kHz VBW:3000.000kHz SWT:Auto</p>	<p>Site : 03CH16-HY Condition : PEAK(UNII-4) 3m 91200_02114_210804 HORIZONTAL REW:3000.000kHz VBW:3000.000kHz SWT:Auto</p>

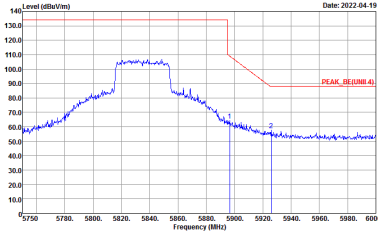
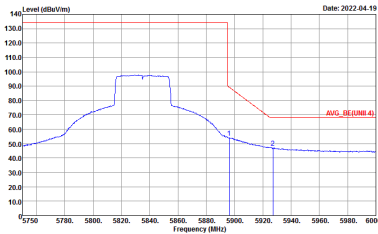

WIFI	UNII-4 5735~5895MHz Band Edge @ 3m	
ANT	802.11ax HE40 CH167 5835MHz - R	
4+3	Horizontal	Fundamental
<p>Peak</p>	 <p>Site : 03CH16-HY Condition : PEAK_BE(UNII 4) 3m 9120D_02114_210804 HORIZONTAL RBW:1000.000KHz VBW:3000.000KHz SWT:Auto</p>	<p>Left blank</p>
<p>Avg.</p>	 <p>Site : 03CH16-HY Condition : AVG_BE(UNII 4) 3m 9120D_02114_210804 HORIZONTAL RBW:1000.000KHz VBW:1000KHz SWT:Auto</p>	<p>Left blank</p>



WIFI	UNII-4 5735~5895MHz Band Edge @ 3m	
ANT	802.11ax HE40 CH167 5835MHz - L	
4+3	Vertical	Fundamental
Peak	<p>Site : 03CH16-HY Condition : PEAK_BE(UNII4)_16-24 3m 9120D_02114_210804 VERTICAL : RBW:1000.000KHz VBW:3000.000KHz SWT:Auto</p>	<p>Site : 03CH16-HY Condition : PEAK(UNII-4) 3m 9120D_02114_210804 VERTICAL : RBW:1000.000KHz VBW:3000.000KHz SWT:Auto</p>



WIFI	UNII-4 5735~5895MHz Band Edge @ 3m	
ANT	802.11ax HE40 CH167 5835MHz - R	
4+3	Vertical	Fundamental
<p>Peak</p>	<p>Site : 03CH16-HY Condition : PEAK_BE(UNII 4) 3m 9120D_02114_210804 VERTICAL : RBW:1000.000KHz VBW:3000.000KHz SWT:Auto</p>	<p>Left blank</p>
<p>Avg.</p>	<p>Site : 03CH16-HY Condition : AVG_BE(UNII 4) 3m 9120D_02114_210804 VERTICAL : RBW:1000.000KHz VBW:1000KHz SWT:Auto</p>	<p>Left blank</p>



WIFI	UNII-4 5735~5895MHz Band Edge @ 3m	
ANT	802.11ax HE40 CH175 5875MHz - L	
4+3	Horizontal	Fundamental
Peak	<p>Site : 03CH16-HY Condition : PEAK_BE(UNII4)_16-24 3m 9120D_02114_210804 HORIZONTAL : RBW:1000.000KHz VBW:3000.000KHz SWT:Auto</p>	<p>Site : 03CH16-HY Condition : PEAK(UNII-4) 3m 9120D_02114_210804 HORIZONTAL : RBW:1000.000KHz VBW:3000.000KHz SWT:Auto</p>

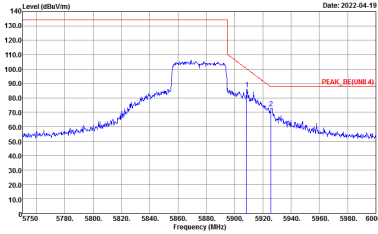
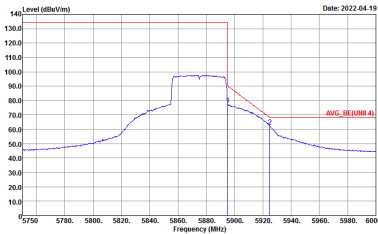

WIFI	UNII-4 5735~5895MHz Band Edge @ 3m	
ANT	802.11ax HE40 CH175 5875MHz - R	
4+3	Horizontal	Fundamental
<p>Peak</p>	 <p>Site : 03CH16-HY Condition : PEAK_BE(UNII 4) 3m 9120D_02114_210804 HORIZONTAL : RBW:1000.000KHz VBW:3000.000KHz SWT:Auto</p>	<p>Left blank</p>
<p>Avg.</p>	 <p>Site : 03CH16-HY Condition : AVG_BE(UNII 4) 3m 9120D_02114_210804 HORIZONTAL : RBW:1000.000KHz VBW:1000KHz SWT:Auto</p>	<p>Left blank</p>



WIFI	UNII-4 5735~5895MHz Band Edge @ 3m	
ANT	802.11ax HE40 CH175 5875MHz - L	
4+3	Vertical	Fundamental
Peak	<p>Site : 03CH16-HY Condition : PEAK_SE(UNII4)_16-24 3m 9120D_02114_210804 VERTICAL : RBW:1000.000KHz VBW:3000.000KHz SWT:Auto</p>	<p>Site : 03CH16-HY Condition : PEAK(UNII-4) 3m 9120D_02114_210804 VERTICAL : RBW:1000.000KHz VBW:3000.000KHz SWT:Auto</p>

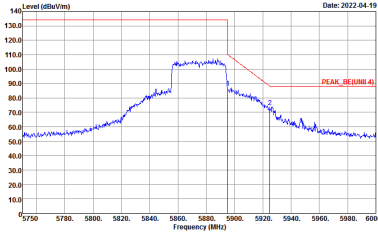
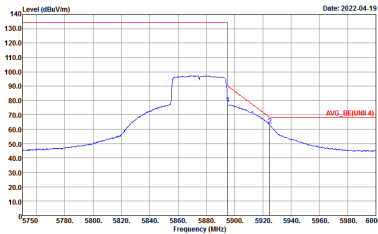

WIFI	UNII-4 5735~5895MHz Band Edge @ 3m	
ANT	802.11ax HE40 CH175 5875MHz - R	
4+3	Vertical	Fundamental
<p>Peak</p>	 <p>Site : 03CH16-HY Condition : PEAK_BE(UNII 4) 3m 9120D_02114_210804 VERTICAL : RBW:1000.000KHz VBW:3000.000KHz SWT:Auto</p>	<p>Left blank</p>
<p>Avg.</p>	 <p>Site : 03CH16-HY Condition : AVG_BE(UNII 4) 3m 9120D_02114_210804 VERTICAL : RBW:1000.000KHz VBW:1000KHz SWT:Auto</p>	<p>Left blank</p>



UNII-4 - 5735~5895MHz
WIFI 802.11ax HE80 (Band Edge @ 3m)

WIFI	UNII-4 5735~5895MHz Band Edge @ 3m	
ANT	802.11ax HE80 CH171 5855MHz - L	
4+3	Horizontal	Fundamental
Peak	<p>Site : 03CH16-HY Condition : PEAK_BE(UNII4)_16-24 3m 91200_021H_210804 HORIZONTAL REW:3000.000KHz VBW:3000.000KHz SWT:Auto</p>	<p>Site : 03CH16-HY Condition : PEAK(UNII-4) 3m 91200_021H_210804 HORIZONTAL REW:3000.000KHz VBW:3000.000KHz SWT:Auto</p>



WIFI	UNII-4 5735~5895MHz Band Edge @ 3m	
ANT	802.11ax HE80 CH171 5855MHz - R	
4+3	Horizontal	Fundamental
<p>Peak</p>	<p>Site : 03CH16-HY Condition : PEAK_BE(UNII 4) 3m 9120D_02114_210804 HORIZONTAL RBW:1000.000kHz VBW:3000.000kHz SWT:Auto</p>	<p>Left blank</p>
<p>Avg.</p>	<p>Site : 03CH16-HY Condition : AVG_BE(UNII 4) 3m 9120D_02114_210804 HORIZONTAL RBW:1000.000kHz VBW:3.000kHz SWT:Auto</p>	<p>Left blank</p>



WIFI	UNII-4 5735~5895MHz Band Edge @ 3m	
ANT	802.11ax HE80 CH171 5855MHz - L	
4+3	Vertical	Fundamental
Peak	<p>Site : 03CH16-HY Condition : PEAK_BE(UNII4)_16-24 3m 9120D_02114_210804 VERTICAL : RBW:1000.000KHz VBW:3000.000KHz SWT:Auto</p>	<p>Site : 03CH16-HY Condition : PEAK(UNII-4) 3m 9120D_02114_210804 VERTICAL : RBW:1000.000KHz VBW:3000.000KHz SWT:Auto</p>



WIFI	UNII-4 5735~5895MHz Band Edge @ 3m	
ANT	802.11ax HE80 CH171 5855MHz - R	
4+3	Vertical	Fundamental
<p>Peak</p>	<p>Site : 03CH16-HY Condition : PEAK_BE(UNII 4) 3m 9120D_02114_210804 VERTICAL : RBW:1000.000kHz VBW:3000.000kHz SWT:Auto</p>	<p>Left blank</p>
<p>Avg.</p>	<p>Site : 03CH16-HY Condition : AVG_BE(UNII 4) 3m 9120D_02114_210804 VERTICAL : RBW:1000.000kHz VBW:3.000kHz SWT:Auto</p>	<p>Left blank</p>



UNII-4 - 5735~5895MHz
WIFI 802.11ax HE160 Full (Band Edge @ 3m)

Table with 2 columns: WIFI (UNII-4 5735~5895MHz Band Edge @ 3m), ANT (802.11ax HE160 Full CH163 5815MHz - L). Row 4+3 contains two plots: Horizontal and Fundamental. The Horizontal plot shows Level (dBuV/m) vs Frequency (MHz) with a peak at 5735 MHz. The Fundamental plot shows Level (dBuV/m) vs Frequency (MHz) with a peak at 5815 MHz. Both plots include site and condition details.



WIFI	UNII-4 5735~5895MHz Band Edge @ 3m	
ANT	802.11ax HE160 Full CH163 5815MHz - R	
4+3	Horizontal	Fundamental
Peak	<p>Site : 03CH16-HY Condition : PEAK_BE(UNII 4) 3m 9120D_02114_210804 HORIZONTAL : RBW:1000.000KHz VBW:3000.000KHz SWT:Auto</p>	Left blank
Avg.	<p>Site : 03CH16-HY Condition : AVG_BE(UNII 4) 3m 9120D_02114_210804 HORIZONTAL : RBW:1000.000KHz VBW:3.000KHz SWT:Auto</p>	Left blank



WIFI	UNII-4 5735~5895MHz Band Edge @ 3m	
ANT	802.11ax HE160 Full CH163 5815MHz - L	
4+3	Vertical	Fundamental
Peak	<p>Site : 03CH16-HY Condition : PEAK_BE(UNII-4)_16-24 3m 9120D_02114_210804 VERTICAL : RBW:1000.000KHz VBW:3000.000KHz SWT:Auto</p>	<p>Site : 03CH16-HY Condition : PEAK(UNII-4) 3m 9120D_02114_210804 VERTICAL : RBW:1000.000KHz VBW:3000.000KHz SWT:Auto</p>

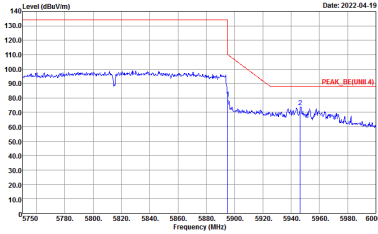
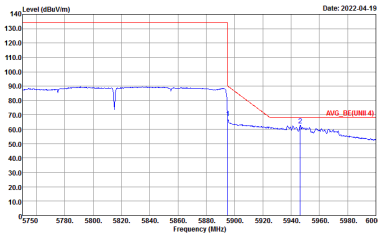

WIFI	UNII-4 5735~5895MHz Band Edge @ 3m	
ANT	802.11ax HE160 Full CH163 5815MHz - R	
4+3	Vertical	Fundamental
Peak	 <p>Site : 03CH16-HY Condition : PEAK_BE(UNII 4) 3m 9120D_02114_210804 VERTICAL : RBW:1000.000KHz VBW:3000.000KHz SWT:Auto</p>	Left blank
Avg.	 <p>Site : 03CH16-HY Condition : AVG_BE(UNII 4) 3m 9120D_02114_210804 VERTICAL : RBW:1000.000KHz VBW:3.000KHz SWT:Auto</p>	Left blank



UNII-4 - 5735~5895MHz

WIFI 802.11a (Harmonic @ 3m)

WIFI	UNII-4 5735~5895MHz Harmonic @ 3m	
ANT	802.11a CH169 5845MHz	
4+3	Horizontal	Vertical
Peak Avg.	<p>Site : 03CH16-HY Condition : PEAK(UNII-4) 3m 9120D_02114_Z10804 HORIZONTAL</p>	<p>Site : 03CH16-HY Condition : PEAK(UNII-4) 3m 9120D_02114_Z10804 VERTICAL</p>



WIFI	UNII-4 5735~5895MHz Harmonic @ 3m	
ANT	802.11a CH173 5865MHz	
4+3	Horizontal	Vertical
Peak Avg.	<p>Site : 03CH16-HY Condition : PEAQ(UNII-4) 3m 9120D_02114_210804 HORIZONTAL</p>	<p>Site : 03CH16-HY Condition : PEAQ(UNII-4) 3m 9120D_02114_210804 VERTICAL</p>



WIFI	UNII-4 5735~5895MHz Harmonic @ 3m	
ANT	802.11a CH177 5885MHz	
4+3	Horizontal	Vertical
Peak Avg.	<p>Site : 03CH16-HY Condition : PEAK(UNII-4) 3m 91200_02114_210804 HORIZONTAL</p>	<p>Site : 03CH16-HY Condition : PEAK(UNII-4) 3m 91200_02114_210804 VERTICAL</p>



UNII-4 - 5735~5895MHz
WIFI 802.11ax HE20 (Harmonic @ 3m)

WIFI	UNII-4 5735~5895MHz Harmonic @ 3m	
ANT	802.11ax HE20 CH169 5845MHz	
4+3	Horizontal	Vertical
Peak Avg.	<p>Site : 03CH16-HY Condition : PEAK(UNII-4) 3m 9120D_02114_210804 HORIZONTAL</p>	<p>Site : 03CH16-HY Condition : PEAK(UNII-4) 3m 9120D_02114_210804 VERTICAL</p>



WIFI	UNII-4 5735~5895MHz Harmonic @ 3m	
ANT	802.11ax HE20 CH173 5865MHz	
4+3	Horizontal	Vertical
Peak Avg.	<p>Site : 03CH16-HY Condition : PEAK(UNII-4) 3m 91200_02114_210804 HORIZONTAL</p>	<p>Site : 03CH16-HY Condition : PEAK(UNII-4) 3m 91200_02114_210804 VERTICAL</p>



WIFI	UNII-4 5735~5895MHz Harmonic @ 3m	
ANT	802.11ax HE20 CH177 5885MHz	
4+3	Horizontal	Vertical
Peak Avg.	<p>Site : 03CH16-HY Condition : PEAK(UNII-4) 3m 91200_02114_210804 HORIZONTAL</p>	<p>Site : 03CH16-HY Condition : PEAK(UNII-4) 3m 91200_02114_210804 VERTICAL</p>



UNII-4 - 5735~5895MHz
 WIFI 802.11ax HE40 (Harmonic @ 3m)

WIFI	UNII-4 5735~5895MHz Harmonic @ 3m	
ANT	802.11ax HE40 CH167 5835MHz	
4+3	Horizontal	Vertical
Peak Avg.	<p>Site : 03CH16-HY Condition : PEAK(UINII-4) 3m 9120D_02114_210804 HORIZONTAL</p>	<p>Site : 03CH16-HY Condition : PEAK(UINII-4) 3m 9120D_02114_210804 VERTICAL</p>



WIFI	UNII-4 5735~5895MHz Harmonic @ 3m	
ANT	802.11ax HE40 CH175 5875MHz	
4+3	Horizontal	Vertical
Peak Avg.	<p>Site : 03CH16-HY Condition : PEAK(UNII-4) 3m 91200_02114_210804 HORIZONTAL</p>	<p>Site : 03CH16-HY Condition : PEAK(UNII-4) 3m 91200_02114_210804 VERTICAL</p>



UNII-4 - 5735~5895MHz
WIFI 802.11ax HE80 (Harmonic @ 3m)

WIFI	UNII-4 5735~5895MHz Harmonic @ 3m	
ANT	802.11ax HE80 CH171 5855MHz	
4+3	Horizontal	Vertical
Peak Avg.	<p>Site : 03CH16-HY Condition : PEAK(UNII-4) 3m 9120D_02114_210804 HORIZONTAL</p>	<p>Site : 03CH16-HY Condition : PEAK(UNII-4) 3m 9120D_02114_210804 VERTICAL</p>

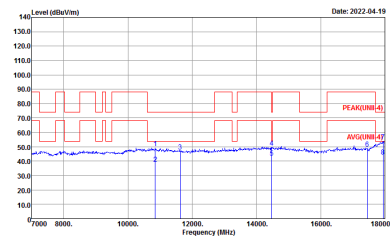
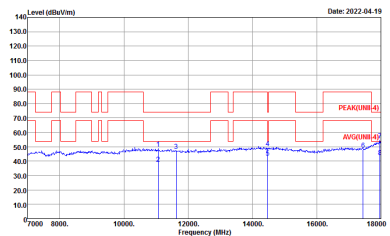

UNII-4 - 5735~5895MHz
WIFI 802.11ax HE160 Full (Harmonic @ 3m)

WIFI	UNII-4 5735~5895MHz Harmonic @ 3m	
ANT	802.11ax HE160 Full CH163 5815MHz	
4+3	Horizontal	Vertical
Peak		
Avg.		



Emission above 18GHz
5GHz WIFI 802.11ax HE160 Full (SHF @ 1m)

WIFI	5GHz WIFI	
ANT	802.11ax HE160 Full SHF	
4+3	Horizontal	Vertical
Peak Avg.	<p>Site : 03CH16-HY Condition : PEAK(UNII) 1m SHF ANT_9170_00993 HORIZONTAL</p>	<p>Site : 03CH16-HY Condition : PEAK(UNII) 1m SHF ANT_9170_00993 VERTICAL</p>



Emission below 1GHz

5GHz WIFI 802.11ax HE160 Full (LF @ 3m)

WIFI	5GHz WIFI	
ANT	8802.11ax HE160 Full LF	
4+3	Horizontal	Vertical
QP / Peak		



Appendix E. Duty Cycle Plots

Antenna	Band	Duty Cycle(%)	T(us)	1/T(kHz)	VBW Setting
4+3	802.11a	93.77	1430	0.70	1kHz
4+3	5GHz 802.11ax HE20 Full RU	96.09	2408	0.42	1kHz
4+3	5GHz 802.11ax HE40 Full RU	92.51	1235	0.81	1kHz
4+3	5GHz 802.11ax HE80 Full RU	85.95	624	1.60	3kHz
4+3	5GHz 802.11ax HE160 Full RU	85.07	570	1.75	3kHz

MIMO <Ant. 4+3>

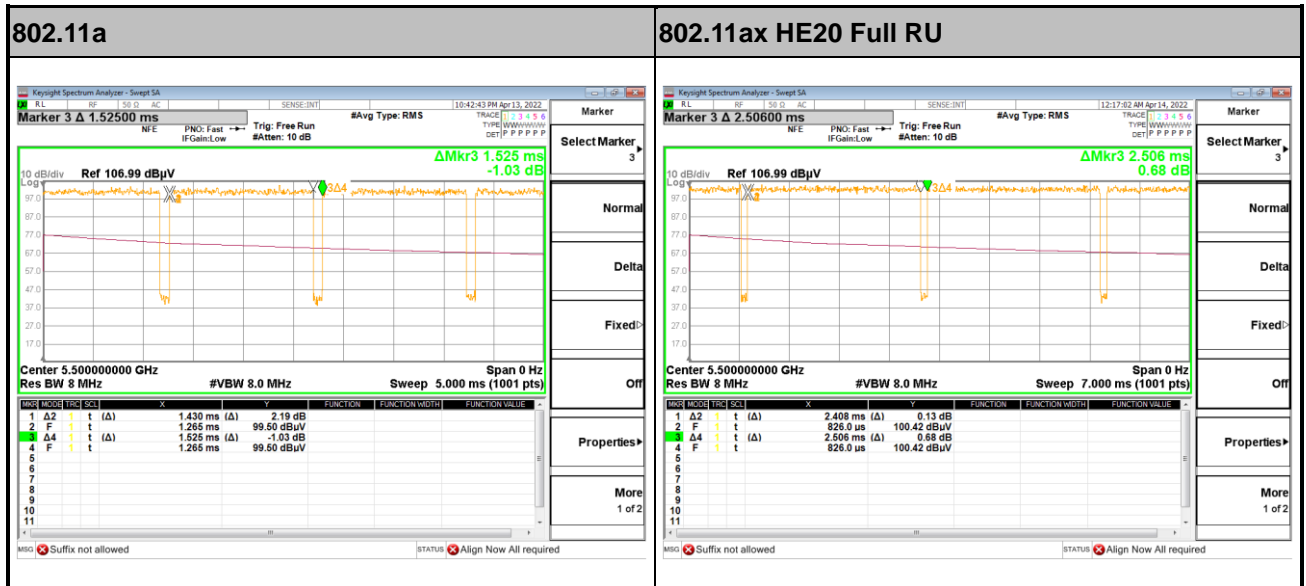

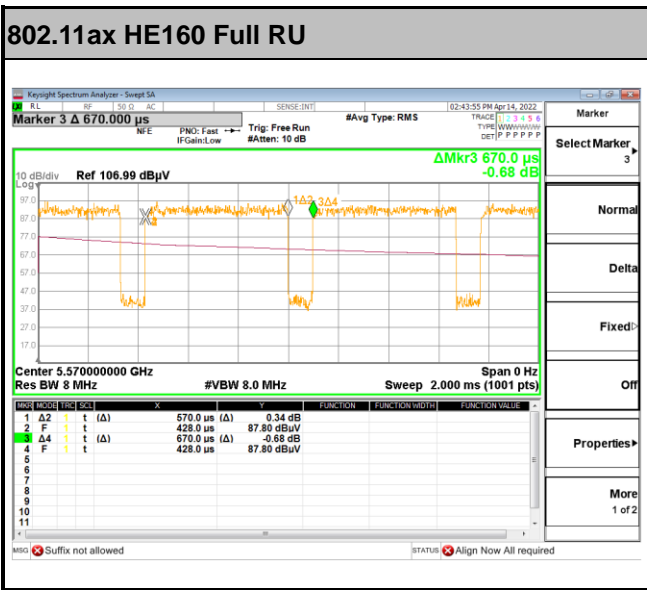
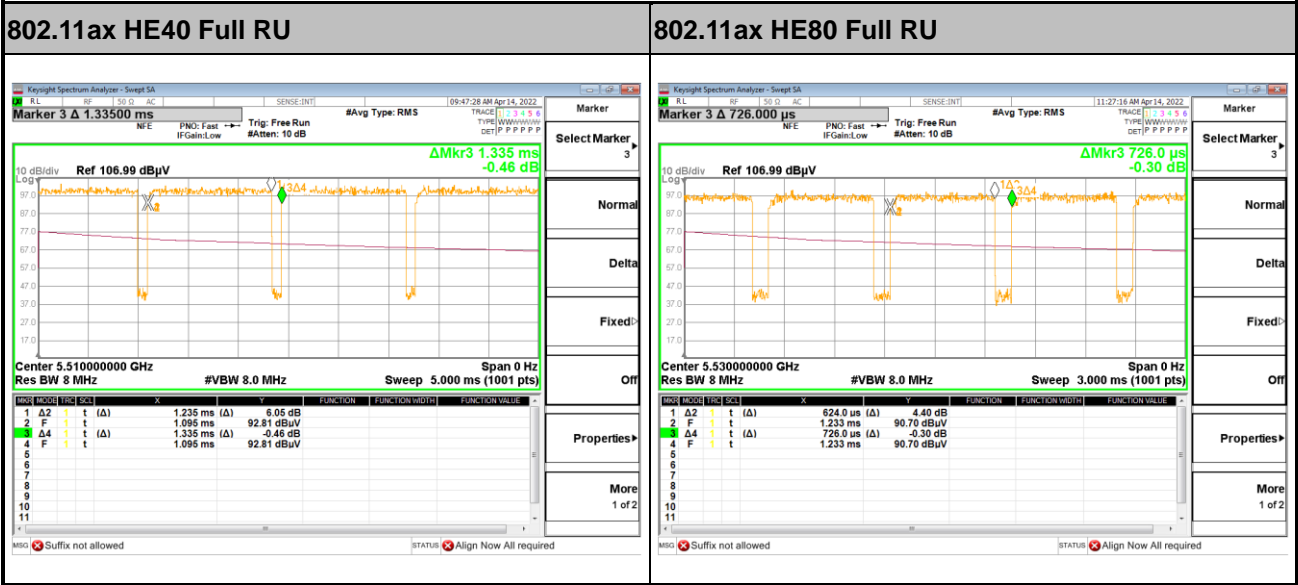

—THE END—