



# FCC RADIO TEST REPORT

**FCC ID** : A4RGKWS6  
**Equipment** : Phone  
**Model Name** : GKWS6  
**Applicant** : Google LLC  
1600 Amphitheatre Parkway,  
Mountain View, California, 94043 USA  
**Standard** : FCC Part 15 Subpart C §15.225

The product was received on Feb. 06, 2023 and testing was performed from Apr. 10, 2023 to May 17, 2023. We, Sporton International Inc. EMC & Wireless Communications Laboratory, would like to declare that the tested sample has been evaluated in accordance with the test procedures and has been in compliance with the applicable technical standards.

The test results in this report apply exclusively to the tested model / sample. Without written approval from Sporton International Inc. EMC & Wireless Communications Laboratory, the test report shall not be reproduced except in full.

Approved by: Louis Wu

**Sporton International Inc. EMC & Wireless Communications Laboratory**  
No. 52, Huaya 1st Rd., Guishan Dist., Taoyuan City 333, Taiwan (R.O.C.)



## Table of Contents

<b>History of this test report.....</b>	<b>3</b>
<b>Summary of Test Result.....</b>	<b>4</b>
<b>1. General Description .....</b>	<b>5</b>
1.1 Product Feature of Equipment Under Test .....	5
1.2 Product Specification of Equipment Under Test .....	5
1.3 Modification of EUT .....	5
1.4 Testing Location .....	6
1.5 Applicable Standards.....	6
<b>2. Test Configuration of Equipment Under Test.....</b>	<b>7</b>
2.1 Descriptions of Test Mode .....	7
2.2 Connection Diagram of Test System .....	8
2.3 Table for Supporting Units .....	9
2.4 EUT Operation Test Setup .....	9
<b>3. Test Results .....</b>	<b>10</b>
3.1 AC Power Line Conducted Emissions Measurement .....	10
3.2 20dB and 99% OBW Spectrum Bandwidth Measurement.....	12
3.3 Frequency Stability Measurement .....	13
3.4 Field Strength of Fundamental Emissions and Mask Measurement.....	14
3.5 Radiated Emissions Measurement .....	16
3.6 Antenna Requirements.....	19
<b>4. List of Measuring Equipment .....</b>	<b>20</b>
<b>5. Measurement Uncertainty.....</b>	<b>21</b>
<b>Appendix A. Test Results of Conducted Emission Test</b>	
<b>Appendix B. Test Results of Near Field Test Items</b>	
B1. Test Result of 20dB Spectrum Bandwidth	
B2. Test Result of Frequency Stability	
<b>Appendix C. Test Results of Radiated Test Items</b>	
C1. Test Result of Field Strength of Fundamental Emissions	
C2. Results of Radiated Emissions (9 kHz~30MHz)	
C3. Results of Radiated Emissions (30MHz~1GHz)	
<b>Appendix D. Setup Photographs</b>	



### History of this test report

Report No.	Version	Description	Issue Date
FR2D0208-01D	01	Initial issue of report	Jun. 29, 2023



## Summary of Test Result

Report Clause	Ref Std. Clause	Test Items	Result (PASS/FAIL)	Remark
3.1	15.207	AC Power Line Conducted Emissions	Pass	15.45 dB under the limit at 27.12MHz
3.2	15.215(c)	20dB Spectrum Bandwidth	Pass	-
	2.1049	99% OBW Spectrum Bandwidth	Reporting only	-
3.3	15.225(e)	Frequency Stability	Pass	-
3.4	15.225(a)(b)(c)	Field Strength of Fundamental Emissions	Pass	Max level 26.97 dB $\mu$ V/m at 13.56 MHz
3.5	15.225(d) 15.209	Radiated Spurious Emissions	Pass	3.03 dB under the limit at 40.68MHz
3.6	15.203	Antenna Requirements	Pass	-

**Conformity Assessment Condition:**

1. The test results (PASS/FAIL) with all measurement uncertainty excluded are presented against the regulation limits or in accordance with the requirements stipulated by the applicant/manufacturer who shall bear all the risks of non-compliance that may potentially occur if measurement uncertainty is taken into account.
2. The measurement uncertainty please refer to each test result in the section "Measurement Uncertainty".

**Disclaimer:**

The product specifications of the EUT presented in the test report that may affect the test assessments are declared by the manufacturer who shall take full responsibility for the authenticity.

**Reviewed by: William Chen****Report Producer: Lucy Wu**



# 1. General Description

## 1.1 Product Feature of Equipment Under Test

Product Feature	
Equipment	Phone
Model Name	GKWS6
FCC ID	A4RGKWS6
EUT supports Radios application	GSM/EGPRS/WCDMA/HSPA/LTE/5G NR/NFC/GNSS/WPT WLAN 11b/g/n HT20 WLAN 11a/n HT20/HT40 WLAN 11ac VHT20/VHT40/VHT80/VHT160 WLAN 11ax HE20/HE40/HE80/HE160 WLAN 11be EHT20/EHT40/EHT80/EHT160 Bluetooth BR/EDR/LE/HR

**Remark:** The above EUT's information was declared by manufacturer.

EUT Information List	
S/N	Performed Test Item
31131FDJH00032	Conducted Emission
33141FDJH0007L	Radiated Spurious Emission
	RF Near Field

## 1.2 Product Specification of Equipment Under Test

Product Specification is subject to this standard	
Tx/Rx Frequency	13.553 ~ 13.567MHz
Channel Number	1
20dBW	2.66 KHz
99%OBW	2.24 KHz
Antenna Type	Loop Antenna
Type of Modulation	ASK

**Remark:** The EUT's information above is declared by manufacturer. Please refer to Disclaimer in report summary.

## 1.3 Modification of EUT

No modifications made to the EUT during the testing.



### 1.4 Testing Location

<b>Test Site</b>	Sporton International Inc. EMC & Wireless Communications Laboratory		
<b>Test Site Location</b>	No.52, Huaya 1st Rd., Guishan Dist., Taoyuan City 333, Taiwan (R.O.C.) TEL: +886-3-327-3456 FAX: +886-3-328-4978		
<b>Test Site No.</b>	<b>Sporton Site No.</b>		
	TH03-HY	CO05-HY	03CH07-HY
<b>Test Engineer</b>	Eric Wu	Calvin Wang	Ken Wu
<b>Temperature</b>	22.2~24.2°C	23~26°C	20.1~24.5°C
<b>Relative Humidity</b>	41.7~43.7%	45~55%	53.5~58.1%

**Note:** The test site complies with ANSI C63.4 2014 requirement.

FCC designation No.: TW1190

### 1.5 Applicable Standards

According to the specifications declared by the manufacturer, the EUT must comply with the requirements of the following standards:

- ♦ FCC Part 15 Subpart C §15.225
- ♦ FCC KDB 414788 D01 Radiated Test Site v01r01
- ♦ ANSI C63.10-2013

**Remark:**

1. All the test items were validated and recorded in accordance with the standards without any modification during the testing.
2. The TAF code is not including all the FCC KDB listed without accreditation.



## 2. Test Configuration of Equipment Under Test

### 2.1 Descriptions of Test Mode

Investigation has been done on all the possible configurations.

The following table is a list of the test modes shown in this test report.

Test Items	
AC Power Line Conducted Emissions	Field Strength of Fundamental Emissions
20dB Spectrum Bandwidth	Frequency Stability
Radiated Emissions 9kHz~30MHz	Radiated Emissions 30MHz~1GHz

The EUT pre-scanned in reader mode with NFC tag (four NFC type A, B, F, V) and without reading tag. Based on the highest field strength of fundamental and spurious emissions, the worst case type (type B) was recorded in this report.

The measured emission level of the EUT was maximized by rotating the EUT on a turntable, adjusting the orientation of the EUT and EUT antenna in three orthogonal axis (X: flat, Y: portrait, Z: landscape), Accessory (Adapter or Earphone) and three receiving antenna orientations (parallel, perpendicular, and ground-parallel) for Loop Antenna, and adjusting the measurement antenna orientation, following C63.10 exploratory test procedures and only the worst case emissions were reported in this report.

Test Cases	
<b>AC Conducted Emission</b>	Mode 1 : GSM850 Idle + WLAN Idle + Bluetooth Idle + NFC Read + USB Cable 1 (Charging from AC Adapter 1)
<b>Remark:</b> For Radiated Test Cases, the tests were performed with Adapter 2 and USB Cable 1.	

## 2.2 Connection Diagram of Test System

<AC Conducted Emission Mode>

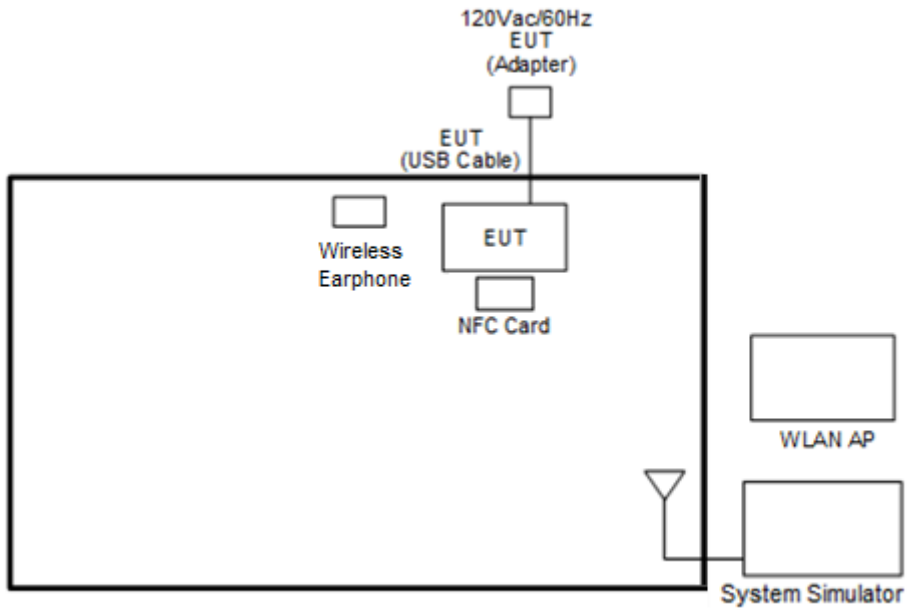

<Radiated Spurious Emission with Adapter Mode>

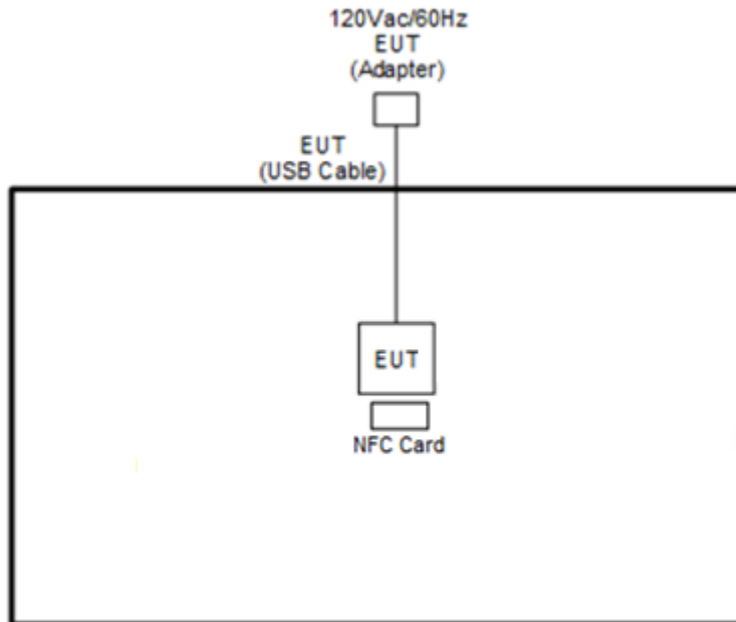



**<Radiated Spurious Emission with Earphone Mode>**

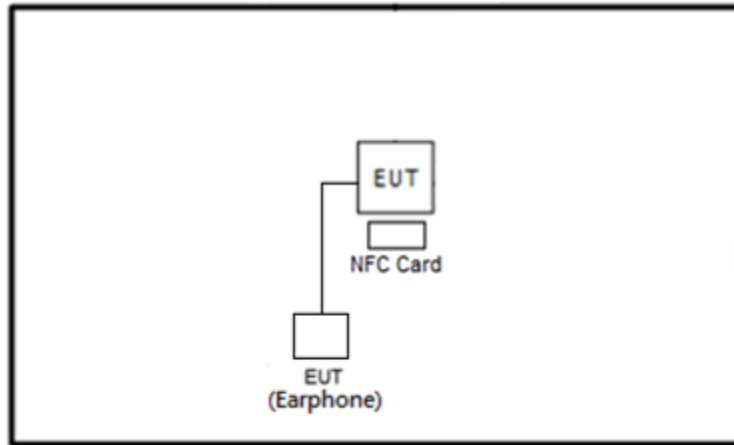

**2.3 Table for Supporting Units**

Item	Equipment	Brand Name	Model Name	FCC ID	Data Cable	Power Cord
1.	System Simulator	Anritsu	MT8820C	N/A	N/A	Unshielded, 1.8m
2.	Wireless Earphone	Google	G1007/G1008	A4RG1007/ A4RG1008	N/A	N/A
3.	WLAN AP	ASUS	RT-AC66U	MSQ-RTAC66U	N/A	Unshielded, 1.8m
4.	NFC Card	N/A	N/A	N/A	N/A	N/A

**2.4 EUT Operation Test Setup**

The EUT is programmed to be in continuously transmitting mode.

The ancillary equipment, NFC card, is used to make the EUT (NFC) continuously transmitting signal (Power Level: Default) at 13.56MHz.



### 3. Test Results

#### 3.1 AC Power Line Conducted Emissions Measurement

##### 3.1.1 Limit of AC Conducted Emission

For equipment that is designed to be connected to the public utility (AC) power line, the radio frequency voltage that is conducted back onto the AC power line on any frequency or frequencies within the band 150 kHz to 30 MHz shall not exceed the limits in the following table.

Frequency of Emission (MHz)	Conducted Limit (dB $\mu$ V)	
	Quasi-Peak	Average
0.15-0.5	66 to 56*	56 to 46*
0.5-5	56	46
5-30	60	50

\*Decreases with the logarithm of the frequency.

For terminal test result, the testing follows FCC KDB 174176.

##### 3.1.2 Measuring Instruments

Please refer to the measuring equipment list in this test report.

##### 3.1.3 Test Procedures

1. The EUT is placed 0.4 meter away from the conducting wall of the shielding room, and is kept at least 80 centimeters from any other grounded conducting surface.
2. Connect EUT to the power mains through a line impedance stabilization network (LISN).
3. All the support units are connecting to the other LISN.
4. The LISN provides 50 ohm coupling impedance for the measuring instrument.
5. The FCC states that a 50 ohm, 50 microhenry LISN shall be used.
6. Both Line and Neutral shall be tested in order to find out the maximum conducted emission.
7. The frequency range from 150 kHz to 30 MHz is scanned.
8. Set the test-receiver system to Peak Detect Function and specified bandwidth (IF Bandwidth = 9 kHz) with Maximum Hold Mode. Then measurement is also conducted by Average Detector and Quasi-Peak Detector Function respectively.

### 3.1.4 Test setup

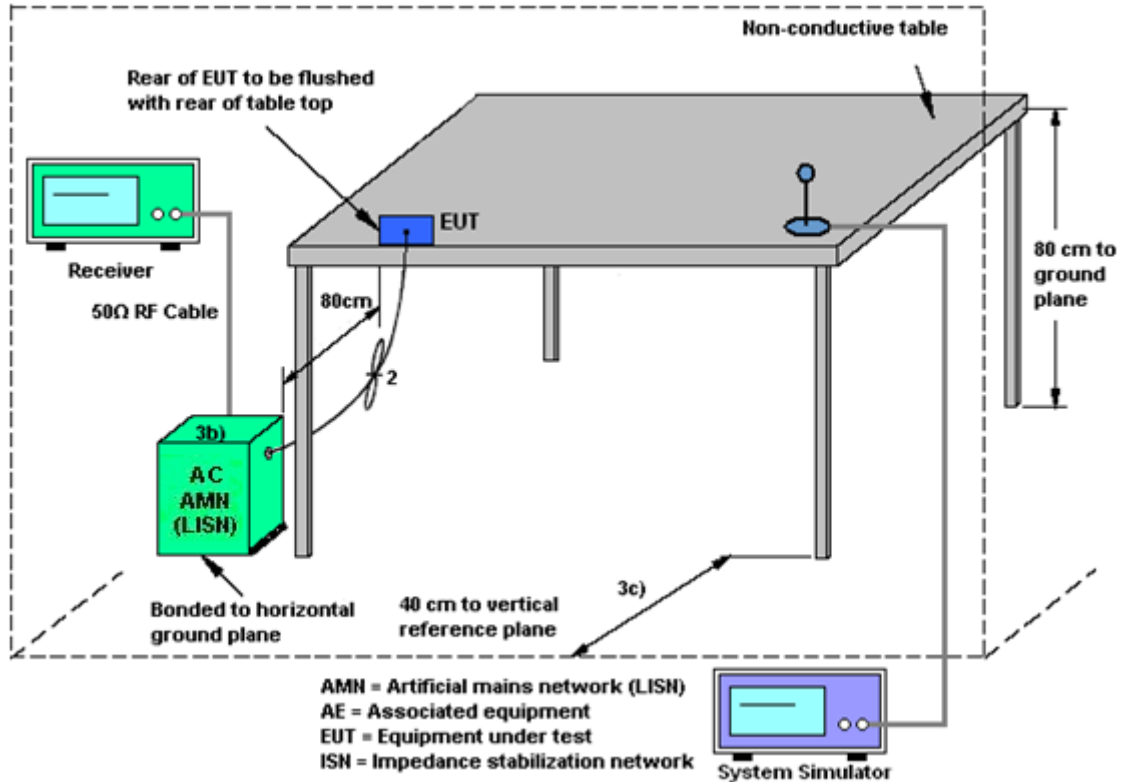

### 3.1.5 Test Result of AC Conducted Emission

Please refer to Appendix A.

**Note:**

(1) with antenna

Remark: 13.560MHz is the NFC RF fundamental signal.

(2) with dummy load

Remark: Only the fundamental NFC signal needs to be retested per C63.4.

## 3.2 20dB and 99% OBW Spectrum Bandwidth Measurement

### 3.2.1 Limit

Intentional radiators must be designed to ensure that the 20 dB and 99% emission bandwidth in the specific band 13.553~13.567 MHz.

### 3.2.2 Measuring Instruments

Please refer to the measuring equipment list in this test report.

### 3.2.3 Test Procedures

1. The spectrum analyzer connected via a receive antenna placed near the EUT in peak Max Hold Mode.
2. The resolution bandwidth of 1 kHz and the video bandwidth of 3 kHz were used.
3. Measured the spectrum width with power higher than 20 dB below carrier.
4. Measured the 99% OBW.

### 3.2.4 Test Setup



### 3.2.5 Test Result of Near Field Test Items

Please refer to Appendix B.

### 3.3 Frequency Stability Measurement

#### 3.3.1 Limit

The frequency tolerance of the carrier signal shall be maintained within +/- 0.01% (100ppm) of the operating frequency over a temperature variation of -20 degrees to +50 degrees C at normal supply voltage, and for a variation in the primary supply voltage from 85% to 115% of the rated supply voltage at a temperature of 20 degrees C. For battery operated equipment, the equipment tests shall be performed by using a new battery.

#### 3.3.2 Measuring Instruments

Please refer to the measuring equipment list in this test report.

#### 3.3.3 Test Procedures

1. The spectrum analyzer connected via a receive antenna placed near the EUT.
2. EUT has transmitted signal and fixed channelize.
3. Set the spectrum analyzer span to view the entire emissions bandwidth.
4. Set RBW = 1 kHz, VBW = 3 kHz with peak detector and maxhold settings.
5. The  $f_c$  is declaring of channel frequency. Then the frequency error formula is  $(f_c - f) / f_c \times 10^6$  ppm and the limit is less than  $\pm 100$ ppm.
6. Extreme temperature rule is -20°C~50°C.

#### 3.3.4 Test Setup



#### 3.3.5 Test Result of Near Field Test Items

Please refer to Appendix B.



### 3.4 Field Strength of Fundamental Emissions and Mask Measurement

#### 3.4.1 Limit

Rules and specifications	FCC CFR 47 Part 15 section 15.225			
Description	Compliance with the spectrum mask is tested with RBW set to 9kHz.			
Freq. of Emission (MHz)	Field Strength (μV/m) at 30m	Field Strength (dBμV/m) at 30m	Field Strength (dBμV/m) at 10m	Field Strength (dBμV/m) at 3m
1.705~13.110	30	29.5	48.58	69.5
13.110~13.410	106	40.5	59.58	80.5
13.410~13.553	334	50.5	69.58	90.5
13.553~13.567	15848	84.0	103.08	124.0
13.567~13.710	334	50.5	69.58	90.5
13.710~14.010	106	40.5	59.58	80.5
14.010~30.000	30	29.5	48.58	69.5

**Remark:**

1. The field strength test result is in 3m test distance, follow test rules the test data use distance extrapolation factor and reported in this report at 30m test result.
2. Distance extrapolation factor = 40 log (specific distance / test distance) (dB)

#### 3.4.2 Measuring Instruments

Please refer to the measuring equipment list in this test report.

### 3.4.3 Test Procedures

1. Configure the EUT according to ANSI C63.10. The EUT is placed on the top of the turntable 0.8 meter above ground. The phase center of the loop receiving antenna mounted antenna tower is placed 3 meters far away from the turntable.
  2. Power on the EUT and all the supporting units. The turntable is rotated by 360 degrees to determine the position of the highest radiation.
  3. The height of the receiving antenna is fixed at one meter above ground to find the maximum emissions field strength.
  4. For Fundamental emissions, use the receiver to measure QP reading.
  5. When the radiated emissions limits are expressed in terms of the average value of the emissions, and pulsed operation is employed, the measurement field strength shall be determined by averaging over one complete pulse train, including blanking intervals, as long as the pulse train does not exceed 0.1 seconds. As an alternative (provided the transmitter operates for longer than 0.1 seconds) or in cases where the pulse train exceeds 0.1 seconds, the measured field strength shall be determined from the average absolute voltage during a 0.1 second interval during which the field strength is at its maximum value.
  6. Compliance with the spectrum mask is tested with RBW set to 9 kHz.
- Note: Emission level (dB $\mu$ V/m) = 20 log Emission level ( $\mu$ V/m).

### 3.4.4 Test Setup

For radiated test below 30MHz

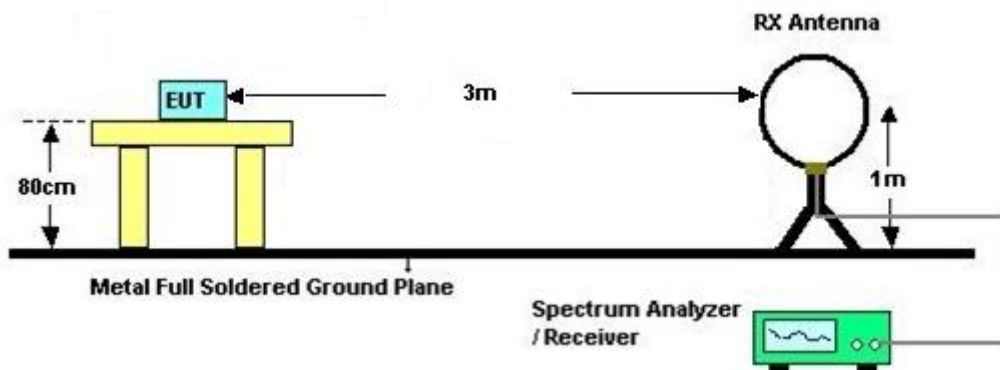

### 3.4.5 Test Result of Field Strength of Fundamental Emissions and Mask

Please refer to Appendix C.



### 3.5 Radiated Emissions Measurement

#### 3.5.1 Limit

The field strength of any emissions which appear outside of 13.110 ~14.010MHz band shall not exceed the general radiated emissions limits.

Frequencies (MHz)	Field Strength (µV/m)	Measurement Distance (meters)
0.009~0.490	2400/F(kHz)	300
0.490~1.705	24000/F(kHz)	30
1.705~30.0	30	30
30~88	100	3
88~216	150	3
216~960	200	3
Above 960	500	3

#### 3.5.2 Measuring Instruments

Please refer to the measuring equipment list in this test report.

#### 3.5.3 Measuring Instrument Setting

The following table is the setting of receiver:

Receiver Parameter	Setting
Attenuation	Auto
Frequency Range: 9kHz~150kHz	RBW 200Hz for QP
Frequency Range: 150kHz~30MHz	RBW 9kHz for QP
Frequency Range: 30MHz~1000MHz	RBW 120kHz for Peak

**Note:** The emission limits shown in the above table are based on measurements employing a CISPR quasi-peak detector except for the frequency bands 9-90 kHz and 110-490 kHz. Radiated emission limits in these two bands are based on measurements employing an average detector.





### 3.5.4 Test Procedures

1. Configure the EUT according to ANSI C63.10. The EUT is placed on the top of the turntable 0.8 meter above ground. The phase center of the receiving antenna mounted on the top of a height-variable antenna tower is placed 3 meters far away from the turntable.
2. Power on the EUT and all the supporting units. The turntable is rotated by 360 degrees to determine the position of the highest radiation.
3. The height of the broadband receiving antenna is varied between one meter and four meters above ground to find the maximum emissions field strength of both horizontal and vertical polarization.
4. For each suspected emissions, the antenna tower is scanned (from 1 M to 4 M) and then the turntable is rotated (from 0 degree to 360 degrees) to find the maximum reading.
5. Set the test-receiver system to Peak or CISPR quasi-peak Detect Function with specified bandwidth under Maximum Hold Mode.
6. When the radiated emissions limits are expressed in terms of the average value of the emissions, and pulsed operation is employed, the measurement field strength shall be determined by averaging over one complete pulse train, including blanking intervals, as long as the pulse train does not exceed 0.1 seconds. As an alternative (provided the transmitter operates for longer than 0.1 seconds) or in cases where the pulse train exceeds 0.1 seconds, the measured field strength shall be determined from the average absolute voltage during a 0.1 second interval during which the field strength is at its maximum value.
7. In case the emission is lower than 30 MHz, loop antenna has to be used for measurement and the recorded data shall be QP measured by receiver.
8. Radiated testing below 1 GHz is performed by adjusting the antenna tower from 1 m to 4 m and by rotating the turn table from 0 degree to 360 degrees to find the peak maximum hold reading. When there is no suspected emission found and the emission level is with at least 6 dB margin against QP limit line, the position is marked as “-“.

### 3.5.5 Test Setup

For radiated test below 30MHz

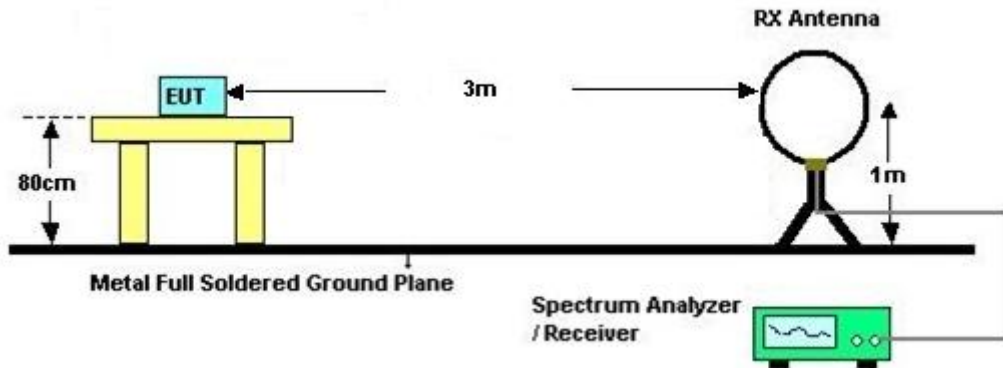

For radiated test above 30MHz

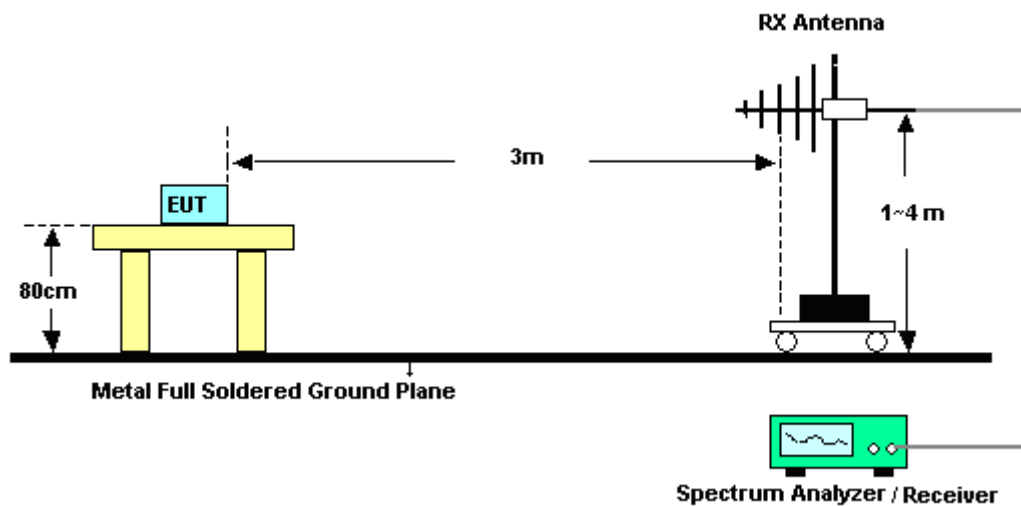

### 3.5.6 Test Result of Radiated Emissions Measurement

Please refer to Appendix C.

**Remark:** There is adequate comparison measurement of both open-field test site and alternative test site - semi-Anechoic chamber according to 414788 D01 Radiated Test Site v01r01, and the result came out very similar.



## **3.6 Antenna Requirements**

### **3.6.1 Standard Applicable**

Except for special regulations, the Low-power Radio-frequency Devices must not be equipped with any jacket for installing an antenna with extension cable. An intentional radiator shall be designed to ensure that no antenna other than that furnished by the responsible party shall be used with the device. The use of a permanently attached antenna or of an antenna that uses a unique coupling to the intentional radiator shall be considered sufficient to comply with the provisions of this Section. The manufacturer may design the unit so that the user can replace a broken antenna, but the use of a standard antenna jack or electrical connector is prohibited.

The use of a permanently attached antenna or of an antenna that uses a unique coupling to the intentional radiator shall be considered sufficient to comply with the rule.

### **3.6.2 Antenna Anti-Replacement Construction**

An embedded-in antenna design is used.



## 4. List of Measuring Equipment

Instrument	Brand Name	Model No.	Serial No.	Characteristics	Calibration Date	Test Date	Due Date	Remark
EMI Test Receiver	Rohde & Schwarz	ESU26	100472	20Hz~26.5GHz	Feb. 13, 2023	Apr. 10, 2023	Feb. 12, 2024	Radiation (03CH07-HY)
Loop Antenna	Rohde & Schwarz	HFH2-Z2	100488	9 kHz~30 MHz	Sep. 20, 2022	Apr. 10, 2023	Sep. 19, 2023	Radiation (03CH07-HY)
Bilog Antenna	TESEQ	CBL 6111D & 00800N1D01N-06	35419 & 03	30MHz~1GHz	Apr. 24, 2022	Apr. 10, 2023	Apr. 23, 2023	Radiation (03CH07-HY)
Preamplifier	COM-POWER	PA-103A	161241	10MHz~1GHz	Oct. 03, 2022	Apr. 10, 2023	Oct. 02, 2023	Radiation (03CH07-HY)
RF Cable	HUBER + SUHNER	SUCOFLEX 104	MY15682/4	30MHz to 18GHz	Feb. 22, 2023	Apr. 10, 2023	Feb. 21, 2024	Radiation (03CH07-HY)
RF Cable	HUBER + SUHNER	SUCOFLEX 104	MY24971/4	9kHz to 18GHz	Feb. 22, 2023	Apr. 10, 2023	Feb. 21, 2024	Radiation (03CH07-HY)
RF Cable	HUBER + SUHNER	SUCOFLEX 104	MY28655/4	9kHz to 18GHz	Feb. 22, 2023	Apr. 10, 2023	Feb. 21, 2024	Radiation (03CH07-HY)
Controller	EMEC	EM1000	N/A	Control Ant Mast	N/A	Apr. 10, 2023	N/A	Radiation (03CH07-HY)
Controller	MF	MF-7802	N/A	Control Turn table	N/A	Apr. 10, 2023	N/A	Radiation (03CH07-HY)
Antenna Mast	EMEC	AM-BS-4500E	N/A	Boresight mast 1M~4M	N/A	Apr. 10, 2023	N/A	Radiation (03CH07-HY)
Turn Table	ChainTek	Chaintek 3000	N/A	0~360 Degree	N/A	Apr. 10, 2023	N/A	Radiation (03CH07-HY)
Software	Audix	E3	N/A	N/A	N/A	Apr. 10, 2023	N/A	Radiation (03CH07-HY)
USB Data Logger	TECPEL	TR-32	HE17XB2495	N/A	Mar. 14, 2023	Apr. 10, 2023	Mar. 13, 2024	Radiation (03CH07-HY)
Hygrometer	TECPEL	DTM-303A	TP201996	N/A	Nov. 17, 2022	Apr. 17, 2023	Nov. 16, 2023	Near Field (TH03-HY)
Spectrum Analyzer	Rohde & Schwarz	FSP30	101329	9kHz~30GHz	Sep. 27, 2022	Apr. 17, 2023	Sep. 26, 2023	Near Field (TH03-HY)
Thermal Chamber	ESPEC	SH-641	92013720	-40°C ~90°C	Sep. 07, 2022	Apr. 17, 2023	Sep. 06, 2023	Near Field (TH03-HY)
Programmable Power Supply	GW Instek	PSS-2005	EL890001	1V~20V 0.5A~4A	Sep. 29, 2022	Apr. 17, 2023	Sep. 28, 2023	Near Field (TH03-HY)
Coupling loop antenna	EMCI	LF R 400	02-1641	100 kHz up to 50 MHz	Apr. 25, 2022	Apr. 17, 2023	Apr. 24, 2023	Near Field (TH03-HY)
AC Power Source	ChainTek	APC-1000W	N/A	N/A	N/A	May 17, 2023	N/A	Conduction (CO05-HY)
EMI Test Receiver	Rohde & Schwarz	ESR3	102388	9kHz~3.6GHz	Dec. 01, 2022	May 17, 2023	Nov. 30, 2023	Conduction (CO05-HY)
Hygrometer	Testo	608-H1	34913912	N/A	Nov. 17, 2022	May 17, 2023	Nov. 16, 2023	Conduction (CO05-HY)
LISN	Rohde & Schwarz	ENV216	100081	9kHz~30MHz	Nov. 17, 2022	May 17, 2023	Nov. 16, 2023	Conduction (CO05-HY)
Software	Rohde & Schwarz	EMC32	N/A	N/A	N/A	May 17, 2023	N/A	Conduction (CO05-HY)
Pulse Limiter	SCHWARZBECK	VTSD 9561-FN	00691	N/A	Aug. 01, 2022	May 17, 2023	Jul. 31, 2023	Conduction (CO05-HY)
LISN Cable	MVE	RG-400	260260	N/A	Dec. 29, 2022	May 17, 2023	Dec. 28, 2023	Conduction (CO05-HY)



## 5. Measurement Uncertainty

### Uncertainty of Conducted Emission Measurement (150 kHz ~ 30 MHz)

Measuring Uncertainty for a Level of Confidence of 95% ( $U = 2Uc(y)$ )	3.5 dB
---	--------

### Uncertainty of Radiated Emission Measurement (9 kHz ~ 30 MHz)

Measuring Uncertainty for a Level of Confidence of 95% ( $U = 2Uc(y)$ )	3.8 dB
---	--------

### Uncertainty of Radiated Emission Measurement (30 MHz ~ 1000 MHz)

Measuring Uncertainty for a Level of Confidence of 95% ( $U = 2Uc(y)$ )	6.5 dB
---	--------



## **Appendix A. Test Results of Conducted Emission Test**

<Original>

## EUT Information

Report NO : 2D0208-01  
Test Mode : Mode 1  
Test Voltage : 120Vac/60Hz  
Phase : Line

Full Spectrum

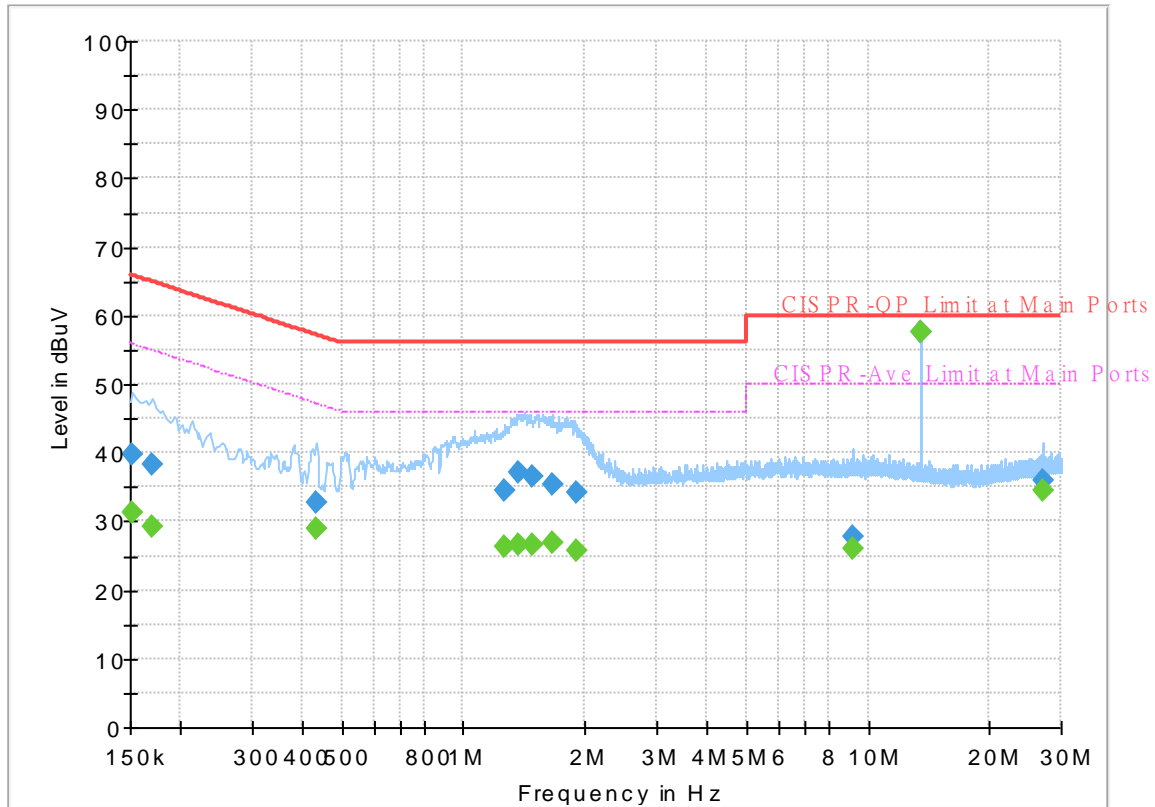

## Final Result

Frequency (MHz)	QuasiPeak (dBuV)	CAverage (dBuV)	Limit (dBuV)	Margin (dB)	Line	Filter	Corr. (dB)
0.152250	---	31.25	55.88	24.63	L1	OFF	19.9
0.152250	39.84	---	65.88	26.04	L1	OFF	19.9
0.170250	---	29.12	54.95	25.83	L1	OFF	19.9
0.170250	38.44	---	64.95	26.51	L1	OFF	19.9
0.431250	---	28.86	47.23	18.37	L1	OFF	19.9
0.431250	32.74	---	57.23	24.49	L1	OFF	19.9
1.259250	---	26.33	46.00	19.67	L1	OFF	19.9
1.259250	34.40	---	56.00	21.60	L1	OFF	19.9
1.360500	---	26.66	46.00	19.34	L1	OFF	19.9
1.360500	37.28	---	56.00	18.72	L1	OFF	19.9
1.488750	---	26.62	46.00	19.38	L1	OFF	19.9
1.488750	36.55	---	56.00	19.45	L1	OFF	19.9
1.653000	---	26.98	46.00	19.02	L1	OFF	19.9
1.653000	35.24	---	56.00	20.76	L1	OFF	19.9
1.905000	---	25.81	46.00	20.19	L1	OFF	19.9
1.905000	34.27	---	56.00	21.73	L1	OFF	19.9
9.222000	---	25.91	50.00	24.09	L1	OFF	20.2
9.222000	27.71	---	60.00	32.29	L1	OFF	20.2
13.560000	---	57.74	50.00	-7.74	L1	OFF	20.4
13.560000	57.69	---	60.00	2.31	L1	OFF	20.4
27.120750	---	34.55	50.00	15.45	L1	OFF	20.7

27.120750	35.83	---	60.00	24.17	L1	OFF	20.7
-----------	-------	-----	-------	-------	----	-----	------



# EUT Information

Report NO : 2D0208-01  
 Test Mode : Mode 1  
 Test Voltage : 120Vac/60Hz  
 Phase : Neutral

Full Spectrum

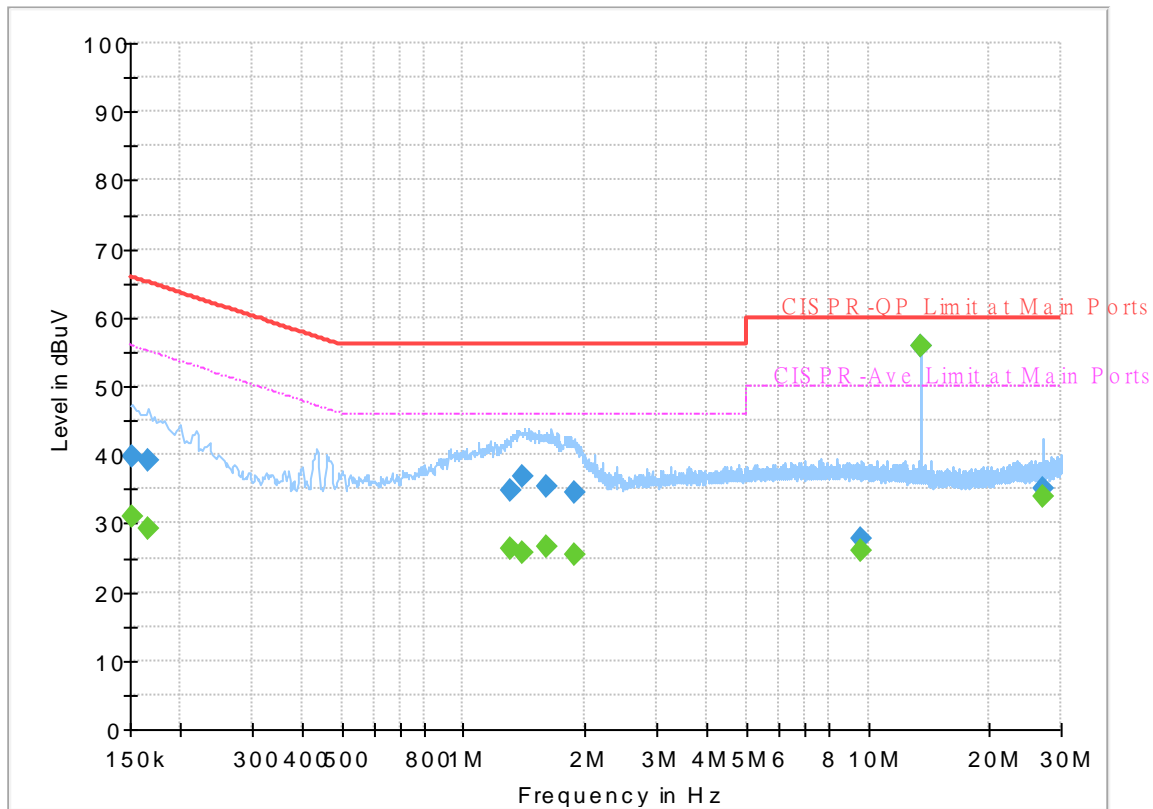

## Final\_Result

Frequency (MHz)	QuasiPeak (dBuV)	CAverage (dBuV)	Limit (dBuV)	Margin (dB)	Line	Filter	Corr. (dB)
0.152250	---	30.93	55.88	24.95	N	OFF	19.9
0.152250	39.78	---	65.88	26.10	N	OFF	19.9
0.165750	---	29.34	55.17	25.83	N	OFF	19.9
0.165750	39.09	---	65.17	26.08	N	OFF	19.9
1.299750	---	26.36	46.00	19.64	N	OFF	19.9
1.299750	34.75	---	56.00	21.25	N	OFF	19.9
1.392000	---	25.59	46.00	20.41	N	OFF	19.9
1.392000	36.76	---	56.00	19.24	N	OFF	19.9
1.603500	---	26.61	46.00	19.39	N	OFF	19.9
1.603500	35.33	---	56.00	20.67	N	OFF	19.9
1.887000	---	25.51	46.00	20.49	N	OFF	19.9
1.887000	34.59	---	56.00	21.41	N	OFF	19.9
9.651750	---	25.94	50.00	24.06	N	OFF	20.2
9.651750	27.85	---	60.00	32.15	N	OFF	20.2
13.560000	---	55.97	50.00	-5.97	N	OFF	20.4
13.560000	55.93	---	60.00	4.07	N	OFF	20.4
27.120750	---	33.80	50.00	16.20	N	OFF	20.9
27.120750	35.06	---	60.00	24.94	N	OFF	20.9

# <Terminal>

## EUT Information

Report NO : 2D0208-01  
 Test Mode : Mode 1  
 Test Voltage : 120Vac/60Hz  
 Phase : Line

Full Spectrum

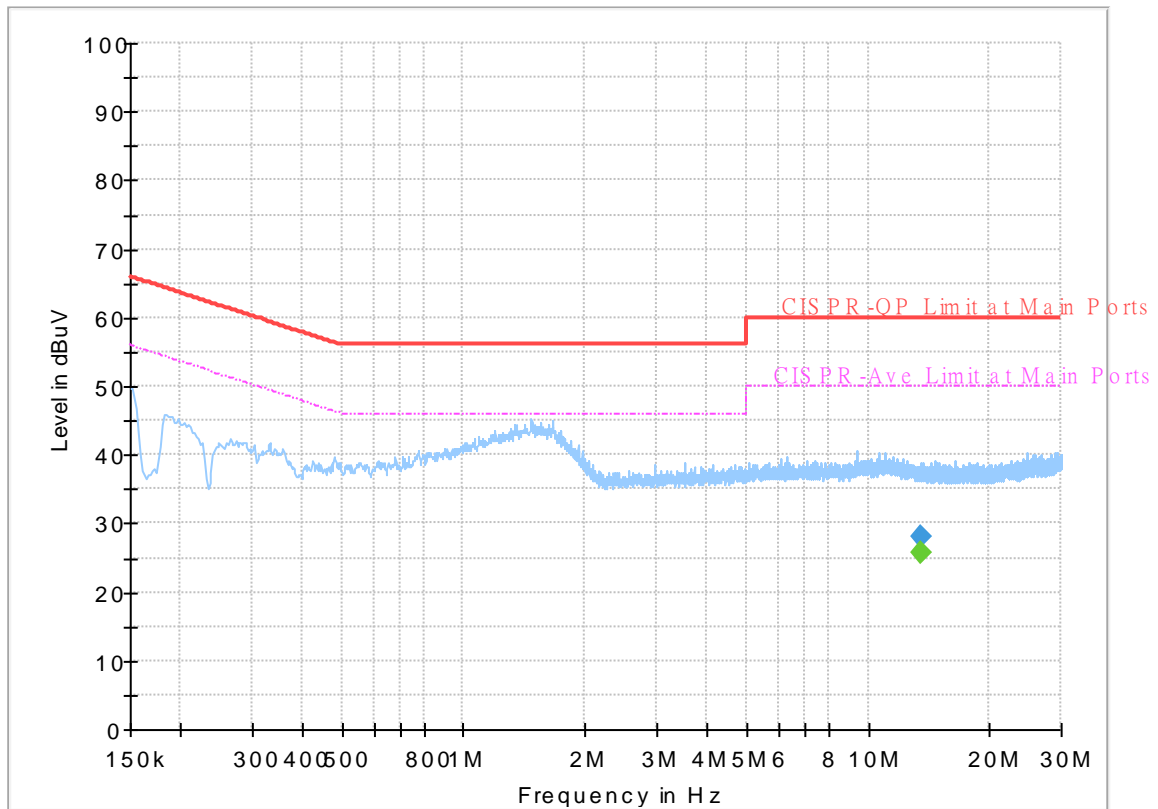

## Final\_Result

Frequency (MHz)	QuasiPeak (dBuV)	CAverage (dBuV)	Limit (dBuV)	Margin (dB)	Line	Filter	Corr. (dB)
13.560000	---	25.83	50.00	24.17	L1	OFF	20.4
13.560000	27.97	---	60.00	32.03	L1	OFF	20.4

# EUT Information

Report NO : 2D0208-01  
 Test Mode : Mode 1  
 Test Voltage : 120Vac/60Hz  
 Phase : Neutral

Full Spectrum

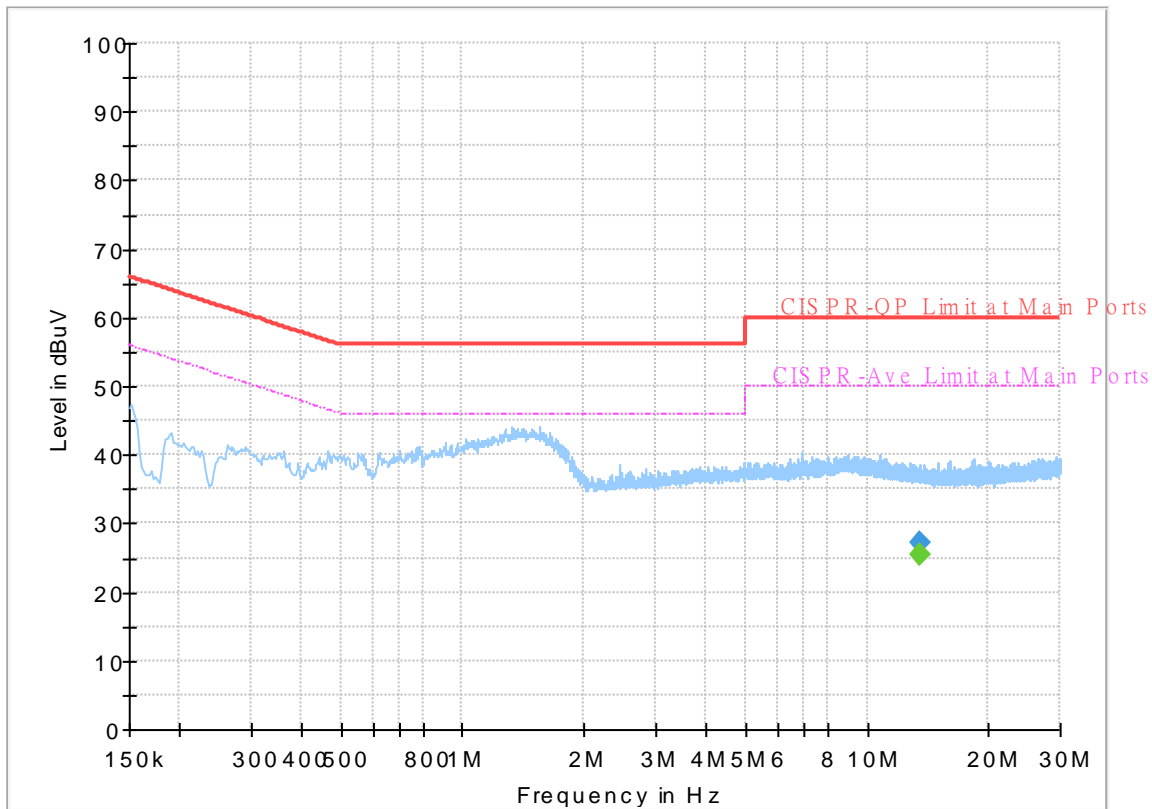

## Final\_Result

Frequency (MHz)	QuasiPeak (dBuV)	CAverage (dBuV)	Limit (dBuV)	Margin (dB)	Line	Filter	Corr. (dB)
13.560000	---	25.43	50.00	24.57	N	OFF	20.4
13.560000	27.14	---	60.00	32.86	N	OFF	20.4



## Appendix B. Test Results of Near Field Test Items

### B1. Test Result of 20dB Spectrum Bandwidth

Test mode	NFC Tx	Test Frequency (MHz)	13.56
Date: 17.APR.2023 18:05:48		Date: 17.APR.2023 18:03:01	
<b>20dB Bandwidth (kHz)</b>	2.660	<b>99% Occupied BW(kHz)</b>	2.240
<b>Frequency range (MHz)</b>	$f_L > 13.553$	13.55868	<b>Test Result</b>
	$f_H < 13.567$	13.56134	<b>Complies</b>

**Remark:** Because the measured signal is CW adjusting the RBW per C63.10 would not be practical since measured bandwidth will always follow the RBW and the result will be approximately twice the RBW.



B2. Test Result of Frequency Stability

Voltage vs. Frequency Stability		Temperature vs. Frequency Stability		
Voltage (Vdc)	Measurement Frequency (MHz)	Temperature (°C)	Time	Measurement Frequency (MHz)
3.89	13.560010	<b>-20</b>	<b>0</b>	13.560060
3.6	13.560020		<b>2</b>	13.560050
4.4	13.560020		<b>5</b>	13.560050
			<b>10</b>	13.560050
		<b>-10</b>	<b>0</b>	13.560060
			<b>2</b>	13.560060
			<b>5</b>	13.560060
			<b>10</b>	13.560060
		<b>0</b>	<b>0</b>	13.560060
			<b>2</b>	13.560060
			<b>5</b>	13.560070
			<b>10</b>	13.560070
		<b>10</b>	<b>0</b>	13.560070
			<b>2</b>	13.560060
			<b>5</b>	13.560060
			<b>10</b>	13.560060
		<b>20</b>	<b>0</b>	13.560060
			<b>2</b>	13.560050
			<b>5</b>	13.560050
			<b>10</b>	13.560050
		<b>30</b>	<b>0</b>	13.560040
			<b>2</b>	13.560040
			<b>5</b>	13.560030
			<b>10</b>	13.560040
		<b>40</b>	<b>0</b>	13.560020
			<b>2</b>	13.560020
			<b>5</b>	13.560010
			<b>10</b>	13.560000



Voltage vs. Frequency Stability		Temperature vs. Frequency Stability		
Voltage (Vdc)	Measurement Frequency (MHz)	Temperature (°C)	Time	Measurement Frequency (MHz)
		50	0	13.559990
			2	13.559990
			5	13.559990
			10	13.559980
Max.Deviation (MHz)	0.000020	Max.Deviation (MHz)		0.000070
Max.Deviation (ppm)	1.4749	Max.Deviation (ppm)		5.1622
Limit	FS < ±100 ppm	Limit		FS < ±100 ppm
Test Result	PASS	Test Result		PASS



## Appendix C. Test Results of Radiated Test Items

### C1. Test Result of Field Strength of Fundamental Emissions

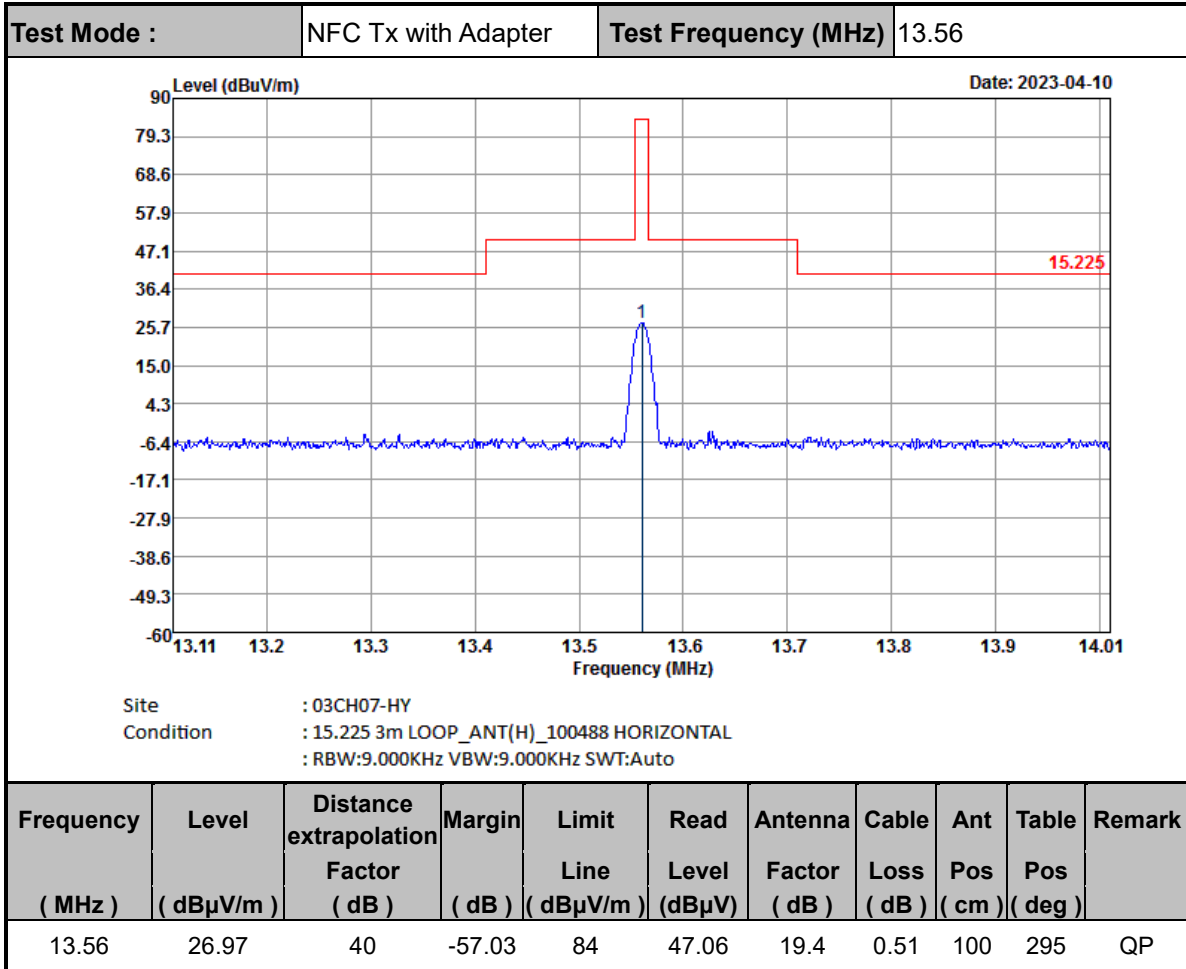



Test Mode :	NFC Tx with Adapter	Test Frequency (MHz)	13.56
-------------	---------------------	----------------------	-------

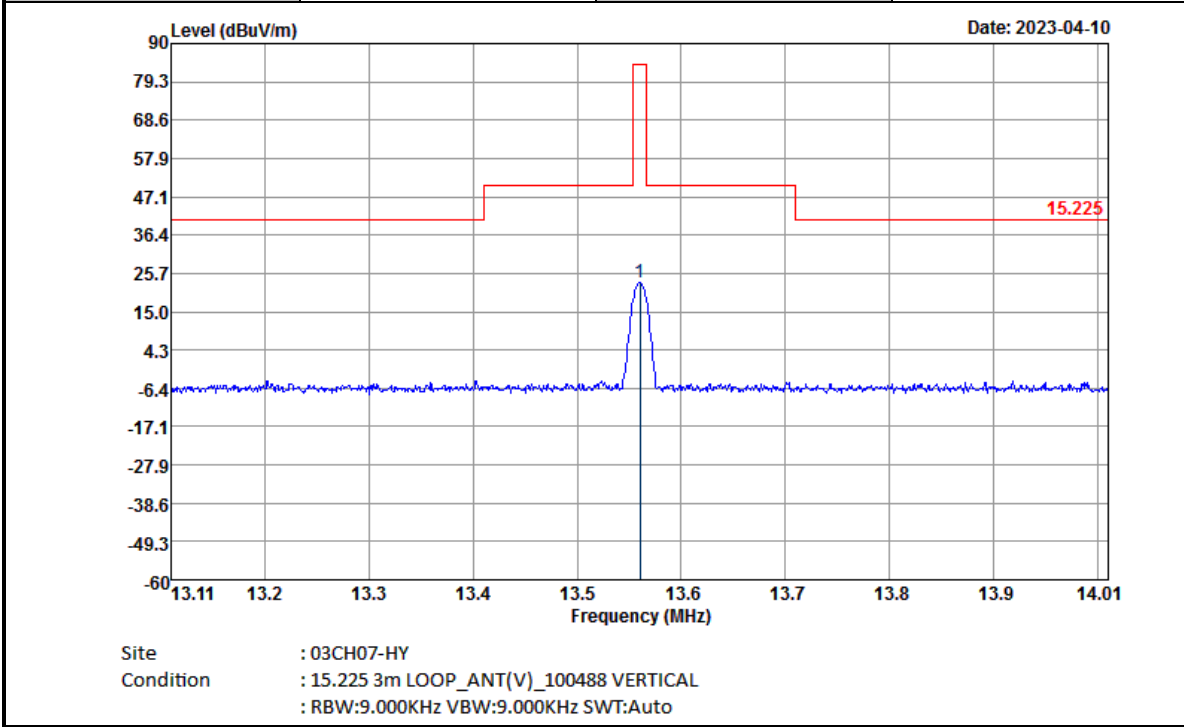

Frequency (MHz)	Level (dBμV/m)	Distance extrapolation Factor (dB)	Margin (dB)	Limit Line (dBμV/m)	Read Level (dBμV)	Antenna Factor (dB)	Cable Loss (dB)	Ant Pos (cm)	Table Pos (deg)	Remark
13.56	23.04	40	-60.96	84	43.13	19.4	0.51	100	0	QP

**Note :**

1. Distance extrapolation factor = 40 log (specific distance / test distance) (dB)
2. Level = Antenna Factor + Cable Loss + Read Level - Distance extrapolation factor.



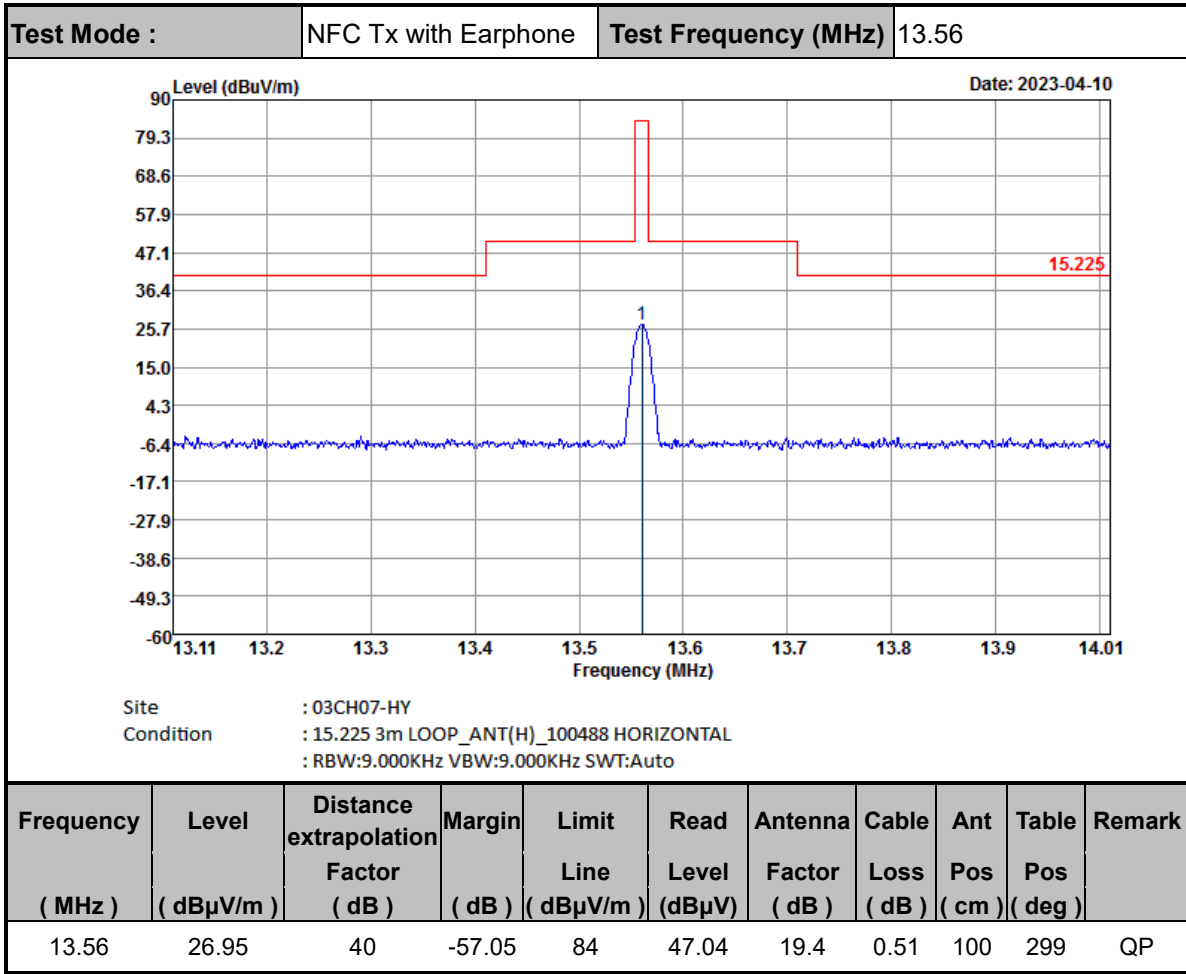



Test Mode :	NFC Tx with Earphone	Test Frequency (MHz)	13.56
-------------	----------------------	----------------------	-------

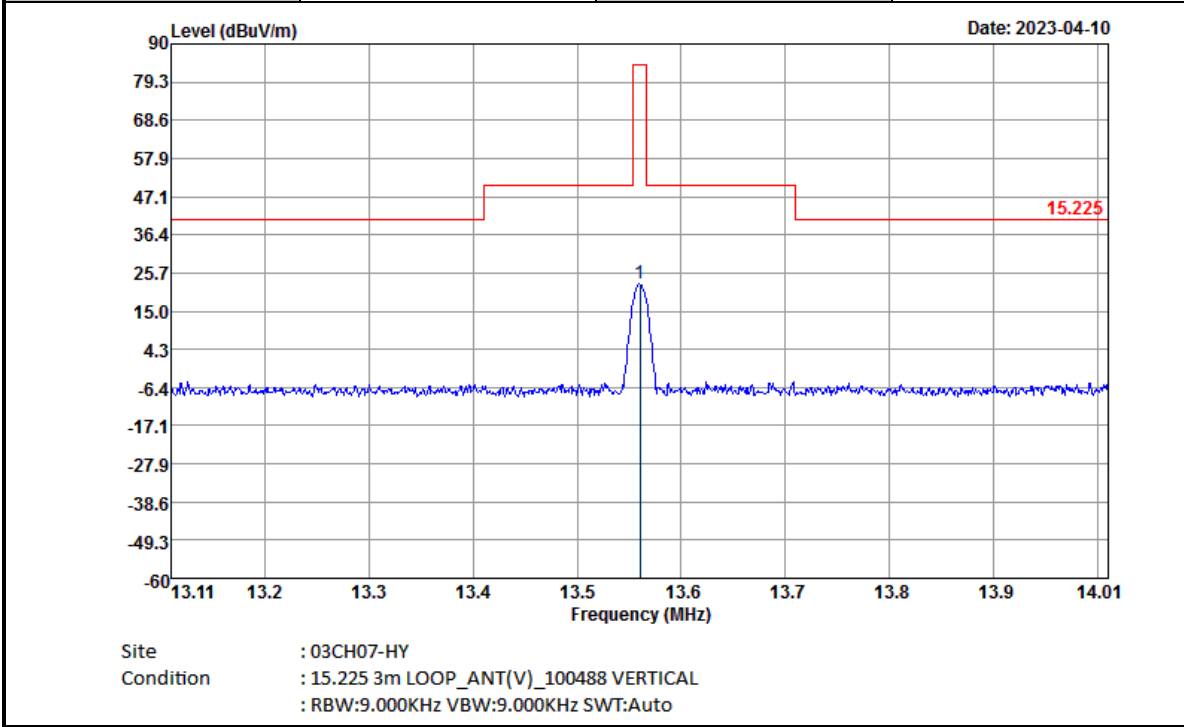

Frequency (MHz)	Level (dBμV/m)	Distance extrapolation Factor (dB)	Margin (dB)	Limit Line (dBμV/m)	Read Level (dBμV)	Antenna Factor (dB)	Cable Loss (dB)	Ant Pos (cm)	Table Pos (deg)	Remark
13.56	22.56	40	-61.44	84	42.65	19.4	0.51	100	190	QP

**Note :**

1. Distance extrapolation factor = 40 log (specific distance / test distance) (dB)
2. Level = Antenna Factor + Cable Loss + Read Level - Distance extrapolation factor.

**C2. Results of Radiated Spurious Emissions (9 kHz~30MHz)**

<b>Test Mode :</b>	NFC Tx with Adapter	<b>Polarization :</b>	Horizontal
--------------------	---------------------	-----------------------	------------

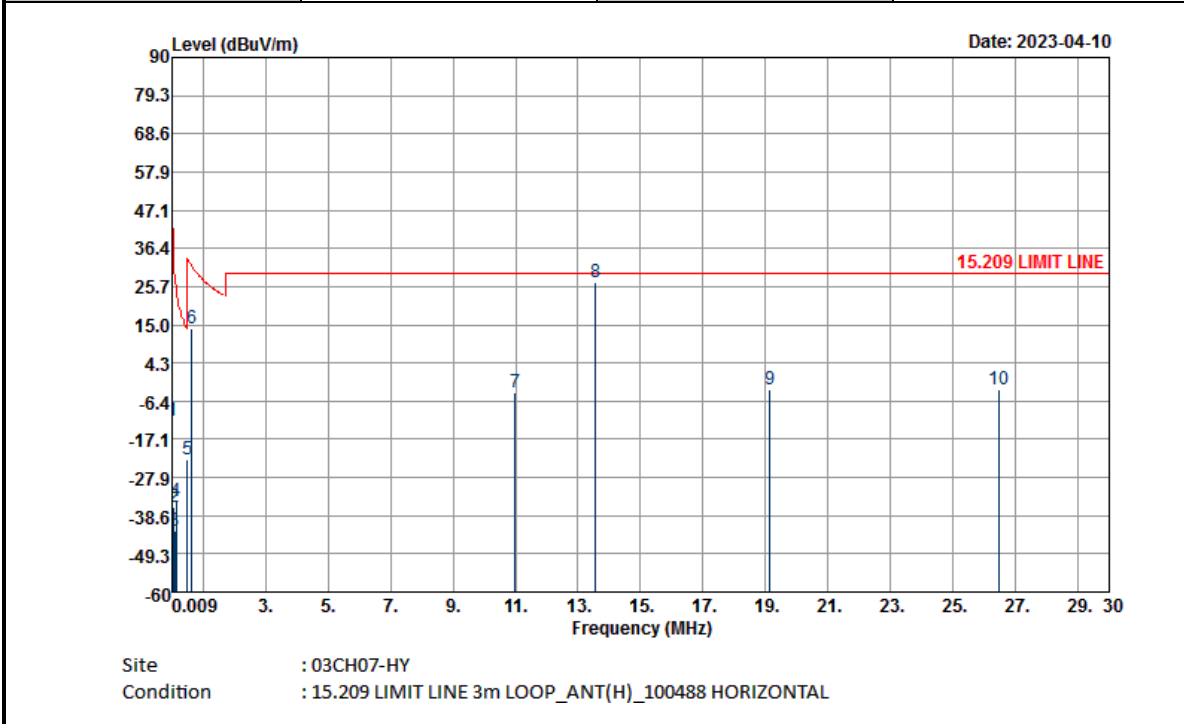

Frequency ( MHz )	Level ( dBμV/m )	Distance extrapolation Factor ( dB )	Margin ( dB )	Limit Line ( dBμV/m )	Read Level ( dBμV )	Antenna Factor ( dB )	Cable Loss ( dB )	Ant Pos ( cm )	Table Pos ( deg )	Remark
0.0192	-11.9	80	-53.84	41.94	47.77	19.82	0.51	-	-	Average
0.06831	-36.31	80	-67.22	30.91	23.48	19.7	0.51	-	-	Average
0.0944	-42.9	80	-71	28.1	16.93	19.66	0.51	-	-	QP
0.15	-34.51	80	-58.59	24.08	25.38	19.6	0.51	-	-	Average
0.48966	-22.77	80	-36.58	13.81	37.22	19.5	0.51	-	-	Average
0.6402	14.02	40	-17.46	31.48	34.01	19.5	0.51	-	-	QP
10.992	-4.1	40	-33.6	29.5	15.99	19.4	0.51	-	-	QP
13.56	26.7	40	-2.8	29.5	46.79	19.4	0.51	-	-	QP
19.132	-3.06	40	-32.56	29.5	16.82	19.61	0.51	-	-	QP
26.475	-3.34	40	-32.84	29.5	15.1	20.2	1.36	-	-	QP



Test Mode :	NFC Tx with Adapter	Polarization :	Vertical
-------------	---------------------	----------------	----------

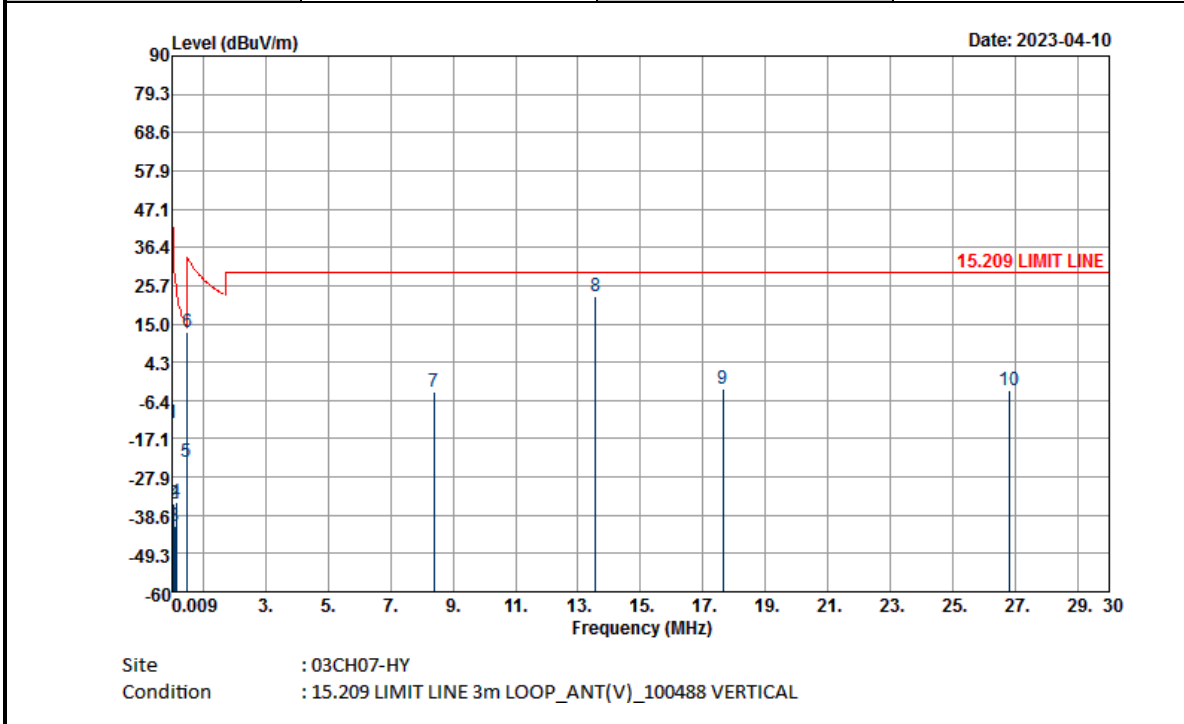

Frequency ( MHz )	Level ( dBμV/m )	Distance extrapolation Factor ( dB )	Margin ( dB )	Limit Line ( dBμV/m )	Read Level ( dBμV )	Antenna Factor ( dB )	Cable Loss ( dB )	Ant Pos ( cm )	Table Pos ( deg )	Remark
0.0192	-12.79	80	-54.73	41.94	46.88	19.82	0.51	-	-	Average
0.06831	-35.16	80	-66.07	30.91	24.63	19.7	0.51	-	-	Average
0.09224	-41.62	80	-69.93	28.31	18.19	19.68	0.51	-	-	QP
0.15	-34.73	80	-58.81	24.08	25.16	19.6	0.51	-	-	Average
0.48048	-23.84	80	-37.81	13.97	36.15	19.5	0.51	-	-	Average
0.49751	12.87	40	-20.8	33.67	32.86	19.5	0.51	-	-	QP
8.392	-4.15	40	-33.65	29.5	15.88	19.46	0.51	-	-	QP
13.56	22.87	40	-6.63	29.5	42.96	19.4	0.51	-	-	QP
17.647	-3.14	40	-32.64	29.5	16.85	19.5	0.51	-	-	QP
26.795	-3.73	40	-33.23	29.5	14.71	20.2	1.36	-	-	QP

**Note :**

1. The amplitude of spurious emissions which are attenuated by more than 20dB below the permissible value has no need to be reported.
2. Distance extrapolation factor = 40 log (specific distance / test distance) (dB)
3. Level = Antenna Factor + Cable Loss + Read Level - Distance extrapolation factor.
4. 13.56 MHz is fundamental signal which can be ignored



<b>Test Mode :</b>	NFC Tx with Earphone	<b>Polarization :</b>	Horizontal
--------------------	----------------------	-----------------------	------------

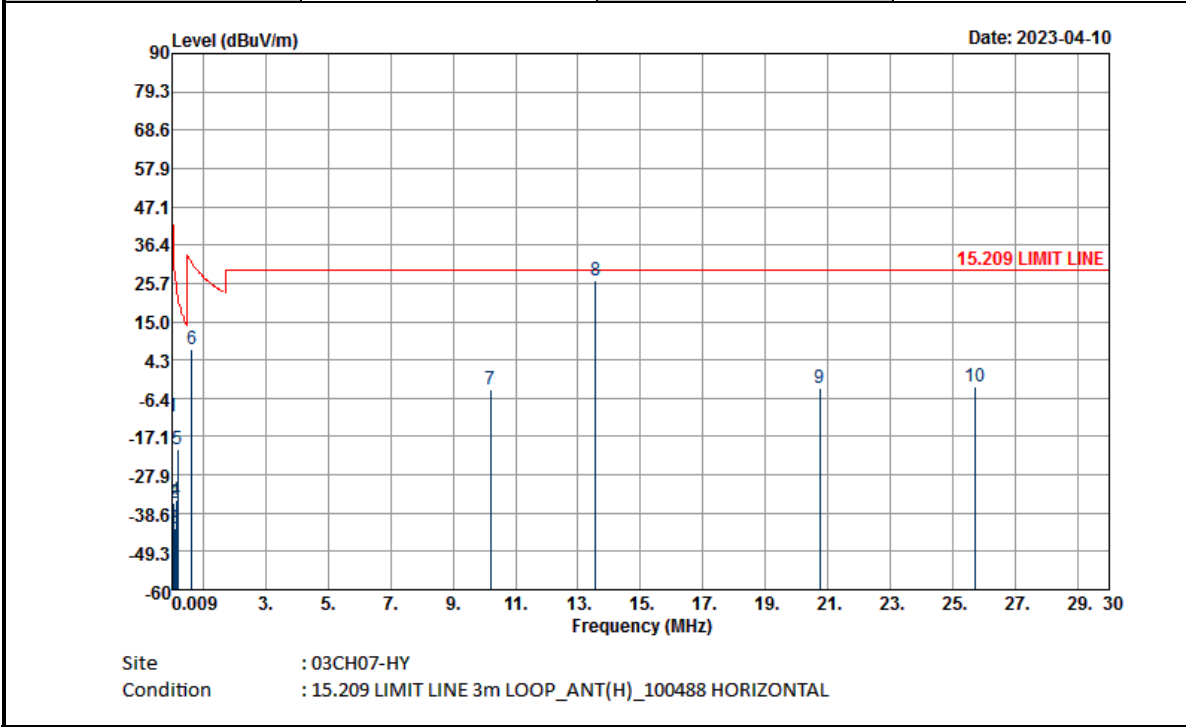

Frequency ( MHz )	Level ( dBμV/m )	Distance extrapolation Factor ( dB )	Margin ( dB )	Limit Line ( dBμV/m )	Read Level (dBμV)	Antenna Factor ( dB )	Cable Loss ( dB )	Ant Pos ( cm )	Table Pos ( deg )	Remark
0.0192	-11.74	80	-53.68	41.94	47.93	19.82	0.51	-	-	Average
0.06831	-35.9	80	-66.81	30.91	23.89	19.7	0.51	-	-	Average
0.10006	-42.71	80	-70.31	27.6	17.18	19.6	0.51	-	-	QP
0.15	-35.1	80	-59.18	24.08	24.79	19.6	0.51	-	-	Average
0.1993	-20.56	80	-42.17	21.61	39.33	19.6	0.51	-	-	Average
0.64771	7.44	40	-23.94	31.38	27.43	19.5	0.51	-	-	QP
10.192	-3.98	40	-33.48	29.5	16.11	19.4	0.51	-	-	QP
13.56	26.43	40	-3.07	29.5	46.52	19.4	0.51	-	-	QP
20.743	-3.43	40	-32.93	29.5	15.44	19.77	1.36	-	-	QP
25.705	-3.34	40	-32.84	29.5	15.13	20.17	1.36	-	-	QP



<b>Test Mode :</b>	NFC Tx with Earphone	<b>Polarization :</b>	Vertical
--------------------	----------------------	-----------------------	----------

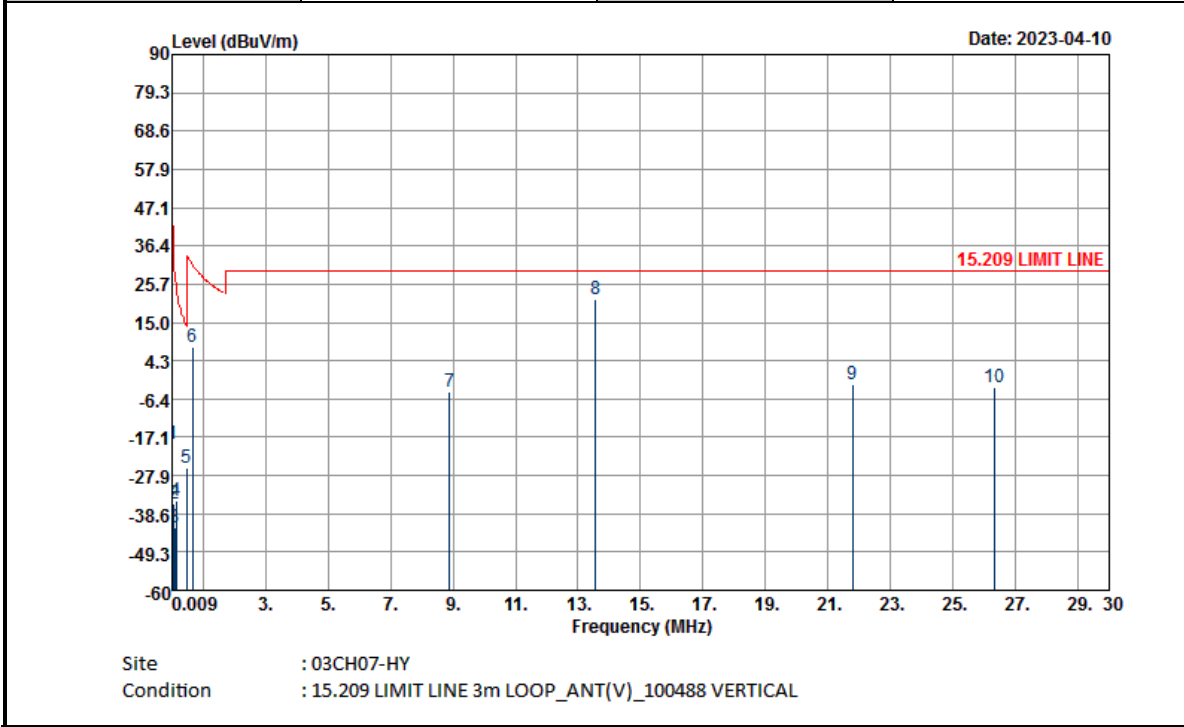

Frequency ( MHz )	Level ( dBμV/m )	Distance extrapolation Factor ( dB )	Margin ( dB )	Limit Line ( dBμV/m )	Read Level (dBμV)	Antenna Factor ( dB )	Cable Loss ( dB )	Ant Pos ( cm )	Table Pos ( deg )	Remark
0.0192	-18.87	80	-60.81	41.94	40.8	19.82	0.51	-	-	Average
0.06831	-35.58	80	-66.49	30.91	24.21	19.7	0.51	-	-	Average
0.10006	-42.43	80	-70.03	27.6	17.46	19.6	0.51	-	-	QP
0.15	-34.97	80	-59.05	24.08	24.92	19.6	0.51	-	-	Average
0.48116	-25.71	80	-39.67	13.96	34.28	19.5	0.51	-	-	Average
0.65522	8.02	40	-23.26	31.28	28.01	19.5	0.51	-	-	QP
8.88	-4.5	40	-34	29.5	15.58	19.41	0.51	-	-	QP
13.56	21.65	40	-7.85	29.5	41.74	19.4	0.51	-	-	QP
21.778	-2.5	40	-32	29.5	16.26	19.88	1.36	-	-	QP
26.34	-3.18	40	-32.68	29.5	15.26	20.2	1.36	-	-	QP

**Note :**

- The amplitude of spurious emissions which are attenuated by more than 20dB below the permissible value has no need to be reported.
- Distance extrapolation factor = 40 log (specific distance / test distance) (dB)
- Level = Antenna Factor + Cable Loss + Read Level - Distance extrapolation factor.
- 13.56 MHz is fundamental signal which can be ignored



**C3. Results of Radiated Spurious Emissions (30MHz~1GHz)**

<b>Test Mode :</b>	NFC Tx with Adapter	<b>Polarization :</b>	Horizontal
--------------------	---------------------	-----------------------	------------

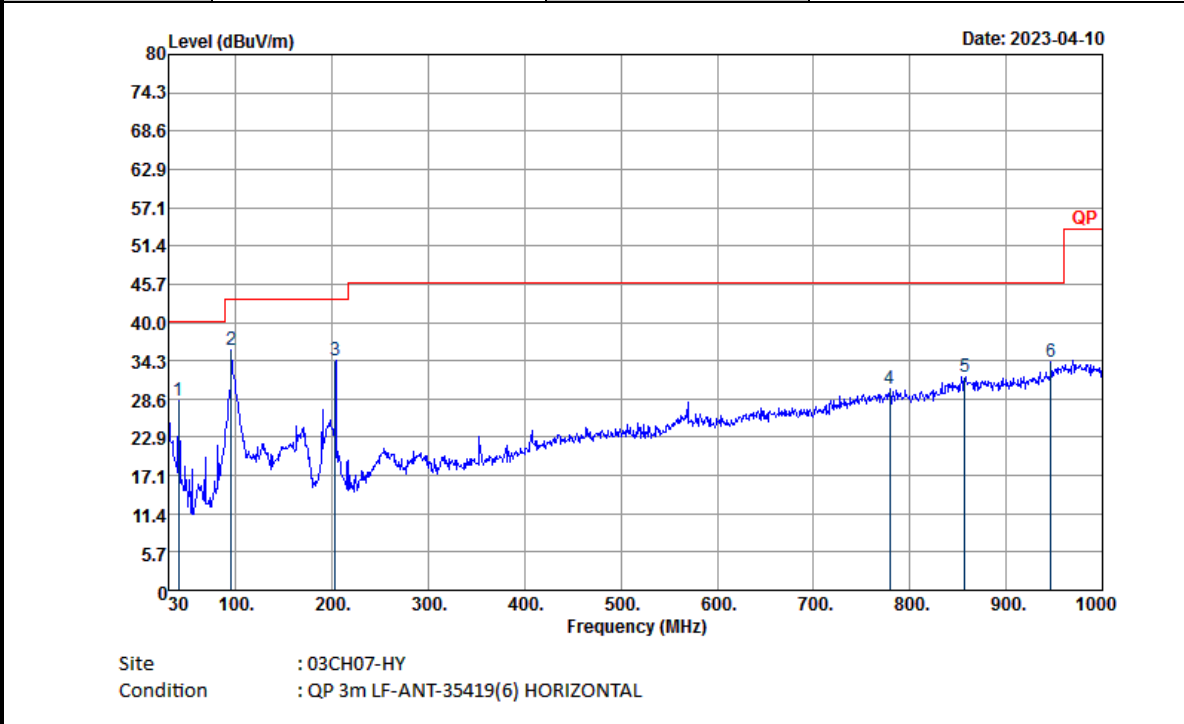

Frequency ( MHz )	Level ( dB $\mu$ V/m )	Margin ( dB )	Limit Line ( dB $\mu$ V/m )	Read Level ( dB $\mu$ V )	Antenna Factor ( dB )	Cable Loss ( dB )	Preamp Factor ( dB )	Ant Pos ( cm )	Table Pos ( deg )	Remark
40.68	28.36	-11.64	40	37.88	19.07	1.36	29.95	-	-	Peak
94.8	35.97	-7.53	43.5	49.32	15.15	1.52	30.02	-	-	Peak
203.34	34.38	-9.12	43.5	47.16	14.98	2.28	30.04	-	-	Peak
778.8	30.02	-15.98	46	27.3	27.81	4.56	29.65	-	-	Peak
857.2	31.9	-14.1	46	27.39	28.9	4.86	29.25	-	-	Peak
946.1	34.14	-11.86	46	27.79	30.05	5.14	28.84	-	-	Peak



Test Mode :	NFC Tx with Adapter	Polarization :	Vertical
-------------	---------------------	----------------	----------

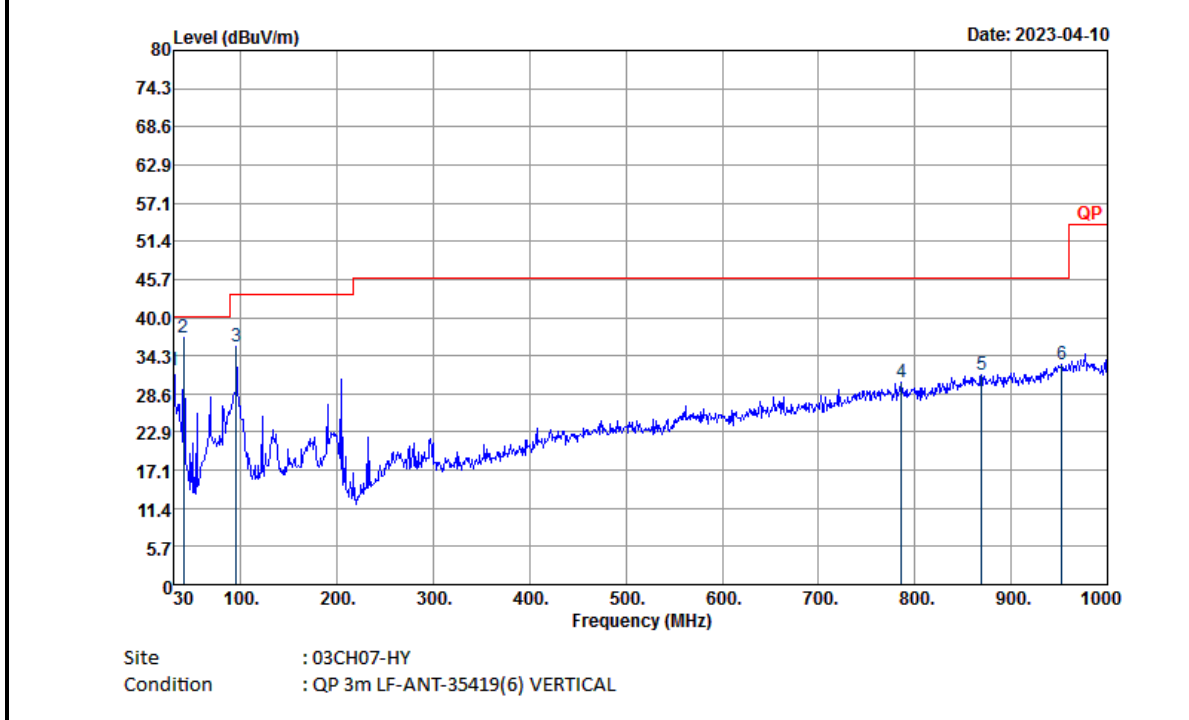

Frequency ( MHz )	Level ( dBμV/m )	Margin ( dB )	Limit Line ( dBμV/m )	Read Level ( dBμV )	Antenna Factor ( dB )	Cable Loss ( dB )	Preamp Factor ( dB )	Ant Pos ( cm )	Table Pos ( deg )	Remark
30	32.11	-7.89	40	36.32	24.51	1.36	30.08	-	-	Peak
40.68	36.97	-3.03	40	46.49	19.07	1.36	29.95	100	41	QP
94.8	35.69	-7.81	43.5	49.04	15.15	1.52	30.02	-	-	Peak
785.8	30.38	-15.62	46	27.4	27.86	4.74	29.62	-	-	Peak
869.1	31.4	-14.6	46	26.8	28.76	5.03	29.19	-	-	Peak
952.4	33.08	-12.92	46	26.32	30.44	5.14	28.82	-	-	Peak

**Note:**

1. The amplitude of spurious emissions which are attenuated by more than 20dB below the permissible value has no need to be reported.
2. Emission level (dBμV/m) = 20 log Emission level (μV/m).
3. Corrected Reading: Antenna Factor + Cable Loss + Read Level - Preamp Factor= Level.
4. The emission position marked as “-” means no suspected emission found and emission level has at least 6dB margin against limit or emission is noise floor only.





<b>Test Mode :</b>	NFC Tx with Earphone	<b>Polarization :</b>	Horizontal
--------------------	----------------------	-----------------------	------------

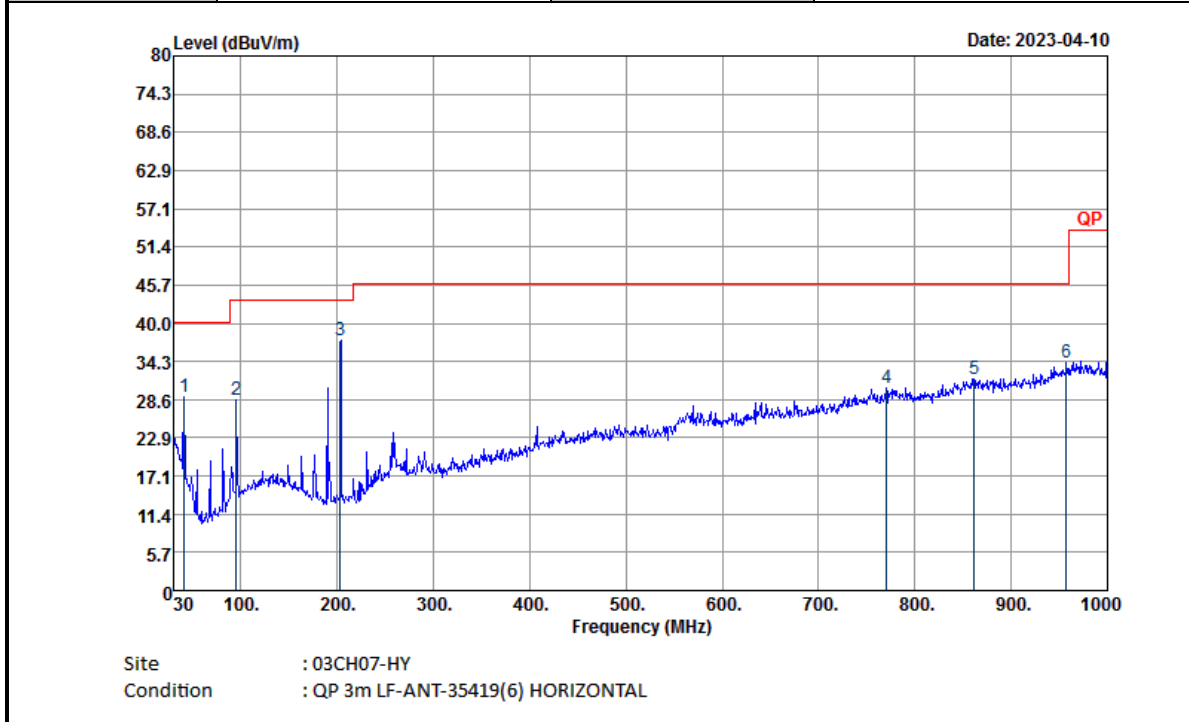

Frequency ( MHz )	Level ( dBμV/m )	Margin ( dB )	Limit Line ( dBμV/m )	Read Level ( dBμV )	Antenna Factor ( dB )	Cable Loss ( dB )	Preamp Factor ( dB )	Ant Pos ( cm )	Table Pos ( deg )	Remark
40.8	28.93	-11.07	40	38.53	18.99	1.36	29.95	-	-	Peak
94.8	28.5	-15	43.5	41.85	15.15	1.52	30.02	-	-	Peak
203.34	37.48	-6.02	43.5	50.26	14.98	2.28	30.04	-	-	Peak
770.4	30.38	-15.62	46	27.7	27.8	4.56	29.68	-	-	Peak
861.4	31.74	-14.26	46	27.07	28.87	5.03	29.23	-	-	Peak
957.3	34.2	-11.8	46	27.21	30.64	5.14	28.79	-	-	Peak



Test Mode :	NFC Tx with Earphone	Polarization :	Vertical
-------------	----------------------	----------------	----------

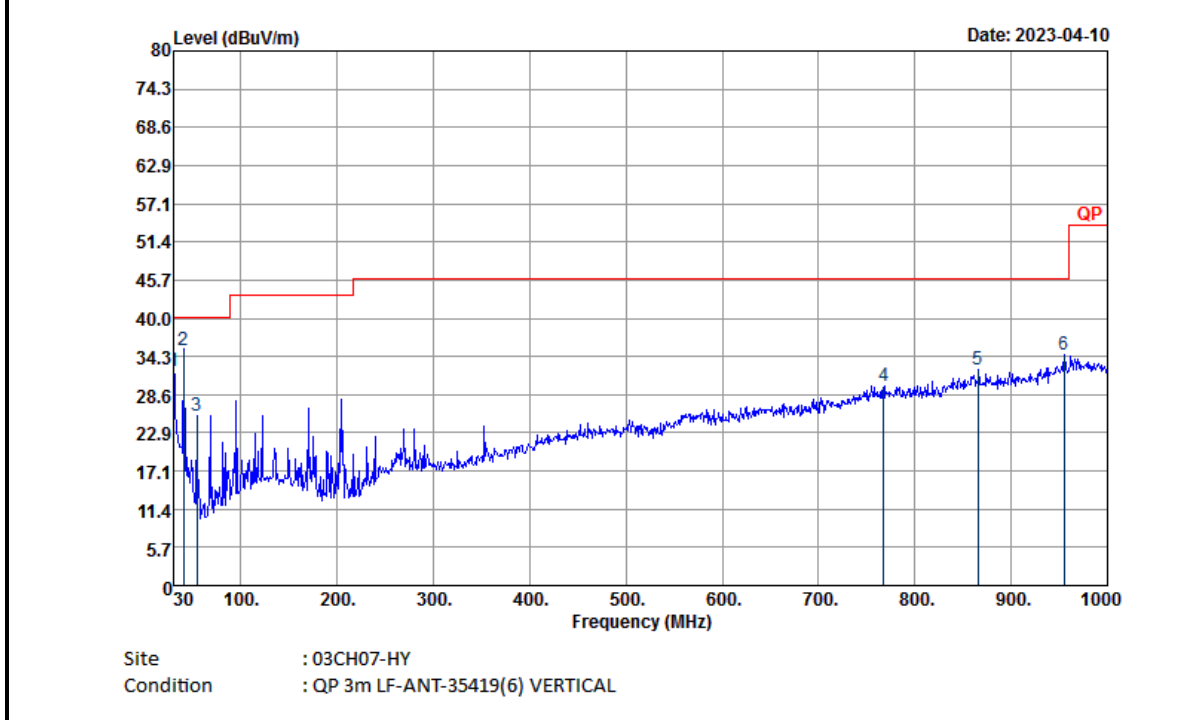

Frequency ( MHz )	Level ( dBμV/m )	Margin ( dB )	Limit Line ( dBμV/m )	Read Level (dBμV)	Antenna Factor ( dB )	Cable Loss ( dB )	Preamp Factor ( dB )	Ant Pos ( cm )	Table Pos ( deg )	Remark
30	32.2	-7.8	40	36.41	24.51	1.36	30.08	-	-	Peak
40.68	35.27	-4.73	40	44.79	19.07	1.36	29.95	100	65	QP
54.3	25.33	-14.67	40	41.49	12.61	1.36	30.13	-	-	Peak
767.6	29.89	-16.11	46	27.22	27.8	4.56	29.69	-	-	Peak
865.6	32.33	-13.67	46	27.73	28.78	5.03	29.21	-	-	Peak
955.2	34.5	-11.5	46	27.56	30.6	5.14	28.8	-	-	Peak

**Note:**

1. The amplitude of spurious emissions which are attenuated by more than 20dB below the permissible value has no need to be reported.
2. Emission level (dBμV/m) = 20 log Emission level (μV/m).
3. Corrected Reading: Antenna Factor + Cable Loss + Read Level - Preamp Factor= Level.
4. The emission position marked as “-” means no suspected emission found and emission level has at least 6dB margin against limit or emission is noise floor only.

————THE END————