



# FCC RADIO TEST REPORT

**FCC ID** : A4RGE2AE  
**Equipment** : Phone  
**Applicant** : Google LLC  
1600 Amphitheatre Parkway,  
Mountain View, California, 94043 USA  
**Standard** : FCC Part 15 Subpart C §15.247

The product was received on Mar. 17, 2022 and testing was performed from Mar. 23, 2022 to Apr. 29, 2022. We, Sporton International Inc. Wensan Laboratory, would like to declare that the tested sample has been evaluated in accordance with the test procedures and has been in compliance with the applicable technical standards.

The test results in this report apply exclusively to the tested model / sample. Without written approval from Sporton International Inc. Wensan Laboratory, the test report shall not be reproduced except in full.

Approved by: Louis Wu

**Sporton International Inc. Wensan Laboratory**

No.58, Aly. 75, Ln. 564, Wenhua 3rd, Rd., Guishan Dist., Taoyuan City 333010, Taiwan (R.O.C.)



## Table of Contents

|  |           |
|--|-----------|
| History of this test report.....                                 | 3         |
| Summary of Test Result.....                                      | 4         |
| <b>1 General Description .....</b>                               | <b>5</b>  |
| 1.1 Product Feature of Equipment Under Test.....                 | 5         |
| 1.2 Product Specification of Equipment Under Test.....           | 6         |
| 1.3 Modification of EUT .....                                    | 6         |
| 1.4 Testing Location .....                                       | 7         |
| 1.5 Applicable Standards.....                                    | 7         |
| <b>2 Test Configuration of Equipment Under Test .....</b>        | <b>8</b>  |
| 2.1 Carrier Frequency and Channel .....                          | 8         |
| 2.2 Test Mode.....   | 9         |
| 2.3 Connection Diagram of Test System.....                       | 10        |
| 2.4 Support Unit used in test configuration and system .....     | 11        |
| 2.5 EUT Operation Test Setup .....                               | 11        |
| 2.6 Measurement Results Explanation Example.....                 | 12        |
| <b>3 Test Result .....</b>                                       | <b>13</b> |
| 3.1 6dB and 99% Bandwidth Measurement .....                      | 13        |
| 3.2 Output Power Measurement.....                                | 16        |
| 3.3 Power Spectral Density Measurement .....                     | 17        |
| 3.4 Conducted Band Edges and Spurious Emission Measurement ..... | 21        |
| 3.5 Radiated Band Edges and Spurious Emission Measurement .....  | 56        |
| 3.6 AC Conducted Emission Measurement.....                       | 61        |
| 3.7 Antenna Requirements .....                                   | 63        |
| <b>4 List of Measuring Equipment.....</b>                        | <b>65</b> |
| <b>5 Uncertainty of Evaluation .....</b>                         | <b>67</b> |
| <b>Appendix A. Conducted Test Results</b>                        |           |
| <b>Appendix B. AC Conducted Emission Test Result</b>             |           |
| <b>Appendix C. Radiated Spurious Emission</b>                    |           |
| <b>Appendix D. Radiated Spurious Emission Plots</b>              |           |
| <b>Appendix E. Duty Cycle Plots</b>                              |           |
| <b>Appendix F. Setup Photographs</b>                             |           |



### History of this test report

| Report No.   | Version | Description   | Issue Date    |
|--------------|---------|---|---------------|
| FR102919-05C | 01      | Initial issue of report   | May 24, 2022  |
| FR102919-05C | 02      | 1. Add remark in section 2.2<br>2. Revise Table of Contents and Antenna Type.<br>3. Revise 3.1.5, 3.3.5 and 3.4.5 | Jun. 02, 2022 |
| FR102919-05C | 03      | Revise Test Mode  | Jun. 06, 2022 |
|              |         |   |               |
|              |         |   |               |
|              |         |   |               |
|              |         |   |               |
|              |         |   |               |
|              |         |   |               |
|              |         |   |               |
|              |         |   |               |
|              |         |   |               |
|              |         |   |               |
|              |         |   |               |
|              |         |   |               |
|              |         |   |               |



### Summary of Test Result

| Report Clause | Ref Std. Clause    | Test Items   | Result (PASS/FAIL) | Remark                                |
|---------------|--------------------|--|--------------------|---------------------------------------|
| 3.1           | 15.247(a)(2)       | 6dB Bandwidth                                      | Pass               | -                                     |
| 3.1           | 2.1049             | 99% Occupied Bandwidth                             | Reporting only     | -                                     |
| 3.2           | 15.247(b)          | Power Output Measurement                           | Pass               | -                                     |
| 3.3           | 15.247(e)          | Power Spectral Density                             | Pass               | -                                     |
| 3.4           | 15.247(d)          | Conducted Band Edges                               | Pass               | -                                     |
|               |                    | Conducted Spurious Emission                        | Pass               | -                                     |
| 3.5           | 15.247(d)          | Radiated Band Edges and Radiated Spurious Emission | Pass               | 1.62 dB under the limit at 2486.8 MHz |
| 3.6           | 15.207             | AC Conducted Emission                              | Pass               | 19.18 dB under the limit at 0.155 MHz |
| 3.7           | 15.203 & 15.247(b) | Antenna Requirement                                | Pass               | -                                     |

**Declaration of Conformity:**

1. The test results (PASS/FAIL) with all measurement uncertainty excluded are presented in accordance with the regulation limits or requirements declared by manufacturers. It's means measurement values may risk exceeding the limit of regulation standards, if measurement uncertainty is include in test results.
2. The measurement uncertainty please refer to this report "Uncertainty of Evaluation".

**Comments and Explanations:**

The product specifications of the EUT presented in the report are declared by the manufacturer who shall take full responsibility for the authenticity.

**Reviewed by: William Chen**

**Report Producer: Kaye Yang**



# 1 General Description

## 1.1 Product Feature of Equipment Under Test

| Product Feature                 |   |
|---------------------------------|---|
| Equipment                       | Phone   |
| FCC ID                          | A4RGE2AE  |
| EUT supports Radios application | GSM/EGPRS/WCDMA/HSPA/LTE/5G NR/<br>NFC/GNSS/WPC/WPT/UWB<br>WLAN 11b/g/n HT20<br>WLAN 11a/n HT20/HT40<br>WLAN 11ac VHT20/VHT40/VHT80/VHT160<br>WLAN 11ax HE20/HE40/HE80/HE160<br>Bluetooth BR/EDR/LE |

**Remark:** The above EUT's information was declared by manufacturer.

| EUT Information List |                            |
|----------------------|----------------------------|
| S/N                  | Performed Test Item        |
| 23061FDH300012       | RF Conducted Measurement   |
| 22271FDH30000A       | Radiated Spurious Emission |
| 22271FDH30000P       | Conducted Emission         |



### 1.2 Product Specification of Equipment Under Test

| Product Specification is subject to this standard |   |        |        |        |         |   |   |                       |   |   |
|---|---|--------|--------|--------|---------|---|---|-----------------------|---|---|
| <b>Tx/Rx Channel Frequency Range</b>              | 2412 MHz ~ 2472 MHz   |        |        |        |         |   |   |                       |   |   |
| <b>Maximum (Average) Output Power to antenna</b>  | <p>&lt;Ant. 4&gt;<br/>802.11b : 22.85 dBm (0.1929 W)</p> <p>&lt;Ant. 3&gt;<br/>802.11b : 22.95 dBm (0.1972 W)</p> <p><b>MIMO &lt;Ant. 4+3&gt;</b><br/>802.11g : 25.42 dBm (0.3483 W)<br/>802.11n HT20 : 25.36 dBm (0.3436 W)<br/>802.11 ac VHT20 : 25.46 dBm (0.3516 W)<br/>802.11 ax HE20 : 25.56 dBm (0.3597 W)</p> |        |        |        |         |   |   |                       |   |   |
| <b>99% Occupied Bandwidth</b>                     | <p>&lt;Ant. 4&gt;<br/>802.11b : 13.54 MHz</p> <p>&lt;Ant. 3&gt;<br/>802.11b : 13.54 MHz</p> <p><b>MIMO &lt;Ant. 4&gt;</b><br/>802.11g : 18.98 MHz<br/>802.11 ax HE20 : 20.23 MHz</p> <p><b>MIMO &lt;Ant. 3&gt;</b><br/>802.11g : 18.53 MHz<br/>802.11 ax HE20 : 20.13 MHz</p>   |        |        |        |         |   |   |                       |   |   |
| <b>Antenna Type / Gain</b>                        | <p>&lt;Ant. 4&gt;: ILA Antenna with gain -1.6 dBi<br/>&lt;Ant. 3&gt;: IFA Antenna with gain -0.4 dBi</p>  |        |        |        |         |   |   |                       |   |   |
| <b>Type of Modulation</b>                         | <p>802.11b : DSSS (DBPSK / DQPSK / CCK)<br/>802.11g/n : OFDM (BPSK / QPSK / 16QAM / 64QAM)<br/>802.11ac : OFDM (BPSK / QPSK / 16QAM / 64QAM / 256QAM)<br/>802.11ax:<br/>OFDMA (BPSK/QPSK/16QAM/64QAM/256QAM/1024QAM)</p>  |        |        |        |         |   |   |                       |   |   |
| <b>Antenna Function for Transmitter</b>           | <table border="1"> <thead> <tr> <th></th> <th>Ant. 4</th> <th>Ant. 3</th> </tr> </thead> <tbody> <tr> <td>802.11b</td> <td>V</td> <td>V</td> </tr> <tr> <td>802.11 g/n/ac/ax MIMO</td> <td>V</td> <td>V</td> </tr> </tbody> </table>  |        | Ant. 4 | Ant. 3 | 802.11b | V | V | 802.11 g/n/ac/ax MIMO | V | V |
|   | Ant. 4  | Ant. 3 |        |        |         |   |   |                       |   |   |
| 802.11b   | V   | V      |        |        |         |   |   |                       |   |   |
| 802.11 g/n/ac/ax MIMO                             | V   | V      |        |        |         |   |   |                       |   |   |

**Remark:**

- MIMO Ant. 4+3 Directional Gain is a calculated result from MIMO Ant. 4 and MIMO Ant. 3. The formula used in calculation is documented in section 3.7.
- Power of MIMO Ant. 4 + Ant. 3 is a calculated result from sum of the power MIMO Ant. 4 and MIMO Ant. 3.
- The above EUT's information was declared by manufacturer. Please refer to Comments and Explanations in report summary.

### 1.3 Modification of EUT

No modifications made to the EUT during the testing.



### 1.4 Testing Location

|                           |   |
|---------------------------|---|
| <b>Test Site</b>          | Sporton International Inc. EMC & Wireless Communications Laboratory   |
| <b>Test Site Location</b> | No.52, Huaya 1st Rd., Guishan Dist.,<br>Taoyuan City 333, Taiwan (R.O.C.)<br>TEL: +886-3-327-3456<br>FAX: +886-3-328-4978 |
| <b>Test Site No.</b>      | <b>Sporton Site No.</b><br>CO05-HY (TAF Code:1190)  |
| <b>Remark</b>             | The Conducted Emission test item subcontracted to Sporton International Inc. EMC & Wireless Communications Laboratory.    |

Note: The test site complies with ANSI C63.4 2014 requirement.

|                           |  |
|---------------------------|--|
| <b>Test Site</b>          | Sporton International Inc. Wensan Laboratory   |
| <b>Test Site Location</b> | No.58, Aly. 75, Ln. 564, Wenhua 3rd, Rd., Guishan Dist.,<br>Taoyuan City 333010, Taiwan (R.O.C.)<br>TEL: +886-3-327-0868<br>FAX: +886-3-327-0855 |
| <b>Test Site No.</b>      | <b>Sporton Site No.</b><br>TH05-HY, 03CH20-HY  |

Note: The test site complies with ANSI C63.4 2014 requirement.

FCC designation No.: TW1190 and TW3786

### 1.5 Applicable Standards

According to the specifications declared by the manufacturer, the EUT must comply with the requirements of the following standards:

- ♦ FCC Part 15 Subpart C §15.247
- ♦ FCC KDB Publication No. 558074 D01 DTS Meas. Guidance v05r02
- ♦ FCC KDB 414788 D01 Radiated Test Site v01r01.
- ♦ FCC KDB 662911 D01 Multiple Transmitter Output v02r01.
- ♦ ANSI C63.10-2013

**Remark:**

1. All the test items were validated and recorded in accordance with the standards without any modification during the testing.
2. The TAF code is not including all the FCC KDB listed without accreditation.



## 2 Test Configuration of Equipment Under Test

- a. The EUT has been associated with peripherals and configuration operated in a manner tended to maximize its emission characteristics in a typical application. Frequency range investigated: conduction emission (150 kHz to 30 MHz), radiation emission (9 kHz to the 10th harmonic of the highest fundamental frequency or to 40 GHz, whichever is lower). For radiated measurement, the measured emission level of the EUT was maximized by rotating the EUT on a turntable, adjusting the orientation of the EUT and EUT antenna in three orthogonal axis (X: flat, Y: portrait, Z: landscape) and accessory (Adapter or Earphone), and adjusting the measurement antenna orientation, following C63.10 exploratory test procedures and find X plane with Adapter as worst plane.
  
- b. AC power line Conducted Emission was tested under maximum output power.

### 2.1 Carrier Frequency and Channel

| Frequency Band  | Channel | Freq. (MHz) | Channel | Freq. (MHz) |
|-----------------|---------|-------------|---------|-------------|
| 2400-2483.5 MHz | 1       | 2412        | 8       | 2447        |
|                 | 2       | 2417        | 9       | 2452        |
|                 | 3       | 2422        | 10      | 2457        |
|                 | 4       | 2427        | 11      | 2462        |
|                 | 5       | 2432        | 12      | 2467        |
|                 | 6       | 2437        | 13      | 2472        |
|                 | 7       | 2442        |         |             |





## 2.2 Test Mode

This device support 26/52/106-tone RU.

The PSD of partial RU is reduced to be smaller than full RU according to TCBC workshop interim guidance Oct., 2018.

The CDD mode is chosen as worst case configuration for all test cases due to higher power than SISO mode.

The power level of each chain in MIMO mode is equal or higher than SISO mode.

The final test modes consider the modulation and the worst data rates as shown in the table below.

### Single Antenna

| Modulation | Data Rate |
|------------|-----------|
| 802.11b    | 1 Mbps    |

### MIMO Antenna

| Modulation                       | Data Rate |
|----------------------------------|-----------|
| 802.11g                          | 6 Mbps    |
| 802.11n HT20 (Covered by HE20)   | MCS0      |
| 802.11ac VHT20 (Covered by HE20) | MCS0      |
| 802.11ax HE20                    | MCS0      |

| Test Cases  |   |
|---|---|
| <b>AC<br/>Conducted<br/>Emission</b>  | Mode 1 :GSM850 Idle + WLAN (2.4GHz) Link + Bluetooth Link + USB Cable 1<br>(Charging from AC Adapter 2) |
| <b>Remark:</b>  |   |
| <ol style="list-style-type: none"> <li>For Radiated Test Cases, the tests were performed with Adapter 2 and USB Cable 1.</li> <li>During the preliminary test, both charging modes (Adapter mode and WPT Charging mode) were verified. It is determined that the adaptor mode is the worst case for official test.</li> </ol> |   |

| Ch. #  | 2400-2483.5 MHz |         |               |
|--------|-----------------|---------|---------------|
|        | 802.11b         | 802.11g | 802.11ax HE20 |
| Low    | 01              | 01      | 01            |
| Middle | 06              | 06      | 06            |
| High   | 11              | 11      | 11            |
|        | 12              | 12      | 12            |
|        | 13              | 13      | 13            |

**Remark:** For radiation spurious emission, the modulation and the data rate picked for testing are determined by the Max. RF conducted power.

### 2.3 Connection Diagram of Test System

<AC Conducted Emission Mode>

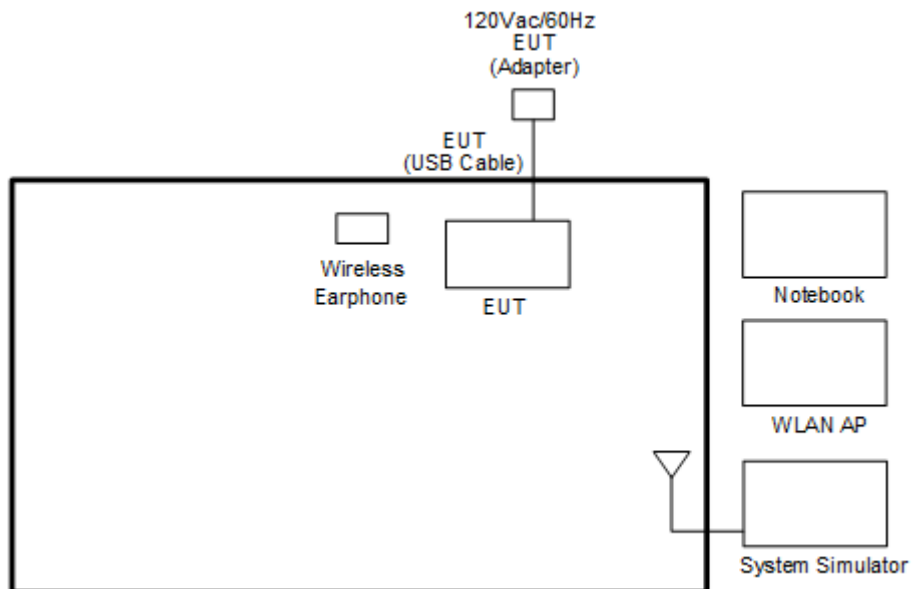

<WLAN Tx Mode>

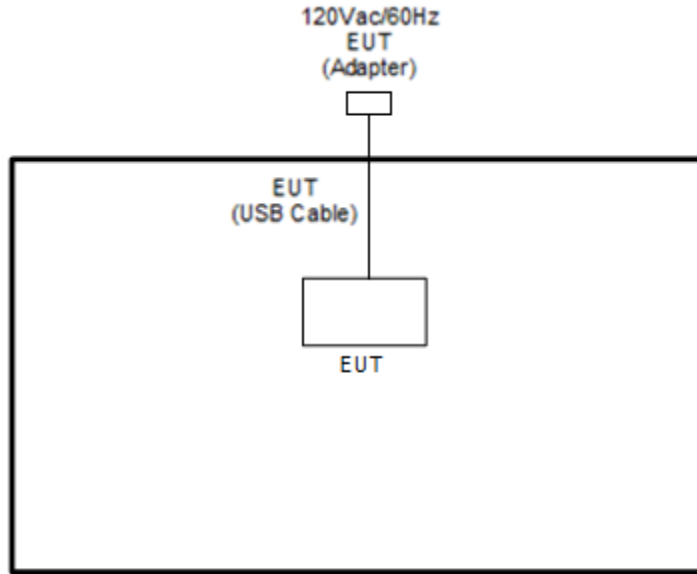

## 2.4 Support Unit used in test configuration and system

| Item | Equipment         | Brand Name | Model Name    | FCC ID                | Data Cable | Power Cord   |
|------|-------------------|------------|---------------|-----------------------|------------|--|
| 1.   | System Simulator  | Anritsu    | MT8820C       | N/A                   | N/A        | Unshielded, 1.8 m  |
| 2.   | Wireless Earphone | Google     | G1007/G1008   | A4RG1007/<br>A4RG1008 | N/A        | N/A  |
| 3.   | WLAN AP           | ASUS       | RT-AC66U      | MSQ-RTAC66U           | N/A        | Unshielded, 1.8 m  |
| 4.   | Notebook          | Dell       | Latitude 3400 | FCC DoC               | N/A        | AC I/P :<br>Unshielded, 1.2m<br>DC O/P :<br>Shielded, 1.8m |

## 2.5 EUT Operation Test Setup

The RF test items, utility “cmd 10.0.17134.1304” was installed in Notebook which was programmed in order to make the EUT get into the engineering modes to provide channel selection, power level, data rate and the application type and for continuous transmitting signals.



## 2.6 Measurement Results Explanation Example

For all conducted test items:

The offset level is set in the spectrum analyzer to compensate the RF cable loss and attenuator factor between EUT conducted output port and spectrum analyzer. With the offset compensation, the spectrum analyzer reading level is exactly the EUT RF output level.

Example:

The spectrum analyzer offset is derived from RF cable loss and attenuator factor.

*Offset = RF cable loss + attenuator factor.*

Following shows an offset computation example with cable loss 4.2 dB and 10 dB attenuator.

$$\begin{aligned} \text{Offset}(dB) &= \text{RF cable loss}(dB) + \text{attenuator factor}(dB). \\ &= 4.2 + 10 = 14.2 \text{ (dB)} \end{aligned}$$

### 3 Test Result

#### 3.1 6dB and 99% Bandwidth Measurement

##### 3.1.1 Limit of 6dB and 99% Bandwidth

The minimum 6 dB bandwidth shall be at least 500 kHz.

##### 3.1.2 Measuring Instruments

Please refer to the measuring equipment list in this test report.

##### 3.1.3 Test Procedures

1. The testing follows the ANSI C63.10 Section 6.9.3 (OBW) and 11.8.1 (6dB BW).
2. The RF output of EUT is connected to the spectrum analyzer by RF cable and attenuator. The path loss is compensated to the results for each measurement.
3. Set the maximum power setting and enable the EUT to transmit continuously.
4. Make the measurement with the spectrum analyzer's resolution bandwidth (RBW) = 100 kHz. Set the Video bandwidth (VBW) = 300 kHz. In order to make an accurate measurement. The 6 dB bandwidth must be greater than 500 kHz.
5. For 99% Bandwidth Measurement, the spectrum analyzer's resolution bandwidth (RBW) is set 1-5% of the emission bandwidth and set the Video bandwidth (VBW)  $\geq 3 * RBW$ .
6. Measure and record the results in the test report.

##### 3.1.4 Test Setup





### 3.1.5 Test Result of 6dB and 99% Occupied Bandwidth

Please refer to Appendix A.

<SISO Mode>

<Ant. 4>

<802.11b>

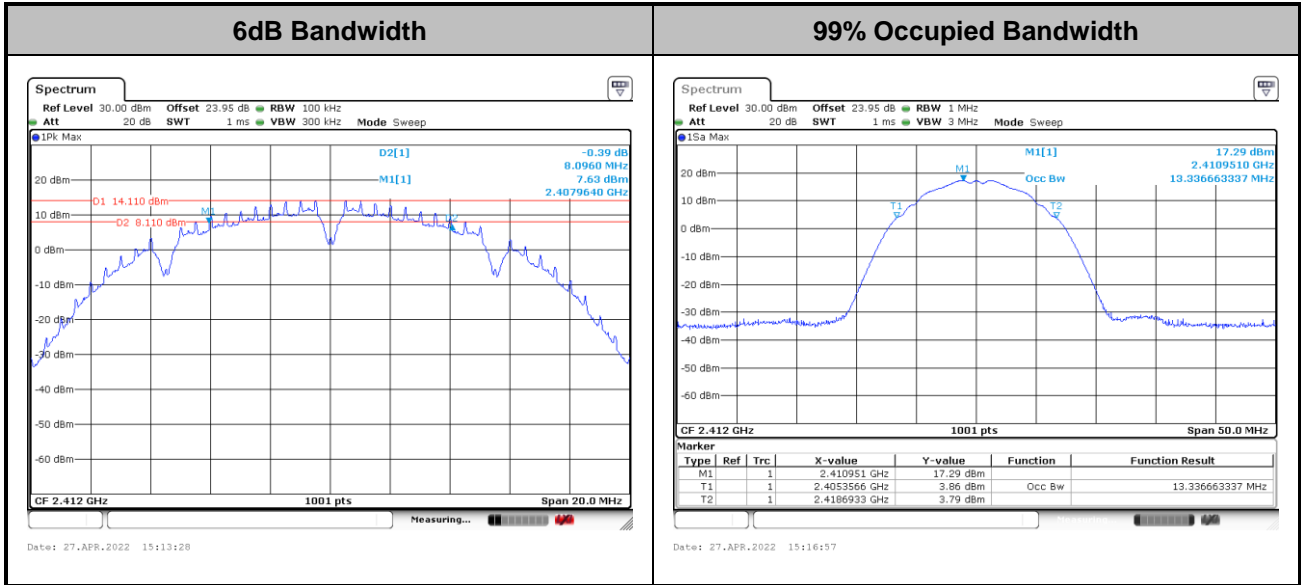

Note: The occupied channel bandwidth is maintained within the band of operation for all of the modulations.

<Ant. 3>

<802.11b>

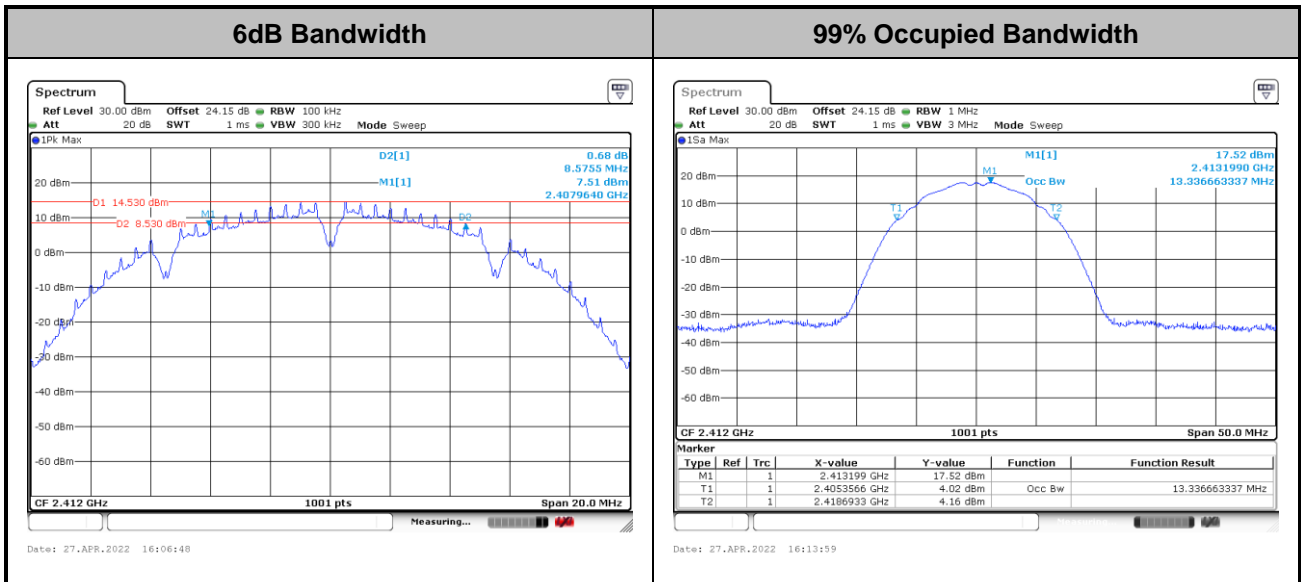

Note: The occupied channel bandwidth is maintained within the band of operation for all of the modulations.



<MIMO Mode>

<Ant. 4+3>

<802.11g>

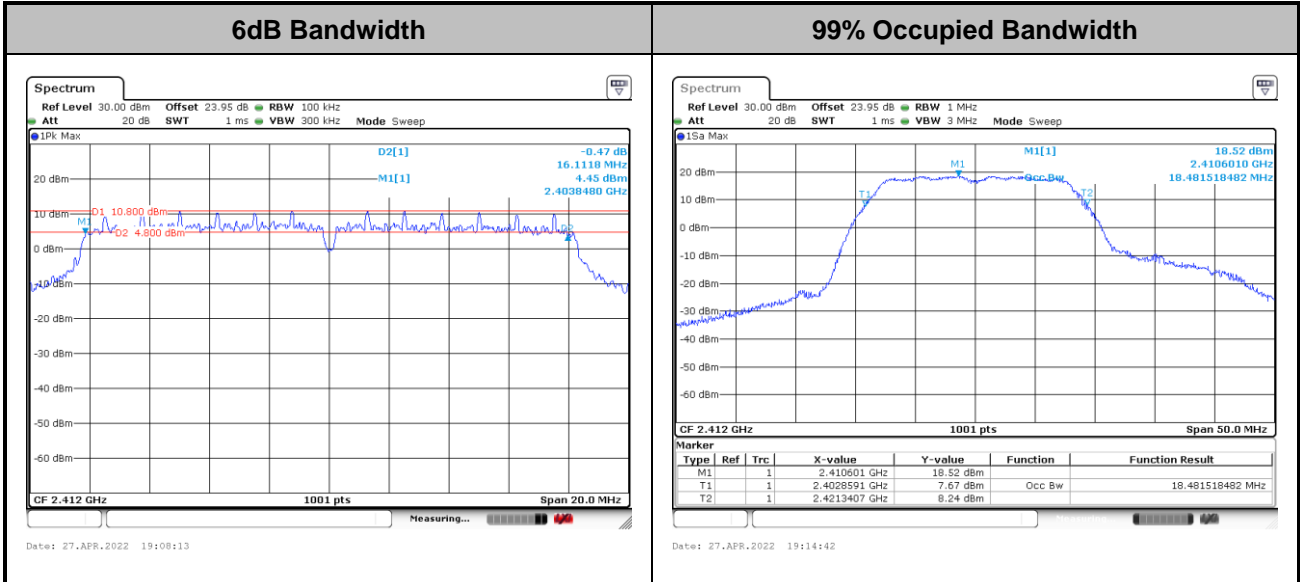

Note: The occupied channel bandwidth is maintained within the band of operation for all of the modulations.

<802.11ax HE20>

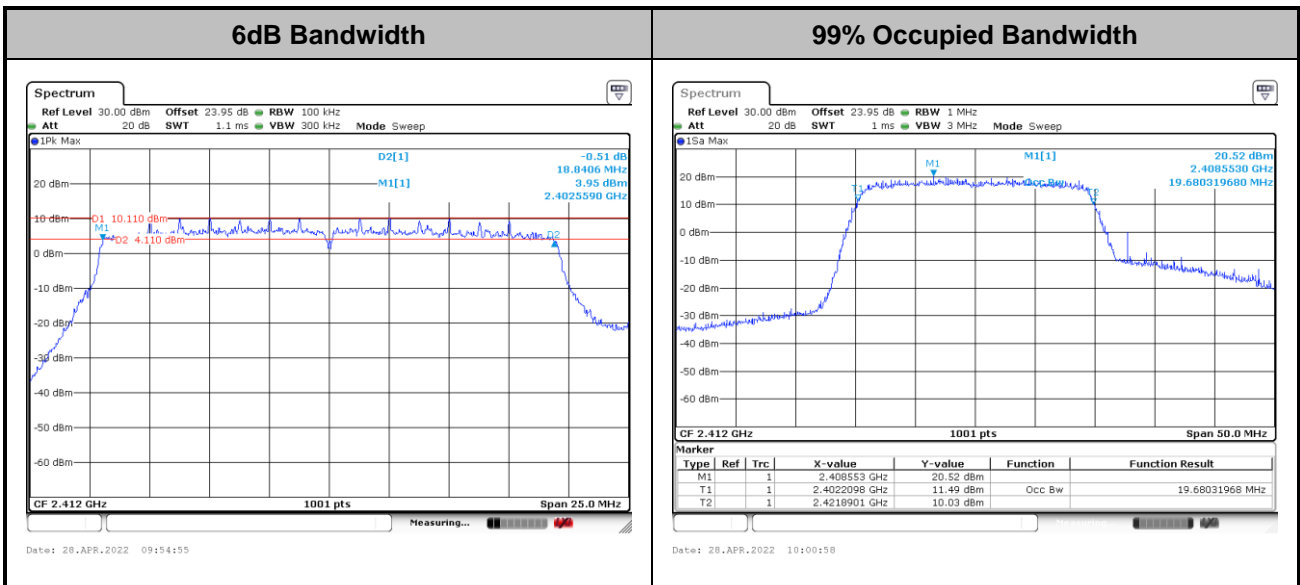

Note: The occupied channel bandwidth is maintained within the band of operation for all of the modulations.

## 3.2 Output Power Measurement

### 3.2.1 Limit of Output Power

For systems using digital modulation in the 2400-2483.5 MHz, the limit for output power is 30 dBm. If transmitting antenna with directional gain greater than 6 dBi is used, the peak output power from the intentional radiator shall be reduced below the above stated value by the amount in dB that the directional gain of the antenna exceeds 6 dBi. In case of point-to-point operation, the limit has to be reduced by 1 dB for every 3 dB that the directional gain of the antenna exceeds 6 dBi.

### 3.2.2 Measuring Instruments

Please refer to the measuring equipment list in this test report.

### 3.2.3 Test Procedures

1. For Average Power, the testing follows ANSI C63.10 Section 11.9.2.3.2 Method AVGPM-G
2. The RF output of EUT is connected to the power meter by RF cable and attenuator. The path loss is compensated to the results for each measurement.
3. Set the maximum power setting and enable the EUT to transmit continuously.
4. Measure the conducted output power and record the results in the test report.
5. For MIMO mode, calculation method follows FCC KDB 662911 D01 Multiple Transmitter Output v02r01.

### 3.2.4 Test Setup

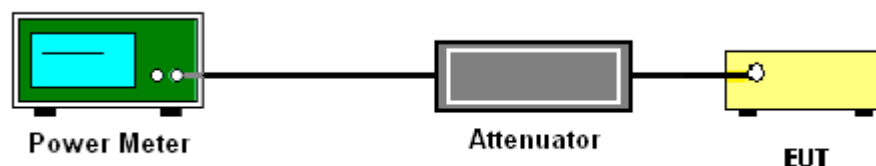

### 3.2.5 Test Result of Average Output Power

Please refer to Appendix A.





### **3.3 Power Spectral Density Measurement**

#### **3.3.1 Limit of Power Spectral Density**

The peak power spectral density shall not be greater than 8 dBm in any 3 kHz band at any time interval of continuous transmission.

#### **3.3.2 Measuring Instruments**

Please refer to the measuring equipment list in this test report.

#### **3.3.3 Test Procedures**

1. The testing follows the ANSI C63.10 Section 11.10.2 Method PKPSD.
2. The RF output of EUT is connected to the spectrum analyzer by RF cable and attenuator. The path loss is compensated to the results for each measurement.
3. Set the maximum power setting and enable the EUT to transmit continuously.
4. Make the measurement with the spectrum analyzer's resolution bandwidth (RBW) = 3 kHz. Video bandwidth VBW = 10 kHz In order to make an accurate measurement, set the span to 1.5 times DTS Channel Bandwidth. (6dB BW)
5. Detector = peak, Sweep time = auto couple, Trace mode = max hold, Allow trace to fully stabilize. Use the peak marker function to determine the maximum power level.
6. Measure and record the results in the test report.
7. For MIMO mode, calculation method follows FCC KDB 662911 D01 Multiple Transmitter Output v02r01.

If measurements performed using method (2) plus  $10 \log(N)$  exceeds the emission limit, the test should choose method (1) before declaring that the device fails the emission limit.

Method (1): Measure and sum the spectra across the outputs.

The total final Power Spectral Density is from a device with 2 transmitter outputs. The spectrum measurements of the individual outputs are all performed with the same span and number of points, the spectrum value in the first spectral bin of output 1 is summed with that in the first spectral bin of output 2 to obtain the value for the first frequency bin of the summed spectrum.

Method (2): Measure and add  $10 \log(N)$  dB, where N is the number of outputs. (N=2)

### 3.3.4 Test Setup

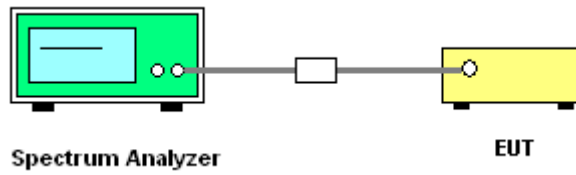

### 3.3.5 Test Result of Power Spectral Density

Please refer to Appendix A.

<SISO Mode>

<Ant. 4>

<802.11b>

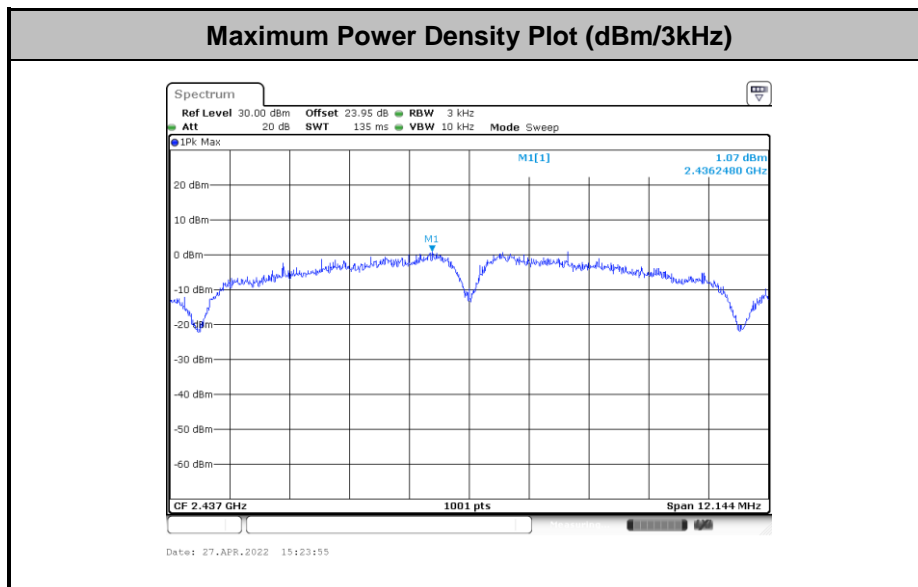



<Ant. 3>

<802.11b>

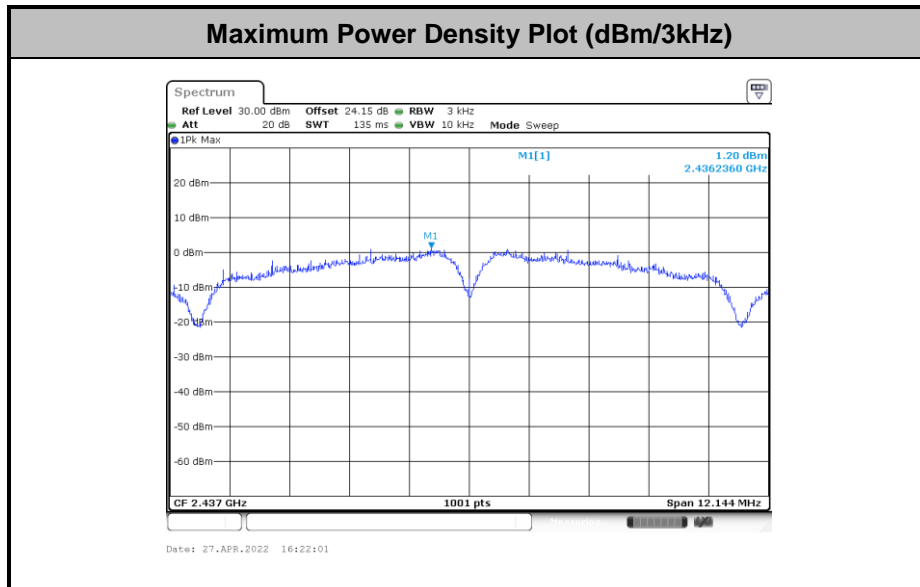



< MIMO Mode >

<802.11g>

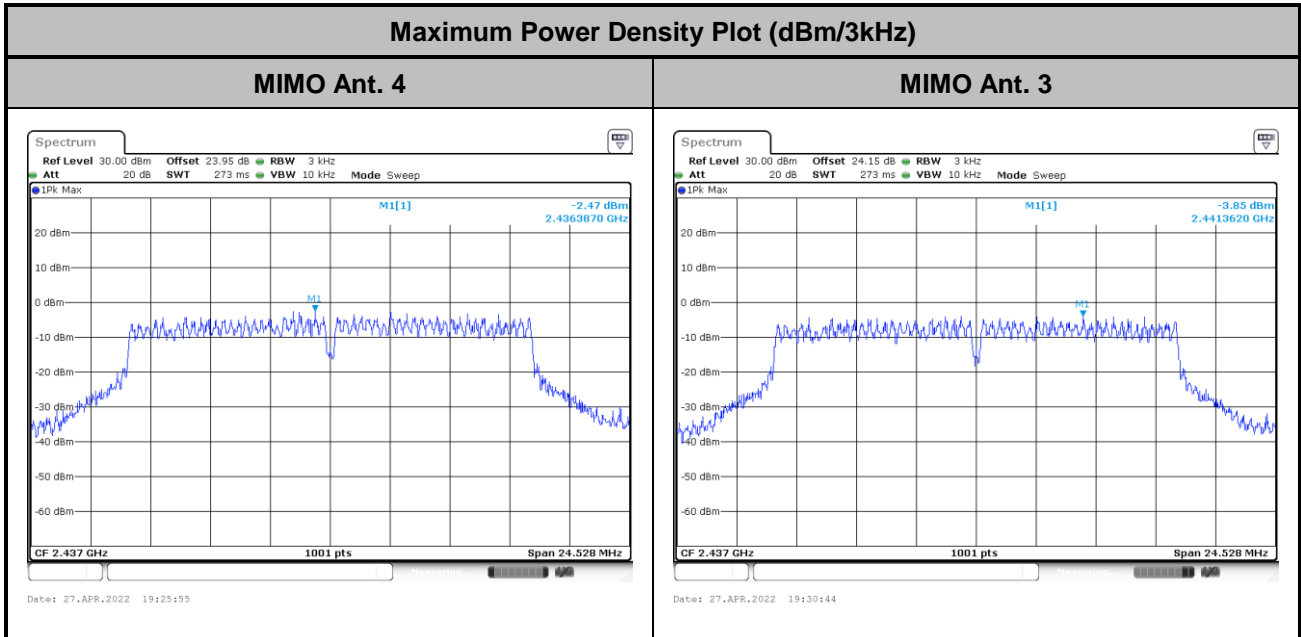

<802.11ax HE20>

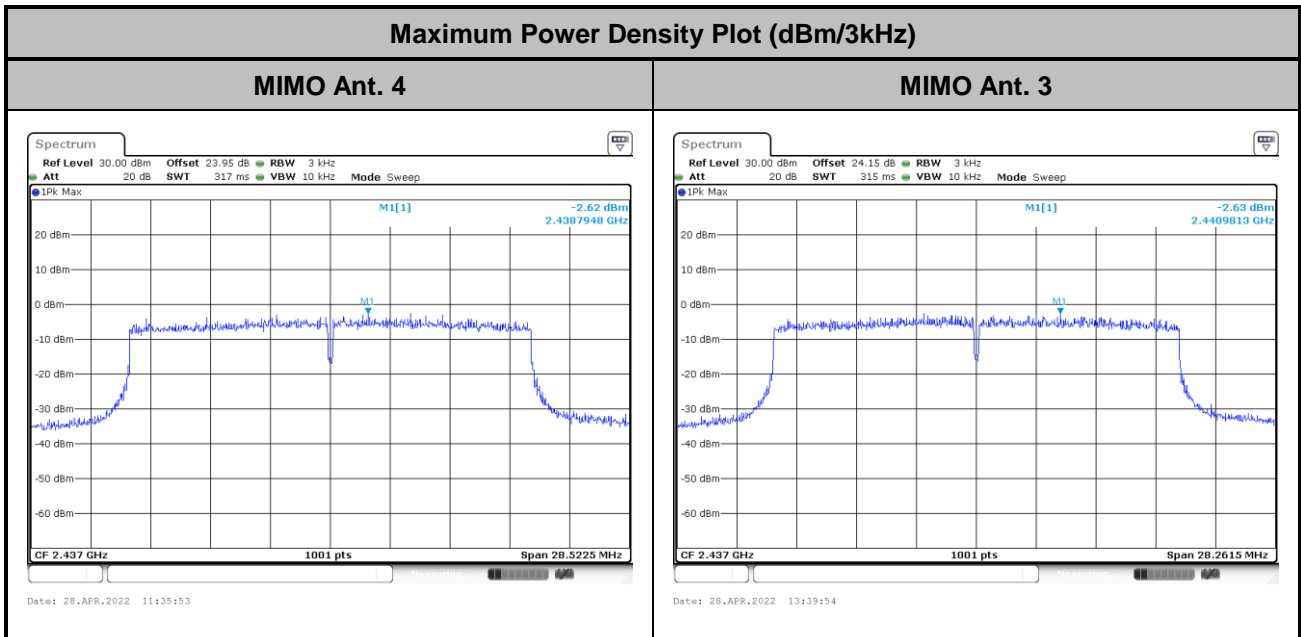

## 3.4 Conducted Band Edges and Spurious Emission Measurement

### 3.4.1 Limit of Conducted Band Edges and Spurious Emission Measurement

In any 100 kHz bandwidth outside of the authorized frequency band, the emissions which fall in the non-restricted bands shall be attenuated at least 20 dB / 30dB relative to the maximum PSD level in 100 kHz by RF conducted measurement.

### 3.4.2 Measuring Instruments

Please refer to the measuring equipment list in this test report.

### 3.4.3 Test Procedures

1. The testing follows the ANSI C63.10 Section 11.11.3 Emission level measurement.
2. The RF output of EUT is connected to the spectrum analyzer by RF cable and attenuator. The path loss is compensated to the results for each measurement.
3. Set the maximum power setting and enable the EUT to transmit continuously.
4. Set RBW = 100 kHz, VBW=300 kHz, Peak Detector. Unwanted Emissions measured in any 100 kHz bandwidth outside of the authorized frequency band shall be attenuated by at least 20 dB relative to the maximum in-band peak PSD level in 100 kHz when maximum peak conducted output power procedure is used. If the transmitter complies with the conducted power limits based on the use of RMS averaging over a time interval, the attenuation required under this paragraph shall be 30 dB instead of 20 dB per 15.247(d).
5. Measure and record the results in the test report.
6. The RF fundamental frequency should be excluded against the limit line in the operating frequency band.

### 3.4.4 Test Setup

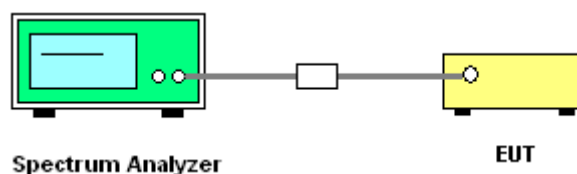



### 3.4.5 Test Result of Conducted Band Edges and Spurious Emission

Number of TX = 1, Ant. 4 (Measured)

|             |         |                |    |
|-------------|---------|----------------|----|
| Test Mode : | 802.11b | Test Channel : | 01 |
|-------------|---------|----------------|----|

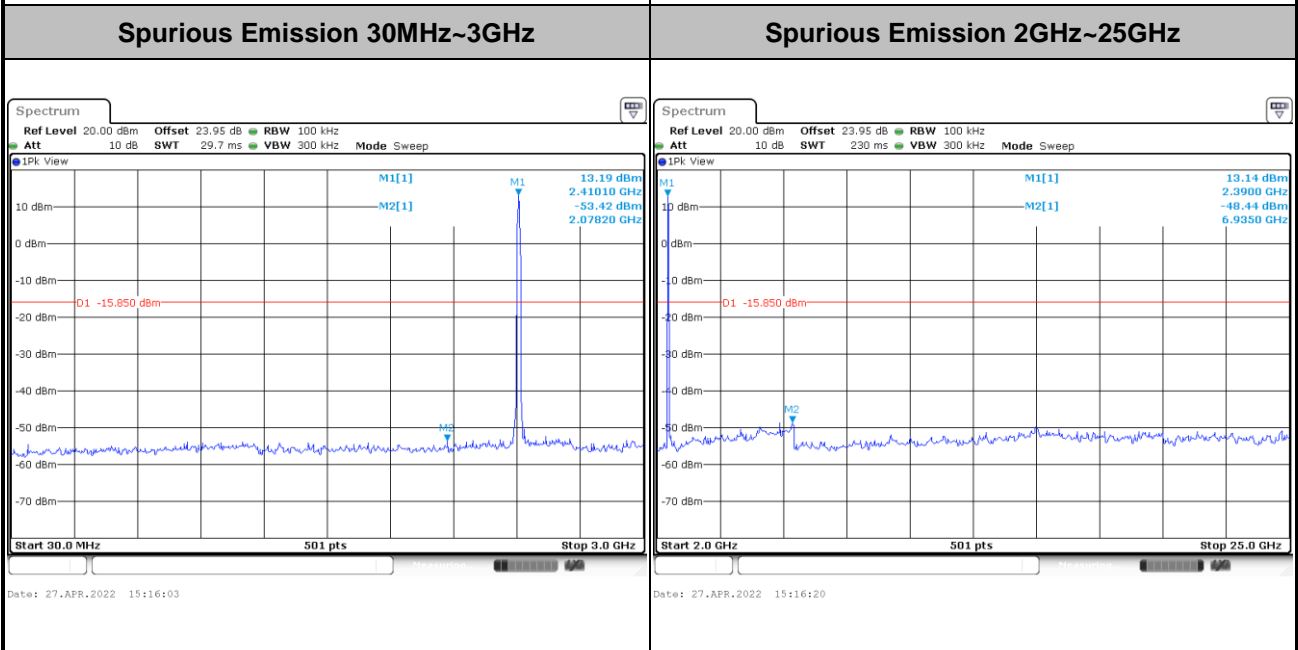
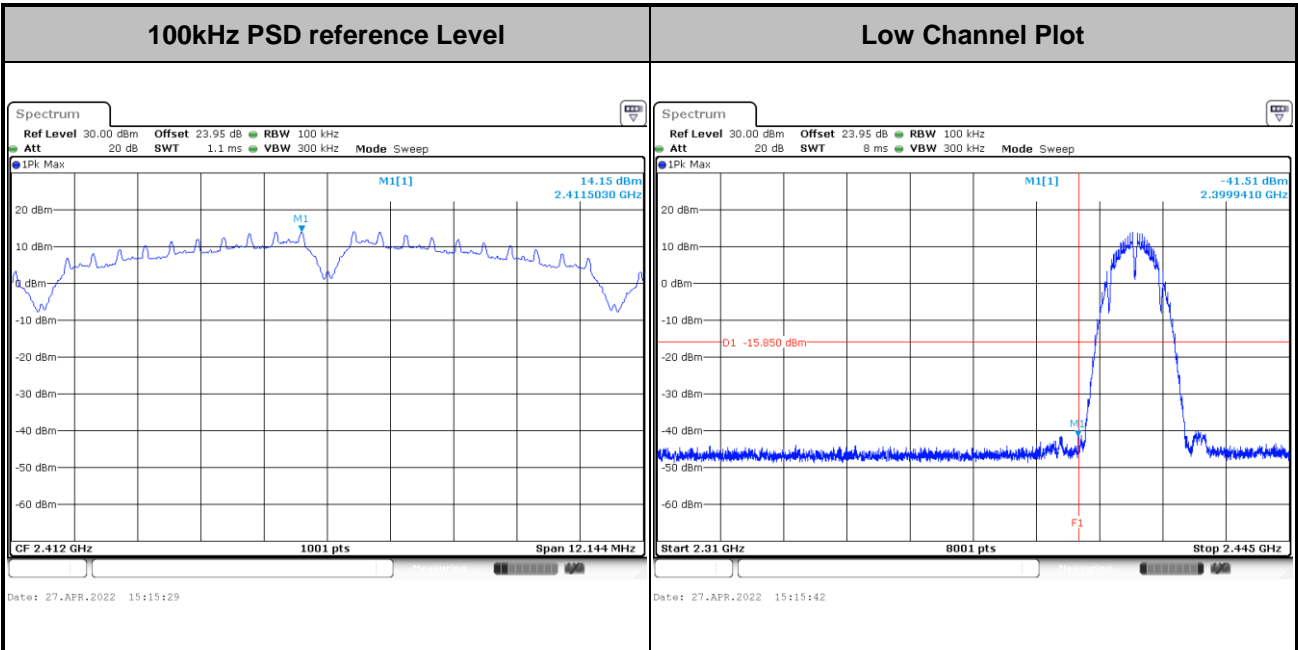



|             |         |                |    |
|-------------|---------|----------------|----|
| Test Mode : | 802.11b | Test Channel : | 06 |
|-------------|---------|----------------|----|

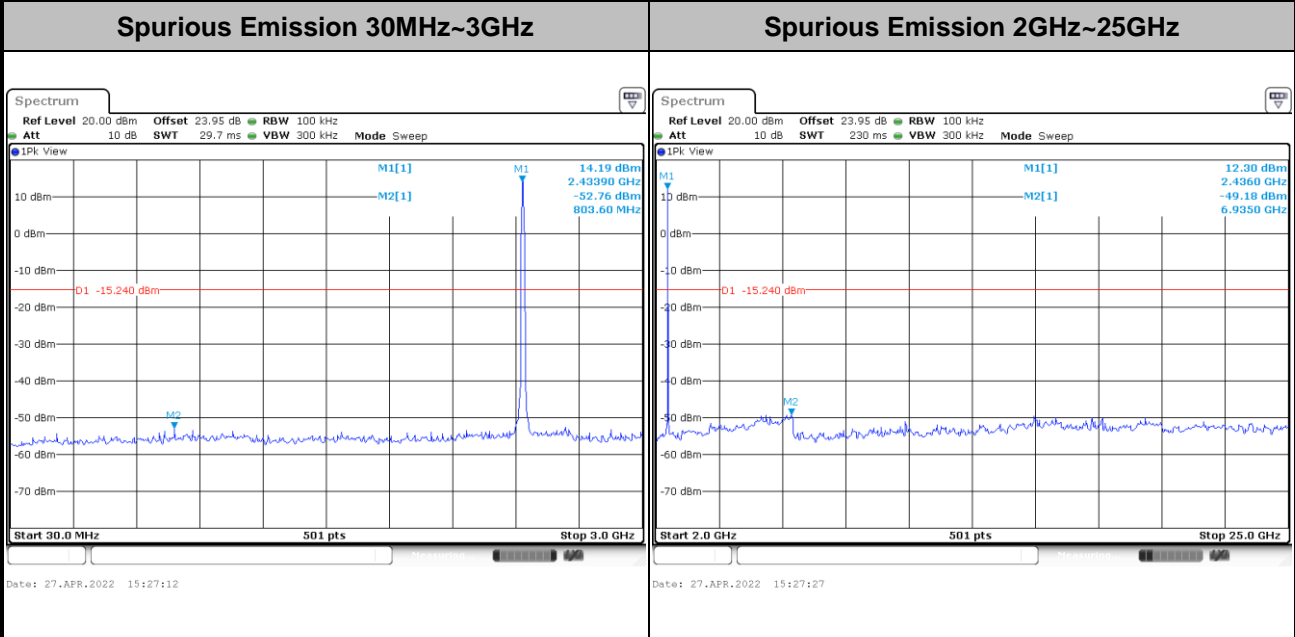
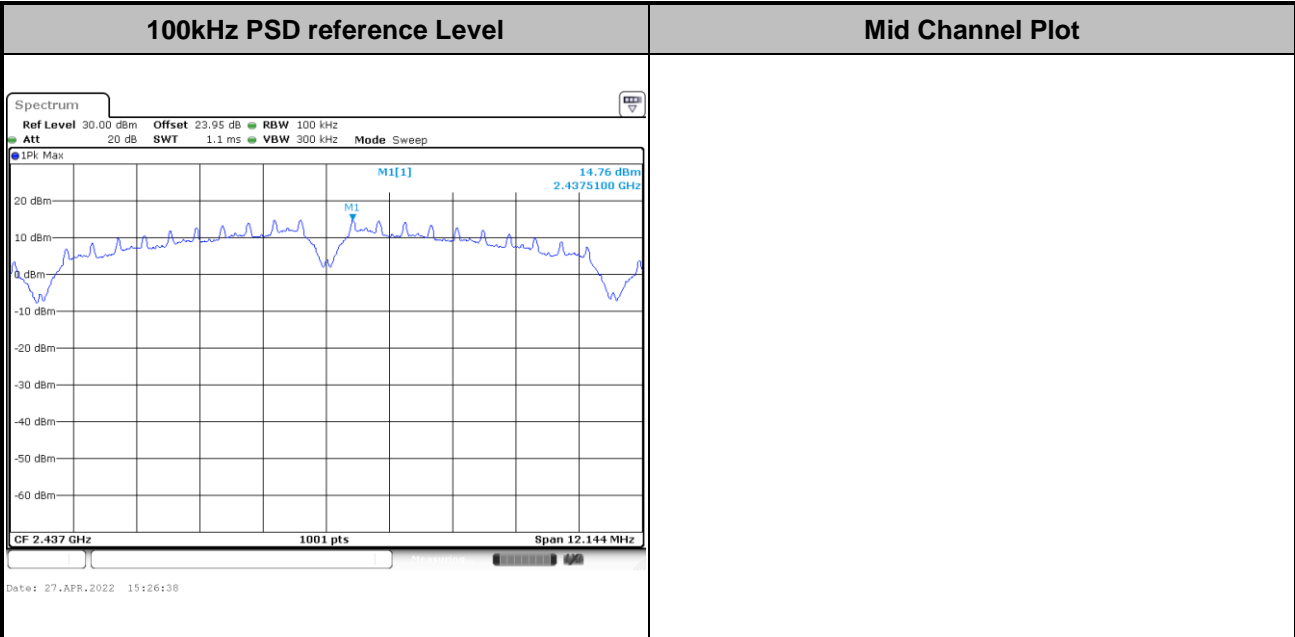



|             |         |                |    |
|-------------|---------|----------------|----|
| Test Mode : | 802.11b | Test Channel : | 11 |
|-------------|---------|----------------|----|

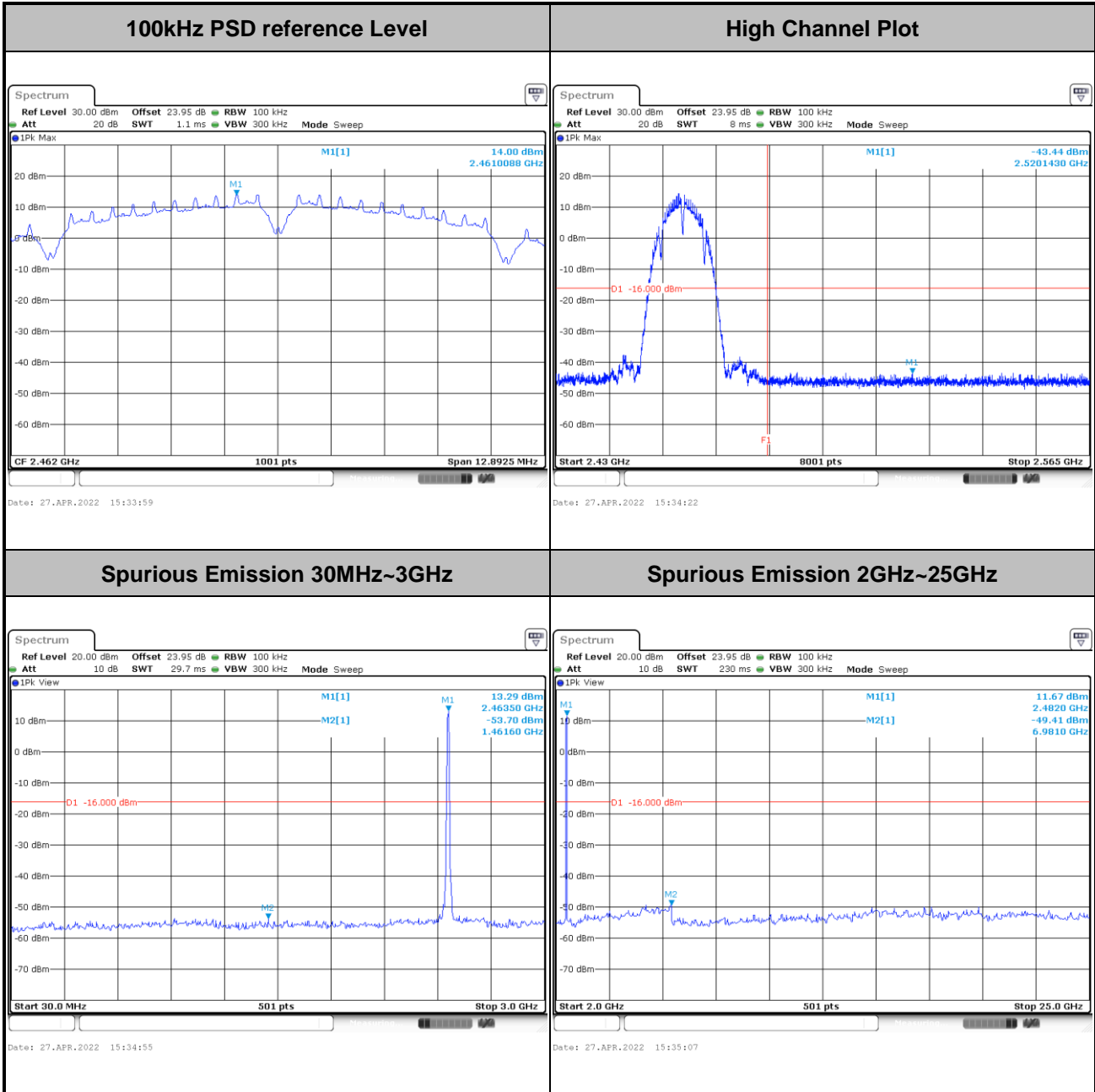





|             |         |                |    |
|-------------|---------|----------------|----|
| Test Mode : | 802.11b | Test Channel : | 12 |
|-------------|---------|----------------|----|

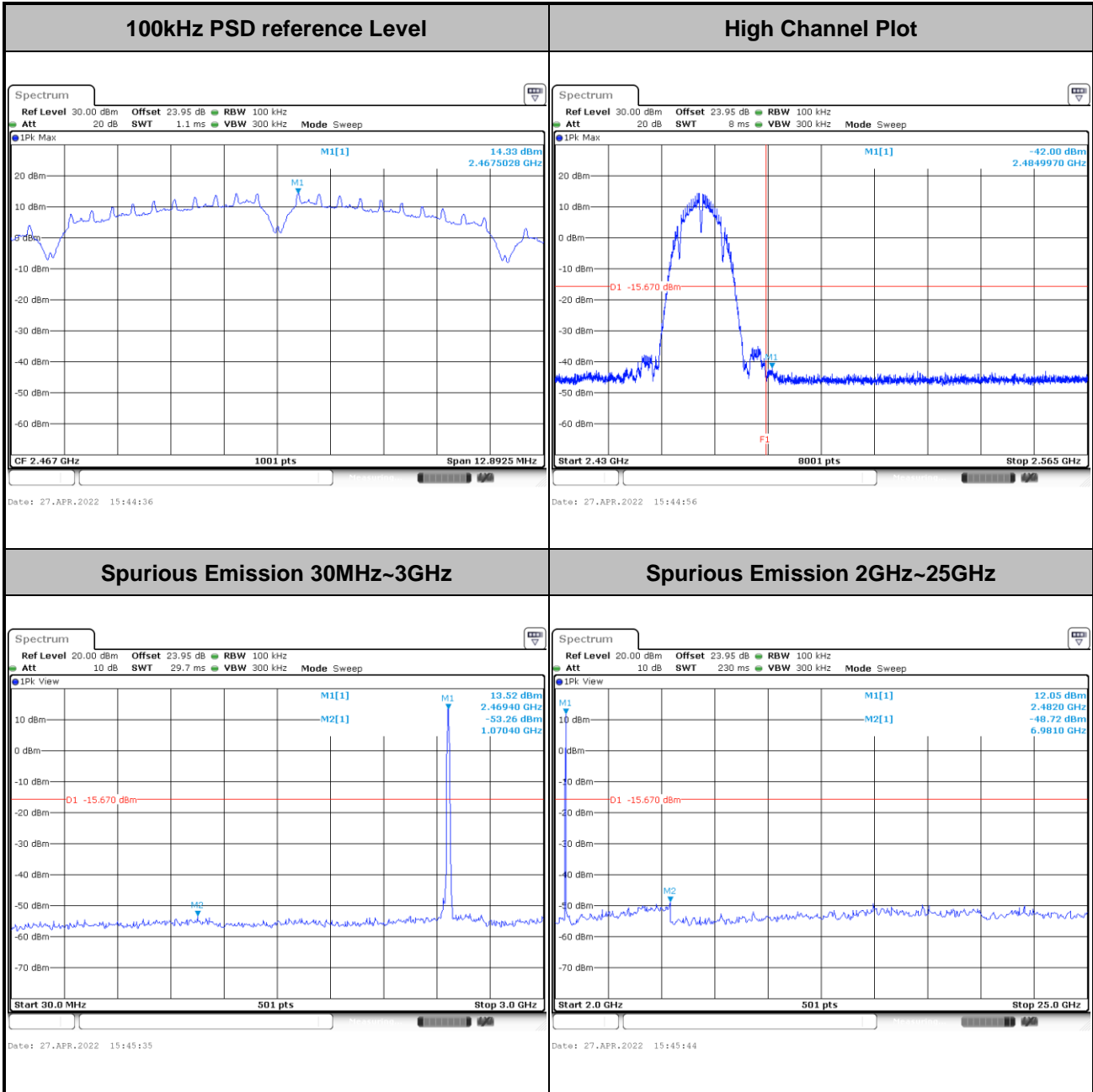



|             |         |                |    |
|-------------|---------|----------------|----|
| Test Mode : | 802.11b | Test Channel : | 13 |
|-------------|---------|----------------|----|

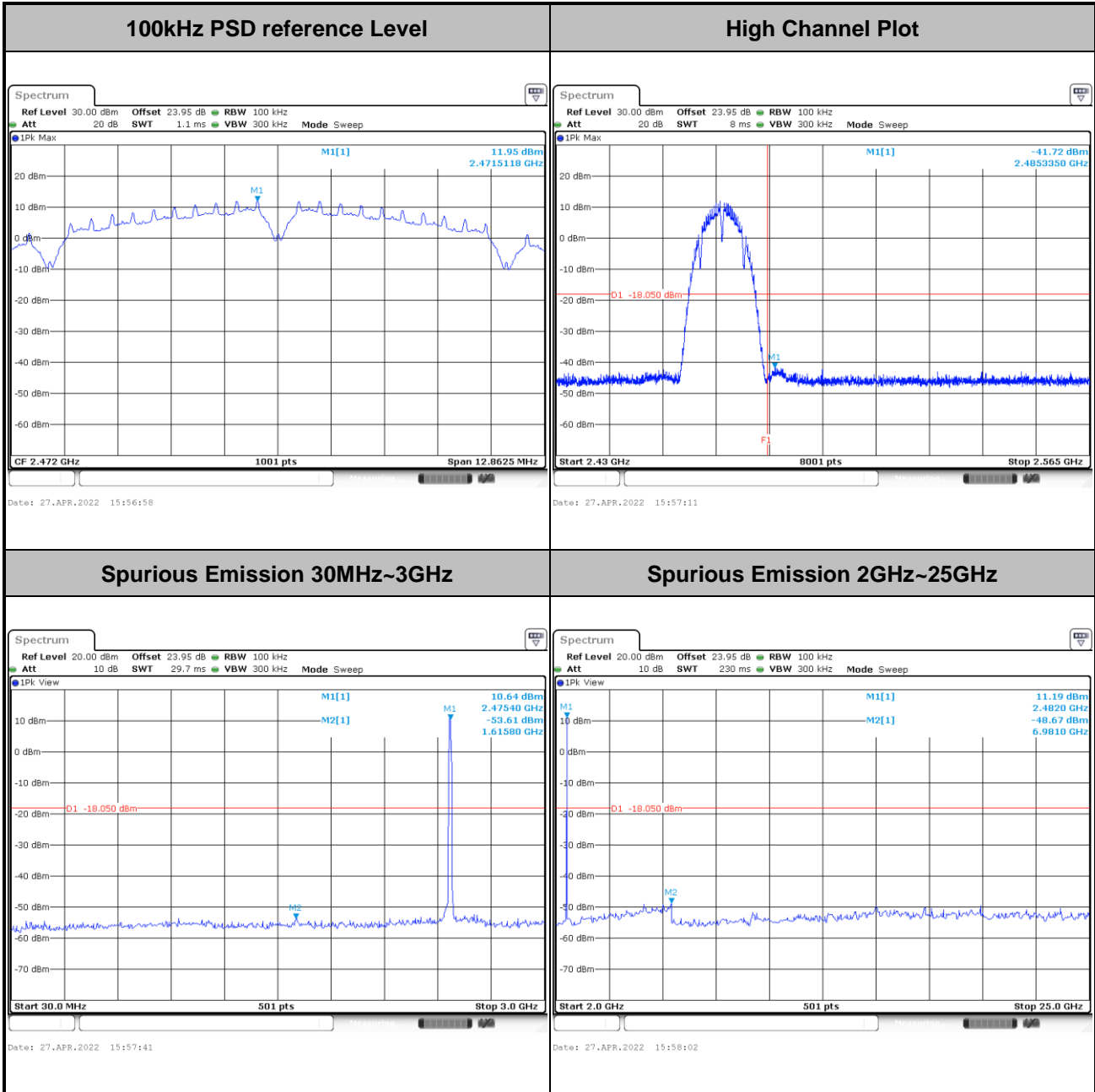



Number of TX = 1, Ant. 3 (Measured)

|             |         |                |    |
|-------------|---------|----------------|----|
| Test Mode : | 802.11b | Test Channel : | 01 |
|-------------|---------|----------------|----|

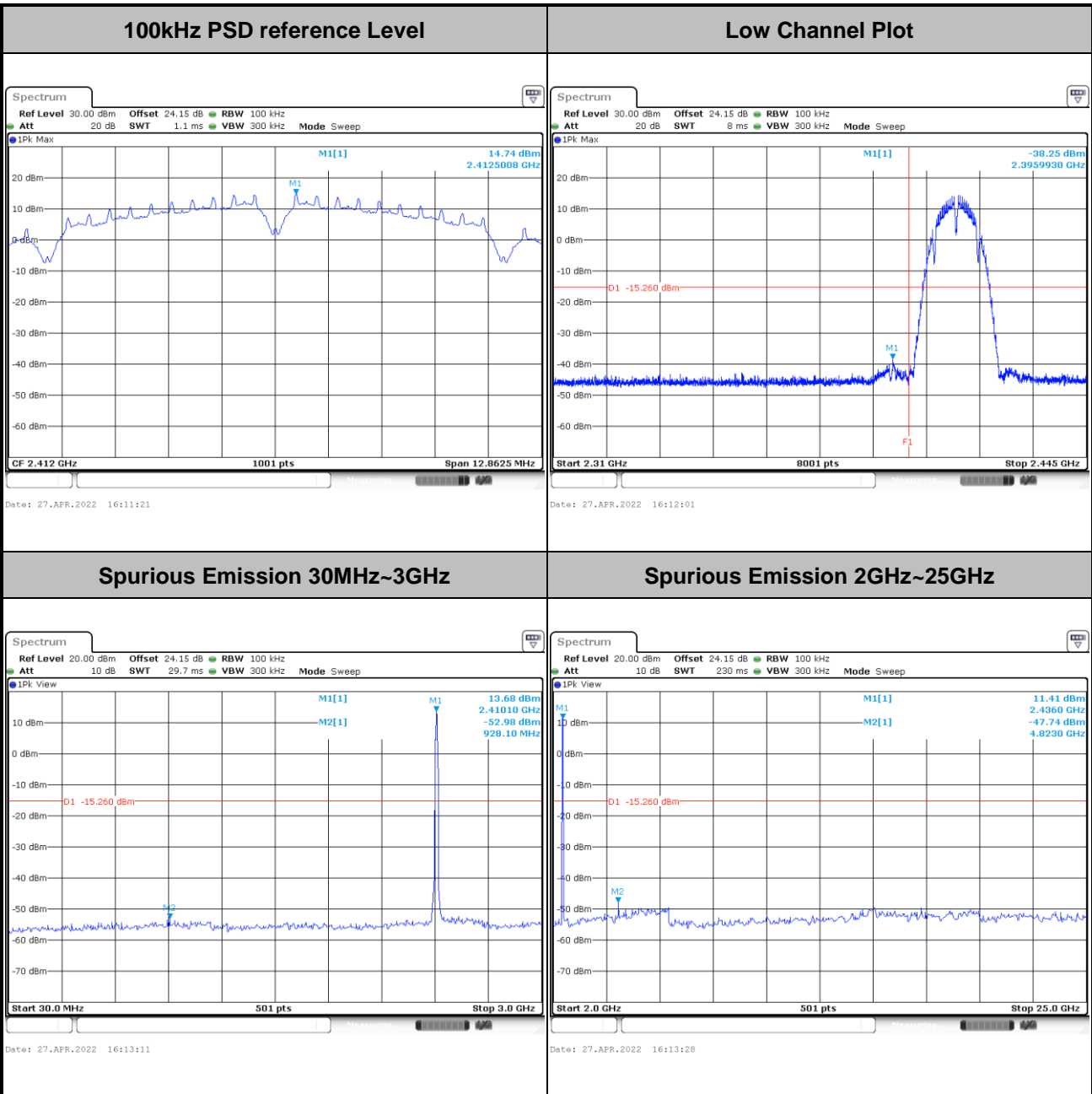



|             |         |                |    |
|-------------|---------|----------------|----|
| Test Mode : | 802.11b | Test Channel : | 06 |
|-------------|---------|----------------|----|

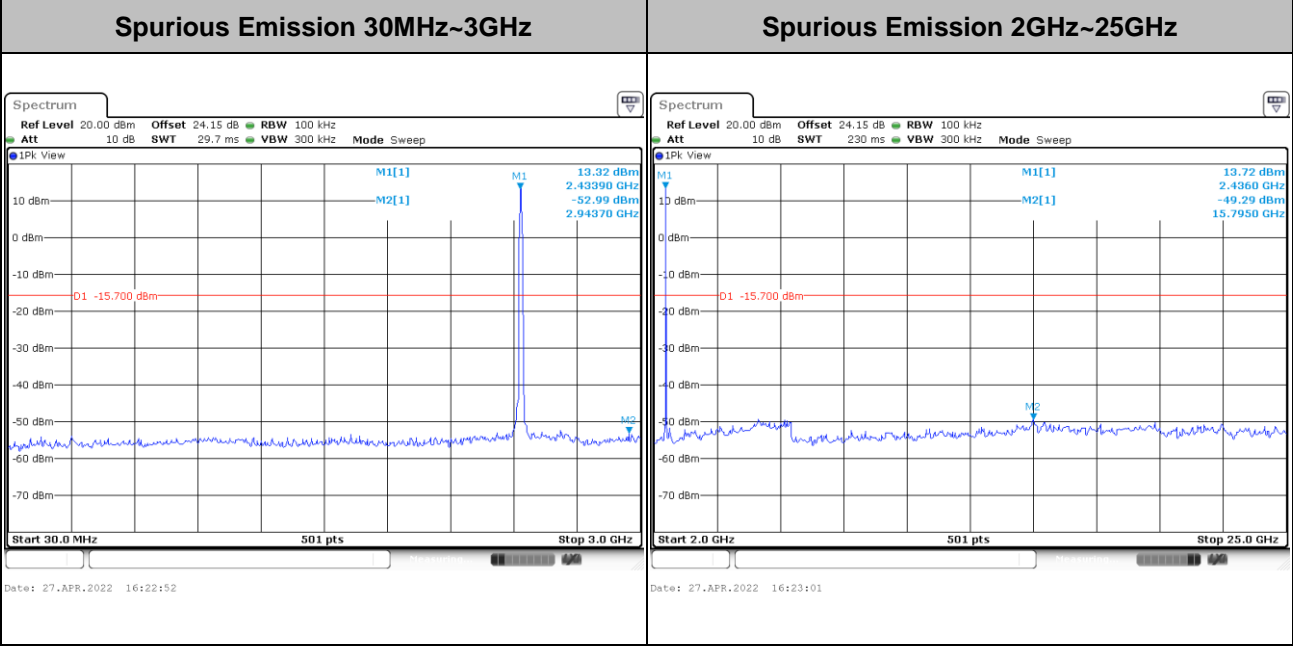
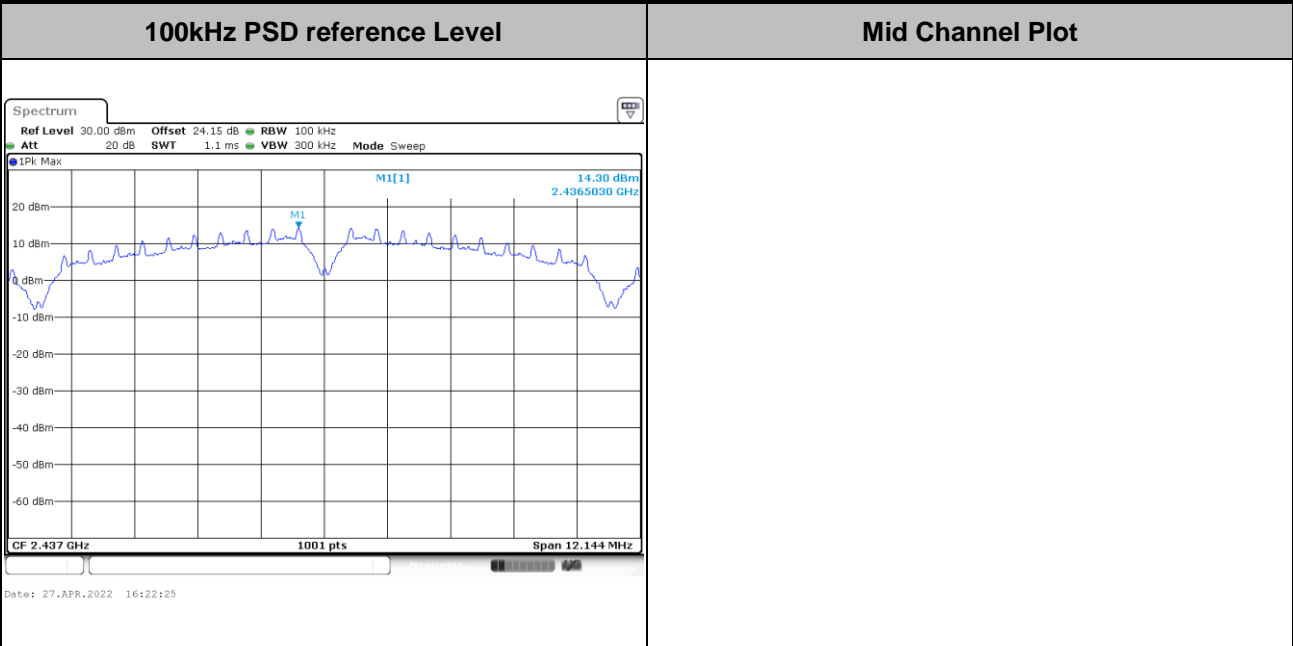



|             |         |                |    |
|-------------|---------|----------------|----|
| Test Mode : | 802.11b | Test Channel : | 11 |
|-------------|---------|----------------|----|

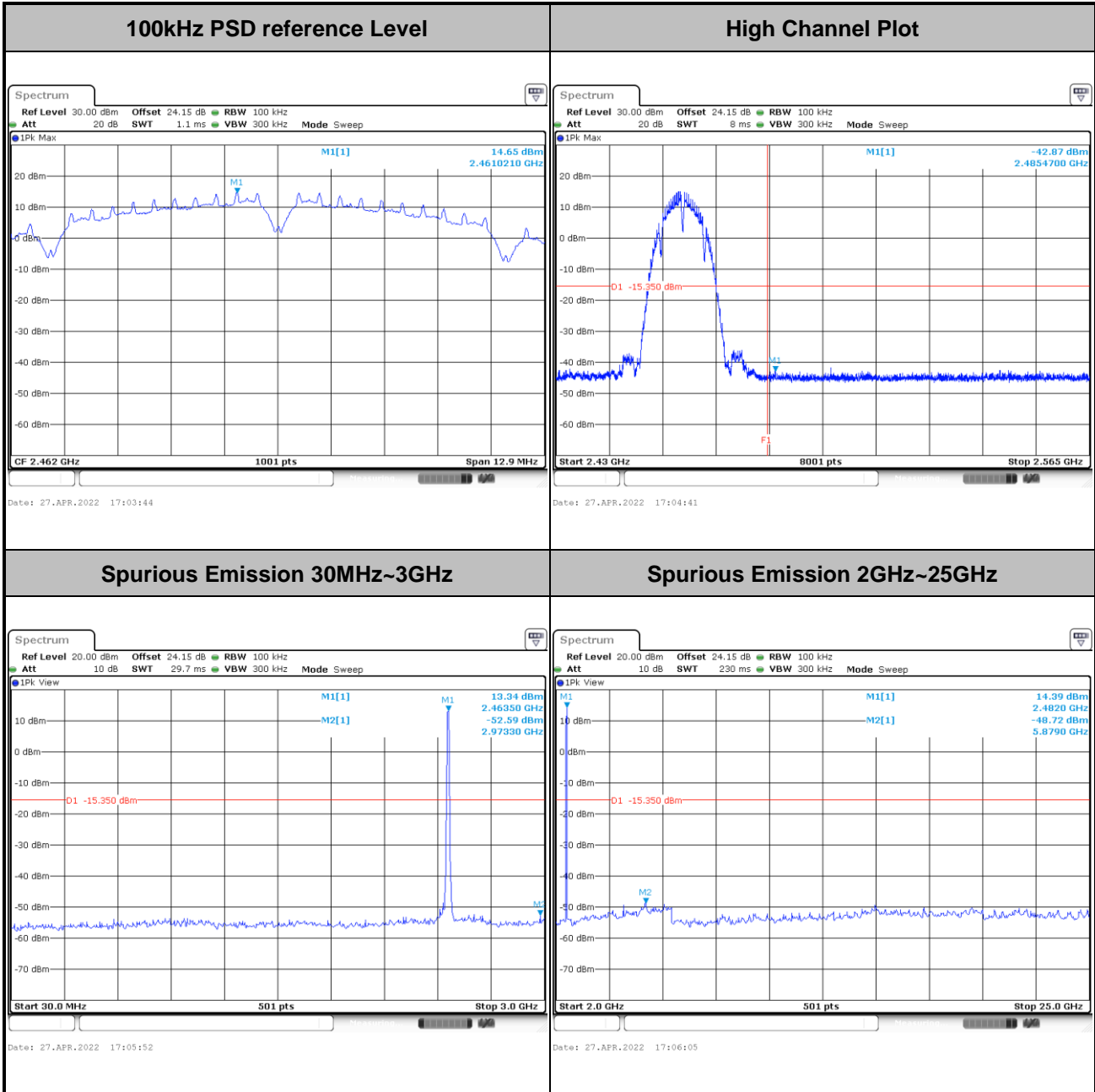



|             |         |                |    |
|-------------|---------|----------------|----|
| Test Mode : | 802.11b | Test Channel : | 12 |
|-------------|---------|----------------|----|

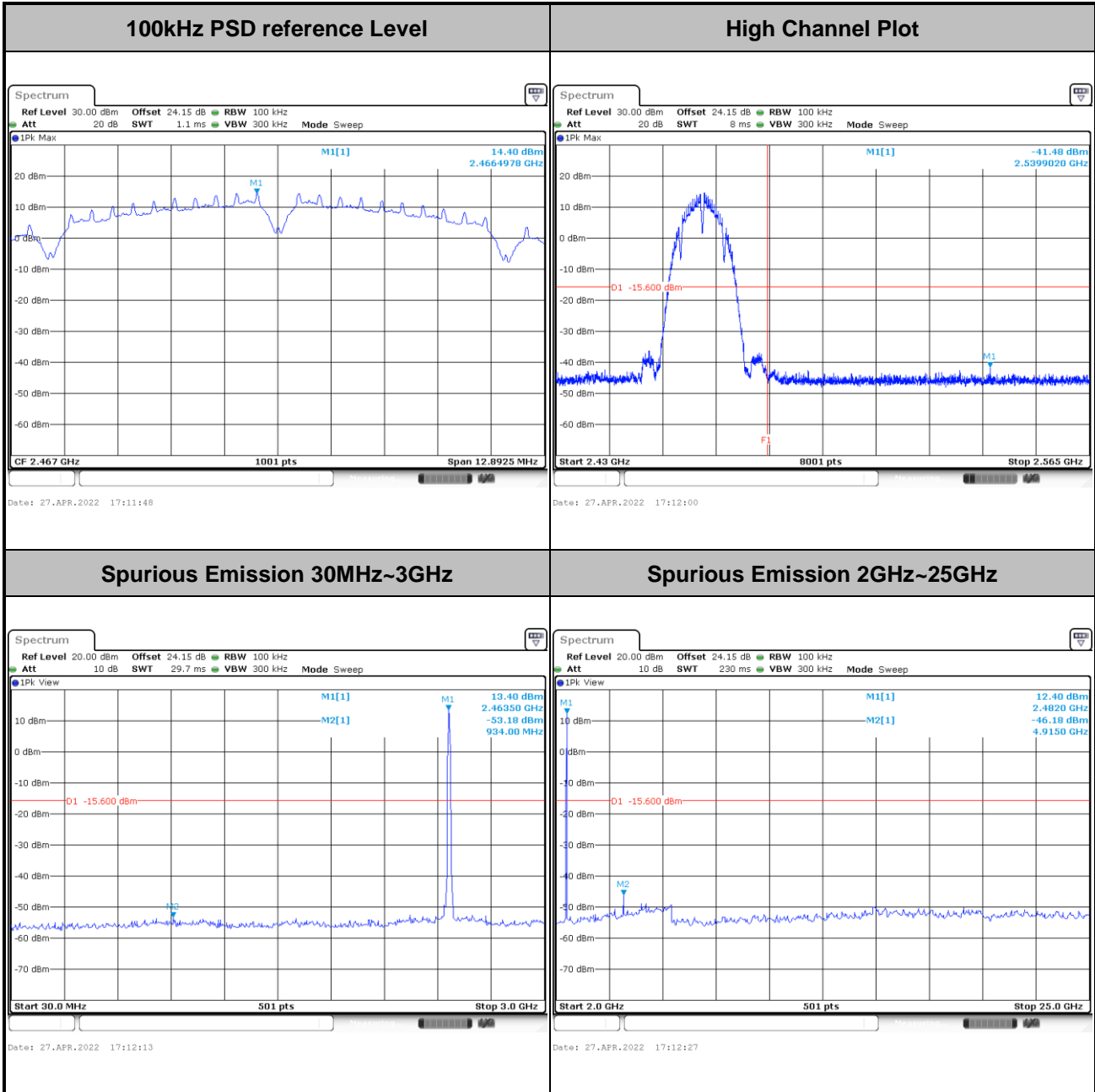



|             |         |                |    |
|-------------|---------|----------------|----|
| Test Mode : | 802.11b | Test Channel : | 13 |
|-------------|---------|----------------|----|

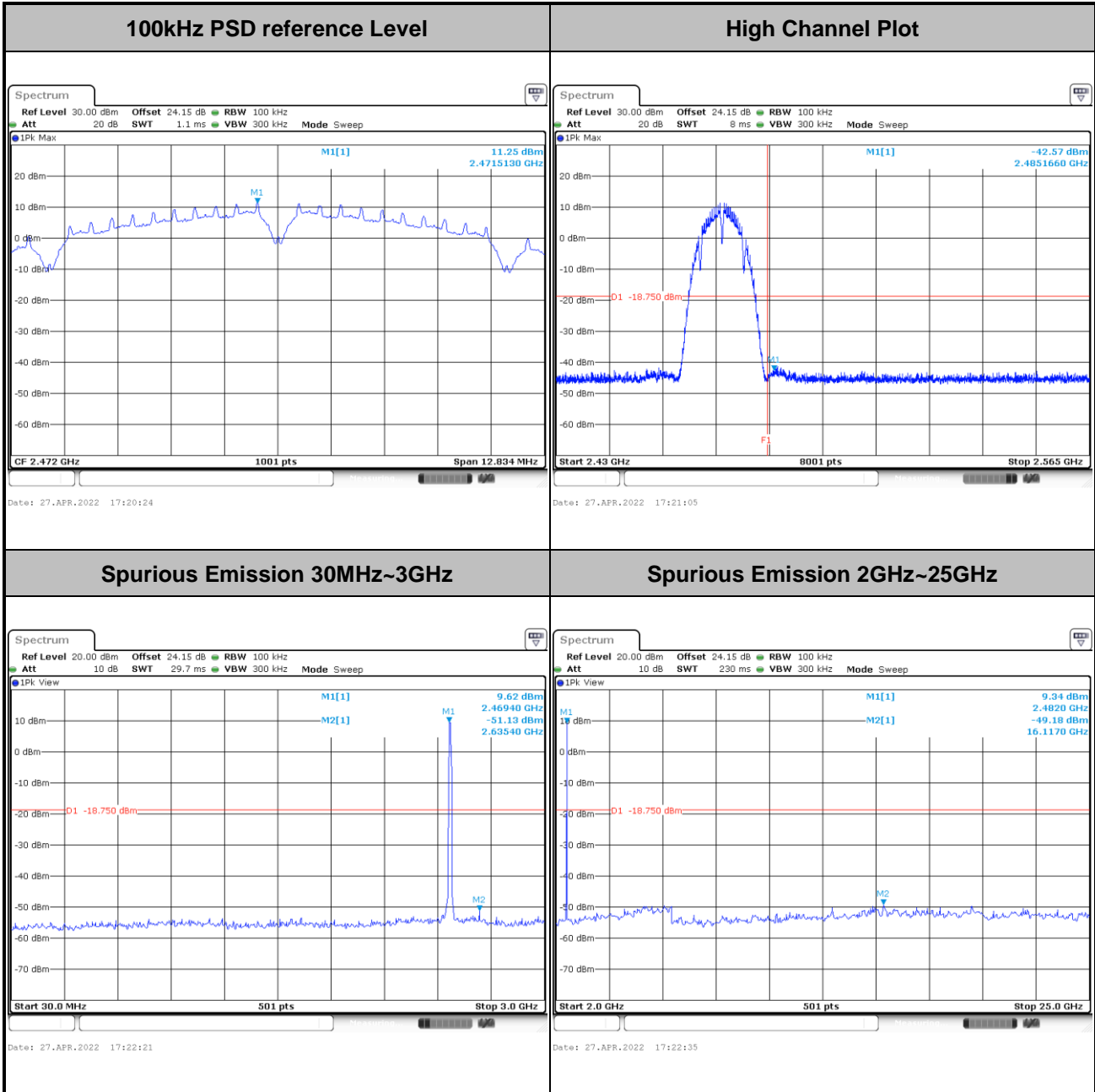



Number of TX = 2, Ant. 4 (Measured)

|             |         |                |    |
|-------------|---------|----------------|----|
| Test Mode : | 802.11g | Test Channel : | 01 |
|-------------|---------|----------------|----|

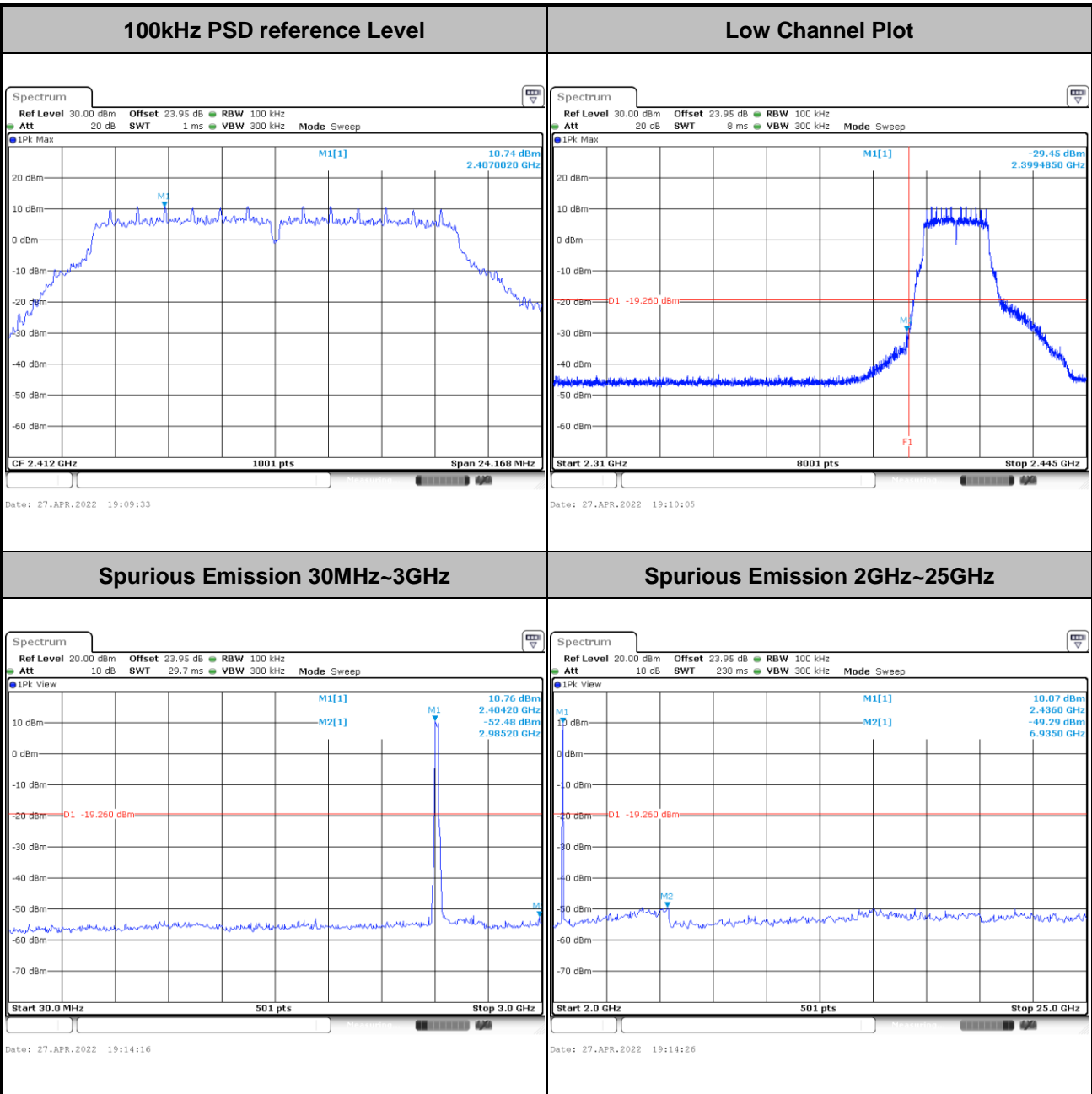





|             |         |                |    |
|-------------|---------|----------------|----|
| Test Mode : | 802.11g | Test Channel : | 06 |
|-------------|---------|----------------|----|

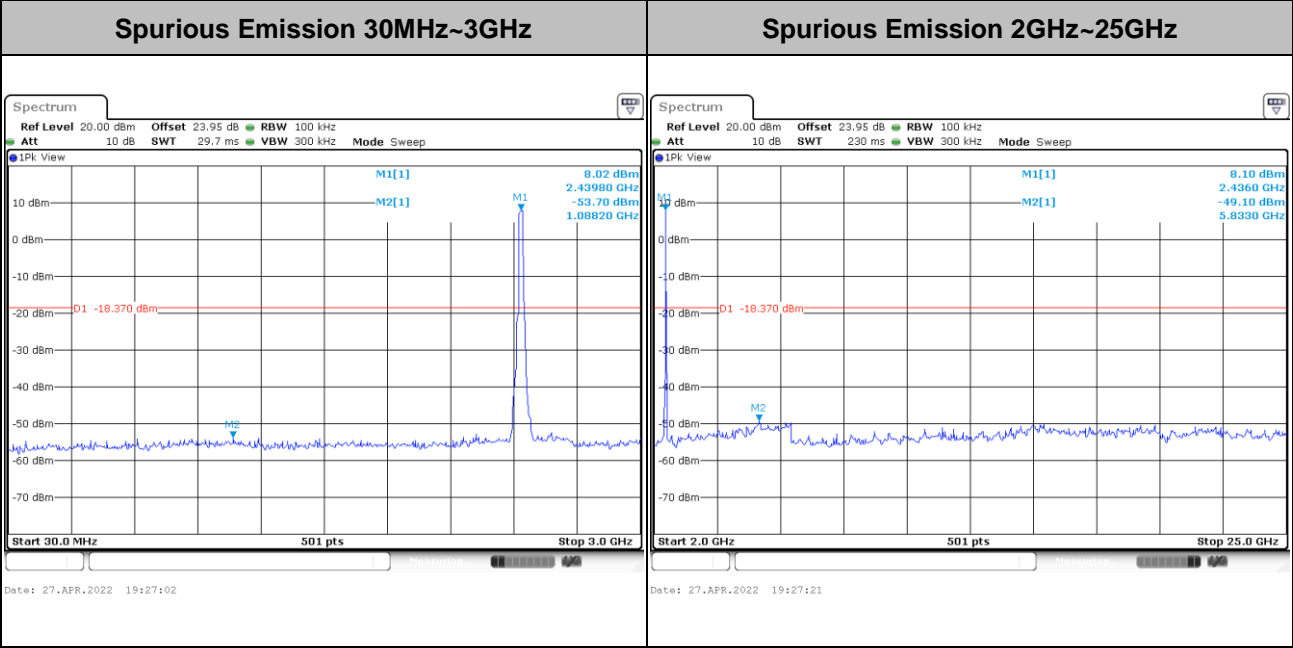
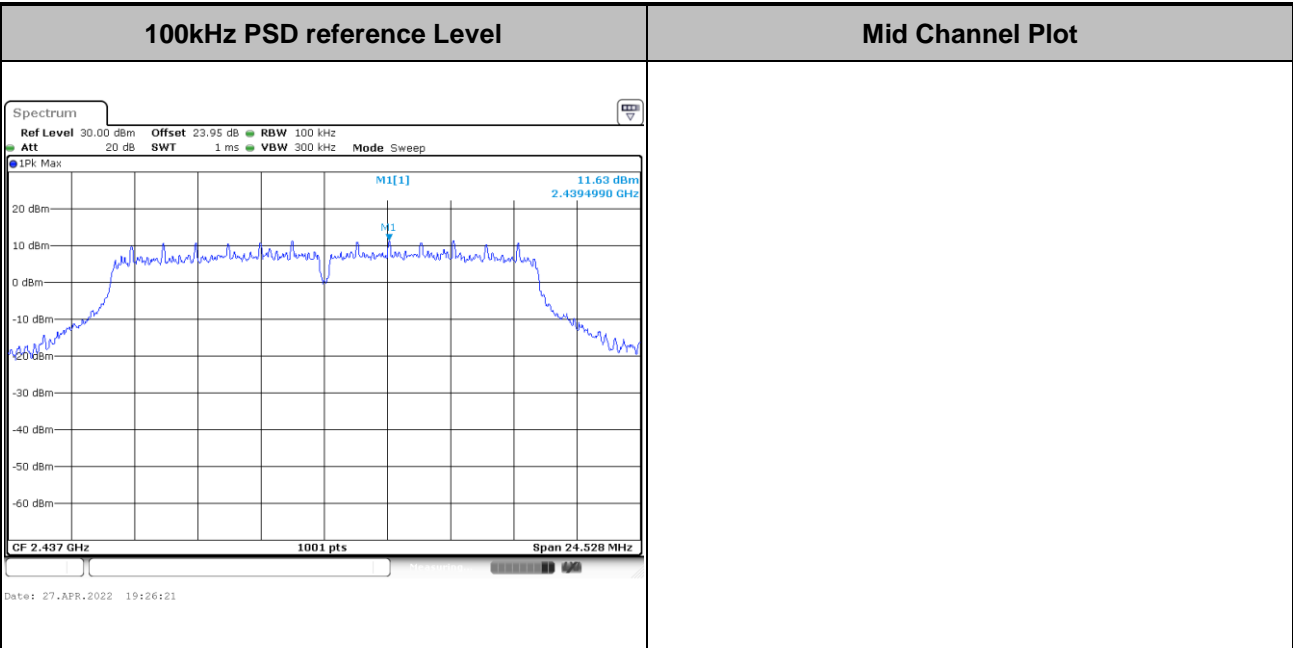



|             |         |                |    |
|-------------|---------|----------------|----|
| Test Mode : | 802.11g | Test Channel : | 11 |
|-------------|---------|----------------|----|

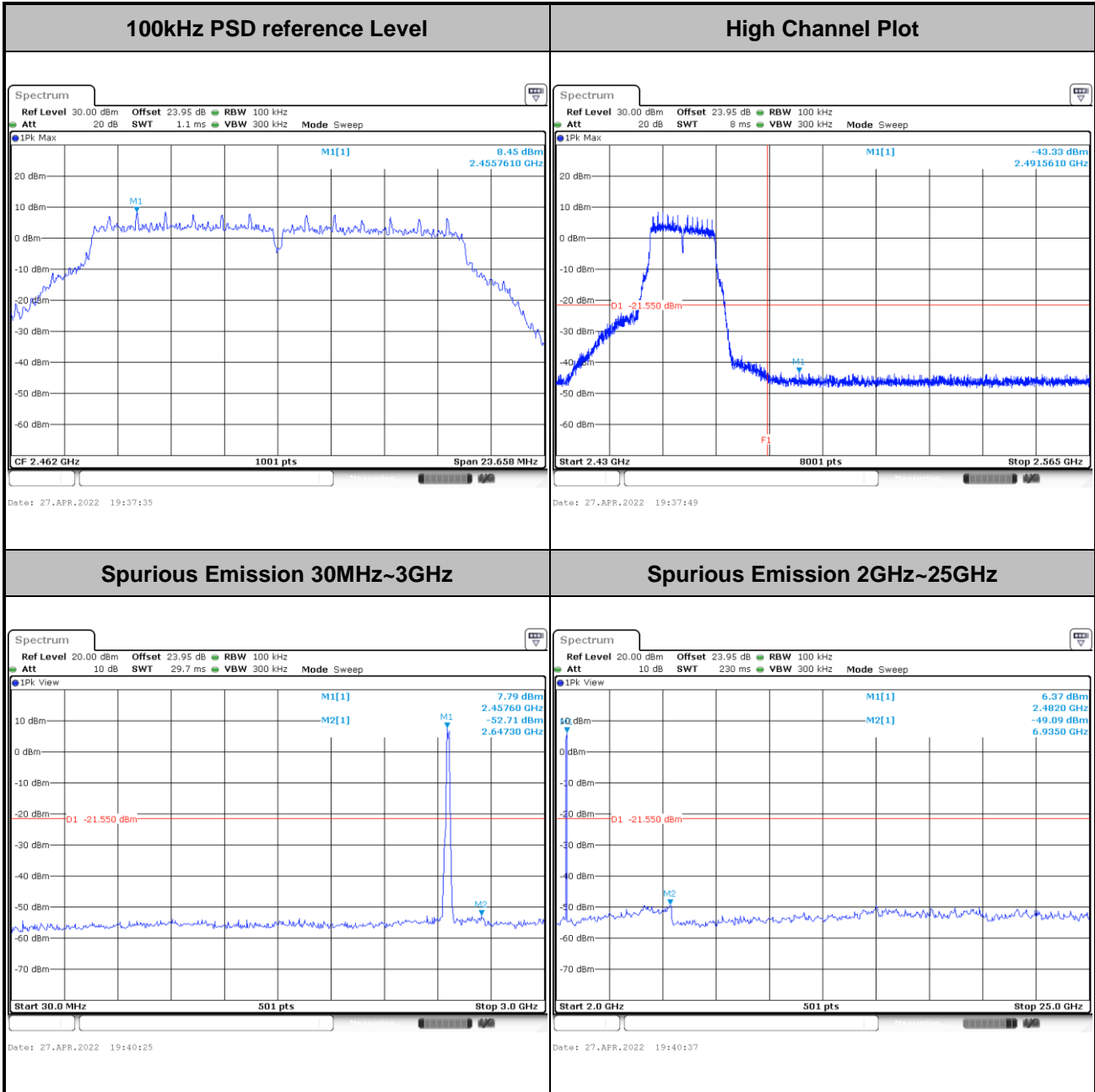



|             |         |                |    |
|-------------|---------|----------------|----|
| Test Mode : | 802.11g | Test Channel : | 12 |
|-------------|---------|----------------|----|

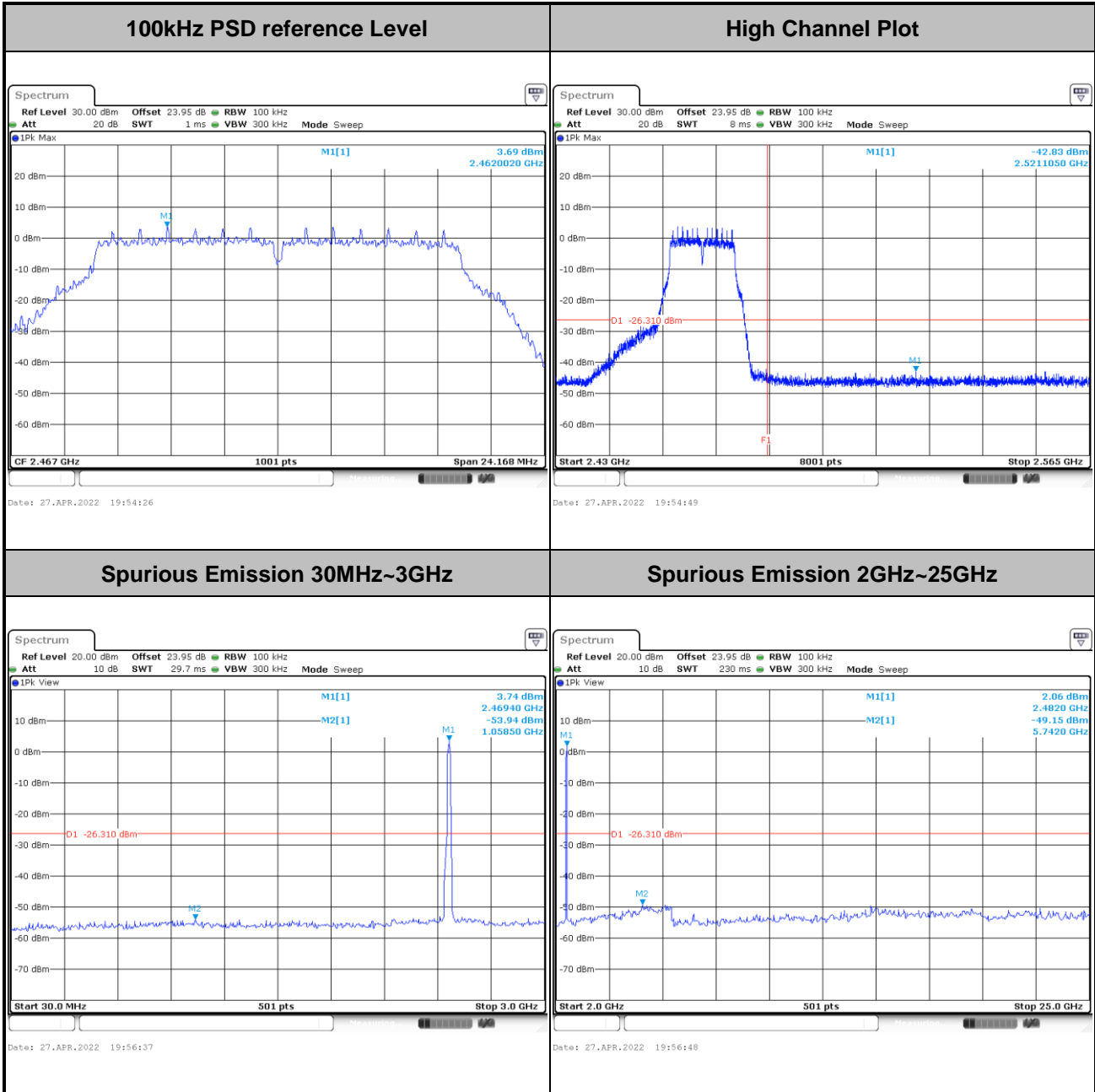



|             |         |                |    |
|-------------|---------|----------------|----|
| Test Mode : | 802.11g | Test Channel : | 13 |
|-------------|---------|----------------|----|

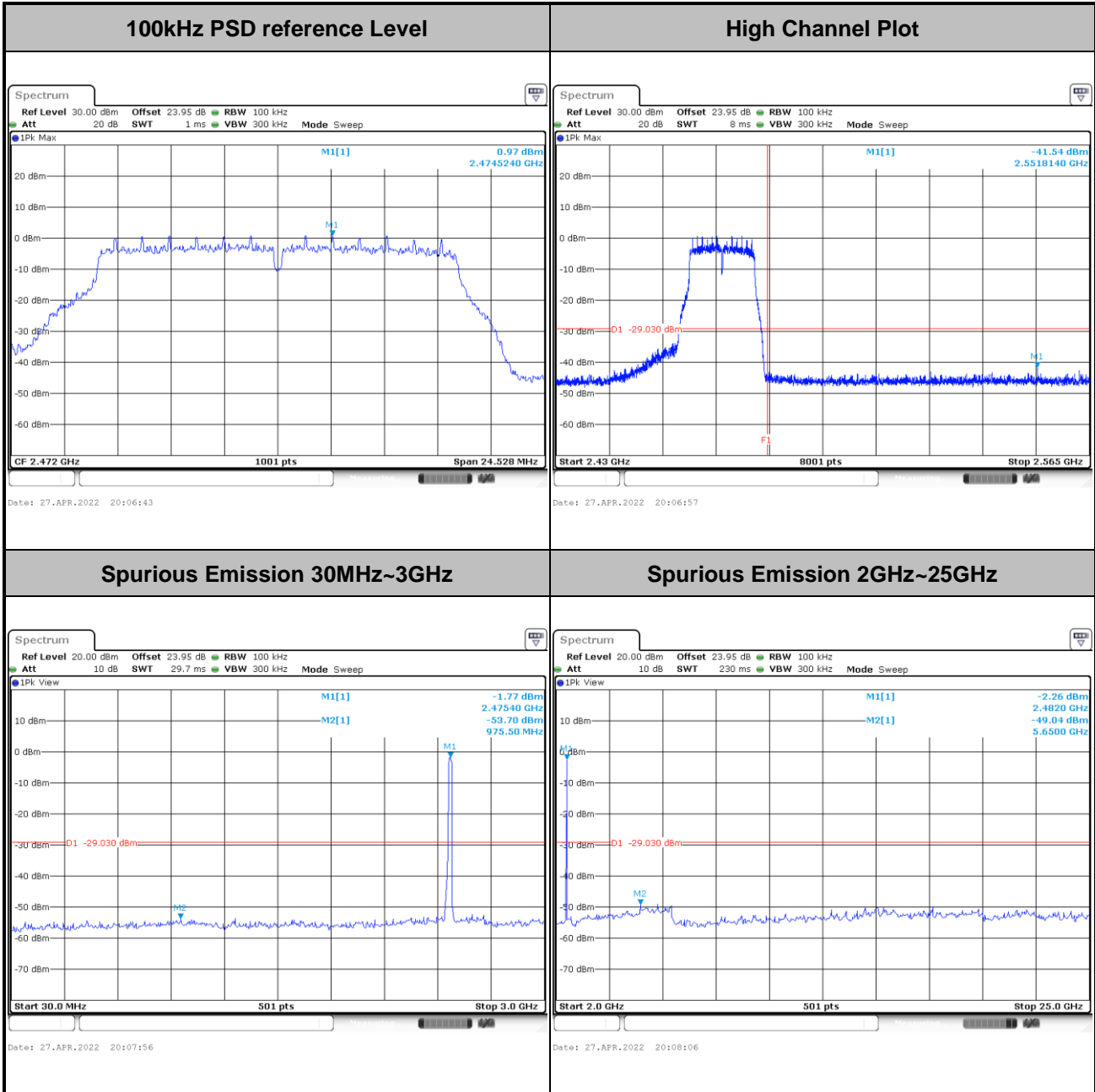



|             |               |                |            |
|-------------|---------------|----------------|------------|
| Test Mode : | 802.11ax HE20 | Test Channel : | 01 Full RU |
|-------------|---------------|----------------|------------|

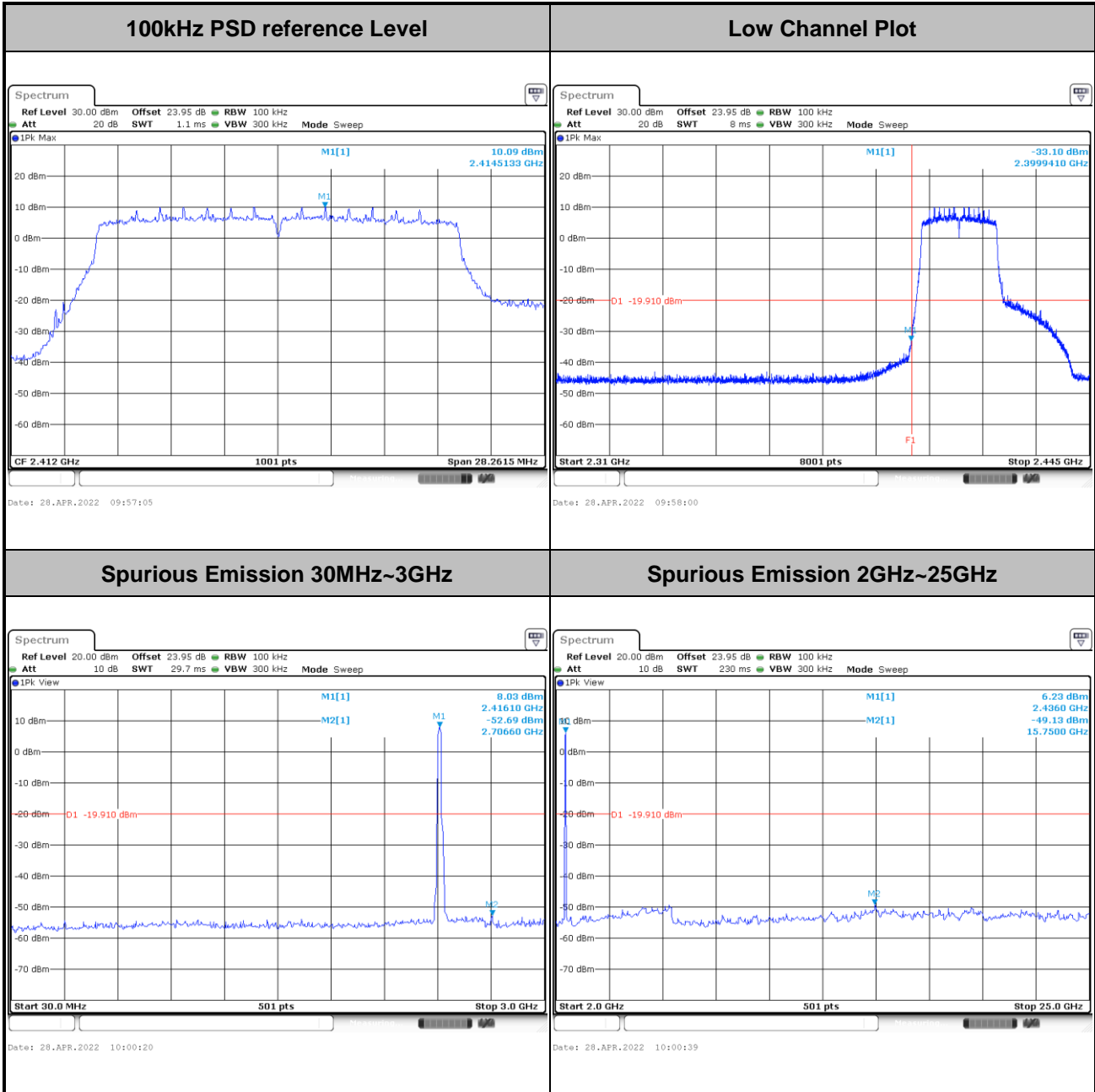



|                    |               |                       |                  |
|--------------------|---------------|-----------------------|------------------|
| <b>Test Mode :</b> | 802.11ax HE20 | <b>Test Channel :</b> | 01 Partial 26 RU |
|--------------------|---------------|-----------------------|------------------|

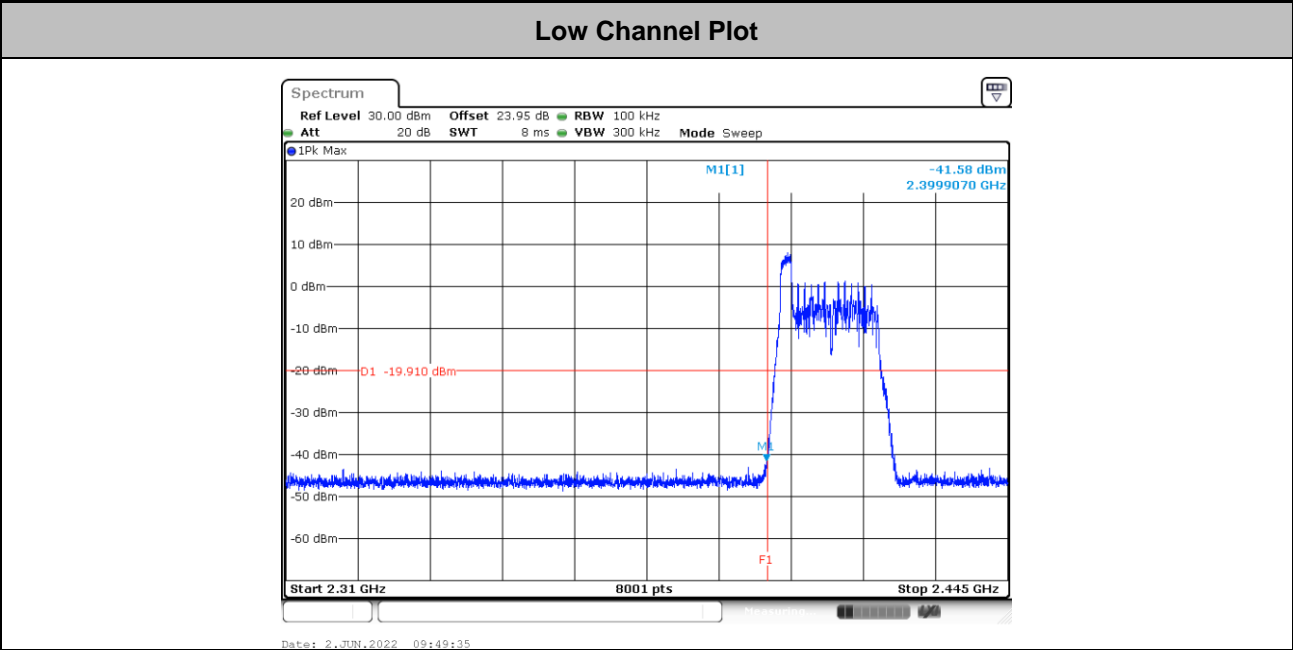



|                    |               |                       |            |
|--------------------|---------------|-----------------------|------------|
| <b>Test Mode :</b> | 802.11ax HE20 | <b>Test Channel :</b> | 06 Full RU |
|--------------------|---------------|-----------------------|------------|

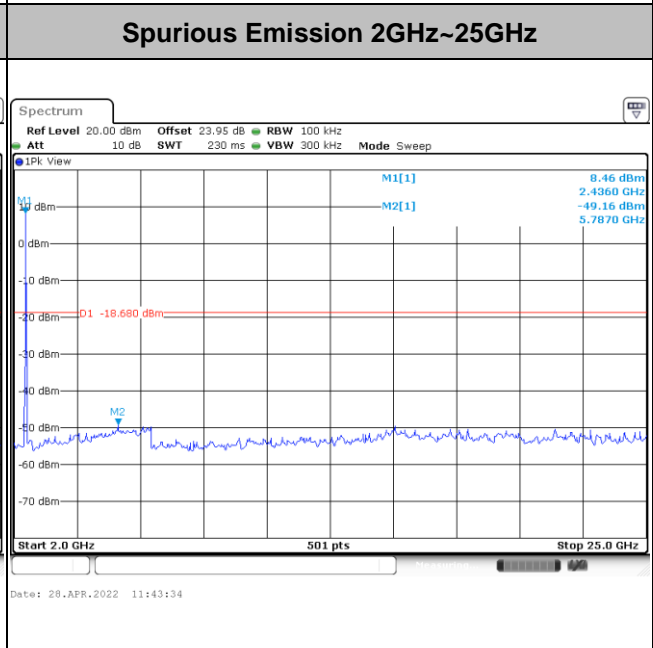
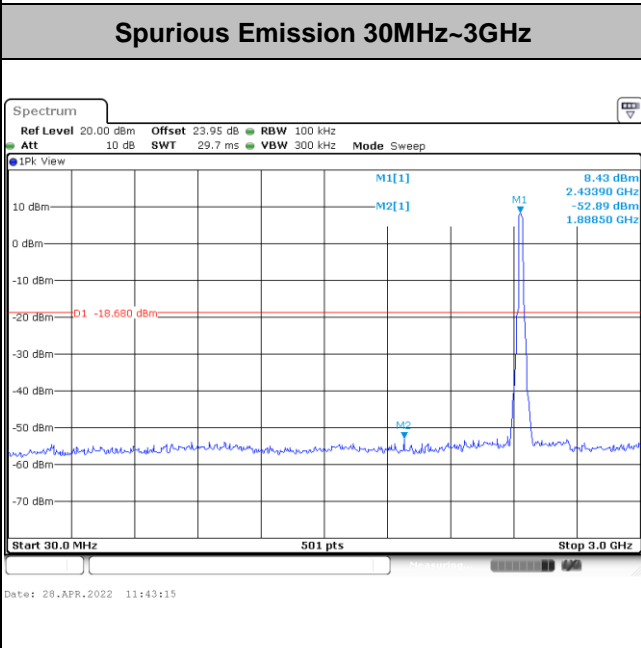
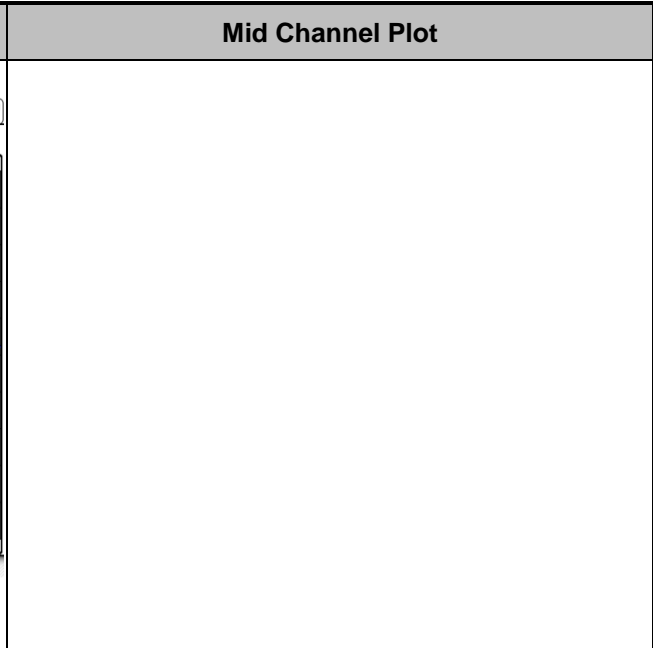
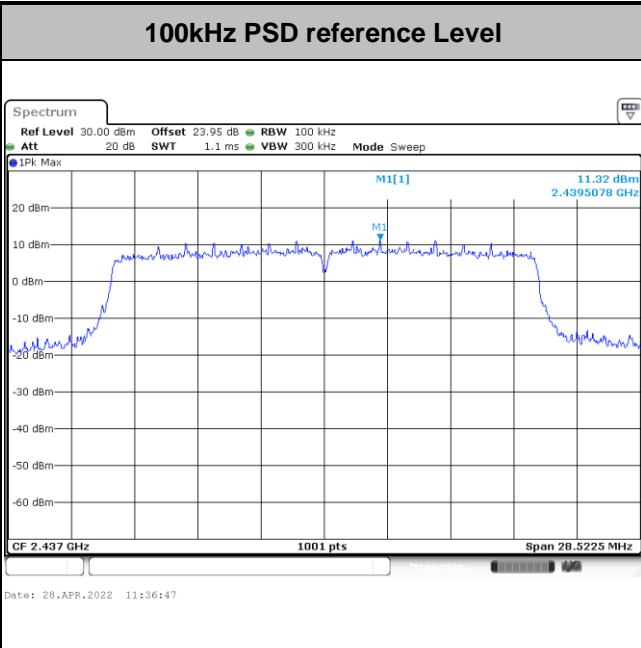



|             |               |                |            |
|-------------|---------------|----------------|------------|
| Test Mode : | 802.11ax HE20 | Test Channel : | 11 Full RU |
|-------------|---------------|----------------|------------|

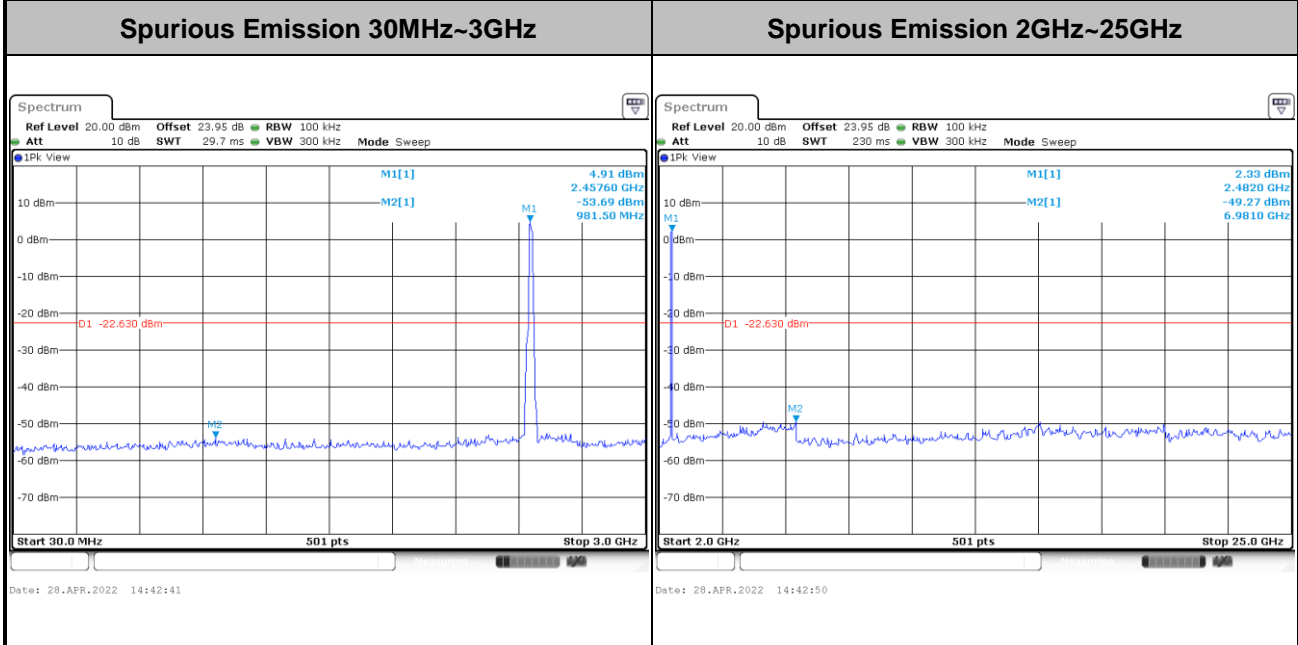
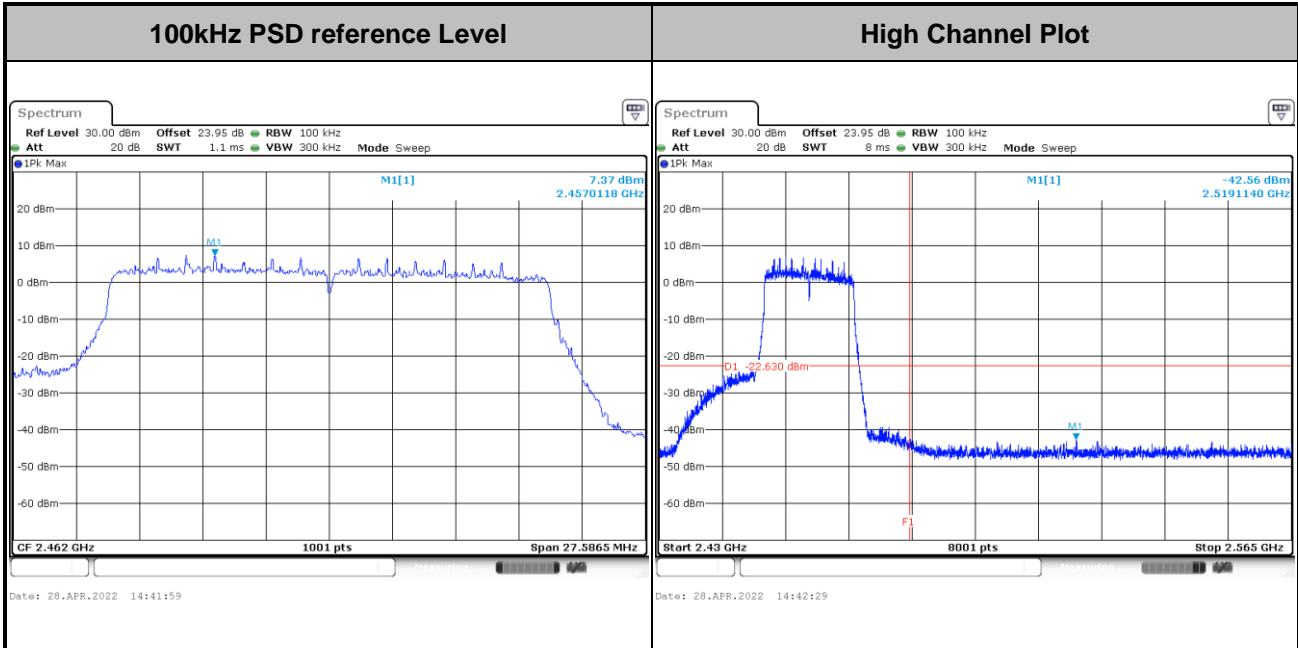





|             |               |                |            |
|-------------|---------------|----------------|------------|
| Test Mode : | 802.11ax HE20 | Test Channel : | 12 Full RU |
|-------------|---------------|----------------|------------|

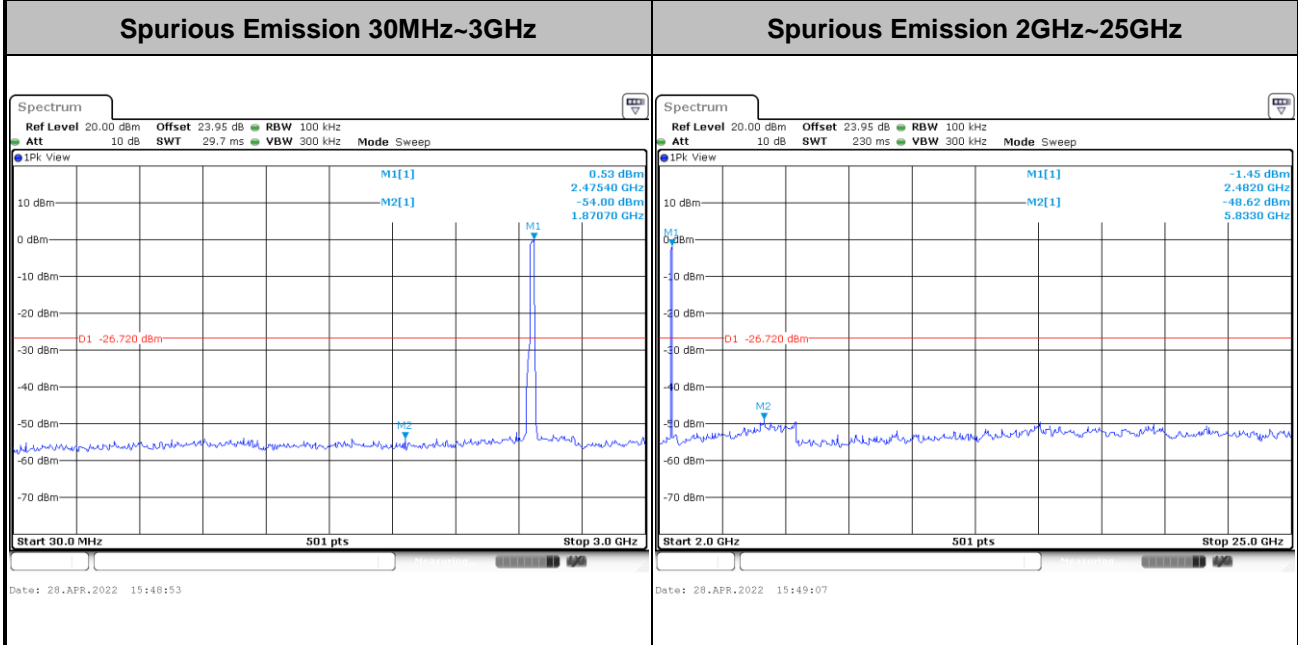
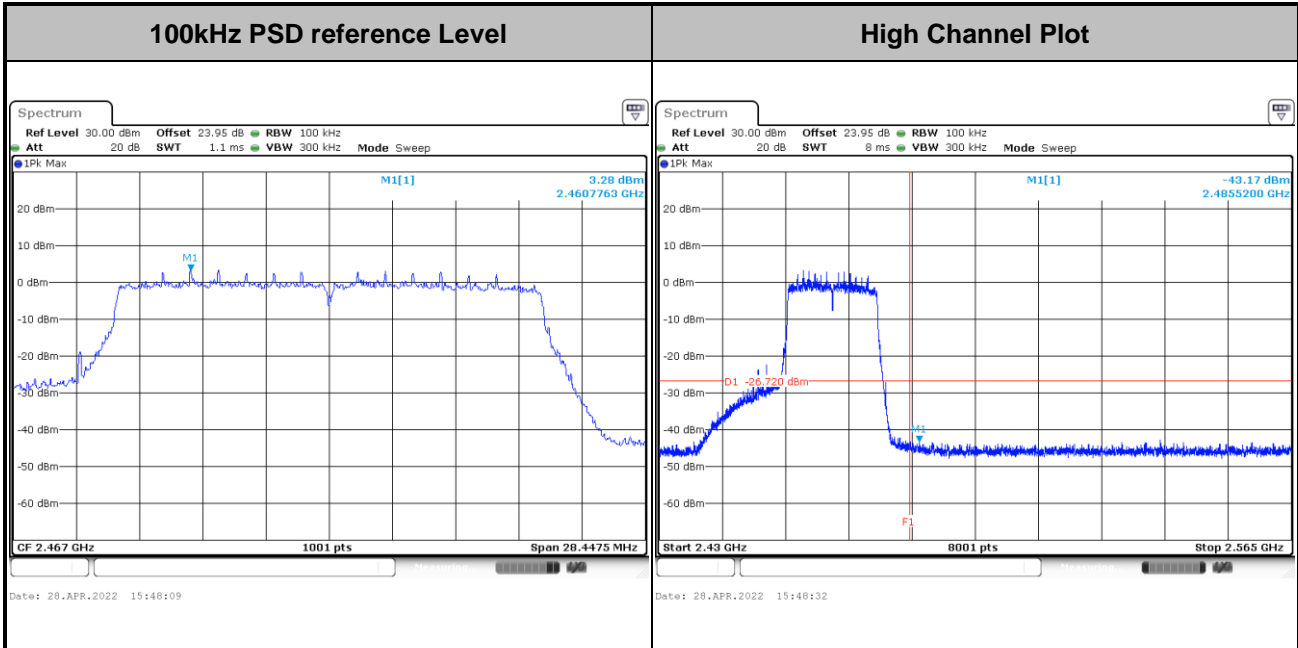



|                    |               |                       |            |
|--------------------|---------------|-----------------------|------------|
| <b>Test Mode :</b> | 802.11ax HE20 | <b>Test Channel :</b> | 13 Full RU |
|--------------------|---------------|-----------------------|------------|

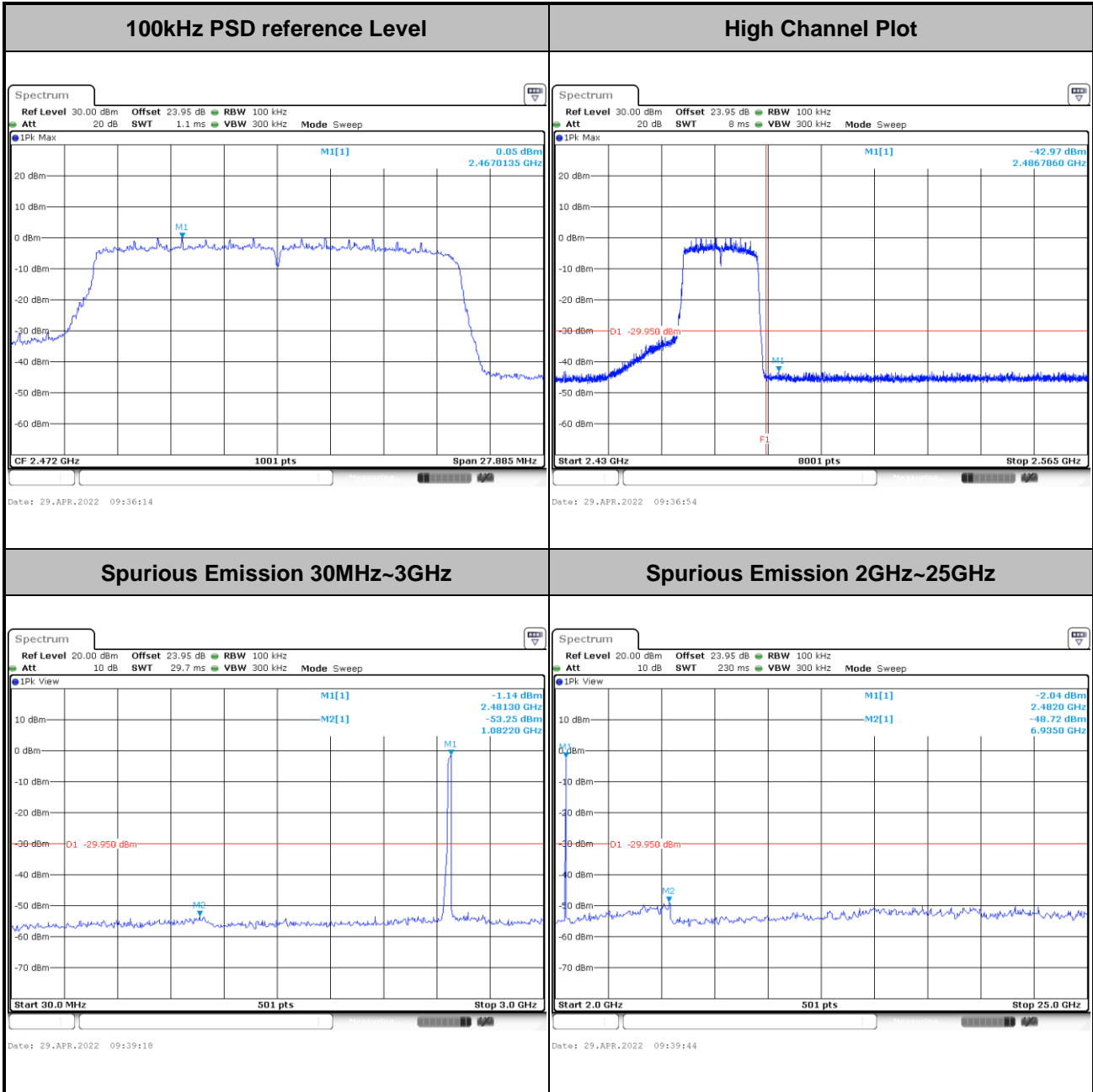



|             |               |                |                  |
|-------------|---------------|----------------|------------------|
| Test Mode : | 802.11ax HE20 | Test Channel : | 13 Partial 26 RU |
|-------------|---------------|----------------|------------------|

High Channel Plot

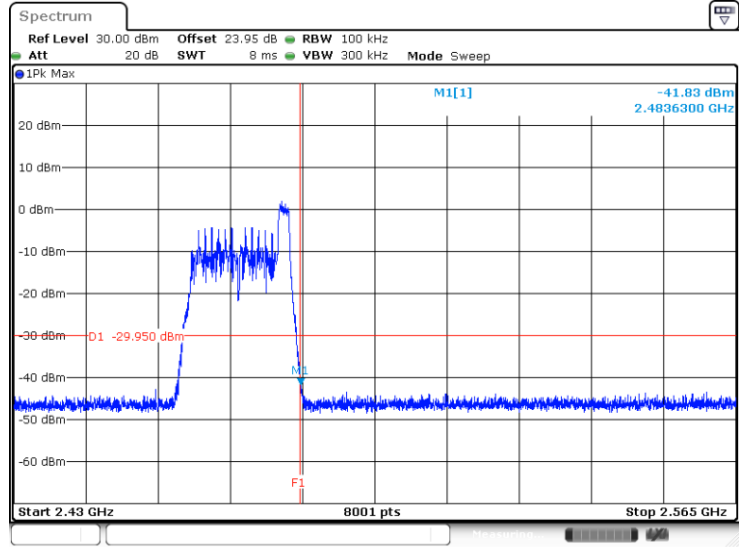



Number of TX = 2, Ant. 3 (Measured)

|             |         |                |    |
|-------------|---------|----------------|----|
| Test Mode : | 802.11g | Test Channel : | 01 |
|-------------|---------|----------------|----|

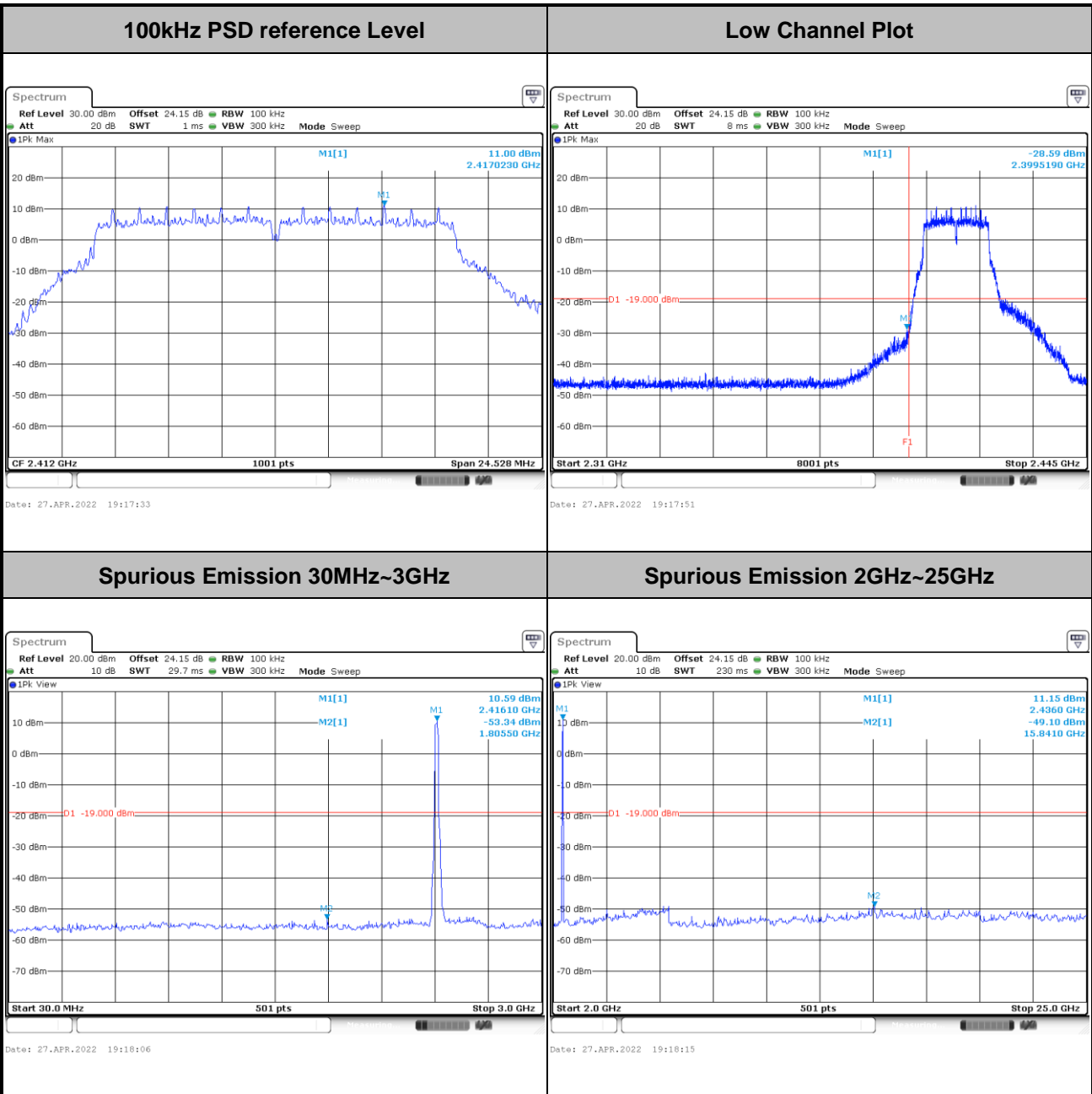



|             |         |                |    |
|-------------|---------|----------------|----|
| Test Mode : | 802.11g | Test Channel : | 06 |
|-------------|---------|----------------|----|

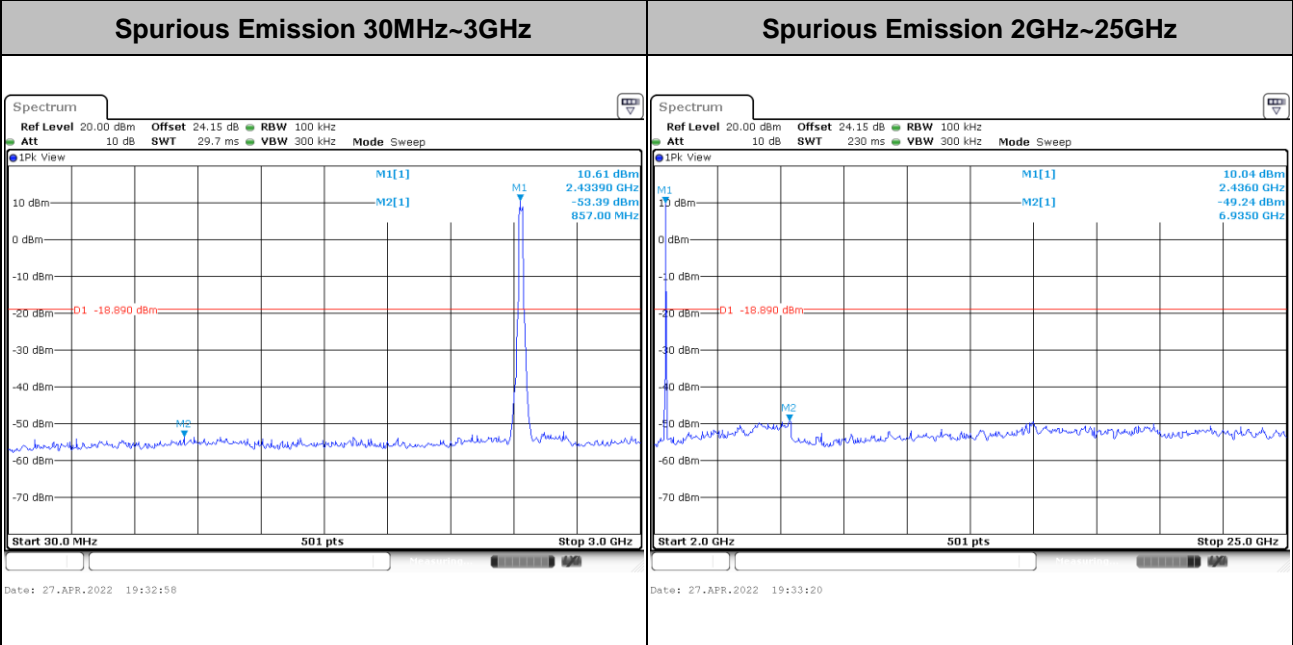
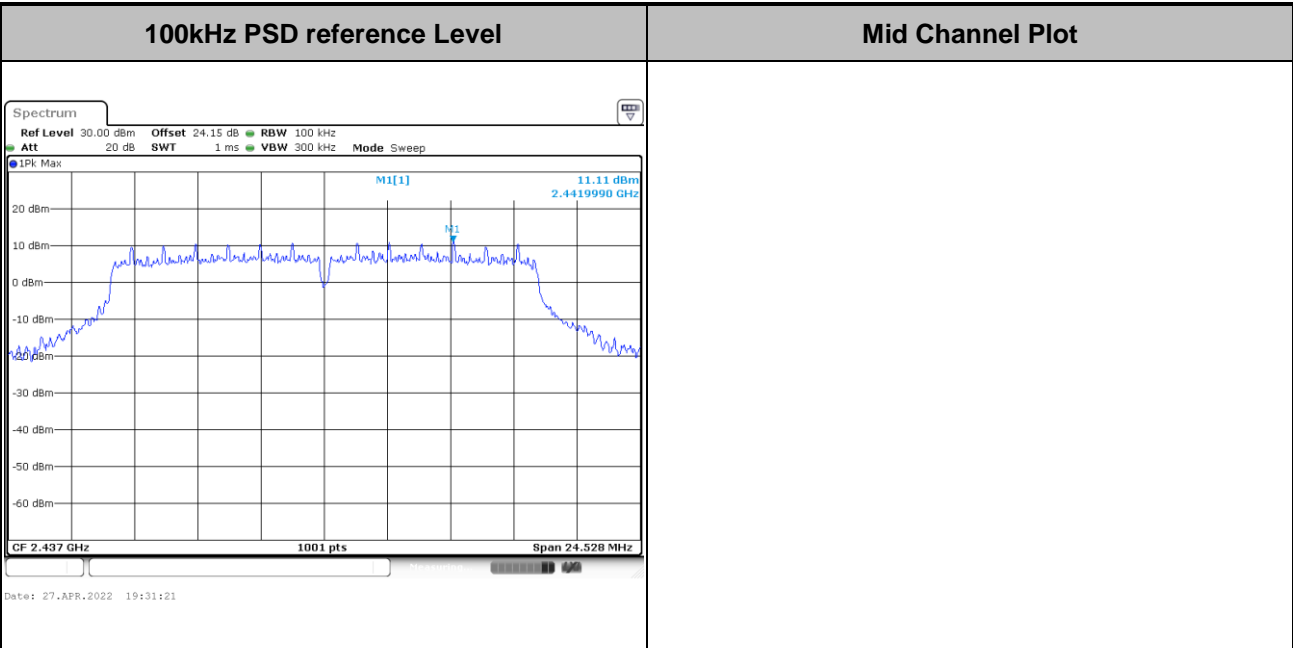



|             |         |                |    |
|-------------|---------|----------------|----|
| Test Mode : | 802.11g | Test Channel : | 11 |
|-------------|---------|----------------|----|

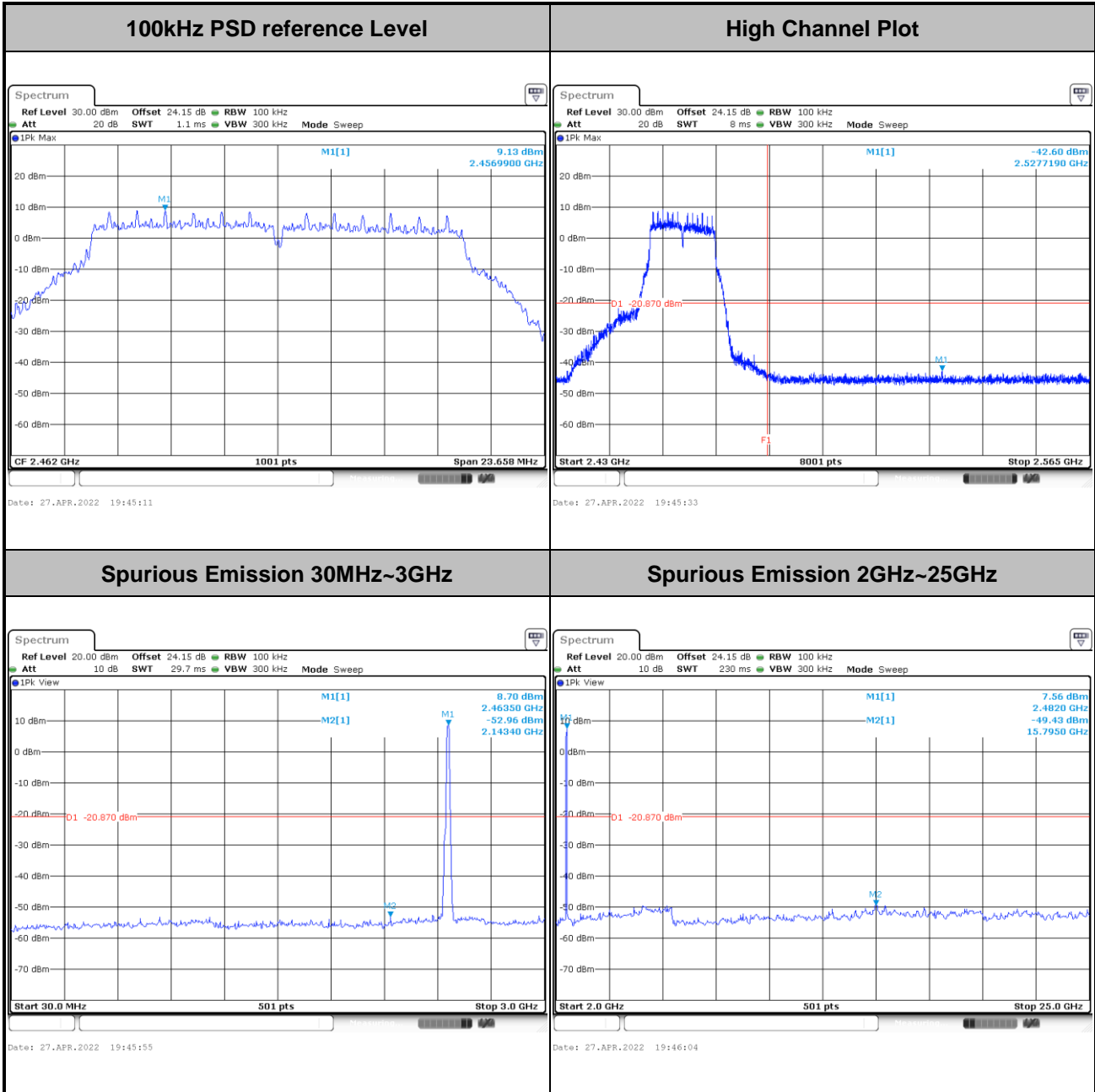



|             |         |                |    |
|-------------|---------|----------------|----|
| Test Mode : | 802.11g | Test Channel : | 12 |
|-------------|---------|----------------|----|

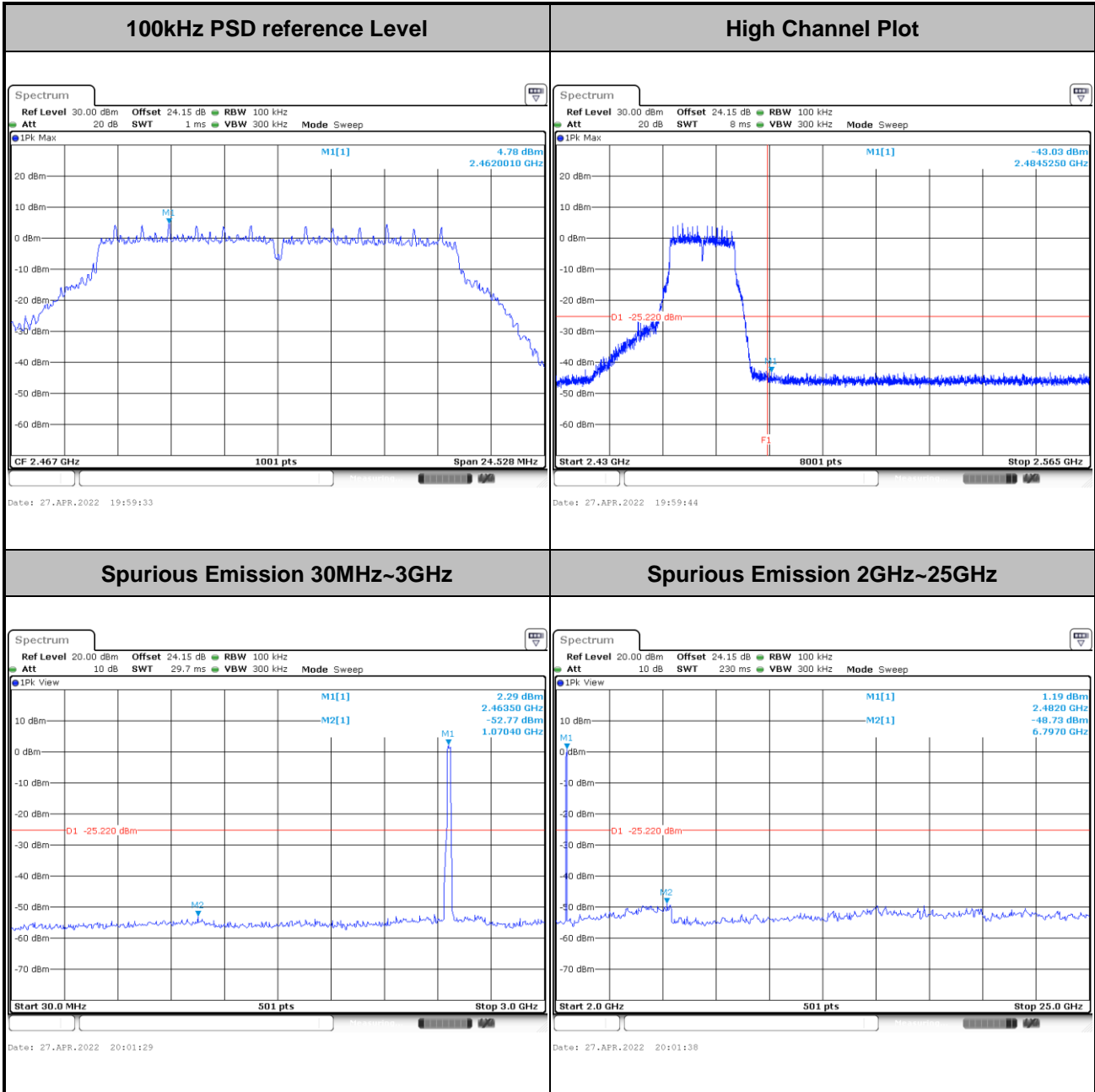



|             |         |                |    |
|-------------|---------|----------------|----|
| Test Mode : | 802.11g | Test Channel : | 13 |
|-------------|---------|----------------|----|

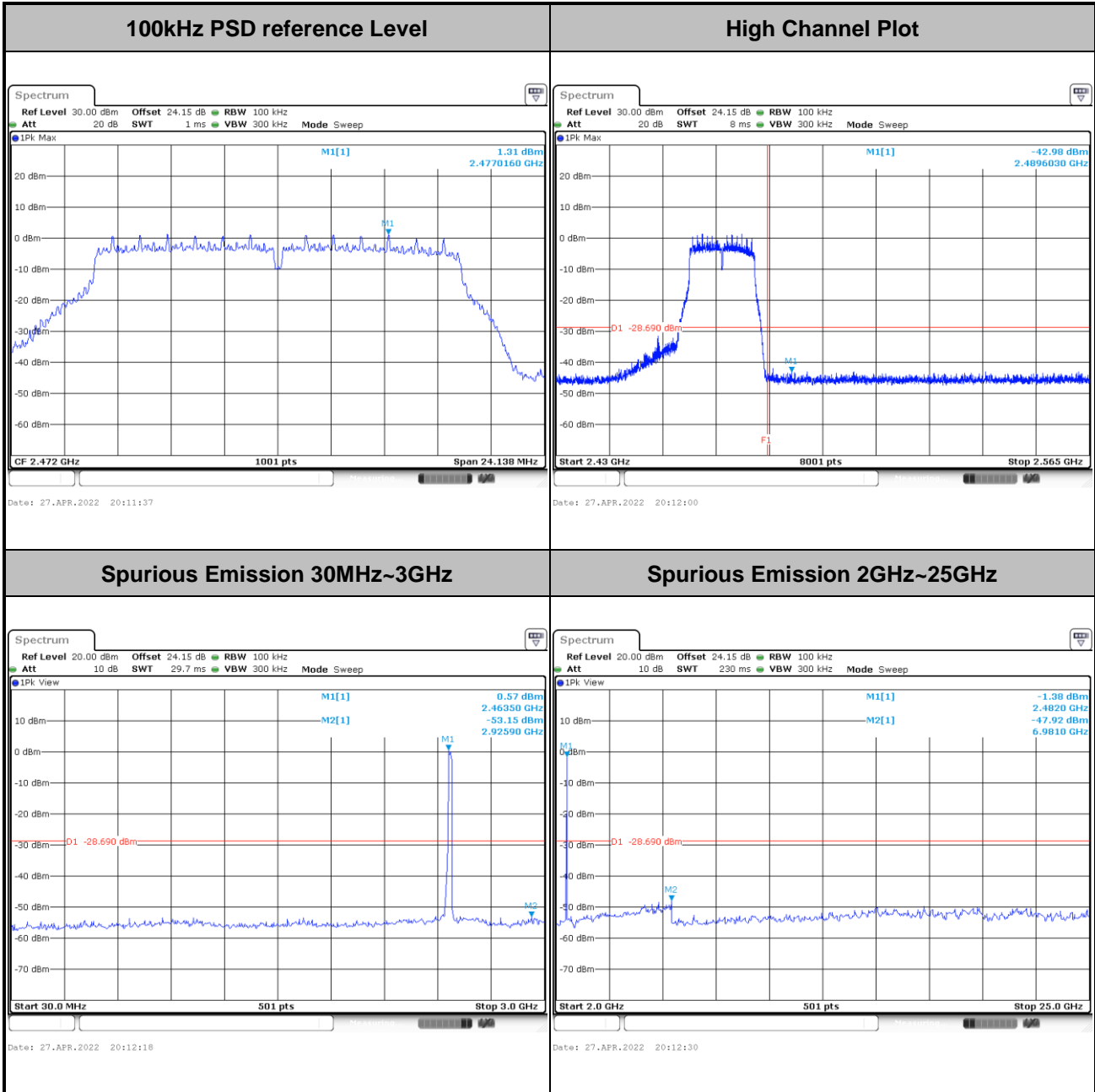





|             |               |                |            |
|-------------|---------------|----------------|------------|
| Test Mode : | 802.11ax HE20 | Test Channel : | 01 Full RU |
|-------------|---------------|----------------|------------|

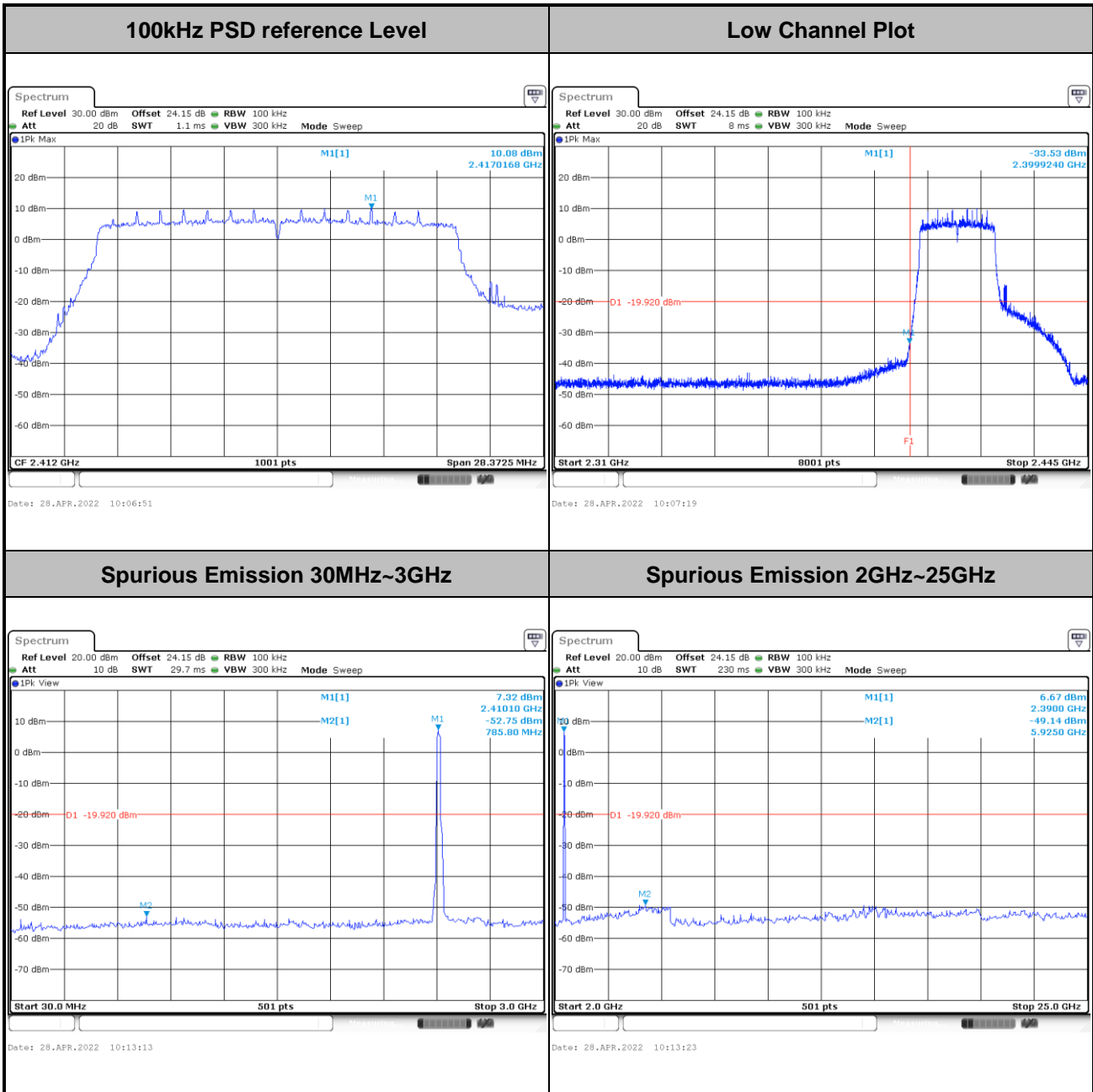



|             |               |                |                  |
|-------------|---------------|----------------|------------------|
| Test Mode : | 802.11ax HE20 | Test Channel : | 01 Partial 26 RU |
|-------------|---------------|----------------|------------------|

Low Channel Plot

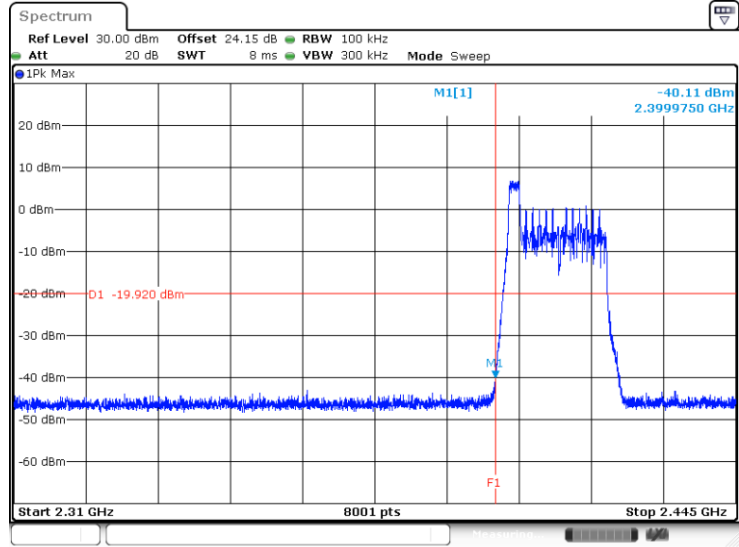



|                    |               |                       |            |
|--------------------|---------------|-----------------------|------------|
| <b>Test Mode :</b> | 802.11ax HE20 | <b>Test Channel :</b> | 06 Full RU |
|--------------------|---------------|-----------------------|------------|

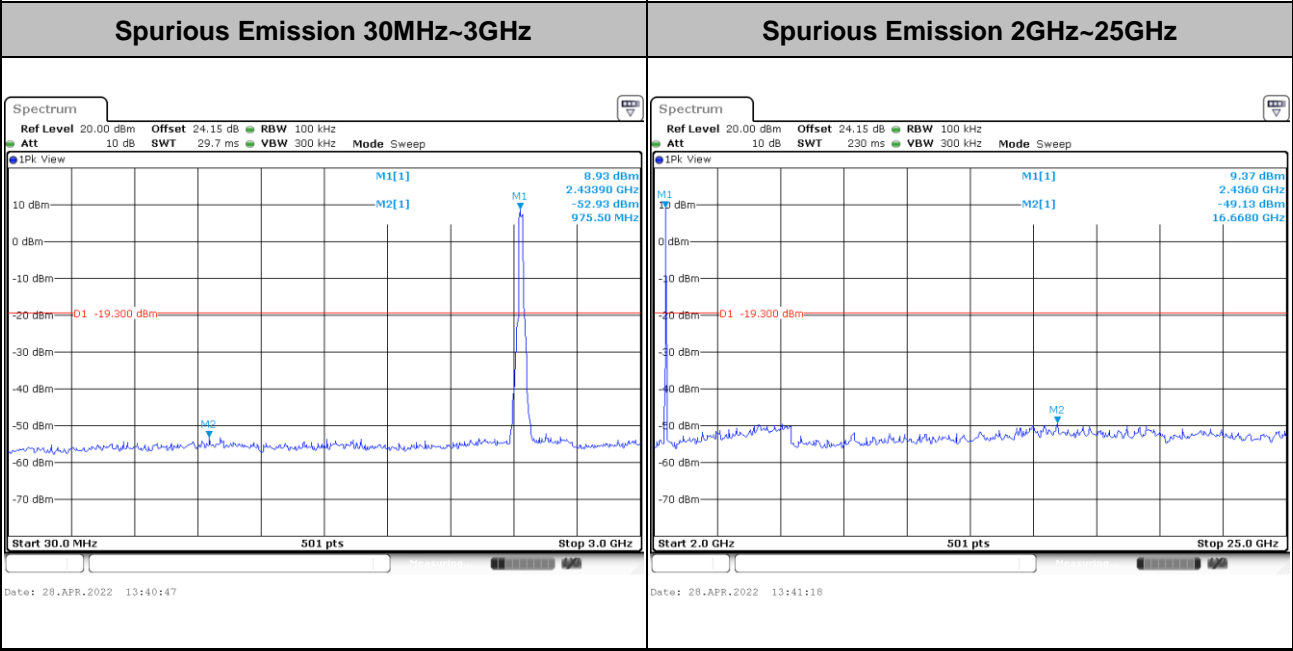
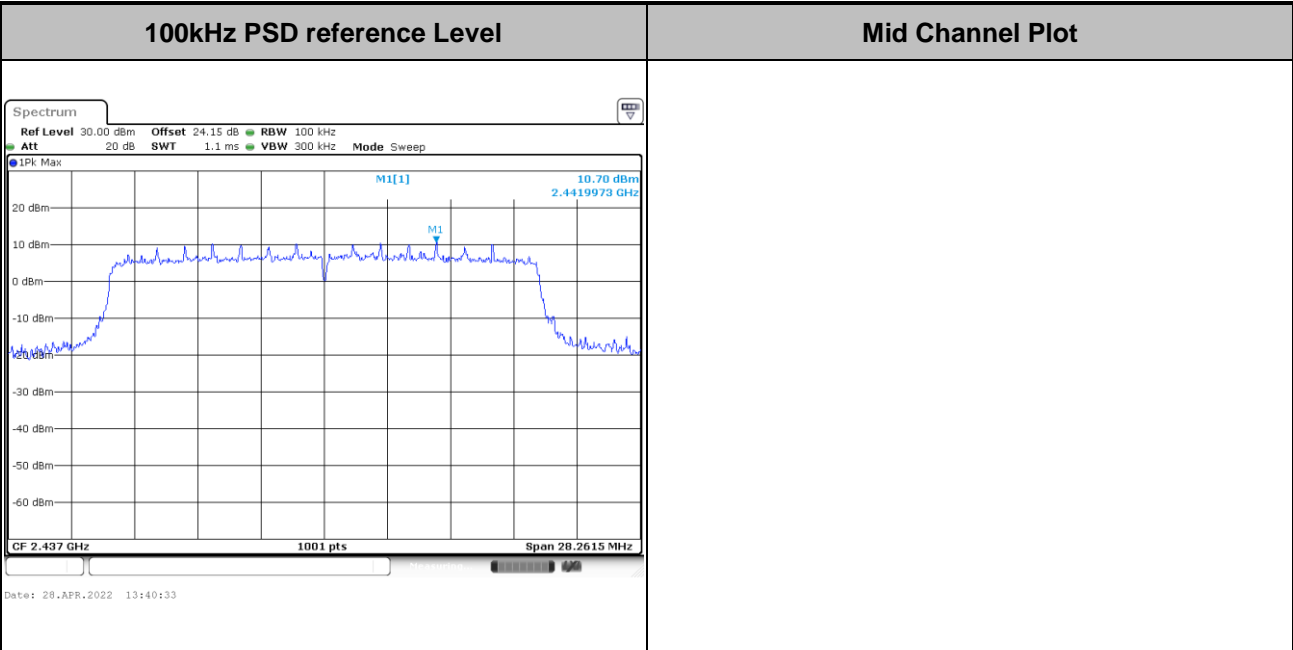



|             |               |                |            |
|-------------|---------------|----------------|------------|
| Test Mode : | 802.11ax HE20 | Test Channel : | 11 Full RU |
|-------------|---------------|----------------|------------|

