



FCC RADIO TEST REPORT

FCC ID : A4RGE2AE
Equipment : Phone
Applicant : Google LLC
1600 Amphitheatre Parkway,
Mountain View, California, 94043 USA
Standard : FCC Part 15 Subpart C §15.225

The product was received on Mar. 10, 2022 and testing was performed from Mar. 29, 2022 to Apr. 28, 2022. We, Sporton International Inc. EMC & Wireless Communications Laboratory, would like to declare that the tested sample has been evaluated in accordance with the test procedures and has been in compliance with the applicable technical standards.

The test results in this report apply exclusively to the tested model / sample. Without written approval from Sporton International Inc. EMC & Wireless Communications Laboratory, the test report shall not be reproduced except in full.

Approved by: Louis Wu

Sporton International Inc. EMC & Wireless Communications Laboratory
No. 52, Huaya 1st Rd., Guishan Dist., Taoyuan City 333, Taiwan (R.O.C.)



Table of Contents

| | |
|---|-----------|
| History of this test report..... | 3 |
| Summary of Test Result..... | 4 |
| 1. General Description | 5 |
| 1.1 Product Feature of Equipment Under Test | 5 |
| 1.2 Product Specification of Equipment Under Test | 5 |
| 1.3 Modification of EUT | 5 |
| 1.4 Testing Location | 6 |
| 1.5 Applicable Standards..... | 6 |
| 2. Test Configuration of Equipment Under Test..... | 7 |
| 2.1 Descriptions of Test Mode..... | 7 |
| 2.2 Connection Diagram of Test System | 8 |
| 2.3 Table for Supporting Units..... | 9 |
| 2.4 EUT Operation Test Setup | 9 |
| 3. Test Results | 10 |
| 3.1 AC Power Line Conducted Emissions Measurement | 10 |
| 3.2 20dB and 99% OBW Spectrum Bandwidth Measurement..... | 12 |
| 3.3 Frequency Stability Measurement | 13 |
| 3.4 Field Strength of Fundamental Emissions and Mask Measurement..... | 14 |
| 3.5 Radiated Emissions Measurement | 16 |
| 3.6 Antenna Requirements..... | 19 |
| 4. List of Measuring Equipment | 20 |
| 5. Uncertainty of Evaluation | 21 |
| Appendix A. Test Results of Conducted Emission Test | |
| Appendix B. Test Results of Near Field Test Items | |
| B1. Test Result of 20dB Spectrum Bandwidth | |
| B2. Test Result of Frequency Stability | |
| Appendix C. Test Results of Radiated Test Items | |
| C1. Test Result of Field Strength of Fundamental Emissions | |
| C2. Results of Radiated Emissions (9 kHz~30MHz) | |
| C3. Results of Radiated Emissions (30MHz~1GHz) | |
| Appendix D. Setup Photographs | |



History of this test report

| Report No. | Version | Description | Issue Date |
|--------------|---------|---|---------------|
| FR1O2919-05D | 01 | Initial issue of report | May 20, 2022 |
| FR1O2919-05D | 02 | 1. Revise Table of Contents and Descriptions of Test Mode 2. Remove Radiated Spurious Emissions (9kHz~30MHz) data remark 4 | Jun. 02, 2022 |
| FR1O2919-05D | 03 | 1. Revise Frequency Stability voltage in appendix B2 2. Remove model name | Jun. 06, 2022 |
| | | | |
| | | | |
| | | | |
| | | | |
| | | | |
| | | | |
| | | | |
| | | | |
| | | | |
| | | | |
| | | | |



Summary of Test Result

| Report Clause | Ref Std. Clause | Test Items | Result (PASS/FAIL) | Remark |
|---------------|---------------------|---|--------------------|--|
| 3.1 | 15.207 | AC Power Line Conducted Emissions | Pass | 19.21 dB under the limit at 27.120MHz |
| 3.2 | 15.215(c) | 20dB Spectrum Bandwidth | Pass | - |
| | 2.1049 | 99% OBW Spectrum Bandwidth | Reporting only | - |
| 3.3 | 15.225(e) | Frequency Stability | Pass | - |
| 3.4 | 15.225(a)(b)(c) | Field Strength of Fundamental Emissions | Pass | Max level 28.19 dB μ V/m at 13.560 MHz |
| 3.5 | 15.225(d) 15.209 | Radiated Spurious Emissions | Pass | 3.83 dB under the limit at 40.680MHz |
| 3.6 | 15.203 | Antenna Requirements | Pass | - |

Declaration of Conformity:

1. The test results (PASS/FAIL) with all measurement uncertainty excluded are presented in accordance with the regulation limits or requirements declared by manufacturers. It's means measurement values may risk exceeding the limit of regulation standards, if measurement uncertainty is include in test results.
2. The measurement uncertainty please refer to this report "Uncertainty of Evaluation".

Comments and Explanations:

The product specifications of the EUT presented in the report are declared by the manufacturer who shall take full responsibility for the authenticity.

Reviewed by: William Chen

Report Producer: Cindy Liu



1. General Description

1.1 Product Feature of Equipment Under Test

| Product Feature | |
|---------------------------------|---|
| Equipment | Phone |
| FCC ID | A4RGE2AE |
| EUT supports Radios application | GSM/EGPRS/WCDMA/HSPA/LTE/5G NR/ NFC/GNSS/WPC/WPT/UWB WLAN 11b/g/n HT20 WLAN 11a/n HT20/HT40 WLAN 11ac VHT20/VHT40/VHT80/VHT160 WLAN 11ax HE20/HE40/HE80/HE160 Bluetooth BR/EDR/LE |

Remark: The above EUT's information was declared by manufacturer.

| EUT Information List | |
|----------------------|----------------------------|
| S/N | Performed Test Item |
| 22271FDH30000P | Conducted Emission |
| 22271FDH30002B | Radiated Spurious Emission |
| 22271FDH300017 | RF Near Field |

1.2 Product Specification of Equipment Under Test

| Product Specification is subject to this standard | |
|---|--------------------|
| Tx/Rx Frequency | 13.553 ~ 13.567MHz |
| Channel Number | 1 |
| Antenna Type | Loop Antenna |
| Type of Modulation | ASK |

Remark: The above EUT's information was declared by manufacturer. Please refer to Comments and Explanations in report summary.

1.3 Modification of EUT

No modifications made to the EUT during the testing.



1.4 Testing Location

| | | | |
|---------------------------|---|----------------------------|------------------------------|
| Test Site | Sporton International Inc. EMC & Wireless Communications Laboratory | | |
| Test Site Location | No.52, Huaya 1st Rd., Guishan Dist., Taoyuan City 333, Taiwan (R.O.C.) TEL: +886-3-327-3456 FAX: +886-3-328-4978 | | |
| Test Site No. | Sporton Site No. | | |
| | TH03-HY | CO05-HY | 03CH07-HY |
| Test Engineer | Oscar Chi | Calvin Wang and Tom Lee | Jesse Wang and Stan Hsieh |
| Temperature | 22~24°C | 23~26°C | 23.6~24.8°C |
| Relative Humidity | 53~55% | 45~55% | 55.2~60.3% |

Note: The test site complies with ANSI C63.4 2014 requirement.

FCC designation No.: TW1190

1.5 Applicable Standards

According to the specifications declared by the manufacturer, the EUT must comply with the requirements of the following standards:

- ♦ FCC Part 15 Subpart C §15.225
- ♦ FCC KDB 414788 D01 Radiated Test Site v01r01
- ♦ ANSI C63.10-2013

Remark:

1. All the test items were validated and recorded in accordance with the standards without any modification during the testing.
2. The TAF code is not including all the FCC KDB listed without accreditation.



2. Test Configuration of Equipment Under Test

2.1 Descriptions of Test Mode

Investigation has been done on all the possible configurations.

The following table is a list of the test modes shown in this test report.

| Test Items | |
|-----------------------------------|---|
| AC Power Line Conducted Emissions | Field Strength of Fundamental Emissions |
| 20dB Spectrum Bandwidth | Frequency Stability |
| Radiated Emissions 9kHz~30MHz | Radiated Emissions 30MHz~1GHz |

The EUT pre-scanned in reader mode with NFC tag (four NFC type A, B, F, V) and without reading tag. Based on the highest field strength of fundamental and spurious emissions, the worst case type (type F) was recorded in this report.

The measured emission level of the EUT was maximized by rotating the EUT on a turntable, adjusting the orientation of the EUT and EUT antenna in three orthogonal axis (X: flat, Y: portrait, Z: landscape) and Accessory (Adapter or Earphone), and adjusting the measurement antenna orientation, following C63.10 exploratory test procedures and find Z plane as worst plane.

| Test Cases | |
|---|--|
| AC Conducted Emission | Mode 1: GSM850 Idle + WLAN Idle + Bluetooth Idle + NFC Read + USB Cable 1 (Charging from Adapter 2) |
| Remark: | |
| <ol style="list-style-type: none"> For Radiated Test Cases, the tests were performed with Adapter 2 and USB Cable 1. During the preliminary test, both charging modes (Adapter mode and WPT Charging mode) were verified. It is determined that the adaptor mode is the worst case for official test. | |

2.2 Connection Diagram of Test System

<AC Conducted Emission Mode>

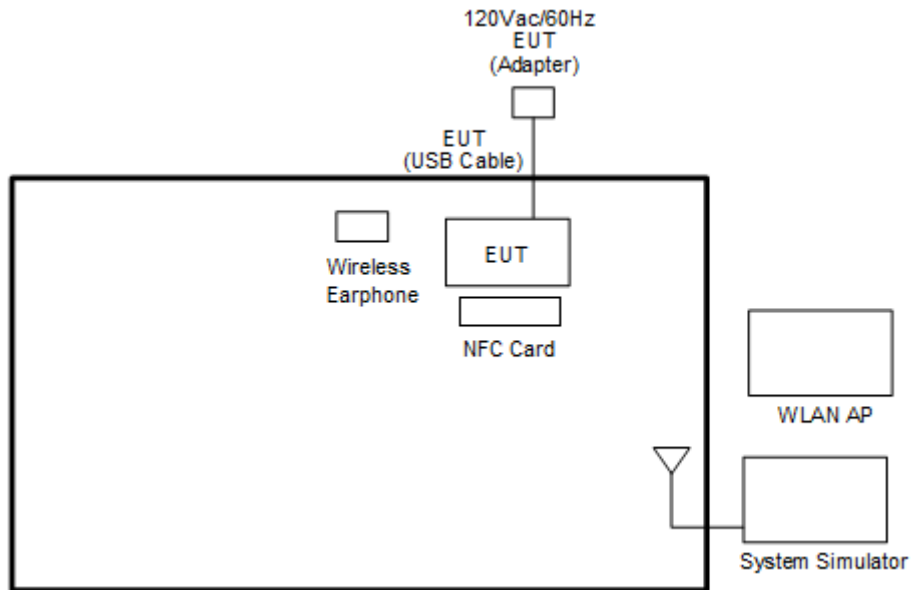

<NFC Tx with Adapter Mode>

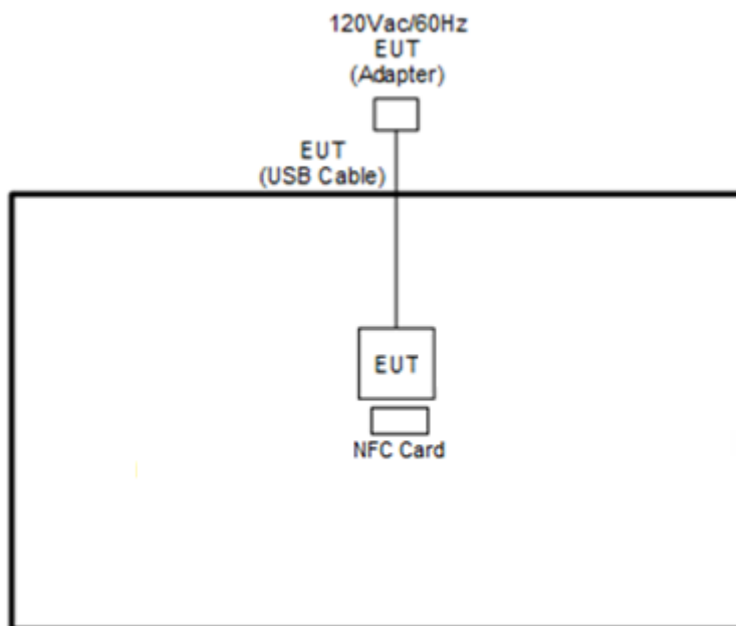

<NFC Tx with Earphone Mode>

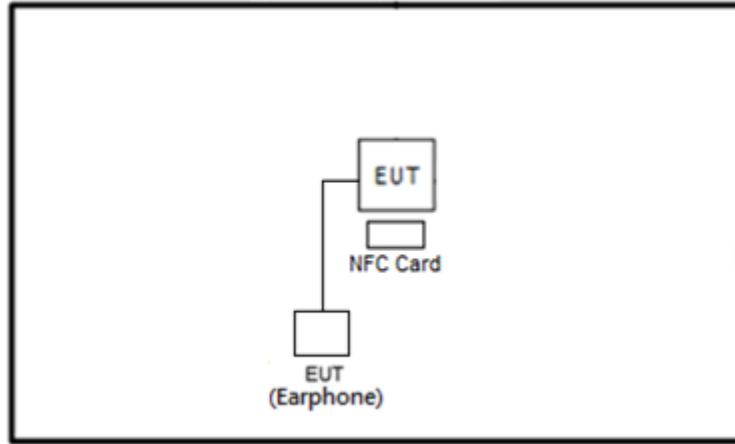

2.3 Table for Supporting Units

| Item | Equipment | Brand Name | Model Name | FCC ID | Data Cable | Power Cord |
|------|-------------------|------------|-------------|-----------------------|------------|-------------------|
| 1. | System Simulator | Anritsu | MT8820C | N/A | N/A | Unshielded, 1.8 m |
| 2. | Wireless Earphone | Google | G1007/G1008 | A4RG1007/ A4RG1008 | N/A | N/A |
| 3. | WLAN AP | ASUS | RT-AC66U | MSQ-RTAC66U | N/A | Unshielded, 1.8 m |
| 4. | NFC Card | N/A | N/A | N/A | N/A | N/A |

2.4 EUT Operation Test Setup

The EUT is programmed to be in continuously transmitting mode.

The ancillary equipment, NFC card, is used to make the EUT (NFC) continuously transmitting signal (Power Level: Default) at 13.56MHz and is placed around 0 cm gap to the EUT.



3. Test Results

3.1 AC Power Line Conducted Emissions Measurement

3.1.1 Limit of AC Conducted Emission

For equipment that is designed to be connected to the public utility (AC) power line, the radio frequency voltage that is conducted back onto the AC power line on any frequency or frequencies within the band 150 kHz to 30 MHz shall not exceed the limits in the following table.

| Frequency of Emission (MHz) | Conducted Limit (dBµV) | |
|-----------------------------|------------------------|-----------|
| | Quasi-Peak | Average |
| 0.15-0.5 | 66 to 56* | 56 to 46* |
| 0.5-5 | 56 | 46 |
| 5-30 | 60 | 50 |

*Decreases with the logarithm of the frequency.

For terminal test result, the testing follows FCC KDB 174176.

3.1.2 Measuring Instruments

Please refer to the measuring equipment list in this test report.

3.1.3 Test Procedures

1. The EUT is placed 0.4 meter away from the conducting wall of the shielding room, and is kept at least 80 centimeters from any other grounded conducting surface.
2. Connect EUT to the power mains through a line impedance stabilization network (LISN).
3. All the support units are connecting to the other LISN.
4. The LISN provides 50 ohm coupling impedance for the measuring instrument.
5. The FCC states that a 50 ohm, 50 microhenry LISN shall be used.
6. Both Line and Neutral shall be tested in order to find out the maximum conducted emission.
7. The frequency range from 150 kHz to 30 MHz is scanned.
8. Set the test-receiver system to Peak Detect Function and specified bandwidth (IF Bandwidth = 9 kHz) with Maximum Hold Mode. Then measurement is also conducted by Average Detector and Quasi-Peak Detector Function respectively.

3.1.4 Test setup

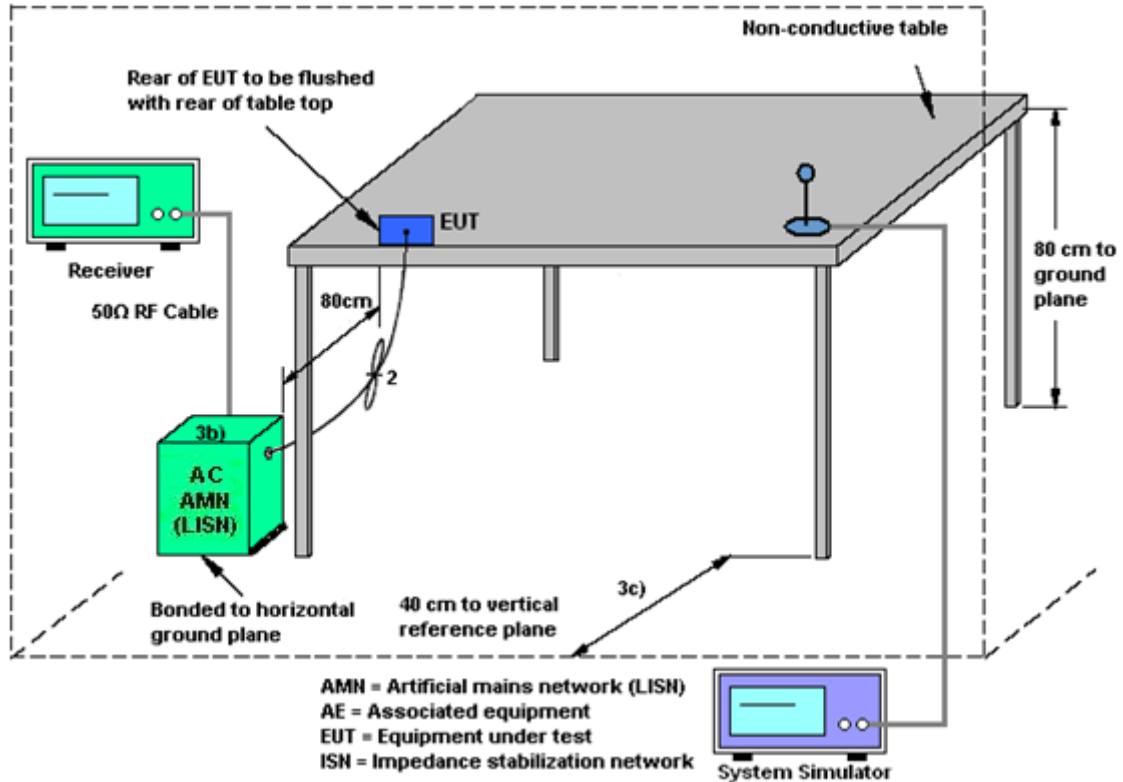

3.1.5 Test Result of AC Conducted Emission

Please refer to Appendix A.

Note:

(1) with antenna

Remark: 13.560 MHz is the NFC RF fundamental signal.

(2) with dummy load

Remark: Only the fundamental NFC signal needs to be retested per C63.4.

3.2 20dB and 99% OBW Spectrum Bandwidth Measurement

3.2.1 Limit

Intentional radiators must be designed to ensure that the 20 dB and 99% emission bandwidth in the specific band 13.553~13.567 MHz.

3.2.2 Measuring Instruments

Please refer to the measuring equipment list in this test report.

3.2.3 Test Procedures

1. The spectrum analyzer connected via a receive antenna placed near the EUT in peak Max Hold Mode.
2. The resolution bandwidth of 1 kHz and the video bandwidth of 3 kHz were used.
3. Measured the spectrum width with power higher than 20 dB below carrier.
4. Measured the 99% OBW.

3.2.4 Test Setup

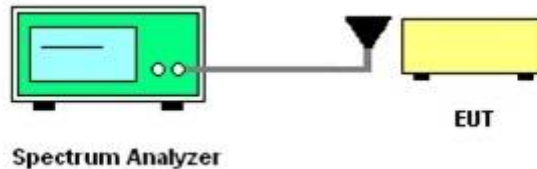

3.2.5 Test Result of RF Near Field Test Items

Please refer to Appendix B.

3.3 Frequency Stability Measurement

3.3.1 Limit

The frequency tolerance of the carrier signal shall be maintained within +/- 0.01% (100ppm) of the operating frequency over a temperature variation of -20 degrees to +50 degrees C at normal supply voltage, and for a variation in the primary supply voltage from 85% to 115% of the rated supply voltage at a temperature of 20 degrees C. For battery operated equipment, the equipment tests shall be performed by using a new battery.

3.3.2 Measuring Instruments

Please refer to the measuring equipment list in this test report.

3.3.3 Test Procedures

1. The spectrum analyzer connected via a receive antenna placed near the EUT.
2. EUT has transmitted signal and fixed channelize.
3. Set the spectrum analyzer span to view the entire emissions bandwidth.
4. Set RBW = 1 kHz, VBW = 3 kHz with peak detector and maxhold settings.
5. The f_c is declaring of channel frequency. Then the frequency error formula is $(f_c - f) / f_c \times 10^6$ ppm and the limit is less than ± 100 ppm.
6. Extreme temperature rule is -20°C~50°C.

3.3.4 Test Setup

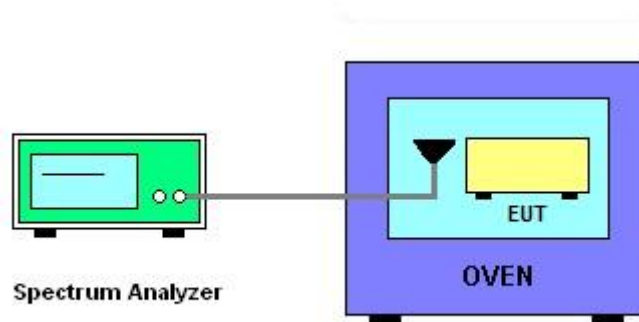

3.3.5 Test Result of Near Field Test Items

Please refer to Appendix B.



3.4 Field Strength of Fundamental Emissions and Mask Measurement

3.4.1 Limit

| Rules and specifications | FCC CFR 47 Part 15 section 15.225 | | | |
|--------------------------|---|--------------------------------|--------------------------------|-------------------------------|
| Description | Compliance with the spectrum mask is tested with RBW set to 9kHz. | | | |
| Freq. of Emission (MHz) | Field Strength (μV/m) at 30m | Field Strength (dBμV/m) at 30m | Field Strength (dBμV/m) at 10m | Field Strength (dBμV/m) at 3m |
| 1.705~13.110 | 30 | 29.5 | 48.58 | 69.5 |
| 13.110~13.410 | 106 | 40.5 | 59.58 | 80.5 |
| 13.410~13.553 | 334 | 50.5 | 69.58 | 90.5 |
| 13.553~13.567 | 15848 | 84.0 | 103.08 | 124.0 |
| 13.567~13.710 | 334 | 50.5 | 69.58 | 90.5 |
| 13.710~14.010 | 106 | 40.5 | 59.58 | 80.5 |
| 14.010~30.000 | 30 | 29.5 | 48.58 | 69.5 |

Remark:

1. The field strength test result is in 3m test distance, follow test rules the test data use distance extrapolation factor and reported in this report at 30m test result.
2. Distance extrapolation factor = $40 \log(\text{specific distance} / \text{test distance})$ (dB)

3.4.2 Measuring Instruments

Please refer to the measuring equipment list in this test report.

3.4.3 Test Procedures

1. Configure the EUT according to ANSI C63.10. The EUT is placed on the top of the turntable 0.8 meter above ground. The phase center of the loop receiving antenna mounted antenna tower is placed 3 meters far away from the turntable.
 2. Power on the EUT and all the supporting units. The turntable is rotated by 360 degrees to determine the position of the highest radiation.
 3. The height of the receiving antenna is fixed at one meter above ground to find the maximum emissions field strength.
 4. For Fundamental emissions, use the receiver to measure QP reading.
 5. When the radiated emissions limits are expressed in terms of the average value of the emissions, and pulsed operation is employed, the measurement field strength shall be determined by averaging over one complete pulse train, including blanking intervals, as long as the pulse train does not exceed 0.1 seconds. As an alternative (provided the transmitter operates for longer than 0.1 seconds) or in cases where the pulse train exceeds 0.1 seconds, the measured field strength shall be determined from the average absolute voltage during a 0.1 second interval during which the field strength is at its maximum value.
 6. Compliance with the spectrum mask is tested with RBW set to 9 kHz.
- Note: Emission level (dB μ V/m) = 20 log Emission level (μ V/m).

3.4.4 Test Setup

For radiated test below 30MHz

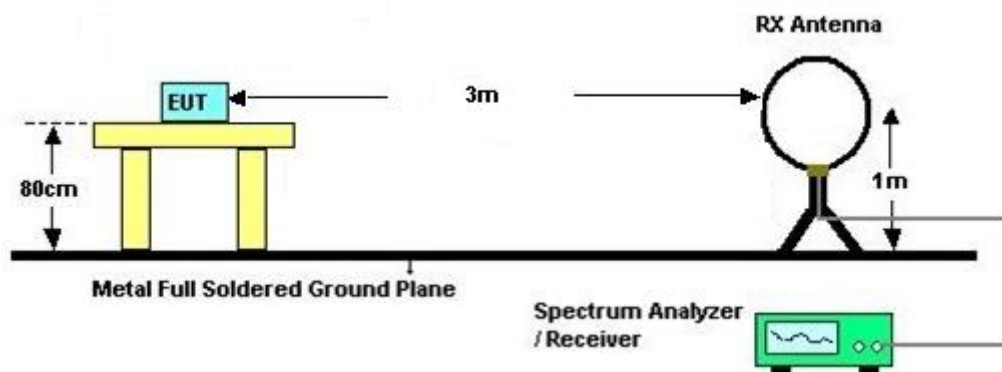

3.4.5 Test Result of Field Strength of Fundamental Emissions and Mask

Please refer to Appendix C.



3.5 Radiated Emissions Measurement

3.5.1 Limit

The field strength of any emissions which appear outside of 13.110 ~14.010MHz band shall not exceed the general radiated emissions limits.

| Frequencies (MHz) | Field Strength (µV/m) | Measurement Distance (meters) |
|-------------------|-----------------------|-------------------------------|
| 0.009~0.490 | 2400/F(kHz) | 300 |
| 0.490~1.705 | 24000/F(kHz) | 30 |
| 1.705~30.0 | 30 | 30 |
| 30~88 | 100 | 3 |
| 88~216 | 150 | 3 |
| 216~960 | 200 | 3 |
| Above 960 | 500 | 3 |

3.5.2 Measuring Instruments

Please refer to the measuring equipment list in this test report.

3.5.3 Measuring Instrument Setting

The following table is the setting of receiver:

| Receiver Parameter | Setting |
|--------------------------------|---------------------|
| Attenuation | Auto |
| Frequency Range: 9kHz~150kHz | RBW 200Hz for QP |
| Frequency Range: 150kHz~30MHz | RBW 9kHz for QP |
| Frequency Range: 30MHz~1000MHz | RBW 120kHz for Peak |

Note: The emission limits shown in the above table are based on measurements employing a CISPR quasi-peak detector except for the frequency bands 9-90 kHz and 110-490 kHz. Radiated emission limits in these two bands are based on measurements employing an average detector.



3.5.4 Test Procedures

1. Configure the EUT according to ANSI C63.10. The EUT is placed on the top of the turntable 0.8 meter above ground. The phase center of the receiving antenna mounted on the top of a height-variable antenna tower is placed 3 meters far away from the turntable.
2. Power on the EUT and all the supporting units. The turntable is rotated by 360 degrees to determine the position of the highest radiation.
3. The height of the broadband receiving antenna is varied between one meter and four meters above ground to find the maximum emissions field strength of both horizontal and vertical polarization.
4. For each suspected emissions, the antenna tower is scanned (from 1 M to 4 M) and then the turntable is rotated (from 0 degree to 360 degrees) to find the maximum reading.
5. Set the test-receiver system to Peak or CISPR quasi-peak Detect Function with specified bandwidth under Maximum Hold Mode.
6. When the radiated emissions limits are expressed in terms of the average value of the emissions, and pulsed operation is employed, the measurement field strength shall be determined by averaging over one complete pulse train, including blanking intervals, as long as the pulse train does not exceed 0.1 seconds. As an alternative (provided the transmitter operates for longer than 0.1 seconds) or in cases where the pulse train exceeds 0.1 seconds, the measured field strength shall be determined from the average absolute voltage during a 0.1 second interval during which the field strength is at its maximum value.
7. In case the emission is lower than 30 MHz, loop antenna has to be used for measurement and the recorded data shall be QP measured by receiver.

3.5.5 Test Setup

For radiated test below 30MHz

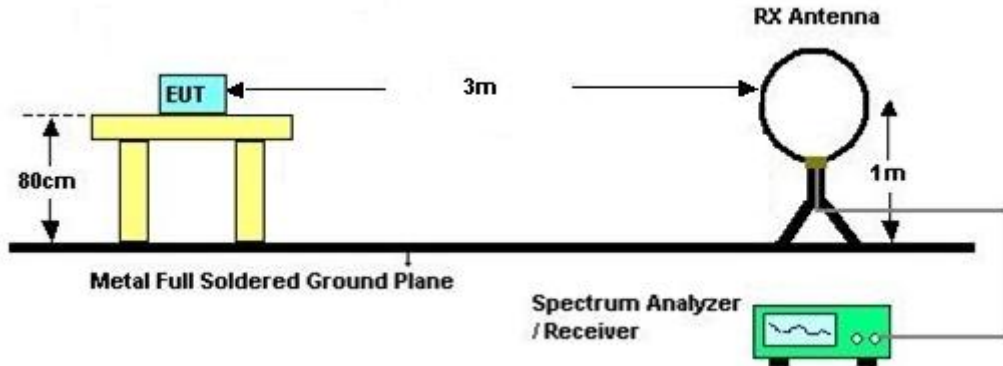

For radiated test above 30MHz

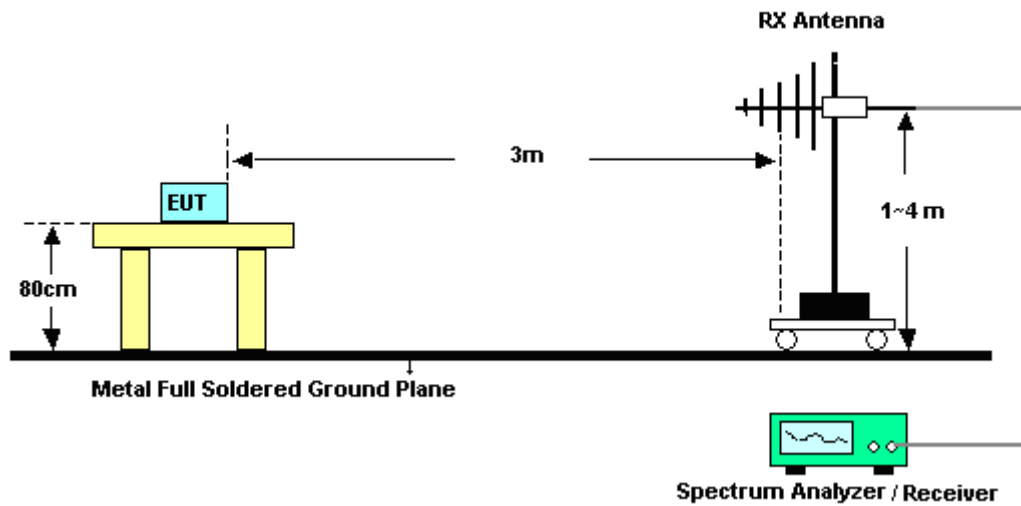

3.5.6 Test Result of Radiated Emissions Measurement

Please refer to Appendix C.

Remark: There is adequate comparison measurement of both open-field test site and alternative test site - semi-Anechoic chamber according to 414788 D01 Radiated Test Site v01r01, and the result came out very similar.



3.6 Antenna Requirements

3.6.1 Standard Applicable

Except for special regulations, the Low-power Radio-frequency Devices must not be equipped with any jacket for installing an antenna with extension cable. An intentional radiator shall be designed to ensure that no antenna other than that furnished by the responsible party shall be used with the device. The use of a permanently attached antenna or of an antenna that uses a unique coupling to the intentional radiator shall be considered sufficient to comply with the provisions of this Section. The manufacturer may design the unit so that the user can replace a broken antenna, but the use of a standard antenna jack or electrical connector is prohibited.

The use of a permanently attached antenna or of an antenna that uses a unique coupling to the intentional radiator shall be considered sufficient to comply with the rule.

3.6.2 Antenna Anti-Replacement Construction

An embedded-in antenna design is used.



4. List of Measuring Equipment

| Instrument | Brand Name | Model No. | Serial No. | Characteristics | Calibration Date | Test Date | Due Date | Remark |
|--|-----------------|----------------------------|------------|----------------------|------------------|------------------------------|---------------|-------------------------|
| Bilog Antenna | TESEQ | CBL 6111D & 00800N1D01N-06 | 35419 & 03 | 30MHz~1GHz | Apr. 28, 2021 | Apr. 14, 2022~ Apr. 15, 2022 | Apr. 27, 2022 | Radiation (03CH07-HY) |
| Loop Antenna | Rohde & Schwarz | HFH2-Z2 | 100315 | 9 kHz~30 MHz | Jan. 07, 2022 | Apr. 14, 2022~ Apr. 15, 2022 | Jan. 06, 2023 | Radiation (03CH07-HY) |
| Preamplifier | COM-POWER | PA-103A | 161241 | 10MHz~1GHz | Oct. 04, 2021 | Apr. 14, 2022~ Apr. 15, 2022 | Oct. 03, 2022 | Radiation (03CH07-HY) |
| RF Cable | HUBER + SUHNER | SUCOFLEX 104 | MY15682-4 | 30MHz to 18GHz | Feb. 23, 2022 | Apr. 14, 2022~ Apr. 15, 2022 | Feb. 22, 2023 | Radiation (03CH07-HY) |
| RF Cable | HUBER + SUHNER | SUCOFLEX 104 | MY24971-4 | 9kHz to 18GHz | Feb. 23, 2022 | Apr. 14, 2022~ Apr. 15, 2022 | Feb. 22, 2023 | Radiation (03CH07-HY) |
| RF Cable | HUBER + SUHNER | SUCOFLEX 104 | MY28655-4 | 9kHz to 18GHz | Feb. 23, 2022 | Apr. 14, 2022~ Apr. 15, 2022 | Feb. 22, 2023 | Radiation (03CH07-HY) |
| Controller | EMEC | EM1000 | N/A | Control Ant Mast | N/A | Apr. 14, 2022~ Apr. 15, 2022 | N/A | Radiation (03CH07-HY) |
| Controller | MF | MF-7802 | N/A | Control Turn table | N/A | Apr. 14, 2022~ Apr. 15, 2022 | N/A | Radiation (03CH07-HY) |
| Antenna Mast | EMEC | AM-BS-4500E | N/A | Boresight mast 1M~4M | N/A | Apr. 14, 2022~ Apr. 15, 2022 | N/A | Radiation (03CH07-HY) |
| Turn Table | ChainTek | Chaintek 3000 | N/A | 0~360 Degree | N/A | Apr. 14, 2022~ Apr. 15, 2022 | N/A | Radiation (03CH07-HY) |
| Software | Audix | E3 | N/A | N/A | N/A | Apr. 14, 2022~ Apr. 15, 2022 | N/A | Radiation (03CH07-HY) |
| USB Data Logger | TECPEL | TR-32 | HE17XB2495 | N/A | Mar. 07, 2022 | Apr. 14, 2022~ Apr. 15, 2022 | Mar. 06, 2023 | Radiation (03CH07-HY) |
| EMI Test Receiver | Agilent | N9038A(MXE) | MY53290053 | 20Hz~26.5GHz | May 24, 2021 | Apr. 14, 2022~ Apr. 15, 2022 | May 23, 2022 | Radiation (03CH07-HY) |
| AC Power Source | ChainTek | APC-1000W | N/A | N/A | N/A | Apr. 19, 2022~ Apr. 28, 2022 | N/A | Conduction (CO05-HY) |
| EMI Test Receiver | Rohde & Schwarz | ESR3 | 102388 | 9kHz~3.6GHz | Dec. 01, 2021 | Apr. 19, 2022~ Apr. 28, 2022 | Nov. 30, 2022 | Conduction (CO05-HY) |
| Hygrometer | Testo | 608-H1 | 34913912 | N/A | Nov. 17, 2021 | Apr. 19, 2022~ Apr. 28, 2022 | Nov. 16, 2022 | Conduction (CO05-HY) |
| LISN | Rohde & Schwarz | ENV216 | 100080 | 9kHz~30MHz | Dec. 03, 2021 | Apr. 19, 2022~ Apr. 28, 2022 | Dec. 02, 2022 | Conduction (CO05-HY) |
| Software | Rohde & Schwarz | EMC32 | N/A | N/A | N/A | Apr. 19, 2022~ Apr. 28, 2022 | N/A | Conduction (CO05-HY) |
| Pulse Limiter | SCHWARZBECK | VTSD 9561-F N | 00691 | N/A | Jul. 28, 2021 | Apr. 19, 2022~ Apr. 28, 2022 | Jul. 27, 2022 | Conduction (CO05-HY) |
| LISN Cable | MVE | RG-400 | 260260 | N/A | Dec. 30, 2021 | Apr. 19, 2022~ Apr. 28, 2022 | Dec. 29, 2022 | Conduction (CO05-HY) |
| 5kVA AC Power Source | TESEQ | NSG 1007 | 1521A01677 | N/A | Jun. 08, 2021 | Mar. 29, 2022 | Jun. 07, 2022 | RF Near Field (TH03-HY) |
| Hygrometer | TECPEL | DTM-303B | TP210073 | N/A | Nov. 16, 2021 | Mar. 29, 2022 | Nov. 15, 2022 | RF Near Field (TH03-HY) |
| Spectrum Analyzer | Rohde & Schwarz | FSP30 | 101329 | 9kHz~30GHz | Sep. 30, 2021 | Mar. 29, 2022 | Sep. 29, 2022 | RF Near Field (TH03-HY) |
| Temperature & Humidity Cabinet Chamber | ESPEC | LHU-113 | 1012005860 | -20°C~85°C | Dec. 09, 2021 | Mar. 29, 2022 | Dec. 08, 2022 | RF Near Field (TH03-HY) |
| Coupling loop antenna | EMCI | LF R 400 | N/A | 100KHz~50MHz | N/A | Mar. 29, 2022 | N/A | RF Near Field (TH03-HY) |



5. Uncertainty of Evaluation

Uncertainty of Conducted Emission Measurement (150 kHz ~ 30 MHz)

| | |
|---|--------|
| Measuring Uncertainty for a Level of Confidence of 95% ($U = 2Uc(y)$) | 3.1 dB |
|---|--------|

Uncertainty of Radiated Emission Measurement (9 kHz ~ 30 MHz)

| | |
|---|--------|
| Measuring Uncertainty for a Level of Confidence of 95% ($U = 2Uc(y)$) | 3.7 dB |
|---|--------|

Uncertainty of Radiated Emission Measurement (30 MHz ~ 1000 MHz)

| | |
|---|--------|
| Measuring Uncertainty for a Level of Confidence of 95% ($U = 2Uc(y)$) | 5.1 dB |
|---|--------|



Appendix A. Test Results of Conducted Emission Test

| | | |
|--|----------------------------|---------|
| Test Engineer : Calvin Wang and Tom Lee | Temperature : | 23~26°C |
| | Relative Humidity : | 45~55% |

Original

Report NO : 1O2919-05
 Test Mode : Mode 1
 Test Voltage : 120Vac/60Hz
 Phase : Line

Full Spectrum

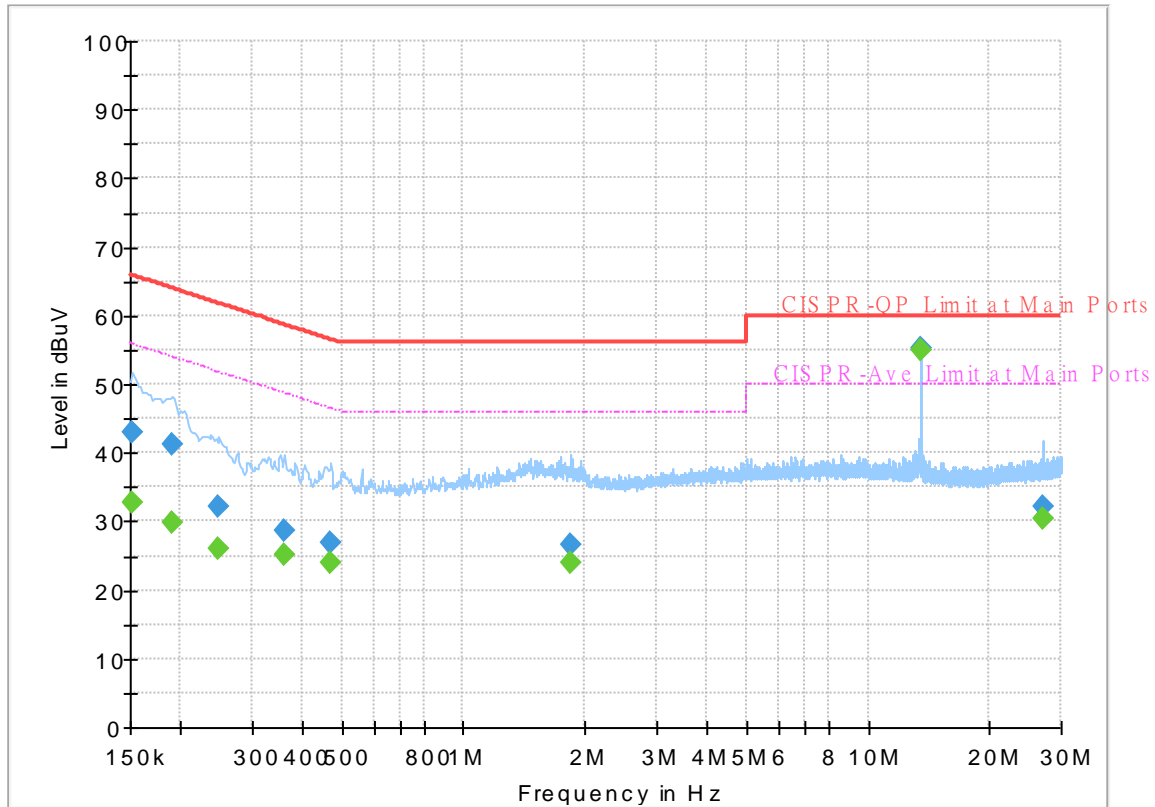

Final_Result

| Frequency (MHz) | QuasiPeak (dBuV) | CAverage (dBuV) | Limit (dBuV) | Margin (dB) | Line | Filter | Corr. (dB) |
|-----------------|------------------|-----------------|--------------|-------------|------|--------|------------|
| 0.152250 | --- | 32.72 | 55.88 | 23.16 | L1 | OFF | 19.6 |
| 0.152250 | 43.09 | --- | 65.88 | 22.79 | L1 | OFF | 19.6 |
| 0.190500 | --- | 29.92 | 54.02 | 24.10 | L1 | OFF | 19.6 |
| 0.190500 | 41.09 | --- | 64.02 | 22.93 | L1 | OFF | 19.6 |
| 0.249000 | --- | 26.10 | 51.79 | 25.69 | L1 | OFF | 19.6 |
| 0.249000 | 32.20 | --- | 61.79 | 29.59 | L1 | OFF | 19.6 |
| 0.361500 | --- | 25.14 | 48.69 | 23.55 | L1 | OFF | 19.6 |
| 0.361500 | 28.69 | --- | 58.69 | 30.00 | L1 | OFF | 19.6 |
| 0.469500 | --- | 23.92 | 46.52 | 22.60 | L1 | OFF | 19.6 |
| 0.469500 | 26.87 | --- | 56.52 | 29.65 | L1 | OFF | 19.6 |
| 1.842000 | --- | 24.12 | 46.00 | 21.88 | L1 | OFF | 19.7 |
| 1.842000 | 26.62 | --- | 56.00 | 29.38 | L1 | OFF | 19.7 |
| 13.560000 | --- | 55.05 | 50.00 | -5.05 | L1 | OFF | 20.2 |
| 13.560000 | 55.15 | --- | 60.00 | 4.85 | L1 | OFF | 20.2 |
| 27.120000 | --- | 30.55 | 50.00 | 19.45 | L1 | OFF | 20.7 |
| 27.120000 | 32.15 | --- | 60.00 | 27.85 | L1 | OFF | 20.7 |

Report NO : 1O2919-05
 Test Mode : Mode 1
 Test Voltage : 120Vac/60Hz
 Phase : Neutral

Full Spectrum

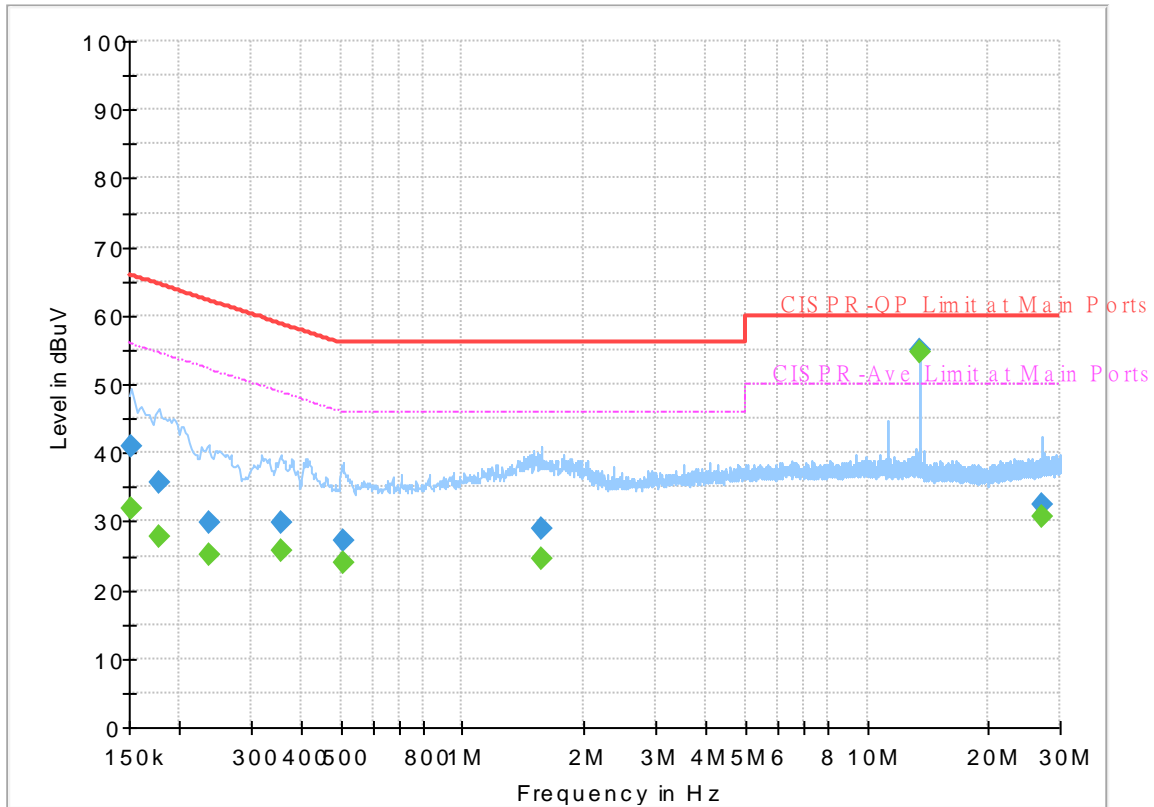

Final_Result

| Frequency (MHz) | QuasiPeak (dBuV) | CAverage (dBuV) | Limit (dBuV) | Margin (dB) | Line | Filter | Corr. (dB) |
|-----------------|------------------|-----------------|--------------|-------------|------|--------|------------|
| 0.152250 | --- | 31.87 | 55.88 | 24.01 | N | OFF | 19.6 |
| 0.152250 | 40.79 | --- | 65.88 | 25.09 | N | OFF | 19.6 |
| 0.177000 | --- | 27.91 | 54.63 | 26.72 | N | OFF | 19.6 |
| 0.177000 | 35.56 | --- | 64.63 | 29.07 | N | OFF | 19.6 |
| 0.235500 | --- | 25.19 | 52.25 | 27.06 | N | OFF | 19.6 |
| 0.235500 | 29.75 | --- | 62.25 | 32.50 | N | OFF | 19.6 |
| 0.354750 | --- | 25.65 | 48.85 | 23.20 | N | OFF | 19.6 |
| 0.354750 | 29.93 | --- | 58.85 | 28.92 | N | OFF | 19.6 |
| 0.507750 | --- | 24.12 | 46.00 | 21.88 | N | OFF | 19.6 |
| 0.507750 | 27.19 | --- | 56.00 | 28.81 | N | OFF | 19.6 |
| 1.565250 | --- | 24.56 | 46.00 | 21.44 | N | OFF | 19.7 |
| 1.565250 | 28.83 | --- | 56.00 | 27.17 | N | OFF | 19.7 |
| 13.560000 | --- | 54.80 | 50.00 | -4.80 | N | OFF | 20.2 |
| 13.560000 | 54.85 | --- | 60.00 | 5.15 | N | OFF | 20.2 |
| 27.120000 | --- | 30.79 | 50.00 | 19.21 | N | OFF | 20.7 |
| 27.120000 | 32.52 | --- | 60.00 | 27.48 | N | OFF | 20.7 |

Terminal

Report NO : 1O2919-05
 Test Mode : Mode 1
 Test Voltage : 120Vac/60Hz
 Phase : Line

Full Spectrum

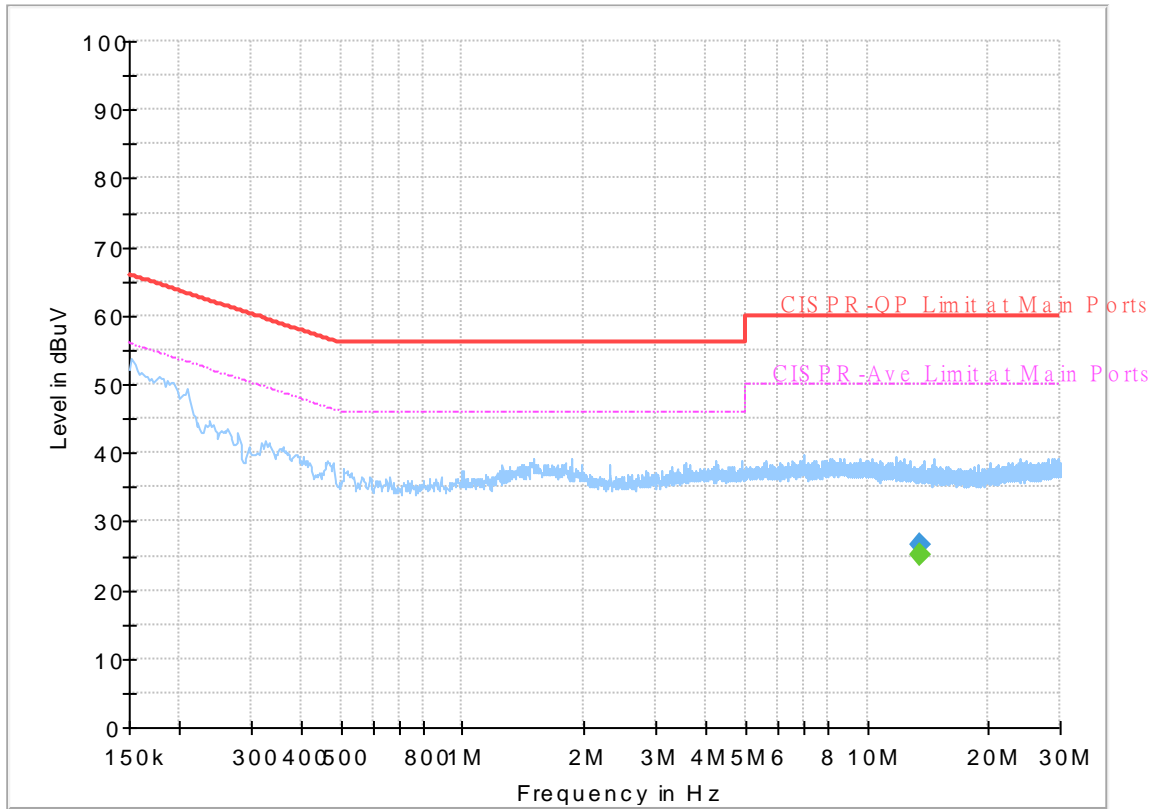

Final_Result

| Frequency (MHz) | QuasiPeak (dBuV) | CAverage (dBuV) | Limit (dBuV) | Margin (dB) | Line | Filter | Corr. (dB) |
|-----------------|------------------|-----------------|--------------|-------------|------|--------|------------|
| 13.560000 | --- | 25.19 | 50.00 | 24.81 | L1 | OFF | 20.2 |
| 13.560000 | 26.67 | --- | 60.00 | 33.33 | L1 | OFF | 20.2 |

Report NO : 1O2919-05
 Test Mode : Mode 1
 Test Voltage : 120Vac/60Hz
 Phase : Neutral

Full Spectrum

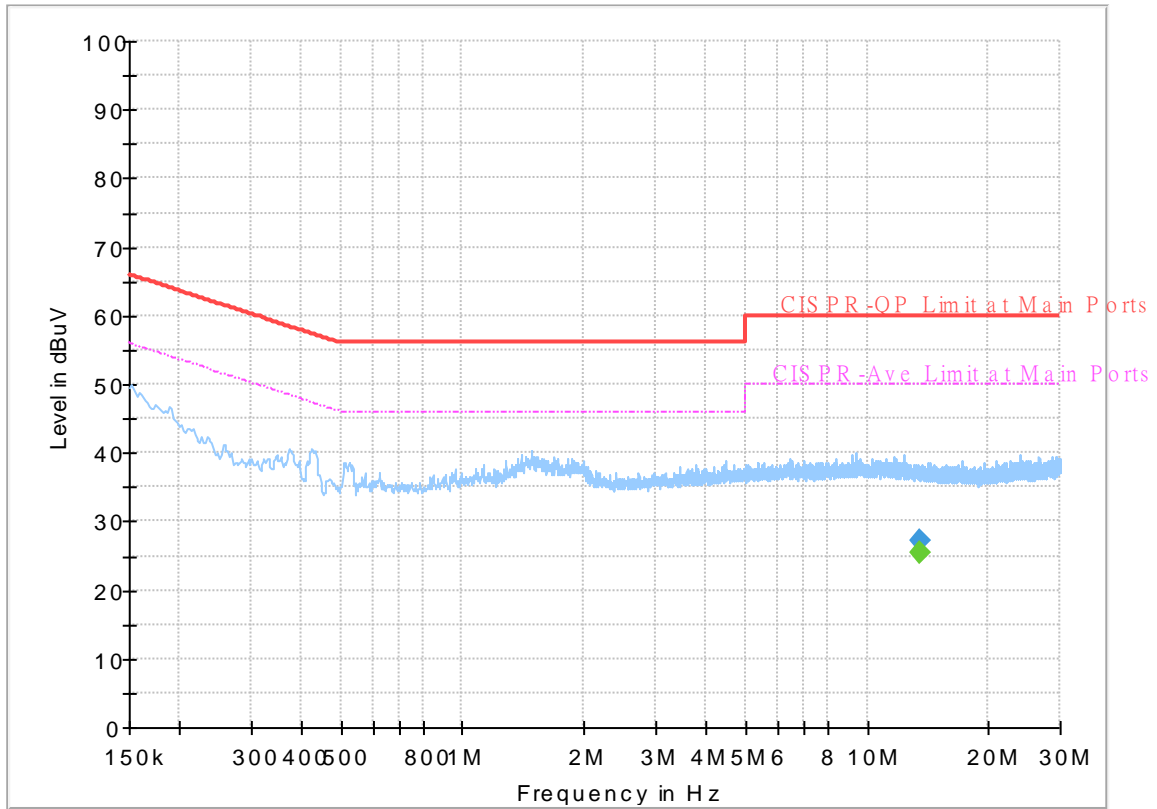

Final_Result

| Frequency (MHz) | QuasiPeak (dBuV) | CAverage (dBuV) | Limit (dBuV) | Margin (dB) | Line | Filter | Corr. (dB) |
|-----------------|------------------|-----------------|--------------|-------------|------|--------|------------|
| 13.560000 | --- | 25.53 | 50.00 | 24.47 | N | OFF | 20.2 |
| 13.560000 | 27.27 | --- | 60.00 | 32.73 | N | OFF | 20.2 |



Appendix B. Test Results of Near Field Test Items

B1. Test Result of 20dB Spectrum Bandwidth

| Test mode | NFC Tx | Test Frequency (MHz) | 13.56 |
|------------------------------|----------------|----------------------------|--------------------|
| | | | |
| 20dB Bandwidth (kHz) | 2.640 | 99% OccupiedBW(kHz) | 2.240 |
| Frequency range (MHz) | $f_L > 13.553$ | 13.55864 | Test Result |
| | $f_H < 13.567$ | 13.56128 | Complies |

Remark: Because the measured signal is CW adjusting the RBW per C63.10 would not be practical since measured bandwidth will always follow the RBW and the result will be approximately twice the RBW.



B2. Test Result of Frequency Stability

| Voltage vs. Frequency Stability | | Temperature vs. Frequency Stability | | |
|---------------------------------|-----------------------------|-------------------------------------|------|-----------------------------|
| Voltage (Vdc) | Measurement Frequency (MHz) | Temperature (°C) | Time | Measurement Frequency (MHz) |
| 3.4 | 13.559960 | -20 | 0 | 13.560060 |
| | | | 2 | 13.560060 |
| | | | 5 | 13.560050 |
| | | | 10 | 13.560060 |
| 3.85 | 13.559960 | -10 | 0 | 13.560040 |
| | | | 2 | 13.560040 |
| | | | 5 | 13.560040 |
| | | | 10 | 13.560040 |
| 4.3 | 13.559960 | 0 | 0 | 13.560000 |
| | | | 2 | 13.560010 |
| | | | 5 | 13.560020 |
| | | | 10 | 13.560020 |
| | | 10 | 0 | 13.559980 |
| | | | 2 | 13.559980 |
| | | | 5 | 13.559980 |
| | | | 10 | 13.559980 |
| | | 20 | 0 | 13.559960 |
| | | | 2 | 13.559960 |
| | | | 5 | 13.559960 |
| | | | 10 | 13.559970 |
| | | 30 | 0 | 13.559960 |
| | | | 2 | 13.559960 |
| | | | 5 | 13.559960 |
| | | | 10 | 13.559960 |
| | | 40 | 0 | 13.559940 |
| | | | 2 | 13.559960 |
| | | | 5 | 13.559940 |
| | | | 10 | 13.559960 |



| Voltage vs. Frequency Stability | | Temperature vs. Frequency Stability | | |
|---------------------------------|-----------------------------|-------------------------------------|---------------|-----------------------------|
| Voltage (Vdc) | Measurement Frequency (MHz) | Temperature (°C) | Time | Measurement Frequency (MHz) |
| | | 50 | 0 | 13.559960 |
| | | | 2 | 13.559960 |
| | | | 5 | 13.559960 |
| | | | 10 | 13.559950 |
| Max.Deviation (MHz) | -0.000040 | Max.Deviation (MHz) | | -0.000060 |
| Max.Deviation (ppm) | -2.9499 | Max.Deviation (ppm) | | -4.4248 |
| Limit | FS < ±100 ppm | Limit | FS < ±100 ppm | |
| Test Result | PASS | Test Result | PASS | |



Appendix C. Test Results of Radiated Test Items

C1. Test Result of Field Strength of Fundamental Emissions

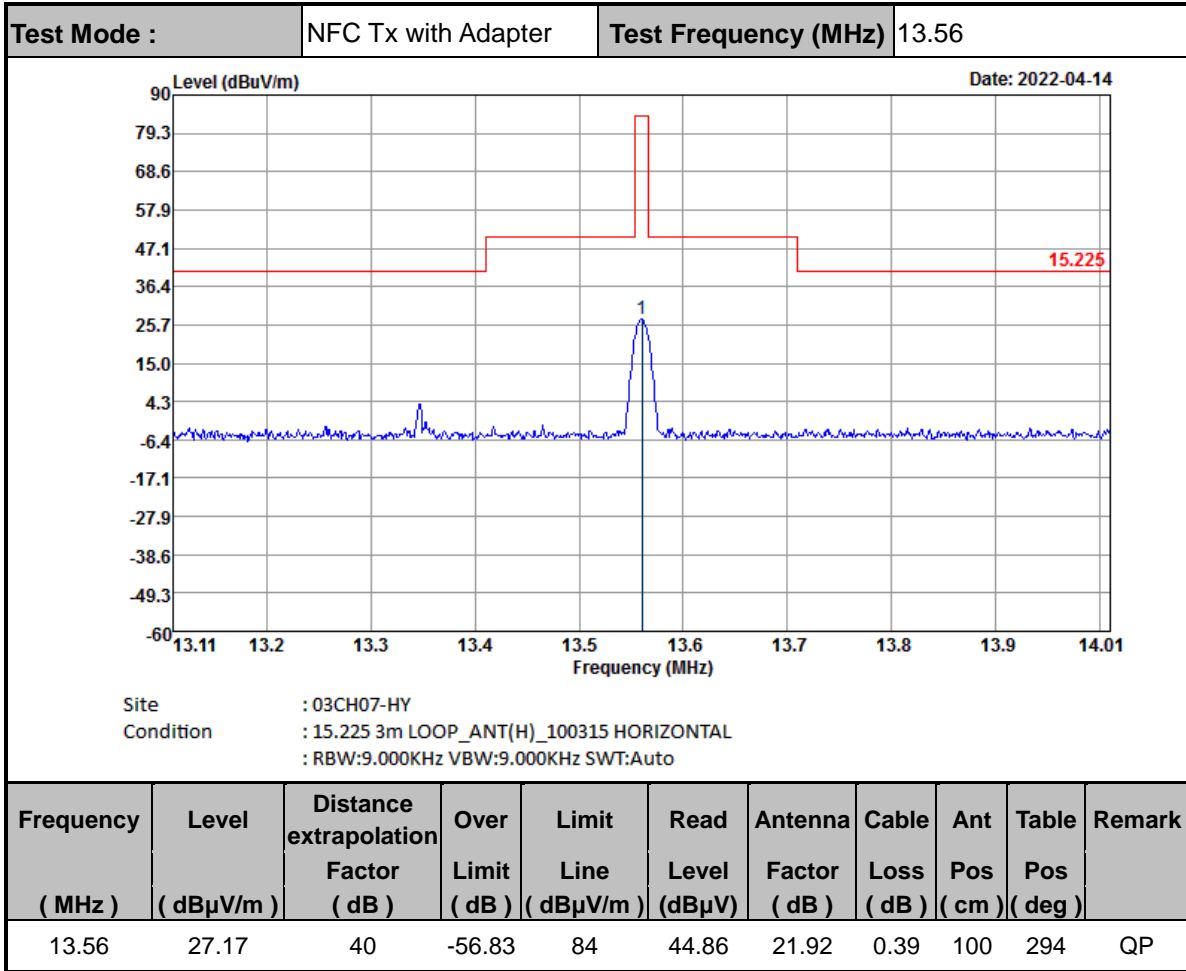

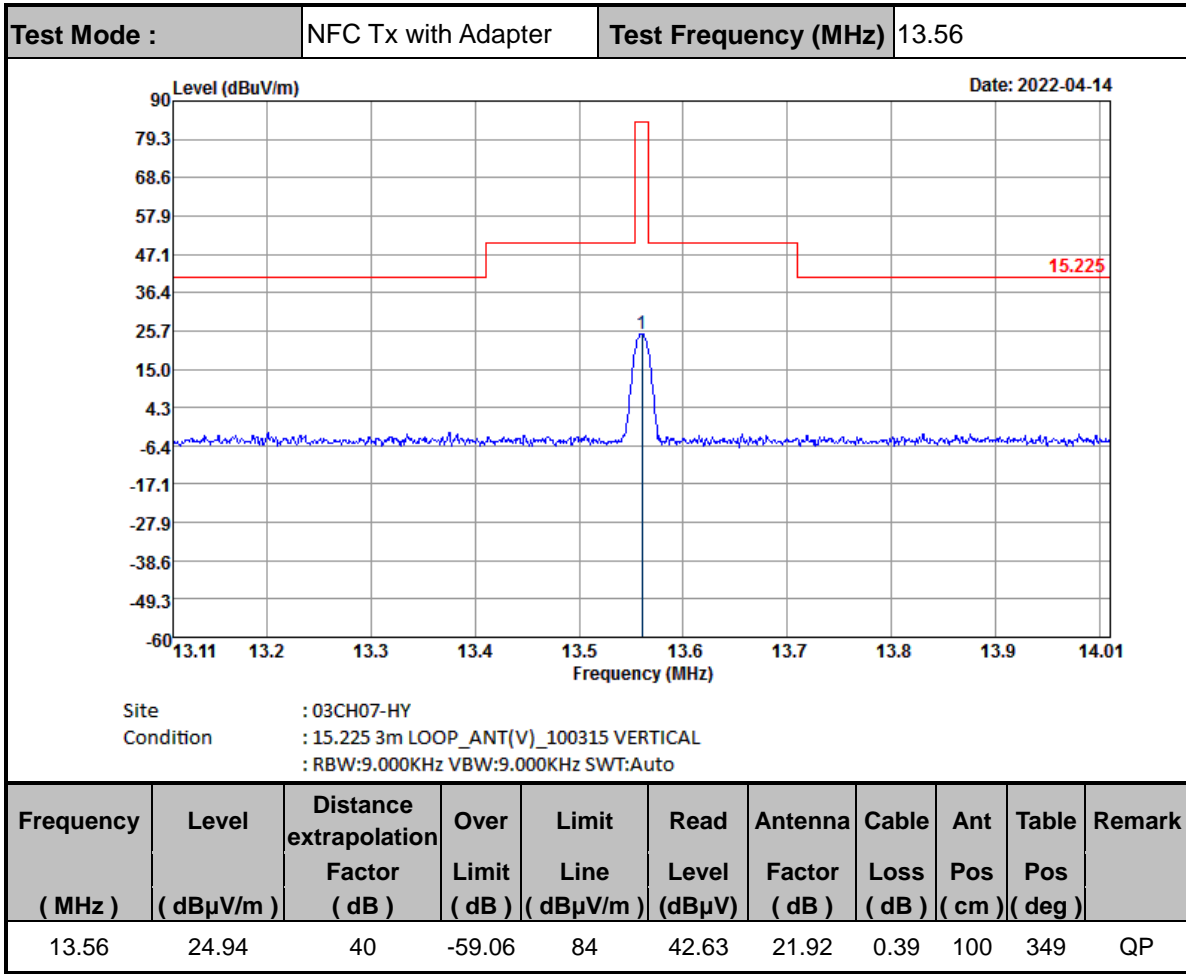

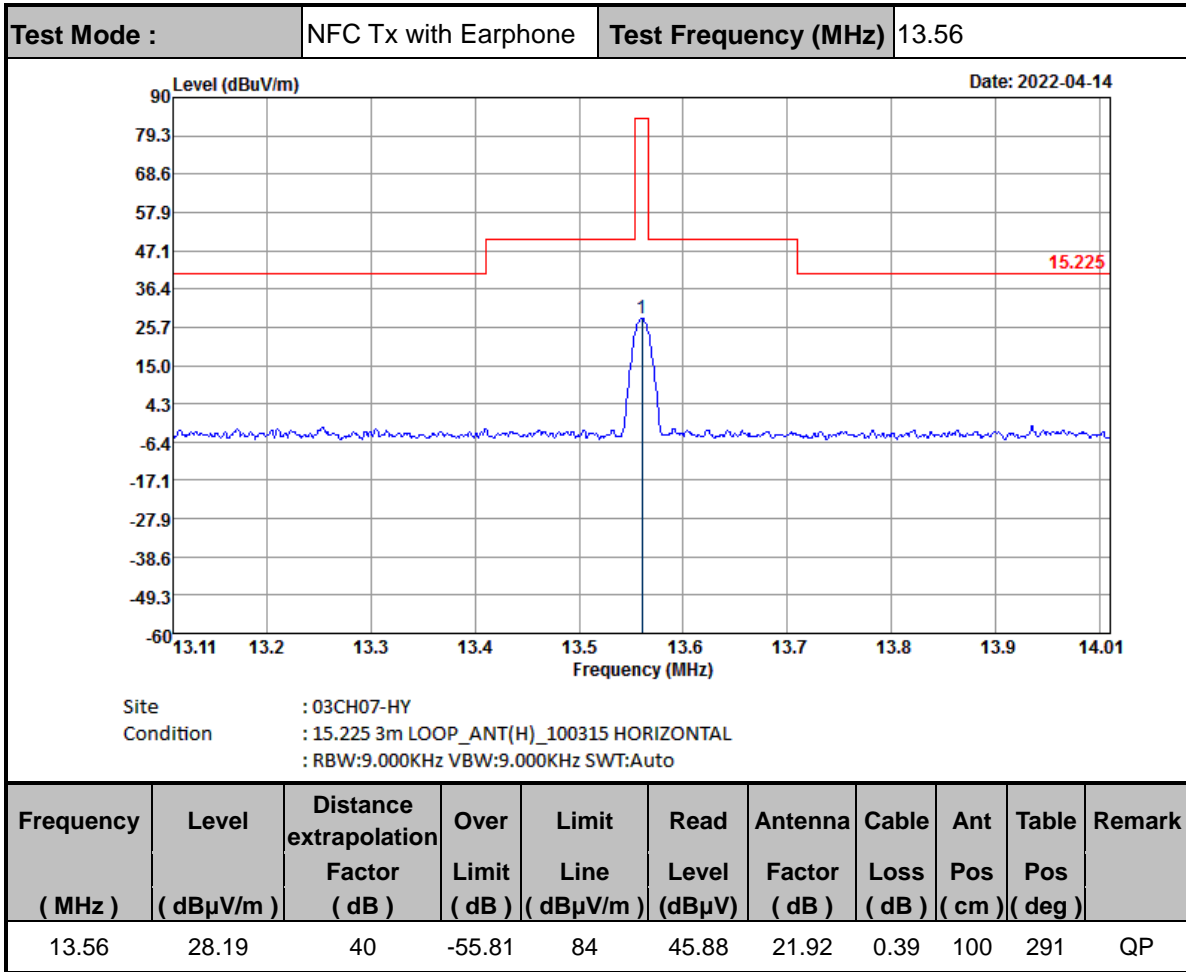



| | | | |
|-------------|----------------------|----------------------|-------|
| Test Mode : | NFC Tx with Earphone | Test Frequency (MHz) | 13.56 |
|-------------|----------------------|----------------------|-------|

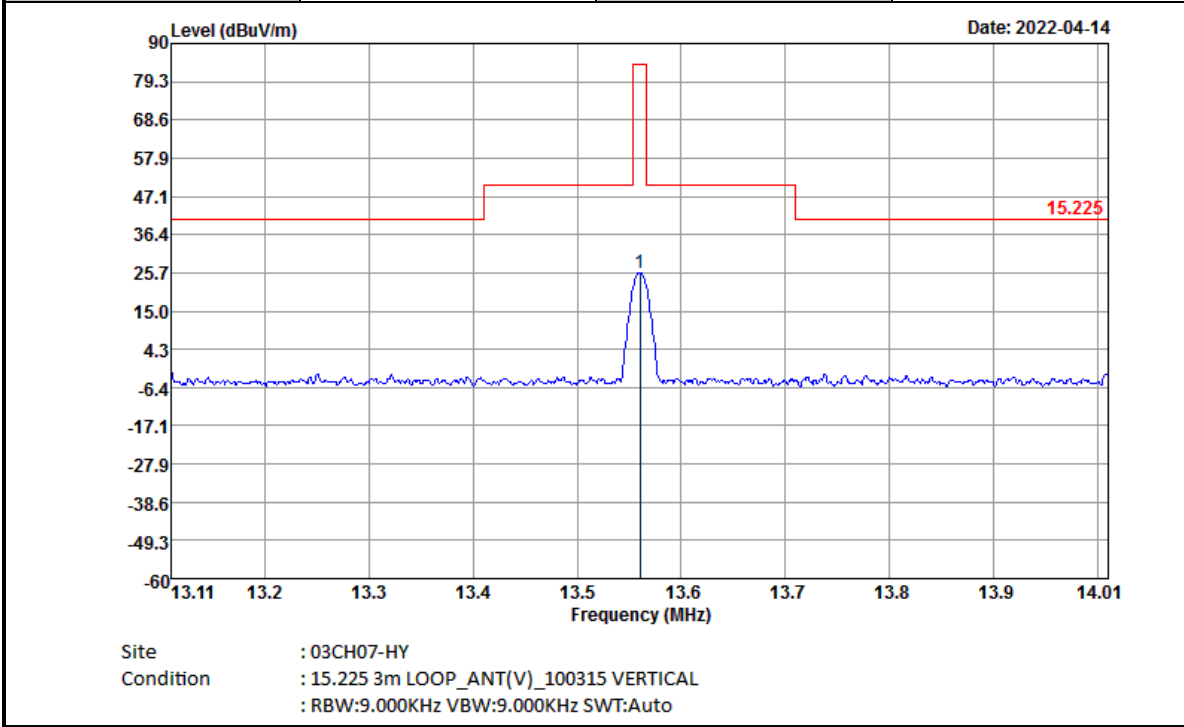

| Frequency (MHz) | Level (dBμV/m) | Distance extrapolation Factor (dB) | Over Limit (dB) | Limit Line (dBμV/m) | Read Level (dBμV) | Antenna Factor (dB) | Cable Loss (dB) | Ant Pos (cm) | Table Pos (deg) | Remark |
|-----------------|----------------|------------------------------------|-----------------|---------------------|-------------------|---------------------|-----------------|--------------|-----------------|--------|
| 13.56 | 25.85 | 40 | -58.15 | 84 | 43.54 | 21.92 | 0.39 | 100 | 0 | QP |

Note :

1. Distance extrapolation factor = 40 log (specific distance / test distance) (dB)
2. Level = Antenna Factor + Cable Loss + Read Level - Distance extrapolation factor.



C2. Results of Radiated Spurious Emissions (9 kHz~30MHz)

| | | | |
|--------------------|---------------------|-----------------------|------------|
| Test Mode : | NFC Tx with Adapter | Polarization : | Horizontal |
|--------------------|---------------------|-----------------------|------------|

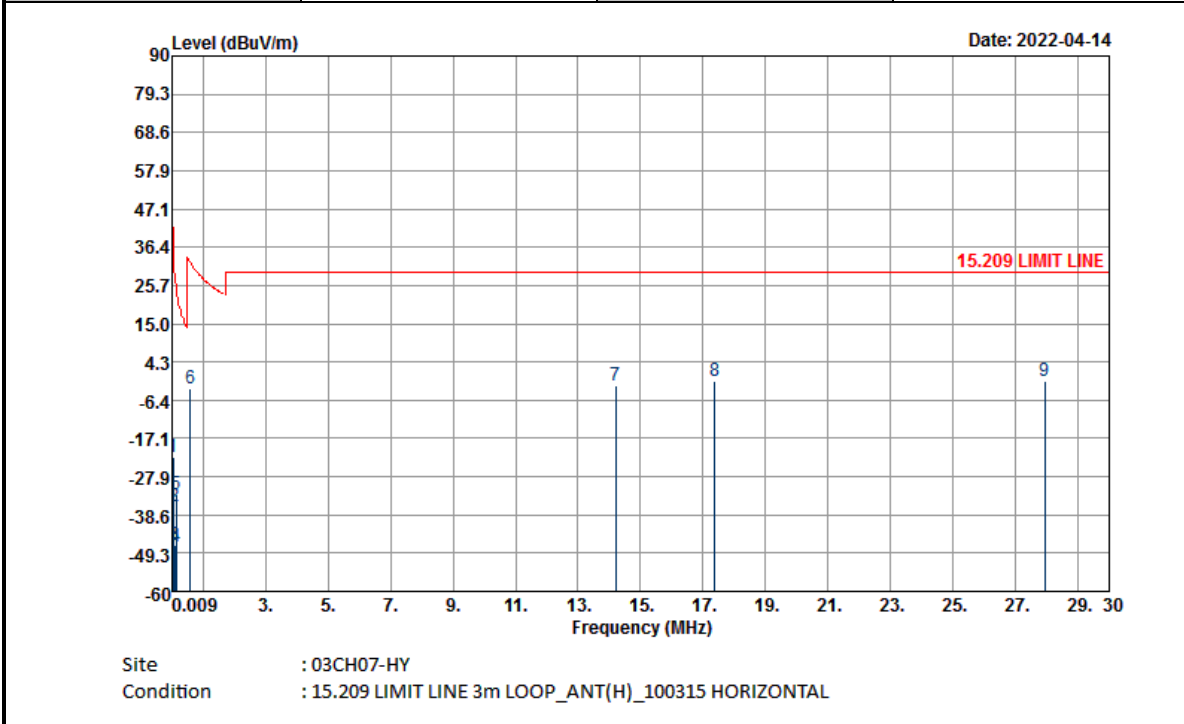

| Frequency (MHz) | Level (dBμV/m) | Distance extrapolation Factor (dB) | Over Limit (dB) | Limit Line (dBμV/m) | Read Level (dBμV) | Antenna Factor (dB) | Cable Loss (dB) | Ant Pos (cm) | Table Pos (deg) | Remark |
|-------------------|------------------|--------------------------------------|-------------------|-----------------------|-------------------|-----------------------|-------------------|----------------|-------------------|---------|
| 0.05011 | -22.5 | 80 | -56.11 | 33.61 | 37.78 | 19.7 | 0.02 | - | - | Average |
| 0.06003 | -36.24 | 80 | -68.28 | 32.04 | 24.26 | 19.48 | 0.02 | - | - | Average |
| 0.09288 | -47.09 | 80 | -75.34 | 28.25 | 14.13 | 18.76 | 0.02 | - | - | QP |
| 0.11436 | -47.37 | 80 | -73.81 | 26.44 | 13.96 | 18.65 | 0.02 | - | - | Average |
| 0.15136 | -32.68 | 80 | -56.68 | 24 | 28.51 | 18.78 | 0.03 | - | - | Average |
| 0.59514 | -3.3 | 40 | -35.41 | 32.11 | 17.15 | 19.46 | 0.09 | - | - | QP |
| 14.2 | -2.25 | 40 | -31.75 | 29.5 | 15.36 | 21.98 | 0.41 | - | - | QP |
| 17.377 | -1.29 | 40 | -30.79 | 29.5 | 15.98 | 22.26 | 0.47 | - | - | QP |
| 27.935 | -0.96 | 40 | -30.46 | 29.5 | 15.48 | 22.74 | 0.82 | - | - | QP |



| | | | |
|--------------------|---------------------|-----------------------|----------|
| Test Mode : | NFC Tx with Adapter | Polarization : | Vertical |
|--------------------|---------------------|-----------------------|----------|

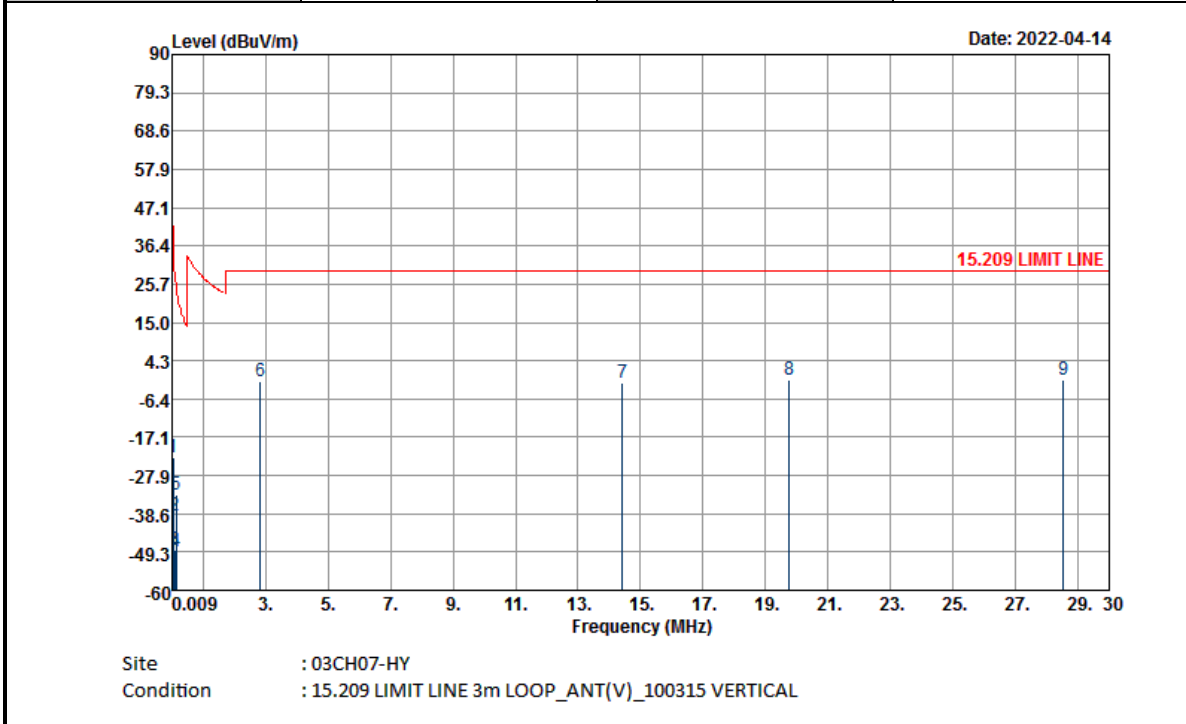

| Frequency (MHz) | Level (dBμV/m) | Distance extrapolation Factor (dB) | Over Limit (dB) | Limit Line (dBμV/m) | Read Level (dBμV) | Antenna Factor (dB) | Cable Loss (dB) | Ant Pos (cm) | Table Pos (deg) | Remark |
|----------------------|---------------------|---|-------------------------|-----------------------------|---------------------------|-----------------------------|-------------------------|----------------------|-------------------------|---------|
| 0.05011 | -22.68 | 80 | -56.29 | 33.61 | 37.6 | 19.7 | 0.02 | - | - | Average |
| 0.06003 | -39.14 | 80 | -71.18 | 32.04 | 21.36 | 19.48 | 0.02 | - | - | Average |
| 0.10024 | -48.56 | 80 | -76.14 | 27.58 | 12.82 | 18.6 | 0.02 | - | - | QP |
| 0.11684 | -49.23 | 80 | -75.48 | 26.25 | 12.09 | 18.66 | 0.02 | - | - | Average |
| 0.15 | -33.08 | 80 | -57.16 | 24.08 | 28.12 | 18.77 | 0.03 | - | - | Average |
| 2.826 | -1.49 | 40 | -30.99 | 29.5 | 18.61 | 19.7 | 0.2 | - | - | QP |
| 14.416 | -1.77 | 40 | -31.27 | 29.5 | 15.82 | 22 | 0.41 | - | - | QP |
| 19.753 | -1.15 | 40 | -30.65 | 29.5 | 15.85 | 22.48 | 0.52 | - | - | QP |
| 28.53 | -0.88 | 40 | -30.38 | 29.5 | 15.5 | 22.76 | 0.86 | - | - | QP |



| | | | |
|-------------|----------------------|----------------|------------|
| Test Mode : | NFC Tx with Earphone | Polarization : | Horizontal |
|-------------|----------------------|----------------|------------|

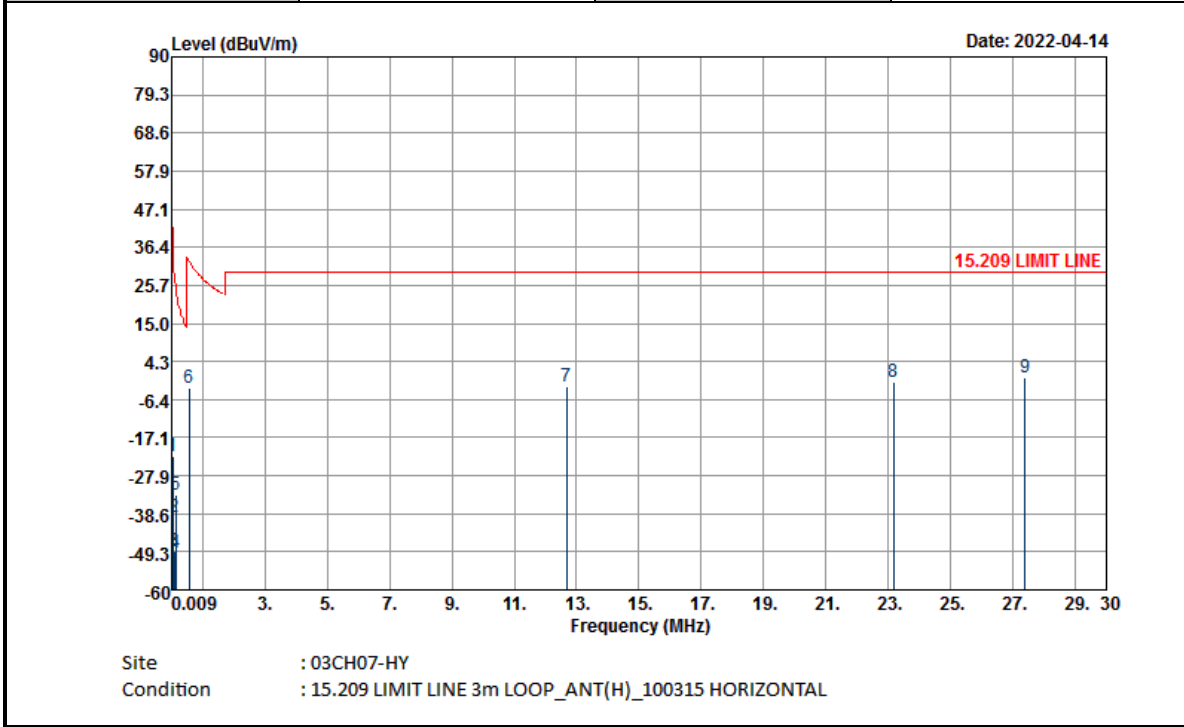

| Frequency (MHz) | Level (dBμV/m) | Distance extrapolation Factor (dB) | Over Limit (dB) | Limit Line (dBμV/m) | Read Level (dBμV) | Antenna Factor (dB) | Cable Loss (dB) | Ant Pos (cm) | Table Pos (deg) | Remark |
|-------------------|------------------|--------------------------------------|-------------------|-----------------------|---------------------|-----------------------|-------------------|----------------|-------------------|---------|
| 0.05011 | -22.49 | 80 | -56.1 | 33.61 | 37.79 | 19.7 | 0.02 | - | - | Average |
| 0.06003 | -39.38 | 80 | -71.42 | 32.04 | 21.12 | 19.48 | 0.02 | - | - | Average |
| 0.10024 | -49.3 | 80 | -76.88 | 27.58 | 12.08 | 18.6 | 0.02 | - | - | QP |
| 0.11436 | -49.7 | 80 | -76.14 | 26.44 | 11.63 | 18.65 | 0.02 | - | - | Average |
| 0.15034 | -33.38 | 80 | -57.44 | 24.06 | 27.81 | 18.78 | 0.03 | - | - | Average |
| 0.55759 | -3.32 | 40 | -36 | 32.68 | 17.17 | 19.43 | 0.08 | - | - | QP |
| 12.688 | -2.68 | 40 | -32.18 | 29.5 | 15.1 | 21.84 | 0.38 | - | - | QP |
| 23.164 | -1.35 | 40 | -30.85 | 29.5 | 15.48 | 22.59 | 0.58 | - | - | QP |
| 27.4 | -0.16 | 40 | -29.66 | 29.5 | 16.34 | 22.72 | 0.78 | - | - | QP |



| | | | |
|--------------------|----------------------|-----------------------|----------|
| Test Mode : | NFC Tx with Earphone | Polarization : | Vertical |
|--------------------|----------------------|-----------------------|----------|

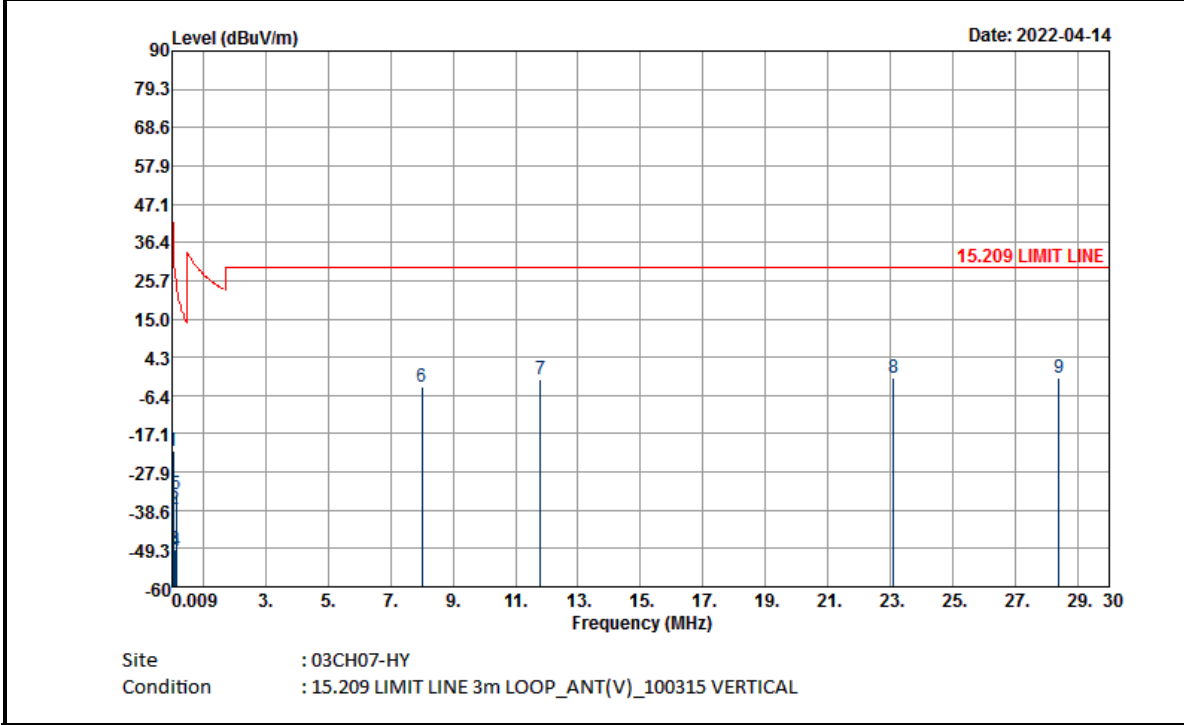

| Frequency (MHz) | Level (dBμV/m) | Distance extrapolation Factor (dB) | Over Limit (dB) | Limit Line (dBμV/m) | Read Level (dBμV) | Antenna Factor (dB) | Cable Loss (dB) | Ant Pos (cm) | Table Pos (deg) | Remark |
|-------------------|------------------|--------------------------------------|-------------------|-----------------------|---------------------|-----------------------|-------------------|----------------|-------------------|---------|
| 0.05011 | -21.95 | 80 | -55.56 | 33.61 | 38.33 | 19.7 | 0.02 | - | - | Average |
| 0.06015 | -38.35 | 80 | -70.37 | 32.02 | 22.15 | 19.48 | 0.02 | - | - | Average |
| 0.10022 | -49.38 | 80 | -76.97 | 27.59 | 12 | 18.6 | 0.02 | - | - | QP |
| 0.11672 | -50.11 | 80 | -76.37 | 26.26 | 11.21 | 18.66 | 0.02 | - | - | Average |
| 0.15 | -33.91 | 80 | -57.99 | 24.08 | 27.29 | 18.77 | 0.03 | - | - | Average |
| 8 | -4.03 | 40 | -33.53 | 29.5 | 14.95 | 20.72 | 0.3 | - | - | QP |
| 11.8 | -1.73 | 40 | -31.23 | 29.5 | 16.15 | 21.76 | 0.36 | - | - | QP |
| 23.092 | -1.34 | 40 | -30.84 | 29.5 | 15.49 | 22.59 | 0.58 | - | - | QP |
| 28.395 | -1.71 | 40 | -31.21 | 29.5 | 14.69 | 22.75 | 0.85 | - | - | QP |

Note :

1. The amplitude of spurious emissions which are attenuated by more than 20dB below the permissible value has no need to be reported.
2. Distance extrapolation factor = 40 log (specific distance / test distance) (dB)
3. Level = Antenna Factor + Cable Loss + Read Level - Distance extrapolation factor.



C3. Results of Radiated Spurious Emissions (30MHz~1GHz)

| | | | |
|--------------------|---------------------|-----------------------|------------|
| Test Mode : | NFC Tx with Adapter | Polarization : | Horizontal |
|--------------------|---------------------|-----------------------|------------|

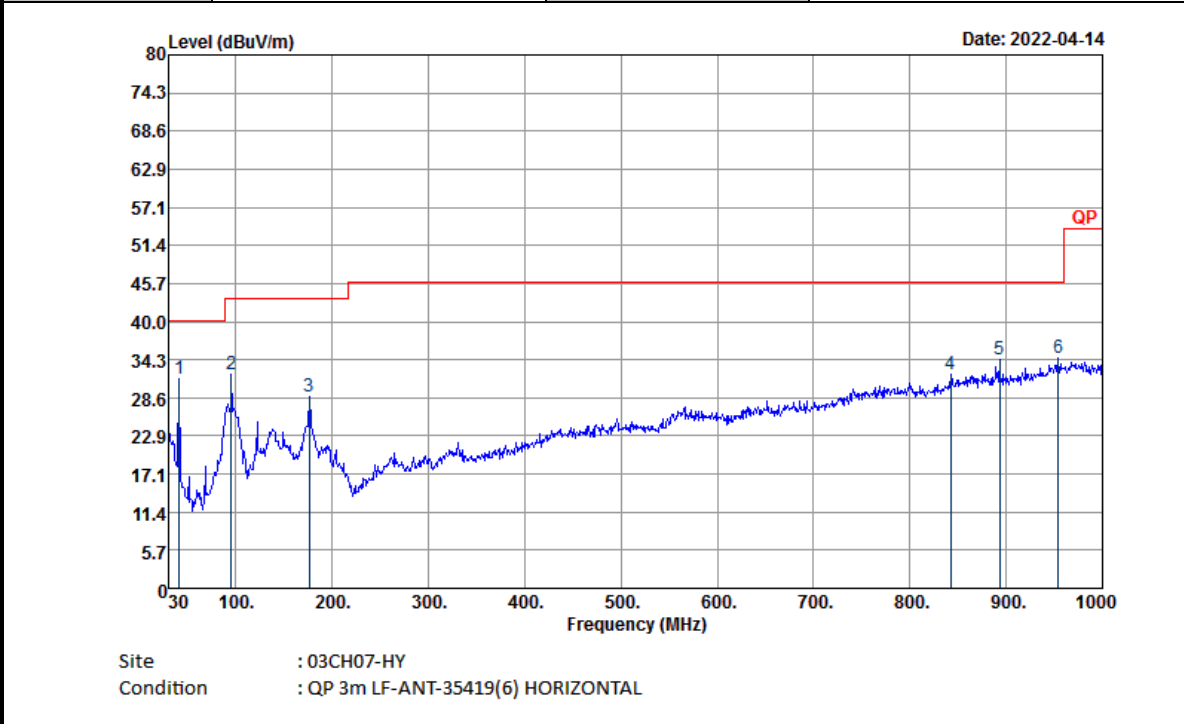

| Frequency (MHz) | Level (dBμV/m) | Over Limit (dB) | Limit Line (dBμV/m) | Read Level (dBμV) | Antenna Factor (dB) | Cable Loss (dB) | Preamp Factor (dB) | Ant Pos (cm) | Table Pos (deg) | Remark |
|-------------------|------------------|-------------------|-----------------------|---------------------|-----------------------|-------------------|----------------------|----------------|-------------------|--------|
| 40.8 | 31.44 | -8.56 | 40 | 41.53 | 19.03 | 0.94 | 30.06 | - | - | Peak |
| 94.8 | 32.06 | -11.44 | 43.5 | 45.23 | 15.26 | 1.55 | 29.98 | - | - | Peak |
| 176.34 | 28.84 | -14.66 | 43.5 | 41.37 | 15.17 | 2.16 | 29.86 | - | - | Peak |
| 842.5 | 32.14 | -13.86 | 46 | 27.85 | 28.51 | 4.87 | 29.09 | - | - | Peak |
| 892.9 | 34.3 | -11.7 | 46 | 29.45 | 28.66 | 5.04 | 28.85 | - | - | Peak |
| 953.8 | 34.6 | -11.4 | 46 | 27.56 | 30.49 | 5.19 | 28.64 | - | - | Peak |



| | | | |
|-------------|---------------------|----------------|----------|
| Test Mode : | NFC Tx with Adapter | Polarization : | Vertical |
|-------------|---------------------|----------------|----------|

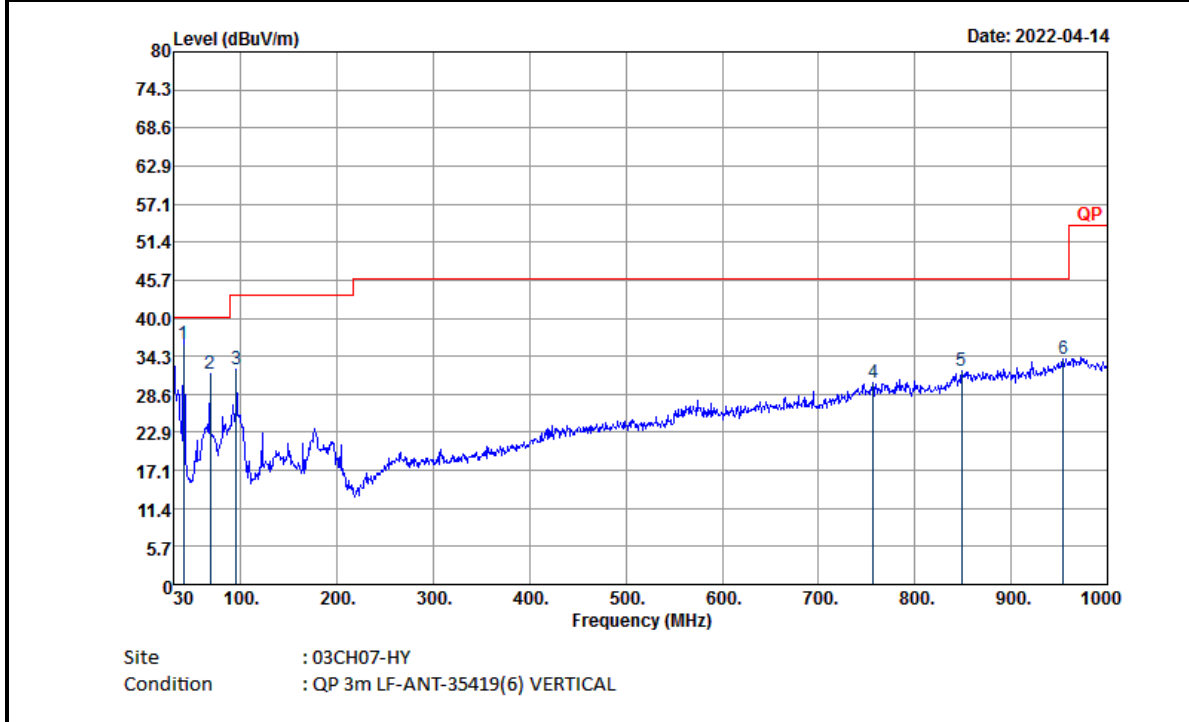

| Frequency (MHz) | Level (dBμV/m) | Over Limit (dB) | Limit Line (dBμV/m) | Read Level (dBμV) | Antenna Factor (dB) | Cable Loss (dB) | Preamp Factor (dB) | Ant Pos (cm) | Table Pos (deg) | Remark |
|-------------------|------------------|-------------------|-----------------------|---------------------|-----------------------|-------------------|----------------------|----------------|-------------------|--------|
| 40.68 | 36.17 | -3.83 | 40 | 46.21 | 19.08 | 0.94 | 30.06 | 100 | 170 | QP |
| 67.8 | 31.7 | -8.3 | 40 | 48.44 | 12.04 | 1.25 | 30.03 | - | - | Peak |
| 94.8 | 32.3 | -11.2 | 43.5 | 45.47 | 15.26 | 1.55 | 29.98 | - | - | Peak |
| 756.4 | 30.23 | -15.77 | 46 | 27.34 | 27.71 | 4.59 | 29.41 | - | - | Peak |
| 848.8 | 32.14 | -13.86 | 46 | 27.68 | 28.63 | 4.89 | 29.06 | - | - | Peak |
| 954.5 | 33.85 | -12.15 | 46 | 26.77 | 30.52 | 5.2 | 28.64 | - | - | Peak |



| | | | |
|--------------------|----------------------|-----------------------|------------|
| Test Mode : | NFC Tx with Earphone | Polarization : | Horizontal |
|--------------------|----------------------|-----------------------|------------|

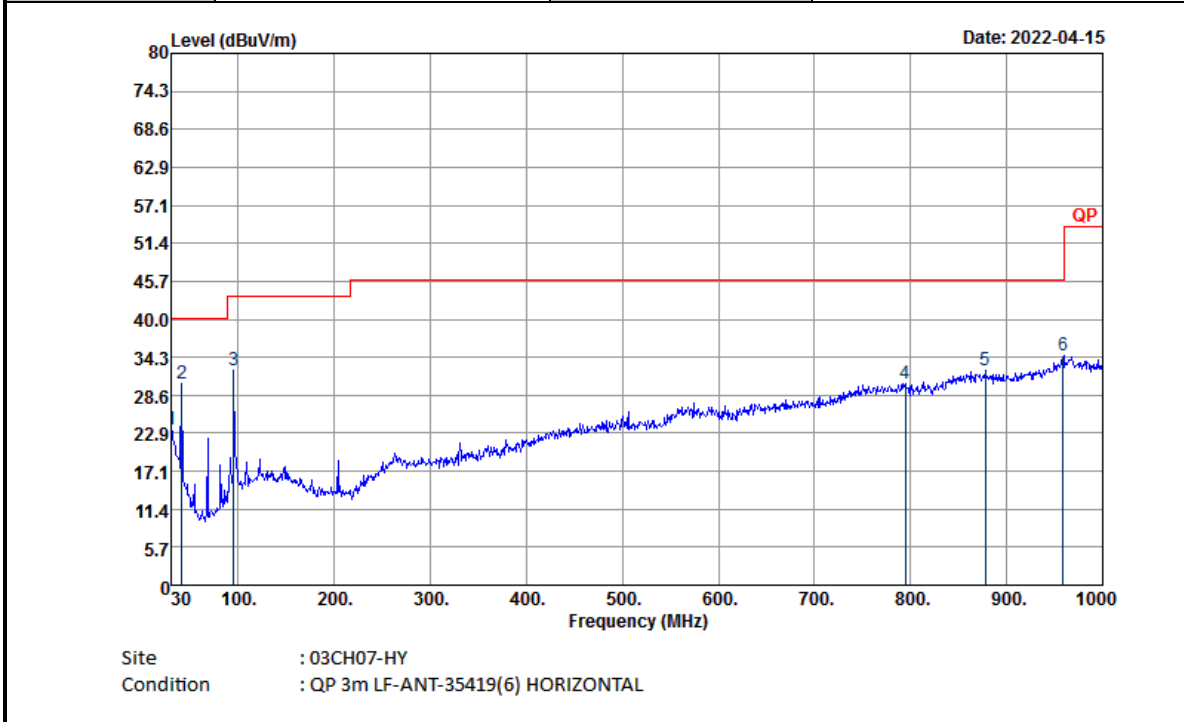

| Frequency (MHz) | Level (dBμV/m) | Over Limit (dB) | Limit Line (dBμV/m) | Read Level (dBμV) | Antenna Factor (dB) | Cable Loss (dB) | Preamp Factor (dB) | Ant Pos (cm) | Table Pos (deg) | Remark |
|-------------------|------------------|-------------------|-----------------------|---------------------|-----------------------|-------------------|----------------------|----------------|-------------------|--------|
| 30 | 23.35 | -16.65 | 40 | 27.92 | 24.57 | 0.97 | 30.11 | - | - | Peak |
| 40.8 | 30.37 | -9.63 | 40 | 40.46 | 19.03 | 0.94 | 30.06 | - | - | Peak |
| 94.8 | 32.41 | -11.09 | 43.5 | 45.58 | 15.26 | 1.55 | 29.98 | - | - | Peak |
| 794.2 | 30.41 | -15.59 | 46 | 27.12 | 27.82 | 4.74 | 29.27 | - | - | Peak |
| 877.5 | 32.31 | -13.69 | 46 | 27.49 | 28.76 | 4.98 | 28.92 | - | - | Peak |
| 958.7 | 34.45 | -11.55 | 46 | 27.11 | 30.75 | 5.21 | 28.62 | - | - | Peak |



| | | | |
|--------------------|----------------------|-----------------------|----------|
| Test Mode : | NFC Tx with Earphone | Polarization : | Vertical |
|--------------------|----------------------|-----------------------|----------|

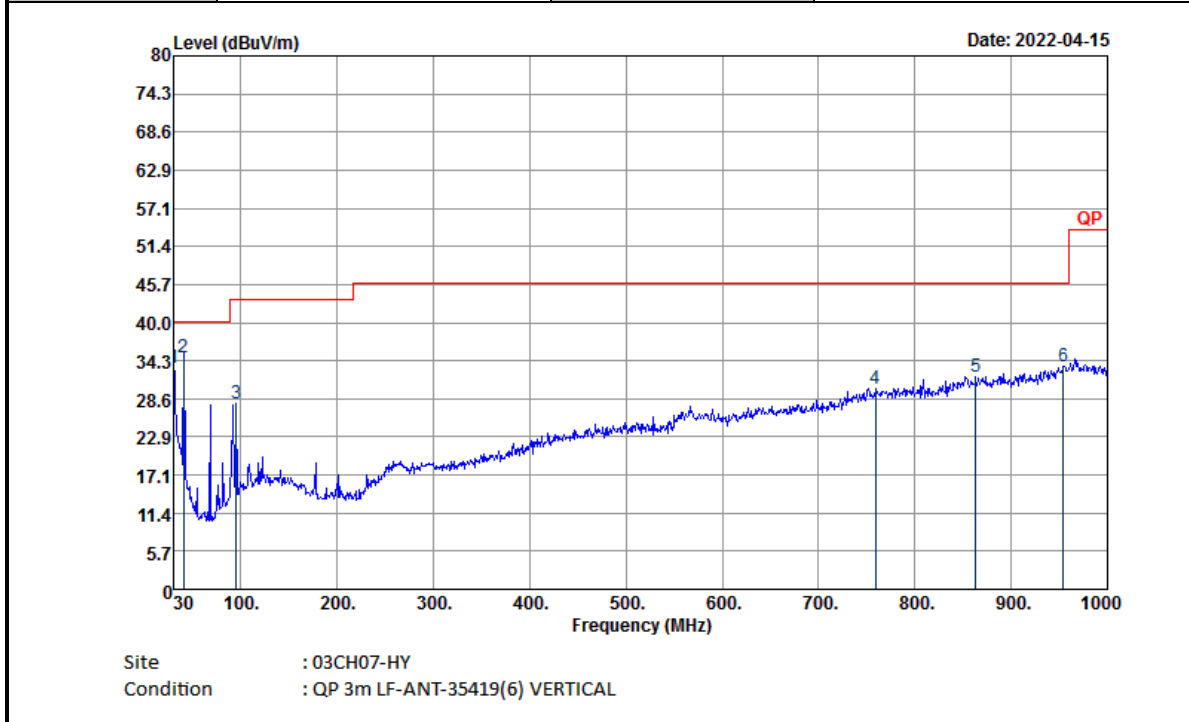

| Frequency (MHz) | Level (dBμV/m) | Over Limit (dB) | Limit Line (dBμV/m) | Read Level (dBμV) | Antenna Factor (dB) | Cable Loss (dB) | Preamp Factor (dB) | Ant Pos (cm) | Table Pos (deg) | Remark |
|-------------------|------------------|-------------------|-----------------------|---------------------|-----------------------|-------------------|----------------------|----------------|-------------------|--------|
| 30 | 33.15 | -6.85 | 40 | 37.72 | 24.57 | 0.97 | 30.11 | - | - | Peak |
| 40.68 | 34.7 | -5.3 | 40 | 44.74 | 19.08 | 0.94 | 30.06 | 100 | 356 | QP |
| 94.8 | 27.89 | -15.61 | 43.5 | 41.06 | 15.26 | 1.55 | 29.98 | - | - | Peak |
| 759.2 | 30.03 | -15.97 | 46 | 27.1 | 27.73 | 4.6 | 29.4 | - | - | Peak |
| 863.5 | 31.89 | -14.11 | 46 | 27.04 | 28.9 | 4.94 | 28.99 | - | - | Peak |
| 953.8 | 33.51 | -12.49 | 46 | 26.47 | 30.49 | 5.19 | 28.64 | - | - | Peak |

Note:

1. The amplitude of spurious emissions which are attenuated by more than 20dB below the permissible value has no need to be reported.
2. Emission level (dBμV/m) = 20 log Emission level (μV/m).
3. Corrected Reading: Antenna Factor + Cable Loss + Read Level - Preamp Factor= Level.
4. The emission position marked as "-" means no suspected emission found with sufficient margin against limit line or noise floor only.

—————THE END—————