



FCC RADIO TEST REPORT

FCC ID : A4RGKWS6
Equipment : Phone
Model Name : GKWS6
Applicant : Google LLC
1600 Amphitheatre Parkway,
Mountain View, California, 94043 USA
Standard : FCC 47 CFR Part 2, 22(H), 24(E), 27(L)

The product was received on Mar. 24, 2023 and testing was performed from Mar. 30, 2023 to May 23, 2023. We, Sporton International Inc. EMC & Wireless Communications Laboratory, would like to declare that the tested sample has been evaluated in accordance with the test procedures given in ANSI / TIA-603-E and has been in compliance with the applicable technical standards.

The test results in this report apply exclusively to the tested model / sample. Without written approval from Sporton International Inc. EMC & Wireless Communications Laboratory, the test report shall not be reproduced except in full.

Louis Wu

Approved by: Louis Wu

Sporton International Inc. EMC & Wireless Communications Laboratory

No. 52, Huaya 1st Rd., Guishan Dist., Taoyuan City 333, Taiwan (R.O.C.)



Table of Contents

History of this test report.....3

Summary of Test Result.....4

1 General Description6

 1.1 Product Feature of Equipment Under Test6

 1.2 Product Specification of Equipment Under Test7

 1.3 Modification of EUT8

 1.4 Testing Location9

 1.5 Applicable Standards9

2 Test Configuration of Equipment Under Test10

 2.1 Test Mode.....10

 2.2 Connection Diagram of Test System11

 2.3 Support Unit used in test configuration12

 2.4 Measurement Results Explanation Example12

 2.5 Frequency List of Low/Middle/High Channels.....13

3 Conducted Test Result14

 3.1 Measuring Instruments.....14

 3.2 Conducted Output Power and ERP/EIRP15

 3.3 Peak-to-Average Ratio16

 3.4 99% Occupied Bandwidth and 26dB Bandwidth Measurement.....17

 3.5 Conducted Band Edge18

 3.6 Conducted Spurious Emission19

 3.7 Frequency Stability.....20

4 Radiated Test Items21

 4.1 Measuring Instruments.....21

 4.2 Test Setup21

 4.3 Test Result of Radiated Test.....22

 4.4 Field Strength of Spurious Radiation Measurement23

5 List of Measuring Equipment.....24

6 Measurement Uncertainty25

Appendix A. Test Results of Conducted Test

Appendix B. Test Results of Radiated Test

Appendix C. Test Setup Photographs



History of this test report

Report No.	Version	Description	Issue Date
FG2D0208-01A	01	Initial issue of report	Jun. 29, 2023



Summary of Test Result

Report Clause	Ref Std. Clause	Test Items	Result (PASS/FAIL)	Remark
3.2	§2.1046	Conducted Output Power	Pass	-
	§22.913 (a)(5)	Effective Radiated Power (GSM850) (WCDMA Band V)		
	§24.232 (c)	Equivalent Isotropic Radiated Power (GSM1900) (WCDMA Band II)		
	§27.50 (d)(4)	Equivalent Isotropic Radiated Power (WCDMA Band IV)		
3.3	§24.232 (d)	Peak-to-Average Ratio	Pass	-
3.4	§2.1049 §22.917 (b) §24.238 (b) §27.53 (g)	Occupied Bandwidth (GSM850) (WCDMA Band V) (GSM1900) (WCDMA Band II) (WCDMA Band IV)	Pass	-
3.5	§2.1051 §22.917 (a) §24.238 (a) §27.53 (g)	Band Edge Measurement (GSM850) (WCDMA Band V) (GSM1900) (WCDMA Band II) (WCDMA Band IV)	Pass	-
3.6	§2.1051 §22.917 (a) §24.238 (a) §27.53 (g)	Conducted Emission (GSM850) (WCDMA Band V) (GSM1900) (WCDMA Band II) (WCDMA Band IV)	Pass	-
3.7	§2.1055 §22.355 §24.235 §27.54	Frequency Stability Temperature & Voltage	Pass	-
4.4	§2.1053 §22.917 (a) §24.238 (a) §27.53 (h)	Field Strength of Spurious Radiation (GSM850) (WCDMA Band V) (GSM1900) (WCDMA Band II) (WCDMA Band IV)	Pass	21.23 dB under the limit at 2508.000 MHz for Primary Antenna 36.83 dB under the limit at 3760.000 MHz for ASDIV Antenna



Conformity Assessment Condition:
1. The test results (PASS/FAIL) with all measurement uncertainty excluded are presented against the regulation limits or in accordance with the requirements stipulated by the applicant/manufacturer who shall bear all the risks of non-compliance that may potentially occur if measurement uncertainty is taken into account.
2. The measurement uncertainty please refer to each test result in the section "Measurement Uncertainty".
Disclaimer:
The product specifications of the EUT presented in the test report that may affect the test assessments are declared by the manufacturer who shall take full responsibility for the authenticity.

Reviewed by: William Chen
Report Producer: Doris Chen



1 General Description

1.1 Product Feature of Equipment Under Test

Product Feature	
Equipment	Phone
FCC ID	A4RGKWS6
Model Name	GKWS6
EUT supports Radios application	GSM/EGPRS/WCDMA/HSPA/LTE/5G NR/NFC/GNSS/WPT WLAN 11b/g/n HT20 WLAN 11a/n HT20/HT40 WLAN 11ac VHT20/VHT40/VHT80/VHT160 WLAN 11ax HE20/HE40/HE80/HE160 WLAN 11be EHT20/EHT40/EHT80/EHT160 Bluetooth BR/EDR/LE/HR

Remark: The above EUT's information was declared by manufacturer.

EUT Information List	
S/N	Performed Test Item
33251FDJH0005T	Conducted Measurement ERP/EIRP
33131FDJH0007Z	Radiated Spurious Emission



1.2 Product Specification of Equipment Under Test

Product Specification is subject to this standard	
Tx Frequency	GSM/GPRS/EDGE: 850: 824.2 MHz ~ 848.8 MHz 1900: 1850.2 MHz ~ 1909.8 MHz WCDMA: Band V: 826.4 MHz ~ 846.6 MHz Band II: 1852.4 MHz ~ 1907.6 MHz Band IV: 1712.4 MHz ~ 1752.6 MHz
Rx Frequency	GSM/GPRS/EDGE: 850: 869.2 MHz ~ 893.8 MHz 1900: 1930.2 MHz ~ 1989.8 MHz WCDMA: Band V: 871.4 MHz ~ 891.6 MHz Band II: 1932.4 MHz ~ 1987.6 MHz Band IV: 2112.4 MHz ~ 2152.6 MHz
Maximum Output Power to Antenna	<Primary Antenna> GSM/GPRS/EDGE: <Ant. 0> 850: 32.31 dBm <Ant.2> 1900: 30.36 dBm WCDMA: <Ant. 0> Band V: 24.52 dBm <Ant. 2> Band II: 24.89 dBm Band IV: 24.93 dBm <ASDIV Antenna> GSM/GPRS/EDGE: <Ant. 1> 850: 31.84 dBm <Ant. 0> 1900: 29.60 dBm WCDMA: <Ant. 0> Band II: 24.35 dBm Band IV: 24.58 dBm <Ant. 1> Band V: 24.62 dBm



Product Specification is subject to this standard	
Antenna Type	<Primary Antenna> <Ant. 0>: PIFA Antenna <Ant. 2>: IFA Antenna <ASDIV Antenna> <Ant. 0>: PIFA Antenna <Ant. 1>: IFA Antenna
Type of Modulation	GSM / GPRS: GMSK EDGE(MCS 0-4): GMSK / (MCS 5-9): 8PSK WCDMA: QPSK (Uplink) HSDPA: 64QAM (Downlink) HSUPA: QPSK (Uplink)

<Primary Antenna>

Radio Tech	Band Number	Antenna name	Gain
GSM	850	Ant 0	-1.1
GSM	1900	Ant 2	0.5
WCDMA	B2	Ant 2	0.5
WCDMA	B4	Ant 2	0.5
WCDMA	B5	Ant 0	-1.1

<ASDIV Antenna>

Radio Tech	Band Number	Antenna name	Gain
GSM	850	Ant 1	-6.1
GSM	1900	Ant 0	0.1
WCDMA	B2	Ant 0	0.1
WCDMA	B4	Ant 0	1.6
WCDMA	B5	Ant 1	-6.1

Remark: The EUT's information above is declared by manufacturer. Please refer to Disclaimer in report summary.

1.3 Modification of EUT

No modifications made to the EUT during the testing.



1.4 Testing Location

Test Site	Sporton International Inc. EMC & Wireless Communications Laboratory
Test Site Location	No.52, Huaya 1st Rd., Guishan Dist., Taoyuan City 333, Taiwan (R.O.C.) TEL: +886-3-327-3456 FAX: +886-3-328-4978
Test Site No.	Sporton Site No.
	TH03-HY
Test Engineer	Eric Wu
Temperature (°C)	22.8~24.8
Relative Humidity (%)	36.4~38.4

Test Site	Sporton International Inc. Wensan Laboratory
Test Site Location	No.58, Aly. 75, Ln. 564, Wenhua 3rd, Rd., Guishan Dist., Taoyuan City 333010, Taiwan (R.O.C.) TEL: +886-3-327-0868 FAX: +886-3-327-0855
Test Site No.	Sporton Site No.
	03CH21-HY (TAF Code: 3786)
Test Engineer	Jack Cheng and Karl Hou
Temperature (°C)	18~26
Relative Humidity (%)	50~70
Remark	The Radiated Emission test item subcontracted to Sporton International Inc. Wensan Laboratory.

Note: The test site complies with ANSI C63.4 2014 requirement.

FCC Designation No.: TW1190 and TW3786

1.5 Applicable Standards

According to the specifications declared by the manufacturer, the EUT must comply with the requirements of the following standards:

- ♦ ANSI C63.26-2015
- ♦ ANSI / TIA-603-E
- ♦ FCC 47 CFR Part 2, 22(H), 24(E), 27(L)
- ♦ FCC KDB 971168 D01 Power Meas. License Digital Systems v03r01
- ♦ FCC KDB 412172 D01 Determining ERP and EIRP v01r01
- ♦ FCC KDB 414788 D01 Radiated Test Site v01r01

Remark:

1. All the test items were validated and recorded in accordance with the standards without any modification during the testing.
2. The TAF code is not including all the FCC KDB listed without accreditation.



2 Test Configuration of Equipment Under Test

2.1 Test Mode

Antenna port conducted and radiated test items listed below are performed according to KDB 971168 D01 Power Meas. License Digital Systems v03r01 with maximum output power.

For radiated measurement, the measured emission level of the EUT was maximized by rotating the EUT on a turntable, adjusting the orientation of the EUT and EUT antenna in three orthogonal axis (X: flat, Y: portrait, Z: landscape), and accessory (Adapter or Earphone) and adjusting the measurement antenna orientation, following C63.26 exploratory test procedures and only the worst case emissions were reported in this report.

Radiated emissions were investigated as following frequency range:

1. 30 MHz to 9000 MHz for GSM850 and WCDMA Band V
2. 30 MHz to 18000 MHz for WCDMA Band IV
3. 30 MHz to 19100 MHz for GSM1900 and WCDMA Band II

All modes, data rates and positions were investigated.

Test modes are chosen to be reported as the worst case configuration below:

Test Modes		
Band	Radiated TCs	Conducted TCs
GSM850	<ul style="list-style-type: none"> ■ GPRS Class 8 Link ■ EDGE Class 8 Link 	<ul style="list-style-type: none"> ■ GPRS Class 8 Link ■ EDGE Class 8 Link
GSM1900	<ul style="list-style-type: none"> ■ GPRS Class 8 Link ■ EDGE Class 8 Link 	<ul style="list-style-type: none"> ■ GPRS Class 8 Link ■ EDGE Class 8 Link
WCDMA Band V	<ul style="list-style-type: none"> ■ RMC 12.2Kbps Link 	<ul style="list-style-type: none"> ■ RMC 12.2Kbps Link
WCDMA Band II	<ul style="list-style-type: none"> ■ RMC 12.2Kbps Link 	<ul style="list-style-type: none"> ■ RMC 12.2Kbps Link
WCDMA Band IV	<ul style="list-style-type: none"> ■ RMC 12.2Kbps Link 	<ul style="list-style-type: none"> ■ RMC 12.2Kbps Link

Remark: All the radiated test cases were performed with Adapter 1 and USB Cable 1.

2.2 Connection Diagram of Test System

<EUT with Adapter>

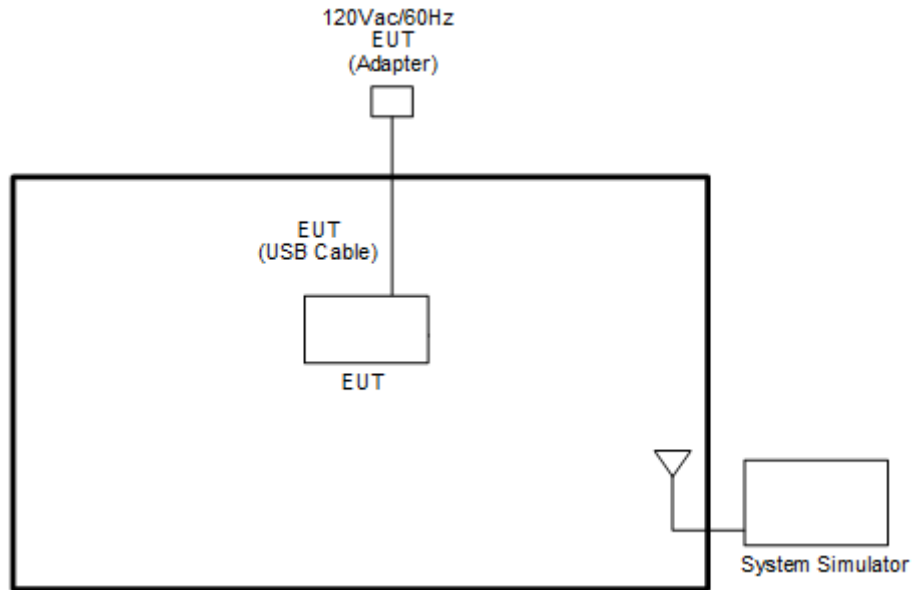

<EUT with Earphone>

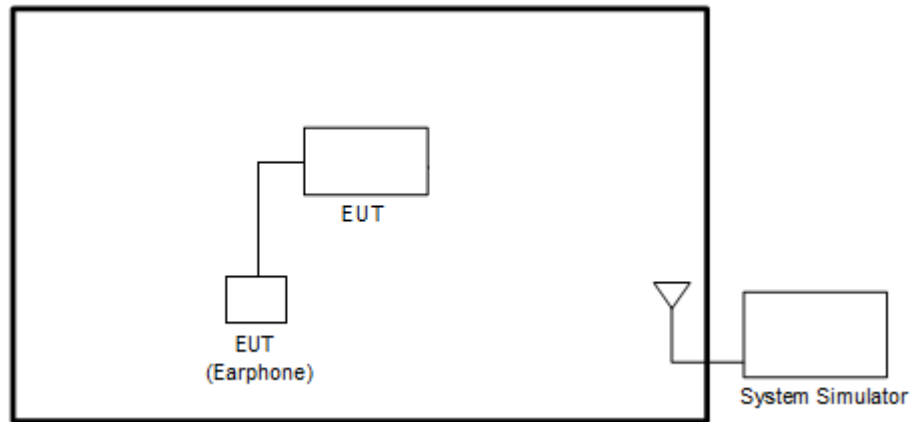

<EUT without Accessory>

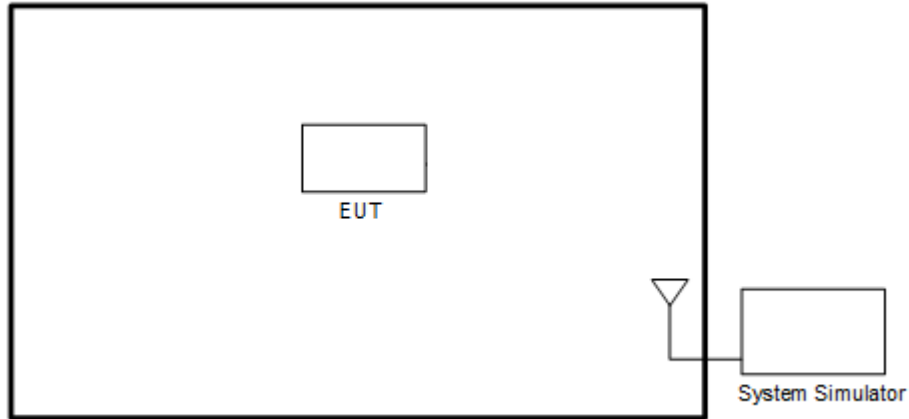

2.3 Support Unit used in test configuration

Item	Equipment	Brand Name	Model No.	FCC ID	Data Cable	Power Cord
1.	System Simulator	Anritsu	MT8821C	N/A	N/A	Unshielded, 1.8 m

2.4 Measurement Results Explanation Example

For all conducted test items:

The offset level is set in the spectrum analyzer to compensate the RF cable loss and attenuator factor between RF conducted output port and spectrum analyzer. With the offset compensation, the spectrum analyzer reading level will be exactly the RF output level.

The spectrum analyzer offset is derived from RF cable loss and attenuator factor.

Offset = RF cable loss + attenuator factor.

The following shows an offset computation example with RF cable loss 4.2 dB and a 10 dB attenuator.

Example:

$$\begin{aligned} \text{Offset(dB)} &= \text{RF cable loss(dB)} + \text{attenuator factor(dB)}. \\ &= 4.2 + 10 = 14.2 \text{ (dB)} \end{aligned}$$



2.5 Frequency List of Low/Middle/High Channels

Frequency List				
Band	Channel/Frequency(MHz)	Lowest	Middle	Highest
GSM850	Channel	128	189	251
	Frequency	824.2	836.4	848.8
WCDMA Band V	Channel	4132	4182	4233
	Frequency	826.4	836.4	846.6
GSM1900	Channel	512	661	810
	Frequency	1850.2	1880.0	1909.8
WCDMA Band II	Channel	9262	9400	9538
	Frequency	1852.4	1880.0	1907.6
WCDMA Band IV	Channel	1312	1413	1513
	Frequency	1712.4	1732.6	1752.6

3 Conducted Test Result

3.1 Measuring Instruments

Please refer to the measuring equipment list in this test report.

3.1.1 Test Setup

3.1.2 Conducted Output Power

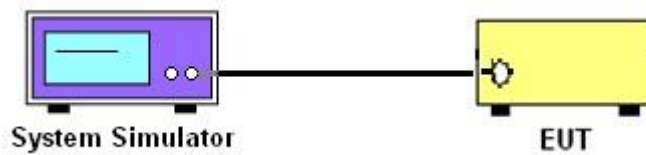

3.1.3 Peak-to-Average Ratio, Occupied Bandwidth, Conducted Band-Edge and Conducted Spurious Emission

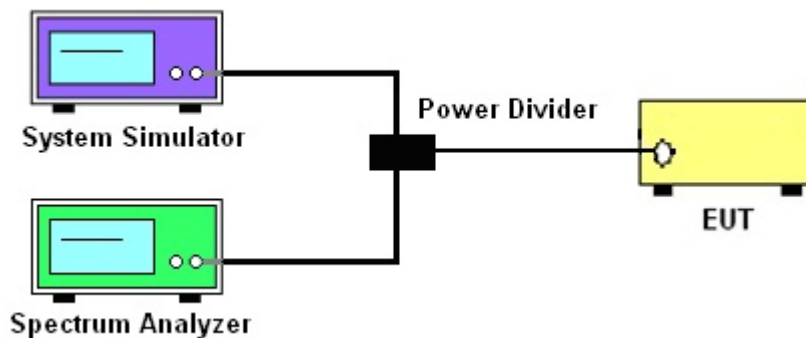

3.1.4 Frequency Stability

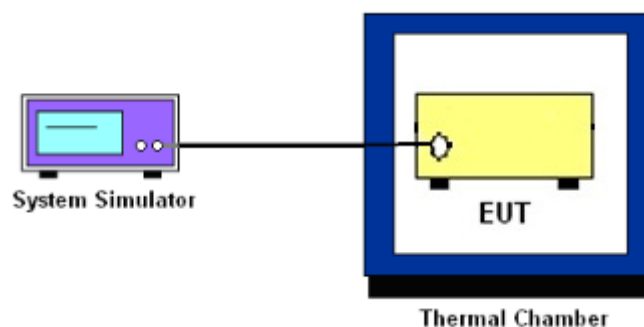

3.1.5 Test Result of Conducted Test

Please refer to Appendix A.



3.2 Conducted Output Power and ERP/EIRP

3.2.1 Description of the Conducted Output Power and ERP/EIRP

A system simulator was used to establish communication with the EUT. Its parameters were set to enforce EUT transmitting at the maximum power. The measured power in the radio frequency on the transmitter output terminals shall be reported.

The ERP of mobile transmitters must not exceed 7 Watts for GSM850 and WCDMA Band V

The EIRP of mobile transmitters must not exceed 2 Watts for GSM1900 and WCDMA Band II

The EIRP of mobile transmitters must not exceed 1 Watts for WCDMA Band IV

According to KDB 412172 D01 Power Approach,

$EIRP = P_T + G_T - L_C$, $ERP = EIRP - 2.15$, where

P_T = transmitter output power in dBm

G_T = gain of the transmitting antenna in dBi

L_C = signal attenuation in the connecting cable between the transmitter and antenna in dB

3.2.2 Test Procedures

1. The transmitter output port is connected to the system simulator.
2. Set EUT at maximum power through system simulator.
3. Select the lowest, middle, and the highest channels for each band and different modulation.
4. Measure the maximum burst average power for GSM and maximum average power for other modulation signal.



3.3 Peak-to-Average Ratio

3.3.1 Description of the PAR Measurement

The peak-to-average ratio (PAR) of the transmission may not exceed 13 dB.

3.3.2 Test Procedures

The testing follows ANSI C63.26-2015 Section 5.2.6

1. The EUT is connected to spectrum analyzer and system simulator via a power divider.
2. Set EUT to transmit at maximum output power.
3. When the duty cycle is less than 98%, then signal gating will be implemented on the spectrum analyzer by triggering from the system simulator.
4. Set the CCDF (Complementary Cumulative Distribution Function) option of the spectrum analyzer.
5. Record the maximum PAPR level associated with a probability of 0.1%.



3.4 99% Occupied Bandwidth and 26dB Bandwidth Measurement

3.4.1 Description of 99% Occupied Bandwidth and 26dB Bandwidth Measurement

The occupied bandwidth is the width of a frequency band such that, below the lower and above the upper frequency limits, the mean powers emitted are each equal to a specified percentage 0.5% of the total mean transmitted power.

The 26 dB emission bandwidth is defined as the frequency range between two points, one above and one below the carrier frequency, at which the spectral density of the emission is attenuated 26 dB below the maximum in-band spectral density of the modulated signal. Spectral density (power per unit bandwidth) is to be measured with a detector of resolution bandwidth equal to approximately 1.0% of the emission bandwidth.

3.4.2 Test Procedures

The testing follows ANSI C63.26-2015 Section 5.4.3 (26dB) and Section 5.4.4 (99OB)

1. The EUT is connected to spectrum analyzer and system simulator via a power divider.
2. The spectrum analyzer center frequency is set to the nominal EUT channel center frequency. The span range for the spectrum analyzer shall be between two and five times the anticipated OBW.
3. The nominal resolution bandwidth (RBW) shall be in the range of 1 to 5 % of the anticipated OBW, and the VBW shall be at least 3 times the RBW.
4. Set the detection mode to peak, and the trace mode to max hold.
5. Determine the reference value: Set the EUT to transmit a modulated signal. Allow the trace to stabilize. Set the spectrum analyzer marker to the highest level of the displayed trace.
(This is the reference value)
6. Determine the “-26 dB down amplitude” as equal to (Reference Value – X).
7. Place two markers, one at the lowest and the other at the highest frequency of the envelope of the spectral display such that each marker is at or slightly below the “-X dB down amplitude” determined in step 6. If a marker is below this “-X dB down amplitude” value it shall be placed as close as possible to this value. The OBW is the positive frequency difference between the two markers.
8. Use the 99 % power bandwidth function of the spectrum analyzer and report the measured bandwidth.



3.5 Conducted Band Edge

3.5.1 Description of Conducted Band Edge Measurement

The power of any emission outside of the authorized operating frequency ranges must be lower than the transmitter power (P) by a factor of at least $43 + 10 \log (P)$ dB.

3.5.2 Test Procedures

The testing follows FCC KDB 971168 D01 v03r01 Section 6.1.

1. The EUT is connected to the spectrum analyzer and system simulator via a power divider.
2. The RF output of EUT is connected to the spectrum analyzer by an RF cable and attenuator. The path loss is compensated to the results for each measurement.
3. The band edges of low and high channels for the highest RF powers are measured.
4. The RF fundamental frequency shall be excluded against the limit line in the operating frequency band.
5. The limit line is derived from $43 + 10\log(P)$ dB below the transmitter power P(Watts)



3.6 Conducted Spurious Emission

3.6.1 Description of Conducted Spurious Emission Measurement

The power of any emission outside of the authorized operating frequency ranges must be lower than the transmitter power (P) by a factor of at least $43 + 10 \log (P)$ dB.

It is measured by means of a calibrated spectrum analyzer and scanned from 30 MHz up to a frequency including its 10th harmonic.

3.6.2 Test Procedures

The testing follows FCC KDB 971168 D01 v03r01 Section 6.1.

1. The EUT is connected to the spectrum analyzer and system simulator via a power divider.
2. The RF output of EUT is connected to the spectrum analyzer by an RF cable and attenuator. The path loss is compensated to the results for each measurement.
3. The middle channel for the highest RF power within the transmitting frequency is measured.
4. The conducted spurious emission for the whole frequency range is taken.
5. The RF fundamental frequency shall be excluded against the limit line in the operating frequency band.
6. The limit line is derived from $43 + 10\log(P)$ dB below the transmitter power P(Watts)



3.7 Frequency Stability

3.7.1 Description of Frequency Stability Measurement

22.355

The frequency stability shall be sufficient to ensure that the occupied bandwidth stays within each of the sub-bands when tested at the temperature and supply voltage variations specified in RSS-Gen..

24.235 & 27.54

The frequency stability shall be sufficient to ensure that the fundamental emission stays within the authorized frequency block.

3.7.2 Test Procedures for Temperature Variation

The testing follows FCC KDB 971168 D01 v03r01 Section 9.0.

1. The EUT is set up in the thermal chamber and connected with the system simulator.
2. With power OFF, the temperature is decreased to -30°C and the EUT is stabilized before testing. Power is applied and the maximum change in frequency is recorded within one minute.
3. With power OFF, the temperature is raised in 10°C steps up to 50°C. The EUT is stabilized at each step for at least half an hour. Power is applied and the maximum frequency change is recorded within one minute.

3.7.3 Test Procedures for Voltage Variation

The testing follows FCC KDB 971168 D01 v03r01 Section 9.0.

1. The EUT is placed in a temperature chamber at 20±5° C and connected with the system simulator.
2. The power supply voltage to the EUT is varied from 85% to 115% of the nominal value measured at the input to the EUT.
3. The variation in frequency is measured for the worst case.

4 Radiated Test Items

4.1 Measuring Instruments

Please refer to the measuring equipment list in this test report.

4.2 Test Setup

For radiated test below 30MHz



For radiated test from 30MHz to 1GHz

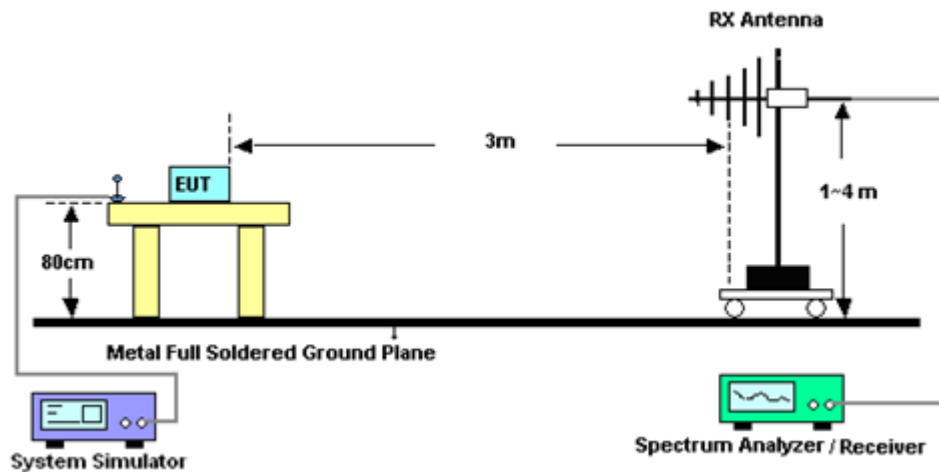

For radiated test from 1GHz to 18GHz

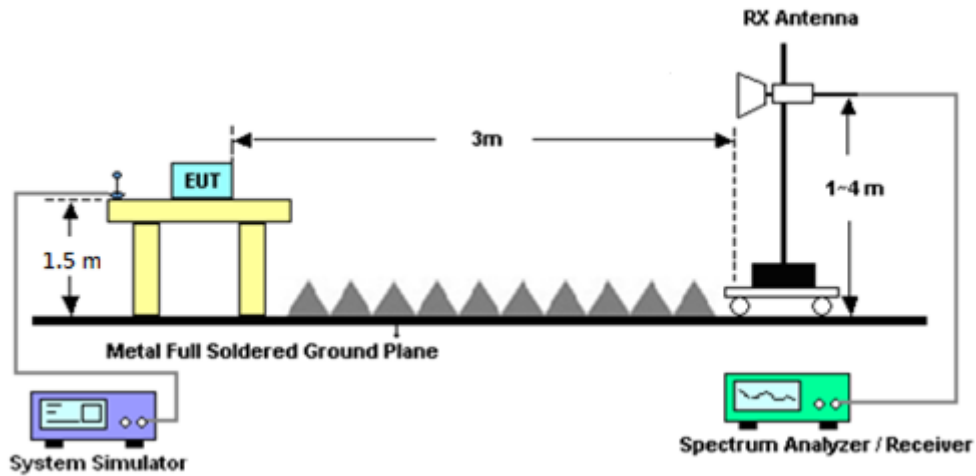

For radiated test above 18GHz

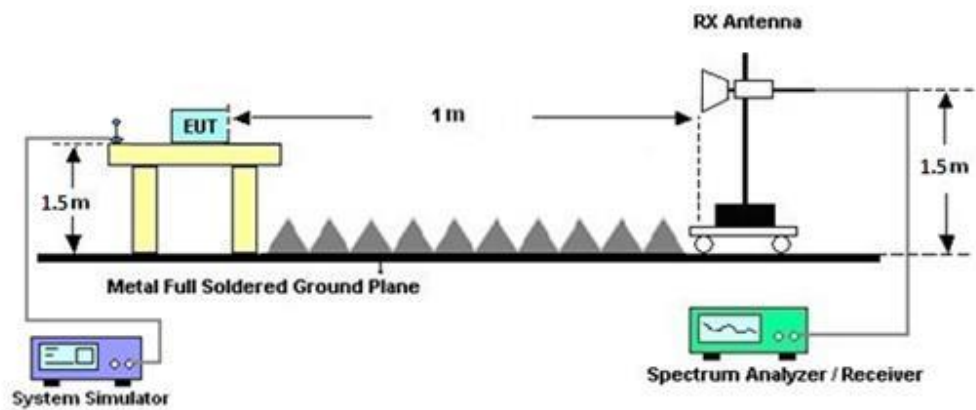

4.3 Test Result of Radiated Test

Please refer to Appendix B.

Note:

The low frequency, which starts from 9 kHz to 30 MHz, is pre-scanned and the result which is 20 dB lower than the limit line is not reported.

There is adequate comparison measurement of both open-field test site and alternative test site - semi-Anechoic chamber according to 414788 D01 Radiated Test Site v01r01, and the result came out very similar.



4.4 Field Strength of Spurious Radiation Measurement

4.4.1 Description of Field Strength of Spurious Radiated Measurement

The power of any emission outside of the authorized operating frequency ranges must be attenuated below the transmitter power (P) by a factor of at least $43 + 10 \log (P)$ dB. The spectrum is scanned from 30 MHz up to a frequency including its 10th harmonic.

4.4.2 Test Procedures

The testing follows FCC KDB 971168 D01 v03r01 Section 7 and ANSI / TIA-603-E Section 2.2.12.

1. The EUT is placed on a rotatable wooden table 0.8 meters for frequency below 1 GHz and 1.5 meter for frequency above 1 GHz above the ground.
2. The EUT is set 3 meters away from the receiving antenna, which is mounted on the antenna tower.
3. The table is rotated 360 degrees to determine the position of the highest spurious emission.
4. The height of the receiving antenna is varied between one meter and four meters to search for the maximum spurious emission for both horizontal and vertical polarizations.
5. Make the measurement with the spectrum analyzer's RBW = 1 MHz, VBW = 3 MHz, taking record of maximum spurious emission.
6. A horn antenna is substituted in place of the EUT and is driven by a signal generator.
7. Tune the output power of signal generator to the same emission level with EUT maximum spurious emission.
8. Take the record of output power at antenna port.
9. Repeat step 7 to step 8 for another polarization.
10. $EIRP (dBm) = S.G. Power - Tx Cable Loss + Tx Antenna Gain$
11. $ERP (dBm) = EIRP - 2.15$
12. The RF fundamental frequency shall be excluded against the limit line in the operating frequency band.
13. The limit line is derived from $43 + 10\log(P)$ dB below the transmitter power P(Watts)



5 List of Measuring Equipment

Instrument	Brand Name	Model No.	Serial No.	Characteristics	Calibration Date	Test Date	Due Date	Remark
LOOP Antenna	Rohde & Schwarz	HFH2-Z2	100488	9 kHz~30 MHz	Sep. 20, 2022	Mar. 30, 2023~ May 18, 2023	Sep. 19, 2023	Radiation (03CH21-HY)
Bilog Antenna	TESEQ & WOKEN	CBL 6111D & 00802N1D-06	63303 & 001	30MHz~1GHz	Oct. 04, 2022	May 05, 2023~ May 18, 2023	Oct. 03, 2023	Radiation (03CH21-HY)
Bilog Antenna	TESEQ	CBL 6111D & N-6-06	35414 & AT-N0602	30MHz~1GHz	Oct. 08, 2021	May 05, 2023~ May 18, 2023	Oct. 07, 2022	Radiation (03CH21-HY)
Horn Antenna	RFSPIN	DRH18-E	LE2C03A18EN	1GHz~18GHz	Jul. 06, 2022	May 05, 2023~ May 18, 2023	Jul. 05, 2023	Radiation (03CH21-HY)
Horn Antenna	SCHWARZBECK	BBHA 9120 D	9120D-1326	1GHz~18GHz	Aug. 24, 2022	May 05, 2023~ May 18, 2023	Aug. 23, 2023	Radiation (03CH21-HY)
SHF-EHF Horn Antenna	SCHWARZBECK	BBHA 9170	1223	18GHz~40GHz	Jul. 05, 2022	Mar. 30, 2023~ May 18, 2023	Jul. 04, 2022	Radiation (03CH21-HY)
SHF-EHF Horn Antenna	SCHWARZBECK	BBHA 9170	00993	18GHz~40GHz	Nov. 24, 2022	Mar. 30, 2023~ May 18, 2023	Nov. 23, 2023	Radiation (03CH21-HY)
Preamplifier	E-INSTRUMENT TECH LTD.	ERA-100M-18G-56-01-A70	EC1900249	1GHz~18GHz	Dec. 21, 2022	Mar. 30, 2023~ May 18, 2023	Dec. 20, 2023	Radiation (03CH21-HY)
Preamplifier	EMEC	EM18G40G	060871	18GHz~40GHz	Sep. 29, 2022	Mar. 30, 2023~ May 18, 2023	Sep. 28, 2023	Radiation (03CH21-HY)
Spectrum Analyzer	Keysight	N9010B	MY62170358	10Hz~44GHz	Sep. 11, 2022	Mar. 30, 2023~ May 18, 2023	Sep. 10, 2023	Radiation (03CH21-HY)
RF Cable	HUBER + SUHNER	SUCOFLEX 102	803951/2	9K~30M	Mar. 07, 2023	Mar. 30, 2023~ May 18, 2023	Mar. 06, 2024	Radiation (03CH21-HY)
RF Cable	HUBER + SUHNER	SUCOFLEX 102	804397/2,804612/2,804614/2	30MHz~40GHz	Oct. 25, 2022	Mar. 30, 2023~ May 18, 2023	Oct. 24, 2023	Radiation (03CH21-HY)
Filter	Wainwright	WHKX12-1080-1200-15000-60ST	SN14	1.2GHz High Pass Filter	May 24, 2022	Mar. 30, 2023~ May 18, 2023	May 23, 2023	Radiation (03CH21-HY)
Filter	Wainwright	WHKX12-2805-3000-18000-40ST	SN19	3GHz High Pass Filter	Aug. 05, 2022	Mar. 30, 2023~ May 18, 2023	Aug. 04, 2023	Radiation (03CH21-HY)
Filter	Wainwright	WHKX8-6090-7000-18000-40SS	SN98	7GHz High Pass Filter	Nov. 03, 2022	Mar. 30, 2023~ May 18, 2023	Nov. 02, 2023	Radiation (03CH21-HY)
Hygrometer	TECPEL	DTM-303A	TP211568	N/A	Nov. 17, 2022	Mar. 30, 2023~ May 18, 2023	Nov. 16, 2023	Radiation (03CH21-HY)
Controller	EMEC	EM 1000	N/A	Control Turn table & Ant Mast	N/A	Mar. 30, 2023~ May 18, 2023	N/A	Radiation (03CH21-HY)
Antenna Mast	EMEC	AM-BS-4500-B	N/A	1~4m	N/A	Mar. 30, 2023~ May 18, 2023	N/A	Radiation (03CH21-HY)
Turn Table	EMEC	TT 2000	N/A	0~360 Degree	N/A	Mar. 30, 2023~ May 18, 2023	N/A	Radiation (03CH21-HY)
Software	Audix	E3 6.2009-8-24	RK-001053	N/A	N/A	Mar. 30, 2023~ May 18, 2023	N/A	Radiation (03CH21-HY)
Spectrum Analyzer	Rohde & Schwarz	FSP30	101329	9kHz~30GHz	Sep. 27, 2022	May 09, 2023~ May 23, 2023	Sep. 26, 2023	Conducted (TH03-HY)
Programmable Power Supply	GW Instek	PSS-2005	EL890001	1V~20V 0.5A~4A	Sep. 29, 2022	May 09, 2023~ May 23, 2023	Sep. 28, 2023	Conducted (TH03-HY)
Base Station (Measure)	Rohde & Schwarz	CMU200	117995	GSM / GPRS / WCDMA / CDMA	Aug. 02, 2022	May 09, 2023~ May 23, 2023	Aug. 01, 2023	Conducted (TH03-HY)
Thermal Chamber	ESPEC	SH-641	92013720	-40°C~90°C	Sep. 07, 2022	May 09, 2023~ May 23, 2023	Sep. 06, 2023	Conducted (TH03-HY)
Hygrometer	TECPEL	DTM-303A	TP201996	N/A	Nov. 17, 2022	May 09, 2023~ May 23, 2023	Nov. 16, 2023	Conducted (TH03-HY)



6 Measurement Uncertainty

Uncertainty of Radiated Emission Measurement (30 MHz ~ 1000 MHz)

Measuring Uncertainty for a Level of Confidence of 95% ($U = 2Uc(y)$)	3.06 dB
---	---------

Uncertainty of Radiated Emission Measurement (1 GHz ~ 18 GHz)

Measuring Uncertainty for a Level of Confidence of 95% ($U = 2Uc(y)$)	3.31 dB
---	---------

Uncertainty of Radiated Emission Measurement (18 GHz ~ 40 GHz)

Measuring Uncertainty for a Level of Confidence of 95% ($U = 2Uc(y)$)	3.30 dB
---	---------



Appendix A. Test Results of Conducted Test

<Primary Antenna>

Conducted Output Power(Average power) & ERP / EIRP

GSM850 Maximum Average Power [dBm] (GT - LC = -1.1 dB)					
Channel	128	189	251	ERP (dBm)	ERP (W)
Frequency	824.2	836.4	848.8		
GSM	32.04	32.18	32.28	29.06	0.8054
GPRS class 8	32.05	32.19	32.31		
GPRS class 10	31.23	31.10	31.19		
GPRS class 11	30.09	29.83	29.93		
GPRS class 12	28.94	29.04	29.03		
EGPRS class 8	26.89	26.75	27.00	23.75	0.2371
EGPRS class 10	25.99	26.14	26.18		
EGPRS class 11	25.95	26.06	25.99		
EGPRS class 12	24.27	24.22	24.21		
Limit	ERP < 7W			Result	Pass

GSM1900 Maximum Average Power [dBm] (GT - LC = 0.5 dB)					
Channel	512	661	810	EIRP (dBm)	EIRP (W)
Frequency	1850.2	1880	1909.8		
GSM	30.28	30.09	29.90	30.86	1.2190
GPRS class 8	30.36	30.30	30.22		
GPRS class 10	29.02	28.87	28.81		
GPRS class 11	28.06	28.15	28.07		
GPRS class 12	27.02	27.03	26.96		
EGPRS class 8	25.08	25.29	25.79	26.29	0.4256
EGPRS class 10	24.16	23.95	24.18		
EGPRS class 11	23.88	23.62	23.72		
EGPRS class 12	22.99	22.53	22.41		
Limit	EIRP < 2W			Result	Pass



WCDMA Band V Maximum Average Power [dBm] (GT - LC = -1.1 dB)							
Channel	4132	4182	4233	ERP (dBm)	ERP (W)		
Frequency	826.4	836.4	846.6				
RMC 12.2K	24.51	24.52	24.50	21.27	0.1340		
HSDPA Subtest-1	24.50	24.51	24.49				
HSDPA Subtest-2	24.32	24.38	24.41				
HSDPA Subtest-3	23.87	23.88	23.87				
HSDPA Subtest-4	23.40	23.43	23.49				
HSUPA Subtest-1	24.12	23.99	23.91				
HSUPA Subtest-2	22.36	22.32	22.32				
HSUPA Subtest-3	23.49	23.33	23.31				
HSUPA Subtest-4	22.30	22.38	22.27				
HSUPA Subtest-5	24.50	24.50	24.50				
Limit	ERP < 7W					Result	Pass

WCDMA Band II Maximum Average Power [dBm] (GT - LC = 0.5 dB)							
Channel	9262	9400	9538	EIRP (dBm)	EIRP (W)		
Frequency	1852.4	1880	1907.6				
RMC 12.2K	24.89	24.61	24.76	25.39	0.3459		
HSDPA Subtest-1	24.88	24.73	24.81				
HSDPA Subtest-2	24.82	24.68	24.69				
HSDPA Subtest-3	24.23	24.12	24.22				
HSDPA Subtest-4	23.74	23.69	23.68				
HSUPA Subtest-1	23.87	23.75	23.80				
HSUPA Subtest-2	21.80	21.72	21.74				
HSUPA Subtest-3	22.87	22.77	22.81				
HSUPA Subtest-4	22.30	22.19	22.28				
HSUPA Subtest-5	24.87	24.86	24.83				
Limit	EIRP < 2W					Result	Pass

WCDMA Band IV Maximum Average Power [dBm] (GT - LC = 0.5 dB)							
Channel	1312	1413	1513	EIRP (dBm)	EIRP (W)		
Frequency	1712.4	1732.6	1752.6				
RMC 12.2K	24.78	24.93	24.81	25.43	0.3491		
HSDPA Subtest-1	24.73	24.88	24.67				
HSDPA Subtest-2	24.60	24.83	24.58				
HSDPA Subtest-3	24.04	24.30	24.09				
HSDPA Subtest-4	24.07	24.27	24.06				
HSUPA Subtest-1	23.73	23.87	23.71				
HSUPA Subtest-2	22.09	22.25	22.12				
HSUPA Subtest-3	22.65	22.77	22.67				
HSUPA Subtest-4	21.89	22.04	21.50				
HSUPA Subtest-5	24.87	24.82	24.86				
Limit	EIRP < 1W					Result	Pass



<ASDIV Antenna>

GSM850 Maximum Average Power [dBm] (GT - LC = -6.1 dB)					
Channel	128	189	251	ERP (dBm)	ERP (W)
Frequency	824.2	836.4	848.8		
GSM	31.58	31.79	31.80	23.59	0.2286
GPRS class 8	31.59	31.81	31.84		
GPRS class 10	31.24	30.88	30.59		
GPRS class 11	30.13	29.60	29.35		
GPRS class 12	28.45	28.46	28.12		
EGPRS class 8	26.42	26.22	26.15	18.17	0.0656
EGPRS class 10	25.55	25.48	25.54		
EGPRS class 11	25.75	25.50	25.44		
EGPRS class 12	23.88	23.60	23.35		
Limit	ERP < 7W			Result	Pass

GSM1900 Maximum Average Power [dBm] (GT - LC = 0.1 dB)					
Channel	512	661	810	EIRP (dBm)	EIRP (W)
Frequency	1850.2	1880	1909.8		
GSM	29.60	29.41	29.30	29.70	0.9333
GPRS class 8	29.22	29.28	29.19		
GPRS class 10	27.87	27.69	27.52		
GPRS class 11	27.23	27.01	26.80		
GPRS class 12	26.02	26.03	25.85		
EGPRS class 8	23.70	23.84	23.74	23.94	0.2477
EGPRS class 10	22.65	22.65	22.45		
EGPRS class 11	22.52	22.24	22.11		
EGPRS class 12	21.26	21.02	20.91		
Limit	EIRP < 2W			Result	Pass



WCDMA Band V Maximum Average Power [dBm] (GT - LC = -6.1 dB)							
Channel	4132	4182	4233	ERP (dBm)	ERP (W)		
Frequency	826.4	836.4	846.6				
RMC 12.2K	24.39	24.62	24.50	16.37	0.0434		
HSDPA Subtest-1	24.39	24.60	24.47				
HSDPA Subtest-2	24.23	24.40	24.28				
HSDPA Subtest-3	23.74	23.91	23.79				
HSDPA Subtest-4	23.20	23.40	23.27				
HSUPA Subtest-1	23.83	24.05	24.03				
HSUPA Subtest-2	22.23	22.41	22.38				
HSUPA Subtest-3	23.30	23.42	23.36				
HSUPA Subtest-4	22.25	22.39	22.30				
HSUPA Subtest-5	24.00	24.10	24.00				
Limit	ERP < 7W					Result	Pass

WCDMA Band II Maximum Average Power [dBm] (GT - LC = 0.1 dB)							
Channel	9262	9400	9538	EIRP (dBm)	EIRP (W)		
Frequency	1852.4	1880	1907.6				
RMC 12.2K	24.34	24.35	24.34	24.45	0.2786		
HSDPA Subtest-1	24.32	24.33	24.32				
HSDPA Subtest-2	24.30	24.25	24.33				
HSDPA Subtest-3	24.00	23.71	23.89				
HSDPA Subtest-4	23.64	23.26	23.46				
HSUPA Subtest-1	23.44	23.57	23.65				
HSUPA Subtest-2	22.97	20.91	21.07				
HSUPA Subtest-3	23.49	21.92	22.03				
HSUPA Subtest-4	22.97	23.02	22.85				
HSUPA Subtest-5	24.30	24.30	24.30				
Limit	EIRP < 2W					Result	Pass

WCDMA Band IV Maximum Average Power [dBm] (GT - LC = 1.6 dB)							
Channel	1312	1413	1513	EIRP (dBm)	EIRP (W)		
Frequency	1712.4	1732.6	1752.6				
RMC 12.2K	24.41	24.58	24.39	26.18	0.4150		
HSDPA Subtest-1	24.37	24.51	24.39				
HSDPA Subtest-2	24.26	24.48	24.29				
HSDPA Subtest-3	23.81	24.00	23.83				
HSDPA Subtest-4	23.77	24.04	23.84				
HSUPA Subtest-1	23.44	23.72	23.60				
HSUPA Subtest-2	20.81	21.05	22.80				
HSUPA Subtest-3	22.37	22.61	22.44				
HSUPA Subtest-4	20.83	22.83	23.10				
HSUPA Subtest-5	24.50	24.50	24.50				
Limit	EIRP < 1W					Result	Pass



A2. GSM

Peak-to-Average Ratio

Mode	GSM850	Limit: 13dB
Mod.	GPRS class 8	Result
Lowest CH	0.80	PASS
Middle CH	0.76	
Highest CH	0.76	

Mode	GSM1900	Limit: 13dB
Mod.	GPRS class 8	Result
Lowest CH	0.44	PASS
Middle CH	0.44	
Highest CH	0.44	



GSM850 (GPRS class 8)

Lowest Channel

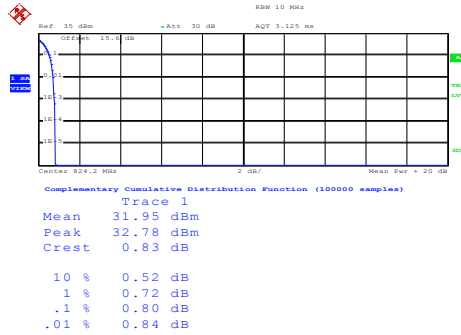

Date: 9.MAY.2023 11:22:05

Middle Channel

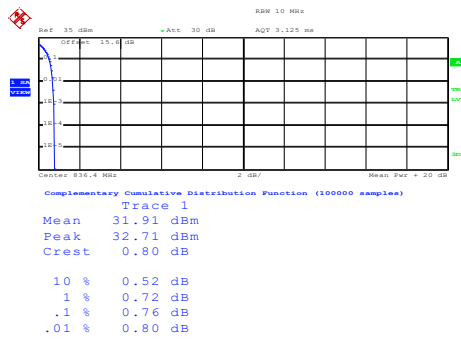

Date: 9.MAY.2023 11:22:26

Highest Channel

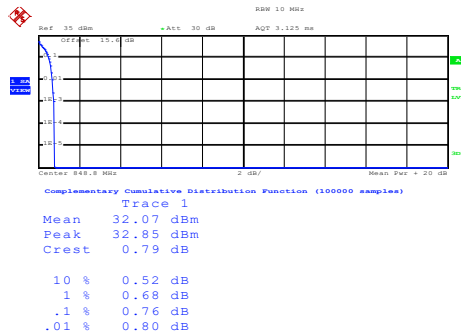

Date: 9.MAY.2023 11:22:47



GSM1900 (GPRS class 8)

Lowest Channel

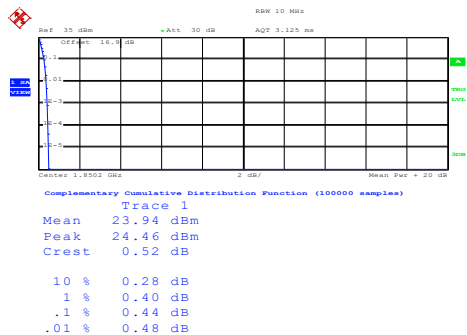

Date: 9.MAY.2023 11:51:07

Middle Channel

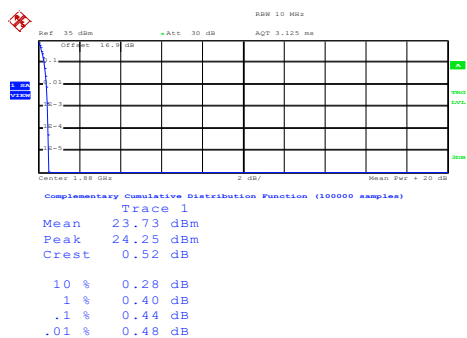

Date: 9.MAY.2023 11:51:29

Highest Channel

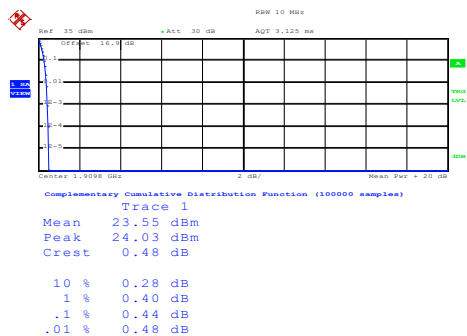

Date: 9.MAY.2023 11:51:50



26dB Bandwidth

Mode	GSM850: 26dB BW(MHz)
Mod.	GPRS class 8
Lowest CH	0.308
Middle CH	0.302
Highest CH	0.316

Mode	GSM1900: 26dB BW(MHz)
Mod.	GPRS class 8
Lowest CH	0.318
Middle CH	0.302
Highest CH	0.308



GSM850 (GPRS class 8)

Lowest Channel

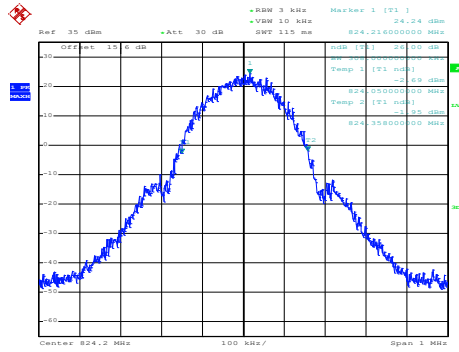

Date: 9.MAY.2023 11:06:08

Middle Channel

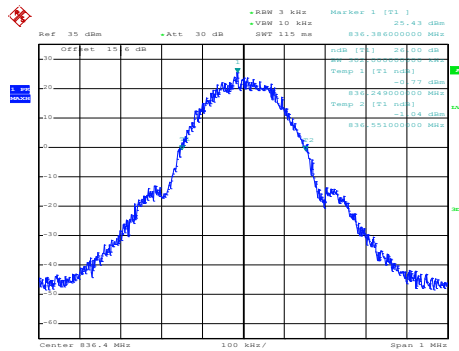

Date: 9.MAY.2023 11:07:04

Highest Channel

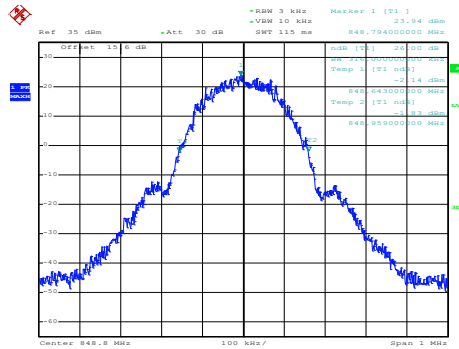

Date: 9.MAY.2023 11:08:04



GSM1900 (GPRS class 8)

Lowest Channel

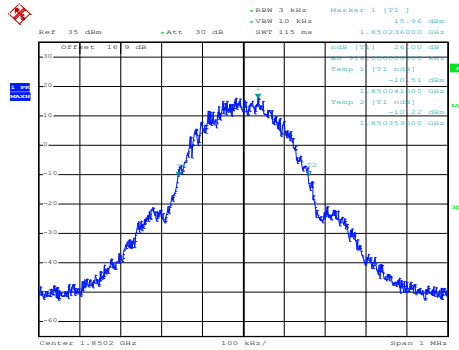

Date: 9.MAY.2023 11:40:26

Middle Channel

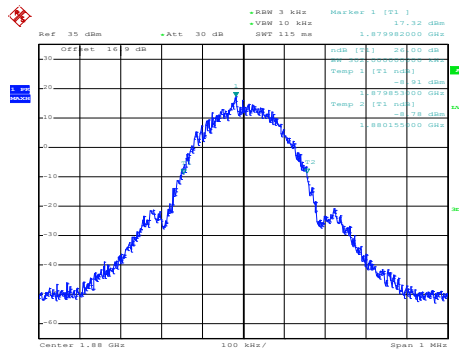

Date: 9.MAY.2023 11:41:02

Highest Channel

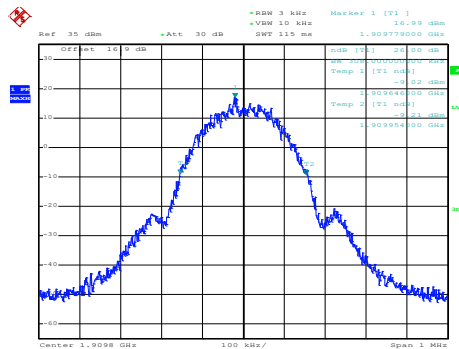

Date: 9.MAY.2023 11:41:39



Occupied Bandwidth

Mode	GSM850: 99%OBW(MHz)
Mod.	GPRS class 8
Lowest CH	0.252
Middle CH	0.243
Highest CH	0.242

Mode	GSM1900: 99%OBW(MHz)
Mod.	GPRS class 8
Lowest CH	0.245
Middle CH	0.246
Highest CH	0.242



GSM850 (GPRS class 8)

Lowest Channel

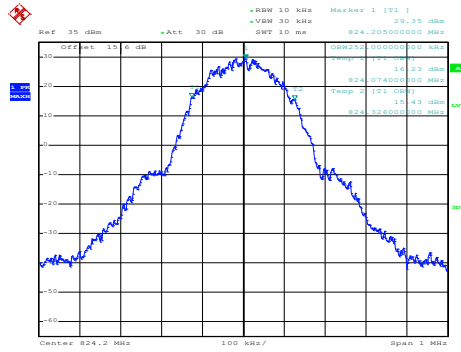

Date: 9.MAY.2023 11:09:23

Middle Channel

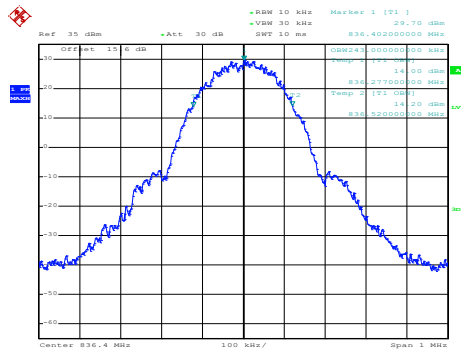

Date: 9.MAY.2023 11:09:59

Highest Channel

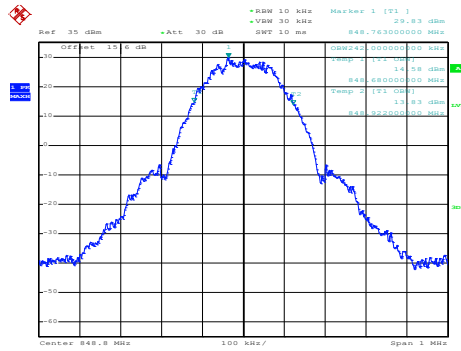

Date: 9.MAY.2023 11:10:35



GSM1900 (GPRS class 8)

Lowest Channel

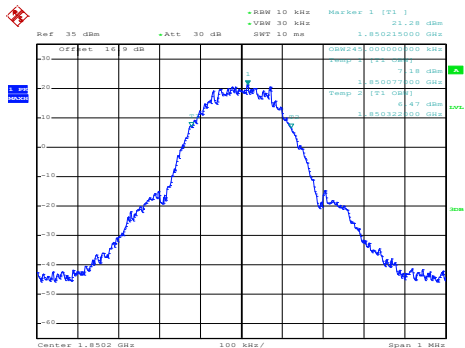

Date: 9.MAY.2023 11:43:01

Middle Channel

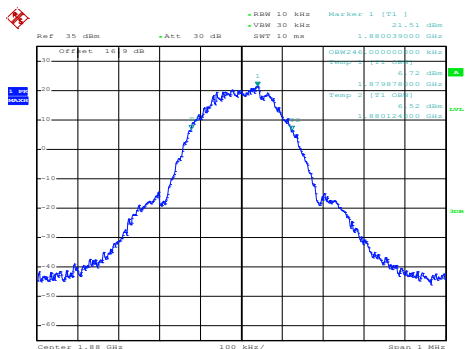

Date: 9.MAY.2023 11:43:39

Highest Channel

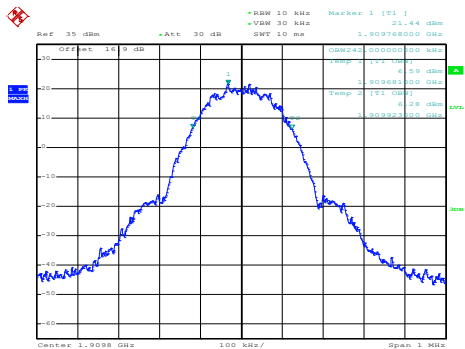

Date: 9.MAY.2023 11:44:17



Conducted Band Edge

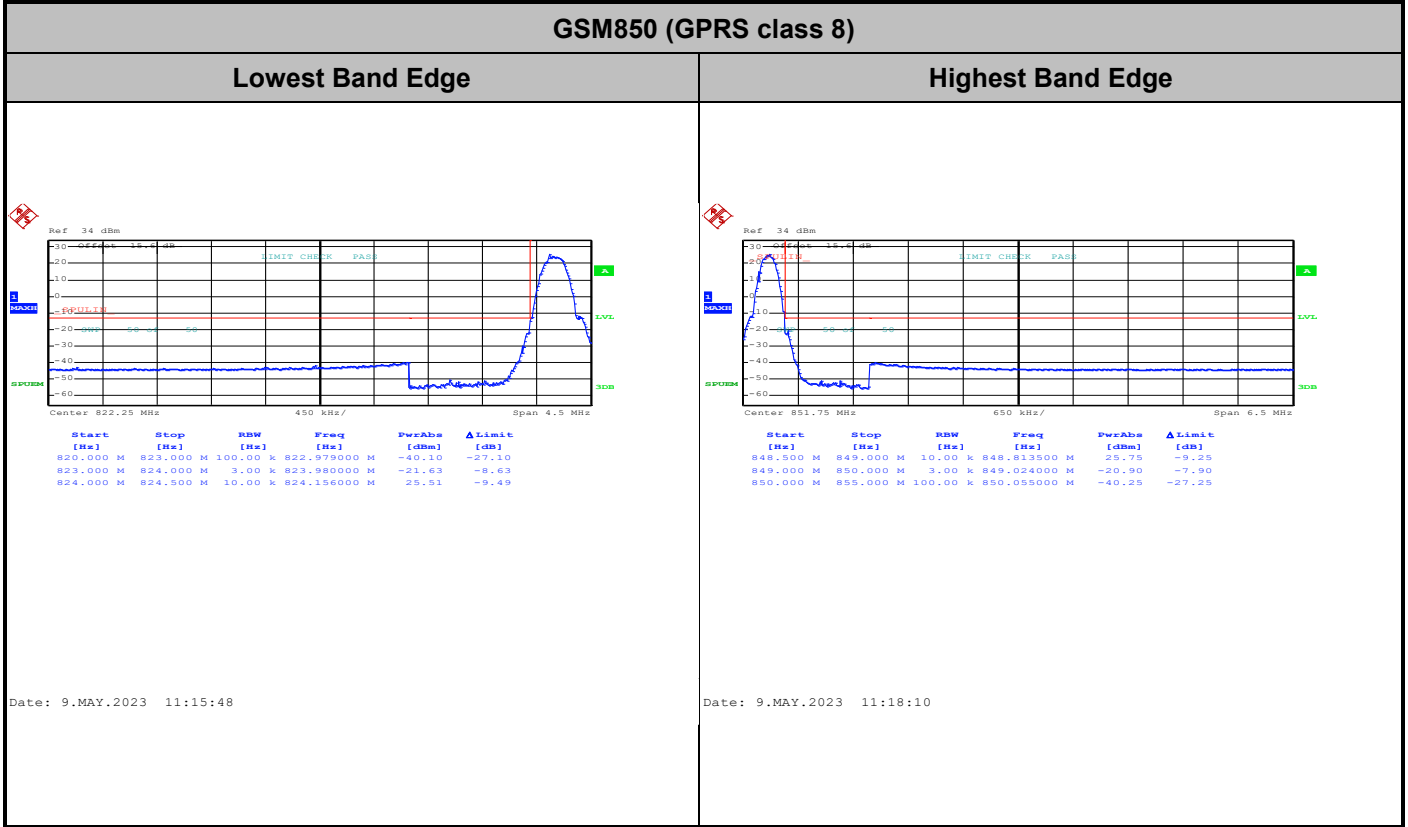



GSM1900 (GPRS class 8)

Lowest Band Edge

Highest Band Edge

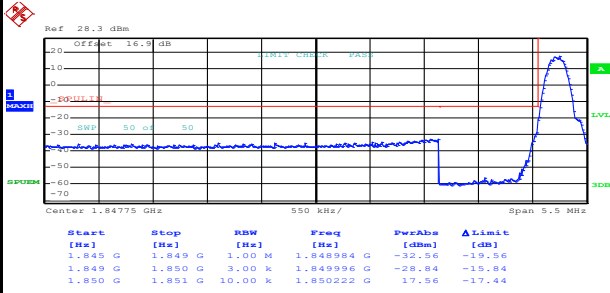

Date: 9.MAY.2023 11:46:03

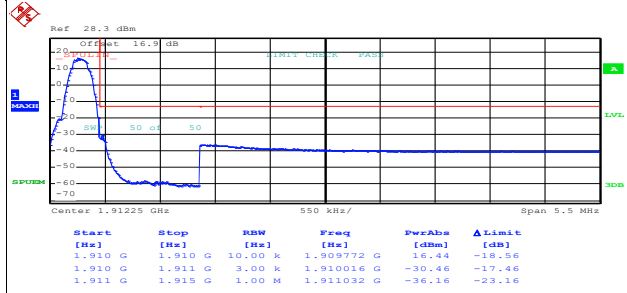

Date: 9.MAY.2023 11:47:38

Conducted Spurious Emission

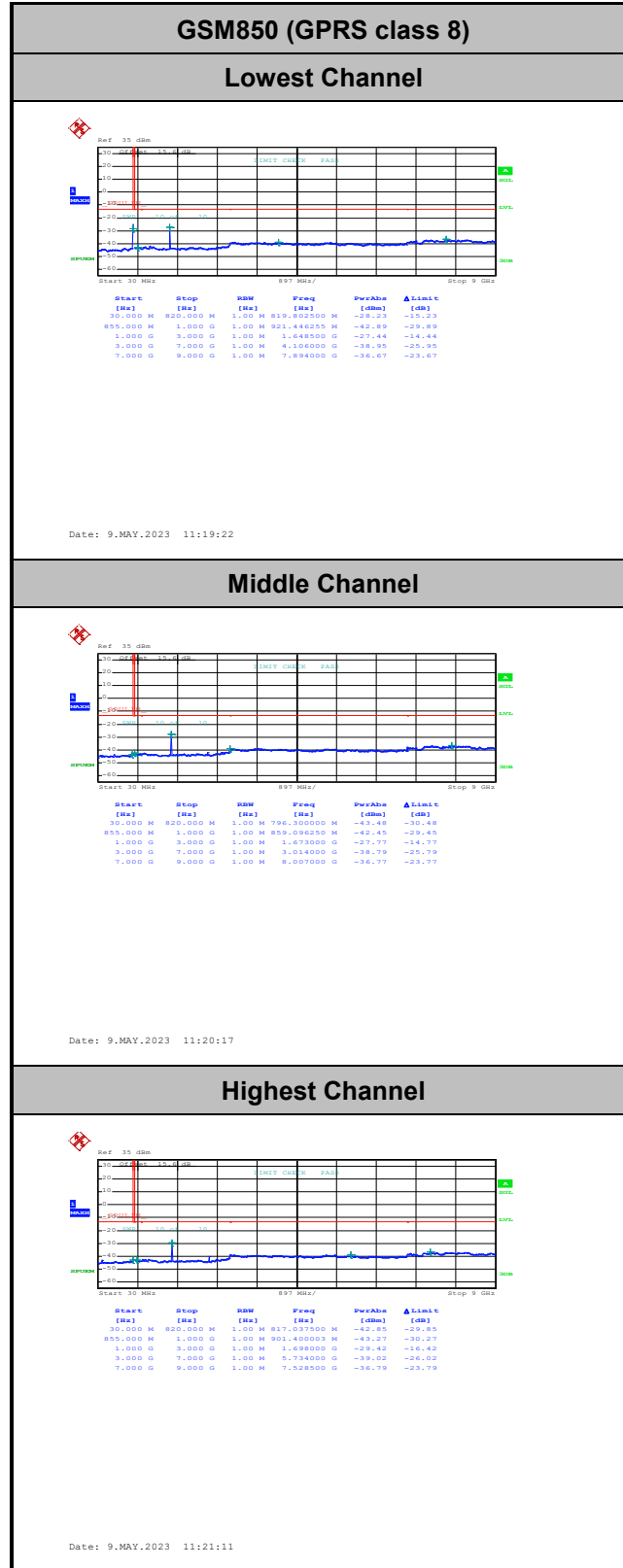



GSM1900 (GPRS class 8)

Lowest Channel

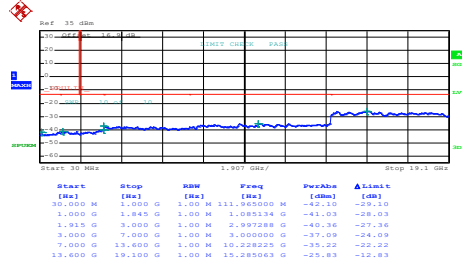

Date: 9.MAY.2023 11:48:46

Middle Channel

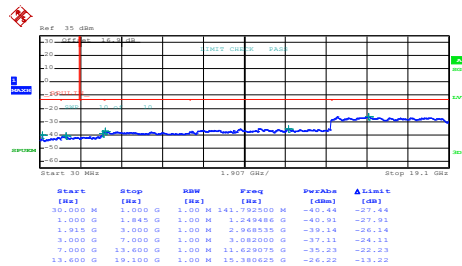

Date: 9.MAY.2023 11:49:38

Highest Channel

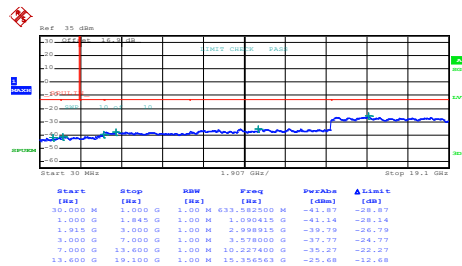

Date: 9.MAY.2023 11:50:31



Frequency Stability

Test Conditions	Middle Channel	GSM850 (GPRS class 8)	Limit 2.5ppm
Temperature (°C)	Voltage (Volt)	Deviation (ppm)	Result
50	Normal Voltage	0.0239	PASS
40	Normal Voltage	0.0275	
30	Normal Voltage	0.0323	
20(Ref.)	Normal Voltage	0.0000	
10	Normal Voltage	0.0155	
0	Normal Voltage	0.0024	
-10	Normal Voltage	0.0155	
-20	Normal Voltage	0.0024	
-30	Normal Voltage	0.0179	
20	Maximum Voltage	0.0143	
20	Normal Voltage	0.0012	
20	Battery End Point	0.0108	

Test Conditions	Middle Channel	GSM1900 (GPRS class 8)	Limit Note 2.
Temperature (°C)	Voltage (Volt)	Deviation (ppm)	Result
50	Normal Voltage	0.0032	PASS
40	Normal Voltage	0.0011	
30	Normal Voltage	0.0021	
20(Ref.)	Normal Voltage	0.0000	
10	Normal Voltage	0.0261	
0	Normal Voltage	0.0213	
-10	Normal Voltage	0.0218	
-20	Normal Voltage	0.0229	
-30	Normal Voltage	0.0011	
20	Maximum Voltage	0.0005	
20	Normal Voltage	0.0000	
20	Battery End Point	0.0106	

Note:

1. Normal Voltage = 3.89V. ; Battery End Point (BEP) = 3.60 V. ; Maximum Voltage =4.40 V
2. The frequency fundamental emissions stay within the authorized frequency block.



A3. WCDMA

Peak-to-Average Ratio

Mode	WCDMA Band V	WCDMA Band II	WCDMA Band IV	Limit: 13dB
Mod.	RMC 12.2Kbps	RMC 12.2Kbps	RMC 12.2Kbps	Result
Lowest CH	3.28	3.28	3.12	PASS
Middle CH	3.36	3.28	3.20	
Highest CH	3.20	3.36	3.12	

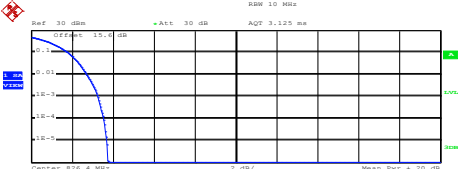
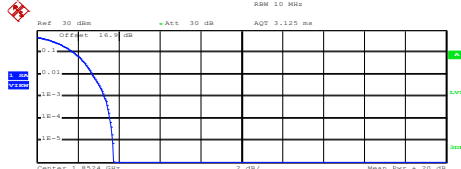
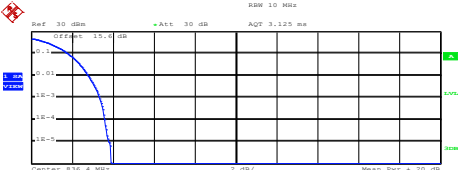
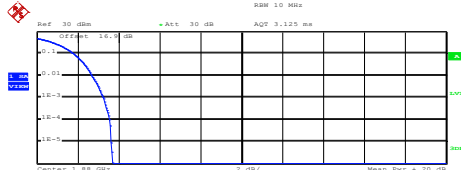
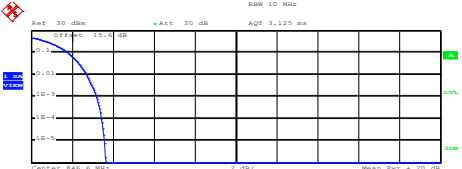
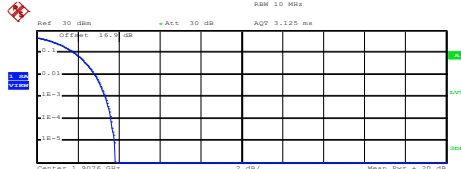

WCDMA Band V (RMC 12.2Kbps)	WCDMA Band II (RMC 12.2Kbps)																
<p align="center">Lowest Channel</p>  <p>Center: 826.4 MHz 2 dB/ Mean Pwr = 20 dB</p> <p>Complementary Cumulative Distribution Function (100000 samples) Trace 1 Mean 23.95 dBm Peak 27.71 dBm Crest 3.76 dB</p> <table border="1"> <tr><td>10 %</td><td>1.80 dB</td></tr> <tr><td>1 %</td><td>2.72 dB</td></tr> <tr><td>.1 %</td><td>3.28 dB</td></tr> <tr><td>.01 %</td><td>3.56 dB</td></tr> </table> <p>Date: 8.MAY.2023 17:28:25</p>	10 %	1.80 dB	1 %	2.72 dB	.1 %	3.28 dB	.01 %	3.56 dB	<p align="center">Lowest Channel</p>  <p>Center: 1.8524 GHz 2 dB/ Mean Pwr = 20 dB</p> <p>Complementary Cumulative Distribution Function (100000 samples) Trace 1 Mean 24.18 dBm Peak 27.92 dBm Crest 3.74 dB</p> <table border="1"> <tr><td>10 %</td><td>1.80 dB</td></tr> <tr><td>1 %</td><td>2.72 dB</td></tr> <tr><td>.1 %</td><td>3.28 dB</td></tr> <tr><td>.01 %</td><td>3.56 dB</td></tr> </table> <p>Date: 9.MAY.2023 10:01:59</p>	10 %	1.80 dB	1 %	2.72 dB	.1 %	3.28 dB	.01 %	3.56 dB
10 %	1.80 dB																
1 %	2.72 dB																
.1 %	3.28 dB																
.01 %	3.56 dB																
10 %	1.80 dB																
1 %	2.72 dB																
.1 %	3.28 dB																
.01 %	3.56 dB																
<p align="center">Middle Channel</p>  <p>Center: 826.4 MHz 2 dB/ Mean Pwr = 20 dB</p> <p>Complementary Cumulative Distribution Function (100000 samples) Trace 1 Mean 23.86 dBm Peak 27.78 dBm Crest 3.92 dB</p> <table border="1"> <tr><td>10 %</td><td>1.80 dB</td></tr> <tr><td>1 %</td><td>2.80 dB</td></tr> <tr><td>.1 %</td><td>3.36 dB</td></tr> <tr><td>.01 %</td><td>3.60 dB</td></tr> </table> <p>Date: 8.MAY.2023 17:28:45</p>	10 %	1.80 dB	1 %	2.80 dB	.1 %	3.36 dB	.01 %	3.60 dB	<p align="center">Middle Channel</p>  <p>Center: 1.88 GHz 2 dB/ Mean Pwr = 20 dB</p> <p>Complementary Cumulative Distribution Function (100000 samples) Trace 1 Mean 24.02 dBm Peak 27.71 dBm Crest 3.70 dB</p> <table border="1"> <tr><td>10 %</td><td>1.80 dB</td></tr> <tr><td>1 %</td><td>2.68 dB</td></tr> <tr><td>.1 %</td><td>3.28 dB</td></tr> <tr><td>.01 %</td><td>3.56 dB</td></tr> </table> <p>Date: 9.MAY.2023 10:02:19</p>	10 %	1.80 dB	1 %	2.68 dB	.1 %	3.28 dB	.01 %	3.56 dB
10 %	1.80 dB																
1 %	2.80 dB																
.1 %	3.36 dB																
.01 %	3.60 dB																
10 %	1.80 dB																
1 %	2.68 dB																
.1 %	3.28 dB																
.01 %	3.56 dB																
<p align="center">Highest Channel</p>  <p>Center: 826.4 MHz 2 dB/ Mean Pwr = 20 dB</p> <p>Complementary Cumulative Distribution Function (100000 samples) Trace 1 Mean 23.92 dBm Peak 27.57 dBm Crest 3.65 dB</p> <table border="1"> <tr><td>10 %</td><td>1.80 dB</td></tr> <tr><td>1 %</td><td>2.72 dB</td></tr> <tr><td>.1 %</td><td>3.20 dB</td></tr> <tr><td>.01 %</td><td>3.44 dB</td></tr> </table> <p>Date: 8.MAY.2023 17:29:05</p>	10 %	1.80 dB	1 %	2.72 dB	.1 %	3.20 dB	.01 %	3.44 dB	<p align="center">Highest Channel</p>  <p>Center: 1.9276 GHz 2 dB/ Mean Pwr = 20 dB</p> <p>Complementary Cumulative Distribution Function (100000 samples) Trace 1 Mean 24.17 dBm Peak 27.99 dBm Crest 3.82 dB</p> <table border="1"> <tr><td>10 %</td><td>1.84 dB</td></tr> <tr><td>1 %</td><td>2.84 dB</td></tr> <tr><td>.1 %</td><td>3.36 dB</td></tr> <tr><td>.01 %</td><td>3.64 dB</td></tr> </table> <p>Date: 9.MAY.2023 10:02:38</p>	10 %	1.84 dB	1 %	2.84 dB	.1 %	3.36 dB	.01 %	3.64 dB
10 %	1.80 dB																
1 %	2.72 dB																
.1 %	3.20 dB																
.01 %	3.44 dB																
10 %	1.84 dB																
1 %	2.84 dB																
.1 %	3.36 dB																
.01 %	3.64 dB																



WCDMA Band IV (RMC 12.2Kbps)

Lowest Channel

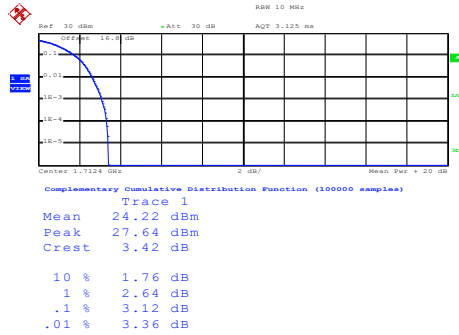

Date: 9.MAY.2023 10:53:20

Middle Channel

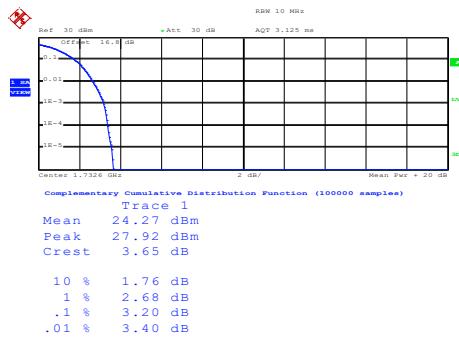

Date: 9.MAY.2023 10:53:38

Highest Channel

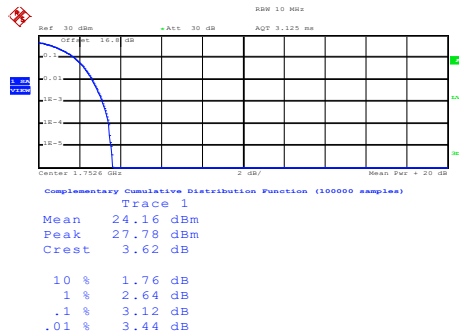

Date: 9.MAY.2023 10:54:01



26dB Bandwidth

Mode	WCDMA Band V 26dB BW(MHz)	WCDMA Band II 26dB BW(MHz)	WCDMA Band IV 26dB BW(MHz)
Mod.	RMC 12.2Kbps	RMC 12.2Kbps	RMC 12.2Kbps
Lowest CH	4.76	4.75	4.76
Middle CH	4.74	4.75	4.76
Highest CH	4.76	4.75	4.75

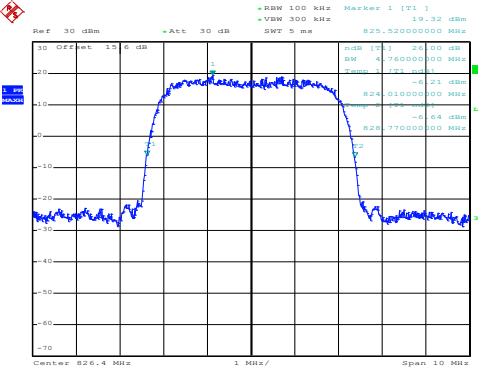
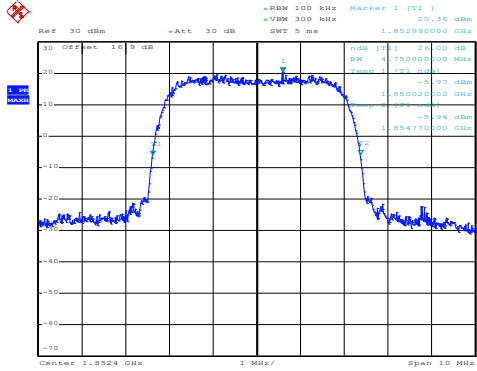
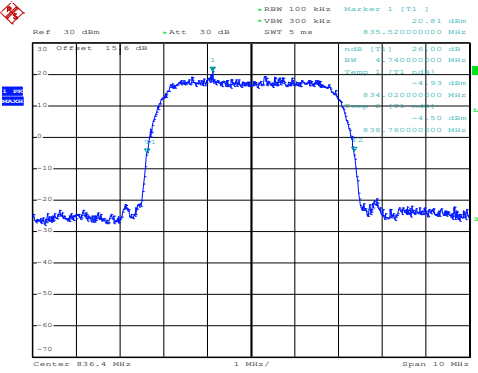
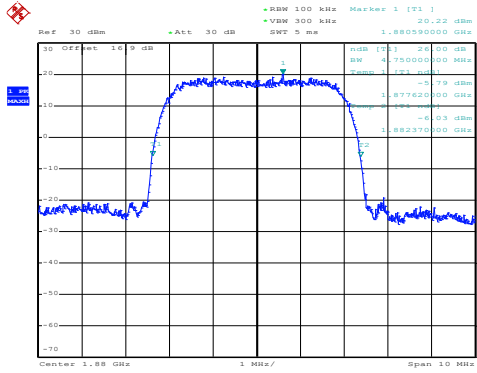
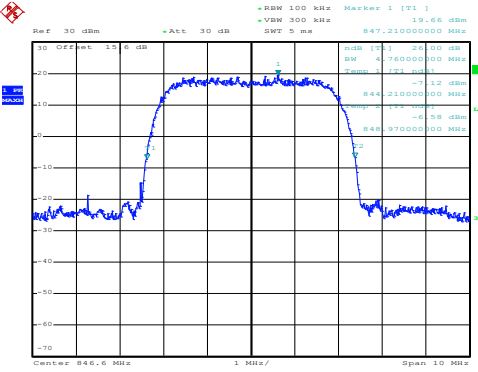
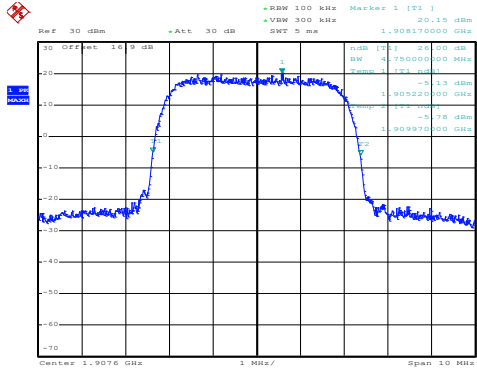

WCDMA Band V (RMC 12.2Kbps)	WCDMA Band II (RMC 12.2Kbps)
<p style="text-align: center;">Lowest Channel</p>  <p>Date: 8.MAY.2023 17:15:00</p>	<p style="text-align: center;">Lowest Channel</p>  <p>Date: 9.MAY.2023 09:47:27</p>
<p style="text-align: center;">Middle Channel</p>  <p>Date: 8.MAY.2023 17:15:40</p>	<p style="text-align: center;">Middle Channel</p>  <p>Date: 9.MAY.2023 09:48:14</p>
<p style="text-align: center;">Highest Channel</p>  <p>Date: 8.MAY.2023 17:16:20</p>	<p style="text-align: center;">Highest Channel</p>  <p>Date: 9.MAY.2023 09:48:56</p>



WCDMA Band IV (RMC 12.2Kbps)

Lowest Channel

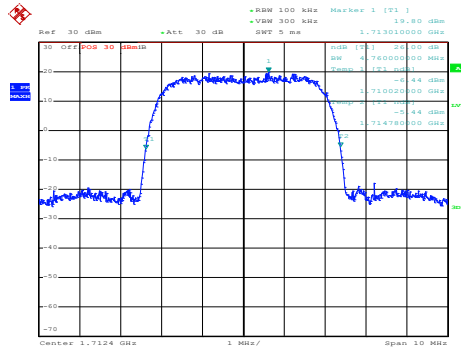

Date: 9.MAY.2023 10:36:37

Middle Channel

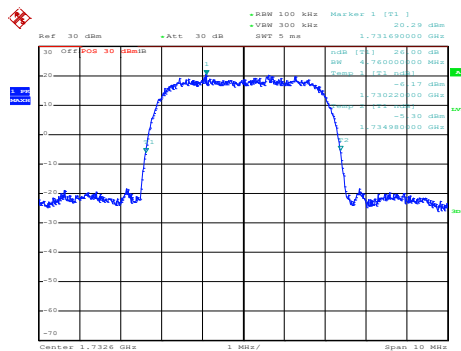

Date: 9.MAY.2023 10:37:18

Highest Channel

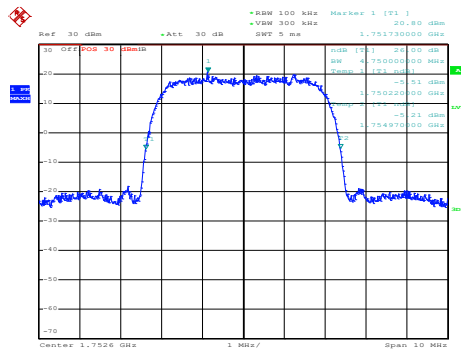

Date: 9.MAY.2023 10:37:58



Occupied Bandwidth

Mode	WCDMA Band V 99%OBW(MHz)	WCDMA Band II 99%OBW(MHz)	WCDMA Band IV 99%OBW(MHz)
Mod.	RMC 12.2Kbps	RMC 12.2Kbps	RMC 12.2Kbps
Lowest CH	4.18	4.17	4.17
Middle CH	4.19	4.19	4.18
Highest CH	4.17	4.16	4.19



WCDMA Band V (RMC 12.2Kbps)	WCDMA Band II (RMC 12.2Kbps)
<p style="text-align: center;">Lowest Channel</p> <p>Date: 8.MAY.2023 17:17:23</p>	<p style="text-align: center;">Lowest Channel</p> <p>Date: 9.MAY.2023 09:50:01</p>
<p style="text-align: center;">Middle Channel</p> <p>Date: 8.MAY.2023 17:18:02</p>	<p style="text-align: center;">Middle Channel</p> <p>Date: 9.MAY.2023 09:50:39</p>
<p style="text-align: center;">Highest Channel</p> <p>Date: 8.MAY.2023 17:18:42</p>	<p style="text-align: center;">Highest Channel</p> <p>Date: 9.MAY.2023 09:51:19</p>



WCDMA Band IV (RMC 12.2Kbps)

Lowest Channel

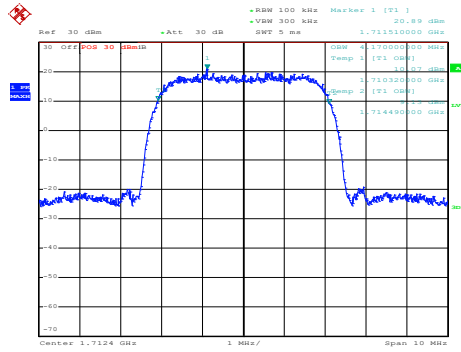

Date: 9.MAY.2023 10:40:47

Middle Channel

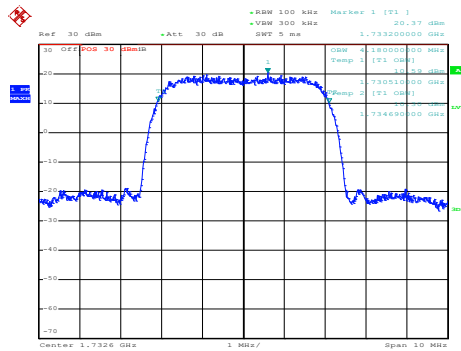

Date: 9.MAY.2023 10:41:29

Highest Channel

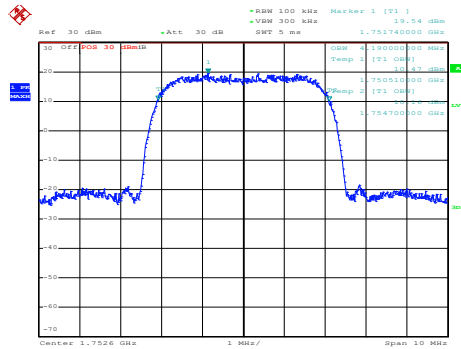

Date: 9.MAY.2023 10:42:31



Conducted Band Edge

WCDMA Band V (RMC 12.2Kbps)

Lowest Band Edge

Highest Band Edge

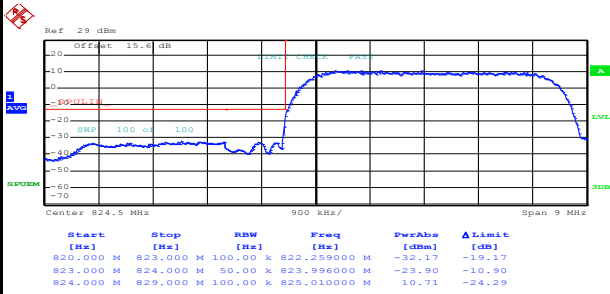

Date: 8.MAY.2023 17:21:48

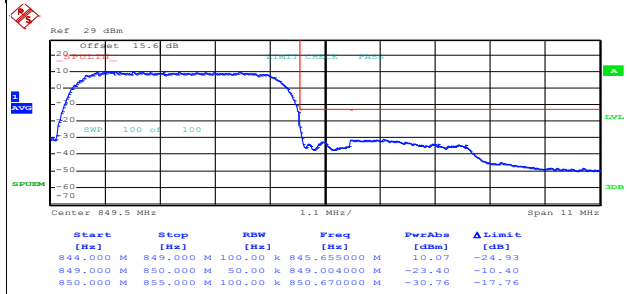

Date: 8.MAY.2023 17:24:42



WCDMA Band II (RMC 12.2Kbps)

Lowest Band Edge

Highest Band Edge

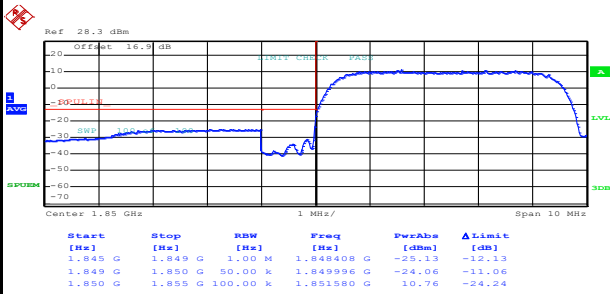

Date: 9.MAY.2023 09:54:32

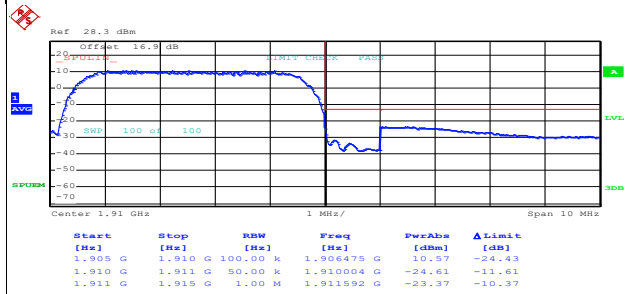

Date: 9.MAY.2023 09:57:26



WCDMA Band IV (RMC 12.2Kbps)

Lowest Band Edge

Highest Band Edge

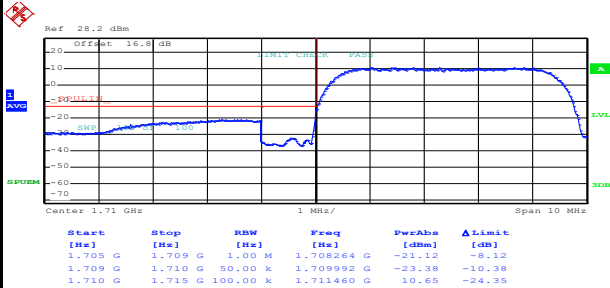

Date: 9.MAY.2023 10:45:48

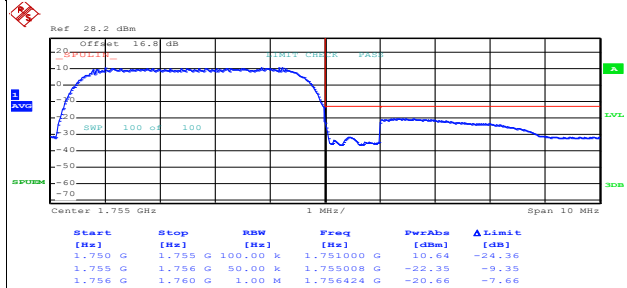

Date: 9.MAY.2023 10:48:46



Conducted Spurious Emission

WCDMA Band V (RMC 12.2Kbps)	WCDMA Band II (RMC 12.2Kbps)																																																																														
<p>Lowest Channel</p> <table border="1"> <thead> <tr> <th>START [Hz]</th> <th>STOP [Hz]</th> <th>RBW [Hz]</th> <th>Freq [Hz]</th> <th>PwrAbs [dBm]</th> <th>ΔLimit [dB]</th> </tr> </thead> <tbody> <tr> <td>30.000 M</td> <td>820.000 M</td> <td>1.00 M</td> <td>819.800000 M</td> <td>-31.12</td> <td>-18.12</td> </tr> <tr> <td>855.000 M</td> <td>1.000 G</td> <td>1.00 M</td> <td>857.012500 M</td> <td>-42.56</td> <td>-29.56</td> </tr> <tr> <td>1.000 G</td> <td>3.000 G</td> <td>1.00 M</td> <td>2.999000 G</td> <td>-40.55</td> <td>-27.55</td> </tr> <tr> <td>3.000 G</td> <td>7.000 G</td> <td>1.00 M</td> <td>3.124000 G</td> <td>-39.07</td> <td>-26.07</td> </tr> <tr> <td>7.000 G</td> <td>9.000 G</td> <td>1.00 M</td> <td>8.338500 G</td> <td>-36.25</td> <td>-23.25</td> </tr> </tbody> </table> <p>Date: 8.MAY.2023 17:25:53</p>	START [Hz]	STOP [Hz]	RBW [Hz]	Freq [Hz]	PwrAbs [dBm]	ΔLimit [dB]	30.000 M	820.000 M	1.00 M	819.800000 M	-31.12	-18.12	855.000 M	1.000 G	1.00 M	857.012500 M	-42.56	-29.56	1.000 G	3.000 G	1.00 M	2.999000 G	-40.55	-27.55	3.000 G	7.000 G	1.00 M	3.124000 G	-39.07	-26.07	7.000 G	9.000 G	1.00 M	8.338500 G	-36.25	-23.25	<p>Lowest Channel</p> <table border="1"> <thead> <tr> <th>START [Hz]</th> <th>STOP [Hz]</th> <th>RBW [Hz]</th> <th>Freq [Hz]</th> <th>PwrAbs [dBm]</th> <th>ΔLimit [dB]</th> </tr> </thead> <tbody> <tr> <td>30.000 M</td> <td>2.000 G</td> <td>1.00 M</td> <td>880.600000 M</td> <td>-42.74</td> <td>-29.74</td> </tr> <tr> <td>1.000 G</td> <td>1.845 G</td> <td>1.00 M</td> <td>1.844789 G</td> <td>-31.62</td> <td>-18.62</td> </tr> <tr> <td>1.915 G</td> <td>3.000 G</td> <td>1.00 M</td> <td>2.812295 G</td> <td>-40.29</td> <td>-27.29</td> </tr> <tr> <td>3.000 G</td> <td>7.000 G</td> <td>1.00 M</td> <td>3.013000 G</td> <td>-37.87</td> <td>-24.87</td> </tr> <tr> <td>7.000 G</td> <td>13.680 G</td> <td>1.00 M</td> <td>10.236475 G</td> <td>-35.21</td> <td>-22.21</td> </tr> <tr> <td>13.680 G</td> <td>19.100 G</td> <td>1.00 M</td> <td>15.297437 G</td> <td>-25.95</td> <td>-12.95</td> </tr> </tbody> </table> <p>Date: 9.MAY.2023 09:59:18</p>	START [Hz]	STOP [Hz]	RBW [Hz]	Freq [Hz]	PwrAbs [dBm]	ΔLimit [dB]	30.000 M	2.000 G	1.00 M	880.600000 M	-42.74	-29.74	1.000 G	1.845 G	1.00 M	1.844789 G	-31.62	-18.62	1.915 G	3.000 G	1.00 M	2.812295 G	-40.29	-27.29	3.000 G	7.000 G	1.00 M	3.013000 G	-37.87	-24.87	7.000 G	13.680 G	1.00 M	10.236475 G	-35.21	-22.21	13.680 G	19.100 G	1.00 M	15.297437 G	-25.95	-12.95
START [Hz]	STOP [Hz]	RBW [Hz]	Freq [Hz]	PwrAbs [dBm]	ΔLimit [dB]																																																																										
30.000 M	820.000 M	1.00 M	819.800000 M	-31.12	-18.12																																																																										
855.000 M	1.000 G	1.00 M	857.012500 M	-42.56	-29.56																																																																										
1.000 G	3.000 G	1.00 M	2.999000 G	-40.55	-27.55																																																																										
3.000 G	7.000 G	1.00 M	3.124000 G	-39.07	-26.07																																																																										
7.000 G	9.000 G	1.00 M	8.338500 G	-36.25	-23.25																																																																										
START [Hz]	STOP [Hz]	RBW [Hz]	Freq [Hz]	PwrAbs [dBm]	ΔLimit [dB]																																																																										
30.000 M	2.000 G	1.00 M	880.600000 M	-42.74	-29.74																																																																										
1.000 G	1.845 G	1.00 M	1.844789 G	-31.62	-18.62																																																																										
1.915 G	3.000 G	1.00 M	2.812295 G	-40.29	-27.29																																																																										
3.000 G	7.000 G	1.00 M	3.013000 G	-37.87	-24.87																																																																										
7.000 G	13.680 G	1.00 M	10.236475 G	-35.21	-22.21																																																																										
13.680 G	19.100 G	1.00 M	15.297437 G	-25.95	-12.95																																																																										
<p>Middle Channel</p> <table border="1"> <thead> <tr> <th>START [Hz]</th> <th>STOP [Hz]</th> <th>RBW [Hz]</th> <th>Freq [Hz]</th> <th>PwrAbs [dBm]</th> <th>ΔLimit [dB]</th> </tr> </thead> <tbody> <tr> <td>30.000 M</td> <td>820.000 M</td> <td>1.00 M</td> <td>811.700000 M</td> <td>-43.67</td> <td>-30.67</td> </tr> <tr> <td>855.000 M</td> <td>1.000 G</td> <td>1.00 M</td> <td>857.537500 M</td> <td>-42.80</td> <td>-29.80</td> </tr> <tr> <td>1.000 G</td> <td>3.000 G</td> <td>1.00 M</td> <td>2.979500 G</td> <td>-41.36</td> <td>-28.36</td> </tr> <tr> <td>3.000 G</td> <td>7.000 G</td> <td>1.00 M</td> <td>3.117000 G</td> <td>-39.64</td> <td>-26.64</td> </tr> <tr> <td>7.000 G</td> <td>9.000 G</td> <td>1.00 M</td> <td>8.338500 G</td> <td>-36.57</td> <td>-23.57</td> </tr> </tbody> </table> <p>Date: 8.MAY.2023 17:26:49</p>	START [Hz]	STOP [Hz]	RBW [Hz]	Freq [Hz]	PwrAbs [dBm]	ΔLimit [dB]	30.000 M	820.000 M	1.00 M	811.700000 M	-43.67	-30.67	855.000 M	1.000 G	1.00 M	857.537500 M	-42.80	-29.80	1.000 G	3.000 G	1.00 M	2.979500 G	-41.36	-28.36	3.000 G	7.000 G	1.00 M	3.117000 G	-39.64	-26.64	7.000 G	9.000 G	1.00 M	8.338500 G	-36.57	-23.57	<p>Middle Channel</p> <table border="1"> <thead> <tr> <th>START [Hz]</th> <th>STOP [Hz]</th> <th>RBW [Hz]</th> <th>Freq [Hz]</th> <th>PwrAbs [dBm]</th> <th>ΔLimit [dB]</th> </tr> </thead> <tbody> <tr> <td>30.000 M</td> <td>1.000 G</td> <td>1.00 M</td> <td>141.000000 M</td> <td>-41.90</td> <td>-28.90</td> </tr> <tr> <td>1.000 G</td> <td>1.845 G</td> <td>1.00 M</td> <td>1.740079 G</td> <td>-41.48</td> <td>-28.48</td> </tr> <tr> <td>1.915 G</td> <td>3.000 G</td> <td>1.00 M</td> <td>2.993761 G</td> <td>-39.58</td> <td>-26.58</td> </tr> <tr> <td>3.000 G</td> <td>7.000 G</td> <td>1.00 M</td> <td>3.588000 G</td> <td>-37.62</td> <td>-24.62</td> </tr> <tr> <td>7.000 G</td> <td>13.680 G</td> <td>1.00 M</td> <td>10.326875 G</td> <td>-35.48</td> <td>-22.48</td> </tr> <tr> <td>13.680 G</td> <td>19.100 G</td> <td>1.00 M</td> <td>15.284375 G</td> <td>-26.24</td> <td>-13.24</td> </tr> </tbody> </table> <p>Date: 9.MAY.2023 10:00:14</p>	START [Hz]	STOP [Hz]	RBW [Hz]	Freq [Hz]	PwrAbs [dBm]	ΔLimit [dB]	30.000 M	1.000 G	1.00 M	141.000000 M	-41.90	-28.90	1.000 G	1.845 G	1.00 M	1.740079 G	-41.48	-28.48	1.915 G	3.000 G	1.00 M	2.993761 G	-39.58	-26.58	3.000 G	7.000 G	1.00 M	3.588000 G	-37.62	-24.62	7.000 G	13.680 G	1.00 M	10.326875 G	-35.48	-22.48	13.680 G	19.100 G	1.00 M	15.284375 G	-26.24	-13.24
START [Hz]	STOP [Hz]	RBW [Hz]	Freq [Hz]	PwrAbs [dBm]	ΔLimit [dB]																																																																										
30.000 M	820.000 M	1.00 M	811.700000 M	-43.67	-30.67																																																																										
855.000 M	1.000 G	1.00 M	857.537500 M	-42.80	-29.80																																																																										
1.000 G	3.000 G	1.00 M	2.979500 G	-41.36	-28.36																																																																										
3.000 G	7.000 G	1.00 M	3.117000 G	-39.64	-26.64																																																																										
7.000 G	9.000 G	1.00 M	8.338500 G	-36.57	-23.57																																																																										
START [Hz]	STOP [Hz]	RBW [Hz]	Freq [Hz]	PwrAbs [dBm]	ΔLimit [dB]																																																																										
30.000 M	1.000 G	1.00 M	141.000000 M	-41.90	-28.90																																																																										
1.000 G	1.845 G	1.00 M	1.740079 G	-41.48	-28.48																																																																										
1.915 G	3.000 G	1.00 M	2.993761 G	-39.58	-26.58																																																																										
3.000 G	7.000 G	1.00 M	3.588000 G	-37.62	-24.62																																																																										
7.000 G	13.680 G	1.00 M	10.326875 G	-35.48	-22.48																																																																										
13.680 G	19.100 G	1.00 M	15.284375 G	-26.24	-13.24																																																																										
<p>Highest Channel</p> <table border="1"> <thead> <tr> <th>START [Hz]</th> <th>STOP [Hz]</th> <th>RBW [Hz]</th> <th>Freq [Hz]</th> <th>PwrAbs [dBm]</th> <th>ΔLimit [dB]</th> </tr> </thead> <tbody> <tr> <td>30.000 M</td> <td>820.000 M</td> <td>1.00 M</td> <td>855.187000 M</td> <td>-43.99</td> <td>-30.99</td> </tr> <tr> <td>855.000 M</td> <td>1.000 G</td> <td>1.00 M</td> <td>857.791250 M</td> <td>-43.87</td> <td>-30.87</td> </tr> <tr> <td>1.000 G</td> <td>3.000 G</td> <td>1.00 M</td> <td>2.999000 G</td> <td>-41.41</td> <td>-28.41</td> </tr> <tr> <td>3.000 G</td> <td>7.000 G</td> <td>1.00 M</td> <td>3.403000 G</td> <td>-38.57</td> <td>-25.57</td> </tr> <tr> <td>7.000 G</td> <td>9.000 G</td> <td>1.00 M</td> <td>8.156500 G</td> <td>-36.48</td> <td>-23.48</td> </tr> </tbody> </table> <p>Date: 8.MAY.2023 17:27:46</p>	START [Hz]	STOP [Hz]	RBW [Hz]	Freq [Hz]	PwrAbs [dBm]	ΔLimit [dB]	30.000 M	820.000 M	1.00 M	855.187000 M	-43.99	-30.99	855.000 M	1.000 G	1.00 M	857.791250 M	-43.87	-30.87	1.000 G	3.000 G	1.00 M	2.999000 G	-41.41	-28.41	3.000 G	7.000 G	1.00 M	3.403000 G	-38.57	-25.57	7.000 G	9.000 G	1.00 M	8.156500 G	-36.48	-23.48	<p>Highest Channel</p> <table border="1"> <thead> <tr> <th>START [Hz]</th> <th>STOP [Hz]</th> <th>RBW [Hz]</th> <th>Freq [Hz]</th> <th>PwrAbs [dBm]</th> <th>ΔLimit [dB]</th> </tr> </thead> <tbody> <tr> <td>30.000 M</td> <td>2.000 G</td> <td>1.00 M</td> <td>168.407000 M</td> <td>-40.84</td> <td>-27.84</td> </tr> <tr> <td>1.000 G</td> <td>1.845 G</td> <td>1.00 M</td> <td>1.187379 G</td> <td>-41.91</td> <td>-28.91</td> </tr> <tr> <td>1.915 G</td> <td>3.000 G</td> <td>1.00 M</td> <td>1.952071 G</td> <td>-28.67</td> <td>-15.67</td> </tr> <tr> <td>3.000 G</td> <td>7.000 G</td> <td>1.00 M</td> <td>3.044000 G</td> <td>-37.82</td> <td>-24.82</td> </tr> <tr> <td>7.000 G</td> <td>13.680 G</td> <td>1.00 M</td> <td>10.213375 G</td> <td>-35.12</td> <td>-22.12</td> </tr> <tr> <td>13.680 G</td> <td>19.100 G</td> <td>1.00 M</td> <td>15.302938 G</td> <td>-25.38</td> <td>-12.38</td> </tr> </tbody> </table> <p>Date: 9.MAY.2023 10:01:13</p>	START [Hz]	STOP [Hz]	RBW [Hz]	Freq [Hz]	PwrAbs [dBm]	ΔLimit [dB]	30.000 M	2.000 G	1.00 M	168.407000 M	-40.84	-27.84	1.000 G	1.845 G	1.00 M	1.187379 G	-41.91	-28.91	1.915 G	3.000 G	1.00 M	1.952071 G	-28.67	-15.67	3.000 G	7.000 G	1.00 M	3.044000 G	-37.82	-24.82	7.000 G	13.680 G	1.00 M	10.213375 G	-35.12	-22.12	13.680 G	19.100 G	1.00 M	15.302938 G	-25.38	-12.38
START [Hz]	STOP [Hz]	RBW [Hz]	Freq [Hz]	PwrAbs [dBm]	ΔLimit [dB]																																																																										
30.000 M	820.000 M	1.00 M	855.187000 M	-43.99	-30.99																																																																										
855.000 M	1.000 G	1.00 M	857.791250 M	-43.87	-30.87																																																																										
1.000 G	3.000 G	1.00 M	2.999000 G	-41.41	-28.41																																																																										
3.000 G	7.000 G	1.00 M	3.403000 G	-38.57	-25.57																																																																										
7.000 G	9.000 G	1.00 M	8.156500 G	-36.48	-23.48																																																																										
START [Hz]	STOP [Hz]	RBW [Hz]	Freq [Hz]	PwrAbs [dBm]	ΔLimit [dB]																																																																										
30.000 M	2.000 G	1.00 M	168.407000 M	-40.84	-27.84																																																																										
1.000 G	1.845 G	1.00 M	1.187379 G	-41.91	-28.91																																																																										
1.915 G	3.000 G	1.00 M	1.952071 G	-28.67	-15.67																																																																										
3.000 G	7.000 G	1.00 M	3.044000 G	-37.82	-24.82																																																																										
7.000 G	13.680 G	1.00 M	10.213375 G	-35.12	-22.12																																																																										
13.680 G	19.100 G	1.00 M	15.302938 G	-25.38	-12.38																																																																										



WCDMA Band IV (RMC 12.2Kbps)

Lowest Channel

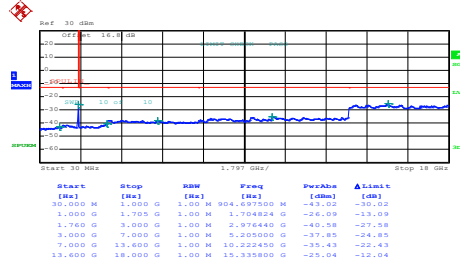

Date: 9.MAY.2023 10:50:53

Middle Channel

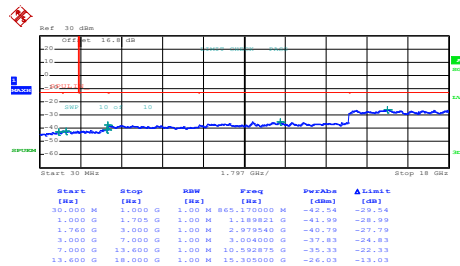

Date: 9.MAY.2023 10:51:49

Highest Channel

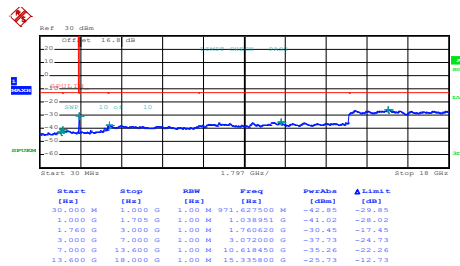

Date: 9.MAY.2023 10:52:51



Frequency Stability

Test Conditions	Middle Channel	WCDMA Band V (RMC 12.2Kbps)	Limit 2.5ppm
Temperature (°C)	Voltage (Volt)	Deviation (ppm)	Result
50	Normal Voltage	0.0024	PASS
40	Normal Voltage	0.0024	
30	Normal Voltage	0.0108	
20(Ref.)	Normal Voltage	0.0000	
10	Normal Voltage	0.0012	
0	Normal Voltage	0.0096	
-10	Normal Voltage	0.0155	
-20	Normal Voltage	0.0167	
-30	Normal Voltage	0.0191	
20	Maximum Voltage	0.0024	
20	Normal Voltage	0.0000	
20	Battery End Point	0.0048	

Test Conditions	Middle Channel	WCDMA Band II (RMC 12.2Kbps)	Limit Note 2.
Temperature (°C)	Voltage (Volt)	Deviation (ppm)	Result
50	Normal Voltage	0.0016	PASS
40	Normal Voltage	0.0011	
30	Normal Voltage	0.0069	
20(Ref.)	Normal Voltage	0.0000	
10	Normal Voltage	0.0154	
0	Normal Voltage	0.0101	
-10	Normal Voltage	0.0181	
-20	Normal Voltage	0.0170	
-30	Normal Voltage	0.0144	
20	Maximum Voltage	0.0011	
20	Normal Voltage	0.0000	
20	Battery End Point	0.0016	



Test Conditions	Middle Channel	WCDMA Band IV (RMC 12.2Kbps)	Limit Note 2.
Temperature (°C)	Voltage (Volt)	Deviation (ppm)	Result
50	Normal Voltage	0.0040	PASS
40	Normal Voltage	0.0052	
30	Normal Voltage	0.0012	
20(Ref.)	Normal Voltage	0.0000	
10	Normal Voltage	0.0046	
0	Normal Voltage	0.0017	
-10	Normal Voltage	0.0006	
-20	Normal Voltage	0.0104	
-30	Normal Voltage	0.0046	
20	Maximum Voltage	0.0012	
20	Normal Voltage	0.0000	
20	Battery End Point	0.0046	

Note:

1. Normal Voltage = 3.89V. ; Battery End Point (BEP) = 3.60 V. ; Maximum Voltage =4.40 V
2. The frequency fundamental emissions stay within the authorized frequency block.



Appendix B. Test Results of Radiated Test

<Primary Antenna>
<Ant. 0>

GSM 850

GSM 850									
Channel	Frequency (MHz)	ERP (dBm)	Limit (dBm)	Margin (dB)	SPA Reading (dBm)	S.G. Power (dBm)	TX Cable loss (dB)	TX Antenna Gain (dBi)	Polarization (H/V)
Lowest	1648	-47.85	-13	-34.85	-59.58	-54.12	0.81	9.24	H
	2472	-37.57	-13	-24.57	-52.44	-44.71	0.97	10.26	H
	3296	-64.65	-13	-51.65	-81.75	-72.16	1.12	10.78	H
									H
									H
									H
	1648	-51.83	-13.00	-38.83	-63.39	-58.10	0.81	9.24	V
	2472	-39.21	-13	-26.21	-53.94	-46.35	0.97	10.26	V
	3296	-64.30	-13	-51.30	-81.36	-71.81	1.12	10.78	V
									V
									V
									V
Middle	1672	-51.99	-13	-38.99	-63.83	-58.43	0.82	9.40	H
	2508	-34.23	-13	-21.23	-49.11	-41.32	0.97	10.21	H
	3344	-64.70	-13	-51.70	-81.89	-72.40	1.13	10.98	H
									H
									H
									H
	1672	-47.74	-13	-34.74	-59.42	-54.18	0.82	9.40	V
	2508	-41.40	-13	-28.40	-56.17	-48.49	0.97	10.21	V
	3344	-64.42	-13	-51.42	-81.59	-72.12	1.13	10.98	V
									V
									V
									V



Highest	1697	-49.57	-13	-36.57	-61.53	-56.17	0.82	9.58	H
	2546	-37.46	-13	-24.46	-52.42	-44.58	0.98	10.25	H
	3395	-64.68	-13	-51.68	-81.98	-72.57	1.14	11.18	H
									H
									H
									H
									H
	1697	-48.17	-13	-35.17	-59.97	-54.77	0.82	9.58	V
	2546	-41.20	-13	-28.20	-56.12	-48.32	0.98	10.25	V
	3395	-63.97	-13	-50.97	-81.27	-71.86	1.14	11.18	V
									V
									V
									V
									V

Remark: Spurious emissions within 30-1000MHz were found more than 20dB below limit line.



WCDMA 850

WCDMA 850									
Channel	Frequency (MHz)	ERP (dBm)	Limit (dBm)	Margin (dB)	SPA Reading (dBm)	S.G. Power (dBm)	TX Cable loss (dB)	TX Antenna Gain (dBi)	Polarization (H/V)
Lowest	1652	-64.60	-13	-51.60	-76.36	-70.90	0.81	9.26	H
	2479	-50.39	-13	-37.39	-65.26	-57.51	0.97	10.24	H
	3305	-64.75	-13	-51.75	-81.86	-72.30	1.12	10.82	H
									H
									H
									H
									H
	1652	-64.33	-13.00	-51.33	-75.91	-70.63	0.81	9.26	V
	2479	-53.61	-13	-40.61	-68.35	-60.73	0.97	10.24	V
	3305	-64.40	-13	-51.40	-81.47	-71.95	1.12	10.82	V
									V
									V
									V
									V
Middle	1672	-60.27	-13	-47.27	-72.11	-66.71	0.82	9.40	H
	2509	-47.21	-13	-34.21	-62.09	-54.30	0.97	10.21	H
	3345	-64.84	-13	-51.84	-82.03	-72.54	1.13	10.98	H
									H
									H
									H
									H
	1672	-60.74	-13	-47.74	-72.42	-67.18	0.82	9.40	V
	2509	-52.64	-13	-39.64	-67.42	-59.73	0.97	10.21	V
	3345	-64.62	-13	-51.62	-81.79	-72.32	1.13	10.98	V
									V
									V
									V
									V
								V	



Highest	1693	-61.98	-13	-48.98	-73.93	-68.56	0.82	9.55	H
	2539	-50.83	-13	-37.83	-65.77	-57.94	0.98	10.24	H
	3386	-64.40	-13	-51.40	-81.68	-72.26	1.14	11.14	H
									H
									H
									H
									H
	1693	-61.33	-13	-48.33	-73.11	-67.91	0.82	9.55	V
	2539	-54.99	-13	-41.99	-69.88	-62.10	0.98	10.24	V
	3386	-64.29	-13	-51.29	-81.57	-72.15	1.14	11.14	V
									V
									V
									V
									V

Remark: Spurious emissions within 30-1000MHz were found more than 20dB below limit line.



<Ant. 2>

GSM 1900

GSM 1900									
Channel	Frequency (MHz)	EIRP (dBm)	Limit (dBm)	Margin (dB)	SPA Reading (dBm)	S.G. Power (dBm)	TX Cable loss (dB)	TX Antenna Gain (dBi)	Polarization (H/V)
Lowest	3700	-52.14	-13	-39.14	-71.5	-62.38	1.22	11.45	H
	5550	-57.83	-13	-44.83	-81.84	-68.39	1.44	12.00	H
	7400	-56.61	-13	-43.61	-84.24	-65.94	1.67	11.00	H
									H
									H
									H
									H
	3700	-57.20	-13	-44.20	-76.31	-67.44	1.22	11.45	V
	5550	-59.60	-13	-46.60	-83.5	-70.16	1.44	12.00	V
	7400	-56.56	-13	-43.56	-84.35	-65.89	1.67	11.00	V
									V
									V
									V
									V
Middle	3760	-57.20	-13	-44.20	-79.93	-67.36	1.20	11.36	H
	5640	-59.21	-13	-46.21	-83.25	-69.61	1.54	11.94	H
	7520	-56.62	-13	-43.62	-84.22	-66.31	1.73	11.42	H
									H
									H
									H
									H
	3760	-60.01	-13	-47.01	-79.42	-70.17	1.20	11.36	V
	5640	-59.14	-13	-46.14	-83.22	-69.54	1.54	11.94	V
	7520	-56.46	-13	-43.46	-84.04	-66.15	1.73	11.42	V
									V
									V
									V
									V



Highest	3819	-54.36	-13	-41.36	-74.44	-64.45	1.19	11.28	H
	5729	-59.38	-13	-46.38	-83.34	-69.32	1.64	11.58	H
	7639	-56.41	-13	-43.41	-83.81	-66.05	1.80	11.44	H
									H
									H
									H
									H
	3819	-58.17	-13	-45.17	-77.92	-68.26	1.19	11.28	V
	5729	-58.77	-13	-45.77	-83	-68.71	1.64	11.58	V
	7639	-56.39	-13	-43.39	-83.98	-66.03	1.80	11.44	V
									V
									V
									V
									V

Remark: Spurious emissions within 30-1000MHz were found more than 20dB below limit line.



WCDMA 1900

WCDMA 1900									
Channel	Frequency (MHz)	EIRP (dBm)	Limit (dBm)	Margin (dB)	SPA Reading (dBm)	S.G. Power (dBm)	TX Cable loss (dB)	TX Antenna Gain (dBi)	Polarization (H/V)
Lowest	3704	-62.04	-13	-49.04	-81.43	-72.27	1.21	11.44	H
	5557	-59.16	-13	-46.16	-83.19	-69.73	1.45	12.01	H
	7409	-56.38	-13	-43.38	-84.01	-65.74	1.67	11.04	H
									H
									H
									H
									H
	3704	-62.48	-13	-49.48	-81.61	-72.71	1.21	11.44	V
	5557	-59.42	-13	-46.42	-83.33	-69.99	1.45	12.01	V
	7409	-56.25	-13	-43.25	-84.02	-65.61	1.67	11.04	V
									V
									V
									V
									V
Middle	3760	-61.08	-13	-48.08	-80.81	-71.24	1.20	11.36	H
	5640	-59.36	-13	-46.36	-83.4	-69.76	1.54	11.94	H
	7520	-56.65	-13	-43.65	-84.25	-66.34	1.73	11.42	H
									H
									H
									H
									H
	3760	-61.17	-13	-48.17	-80.58	-71.33	1.20	11.36	V
	5640	-58.87	-13	-45.87	-82.95	-69.27	1.54	11.94	V
	7520	-56.84	-13	-43.84	-84.42	-66.53	1.73	11.42	V
									V
									V
									V
									V



Highest	3815	-60.79	-13	-47.79	-80.84	-70.88	1.19	11.29	H
	5722	-59.60	-13	-46.60	-83.57	-69.58	1.63	11.61	H
	7630	-56.24	-13	-43.24	-83.64	-65.89	1.81	11.46	H
									H
									H
									H
									H
	3815	-61.03	-13	-48.03	-80.74	-71.12	1.19	11.29	V
	5722	-59.24	-13	-46.24	-83.46	-69.22	1.63	11.61	V
	7630	-56.41	-13	-43.41	-84.01	-66.06	1.81	11.46	V
									V
									V
									V
									V

Remark: Spurious emissions within 30-1000MHz were found more than 20dB below limit line.



WCDMA 1700

WCDMA 1700									
Channel	Frequency (MHz)	EIRP (dBm)	Limit (dBm)	Margin (dB)	SPA Reading (dBm)	S.G. Power (dBm)	TX Cable loss (dB)	TX Antenna Gain (dBi)	Polarization (H/V)
Lowest	3424	-63.83	-13	-50.83	-82	-73.93	1.14	11.25	H
	5137	-58.45	-13	-45.45	-81.86	-68.26	1.36	11.17	H
	6849	-57.34	-13	-44.34	-83.74	-66.64	1.60	10.90	H
									H
									H
									H
									H
	3424	-63.82	-13	-50.82	-81.98	-73.92	1.14	11.25	V
	5137	-59.01	-13	-46.01	-82.24	-68.82	1.36	11.17	V
	6849	-56.74	-13	-43.74	-83.83	-66.04	1.60	10.90	V
									V
									V
									V
									V
Middle	3465	-63.27	-13	-50.27	-81.6	-73.45	1.15	11.33	H
	5197	-59.27	-13	-46.27	-82.81	-69.18	1.38	11.29	H
	6930	-57.31	-13	-44.31	-83.9	-66.75	1.62	11.06	H
									H
									H
									H
									H
	3465	-63.09	-13	-50.09	-81.39	-73.27	1.15	11.33	V
	5197	-59.23	-13	-46.23	-82.59	-69.14	1.38	11.29	V
	6930	-56.71	-13	-43.71	-83.88	-66.15	1.62	11.06	V
									V
									V
									V
									V



Highest	3505	-63.41	-13	-50.41	-81.88	-73.66	1.16	11.41	H
	5257	-59.36	-13	-46.36	-82.98	-69.39	1.38	11.41	H
	7010	-56.57	-13	-43.57	-83.33	-66.09	1.64	11.16	H
									H
									H
									H
									H
	3505	-63.16	-13	-50.16	-81.59	-73.41	1.16	11.41	V
	5257	-58.98	-13	-45.98	-82.47	-69.01	1.38	11.41	V
	7010	-56.56	-13	-43.56	-83.79	-66.08	1.64	11.16	V
									V
									V
									V
									V

Remark: Spurious emissions within 30-1000MHz were found more than 20dB below limit line.



<ASDIV Antenna>
<Ant. 1>

GSM 850

GSM 850									
Channel	Frequency (MHz)	ERP (dBm)	Limit (dBm)	Margin (dB)	SPA Reading (dBm)	S.G. Power (dBm)	TX Cable loss (dB)	TX Antenna Gain (dBi)	Polarization (H/V)
Lowest	1648	-69.08	-13	-56.08	-80.81	-75.35	0.81	9.24	H
	2472	-66.14	-13	-53.14	-81.01	-73.28	0.97	10.26	H
	3296	-64.83	-13	-51.83	-81.93	-72.34	1.12	10.78	H
									H
									H
									H
	1648	-69.57	-13.00	-56.57	-81.13	-75.84	0.81	9.24	V
	2472	-67.10	-13	-54.10	-81.83	-74.24	0.97	10.26	V
	3296	-64.61	-13	-51.61	-81.67	-72.12	1.12	10.78	V
									V
									V
									V
Middle	1672	-68.26	-13	-55.26	-80.10	-74.70	0.82	9.40	H
	2509	-66.02	-13	-53.02	-80.90	-73.11	0.97	10.21	H
	3345	-64.61	-13	-51.61	-81.80	-72.31	1.13	10.98	H
									H
									H
									H
	1672	-68.75	-13	-55.75	-80.43	-75.19	0.82	9.40	V
	2509	-65.94	-13	-52.94	-80.71	-73.03	0.97	10.21	V
	3345	-64.58	-13	-51.58	-81.75	-72.28	1.13	10.98	V
									V
									V
									V



Highest	1697	-68.95	-13	-55.95	-80.91	-75.55	0.82	9.58	H
	2546	-66.93	-13	-53.93	-81.89	-74.05	0.98	10.25	H
	3395	-64.91	-13	-51.91	-82.21	-72.80	1.14	11.18	H
									H
									H
									H
									H
	1697	-68.63	-13	-55.63	-80.43	-75.23	0.82	9.58	V
	2546	-66.90	-13	-53.90	-81.82	-74.02	0.98	10.25	V
	3395	-64.39	-13	-51.39	-81.69	-72.28	1.14	11.18	V
									V
									V
									V
									V

Remark: Spurious emissions within 30-1000MHz were found more than 20dB below limit line.



WCDMA 850

WCDMA 850									
Channel	Frequency (MHz)	ERP (dBm)	Limit (dBm)	Margin (dB)	SPA Reading (dBm)	S.G. Power (dBm)	TX Cable loss (dB)	TX Antenna Gain (dBi)	Polarization (H/V)
Lowest	1652	-68.98	-13	-55.98	-80.74	-75.28	0.81	9.26	H
	2479	-66.61	-13	-53.61	-81.48	-73.73	0.97	10.24	H
	3305	-64.93	-13	-51.93	-82.04	-72.48	1.12	10.82	H
									H
									H
									H
									H
	1652	-69.31	-13.00	-56.31	-80.89	-75.61	0.81	9.26	V
	2479	-66.45	-13	-53.45	-81.19	-73.57	0.97	10.24	V
	3305	-64.60	-13	-51.60	-81.67	-72.15	1.12	10.82	V
									V
									V
									V
									V
Middle	1672	-68.31	-13	-55.31	-80.15	-74.75	0.82	9.40	H
	2509	-66.06	-13	-53.06	-80.94	-73.15	0.97	10.21	H
	3845	-64.79	-13	-51.79	-81.98	-72.70	1.19	11.26	H
									H
									H
									H
									H
	1672	-68.42	-13	-55.42	-80.1	-74.86	0.82	9.40	V
	2509	-65.95	-13	-52.95	-80.72	-73.04	0.97	10.21	V
	3845	-64.47	-13	-51.47	-81.64	-72.38	1.19	11.26	V
									V
									V
									V
									V



Highest	1693	-68.12	-13	-55.12	-80.07	-74.70	0.82	9.55	H
	2539	-66.19	-13	-53.19	-81.13	-73.30	0.98	10.24	H
	3386	-64.86	-13	-51.86	-82.14	-72.72	1.14	11.14	H
									H
									H
									H
									H
	1693	-67.95	-13	-54.95	-79.73	-74.53	0.82	9.55	V
	2539	-66.19	-13	-53.19	-81.08	-73.30	0.98	10.24	V
	3386	-64.43	-13	-51.43	-81.71	-72.29	1.14	11.14	V
									V
									V
									V
									V

Remark: Spurious emissions within 30-1000MHz were found more than 20dB below limit line.



<Ant. 0>

GSM 1900

GSM 1900									
Channel	Frequency (MHz)	EIRP (dBm)	Limit (dBm)	Margin (dB)	SPA Reading (dBm)	S.G. Power (dBm)	TX Cable loss (dB)	TX Antenna Gain (dBi)	Polarization (H/V)
Lowest	3700	-53.98	-13	-40.98	-73.33	-64.21	1.22	11.45	H
	5550	-54.36	-13	-41.36	-78.37	-64.92	1.44	12.00	H
	7400	-55.97	-13	-42.97	-83.6	-65.30	1.67	11.00	H
									H
									H
									H
									H
	3700	-56.93	-13	-43.93	-76.03	-67.16	1.22	11.45	V
	5550	-57.39	-13	-44.39	-81.29	-67.95	1.44	12.00	V
	7400	-56.17	-13	-43.17	-83.96	-65.50	1.67	11.00	V
									V
									V
									V
									V
Middle	3760	-53.52	-13	-40.52	-73.25	-63.68	1.20	11.36	H
	5640	-54.22	-13	-41.22	-78.26	-64.62	1.54	11.94	H
	7520	-56.49	-13	-43.49	-84.09	-66.18	1.73	11.42	H
									H
									H
									H
									H
	3760	-49.83	-13	-36.83	-69.24	-59.99	1.20	11.36	V
	5640	-54.70	-13	-41.70	-78.78	-65.10	1.54	11.94	V
	7520	-56.36	-13	-43.36	-83.94	-66.05	1.73	11.42	V
									V
									V
									V
									V



Highest	3819	-59.08	-13	-46.08	-79.16	-69.17	1.19	11.28	H
	5729	-54.39	-13	-41.39	-78.35	-64.33	1.64	11.58	H
	7639	-56.64	-13	-43.64	-84.04	-66.28	1.80	11.44	H
									H
									H
									H
									H
	3819	-59.20	-13	-46.20	-78.95	-69.29	1.19	11.28	V
	5729	-54.09	-13	-41.09	-78.32	-64.03	1.64	11.58	V
	7639	-56.43	-13	-43.43	-84.02	-66.07	1.80	11.44	V
									V
									V
									V
									V

Remark: Spurious emissions within 30-1000MHz were found more than 20dB below limit line.



WCDMA 1900

WCDMA 1900									
Channel	Frequency (MHz)	EIRP (dBm)	Limit (dBm)	Margin (dB)	SPA Reading (dBm)	S.G. Power (dBm)	TX Cable loss (dB)	TX Antenna Gain (dBi)	Polarization (H/V)
Lowest	3704	-62.18	-13	-49.18	-81.57	-72.41	1.21	11.44	H
	5557	-59.26	-13	-46.26	-83.29	-69.83	1.45	12.01	H
	7409	-56.27	-13	-43.27	-83.9	-65.63	1.67	11.04	H
									H
									H
									H
									H
	3704	-61.93	-13	-48.93	-81.06	-72.16	1.21	11.44	V
	5557	-59.42	-13	-46.42	-83.33	-69.99	1.45	12.01	V
	7409	-56.00	-13	-43.00	-83.77	-65.36	1.67	11.04	V
									V
									V
									V
									V
Middle	3760	-60.91	-13	-47.91	-80.64	-71.07	1.20	11.36	H
	5640	-58.54	-13	-45.54	-82.58	-68.94	1.54	11.94	H
	7520	-56.43	-13	-43.43	-84.03	-66.12	1.73	11.42	H
									H
									H
									H
									H
	3760	-61.43	-13	-48.43	-80.84	-71.59	1.20	11.36	V
	5640	-58.50	-13	-45.50	-82.58	-68.90	1.54	11.94	V
	7520	-56.34	-13	-43.34	-83.92	-66.03	1.73	11.42	V
									V
									V
									V
									V



Highest	3815	-60.71	-13	-47.71	-80.76	-70.80	1.19	11.29	H
	5722	-59.31	-13	-46.31	-83.28	-69.29	1.63	11.61	H
	7630	-56.65	-13	-43.65	-84.05	-66.30	1.81	11.46	H
									H
									H
									H
									H
	3815	-61.21	-13	-48.21	-80.92	-71.30	1.19	11.29	V
	5722	-58.92	-13	-45.92	-83.14	-68.90	1.63	11.61	V
	7630	-55.95	-13	-42.95	-83.55	-65.60	1.81	11.46	V
									V
									V
									V
									V

Remark: Spurious emissions within 30-1000MHz were found more than 20dB below limit line.



WCDMA 1700

WCDMA 1700									
Channel	Frequency (MHz)	EIRP (dBm)	Limit (dBm)	Margin (dB)	SPA Reading (dBm)	S.G. Power (dBm)	TX Cable loss (dB)	TX Antenna Gain (dBi)	Polarization (H/V)
Lowest	3424	-63.70	-13	-50.70	-81.87	-73.80	1.14	11.25	H
	5137	-58.84	-13	-45.84	-82.25	-68.65	1.36	11.17	H
	6849	-58.02	-13	-45.02	-84.42	-67.32	1.60	10.90	H
									H
									H
									H
									H
	3424	-63.69	-13	-50.69	-81.85	-73.79	1.14	11.25	V
	5137	-59.15	-13	-46.15	-82.38	-68.96	1.36	11.17	V
	6849	-57.14	-13	-44.14	-84.23	-66.44	1.60	10.90	V
									V
									V
									V
									V
Middle	3465	-62.99	-13	-49.99	-81.32	-73.17	1.15	11.33	H
	5197	-59.47	-13	-46.47	-83.01	-69.38	1.38	11.29	H
	6930	-57.46	-13	-44.46	-84.05	-66.90	1.62	11.06	H
									H
									H
									H
									H
	3465	-63.41	-13	-50.41	-81.71	-73.59	1.15	11.33	V
	5197	-59.50	-13	-46.50	-82.86	-69.41	1.38	11.29	V
	6930	-56.74	-13	-43.74	-83.91	-66.18	1.62	11.06	V
									V
									V
									V
									V



Highest	3505	-63.35	-13	-50.35	-81.82	-73.60	1.16	11.41	H
	5257	-59.88	-13	-46.88	-83.5	-69.91	1.38	11.41	H
	7010	-56.85	-13	-43.85	-83.61	-66.37	1.64	11.16	H
									H
									H
									H
									H
	3505	-63.47	-13	-50.47	-81.9	-73.72	1.16	11.41	V
	5257	-59.89	-13	-46.89	-83.38	-69.92	1.38	11.41	V
	7010	-56.78	-13	-43.78	-84.01	-66.30	1.64	11.16	V
									V
									V
									V
									V

Remark: Spurious emissions within 30-1000MHz were found more than 20dB below limit line.

————THE END————