



FCC RADIO TEST REPORT

FCC ID : A4RGKWS6
Equipment : Phone
Model Name : GKWS6
Applicant : Google LLC
1600 Amphitheatre Parkway,
Mountain View, California, 94043 USA
Standard : FCC Part 15 Subpart C §15.247

The product was received on Feb. 06, 2023 and testing was performed from Feb. 27, 2023 to Jun. 05, 2023. We, Sporton International Inc. EMC & Wireless Communications Laboratory, would like to declare that the tested sample has been evaluated in accordance with the test procedures and has been in compliance with the applicable technical standards.

The test results in this report apply exclusively to the tested model / sample. Without written approval from Sporton International Inc. EMC & Wireless Communications Laboratory, the test report shall not be reproduced except in full.

Louis Wu

Approved by: Louis Wu

Sporton International Inc. EMC & Wireless Communications Laboratory

No. 52, Huaya 1st Rd., Guishan Dist., Taoyuan City 333, Taiwan (R.O.C.)



Table of Contents

History of this test report.....	3
Summary of Test Result.....	4
1 General Description.....	5
1.1 Product Feature of Equipment Under Test.....	5
1.2 Product Specification of Equipment Under Test.....	6
1.3 Modification of EUT	8
1.4 Testing Location	8
1.5 Applicable Standards.....	8
2 Test Configuration of Equipment Under Test	9
2.1 Carrier Frequency Channel	9
2.2 Test Mode.....	11
2.3 Connection Diagram of Test System.....	13
2.4 Support Unit used in test configuration and system	14
2.5 EUT Operation Test Setup	14
2.6 Measurement Results Explanation Example.....	14
3 Test Result.....	15
3.1 6dB and 99% Bandwidth Measurement	15
3.2 Output Power Measurement.....	16
3.3 Power Spectral Density Measurement	17
3.4 Conducted Band Edges and Spurious Emission Measurement	18
3.5 Radiated Band Edges and Spurious Emission Measurement	19
3.6 AC Conducted Emission Measurement.....	23
3.7 Antenna Requirements.....	25
4 List of Measuring Equipment	26
5 Measurement Uncertainty	28
Appendix A. Conducted Test Results	
Appendix B. AC Conducted Emission Test Result	
Appendix C. Radiated Spurious Emission	
Appendix D. Radiated Spurious Emission Plots	
Appendix E. Duty Cycle Plots	
Appendix F. Setup Photographs	



History of this test report

Report No.	Version	Description	Issue Date
FR2D0208-01B	01	Initial issue of report	Jun. 28, 2023
FR2D0208-01B	02	Revise Section 2.2 This report is an updated version, replacing the report issued on Jun. 28, 2023.	Jun. 30, 2023



Summary of Test Result

Report Clause	Ref Std. Clause	Test Items	Result (PASS/FAIL)	Remark
3.1	15.247(a)(2)	6dB Bandwidth	Pass	-
3.1	2.1049	99% Occupied Bandwidth	Reporting only	-
3.2	15.247(b)(3) 15.247(b)(4)	Output Power	Pass	-
3.3	15.247(e)	Power Spectral Density	Pass	-
3.4	15.247(d)	Conducted Band Edges and Spurious Emission	Pass	-
3.5	15.247(d)	Radiated Band Edges and Spurious Emission	Pass	2.62 dB under the limit at 2483.60 MHz
3.6	15.207	AC Conducted Emission	Pass	14.92 dB 1.40 MHz for Quasi-Peak
3.7	15.203	Antenna Requirement	Pass	-

Conformity Assessment Condition:

1. The test results (PASS/FAIL) with all measurement uncertainty excluded are presented against the regulation limits or in accordance with the requirements stipulated by the applicant/manufacturer who shall bear all the risks of non-compliance that may potentially occur if measurement uncertainty is taken into account.
2. The measurement uncertainty please refer to each test result in the section "Measurement Uncertainty".

Disclaimer:

The product specifications of the EUT presented in the test report that may affect the test assessments are declared by the manufacturer who shall take full responsibility for the authenticity.

Reviewed by: William Chen

Report Producer: Cindy Fang



1 General Description

1.1 Product Feature of Equipment Under Test

Product Feature	
Equipment	Phone
FCC ID	A4RGKWS6
EUT supports Radios application	GSM/EGPRS/WCDMA/HSPA/LTE/5G NR/NFC/GNSS/WPT WLAN 11b/g/n HT20 WLAN 11a/n HT20/HT40 WLAN 11ac VHT20/VHT40/VHT80/VHT160 WLAN 11ax HE20/HE40/HE80/HE160 WLAN 11be EHT20/EHT40/EHT80/EHT160 Bluetooth BR/EDR/LE/HR

Remark: The above EUT's information was declared by manufacturer.

EUT Information List	
S/N	Performed Test Item
33251FDJH0005Y	RF Conducted Measurement
33131FDJH0006J	Radiated Spurious Emission
31131FDJH00032	Conducted Emission



1.2 Product Specification of Equipment Under Test

Product Specification is subject to this standard			
Tx/Rx Frequency Range	2402 MHz ~ 2480 MHz		
Number of Channels	Bluetooth – LE: 40 Bluetooth HR : 75		
Carrier Frequency of Each Channel	Bluetooth – LE : 40 Channel (37 hopping + 3 advertising channel) Bluetooth HR : 75 Channel		
Maximum Output Power to Antenna	<Ant. 3> Bluetooth -LE(1Mbps): 18.85 dBm (0.0767 W) Bluetooth -LE (2Mbps): 18.95 dBm (0.0785 W) Bluetooth HR (4Mbps): 20.50 dBm / 0.1122 W Bluetooth HR (8Mbps): 20.48 dBm / 0.1117 W <Ant. 4> Bluetooth -LE (1Mbps): 18.75 dBm (0.0750 W) Bluetooth -LE (2Mbps): 18.65 dBm (0.0733 W) Bluetooth HR (4Mbps): 20.61 dBm / 0.1151 W Bluetooth HR (8Mbps): 20.70 dBm / 0.1175 W		
Maximum Output Power to Antenna <TXBF Modes>	MIMO <Ant. 3+4> Bluetooth – LE (1Mbps): 21.96 dBm / 0.1570 W Bluetooth – LE (2Mbps): 22.02 dBm / 0.1590 W Bluetooth HR (4Mbps): 20.93 dBm / 0.1239 W Bluetooth HR (8Mbps): 20.90 dBm / 0.1230 W		
99% Occupied Bandwidth	<Ant. 3> Bluetooth HR(4Mbps): 2.414 MHz Bluetooth HR(8Mbps): 4.699 MHz <Ant. 4> Bluetooth HR(4Mbps): 2.414 MHz Bluetooth HR(8Mbps): 4.699 MHz		
99% Occupied Bandwidth <TXBF Mode>	MIMO <Ant. 3+4> Bluetooth – LE (1Mbps): 1.055 MHz Bluetooth – LE (2Mbps): 2.134 MHz MIMO <Ant. 3+4> Bluetooth HR(4Mbps): 2.414 MHz Bluetooth HR(8Mbps): 4.699 MHz		
Antenna Type / Gain	<Ant. 3> : Loop Antenna with gain -2.20 dBi <Ant. 4> : Monopole Antenna with gain -0.1 dBi		
Type of Modulation	Bluetooth - LE : GFSK Bluetooth HR: 8PSK		
Antenna Function Description		Ant. 3	Ant. 4
	Bluetooth - LE	V	V
	Bluetooth- LE TXBF	V	V
	Bluetooth HR	V	V
	Bluetooth HR TXBF	V	V

Remark:

1. MIMO Ant. 3+4 Directional Gain is a calculated result from MIMO Ant. 3 and MIMO Ant. 4. The formula used in calculation is documented in section 1.2.1.
2. Power of MIMO Ant. 3 + Ant. 4 is a calculated result from sum of the power MIMO Ant. 3 and MIMO Ant. 4.
3. The EUT's information above is declared by manufacturer. Please refer to Disclaimer in report summary.



1.2.1 Antenna Directional Gain

Follows FCC KDB 662911 D01 Multiple Transmitter Output v02r01 F)2)e)i)

Directional gain = GANT + 10 log(NANT/NSS) dBi, where NSS = the number of independent spatial lstreams of data and GANT is the antenna gain in dBi. (This formula can also be applied when antennas have different gains if the highest antenna gain is substituted for GANT.)

The directional gain “DG” is calculated as following table.

			DG for Power (dBi)	DG for PSD (dBi)	Power Limit Reduction (dB)	PSD Limit Reduction (dB)
	Ant 3 (dBi)	Ant 4 (dBi)				
Bluetooth	-2.20	-0.10	-0.10	-0.10	0.00	0.00

Calculation example:

If a device has two antenna, $G_{ANT1} = -2.20\text{dBi}$; $G_{ANT2} = -0.10\text{dBi}$
 $-0.10\text{ dBi} + 10 \times \log(2 / 2)$
 $= -0.10\text{ dBi}$

Power and PSD limit reduction = Composite gain – 6dBi, (min = 0)



1.3 Modification of EUT

No modifications made to the EUT during the testing.

1.4 Testing Location

Test Site	Sporton International Inc. EMC & Wireless Communications Laboratory
Test Site Location	No.52, Huaya 1st Rd., Guishan Dist., Taoyuan City 333, Taiwan (R.O.C.) TEL: +886-3-327-3456 FAX: +886-3-328-4978
Test Site No.	Sporton Site No. CO05-HY, 03CH07-HY

Note: The test site complies with ANSI C63.4 2014 requirement.

Test Site	Sporton International Inc. Wensan Laboratory
Test Site Location	No.58, Aly. 75, Ln. 564, Wenhua 3rd, Rd., Guishan Dist., Taoyuan City 333010, Taiwan (R.O.C.) TEL: +886-3-327-0868 FAX: +886-3-327-0855
Test Site No.	Sporton Site No. TH05-HY(TAF Code: 3786)
Remark	The Conducted Emission test item subcontracted to Sporton International Inc. Wensan Laboratory.

FCC designation No.: TW1190 and TW3786

1.5 Applicable Standards

According to the specifications declared by the manufacturer, the EUT must comply with the requirements of the following standards:

- ♦ FCC Part 15 Subpart C §15.247
- ♦ FCC KDB Publication No. 558074 D01 15.247 Meas Guidance v05r02
- ♦ FCC KDB 414788 D01 Radiated Test Site v01r01
- ♦ FCC KDB 662911 D01 Multiple Transmitter Output v02r01.
- ♦ ANSI C63.10-2013

Remark:

1. All the test items were validated and recorded in accordance with the standards without any modification during the testing.
2. The TAF code is not including all the FCC KDB listed without accreditation.



2 Test Configuration of Equipment Under Test

2.1 Carrier Frequency Channel

<Bluetooth - LE>

Frequency Band	Channel	Freq. (MHz)	Channel	Freq. (MHz)
2400-2483.5 MHz	0	2402	21	2444
	1	2404	22	2446
	2	2406	23	2448
	3	2408	24	2450
	4	2410	25	2452
	5	2412	26	2454
	6	2414	27	2456
	7	2416	28	2458
	8	2418	29	2460
	9	2420	30	2462
	10	2422	31	2464
	11	2424	32	2466
	12	2426	33	2468
	13	2428	34	2470
	14	2430	35	2472
	15	2432	36	2474
	16	2434	37	2476
	17	2436	38	2478
	18	2438	39	2480
	19	2440	-	-
20	2442	-	-	



<Bluetooth HR>

Frequency Band	Channel	Freq. (MHz)	Channel	Freq. (MHz)	Channel	Freq. (MHz)
2400-2483.5 MHz	2	2404	27	2429	52	2454
	3	2405	28	2430	53	2455
	4	2406	29	2431	54	2456
	5	2407	30	2432	55	2457
	6	2408	31	2433	56	2458
	7	2409	32	2434	57	2459
	8	2410	33	2435	58	2460
	9	2411	34	2436	59	2461
	10	2412	35	2437	60	2462
	11	2413	36	2438	61	2463
	12	2414	37	2439	62	2464
	13	2415	38	2440	63	2465
	14	2416	39	2441	64	2466
	15	2417	40	2442	65	2467
	16	2418	41	2443	66	2468
	17	2419	42	2444	67	2469
	18	2420	43	2445	68	2470
	19	2421	44	2446	69	2471
	20	2422	45	2447	70	2472
	21	2423	46	2448	71	2473
	22	2424	47	2449	72	2474
	23	2425	48	2450	73	2475
	24	2426	49	2451	74	2476
	25	2427	50	2452	75	2477
	26	2428	51	2453	76	2478



2.2 Test Mode

- a. The EUT has been associated with peripherals and configuration operated in a manner tended to maximize its emission characteristics in a typical application. Frequency range investigated: conduction emission (150 kHz to 30 MHz), radiation emission (9 kHz to the 10th harmonic of the highest fundamental frequency or to 40 GHz, whichever is lower). For radiated measurement, the measured emission level of the EUT was maximized by rotating the EUT on a turntable, adjusting the orientation of the EUT and EUT antenna in three orthogonal axis (X: flat, Y: portrait, Z: landscape), and accessory (Adapter or Earphone) and adjusting the measurement antenna orientation, following C63.10 exploratory test procedures and only the worst case emissions were reported in this report.

- b. AC power line Conducted Emission was tested under maximum output power.

- c. The BLE SISO mode conducted power is covered by MIMO mode per chain, so only the MIMO mode is chosen as main test configuration.



The following summary table is showing all test modes to demonstrate in compliance with the standard.

Summary table of Test Cases	
Test Item	Data Rate / Modulation
Conducted Test Cases	Bluetooth – LE / GFSK
	Mode 1: Bluetooth Tx CH00_2402 MHz_1Mbps
	Mode 2: Bluetooth Tx CH19_2440 MHz_1Mbps
	Mode 3: Bluetooth Tx CH39_2480 MHz_1Mbps
	Mode 4: Bluetooth Tx CH00_2402 MHz_2Mbps
	Mode 5: Bluetooth Tx CH19_2440 MHz_2Mbps
	Mode 6: Bluetooth Tx CH39_2480 MHz_2Mbps
	Mode 7: Bluetooth HR CH02_2404 MHz_4Mbps
	Mode 8: Bluetooth HR CH39_2441 MHz_4Mbps
	Mode 9: Bluetooth HR CH76_2478 MHz_4Mbps
	Mode 10: Bluetooth HR CH02_2404 MHz_8Mbps
	Mode 11: Bluetooth HR CH39_2441 MHz_8Mbps
	Mode 12: Bluetooth HR CH76_2478 MHz_8Mbps
Radiated Test Cases	Mode 1: Bluetooth Tx CH00_2402 MHz_1Mbps
	Mode 2: Bluetooth Tx CH19_2440 MHz_1Mbps
	Mode 3: Bluetooth Tx CH39_2480 MHz_1Mbps
	Mode 4: Bluetooth Tx CH00_2402 MHz_2Mbps
	Mode 5: Bluetooth Tx CH19_2440 MHz_2Mbps
	Mode 6: Bluetooth Tx CH39_2480 MHz_2Mbps
	Mode 7: Bluetooth HR CH02_2404 MHz_4Mbps
	Mode 8: Bluetooth HR CH39_2441 MHz_4Mbps
	Mode 9: Bluetooth HR CH76_2478 MHz_4Mbps
	Mode 10: Bluetooth HR CH02_2404 MHz_8Mbps
	Mode 11: Bluetooth HR CH39_2441 MHz_8Mbps
	Mode 12: Bluetooth HR CH76_2478 MHz_8Mbps
	AC Conducted Emission
Remark:	
<ol style="list-style-type: none"> For Radiated Test Cases, the tests were performed with Adapter 2, USB Cable 2. During the preliminary test, both charging modes (Adapter mode and WPT Charging mode) were verified. It is determined that the adaptor mode is the worst case for official test. For radiation spurious emission, the modulation and the data rate picked for testing are determined by the Max. RF conducted power. 	

2.3 Connection Diagram of Test System

<AC Conducted Emission Mode>

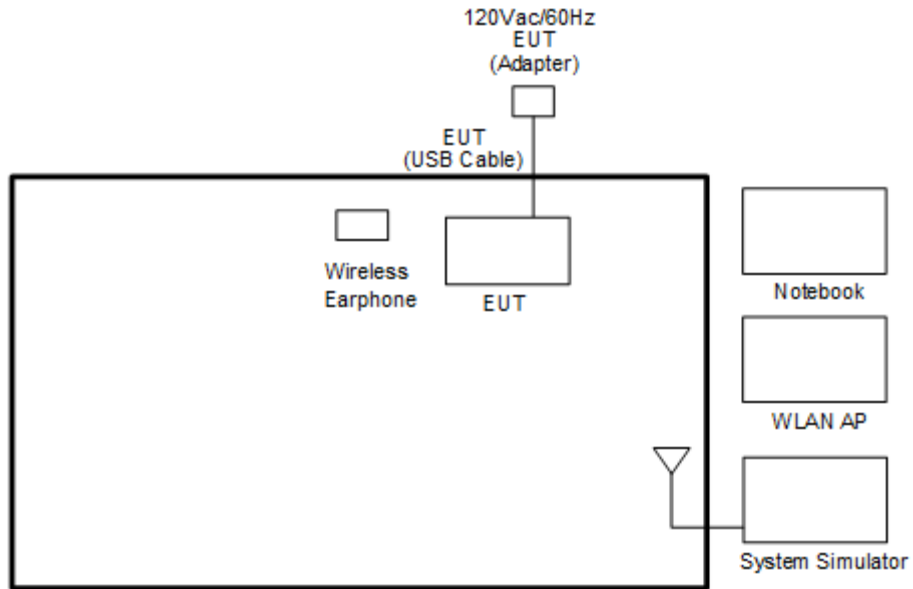

<Bluetooth Tx Mode>

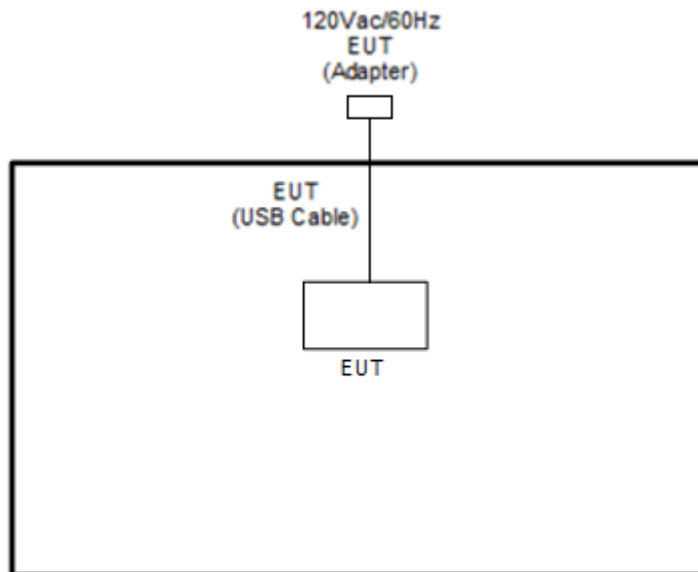

2.4 Support Unit used in test configuration and system

Item	Equipment	Brand Name	Model Name	FCC ID	Data Cable	Power Cord
1.	System Simulator	Anritsu	MT8820C	N/A	N/A	Unshielded, 1.8m
2.	WLAN AP	ASUS	RT-AC66U	MSQ-RTAC66U	N/A	Unshielded, 1.8m
3.	Notebook	DELL	Latitude3420	FCC DoC	N/A	AC I/P: Unshielded, 1.2 m DC O/P: Shielded, 1.8 m
4.	Bluetooth Earphone	Google	G1007/G1008	A4RG1007/ A4RG1008	N/A	N/A

2.5 EUT Operation Test Setup

The RF test items, utility “cmd 10.0.19042.1526” was installed in Notebook which was programmed in order to make the EUT get into the engineering modes to provide channel selection, power level, data rate and the application type and for continuous transmitting signals.

2.6 Measurement Results Explanation Example

For all conducted test items:

The offset level is set in the spectrum analyzer to compensate the RF cable loss and attenuator factor between EUT conducted output port and spectrum analyzer. With the offset compensation, the spectrum analyzer reading level is exactly the EUT RF output level.

Example :

The spectrum analyzer offset is derived from RF cable loss and attenuator factor.

Offset = RF cable loss + attenuator factor.

Following shows an offset computation example with cable loss 4.2 dB and 10 dB attenuator.

$$\begin{aligned}
 \text{Offset(dB)} &= \text{RF cable loss(dB)} + \text{attenuator factor(dB)}. \\
 &= 4.2 + 10 = 14.2 \text{ (dB)}
 \end{aligned}$$

3 Test Result

3.1 6dB and 99% Bandwidth Measurement

3.1.1 Limit of 6dB and 99% Bandwidth

The minimum 6 dB bandwidth shall be at least 500 kHz.

3.1.2 Measuring Instruments

Please refer to the measuring equipment list in this test report.

3.1.3 Test Procedures

1. The testing follows the ANSI C63.10 Section 6.9.3 (OBW) and 11.8.1 (6dB BW).
2. The RF output of EUT is connected to the spectrum analyzer by RF cable and attenuator. The path loss is compensated to the results for each measurement.
3. Set the maximum power setting and enable the EUT to transmit continuously.
4. Make the measurement with the spectrum analyzer's resolution bandwidth (RBW) = 100 kHz. Set the Video bandwidth (VBW) = 300 kHz. In order to make an accurate measurement. The 6dB bandwidth must be greater than 500 kHz.
5. For 99% Bandwidth Measurement, the spectrum analyzer's resolution bandwidth (RBW) is set 1-5% of the emission bandwidth and set the Video bandwidth (VBW) $\geq 3 * RBW$.
6. Measure and record the results in the test report.

3.1.4 Test Setup



3.1.5 Test Result of 6dB Bandwidth

Please refer to Appendix A.

3.1.6 Test Result of 99% Occupied Bandwidth

3.2 Output Power Measurement

3.2.1 Limit of Output Power

For systems using digital modulation in the 2400-2483.5 MHz, the limit for output power is 30 dBm. If transmitting antenna of directional gain greater than 6 dBi is used, the peak output power from the intentional radiator shall be reduced below the above stated value by the amount in dB that the directional gain of the antenna exceeds 6 dBi. In case of point-to-point operation, the limit has to be reduced by 1 dB for every 3 dB that the directional gain of the antenna exceeds 6 dBi.

3.2.2 Measuring Instruments

Please refer to the measuring equipment list in this test report.

3.2.3 Test Procedures

1. For BT HR modes, the testing follows ANSI C63.10 Section 11.9.1.3 PKPM1 Peak power meter method.
2. For BLE modes Average Power, the testing follows ANSI C63.10 Section 11.9.2.3.2 Method AVGPM-G
3. The RF output of EUT is connected to the power meter by RF cable and attenuator.
4. The path loss is compensated to the results for each measurement.
5. Set the maximum power setting and enable the EUT to transmit continuously.
6. Measure the conducted output power and record the results in the test report.

3.2.4 Test Setup

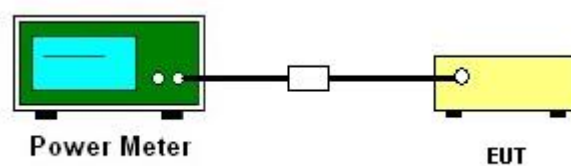

3.2.5 Test Result of Peak Output Power

Please refer to Appendix A.

3.2.6 Test Result of Average Output Power

Please refer to Appendix A.

3.3 Power Spectral Density Measurement

3.3.1 Limit of Power Spectral Density

The peak power spectral density shall not be greater than 8 dBm in any 3 kHz band at any time interval of continuous transmission.

3.3.2 Measuring Instruments

Please refer to the measuring equipment list in this test report.

3.3.3 Test Procedures

1. The testing follows the ANSI C63.10 Section 11.10.2 Method PKPSD.
2. The RF output of EUT is connected to the spectrum analyzer by RF cable and attenuator. The path loss is compensated to the results for each measurement.
3. Set the maximum power setting and enable the EUT to transmit continuously.
4. Make the measurement with the spectrum analyzer's resolution bandwidth (RBW) = 3 kHz. Video bandwidth (VBW) = 10 kHz. In order to make an accurate measurement, set the span to 1.5 times DTS Channel Bandwidth. (6 dB BW)
5. Detector = peak, Sweep time = auto couple, Trace mode = max hold, Allow trace to fully stabilize. Use the peak marker function to determine the maximum power level.
6. Measure and record the results in the test report.
7. The Measured power density (dBm)/ 100 kHz is a reference level and is used as 20 dBc down limit line for Conducted Band Edges and Conducted Spurious Emission.

3.3.4 Test Setup

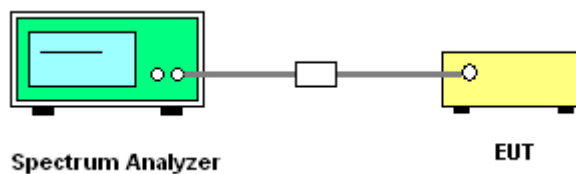

3.3.5 Test Result of Power Spectral Density

Please refer to Appendix A.

3.4 Conducted Band Edges and Spurious Emission Measurement

3.4.1 Limit of Conducted Band Edges and Spurious Emission

In any 100 kHz bandwidth outside of the authorized frequency band, the emissions which fall in the non-restricted bands shall be attenuated at least 20 dB / 30dB relative to the maximum PSD level in 100 kHz by RF conducted measurement.

3.4.2 Measuring Instruments

Please refer to the measuring equipment list in this test report.

3.4.3 Test Procedure

1. The testing follows the ANSI C63.10 Section 11.11.3 Emission level measurement.
2. The RF output of EUT is connected to the spectrum analyzer by RF cable and attenuator. The path loss is compensated to the results for each measurement.
3. Set the maximum power setting and enable the EUT to transmit continuously.
4. Set RBW = 100 kHz, VBW = 300 kHz, Peak Detector. Unwanted Emissions measured in any 100 kHz bandwidth outside of the authorized frequency band shall be attenuated by at least 20 dB relative to the maximum in-band peak PSD level in 100 kHz when maximum peak conducted output power procedure is used. If the transmitter complies with the conducted power limits based on the use of RMS averaging over a time interval, the attenuation required under this paragraph shall be 30 dB instead of 20 dB.
5. Measure and record the results in the test report.
6. The RF fundamental frequency should be excluded against the limit line in the operating frequency band.

3.4.4 Test Setup



3.4.5 Test Result of Conducted Band Edges Plots

Please refer to Appendix A.

3.4.6 Test Result of Conducted Spurious Emission Plots

Please refer to Appendix A.



3.5 Radiated Band Edges and Spurious Emission Measurement

3.5.1 Limit of Radiated Band Edges and Spurious Emission

In any 100 kHz bandwidth outside the intentional radiator frequency band, all harmonics/spurious must be at least 20 dB below the highest emission level within the authorized band. If the output power of this device is measured by spectrum analyzer, the attenuation under this paragraph shall be 30 dB instead of 20 dB. In addition, radiated emissions which fall in the restricted bands must also comply with the limits as below.

Frequency (MHz)	Field Strength (microvolts/meter)	Measurement Distance (meters)
0.009 – 0.490	2400/F(kHz)	300
0.490 – 1.705	24000/F(kHz)	30
1.705 – 30.0	30	30
30 – 88	100	3
88 – 216	150	3
216 - 960	200	3
Above 960	500	3

3.5.2 Measuring Instruments

Please refer to the measuring equipment list in this test report.



3.5.3 Test Procedures

1. The testing follows the ANSI C63.10 Section 11.12.1 Radiated emission measurements.
2. The EUT is arranged to its worst case and then tune the antenna tower (from 1 m to 4 m) and turntable (from 0 degree to 360 degrees) to find the maximum reading. A pre-amp and a high pass filter are used for the test in order to get better signal level.
3. The EUT is placed on a turntable with 0.8 meter for frequency below 1 GHz and 1.5 meter for frequency above 1 GHz respectively above ground.
4. The EUT is set 3 meters away from the receiving antenna, which is mounted on the top of a variable height antenna tower.
5. Corrected Reading: Antenna Factor + Cable Loss + Read Level - Preamp Factor = Level
6. Radiated testing below 1 GHz is performed by adjusting the antenna tower from 1 m to 4 m and by rotating the turn table from 0 degree to 360 degrees to find the peak maximum hold reading. When there is no suspected emission found and the emission level is with at least 6 dB margin against QP limit line, the position is marked as “-“.
7. Radiated testing above 1 GHz is performed by adjusting the antenna tower from 1 m to 4 m and by rotating the turn table from 0 degree to 360 degrees to find the peak maximum hold reading for scanning all frequencies. When there is no suspected emission found and the harmonic emission level is with at least 6 dB margin against average limit line, the position is marked as “-“.
8. Use the following spectrum analyzer settings:
 - (1) Span shall wide enough to fully capture the emission being measured;
 - (2) Set RBW = 100 kHz for $f < 1$ GHz; VBW \geq RBW; Sweep = auto; Detector function = peak; Trace = max hold;
 - (3) Set RBW = 1 MHz, VBW = 3 MHz for $f \geq 1$ GHz for peak measurement.
For average measurement:
 - VBW = 10 Hz, when duty cycle is no less than 98 percent.
 - VBW $\geq 1/T$, when duty cycle is less than 98 percent where T is the minimum transmission duration over which the transmitter is on and is transmitting at its maximum power control level for the tested mode of operation.

3.5.4 Test Setup

For radiated test below 30MHz

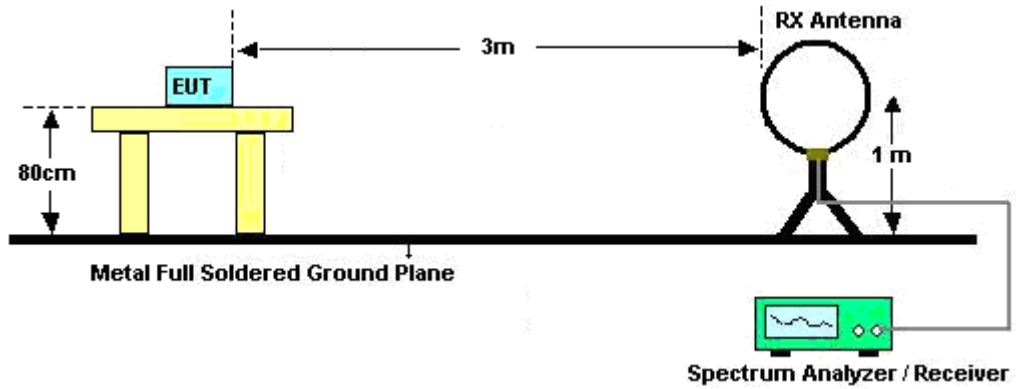

For radiated test from 30MHz to 1GHz

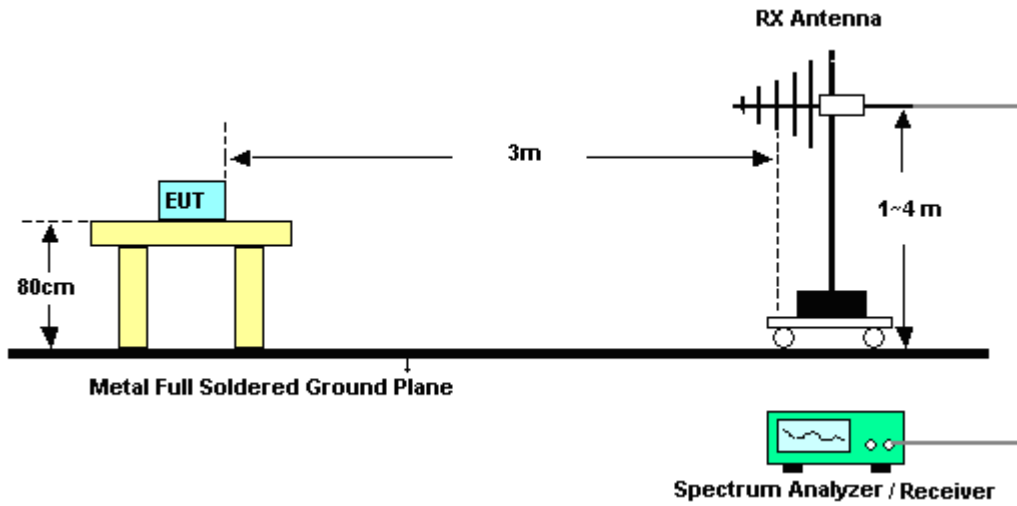

For radiated test from 1GHz to 18GHz

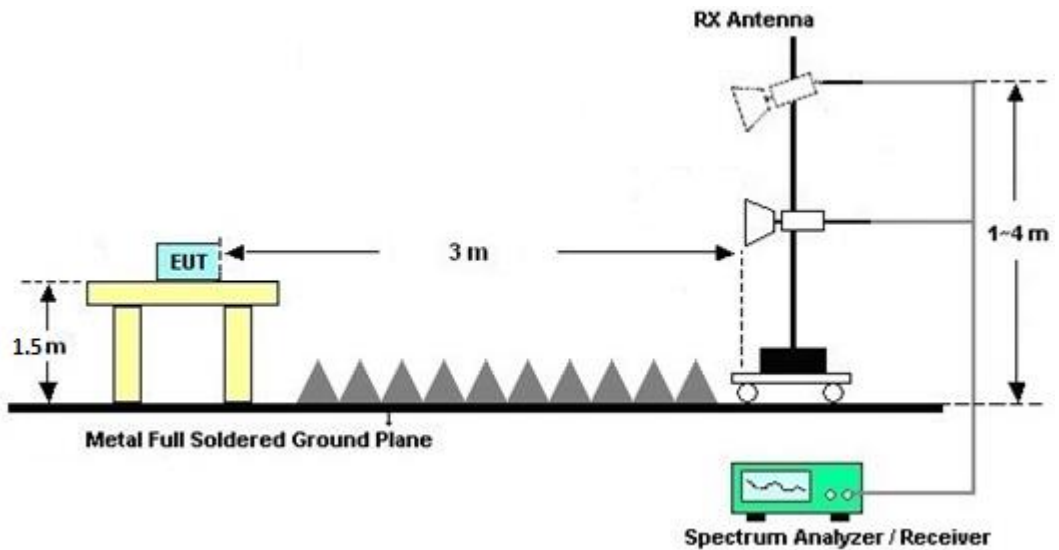

For radiated test above 18GHz

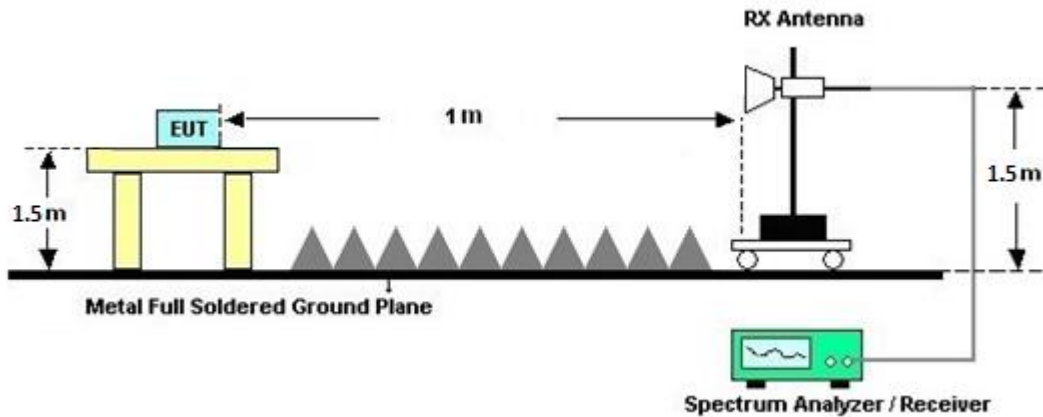

3.5.5 Test Results of Radiated Spurious Emissions (9 kHz ~ 30 MHz)

The low frequency, which starts from 9 kHz to 30 MHz, is pre-scanned and the result which is 20 dB lower than the limit line is not reported.

There is adequate comparison measurement of both open-field test site and alternative test site - semi-Anechoic chamber according to 414788 D01 Radiated Test Site v01r01, and the result comes out very similar.

3.5.6 Test Result of Radiated Spurious at Band Edges

Please refer to Appendix C and D.

3.5.7 Duty Cycle

Please refer to Appendix E.

3.5.8 Test Result of Radiated Spurious Emission (30 MHz ~ 10th Harmonic)

Please refer to Appendix C and D.



3.6 AC Conducted Emission Measurement

3.6.1 Limit of AC Conducted Emission

For equipment that is designed to be connected to the public utility (AC) power line, the radio frequency voltage that is conducted back onto the AC power line on any frequency or frequencies within the band 150 kHz to 30 MHz shall not exceed the limits in the following table.

Frequency of emission (MHz)	Conducted limit (dB μ V)	
	Quasi-peak	Average
0.15-0.5	66 to 56*	56 to 46*
0.5-5	56	46
5-30	60	50

*Decreases with the logarithm of the frequency.

3.6.2 Measuring Instruments

Please refer to the measuring equipment list in this test report.

3.6.3 Test Procedures

1. The EUT is placed 0.4 meter away from the conducting wall of the shielding room, and is kept at least 80 centimeters from any other grounded conducting surface.
2. Connect EUT to the power mains through a line impedance stabilization network (LISN).
3. All the support units are connecting to the other LISN.
4. The LISN provides 50 ohm coupling impedance for the measuring instrument.
5. The FCC states that a 50 ohm, 50 microhenry LISN shall be used.
6. Both Line and Neutral shall be tested in order to find out the maximum conducted emission.
7. The frequency range from 150 kHz to 30 MHz is scanned.
8. Set the test-receiver system to Peak Detect Function and specified bandwidth (IF Bandwidth = 9 kHz) with Maximum Hold Mode. Then measurement is also conducted by Average Detector and Quasi-Peak Detector Function respectively.

3.6.4 Test Setup



3.6.5 Test Result of AC Conducted Emission

Please refer to Appendix B.



3.7 Antenna Requirements

3.7.1 Standard Applicable

The use of a permanently attached antenna or of an antenna that uses a unique coupling to the intentional radiator shall be considered sufficient to comply with the rule.

3.7.2 Antenna Anti-Replacement Construction

An embedded-in antenna design is used.



4 List of Measuring Equipment

Instrument	Brand Name	Model No.	Serial No.	Characteristics	Calibration Date	Test Date	Due Date	Remark
Bilog Antenna	TESEQ	CBL 6111D & 00800N1D01N-06	35419 & 03	30MHz~1GHz	Apr. 24, 2022	Apr. 10, 2023 ~ Apr. 22, 2023	Apr. 23, 2023	Radiation (03CH07-HY)
Bilog Antenna	TESEQ	CBL 6111D & 00800N1D01N-06	35419 & 03	30MHz~1GHz	Apr. 23, 2023	Apr. 23, 2023 ~ Jun. 05, 2023	Apr. 22, 2024	Radiation (03CH07-HY)
Double Ridge Horn Antenna	ESCO	3117	00075962	1GHz ~ 18GHz	Dec. 01, 2022	Apr. 10, 2023 ~ Jun. 05, 2023	Nov. 30, 2023	Radiation (03CH07-HY)
Loop Antenna	Rohde & Schwarz	HFH2-Z2	100315	9 kHz~30 MHz	Feb. 28, 2023	Apr. 10, 2023 ~ Jun. 05, 2023	Feb. 27, 2024	Radiation (03CH07-HY)
Preamplifier	MITEQ	AMF-7D-0010 1800-30-10P	1590075	1GHz~18GHz	Apr. 21, 2022	Apr. 10, 2023 ~ Apr. 19, 2023	Apr. 20, 2023	Radiation (03CH07-HY)
Preamplifier	MITEQ	AMF-7D-0010 1800-30-10P	1590075	1GHz~18GHz	Apr. 20, 2023	Apr. 20, 2023 ~ Jun. 05, 2023	Apr. 19, 2024	Radiation (03CH07-HY)
Preamplifier	COM-POWER	PA-103A	161241	10MHz~1GHz	Oct. 03, 2022	Apr. 10, 2023 ~ Jun. 05, 2023	Oct. 02, 2023	Radiation (03CH07-HY)
Preamplifier	Agilent	8449B	3008A02362	1GHz~26.5GHz	Mar. 24, 2023	Apr. 10, 2023 ~ Jun. 05, 2023	Mar. 23, 2024	Radiation (03CH07-HY)
Preamplifier	EMEC	EM18G40G	0600789	18-40GHz	Jul. 21, 2022	Apr. 10, 2023 ~ Jun. 05, 2023	Jul. 20, 2023	Radiation (03CH07-HY)
Spectrum Analyzer	Keysight	Keysight	MY60241058	10Hz~44GHz	Jul. 07, 2022	Apr. 10, 2023 ~ Jun. 05, 2023	Jul. 06, 2023	Radiation (03CH07-HY)
RF Cable	HUBER + SUHNER	SUCOFLEX 104	MY15682/4	30MHz to 18GHz	Feb. 22, 2023	Apr. 10, 2023 ~ Jun. 05, 2023	Feb. 21, 2024	Radiation (03CH07-HY)
RF Cable	HUBER + SUHNER	SUCOFLEX 104	MY24971/4	9kHz to 18GHz	Feb. 22, 2023	Apr. 10, 2023 ~ Jun. 05, 2023	Feb. 21, 2024	Radiation (03CH07-HY)
RF Cable	HUBER + SUHNER	SUCOFLEX 104	MY28655/4	9kHz to 18GHz	Feb. 22, 2023	Apr. 10, 2023 ~ Jun. 05, 2023	Feb. 21, 2024	Radiation (03CH07-HY)
RF Cable	HUBER + SUHNER	SUCOFLEX 126	532078/126E	30MHz~18GHz	Sep. 16, 2022	Apr. 10, 2023 ~ Jun. 05, 2023	Sep. 15, 2023	Radiation (03CH07-HY)
RF Cable	HUBER + SUHNER	SUCOFLEX 102	MY2858/2	18GHz~40GHz	Feb. 22, 2023	Apr. 10, 2023 ~ Jun. 05, 2023	Feb. 21, 2024	Radiation (03CH07-HY)
Controller	EMEC	EM1000	N/A	Control Ant Mast	N/A	Apr. 10, 2023 ~ Jun. 05, 2023	N/A	Radiation (03CH07-HY)
Controller	MF	MF-7802	N/A	Control Turn table	N/A	Apr. 10, 2023 ~ Jun. 05, 2023	N/A	Radiation (03CH07-HY)
Antenna Mast	EMEC	AM-BS-4500E	N/A	Boresight mast 1M~4M	N/A	Apr. 10, 2023 ~ Jun. 05, 2023	N/A	Radiation (03CH07-HY)
Turn Table	ChainTek	Chaintek 3000	N/A	0~360 Degree	N/A	Apr. 10, 2023 ~ Jun. 05, 2023	N/A	Radiation (03CH07-HY)
Software	Audix	E3	N/A	N/A	N/A	Apr. 10, 2023 ~ Jun. 05, 2023	N/A	Radiation (03CH07-HY)
USB Data Logger	TECPEL	TR-32	HE17XB2495	N/A	Mar. 14, 2023	Apr. 10, 2023 ~ Jun. 05, 2023	Mar. 13, 2024	Radiation (03CH07-HY)
EMI Test Receiver	Rohde & Schwarz	ESU26	100472	20Hz~26.5GHz	Feb. 13, 2023	Apr. 10, 2023 ~ Jun. 05, 2023	Feb. 12, 2024	Radiation (03CH07-HY)



Instrument	Brand Name	Model No.	Serial No.	Characteristics	Calibration Date	Test Date	Due Date	Remark
SHF-EHF Horn Antenna	SCHWARZBECK	BBHA 9170	BBHA9170251	18GHz~40GHz	Nov. 24, 2022	Apr. 10, 2023 ~ Jun. 05, 2023	Nov. 23, 2023	Radiation (03CH07-HY)
AC Power Source	ChainTek	APC-1000W	N/A	N/A	N/A	May 17, 2023	N/A	Conduction (CO05-HY)
EMI Test Receiver	Rohde & Schwarz	ESR3	102388	9kHz~3.6GHz	Dec. 01, 2022	May 17, 2023	Nov. 30, 2023	Conduction (CO05-HY)
Hygrometer	Testo	608-H1	34913912	N/A	Nov. 17, 2022	May 17, 2023	Nov. 16, 2023	Conduction (CO05-HY)
LISN	Rohde & Schwarz	ENV216	100081	9kHz~30MHz	Nov. 17, 2022	May 17, 2023	Nov. 16, 2023	Conduction (CO05-HY)
Software	Rohde & Schwarz	EMC32	N/A	N/A	N/A	May 17, 2023	N/A	Conduction (CO05-HY)
Pulse Limiter	SCHWARZBECK	VTSD 9561-FN	00691	N/A	Aug. 01, 2022	May 17, 2023	Jul. 31, 2023	Conduction (CO05-HY)
LISN Cable	MVE	RG-400	260260	N/A	Dec. 29, 2022	May 17, 2023	Dec. 28, 2023	Conduction (CO05-HY)
Hygrometer	TECPEL	DTM-303A	TP201996	N/A	Nov. 17, 2022	Feb. 27, 2023~ May 25, 2023	Nov. 16, 2023	Conducted (TH05-HY)
Power Meter	Anritsu	ML2495A	1036004	N/A	Aug. 08, 2022	Feb. 27, 2023~ May 23, 2023	Aug. 07, 2023	Conducted (TH05-HY)
Power Sensor	Anritsu	MA2411B	1027253	300MHz~40GHz	Aug. 08, 2022	Feb. 27, 2023~ May 23, 2023	Aug. 07, 2023	Conducted (TH05-HY)
Signal Analyzer	Rohde & Schwarz	FSV40	101905	10Hz - 40GHz	Aug. 03, 2022	Feb. 27, 2023~ May 25, 2023	Aug. 02, 2023	Conducted (TH05-HY)
Power Sensor	DARE	RPR3006W	16I00054SNO12 (NO:113)	10MHz~6GHz	Dec. 13, 2022	Feb. 28, 2023~ May 25, 2023	Dec. 12, 2023	Conducted (TH05-HY)



5 Measurement Uncertainty

Uncertainty of Conducted Emission Measurement (150 kHz ~ 30 MHz)

Measuring Uncertainty for a Level of Confidence of 95% ($U = 2Uc(y)$)	3.50 dB
---	---------

Uncertainty of Radiated Emission Measurement (30 MHz ~ 1000 MHz)

Measuring Uncertainty for a Level of Confidence of 95% ($U = 2Uc(y)$)	6.50 dB
---	---------

Uncertainty of Radiated Emission Measurement (1000 MHz ~ 6000 MHz)

Measuring Uncertainty for a Level of Confidence of 95% ($U = 2Uc(y)$)	4.50 dB
---	---------

Uncertainty of Radiated Emission Measurement (6000 MHz ~ 18000 MHz)

Measuring Uncertainty for a Level of Confidence of 95% ($U = 2Uc(y)$)	4.20 dB
---	---------

Uncertainty of Radiated Emission Measurement (18000 MHz ~ 40000 MHz)

Measuring Uncertainty for a Level of Confidence of 95% ($U = 2Uc(y)$)	5.30 dB
---	---------

Appendix A. Test Result of Conducted Test Items

Test Engineer:	Junyu Jhou	Temperature:	21~25	°C
Test Date:	2023/3/10	Relative Humidity:	51~54	%

<BLE Ant. 3>

<u>TEST RESULTS DATA</u>										
<u>Average Power Table</u>										
Mod.	Data Rate	NTX	CH.	Freq. (MHz)	Average Conducted Power (dBm)	Conducted Power Limit (dBm)	DG (dBi)	EIRP Power (dBm)	EIRP Power Limit (dBm)	Pass /Fail
BLE	1Mbps	1	0	2402	18.85	30.00	-2.20	16.65	36.00	Pass
BLE	1Mbps	1	19	2440	18.15	30.00	-2.20	15.95	36.00	Pass
BLE	1Mbps	1	39	2480	18.05	30.00	-2.20	15.85	36.00	Pass

TEST RESULTS DATA
Average Power Table

Mod.	Data Rate	N _{Tx}	CH.	Freq. (MHz)	Average Conducted Power (dBm)	Conducted Power Limit (dBm)	DG (dBi)	EIRP Power (dBm)	EIRP Power Limit (dBm)	Pass /Fail
BLE	2Mbps	1	0	2402	18.95	30.00	-2.20	16.75	36.00	Pass
BLE	2Mbps	1	19	2440	18.55	30.00	-2.20	16.35	36.00	Pass
BLE	2Mbps	1	39	2480	17.75	30.00	-2.20	15.55	36.00	Pass

<BLE Ant. 4>

TEST RESULTS DATA
Average Power Table

Mod.	Data Rate	N _{TX}	CH.	Freq. (MHz)	Average Conducted Power (dBm)	Conducted Power Limit (dBm)	DG (dBi)	EIRP Power (dBm)	EIRP Power Limit (dBm)	Pass /Fail
BLE	1Mbps	1	0	2402	18.75	30.00	-0.10	18.65	36.00	Pass
BLE	1Mbps	1	19	2440	18.35	30.00	-0.10	18.25	36.00	Pass
BLE	1Mbps	1	39	2480	17.65	30.00	-0.10	17.55	36.00	Pass

TEST RESULTS DATA
Average Power Table

Mod.	Data Rate	N _{Tx}	CH.	Freq. (MHz)	Average Conducted Power (dBm)	Conducted Power Limit (dBm)	DG (dBi)	EIRP Power (dBm)	EIRP Power Limit (dBm)	Pass /Fail
BLE	2Mbps	1	0	2402	18.55	30.00	-0.10	18.45	36.00	Pass
BLE	2Mbps	1	19	2440	18.65	30.00	-0.10	18.55	36.00	Pass
BLE	2Mbps	1	39	2480	17.45	30.00	-0.10	17.35	36.00	Pass

<HR 4Mbps 8Mbps Ant. 3>

TEST RESULTS DATA								
<u>6dB and 99% Occupied Bandwidth</u>								
Mod.	Data Rate	NTx	CH.	Freq. (MHz)	99% Occupied BW (MHz)	6dB BW (MHz)	6dB BW Limit (MHz)	Pass/Fail
BT	4Mbps	1	2	2404	2.406	1.656	0.50	Pass
BT	4Mbps	1	39	2441	2.406	1.664	0.50	Pass
BT	4Mbps	1	76	2478	2.414	1.664	0.50	Pass

TEST RESULTS DATA										
<u>Peak Power Table</u>										
Mod.	Data Rate	NTx	CH.	Freq. (MHz)	Peak Conducted Power (dBm)	Conducted Power Limit (dBm)	DG (dBi)	EIRP Power (dBm)	EIRP Power Limit (dBm)	Pass /Fail
BT	4Mbps	1	2	2404	20.50	30.00	-2.20	18.30	36.00	Pass
BT	4Mbps	1	39	2441	19.97	30.00	-2.20	17.77	36.00	Pass
BT	4Mbps	1	76	2478	20.23	30.00	-2.20	18.03	36.00	Pass

TEST RESULTS DATA									
<u>Peak Power Density</u>									
Mod.	Data Rate	NTx	CH.	Freq. (MHz)	Peak PSD (dBm /100kHz)	Peak PSD (dBm /3kHz)	DG (dBi)	Peak PSD Limit (dBm /3kHz)	Pass/Fail
BT	4Mbps	1	2	2404	16.60	0.86	-2.20	8.00	Pass
BT	4Mbps	1	39	2441	16.14	0.43	-2.20	8.00	Pass
BT	4Mbps	1	76	2478	16.41	0.64	-2.20	8.00	Pass

Note: PSD (dBm/ 100kHz) is a reference level used for Conducted Band Edges and Conducted Spurious Emission 30dBc limit.

TEST RESULTS DATA
6dB and 99% Occupied Bandwidth

Mod.	Data Rate	NTx	CH.	Freq. (MHz)	99% Occupied BW (MHz)	6dB BW (MHz)	6dB BW Limit (MHz)	Pass/Fail
BT	8Mbps	1	2	2404	4.683	0.664	0.50	Pass
BT	8Mbps	1	39	2441	4.699	0.664	0.50	Pass
BT	8Mbps	1	76	2478	4.699	0.660	0.50	Pass

TEST RESULTS DATA
Peak Power Table

Mod.	Data Rate	NTx	CH.	Freq. (MHz)	Peak Conducted Power (dBm)	Conducted Power Limit (dBm)	DG (dBi)	EIRP Power (dBm)	EIRP Power Limit (dBm)	Pass /Fail
BT	8Mbps	1	2	2404	20.48	30.00	-2.20	18.28	36.00	Pass
BT	8Mbps	1	39	2441	20.09	30.00	-2.20	17.89	36.00	Pass
BT	8Mbps	1	76	2478	20.34	30.00	-2.20	18.14	36.00	Pass

TEST RESULTS DATA
Peak Power Density

Mod.	Data Rate	NTx	CH.	Freq. (MHz)	Peak PSD (dBm /100kHz)	Peak PSD (dBm /3kHz)	DG (dBi)	Peak PSD Limit (dBm /3kHz)	Pass/Fail
BT	8Mbps	1	2	2404	16.62	1.85	-2.20	8.00	Pass
BT	8Mbps	1	39	2441	16.14	1.42	-2.20	8.00	Pass
BT	8Mbps	1	76	2478	16.59	1.85	-2.20	8.00	Pass

Note: PSD (dBm/ 100kHz) is a reference level used for Conducted Band Edges and Conducted Spurious Emission 30dBc limit.

<HR 4Mbps 8Mbps Ant. 4>

TEST RESULTS DATA								
<u>6dB and 99% Occupied Bandwidth</u>								
Mod.	Data Rate	NTx	CH.	Freq. (MHz)	99% Occupied BW (MHz)	6dB BW (MHz)	6dB BW Limit (MHz)	Pass/Fail
BT	4Mbps	1	2	2404	2.406	1.612	0.50	Pass
BT	4Mbps	1	39	2441	2.406	1.660	0.50	Pass
BT	4Mbps	1	76	2478	2.414	1.664	0.50	Pass

TEST RESULTS DATA										
<u>Peak Power Table</u>										
Mod.	Data Rate	NTx	CH.	Freq. (MHz)	Peak Conducted Power (dBm)	Conducted Power Limit (dBm)	DG (dBi)	EIRP Power (dBm)	EIRP Power Limit (dBm)	Pass /Fail
BT	4Mbps	1	2	2404	20.61	30.00	-0.10	20.51	36.00	Pass
BT	4Mbps	1	39	2441	19.99	30.00	-0.10	19.89	36.00	Pass
BT	4Mbps	1	76	2478	19.66	30.00	-0.10	19.56	36.00	Pass

TEST RESULTS DATA									
<u>Peak Power Density</u>									
Mod.	Data Rate	NTx	CH.	Freq. (MHz)	Peak PSD (dBm /100kHz)	Peak PSD (dBm /3kHz)	DG (dBi)	Peak PSD Limit (dBm /3kHz)	Pass/Fail
BT	4Mbps	1	2	2404	16.89	1.16	-0.10	8.00	Pass
BT	4Mbps	1	39	2441	16.49	0.74	-0.10	8.00	Pass
BT	4Mbps	1	76	2478	16.10	0.21	-0.10	8.00	Pass

Note: PSD (dBm/ 100kHz) is a reference level used for Conducted Band Edges and Conducted Spurious Emission 30dBc limit.

TEST RESULTS DATA
6dB and 99% Occupied Bandwidth

Mod.	Data Rate	NTX	CH.	Freq. (MHz)	99% Occupied BW (MHz)	6dB BW (MHz)	6dB BW Limit (MHz)	Pass/Fail
BT	8Mbps	1	2	2404	4.683	0.660	0.50	Pass
BT	8Mbps	1	39	2441	4.699	0.680	0.50	Pass
BT	8Mbps	1	76	2478	4.699	0.700	0.50	Pass

TEST RESULTS DATA
Peak Power Table

Mod.	Data Rate	NTX	CH.	Freq. (MHz)	Peak Conducted Power (dBm)	Conducted Power Limit (dBm)	DG (dBi)	EIRP Power (dBm)	EIRP Power Limit (dBm)	Pass /Fail
BT	8Mbps	1	2	2404	20.70	30.00	-0.10	20.60	36.00	Pass
BT	8Mbps	1	39	2441	19.94	30.00	-0.10	19.84	36.00	Pass
BT	8Mbps	1	76	2478	19.59	30.00	-0.10	19.49	36.00	Pass

TEST RESULTS DATA
Peak Power Density

Mod.	Data Rate	NTX	CH.	Freq. (MHz)	Peak PSD (dBm /100kHz)	Peak PSD (dBm /3kHz)	DG (dBi)	Peak PSD Limit (dBm /3kHz)	Pass/Fail
BT	8Mbps	1	2	2404	16.99	2.21	-0.10	8.00	Pass
BT	8Mbps	1	39	2441	16.31	1.45	-0.10	8.00	Pass
BT	8Mbps	1	76	2478	15.92	1.10	-0.10	8.00	Pass

Note: PSD (dBm/ 100kHz) is a reference level used for Conducted Band Edges and Conducted Spurious Emission 30dBc limit.

TEST RESULTS DATA
6dB and 99% Occupied Bandwidth

Mod.	Data Rate	NTX	CH.	Freq. (MHz)	99% Occupied BW (MHz)	6dB BW (MHz)	6dB BW Limit (MHz)	Pass/Fail
BLE	1Mbps	2	0	2402	1.055	0.720	0.50	Pass
BLE	1Mbps	2	19	2440	1.051	0.724	0.50	Pass
BLE	1Mbps	2	39	2480	1.053	0.726	0.50	Pass

TEST RESULTS DATA
Average Power Table

Mod.	Data Rate	NTX	CH.	Freq. (MHz)	Average Conducted Power Ant 4 (dBm)	Average Conducted Power Ant 3 (dBm)	Total Conducted Power (dBm)	Conducted Power Limit (dBm)	DG (dBi)	Total EIRP Power (dBm)	EIRP Power Limit (dBm)	Pass /Fail
BLE	1Mbps	2	0	2402	18.85	19.05	21.96	30.00	-0.10	21.86	36.00	Pass
BLE	1Mbps	2	19	2440	18.55	18.25	21.41	30.00	-0.10	21.31	36.00	Pass
BLE	1Mbps	2	39	2480	17.75	18.35	21.07	30.00	-0.10	20.97	36.00	Pass

TEST RESULTS DATA
Peak Power Density

Mod.	Data Rate	NTX	CH.	Freq. (MHz)	Peak PSD (dBm /100kHz)	Peak PSD (dBm /3kHz)	Peak PSD Worst +3.01 (dBm /3kHz)	DG (dBi)	Peak PSD Limit (dBm /3kHz)	Pass/Fail
BLE	1Mbps	2	0	2402	17.54	2.64	5.65	-0.10	8.00	Pass
BLE	1Mbps	2	19	2440	17.37	2.53	5.54	-0.10	8.00	Pass
BLE	1Mbps	2	39	2480	16.82	2.04	5.05	-0.10	8.00	Pass

Note: PSD (dBm/ 100kHz) is a reference level used for Conducted Band Edges and Conducted Spurious Emission 30dBc limit.

TEST RESULTS DATA
6dB and 99% Occupied Bandwidth

Mod.	Data Rate	NTX	CH.	Freq. (MHz)	99% Occupied BW (MHz)	6dB BW (MHz)	6dB BW Limit (MHz)	Pass/Fail
BLE	2Mbps	2	0	2402	2.134	1.256	0.50	Pass
BLE	2Mbps	2	19	2440	2.094	1.260	0.50	Pass
BLE	2Mbps	2	39	2480	2.090	1.264	0.50	Pass

TEST RESULTS DATA
Average Power Table

Mod.	Data Rate	NTX	CH.	Freq. (MHz)	Average Conducted Power Ant 4 (dBm)	Average Conducted Power Ant 3 (dBm)	Total Conducted Power (dBm)	Conducted Power Limit (dBm)	DG (dBi)	Total EIRP Power (dBm)	EIRP Power Limit (dBm)	Pass /Fail
BLE	2Mbps	2	0	2402	18.65	19.35	22.02	30.00	-0.10	21.92	36.00	Pass
BLE	2Mbps	2	19	2440	18.75	18.65	21.71	30.00	-0.10	21.61	36.00	Pass
BLE	2Mbps	2	39	2480	17.55	18.05	20.82	30.00	-0.10	20.72	36.00	Pass

TEST RESULTS DATA
Peak Power Density

Mod.	Data Rate	NTX	CH.	Freq. (MHz)	Peak PSD (dBm /100kHz)	Peak PSD (dBm /3kHz)	Peak PSD Worst +3.01 (dBm /3kHz)	DG (dBi)	Peak PSD Limit (dBm /3kHz)	Pass/Fail
BLE	2Mbps	2	0	2402	17.49	-1.21	1.80	-0.10	8.00	Pass
BLE	2Mbps	2	19	2440	17.41	-1.11	1.90	-0.10	8.00	Pass
BLE	2Mbps	2	39	2480	15.97	-2.43	0.58	-0.10	8.00	Pass

Note: PSD (dBm/ 100kHz) is a reference level used for Conducted Band Edges and Conducted Spurious Emission 30dBc limit.

<TXBF HR 4Mbps 8Mbps Ant.3+4>

TEST RESULTS DATA								
<u>6dB and 99% Occupied Bandwidth</u>								
Mod.	Data Rate	NTx	CH.	Freq. (MHz)	99% Occupied BW (MHz)	6dB BW (MHz)	6dB BW Limit (MHz)	Pass/Fail
BT	4Mbps	2	2	2404	2.406	1.656	0.50	Pass
BT	4Mbps	2	39	2441	2.414	1.656	0.50	Pass
BT	4Mbps	2	76	2478	2.406	1.656	0.50	Pass

TEST RESULTS DATA												
<u>Peak Power Table</u>												
Mod.	Data Rate	NTx	CH.	Freq. (MHz)	Peak Conducted Power Ant 3 (dBm)	Peak Conducted Power Ant 4 (dBm)	Total Conducted Power (dBm)	Conducted Power Limit (dBm)	DG (dBi)	Total EIRP Power (dBm)	EIRP Power Limit (dBm)	Pass /Fail
BT	4Mbps	2	2	2404	18.05	17.78	20.93	30.00	-0.10	20.83	36.00	Pass
BT	4Mbps	2	39	2441	17.55	17.40	20.49	30.00	-0.10	20.39	36.00	Pass
BT	4Mbps	2	76	2478	17.74	16.83	20.32	30.00	-0.10	20.22	36.00	Pass

TEST RESULTS DATA										
<u>Peak Power Density</u>										
Mod.	Data Rate	NTx	CH.	Freq. (MHz)	Peak PSD (dBm /100kHz)	Peak PSD (dBm /3kHz)	Peak PSD Worst +3.01 (dBm /3kHz)	DG (dBi)	Peak PSD Limit (dBm /3kHz)	Pass/Fail
BT	4Mbps	2	2	2404	14.02	-1.74	1.27	-0.10	8.00	Pass
BT	4Mbps	2	39	2441	13.77	-1.96	1.05	-0.10	8.00	Pass
BT	4Mbps	2	76	2478	13.99	-1.74	1.27	-0.10	8.00	Pass

Note: PSD (dBm/ 100kHz) is a reference level used for Conducted Band Edges and Conducted Spurious Emission 30dBc limit.

TEST RESULTS DATA
6dB and 99% Occupied Bandwidth

Mod.	Data Rate	NTx	CH.	Freq. (MHz)	99% Occupied BW (MHz)	6dB BW (MHz)	6dB BW Limit (MHz)	Pass/Fail
BT	8Mbps	2	2	2404	4.683	0.660	0.50	Pass
BT	8Mbps	2	39	2441	4.683	0.664	0.50	Pass
BT	8Mbps	2	76	2478	4.699	0.668	0.50	Pass

TEST RESULTS DATA
Peak Power Table

Mod.	Data Rate	NTx	CH.	Freq. (MHz)	Peak Conducted Power Ant 3 (dBm)	Peak Conducted Power Ant 4 (dBm)	Total Conducted Power (dBm)	Conducted Power Limit (dBm)	DG (dBi)	Total EIRP Power (dBm)	EIRP Power Limit (dBm)	Pass /Fail
BT	8Mbps	2	2	2404	18.00	17.77	20.90	30.00	-0.10	20.80	36.00	Pass
BT	8Mbps	2	39	2441	17.53	17.39	20.47	30.00	-0.10	20.37	36.00	Pass
BT	8Mbps	2	76	2478	17.84	16.93	20.42	30.00	-0.10	20.32	36.00	Pass

TEST RESULTS DATA
Peak Power Density

Mod.	Data Rate	NTx	CH.	Freq. (MHz)	Peak PSD (dBm /100kHz)	Peak PSD (dBm /3kHz)	Peak PSD Worst +3.01 (dBm /3kHz)	DG (dBi)	Peak PSD Limit (dBm /3kHz)	Pass/Fail
BT	8Mbps	2	2	2404	13.96	-0.82	2.19	-0.10	8.00	Pass
BT	8Mbps	2	39	2441	13.46	-0.91	2.10	-0.10	8.00	Pass
BT	8Mbps	2	76	2478	13.98	-0.90	2.11	-0.10	8.00	Pass

Note: PSD (dBm/ 100kHz) is a reference level used for Conducted Band Edges and Conducted Spurious Emission 30dBc limit.



TXBF Mode

MIMO <Ant. 3>

6dB Bandwidth

<1Mbps>

6 dB Bandwidth Plot on Channel 00

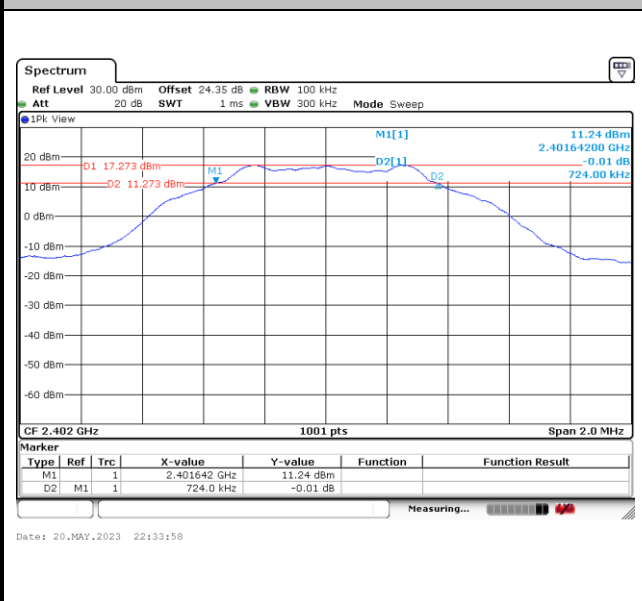

6 dB Bandwidth Plot on Channel 19

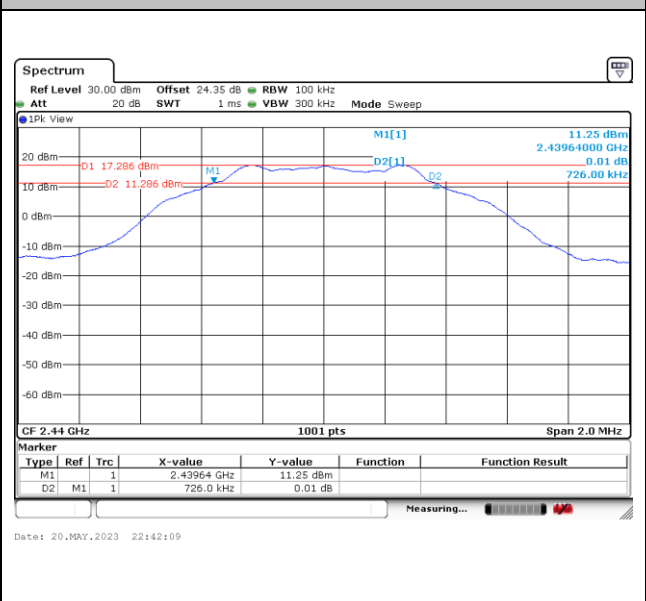

6 dB Bandwidth Plot on Channel 39

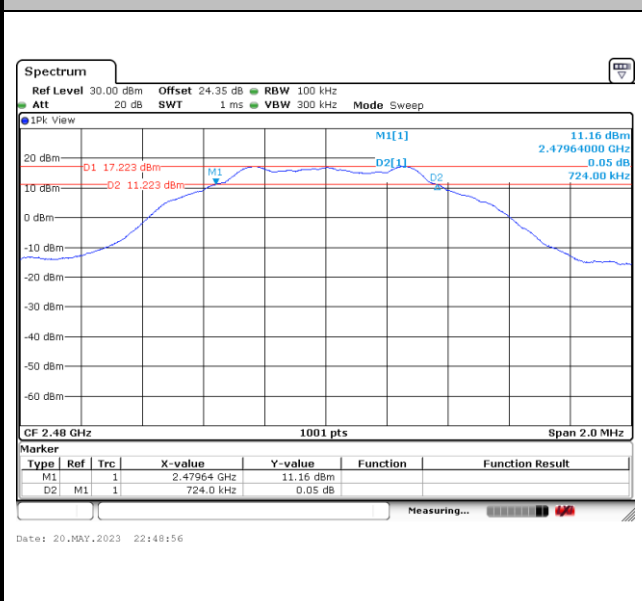



<2Mbps>

6 dB Bandwidth Plot on Channel 00

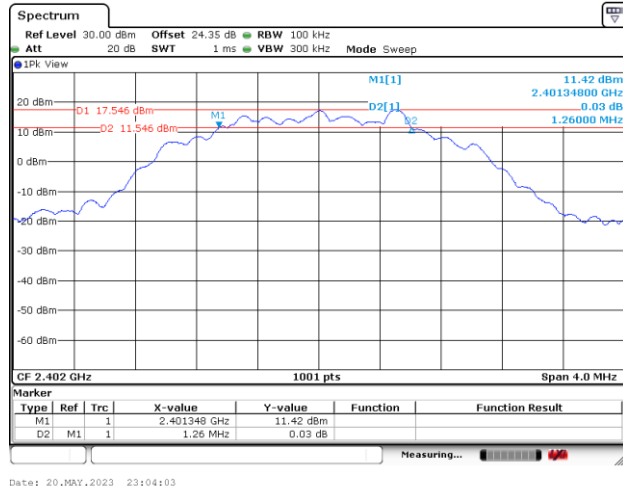

6 dB Bandwidth Plot on Channel 19

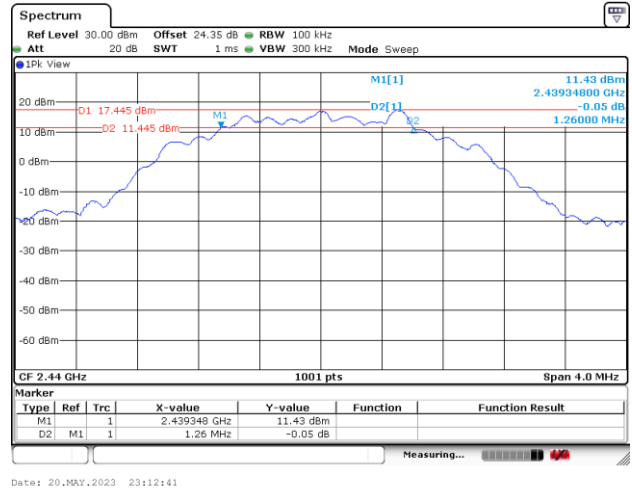

6 dB Bandwidth Plot on Channel 39

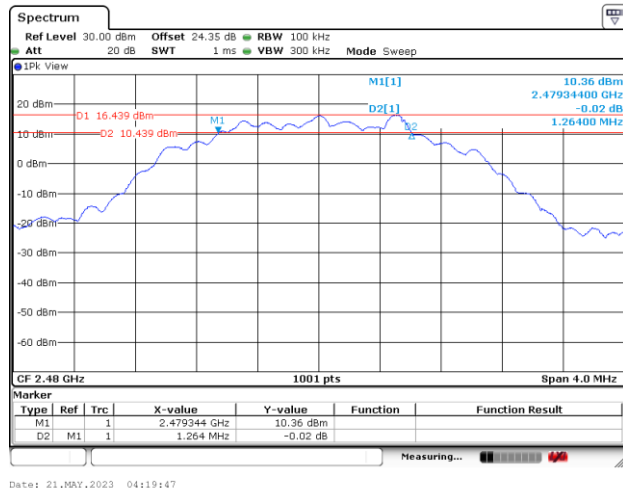



99% Occupied Bandwidth

<1Mbps>

99% Occupied Bandwidth Plot on Channel 00

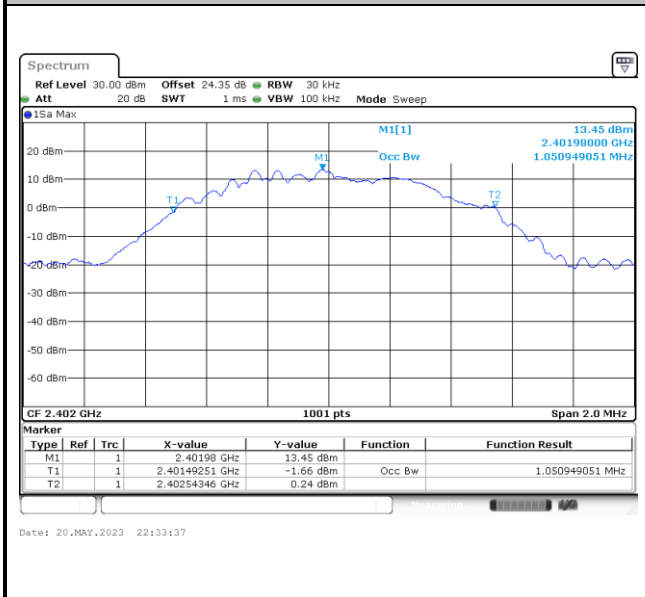

99% Occupied Plot Bandwidth on Channel 19

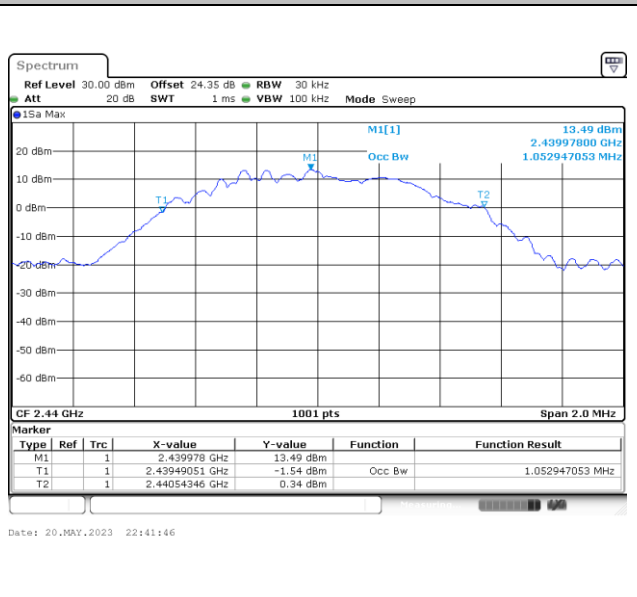

99% Occupied Bandwidth Plot on Channel 39

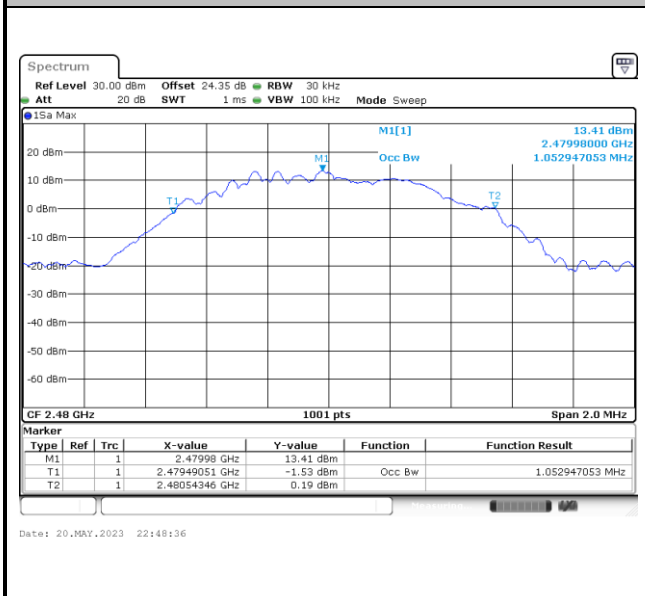

Note: The occupied channel bandwidth is maintained within the band of operation for all of the modulations.



<2Mbps>

99% Occupied Bandwidth Plot on Channel 00

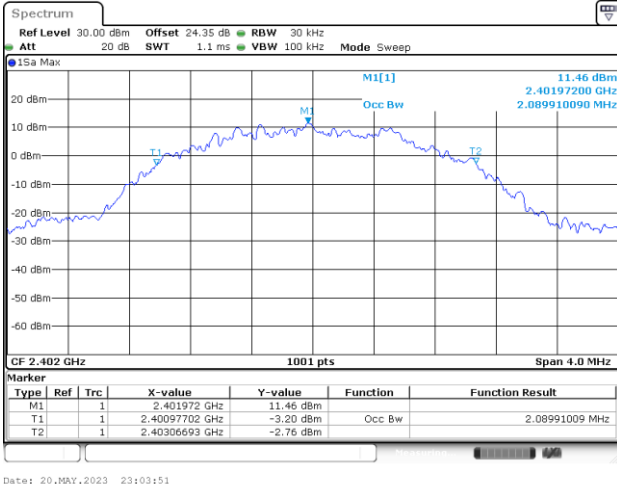

99% Occupied Plot Bandwidth on Channel 19

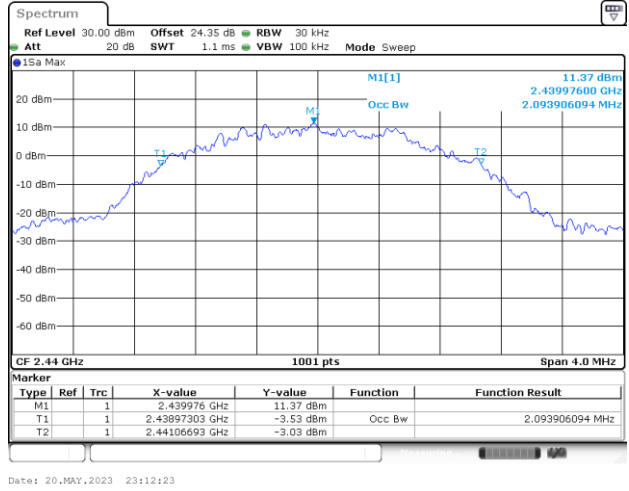

99% Occupied Bandwidth Plot on Channel 39

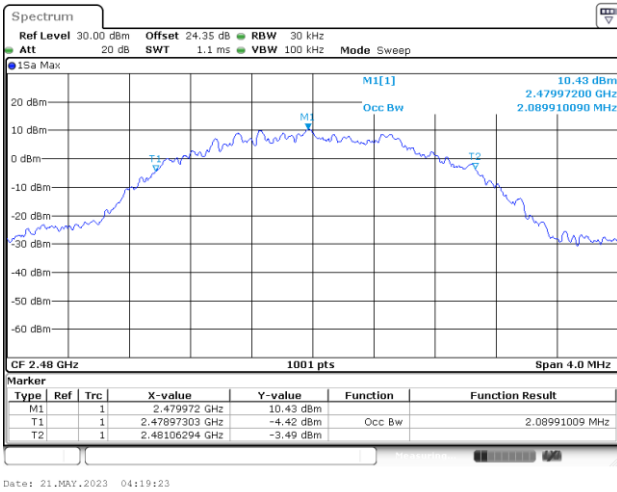



Power Spectral Density (dBm/3kHz)

<1Mbps>

Power Density (dBm/3kHz) Plot Channel 00

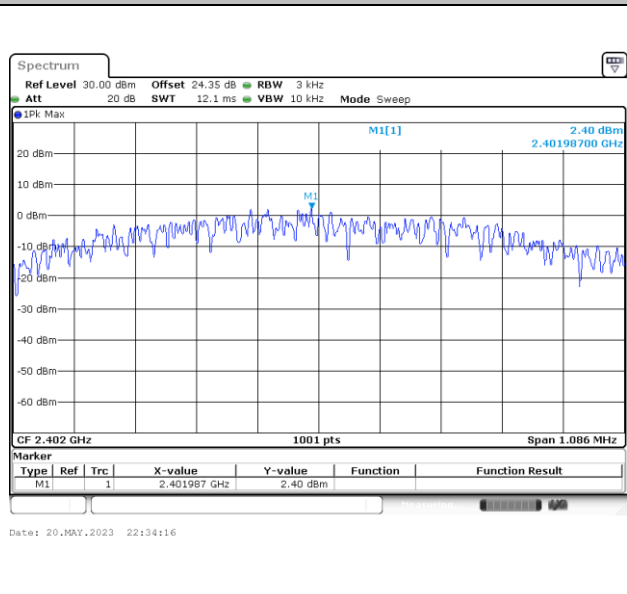

Power Density (dBm/3kHz) Plot Channel 19

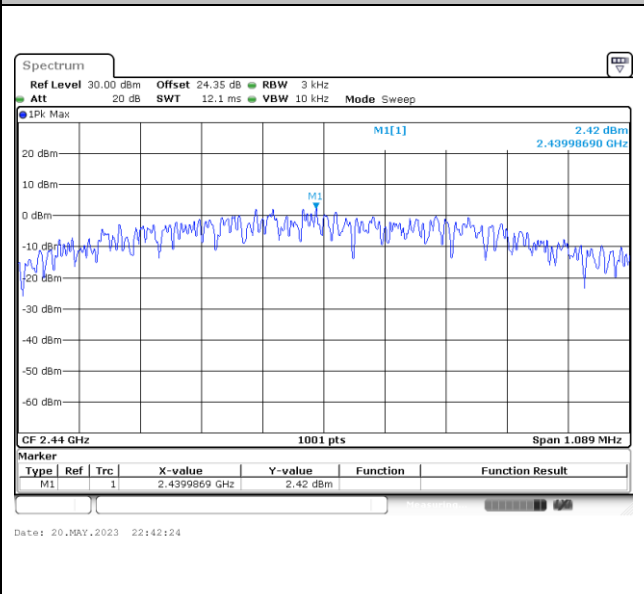

Power Density (dBm/3kHz) Plot Channel 39

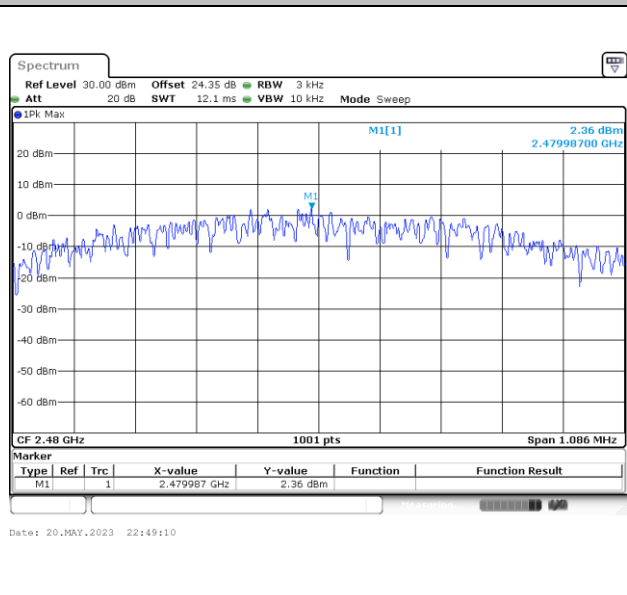



<2Mbps>

Power Density (dBm/3kHz) Plot Channel 00

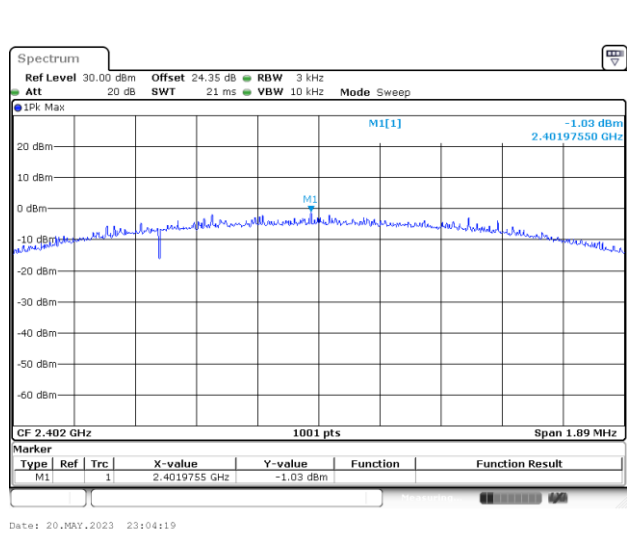

Power Density (dBm/3kHz) Plot Channel 19

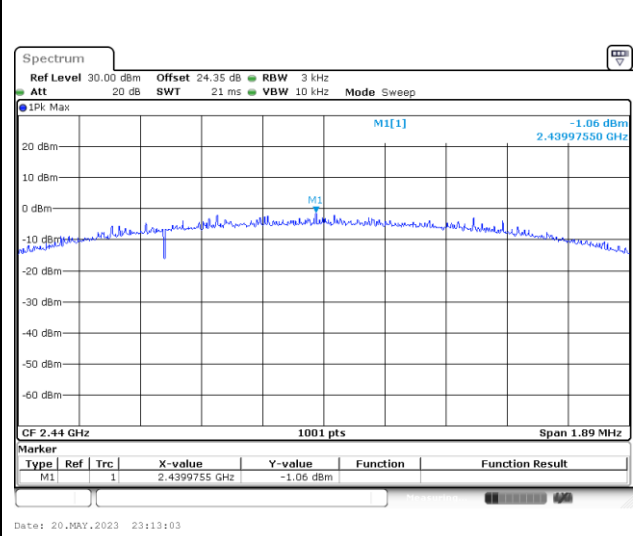

Power Density (dBm/3kHz) Plot Channel 39

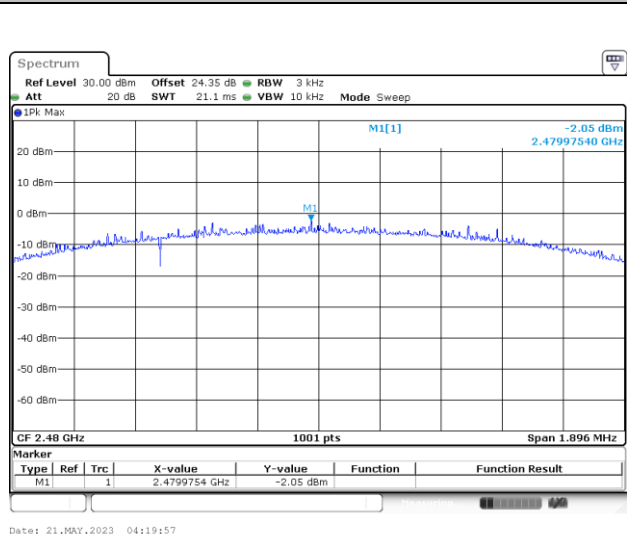



Band Edge and Spurious Emission

<1Mbps> Channel 00

100kHz PSD reference Level Plot

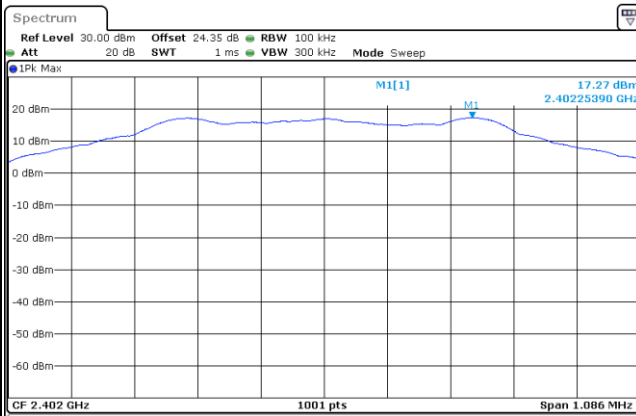

Date: 20.MAY.2023 22:34:35

Low Channel Plot

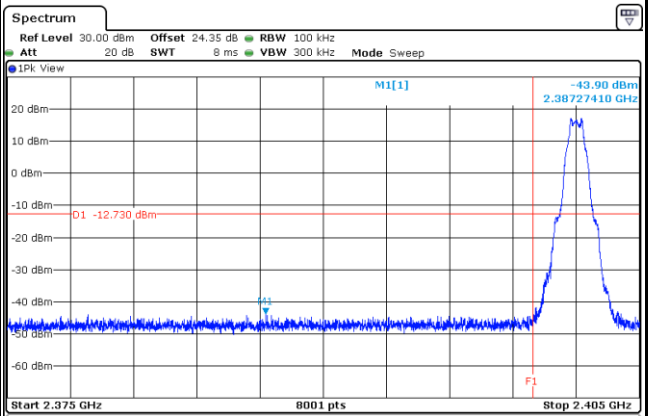

Date: 20.MAY.2023 22:35:47

Spurious Emission 30MHz~1GHz Plot

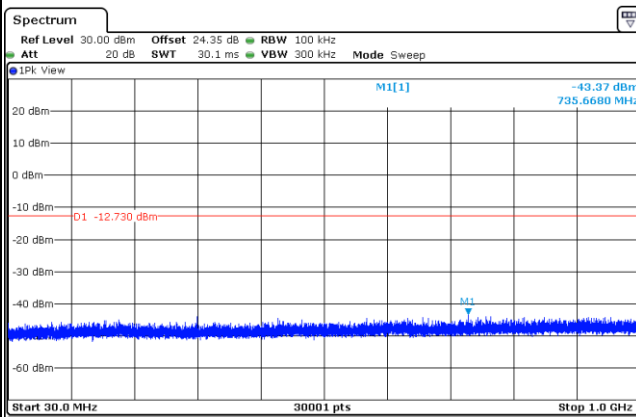

Date: 20.MAY.2023 22:35:19

Spurious Emission 1GHz~26.5GHz Plot

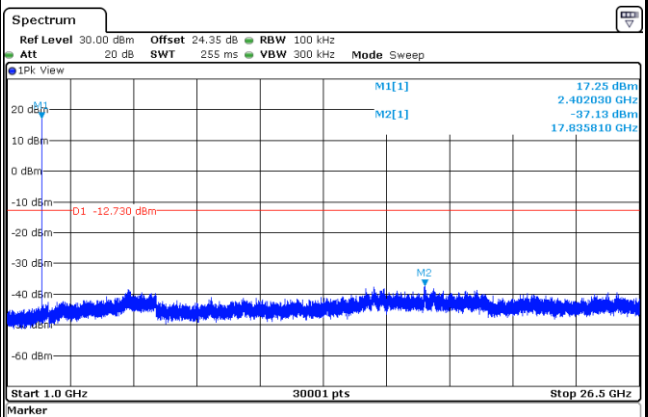

Date: 20.MAY.2023 22:35:34



<1Mbps> Channel 19

100kHz PSD reference Level Plot

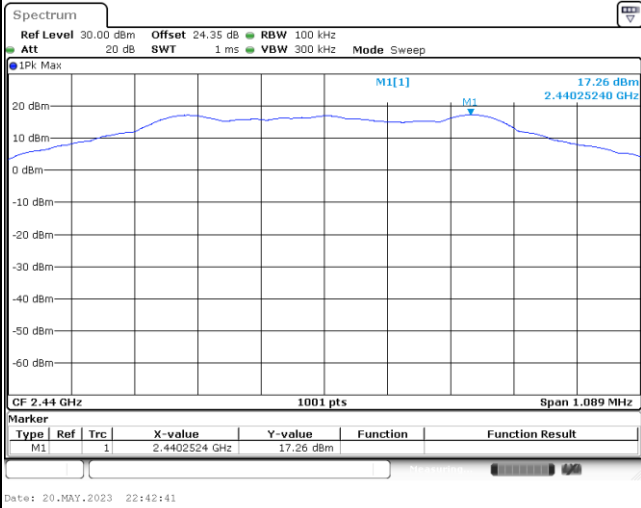

Low Channel Plot

Spurious Emission 30MHz~1GHz Plot

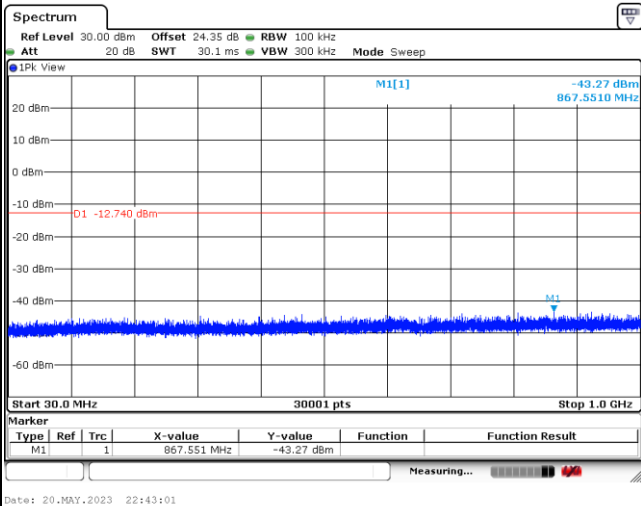

Spurious Emission 1GHz~26.5GHz Plot

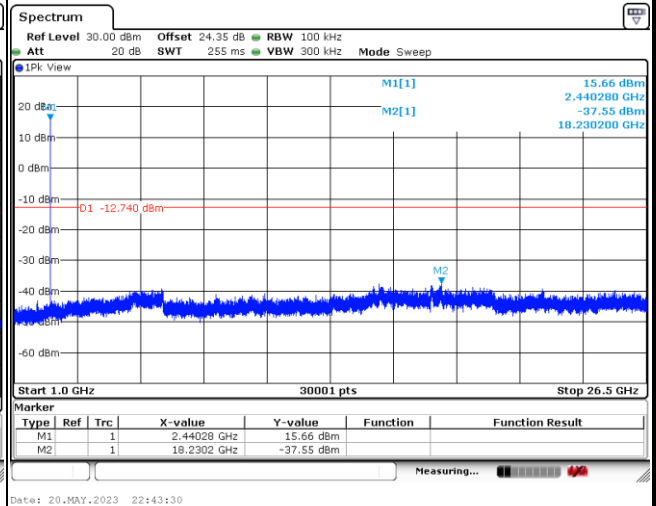



<1Mbps> Channel 39

100kHz PSD reference Level Plot

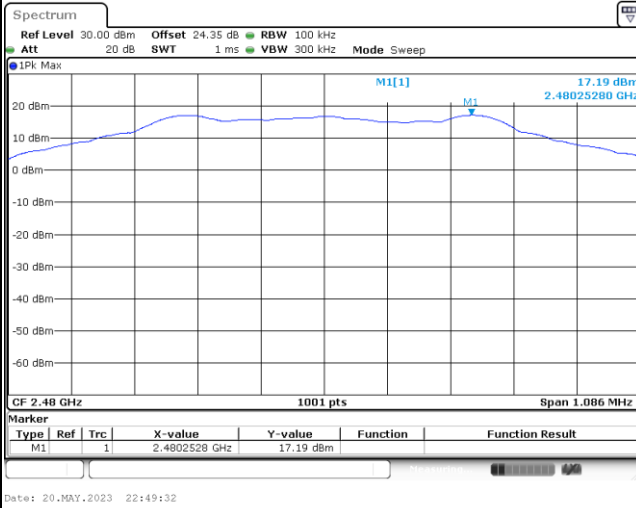

Low Channel Plot

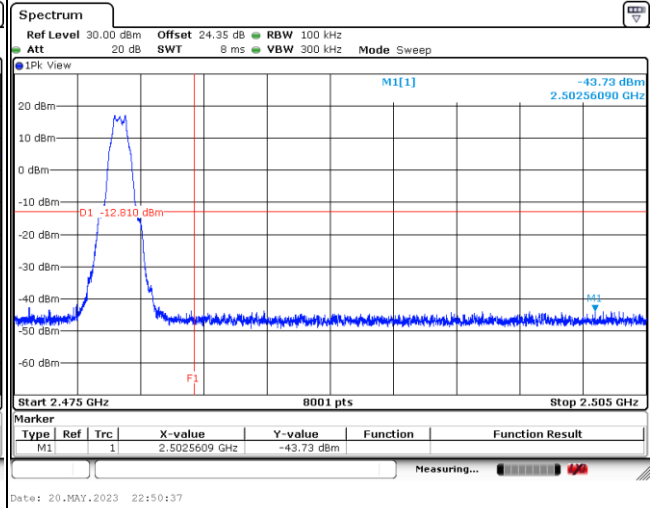

Spurious Emission 30MHz~1GHz Plot

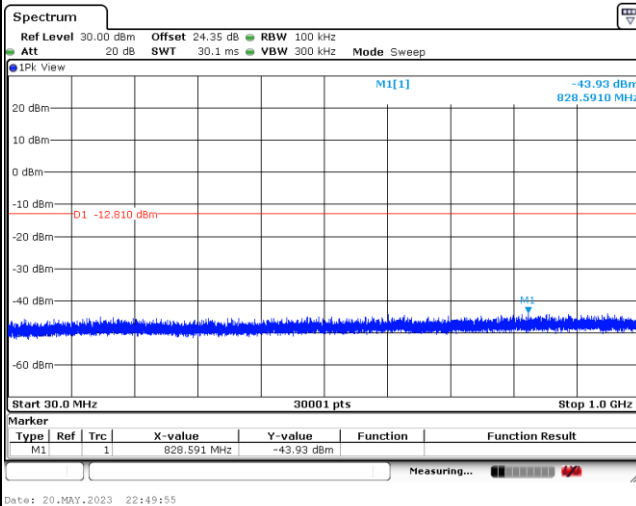

Spurious Emission 1GHz~26.5GHz Plot

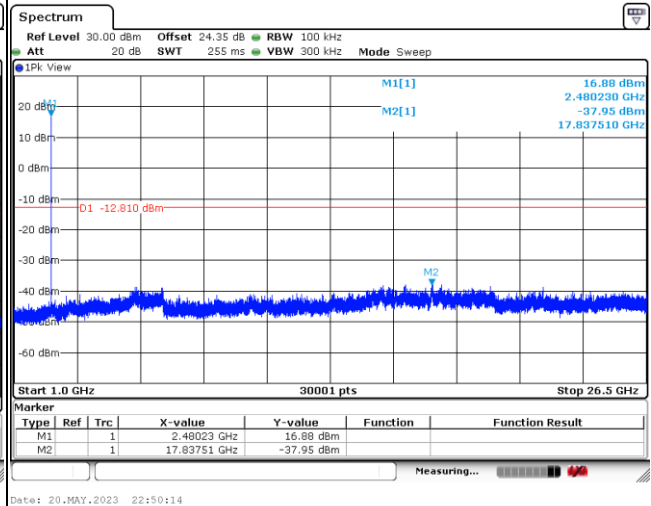



<2Mbps> Channel 00

100kHz PSD reference Level Plot

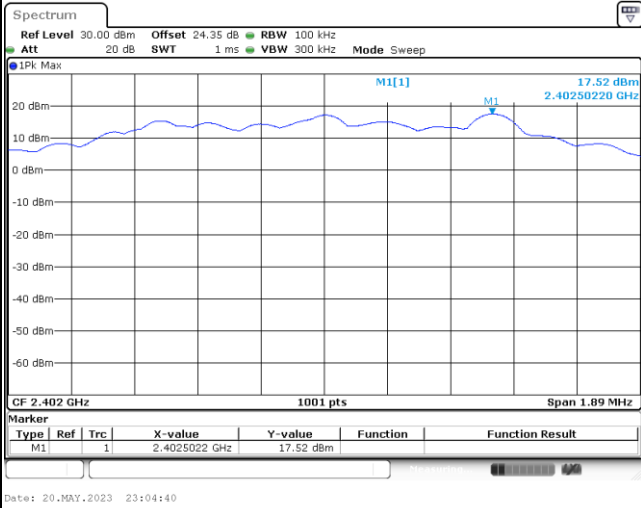

Low Channel Plot

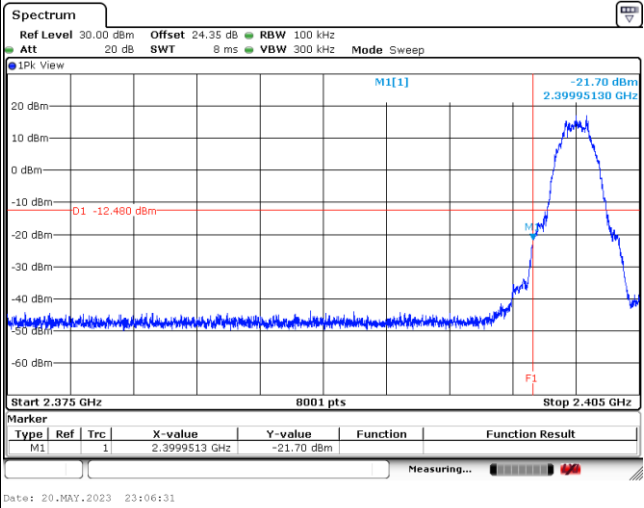

Spurious Emission 30MHz~1GHz Plot

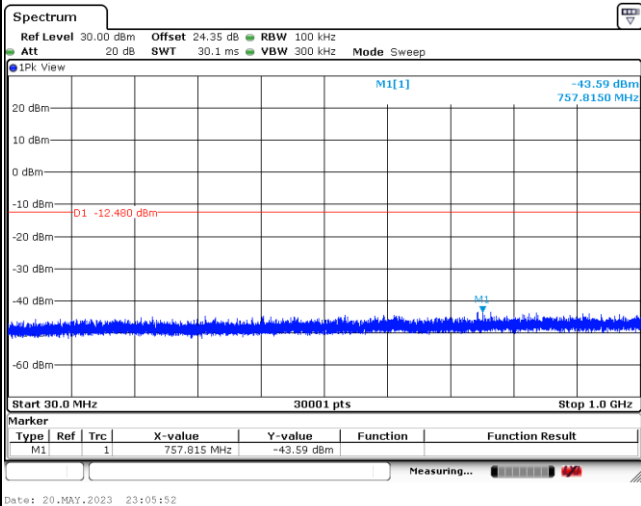

Spurious Emission 1GHz~26.5GHz Plot

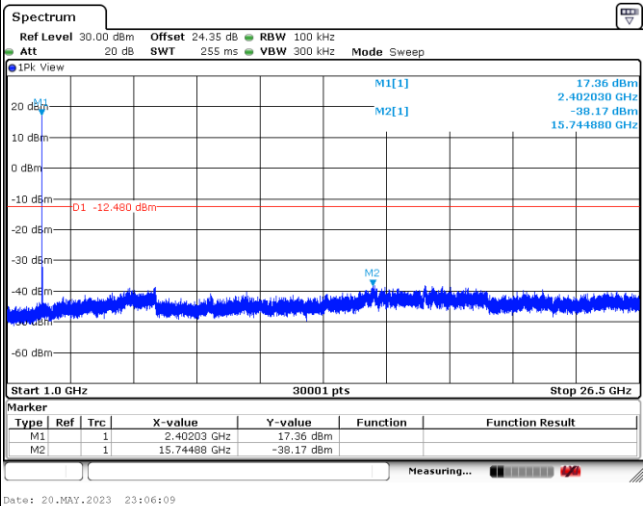



<2Mbps> Channel 19

100kHz PSD reference Level Plot

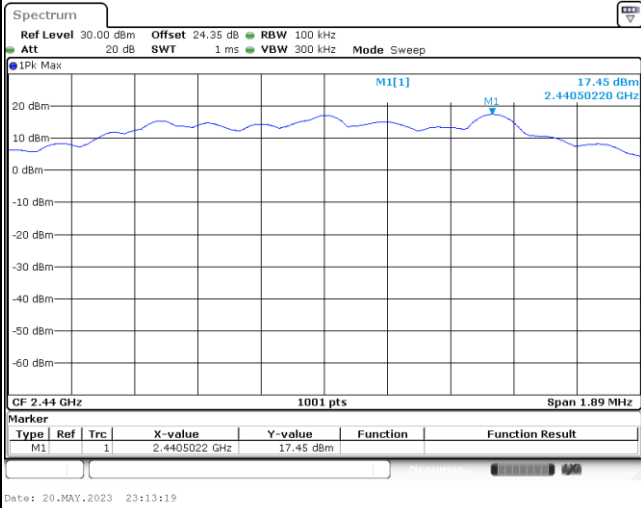

Low Channel Plot



Spurious Emission 30MHz~1GHz Plot

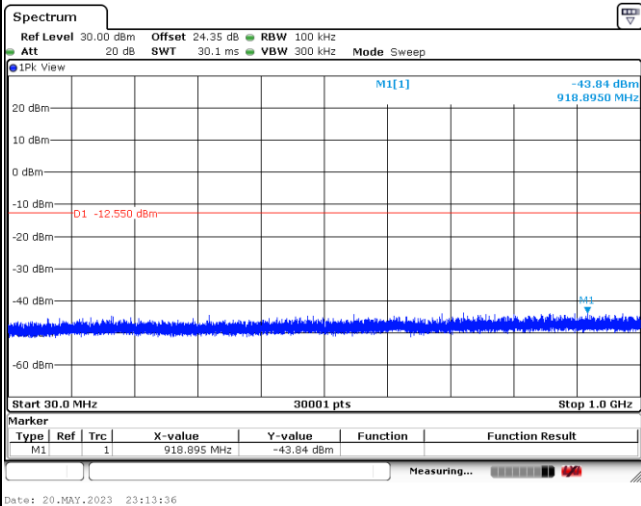

Spurious Emission 1GHz~26.5GHz Plot

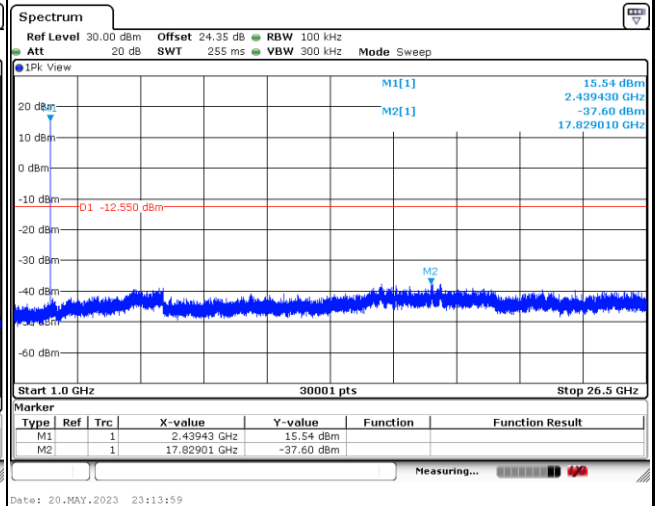



<2Mbps> Channel 39

100kHz PSD reference Level Plot

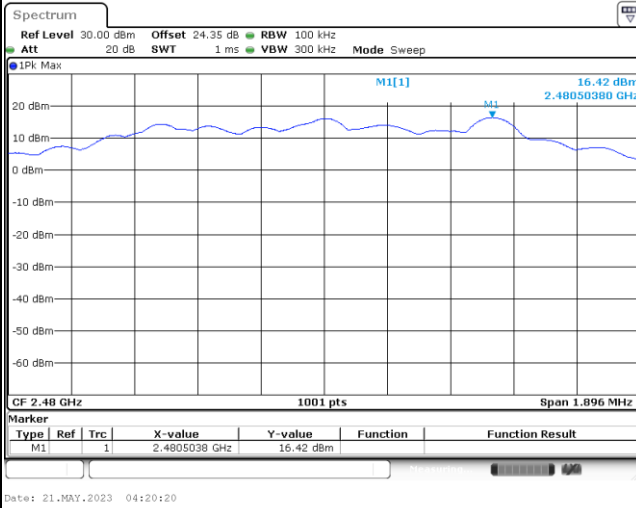

Low Channel Plot

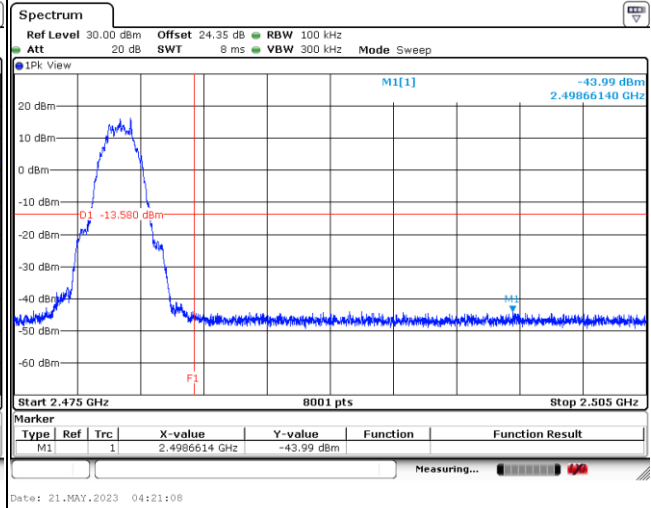

Spurious Emission 30MHz~1GHz Plot

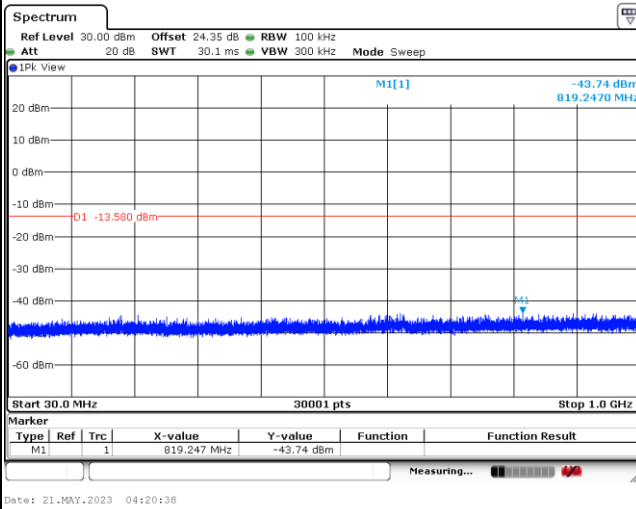

Spurious Emission 1GHz~26.5GHz Plot

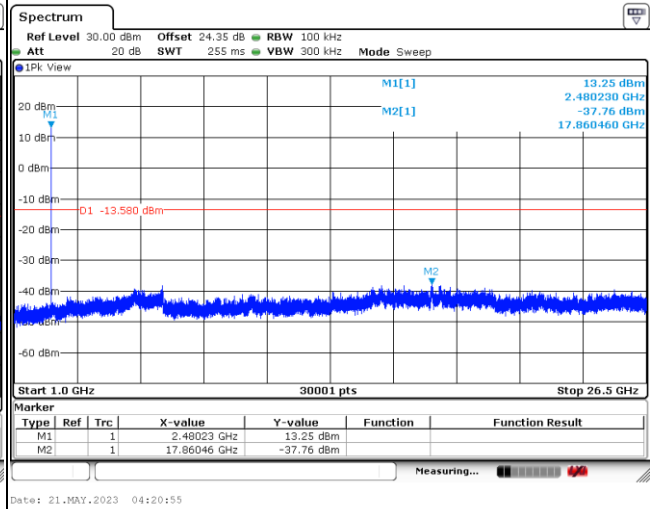



TXBF Mode

MIMO <Ant. 4>

6dB Bandwidth

<1Mbps>

6 dB Bandwidth Plot on Channel 00

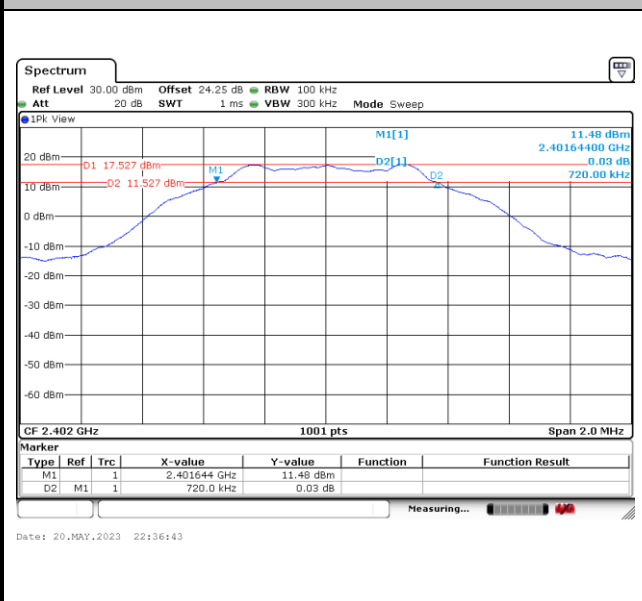

6 dB Bandwidth Plot on Channel 19

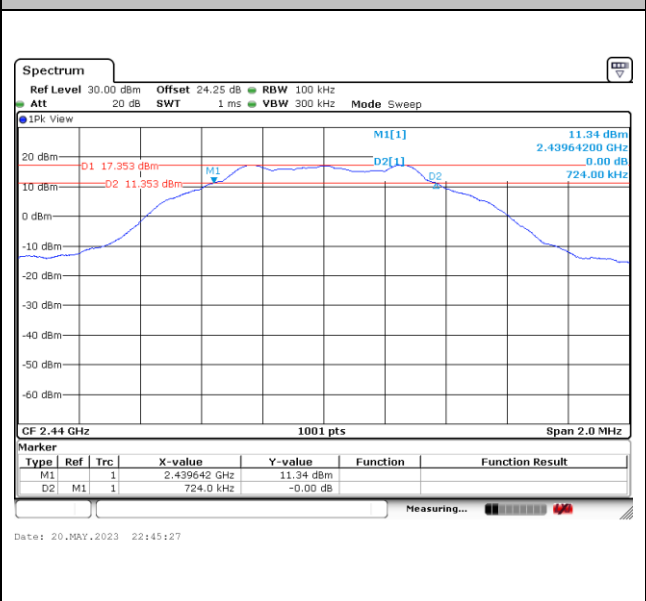

6 dB Bandwidth Plot on Channel 39

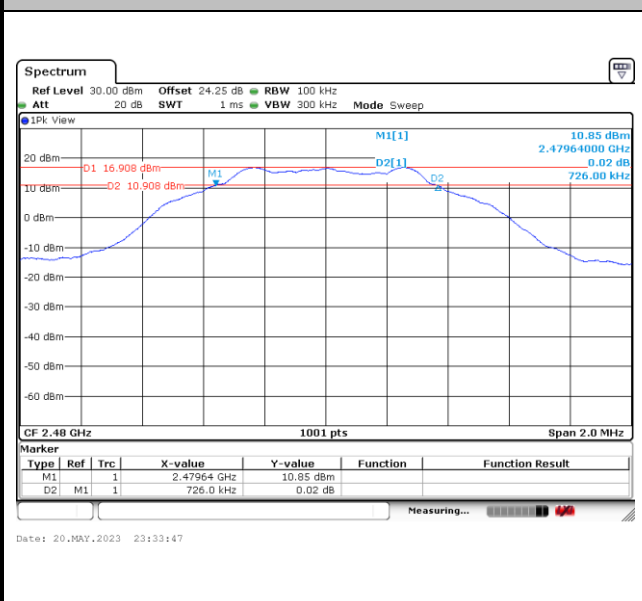



<2Mbps>

6 dB Bandwidth Plot on Channel 00

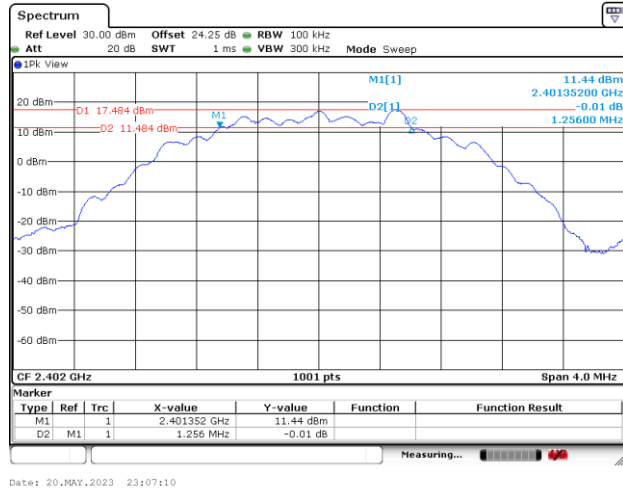

6 dB Bandwidth Plot on Channel 19

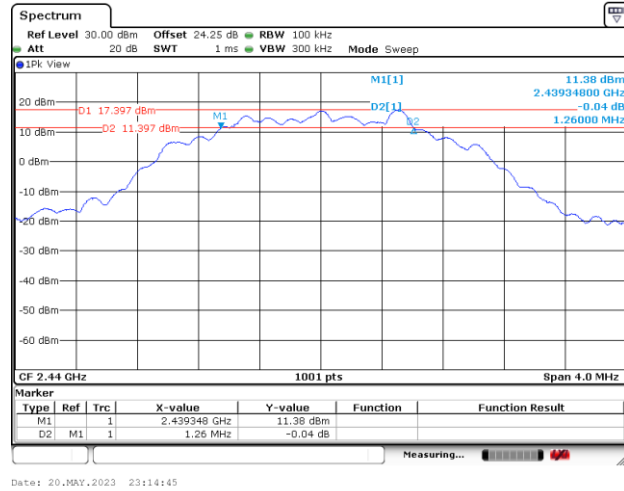

6 dB Bandwidth Plot on Channel 39

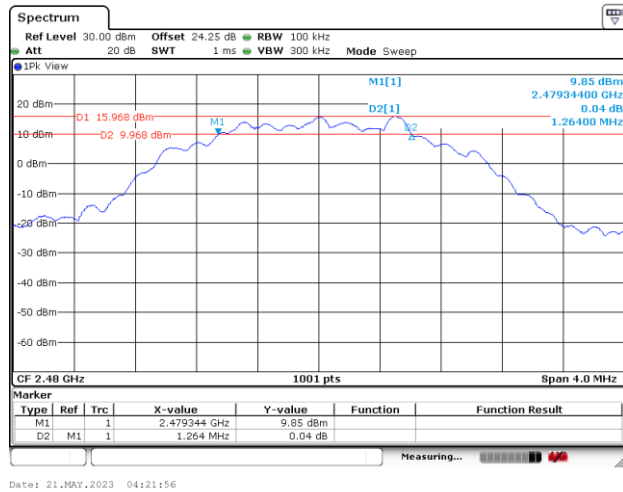



99% Occupied Bandwidth

<1Mbps>

99% Occupied Bandwidth Plot on Channel 00

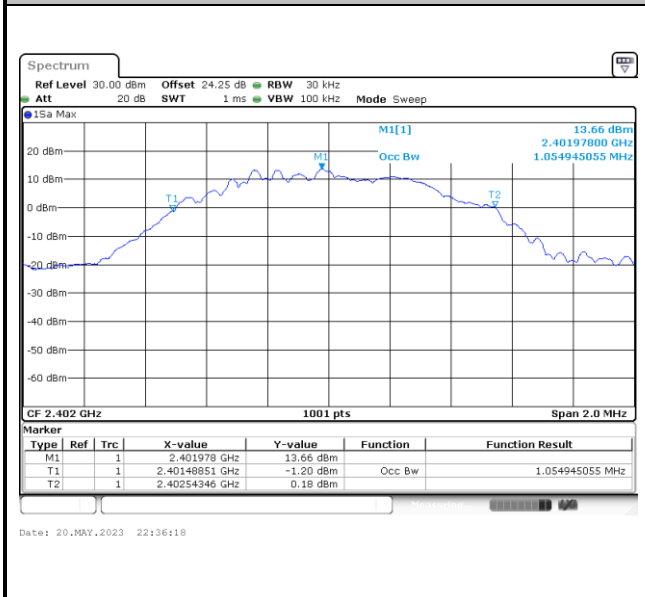

99% Occupied Plot Bandwidth on Channel 19

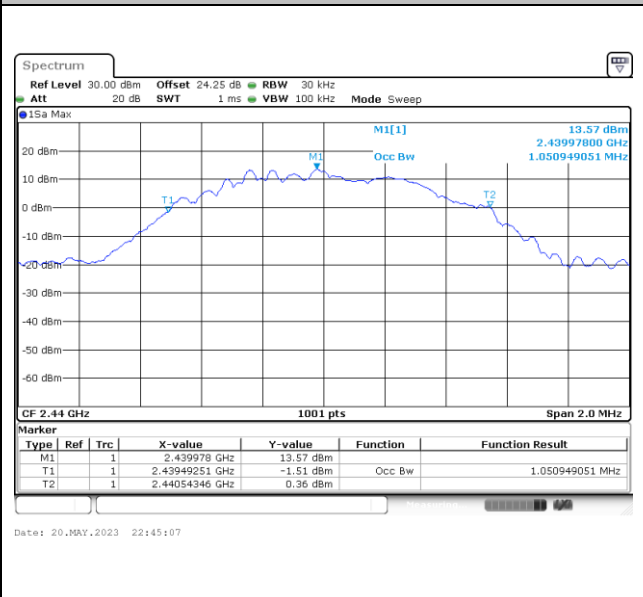

99% Occupied Bandwidth Plot on Channel 39

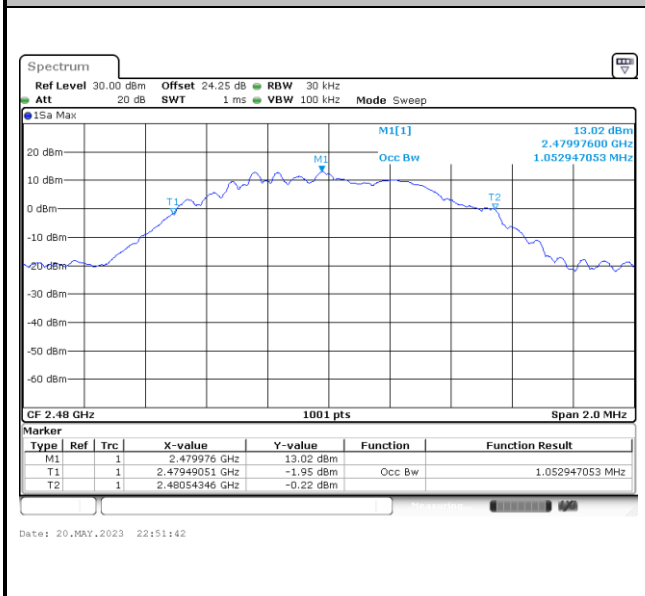

Note: The occupied channel bandwidth is maintained within the band of operation for all of the modulations.



<2Mbps>

99% Occupied Bandwidth Plot on Channel 00

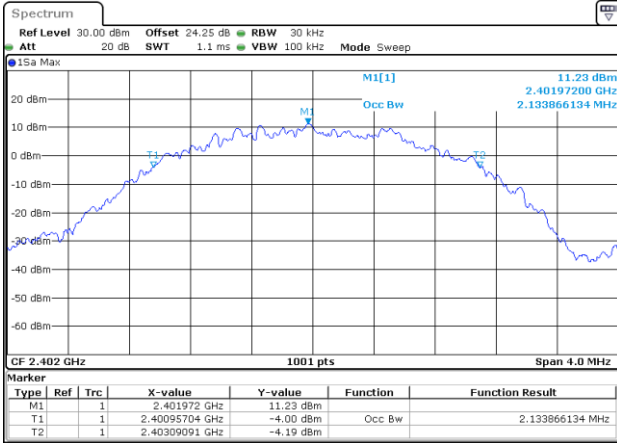

Date: 20.MAY.2023 23:06:47

99% Occupied Plot Bandwidth on Channel 19

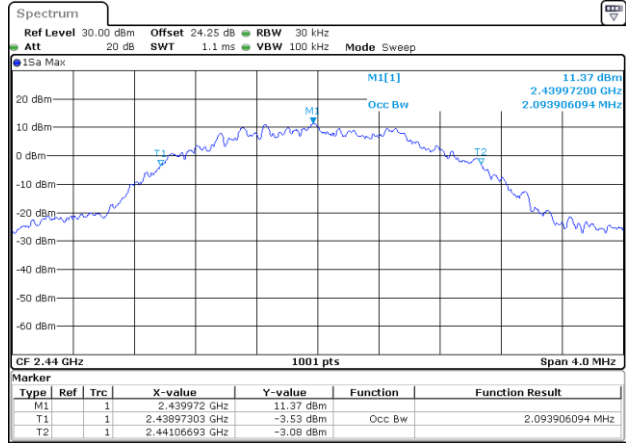

Date: 20.MAY.2023 23:14:17

99% Occupied Bandwidth Plot on Channel 39

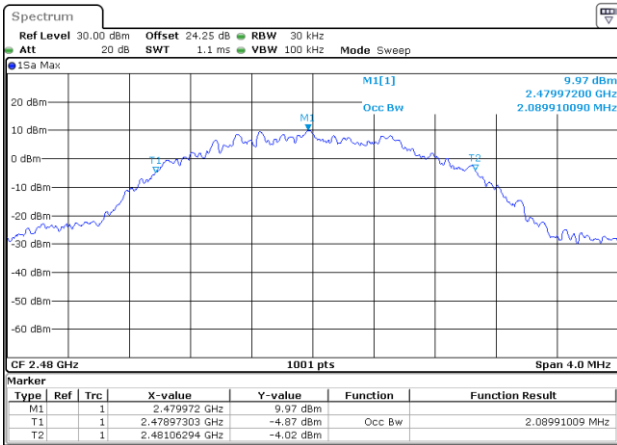

Date: 21.MAY.2023 04:21:35



Power Spectral Density (dBm/3kHz)

<1Mbps>

Power Density (dBm/3kHz) Plot Channel 00

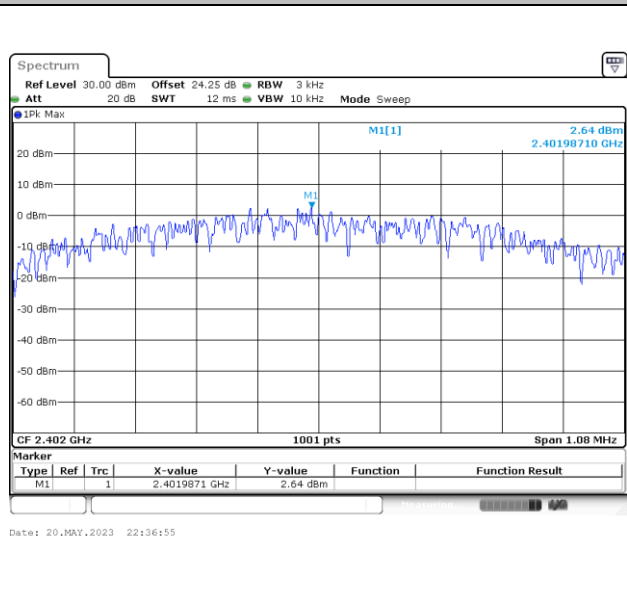

Power Density (dBm/3kHz) Plot Channel 19

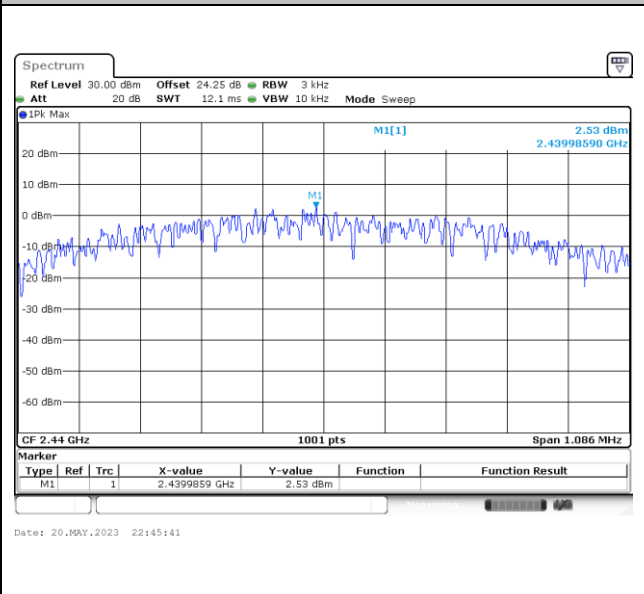

Power Density (dBm/3kHz) Plot Channel 39

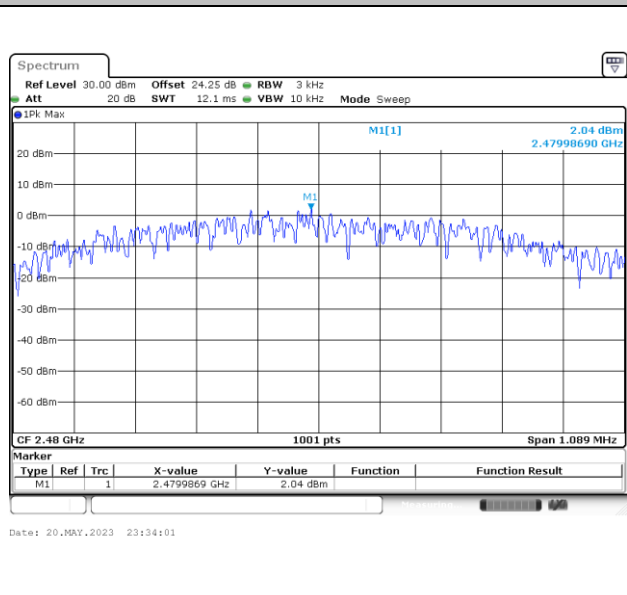



<2Mbps>

Power Density (dBm/3kHz) Plot Channel 00

Power Density (dBm/3kHz) Plot Channel 19

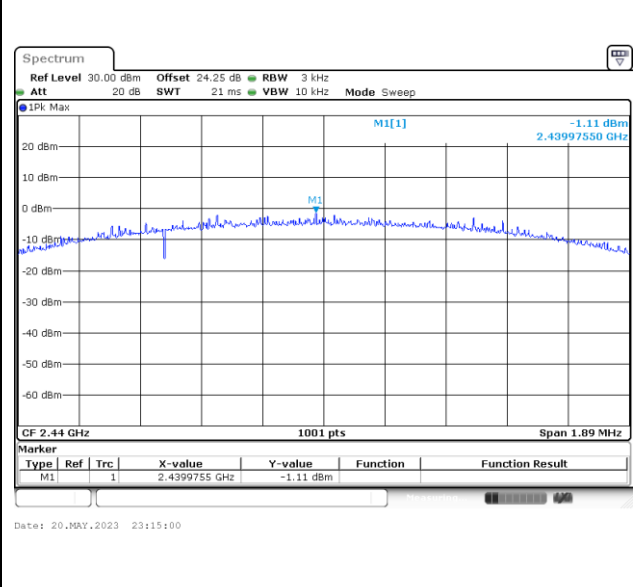
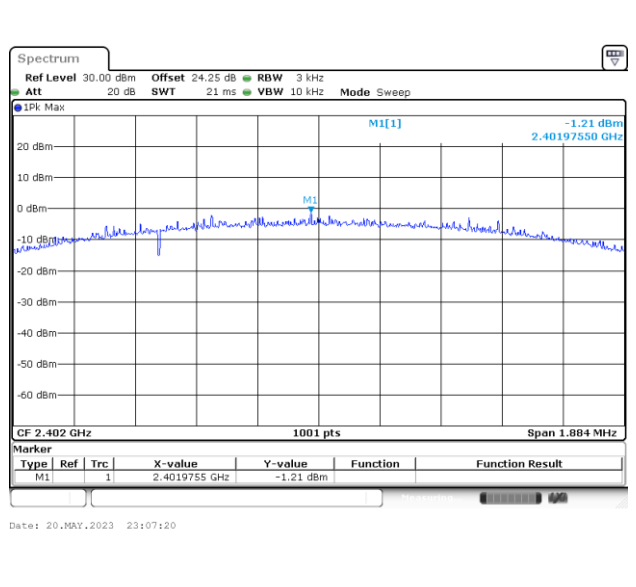

Power Density (dBm/3kHz) Plot Channel 39

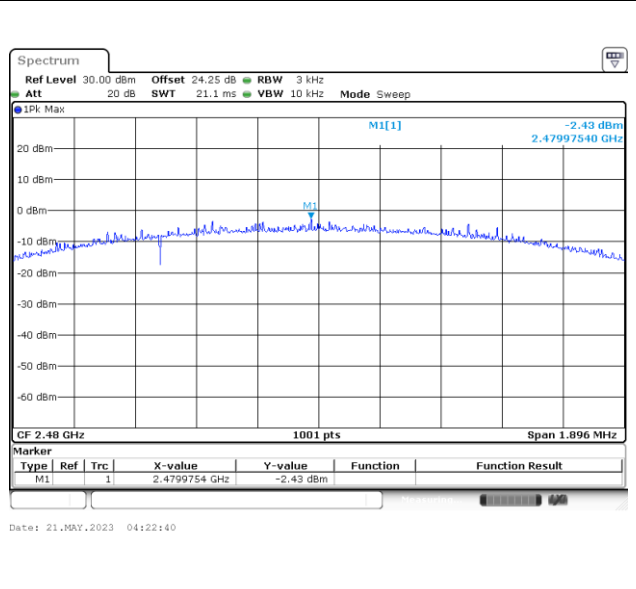



Band Edge and Spurious Emission

<1Mbps> Channel 00

100kHz PSD reference Level Plot

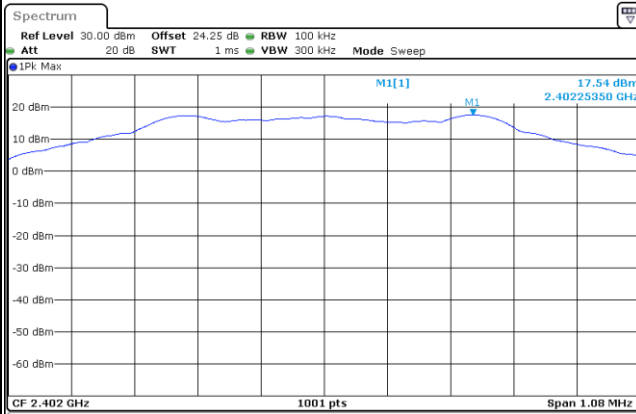

Date: 20.MAY.2023 22:37:13

Low Channel Plot

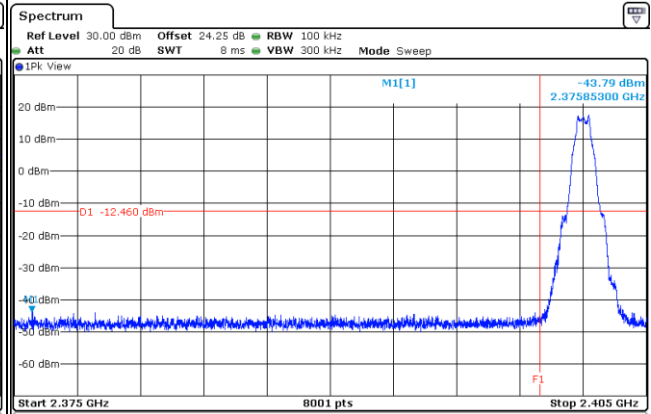

Date: 20.MAY.2023 22:38:07

Spurious Emission 30MHz~1GHz Plot

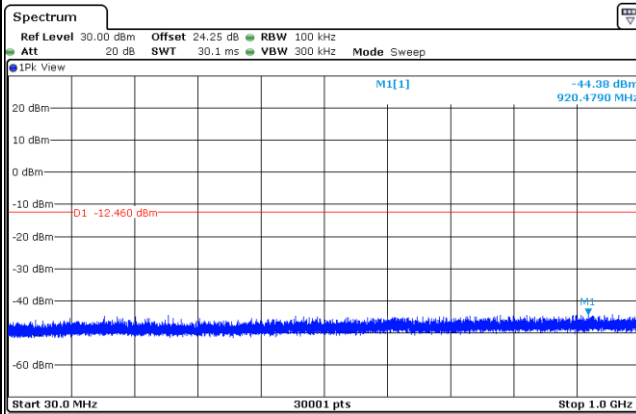

Date: 20.MAY.2023 22:37:37

Spurious Emission 1GHz~26.5GHz Plot

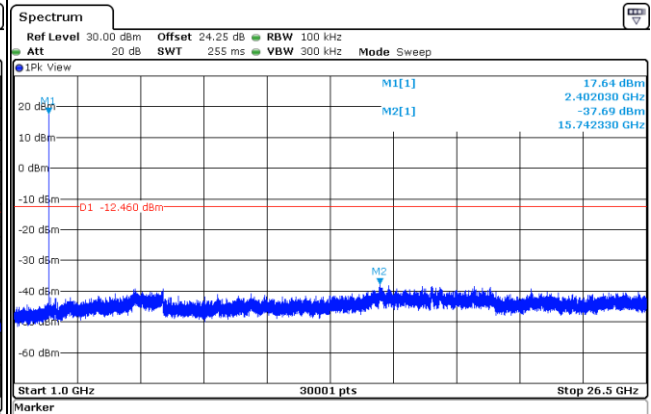

Date: 20.MAY.2023 22:37:52



<1Mbps> Channel 19

100kHz PSD reference Level Plot

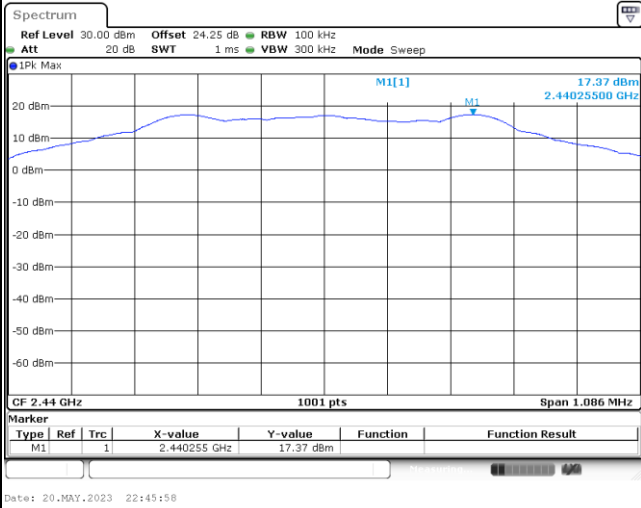

Low Channel Plot

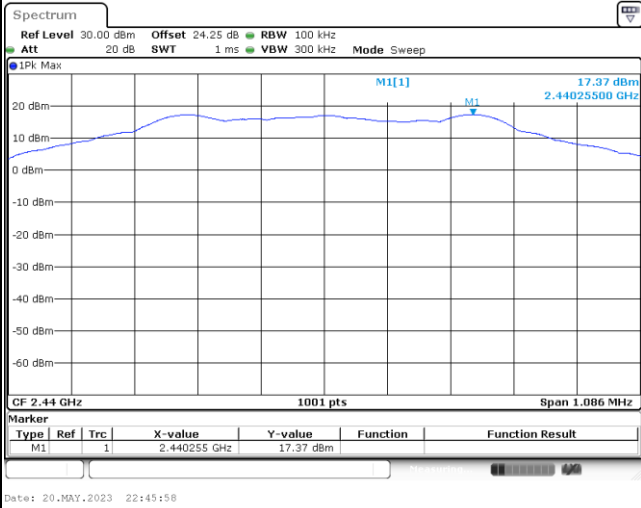

Spurious Emission 30MHz~1GHz Plot

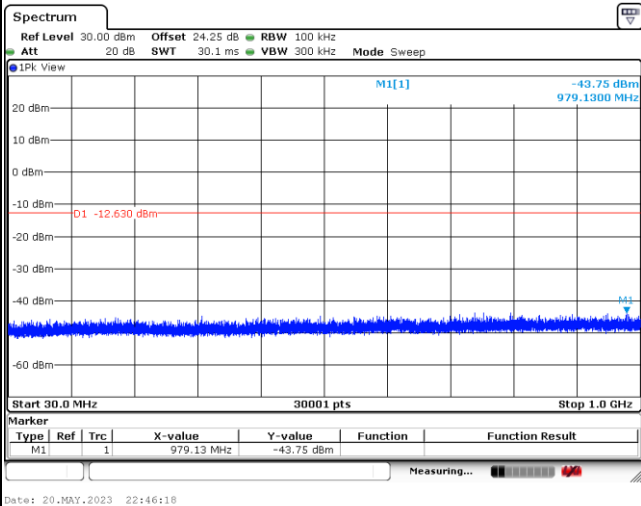

Spurious Emission 1GHz~26.5GHz Plot

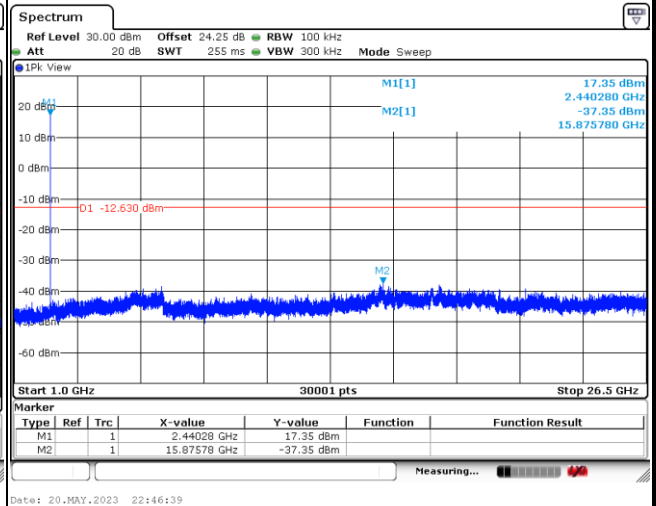



<1Mbps> Channel 39

100kHz PSD reference Level Plot

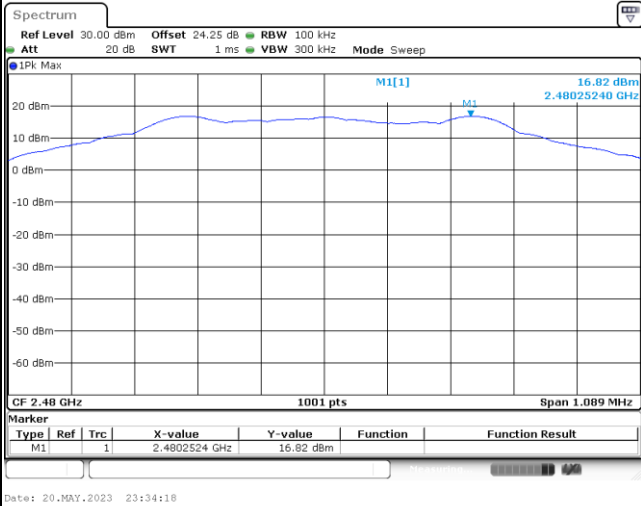

Low Channel Plot

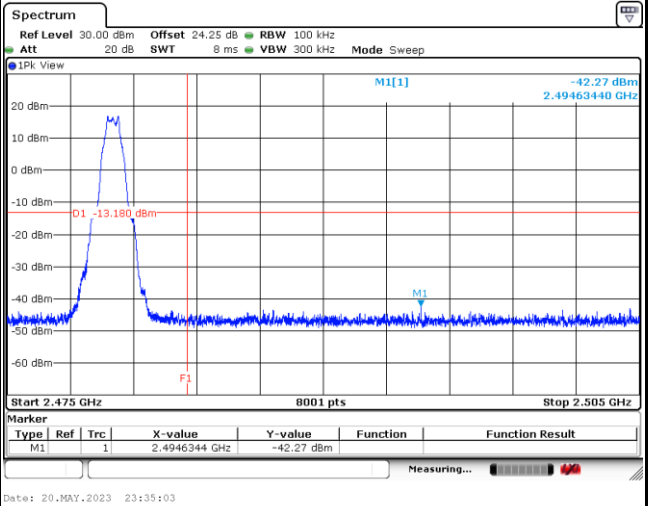

Spurious Emission 30MHz~1GHz Plot

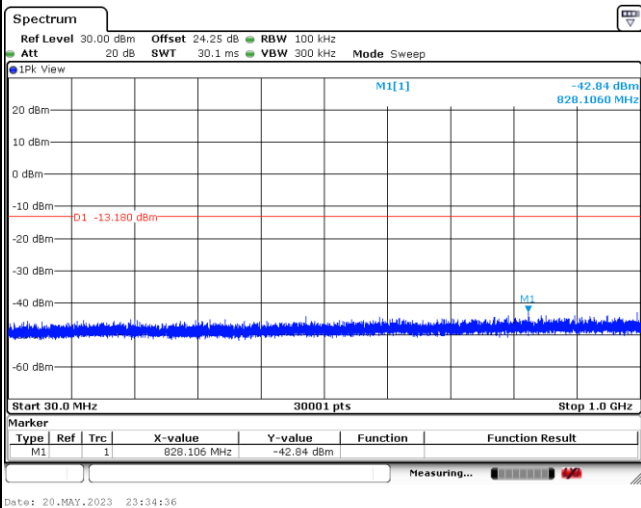

Spurious Emission 1GHz~26.5GHz Plot

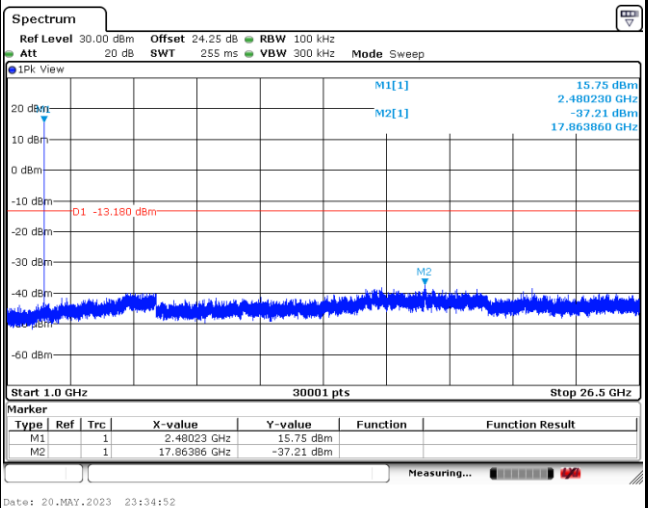



<2Mbps> Channel 00

100kHz PSD reference Level Plot

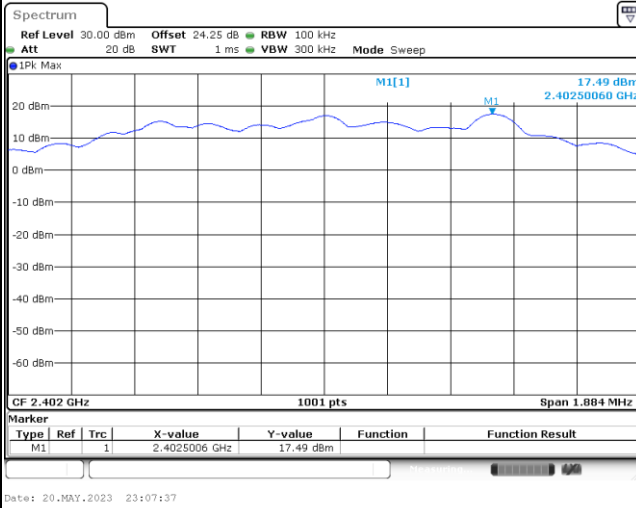

Low Channel Plot

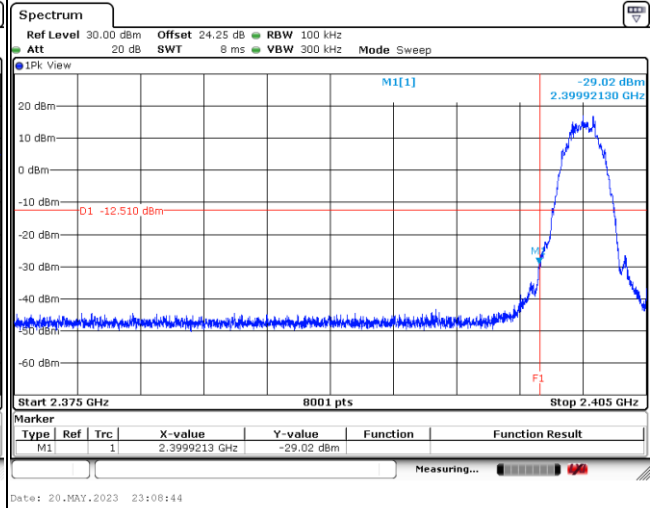

Spurious Emission 30MHz~1GHz Plot

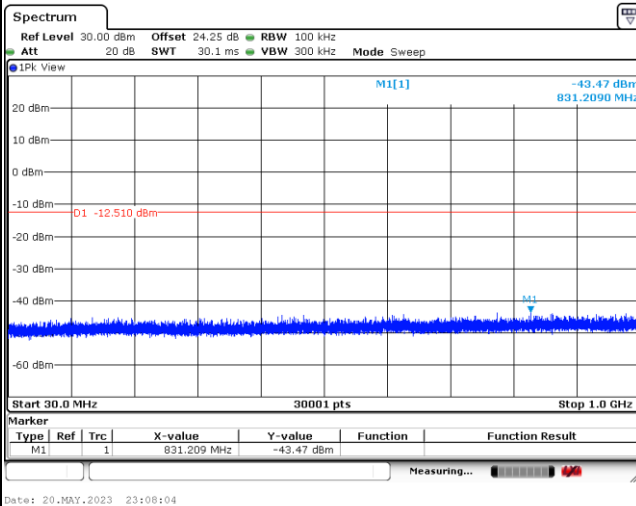

Spurious Emission 1GHz~26.5GHz Plot

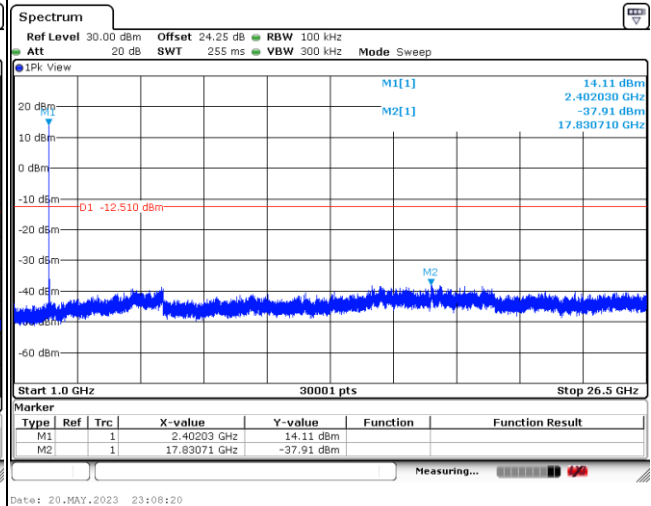



<2Mbps> Channel 19

100kHz PSD reference Level Plot

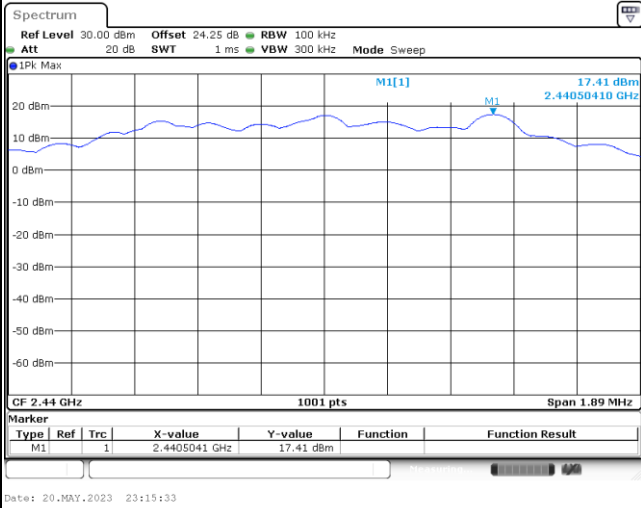

Low Channel Plot

Spurious Emission 30MHz~3GHz Plot

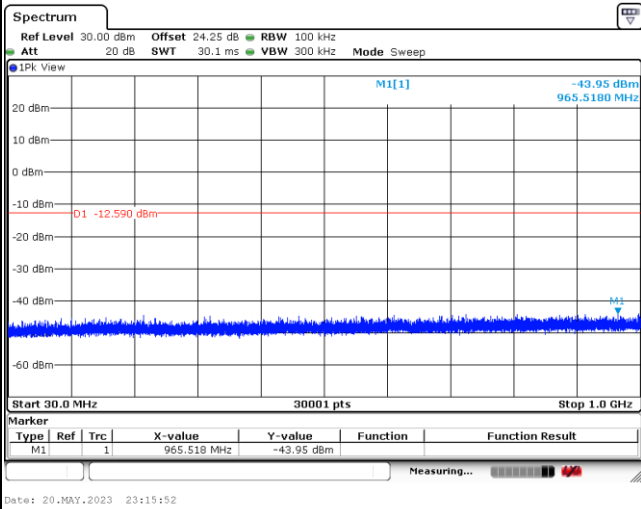

Spurious Emission 2GHz~25GHz Plot

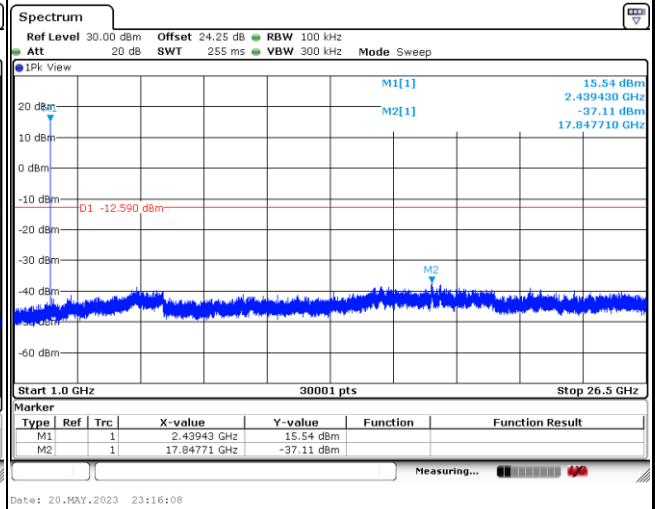



<2Mbps> Channel 39

100kHz PSD reference Level Plot

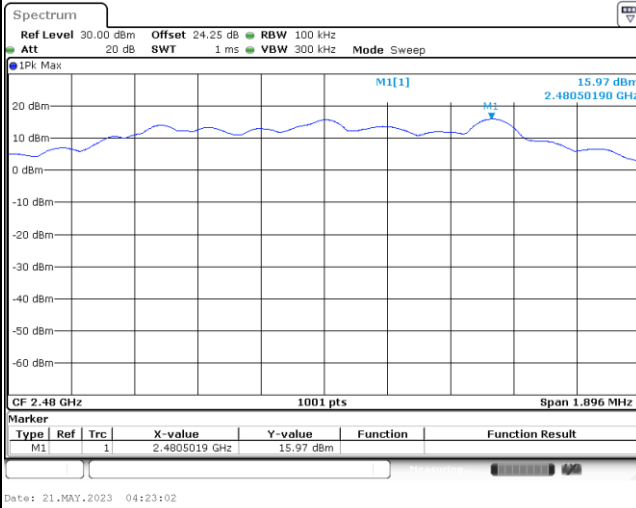

Low Channel Plot

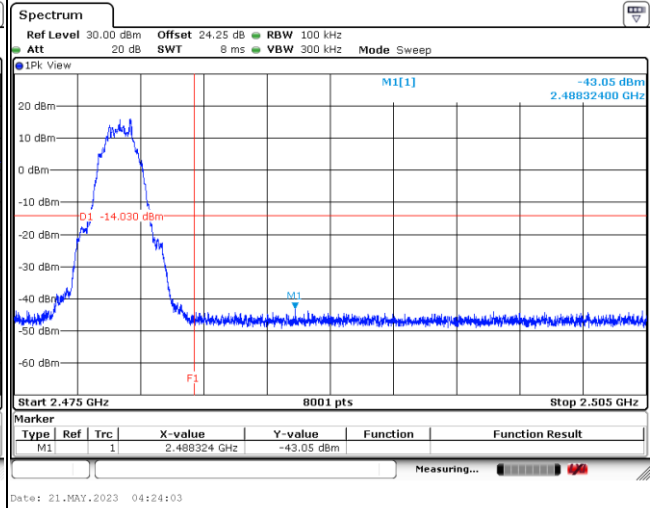

Spurious Emission 30MHz~1GHz Plot

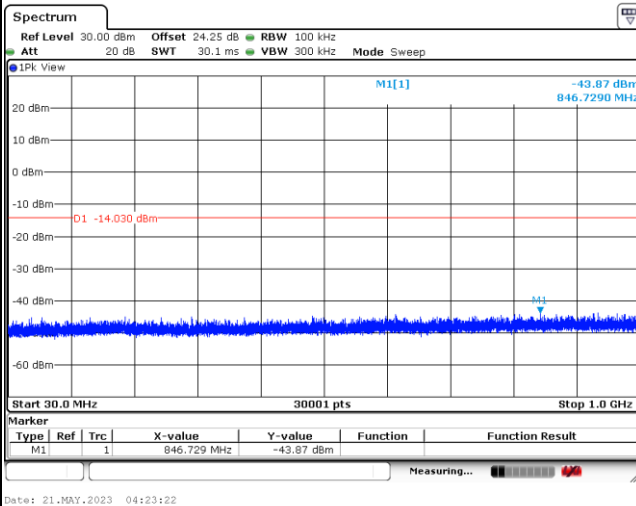

Spurious Emission 1GHz~26.5GHz Plot

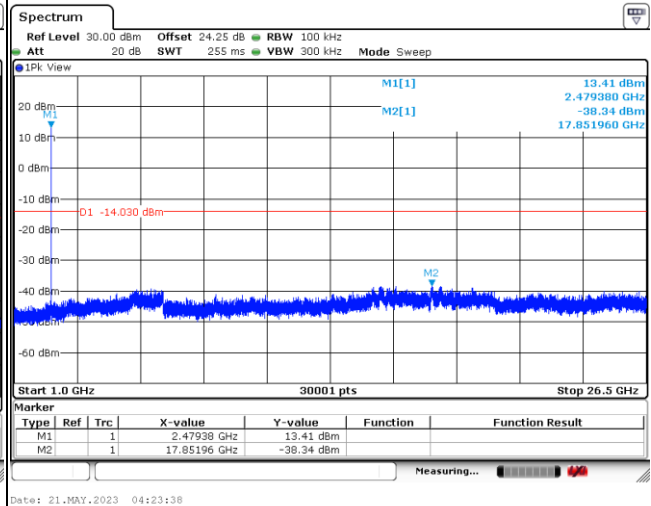



<HR Ant. 3>

6dB Bandwidth

<HR 4Mbps>

6 dB Bandwidth Plot on Channel 02

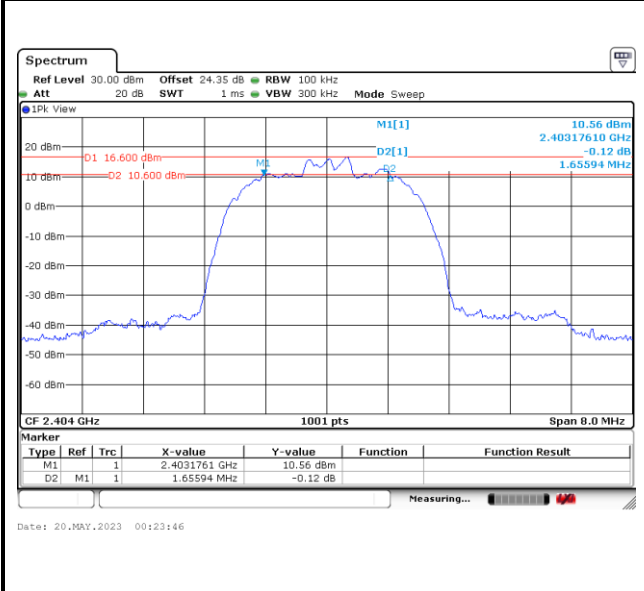

6 dB Bandwidth Plot on Channel 39

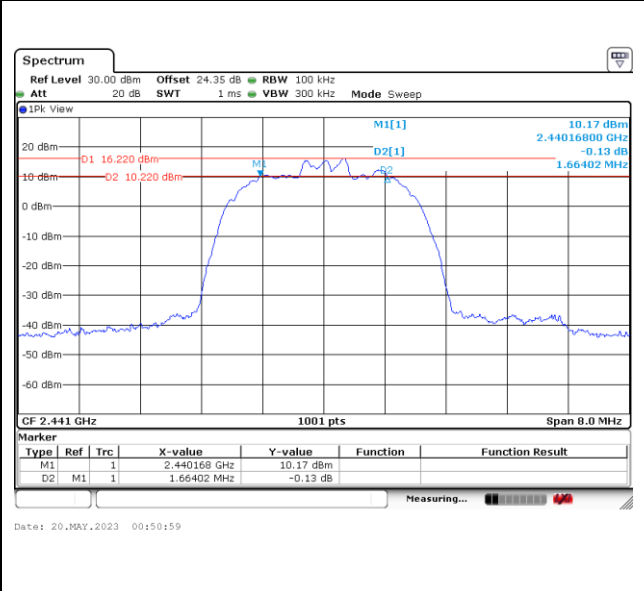

6 dB Bandwidth Plot on Channel 76

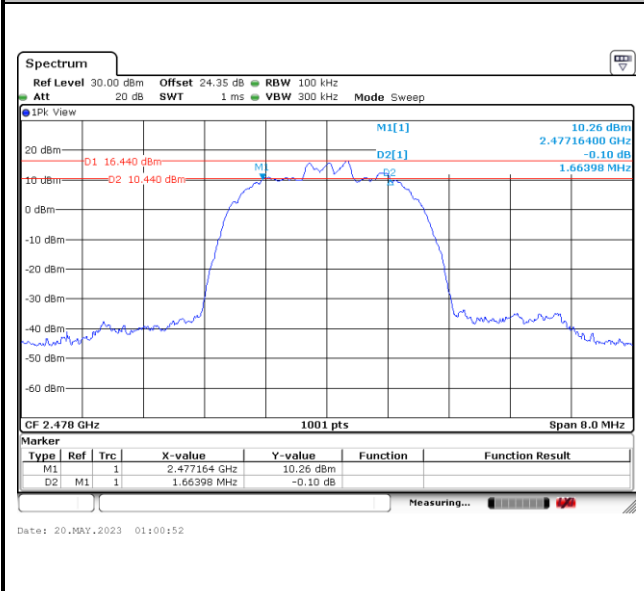



< HR 8Mbps >

6 dB Bandwidth Plot on Channel 20

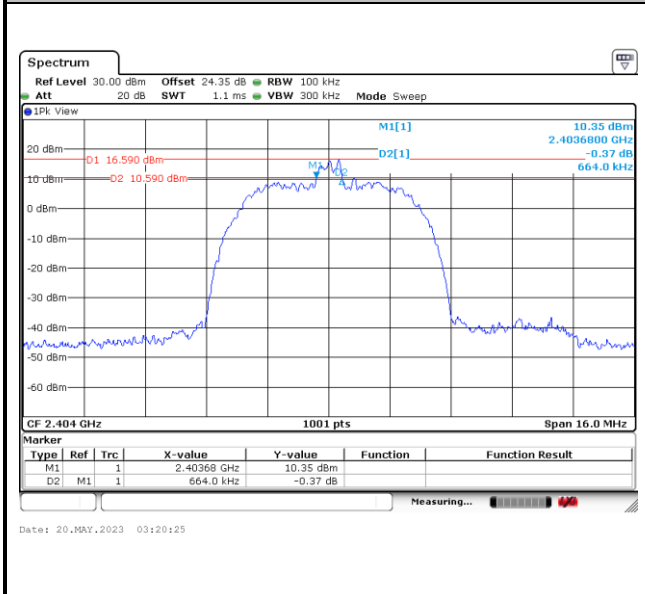

6 dB Bandwidth Plot on Channel 39

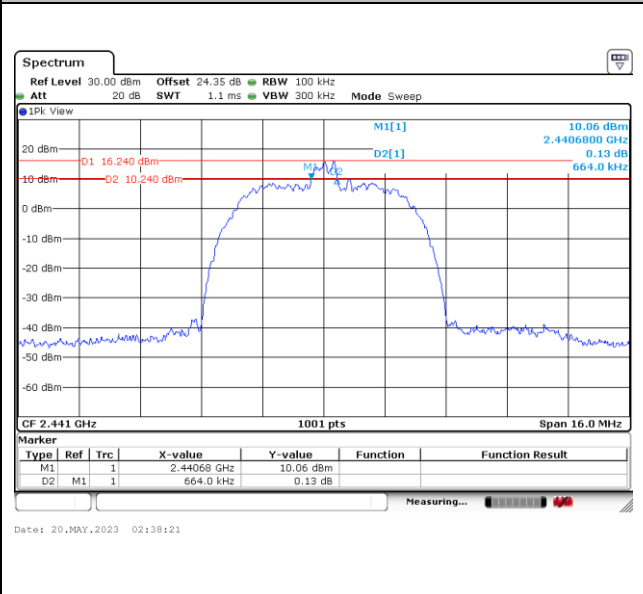

6 dB Bandwidth Plot on Channel 76

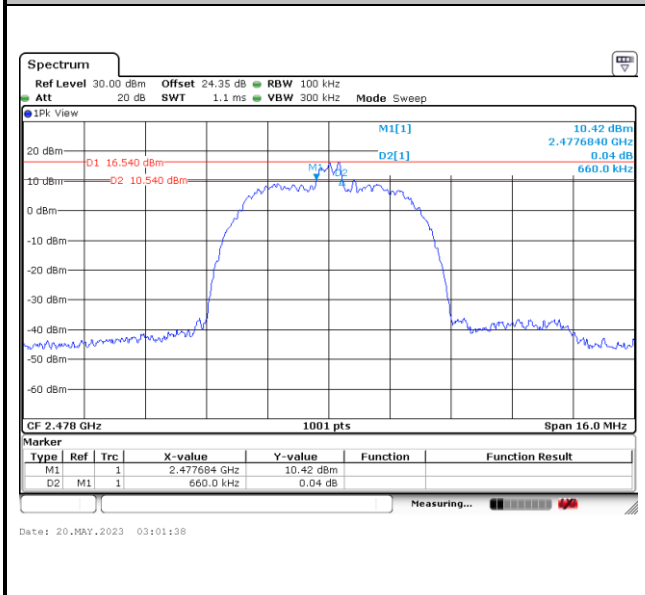



99% Occupied Bandwidth

< HR 4Mbps >

99% Occupied Bandwidth Plot on Channel 02

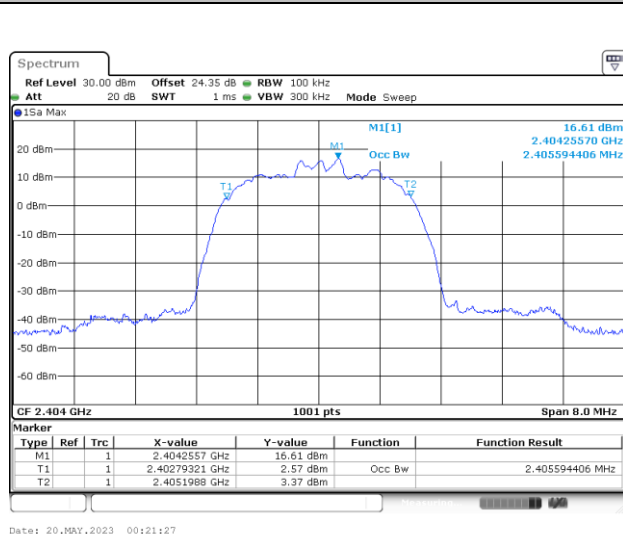

99% Occupied Plot Bandwidth on Channel 39

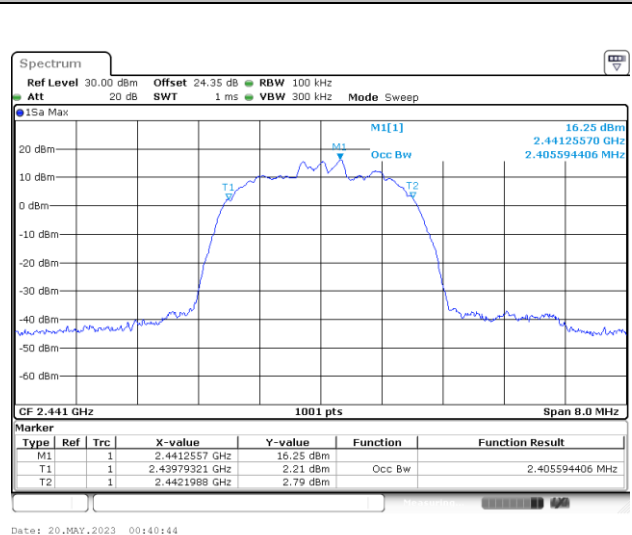

99% Occupied Bandwidth Plot on Channel 76

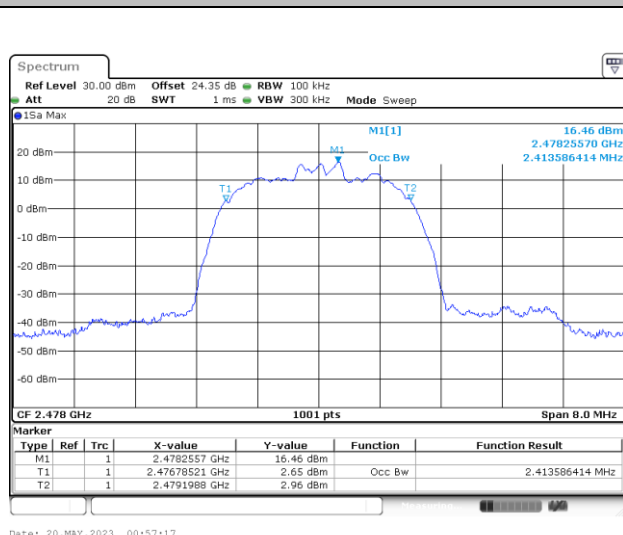

Note: The occupied channel bandwidth is maintained within the band of operation for all of the modulations.



< HR 8Mbps >

99% Occupied Bandwidth Plot on Channel 02

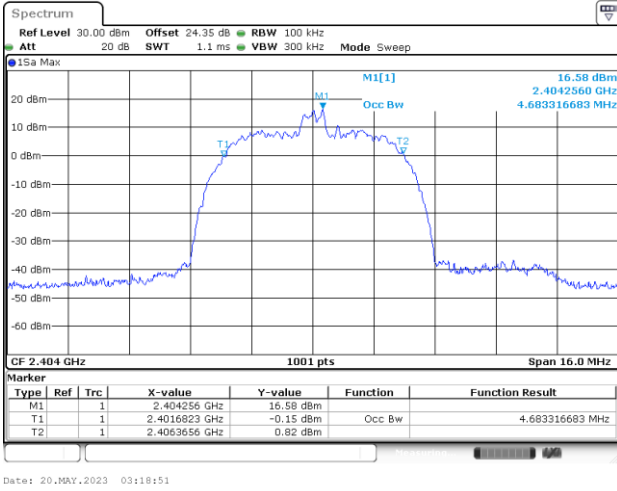

99% Occupied Plot Bandwidth on Channel 39

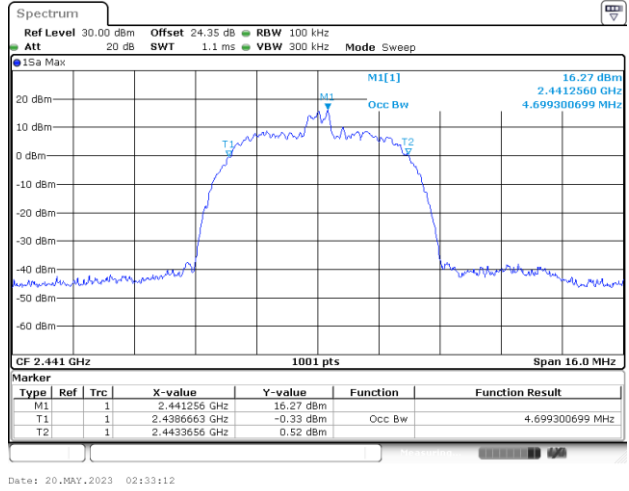

99% Occupied Bandwidth Plot on Channel 76

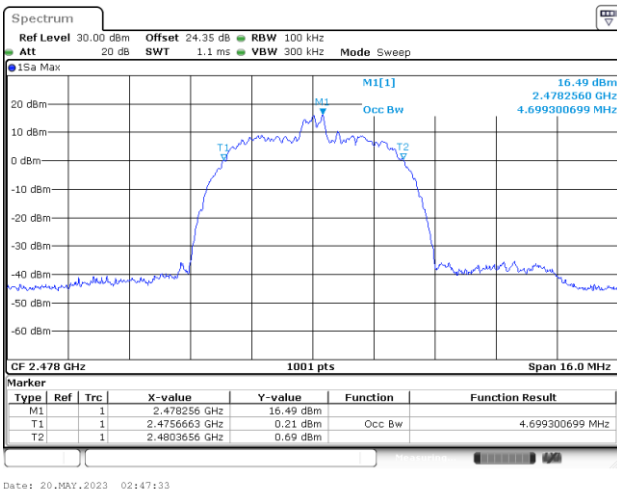



Power Spectral Density (dBm/3kHz)

< HR 4Mbps >

Power Density (dBm/3kHz) Plot Channel 02

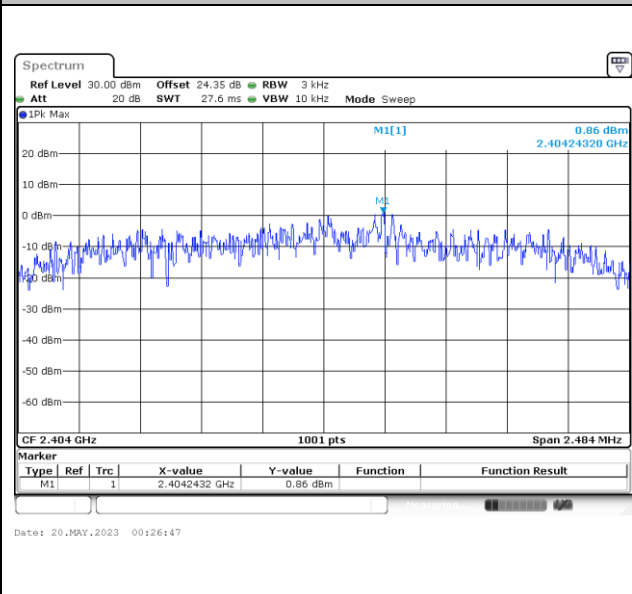

Power Density (dBm/3kHz) Plot Channel 39

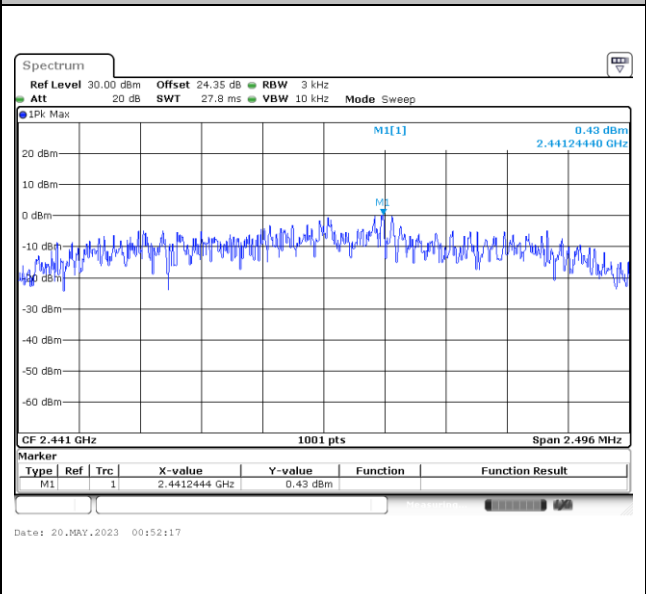

Power Density (dBm/3kHz) Plot Channel 76

