



FCC RADIO TEST REPORT

FCC ID : A4RG8HHN
Equipment : Phone
Model Name : G8HHN
Applicant : Google LLC
1600 Amphitheatre Parkway,
Mountain View, California, 94043 USA
Standard : FCC 47 CFR Part 2, 96

The product was received on Aug. 25, 2023 and testing was performed from Aug. 25, 2023 to Dec. 09, 2023. We, Sporton International Inc. EMC & Wireless Communications Laboratory, would like to declare that the tested sample has been evaluated in accordance with the test procedures given in ANSI / TIA-603-E and has been in compliance with the applicable technical standards.

The test results in this report apply exclusively to the tested model / sample. Without written approval of Sporton International Inc. EMC & Wireless Communications Laboratory, the test report shall not be reproduced except in full.

Louis Wu

Approved by: Louis Wu

Sporton International Inc. EMC & Wireless Communications Laboratory

No. 52, Huaya 1st Rd., Guishan Dist., Taoyuan City 333, Taiwan (R.O.C.)



Table of Contents

History of this test report.....	3
Summary of Test Result.....	4
1 General Description	5
1.1 Product Feature of Equipment Under Test	5
1.2 Modification of EUT	5
1.3 Testing Location	6
1.4 Applied Standards	6
2 Test Configuration of Equipment Under Test	7
2.1 Test Mode.....	7
2.2 Connection Diagram of Test System	8
2.3 Support Unit used in test configuration	9
2.4 Measurement Results Explanation Example	10
2.5 Frequency List of Low/Middle/High Channels.....	10
3 Conducted Test Items.....	11
3.1 Measuring Instruments.....	11
3.2 Conducted Output Power	12
3.3 Peak-to-Average Ratio	13
3.4 EIRP	14
3.5 Occupied Bandwidth	15
3.6 Conducted Band Edge	16
3.7 Conducted Spurious Emission	17
3.8 Frequency Stability.....	18
4 Radiated Test Items	19
4.1 Measuring Instruments.....	19
4.2 Test Setup	19
4.3 Test Result of Radiated Test.....	20
4.4 Radiated Spurious Emission	21
5 List of Measuring Equipment.....	22
6 Measurement Uncertainty	24
Appendix A. Test Results of Conducted Test	
Appendix B. Test Results of Radiated Test	
Appendix C. Test Setup Photographs	



History of this test report

Report No.	Version	Description	Issue Date
FG380306G	01	Initial issue of report	Nov. 02, 2023
FG380306G	02	Revise Section 2.1, List of Measuring Equipment and Appendix A This report is an updated version, replacing the report issued on Dec. 01, 2023.	Dec. 07, 2023
FG380306G	03	Add Radiated Spurious Emission test data This report is an updated version, replacing the report issued on Dec. 07, 2023.	Dec. 11, 2023



Summary of Test Result

Report Clause	Ref Std. Clause	Test Items	Result (PASS/FAIL)	Remark
3.2	§2.1046	Conducted Output Power	Reporting only	-
3.3	§96.41	Peak-to-Average Ratio	Pass	-
3.4	§96.41	Effective Isotropic Radiated Power	Pass	-
3.5	§2.1049 §96.41	Occupied Bandwidth	Reporting only	-
3.6	§2.1051 §96.41	Conducted Band Edge Measurement	Pass	-
3.7	§2.1051 §96.41	Conducted Spurious Emission	Pass	-
3.8	§2.1055	Frequency Stability for Temperature & Voltage	Pass	-
4.4	§2.1051 §96.41	Radiated Spurious Emission	Pass	9.06 dB under limit at 10653.00 MHz for Tx0 3.16 dB under limit at 7362.00 MHz for Tx1

Conformity Assessment Condition:

- The test results (PASS/FAIL) with all measurement uncertainty excluded are presented against the regulation limits or in accordance with the requirements stipulated by the applicant/manufacturer who shall bear all the risks of non-compliance that may potentially occur if measurement uncertainty is taken into account.
- The measurement uncertainty please refer to each test result in the section "Measurement Uncertainty".

Disclaimer:

The product specifications of the EUT presented in the test report that may affect the test assessments are declared by the manufacturer who shall take full responsibility for the authenticity.

Reviewed by: William Chen

Report Producer: Michelle Chen



1 General Description

1.1 Product Feature of Equipment Under Test

Product Feature
<p>General Specs GSM/WCDMA/LTE/5G NR, Bluetooth, BLE, BLE channel sounding, Wi-Fi 2.4GHz 802.11b/g/n/ac/ax, Wi-Fi 5GHz 802.11a/n/ac/ax, Wi-Fi 6GHz 802.11a/ax, NFC, WPC Rx and GNSS Rx.</p> <p>Antenna Type WWAN: <Ant. 0>: ILA Antenna <Ant. 1>: ILA Antenna <Ant. 2>: IFA Antenna <Ant. 5>: IFA Antenna <Ant. 6>: IFA Antenna</p>

Remark: The above EUT's information was declared by manufacturer. Please refer to Disclaimer in report summary.

TDD band Power Class				
	PC3	PC2		
n48	V			

Antenna information							
Band	Ant0	Ant1	Ant2	Ant5	Ant6	Main Ant. #	Sub Ant. #
n48			-3.5		-2.5	6	2

Remark:

- For Test Items, Main Ant. means Tx0 and Sub Ant. means Tx1.
- After preliminary scan, the main antenna Ant6 is selected as the worst mode to be reported for conducted test" in the test report.

EUT Information List	
S/N	Performed Test Item
38011JEKB00251	Conducted Measurement EIRP
38031JEKB01525	Radiated Spurious Emission

1.2 Modification of EUT

No modifications are made to the EUT during all test items.



1.3 Testing Location

Test Site	Sporton International Inc. EMC & Wireless Communications Laboratory
Test Site Location	No.52, Huaya 1st Rd., Guishan Dist., Taoyuan City 333, Taiwan (R.O.C.) TEL: +886-3-327-3456 FAX: +886-3-328-4978
Test Site No.	Sporton Site No.
	TH03-HY
Test Engineer	Sherry Wu
Temperature (°C)	20~24
Relative Humidity (%)	43~58

Test Site	Sporton International Inc. Wensan Laboratory
Test Site Location	No.58, Aly. 75, Ln. 564, Wenhua 3rd, Rd., Guishan Dist., Taoyuan City 333010, Taiwan (R.O.C.) TEL: +886-3-327-0868 FAX: +886-3-327-0855
Test Site No.	Sporton Site No.
	03CH12-HY (TAF Code: 3786)
Test Engineer	Wilson Wu, Jesse Fan and Tim Lee
Temperature (°C)	20~25
Relative Humidity (%)	50~60
Remark	The Radiated Spurious Emission test item subcontracted to Sporton International Inc. Wensan Laboratory.

Note: The test site complies with ANSI C63.4 2014 requirement.

FCC Designation No.: TW1190 and TW3786

1.4 Applied Standards

According to the specifications of the manufacturer, the EUT must comply with the requirements of the following standards:

- ♦ ANSI C63.26-2015
- ♦ ANSI / TIA-603-E
- ♦ FCC 47 CFR Part 2, 96
- ♦ FCC KDB 971168 D01 Power Meas. License Digital Systems v03r01
- ♦ FCC KDB 940660 D01 Part 96 CBRS Eqpt v03
- ♦ FCC KDB 412172 D01 Determining ERP and EIRP v01r01
- ♦ FCC KDB 414788 D01 Radiated Test Site v01r01
- ♦ FCC KDB 662911 D01 Multiple Transmitter Output v02r01.

Remark:

1. All test items were verified and recorded according to the standards and without any deviation during the test.
2. The TAF code is not including all the FCC KDB listed without accreditation.

2 Test Configuration of Equipment Under Test

2.1 Test Mode

Antenna port conducted and radiated test items listed below are performed according to KDB 971168 D01 Power Meas. License Digital Systems v03r01 with maximum output power.

For radiated measurement, the measured emission level of the EUT was maximized by rotating the EUT on a turntable, adjusting the orientation of the EUT and EUT antenna in three orthogonal axis (X: flat, Y: portrait, Z: landscape), and accessory (Adapter or Earphone) and adjusting the measurement antenna orientation, following C63.26 exploratory test procedures and find **<Tx0 Antenna>**: Y plane with Earphone for 5G NR n48 and EN-DC 66A-n48A; **<Tx1 Antenna>**: X plane without Accessory for 5G NR n48, Z plane with Adapter for EN-DC 66A-n48A as worst plane.

Modulation Type	Modulation	Modulation Type	Modulation
A	DFT-s-OFDM pi/2 BPSK	N/A	N/A
B	DFT-s-OFDM QPSK	F	CP-OFDM QPSK
C	DFT-s-OFDM 16QAM	G	CP-OFDM 16QAM
D	DFT-s-OFDM 64QAM	H	CP-OFDM 64QAM
E	DFT-s-OFDM 256QAM	I	CP-OFDM 256QAM

Test Item	Modulation Type	Bandwidth	RB Size	Channel
Conducted Power	A, B, C, D, E	All	1, Half, Full	L, M, H
EIRP	A, B, C, D, E	All	1, Half, Full	L, M, H
PAR	A, B, C, D, E	20 MHz or less	Outer_Full	M
Bandwidth	A, F, G, H, I	All	Outer_Full	M
ACLR, Mask (Part 96)	A, B, C, D, E, F	10 / 40 MHz	Outer_1RB	L, M, H
		All	Outer_Full	
CSE	B	Minimum	Inner_1RB	L, M, H
Frequency Stability	A	20 MHz or less	Outer_Full	M
RSE	A or B	20 MHz or less	Inner_1RB	L, M, H

Remark:

1. Evaluated all the transmitter signal and reporting worst-case configuration among all modulation types.
2. The device is investigated from 30MHz to 10 times of fundamental signal for radiated spurious emission test under different RB size/offset and modulations in exploratory test. Subsequently, only the worst-case emissions are reported.
3. For 5G NR test combination is EN-DC 66A_n48A.
4. During the RSE preliminary test, the standalone mode and charging modes (Adapter mode and WPC Rx mode) were verified. It is determined that the adapter mode is the worst case for the official test.
5. All the radiated test cases were performed with Adapter 1 and USB Cable 3.

2.2 Connection Diagram of Test System

<EUT with Adapter>

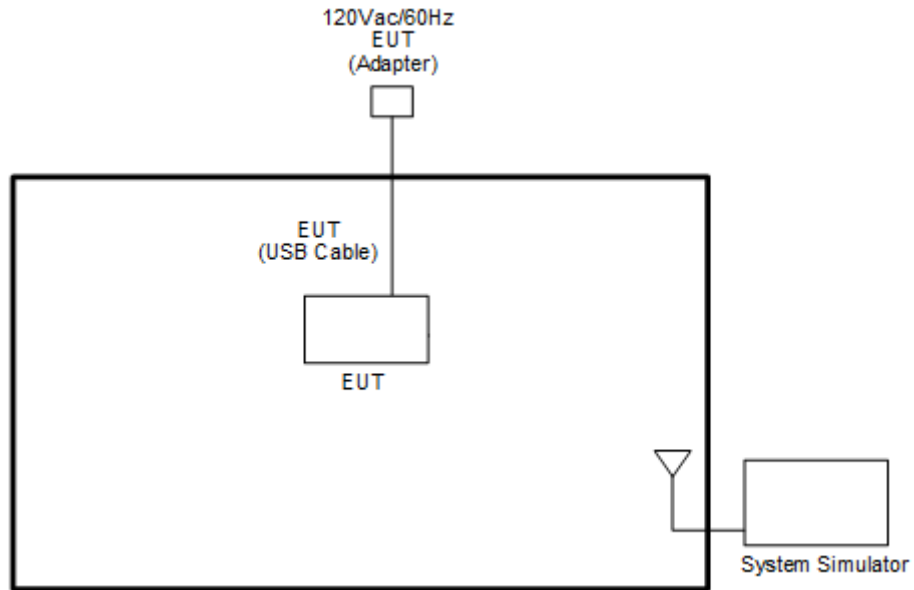

<EUT with Earphone>

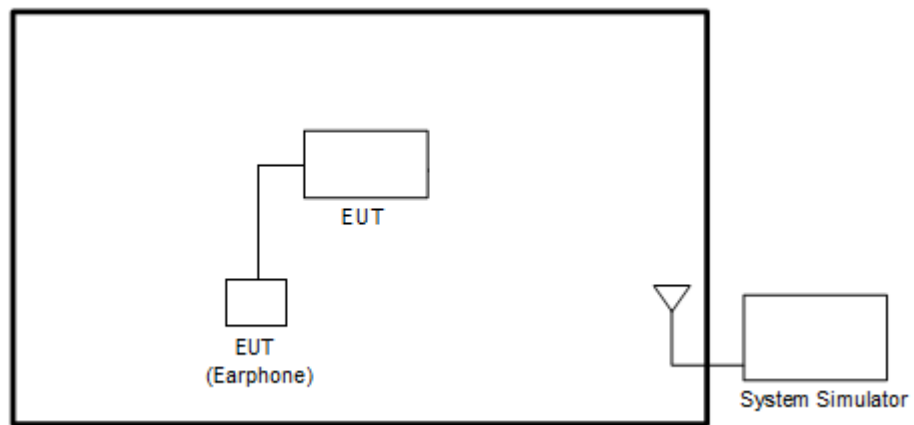

<EUT without Accessory>

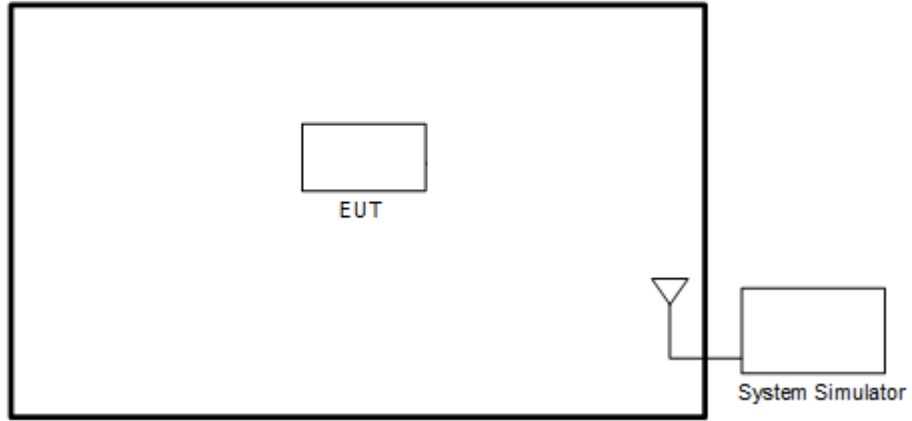

2.3 Support Unit used in test configuration

Item	Equipment	Brand Name	Model No.	FCC ID	Data Cable	Power Cord
1.	5G Wireless Test Platform	Anritsu	MT8000A	N/A	N/A	Unshielded, 1.8 m



2.4 Measurement Results Explanation Example

For all conducted test items:

The offset level is set in the spectrum analyzer to compensate the RF cable loss and attenuator factor between EUT conducted output port and spectrum analyzer. With the offset compensation, the spectrum analyzer reading level is exactly the EUT RF output level.

The spectrum analyzer offset is derived from RF cable loss and attenuator factor.

$$\text{Offset} = \text{RF cable loss} + \text{attenuator factor}.$$

Following shows an offset computation example with cable loss 4.2 dB and 10dB attenuator.

Example :

$$\begin{aligned} \text{Offset(dB)} &= \text{RF cable loss(dB)} + \text{attenuator factor(dB)}. \\ &= 4.2 + 10 = 14.2 \text{ (dB)} \end{aligned}$$

2.5 Frequency List of Low/Middle/High Channels

5G NR n48 Channel and Frequency List				
BW [MHz]	Channel/Frequency(MHz)	Lowest	Middle	Highest
40	Channel	638000	641666	645332
	Frequency	3570	3624.99	3679.98
20	Channel	637334	641666	646000
	Frequency	3560.01	3624.99	3690
15	Channel	637168	641666	646166
	Frequency	3557.52	3624.99	3692.49
10	Channel	637000	641666	646332
	Frequency	3555	3624.99	3694.98

3 Conducted Test Items

3.1 Measuring Instruments

See list of measuring instruments of this test report.

3.1.1 Test Setup

3.1.2 Conducted Output Power



3.1.3 Peak-to-Average Ratio, Occupied Bandwidth, Conducted Band Edge and Conducted Spurious Emission



3.1.4 Frequency Stability

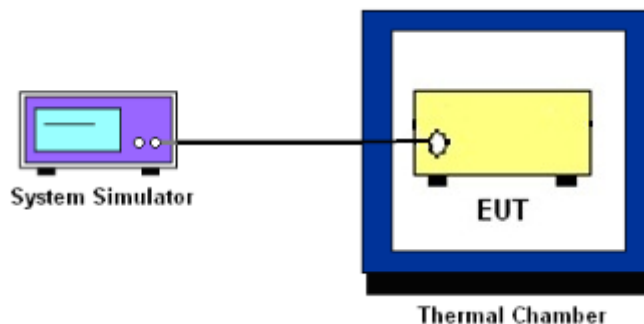

3.1.5 Test Result of Conducted Test

Please refer to Appendix A.



3.2 Conducted Output Power

3.2.1 Description of the Conducted Output Power Measurement

A system simulator was used to establish communication with the EUT. Its parameters were set to force the EUT transmitting at maximum output power. The measured power in the radio frequency on the transmitter output terminals shall be reported.

3.2.2 Test Procedures

1. The transmitter output port was connected to the system simulator.
2. Set EUT at maximum power through the system simulator.
3. Select lowest, middle, and highest channels for each band and different modulation.
4. Measure and record the power level from the system simulator.



3.3 Peak-to-Average Ratio

3.3.1 Description of the PAR Measurement

Power Complementary Cumulative Distribution Function (CCDF) curves provide a means for characterizing the power peaks of a digitally modulated signal on a statistical basis. A CCDF curve depicts the probability of the peak signal amplitude exceeding the average power level. Most contemporary measurement instrumentation include the capability to produce CCDF curves for an input signal provided that the instrument's resolution bandwidth can be set wide enough to accommodate the entire input signal bandwidth. In measuring transmissions in this band using an average power technique, the peak-to-average ratio (PAR) of the transmission may not exceed 13 dB.

3.3.2 Test Procedures

The testing follows ANSI C63.26-2015 Section 5.2.6

1. The EUT was connected to spectrum and system simulator via a power divider.
2. Set the CCDF (Complementary Cumulative Distribution Function) option in spectrum analyzer.
3. The highest RF powers were measured and recorded the maximum PAPR level associated with a probability of 0.1 %.
4. Record the deviation as Peak to Average Ratio



3.4 EIRP

3.4.1 Description of the EIRP Measurement

The EIRP of mobile transmitters must not exceed 23 dBm /10 megahertz for 5G NR n48.

The testing follows ANSI C63.26-2015 Section 5.2.5.5

According to KDB 412172 D01 Power Approach,

$EIRP = P_T + G_T - LC$, where

P_T = transmitter output power in dBm

G_T = gain of the transmitting antenna in dBi

LC = signal attenuation in the connecting cable between the transmitter and antenna in dB

Device	Maximum EIRP (dBm/10 MHz)	Maximum PSD (dBm/MHz)
End User Device	23	n/a

3.4.2 Test Procedures

1. The testing follows procedure in Section 5.2 of ANSI C63.26-2015 and KDB 940660 D01 Part 96 CBRS Eqpt v03 Section 3.2(b)(2) and 3.2(b)(3)
2. Determine the EIRP by adding the effective antenna gain to the measured average conducted power level.



3.5 Occupied Bandwidth

3.5.1 Description of Occupied Bandwidth Measurement

The occupied bandwidth is the width of a frequency band such that, below the lower and above the upper frequency limits, the mean powers emitted are each equal to a specified percentage 0.5% of the total mean transmitted power.

The 26 dB emission bandwidth is defined as the frequency range between two points, one above and one below the carrier frequency, at which the spectral density of the emission is attenuated 26 dB below the maximum in-band spectral density of the modulated signal. Spectral density (power per unit bandwidth) is to be measured with a detector of resolution bandwidth equal to approximately 1.0% of the emission bandwidth.

3.5.2 Test Procedures

The testing follows ANSI C63.26-2015 Section 5.4.3 (26dB) and Section 5.4.4 (99OB)

1. The EUT was connected to spectrum analyzer and system simulator via a power divider.
2. The spectrum analyzer center frequency is set to the nominal EUT channel center frequency. The span range for the spectrum analyzer shall be between two and five times the anticipated OBW.
3. The nominal resolution bandwidth (RBW) shall be in the range of 1 to 5 % of the anticipated OBW, and the VBW shall be at least 3 times the RBW.
4. Set the detection mode to peak, and the trace mode to max hold.
5. Determine the reference value: Set the EUT to transmit a modulated signal. Allow the trace to stabilize. Set the spectrum analyzer marker to the highest level of the displayed trace.
(this is the reference value)
6. Determine the "-26 dB down amplitude" as equal to (Reference Value - X).
7. Place two markers, one at the lowest and the other at the highest frequency of the envelope of the spectral display such that each marker is at or slightly below the "-X dB down amplitude" determined in step 6. If a marker is below this "-X dB down amplitude" value it shall be placed as close as possible to this value. The OBW is the positive frequency difference between the two markers.
8. Use the 99 % power bandwidth function of the spectrum analyzer and report the measured bandwidth.



3.6 Conducted Band Edge

3.6.1 Description of Conducted Band Edge Measurement

The conducted power of any End User Device emission outside the fundamental emission (whether in or outside of the authorized band) shall not exceed -13 dBm/MHz within 0 to B megahertz (where B is the bandwidth in megahertz of the assigned channel or multiple contiguous channels of the End User Device) above the upper CBSD-assigned channel edge and within 0 to B megahertz below the lower CBSD-assigned channel edge. At all frequencies greater than B megahertz above the upper CBSD assigned channel edge and less than B megahertz below the lower CBSD-assigned channel edge, the conducted power of any End User Device emission shall not exceed -25 dBm/MHz. Notwithstanding the emission limits in this paragraph, the Adjacent Channel Leakage Ratio for End User Devices shall be at least 30 dB.

3.6.2 Test Procedures

The testing follows FCC KDB 971168 D01 v03r01 Section 6.1.

1. The EUT was connected to spectrum analyzer and system simulator via a power divider.
2. The band edges of low and high channels for the highest RF powers were measured.
3. Set RBW \geq 1% EBW in the 1MHz band immediately outside and adjacent to the band edge.
4. Beyond the 1 MHz band from the band edge, RBW=1MHz was used
5. Set spectrum analyzer with RMS detector.
6. The RF fundamental frequency should be excluded against the limit line in the operating frequency band.

For Adjacent Channel Leakage Ratio (ACLR) measurement,

7. The Adjacent Channel Leakage Ratio (ACLR) is the ratio of the average power in the assigned aggregated channel bandwidth to the average power over the equivalent adjacent channel bandwidth.
8. The option ACLR of spectrum analyzer is used and measures the ACLR ratio by setting equivalent channel bandwidth.
9. The measured ACLR ratio shall be at least 30 dB.



3.7 Conducted Spurious Emission

3.7.1 Description of Conducted Spurious Emission Measurement

96.41 (e)(2)

The conducted power of any emissions below 3530 MHz or above 3720 MHz shall not exceed -40dBm/MHz.

3.7.2 Test Procedures

The testing follows FCC KDB 971168 D01 v03r01 Section 6.1.

1. The EUT was connected to spectrum analyzer and system simulator via a power divider.
2. The RF output of EUT was connected to the spectrum analyzer by RF cable and attenuator. The path loss was compensated to the results for each measurement.
3. The middle channel for the highest RF power within the transmitting frequency was measured.
4. The conducted spurious emission for the whole frequency range was taken.
5. Make the measurement with the spectrum analyzer's RBW = 1MHz, VBW = 3MHz.
6. Set spectrum analyzer with RMS detector.
7. Taking the record of maximum spurious emission.
8. The RF fundamental frequency should be excluded against the limit line in the operating frequency band.
9. The limit line is -40dBm/MHz.



3.8 Frequency Stability

3.8.1 Description of Frequency Stability Measurement

The frequency stability shall be measured by variation of ambient temperature and variation of primary supply voltage to ensure that the fundamental emission stays within the authorized frequency block.

3.8.2 Test Procedures for Temperature Variation

The testing follows FCC KDB 971168 D01 v03r01 Section 9.0.

1. The EUT was set up in the thermal chamber and connected with the system simulator.
2. With power OFF, the temperature was decreased to -30°C and the EUT was stabilized before testing. Power was applied and the maximum change in frequency was recorded within one minute.
3. With power OFF, the temperature was raised in 10°C step up to 50°C. The EUT was stabilized at each step for at least half an hour. Power was applied and the maximum frequency change was recorded within one minute.

3.8.3 Test Procedures for Voltage Variation

The testing follows FCC KDB 971168 D01 v03r01 Section 9.0.

1. The EUT was placed in a temperature chamber at 25±5° C and connected with the system simulator.
2. The power supply voltage to the EUT was varied from 85% to 115% of the nominal value measured at the input to the EUT.
3. The variation in frequency was measured for the worst case.

4 Radiated Test Items

4.1 Measuring Instruments

See list of measuring instruments of this test report.

4.2 Test Setup

For radiated emissions below 30MHz

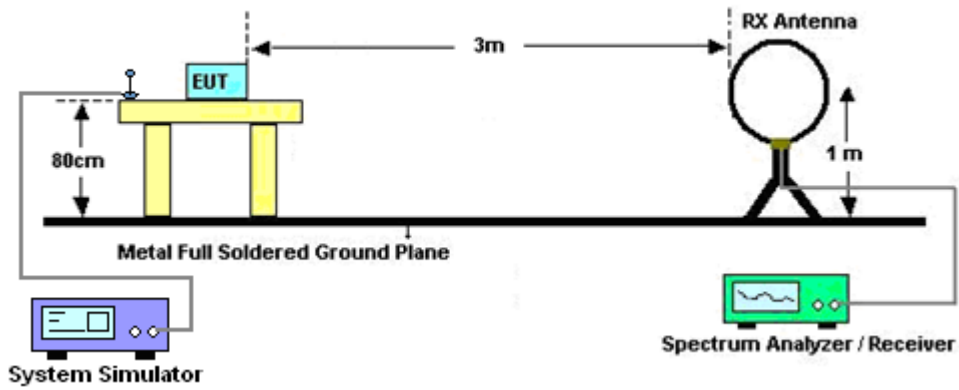

For radiated emissions from 30MHz to 1GHz

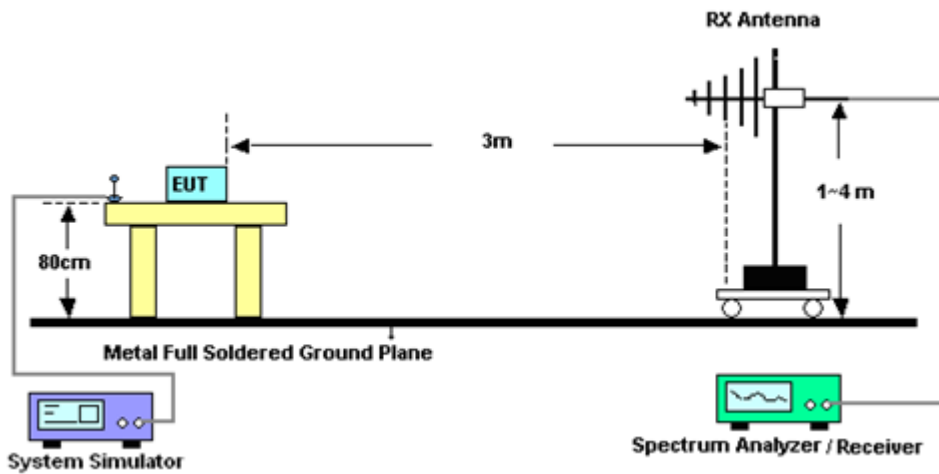

For radiated emissions from 1GHz to 18GHz

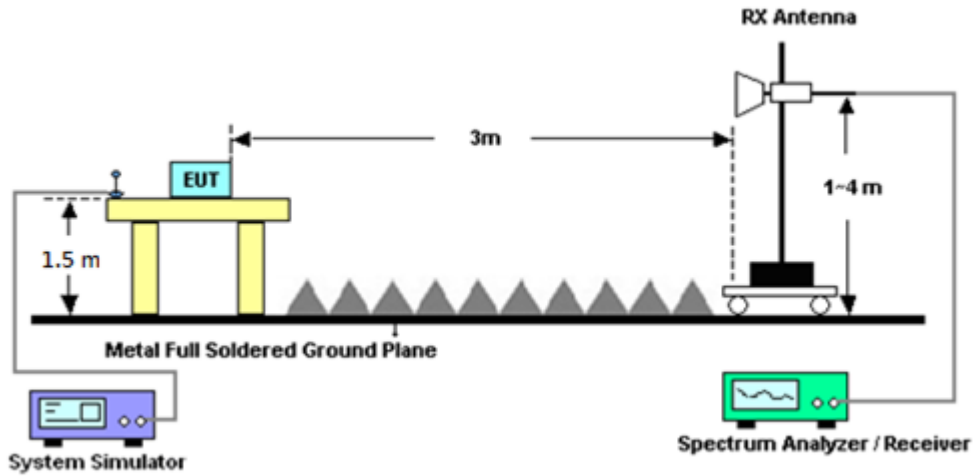

For radiated emissions above 18GHz

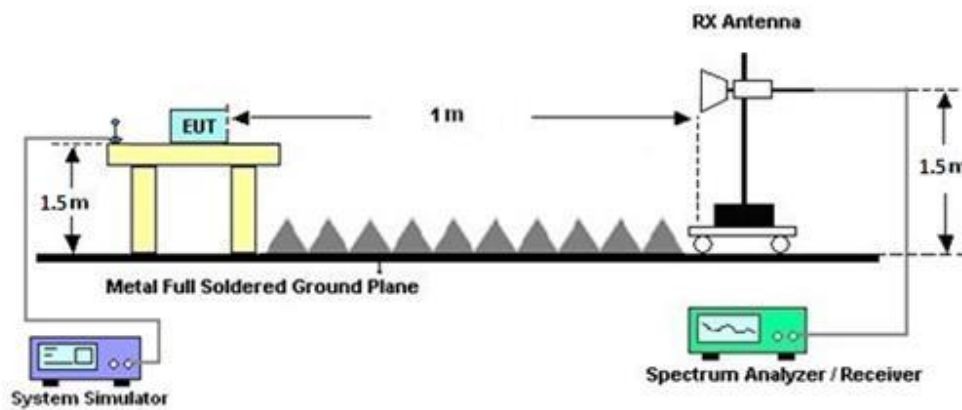

4.3 Test Result of Radiated Test

Please refer to Appendix B.

Note:

The low frequency, which started from 9 kHz to 30MHz, was pre-scanned and the result which was 20dB lower than the limit line was not reported.

There is adequate comparison measurement of both open-field test site and alternative test site - semi-Anechoic chamber according to 414788 D01 Radiated Test Site v01r01, and the result came out very similar.



4.4 Radiated Spurious Emission

4.4.1 Description of Radiated Spurious Emission Measurement

The radiated spurious emission was measured by substitution method according to ANSI / TIA-603-E. The power of any emission outside of the authorized operating frequency ranges must be attenuated below the transmitter power (P) by a factor of at least -40dBm / MHz .

The spectrum is scanned from 30 MHz up to a frequency including its 10th harmonic.

4.4.2 Test Procedures

The testing follows FCC KDB 971168 D01 v03r01 Section 7 and ANSI C63.26-2015 section 5.5.4 Radiated measurement using the field strength method.

1. The EUT was placed on a turntable with 0.8 meter height for frequency below 1GHz and 1.5 meter height for frequency above 1GHz respectively above ground.
2. The EUT was set 3 meters from the receiving antenna mounted on the antenna tower.
3. The table was rotated 360 degrees to determine the position of the highest spurious emission.
4. The height of the receiving antenna is varied between 1m to 4m to search the maximum spurious emission for both horizontal and vertical polarizations.
5. During the measurement, the system simulator parameters were set to force the EUT transmitting at maximum output power.
6. Make the measurement with the spectrum analyzer's RBW = 1MHz, VBW = 3MHz, taking the record of maximum spurious emission.
7. To convert spectrum reading E(dBuV/m) to EIRP(dBm)
$$\text{EIRP(dBm)} = \text{Level (dBuV/m)} + 20\log(d) - 104.77$$
, where d is the distance at which filed strength limit is specified in the rules
8. Field Strength Level (dBm) = Spectrum Reading (dBm) + Antenna Factor + Cable Loss + Read Level - Preamp Factor.
9. ERP (dBm) = EIRP - 2.15
10. The RF fundamental frequency should be excluded against the limit line in the operating frequency band.



5 List of Measuring Equipment

Instrument	Brand Name	Model No.	Serial No.	Characteristics	Calibration Date	Test Date	Due Date	Remark
Loop Antenna	Rohde & Schwarz	HFH2-Z2	100315	9 kHz~30 MHz	Feb. 28, 2023	Aug. 29, 2023~ Dec. 09, 2023	Feb. 27, 2024	Radiation (03CH12-HY)
Bilog Antenna	TESEQ	CBL 6111D & 00800N1D01N -06	37059 & 01	30MHz~1GHz	Nov. 10, 2022	Aug. 29, 2023~ Nov. 01, 2023	Nov. 09, 2023	Radiation (03CH12-HY)
Bilog Antenna	TESEQ	CBL 6111D & 00800N1D01N -06	37059 & 01	30MHz~1GHz	Nov. 03, 2023	Nov. 03, 2023~ Dec. 09, 2023	Nov. 02, 2024	Radiation (03CH12-HY)
Horn Antenna	SCHWARZBE CK	BBHA 9120 D	9120D-1241	1GHz~18GHz	Jul. 31, 2023	Aug. 29, 2023~ Dec. 09, 2023	Jul. 30, 2024	Radiation (03CH12-HY)
SHF-EHF Horn Antenna	SCHWARZBE CK	BBHA9170	00993	18GHz~40GHz	Nov. 24, 2022	Aug. 29, 2023~ Nov. 22, 2023	Nov. 23, 2023	Radiation (03CH12-HY)
SHF-EHF Horn Antenna	SCHWARZBE CK	BBHA9170	1224	18GHz~40GHz	Jul. 10, 2023	Nov. 23, 2023~ Dec. 09, 2023	Jul. 09, 2024	Radiation (03CH12-HY)
Preamplifier	COM-POWER	PAM-103	161075	10MHz~1GHz	Mar. 21, 2023	Aug. 29, 2023~ Dec. 09, 2023	Mar. 20, 2024	Radiation (03CH12-HY)
Preamplifier	Agilent	8449B	3008A02375	1GHz~26.5GHz	May 23, 2023	Aug. 29, 2023~ Dec. 09, 2023	May 22, 2024	Radiation (03CH12-HY)
Preamplifier	E-INSTRUME NT TECH LTD.	ERA-100M-18 G-56-01-A70	EC1900249	1GHz-18GHz	Dec. 21, 2022	Aug. 29, 2023~ Dec. 09, 2023	Dec. 20, 2023	Radiation (03CH12-HY)
Preamplifier	EMEC	EM18G40G	060715	18GHz~40GHz	Dec. 07, 2022	Aug. 29, 2023~ Dec. 05, 2023	Dec. 06, 2023	Radiation (03CH12-HY)
Preamplifier	EMEC	EM18G40G	060801	18GHz~40GHz	Jun. 27, 2023	Dec. 06, 2023~ Dec. 09, 2023	Jun. 26, 2024	Radiation (03CH12-HY)
Spectrum Analyzer	Agilent	N9010A	MY53470118	10Hz~44GHz	Jan. 10, 2023	Aug. 29, 2023~ Dec. 09, 2023	Jan. 09, 2024	Radiation (03CH12-HY)
Filter	Wainwright	WHKX8-5872. 5-6750-18000- 40ST	SN2	6.75GHz High Pass Filter	Mar. 14, 2023	Aug. 29, 2023~ Dec. 09, 2023	Mar. 13, 2024	Radiation (03CH12-HY)
RF Cable	HUBER + SUHNER	SUCOFLEX 102	803951/2	9kHz~30MHz	Mar. 07, 2023	Aug. 29, 2023~ Dec. 09, 2023	Mar. 06, 2024	Radiation (03CH12-HY)
RF Cable	HUBER + SUHNER	SUCOFLEX 126E	0058/126E	30MHz~18GHz	Dec. 20, 2022	Aug. 29, 2023~ Dec. 09, 2023	Dec. 19, 2023	Radiation (03CH12-HY)
RF Cable	HUBER + SUHNER	SUCOFLEX 102	505134/2	30MHz~40GHz	Dec. 20, 2022	Aug. 29, 2023~ Dec. 09, 2023	Dec. 19, 2023	Radiation (03CH12-HY)
RF Cable	HUBER + SUHNER	SUCOFLEX 102	803953/2	30MHz~40GHz	Dec. 20, 2022	Aug. 29, 2023~ Dec. 09, 2023	Dec. 19, 2023	Radiation (03CH12-HY)
Hygrometer	TECPEL	DTM-303B	TP161250	N/A	Jul. 26, 2023	Aug. 29, 2023~ Dec. 09, 2023	Jul. 25, 2024	Radiation (03CH12-HY)
Controller	EMEC	EM1000	N/A	Control Turn table & Ant Mast	N/A	Aug. 29, 2023~ Dec. 09, 2023	N/A	Radiation (03CH12-HY)
Antenna Mast	EMEC	AM-BS-4500-B	N/A	1m~4m	N/A	Aug. 29, 2023~ Dec. 09, 2023	N/A	Radiation (03CH12-HY)
Turn Table	EMEC	TT2000	N/A	0~360 Degree	N/A	Aug. 29, 2023~ Dec. 09, 2023	N/A	Radiation (03CH12-HY)
Software	Audix	E3 6.2009-8-24	RK-000989	N/A	N/A	Aug. 29, 2023~ Dec. 09, 2023	N/A	Radiation (03CH12-HY)



Instrument	Brand Name	Model No.	Serial No.	Characteristics	Calibration Date	Test Date	Due Date	Remark
Programmable Power Supply	GW Instek	GPE-2323	GET910884	0V~64V ;0A~6A	Dec. 21, 2022	Aug. 25, 2023~ Dec. 05, 2023	Dec. 20, 2023	Conducted (TH03-HY)
Signal Analyzer	Rohde & Schwarz	FSV3044	101048	10Hz~44GHz	May 03, 2023	Aug. 25, 2023~ Dec. 05, 2023	May 02, 2024	Conducted (TH03-HY)
Temperature Chamber	ESPEC	SH-241	92003713	-30°C ~90°C	May 17, 2023	Aug. 25, 2023~ Dec. 05, 2023	May 16, 2024	Conducted (TH03-HY)
Base Station (Measure)	Anritsu	MT8821C	6262116730	LTE	Jul. 10, 2023	Aug. 25, 2023~ Dec. 05, 2023	Jul. 09, 2024	Conducted (TH03-HY)
Base Station (Measure)	Anritsu	MT8000A	6262134933	FR1	Jul. 10, 2023	Aug. 25, 2023~ Dec. 05, 2023	Jul. 09, 2024	Conducted (TH03-HY)
Signal Analyzer	Rohde & Schwarz	FSW43	101456	RBW 50MHz	Feb. 23, 2023	Aug. 25, 2023~ Dec. 05, 2023	Feb. 22, 2024	Conducted (TH03-HY)



6 Measurement Uncertainty

Uncertainty of Radiated Emission Measurement (30 MHz ~ 1000 MHz)

Measuring Uncertainty for a Level of Confidence of 95% ($U = 2Uc(y)$)	3.07 dB
---	---------

Uncertainty of Radiated Emission Measurement (1 GHz ~ 18 GHz)

Measuring Uncertainty for a Level of Confidence of 95% ($U = 2Uc(y)$)	3.63 dB
---	---------

Uncertainty of Radiated Emission Measurement (18 GHz ~ 40 GHz)

Measuring Uncertainty for a Level of Confidence of 95% ($U = 2Uc(y)$)	4.14 dB
---	---------



Appendix A. Test Results of Conducted Test

Conducted Output Power(Average power) and EIRP

<Tx0 Antenna>

NR n48 Maximum Average Power [dBm] (GT - LC = -2.5 dB)										
BW [MHz]	RB Size	RB Offset	Mod	Lowest	Middle	Highest	EIRP (dBm)	EIRP(W)		
10	1	1	PI/2 BPSK	23.98	24.48	24.47	21.98	0.1578		
10	1	22		24.05	24.37	24.40				
10	12	6		24.06	24.40	24.41				
10	1	0		23.55	23.95	23.96				
10	1	23		23.59	23.82	23.93				
10	24	0		23.57	23.95	23.91				
10	1	1	QPSK	23.04	24.43	24.42			20.97	0.1250
10	1	22		24.11	24.32	24.35				
10	12	6		24.07	24.42	24.43				
10	1	0		23.08	23.45	23.42				
10	1	23		23.11	23.33	23.35				
10	24	0		23.07	23.41	23.41				
10	1	1	16-QAM	23.07	23.47	23.20	20.97	0.1250		
10	1	1	64-QAM	21.53	21.71	22.09				
10	1	1	256-QAM	19.63	19.93	19.96				
Limit	EIRP < 23dBm/10MHz			Result			Pass			

NR n48 Maximum Average Power [dBm] (GT - LC = -2.5 dB)										
BW [MHz]	RB Size	RB Offset	Mod	Lowest	Middle	Highest	EIRP (dBm)	EIRP(W)		
15	1	1	PI/2 BPSK	20.16	24.50	24.45	22.00	0.1585		
15	1	36		24.03	24.30	20.31				
15	18	9		24.19	24.45	24.35				
15	1	0		20.12	24.00	23.95				
15	1	37		23.60	23.80	20.32				
15	36	0		20.17	23.93	20.34				
15	1	1	QPSK	20.11	24.43	24.42			21.07	0.1279
15	1	36		24.04	24.23	20.26				
15	18	9		24.17	24.41	24.35				
15	1	0		20.13	23.46	23.46				
15	1	37		23.06	23.26	20.31				
15	36	0		20.18	23.43	20.37				
15	1	1	16-QAM	19.25	23.57	23.44	21.07	0.1279		
15	1	1	64-QAM	19.08	22.01	21.92				
15	1	1	256-QAM	19.63	20.02	19.89				
Limit	EIRP < 23dBm/10MHz			Result			Pass			

Total EIRP power is less than partial EIRP limit 23 dBm/10MHz.



NR n48 Maximum Average Power [dBm] (GT - LC = -2.5 dB)										
BW [MHz]	RB Size	RB Offset	Mod	Lowest	Middle	Highest	EIRP (dBm)	EIRP(W)		
20	1	1	PI/2 BPSK	20.28	24.47	24.50	22.02	0.1592		
20	1	49		24.11	24.21	20.29				
20	25	12		24.15	24.43	24.34				
20	1	0		20.17	24.01	24.04				
20	1	50		23.66	23.72	20.29				
20	50	0		20.19	23.93	20.32				
20	1	1	QPSK	20.18	24.52	24.42			20.99	0.1256
20	1	49		24.06	24.21	20.19				
20	25	12		24.22	24.43	24.32				
20	1	0		20.21	23.51	23.36				
20	1	50		23.09	23.21	20.25				
20	50	0		20.22	23.40	20.33				
20	1	1	16-QAM	19.38	23.43	23.49	20.99	0.1256		
20	1	1	64-QAM	19.26	21.89	21.83				
20	1	1	256-QAM	19.69	19.87	19.97				
Limit	EIRP < 23dBm/10MHz			Result			Pass			

NR n48 Maximum Average Power [dBm] (GT - LC = -2.5 dB)										
BW [MHz]	RB Size	RB Offset	Mod	Lowest	Middle	Highest	EIRP (dBm)	EIRP(W)		
40	1	1	PI/2 BPSK	13.84	20.49	14.09	21.92	0.1556		
40	1	104		13.40	19.96	13.80				
40	50	25		13.72	24.42	14.12				
40	1	0		13.82	20.45	14.04				
40	1	105		13.41	19.91	13.82				
40	100	0		13.66	19.91	14.00				
40	1	1	QPSK	10.36	20.48	10.52			18.19	0.0659
40	1	104		9.88	19.90	10.25				
40	50	25		10.21	24.42	10.56				
40	1	0		10.42	20.55	10.54				
40	1	105		9.88	19.93	10.27				
40	100	0		10.15	19.90	10.53				
40	1	1	16-QAM	10.41	20.69	10.67	18.19	0.0659		
40	1	1	64-QAM	10.39	20.48	10.65				
40	1	1	256-QAM	10.26	20.07	10.52				
Limit	EIRP < 23dBm/10MHz			Result			Pass			



<Tx1 Antenna>

NR n48 Maximum Average Power [dBm] (GT - LC = -3.5 dB)								
BW [MHz]	RB Size	RB Offset	Mod	Lowest	Middle	Highest	EIRP (dBm)	EIRP(W)
10	1	1	PI/2 BPSK	24.03	24.34	24.31	20.84	0.1213
10	1	22		24.06	24.10	24.16		
10	12	6		24.08	24.15	24.26		
10	1	0		23.56	23.79	23.80		
10	1	23		23.60	23.62	23.66		
10	24	0		23.60	23.63	23.72		
10	1	1	QPSK	24.08	24.26	24.27		
10	1	22		24.07	24.16	24.16		
10	12	6		24.15	24.22	24.26		
10	1	0		23.07	23.34	23.20		
10	1	23		23.04	23.18	23.15		
10	24	0		23.14	23.13	23.25		
10	1	1	16-QAM	23.20	23.44	23.25	19.94	0.0986
10	1	1	64-QAM	21.61	21.81	21.91		
10	1	1	256-QAM	19.62	19.69	19.66		
Limit	EIRP < 23dBm/10MHz			Result			Pass	

NR n48 Maximum Average Power [dBm] (GT - LC = -3.5 dB)								
BW [MHz]	RB Size	RB Offset	Mod	Lowest	Middle	Highest	EIRP (dBm)	EIRP(W)
15	1	1	PI/2 BPSK	20.09	24.33	24.18	20.83	0.1211
15	1	36		23.96	24.15	20.06		
15	18	9		24.15	24.13	24.12		
15	1	0		20.14	23.79	23.71		
15	1	37		23.42	23.60	20.06		
15	36	0		20.16	23.63	20.17		
15	1	1	QPSK	20.11	24.28	24.16		
15	1	36		23.94	24.06	20.04		
15	18	9		24.12	24.14	24.16		
15	1	0		20.08	23.28	23.12		
15	1	37		22.91	23.04	20.03		
15	36	0		20.15	23.12	20.14		
15	1	1	16-QAM	19.24	23.29	23.07	19.79	0.0953
15	1	1	64-QAM	19.17	21.92	21.87		
15	1	1	256-QAM	19.52	19.89	19.71		
Limit	EIRP < 23dBm/10MHz			Result			Pass	

Total EIRP power is less than partial EIRP limit 23 dBm/10MHz.



NR n48 Maximum Average Power [dBm] (GT - LC = -3.5 dB)										
BW [MHz]	RB Size	RB Offset	Mod	Lowest	Middle	Highest	EIRP (dBm)	EIRP(W)		
20	1	1	PI/2 BPSK	20.18	24.30	24.06	20.80	0.1202		
20	1	49		23.92	24.13	20.00				
20	25	12		24.07	24.14	24.07				
20	1	0		20.19	23.82	23.61				
20	1	50		23.44	23.61	20.00				
20	50	0		20.13	23.63	20.12				
20	1	1	QPSK	20.14	24.26	24.13				
20	1	49		23.95	24.09	19.98				
20	25	12		24.18	24.15	24.08				
20	1	0		20.17	23.28	23.57				
20	1	50		22.92	23.15	19.97				
20	50	0		20.11	23.11	20.09				
20	1	1	16-QAM	19.14	23.45	23.17			19.95	0.0989
20	1	1	64-QAM	19.22	21.88	21.82				
20	1	1	256-QAM	19.79	19.76	19.70				
Limit	EIRP < 23dBm/10MHz			Result			Pass			

NR n48 Maximum Average Power [dBm] (GT - LC = -3.5 dB)										
BW [MHz]	RB Size	RB Offset	Mod	Lowest	Middle	Highest	EIRP (dBm)	EIRP(W)		
40	1	1	PI/2 BPSK	13.73	20.37	13.66	20.76	0.1191		
40	1	104		13.45	20.08	13.47				
40	50	25		13.52	24.23	13.60				
40	1	0		13.77	20.41	13.72				
40	1	105		13.49	20.08	13.46				
40	100	0		13.51	19.73	13.62				
40	1	1	QPSK	10.27	20.41	10.20				
40	1	104		9.94	20.10	10.04				
40	50	25		10.03	24.26	10.14				
40	1	0		10.23	20.38	10.18				
40	1	105		9.92	20.08	10.02				
40	100	0		10.04	19.75	10.15				
40	1	1	16-QAM	10.33	20.39	10.11			16.98	0.0499
40	1	1	64-QAM	10.25	20.48	10.01				
40	1	1	256-QAM	10.22	19.86	10.07				
Limit	EIRP < 23dBm/10MHz			Result			Pass			



FR1 n48

Peak-to-Average Ratio

Mode	FR1 n48 / 20MHz / DFT-S OFDM				
Mod.	PI/2 BPSK	QPSK	16QAM	64QAM	Limit: 13dB
RB Size	Full RB	Full RB	Full RB	Full RB	Result
Middle CH	4.56	5.94	6.16	6.40	PASS
Mode	FR1 n48 / 20MHz / DFT-S OFDM				
Mod.	256QAM				Limit: 13dB
RB Size	Full RB				Result
Middle CH	9.14				PASS



FR1 n48 / 20MHz / DFT-S OFDM / Middle Channel / Full RB

PI/2 BPSK



QPSK

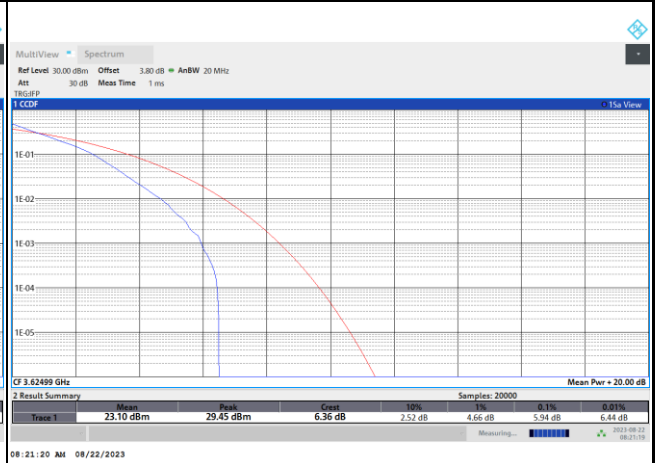

16QAM

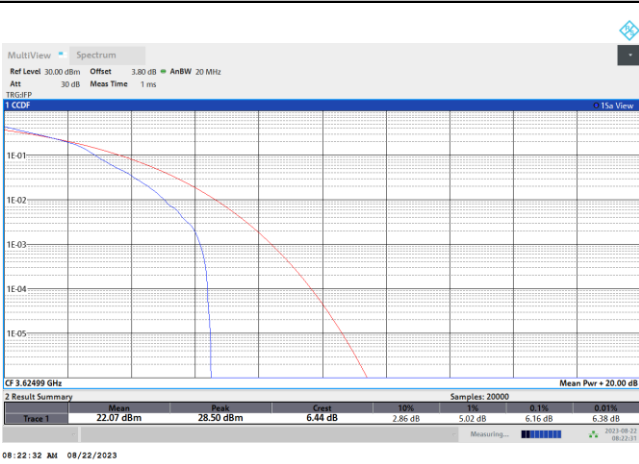

64QAM

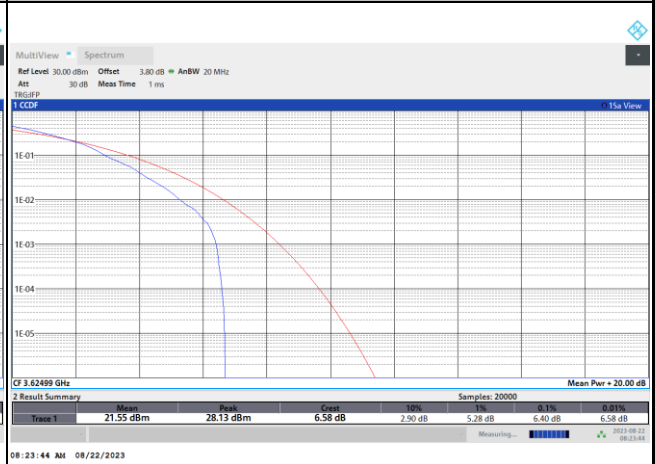

256QAM

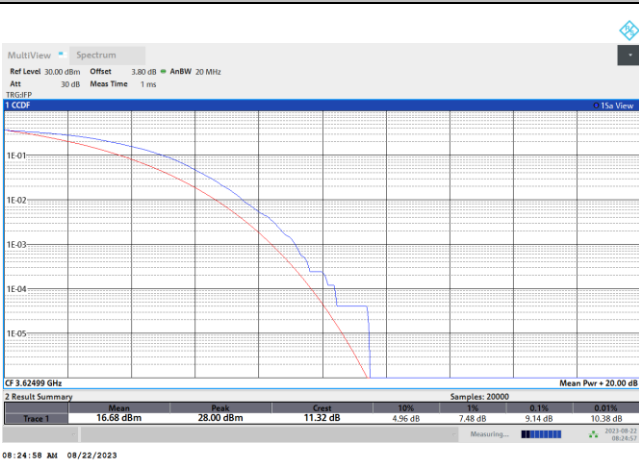



26dB Bandwidth

Mode	FR1 n48 : 26dB BW(MHz) / DFT-S OFDM							
BW	10MHz	15MHz	20MHz	30MHz	40MHz	50MHz	60MHz	70MHz
Mod.	PI/2 BPSK	PI/2 BPSK	PI/2 BPSK	PI/2 BPSK	PI/2 BPSK	PI/2 BPSK	PI/2 BPSK	PI/2 BPSK
Middle CH	9.73	14.71	19.94	-	38.84	-	-	-
BW	80MHz	90MHz	100MHz					
Mod.	PI/2 BPSK	PI/2 BPSK	PI/2 BPSK					
Middle CH	-	-	-					

Mode	FR1 n48 : 26dB BW(MHz) / CP OFDM							
BW	10MHz		15MHz		20MHz		30MHz	
Mod.	QPSK	16QAM	QPSK	16QAM	QPSK	16QAM	QPSK	16QAM
Middle CH	9.77	9.97	15.49	15.64	20.38	20.38	-	-
Mod.	64QAM	256QAM	64QAM	256QAM	64QAM	256QAM	64QAM	256QAM
Middle CH	9.81	9.81	15.46	15.61	20.30	20.26	-	-
BW	40MHz		50MHz		60MHz		70MHz	
Mod.	QPSK	16QAM	QPSK	16QAM	QPSK	16QAM	QPSK	16QAM
Middle CH	42.44	42.52	-	-	-	-	-	-
Mod.	64QAM	256QAM	64QAM	256QAM	64QAM	256QAM	64QAM	256QAM
Middle CH	42.20	43.16	-	-	-	-	-	-
BW	80MHz		90MHz		100MHz			
Mod.	QPSK	16QAM	QPSK	16QAM	QPSK	16QAM		
Middle CH	-	-	-	-	-	-		
Mod.	64QAM	256QAM	64QAM	256QAM	64QAM	256QAM		
Middle CH	-	-	-	-	-	-		



FR1 n48 / 10MHz / DFT-S OFDM / Middle Channel / Full RB

PI/2 BPSK

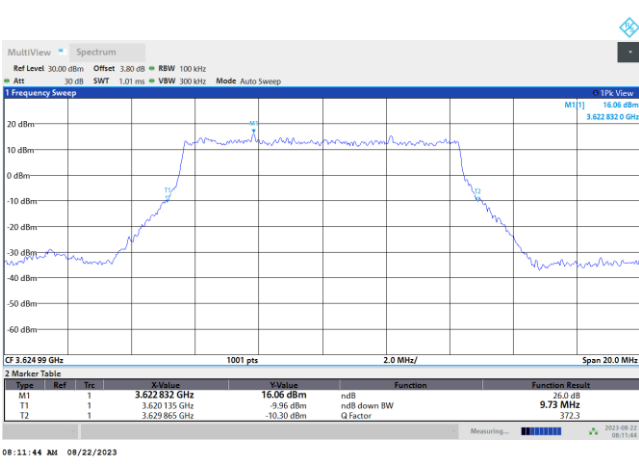

FR1 n48 / 10MHz / CP OFDM / Middle Channel / Full RB

QPSK

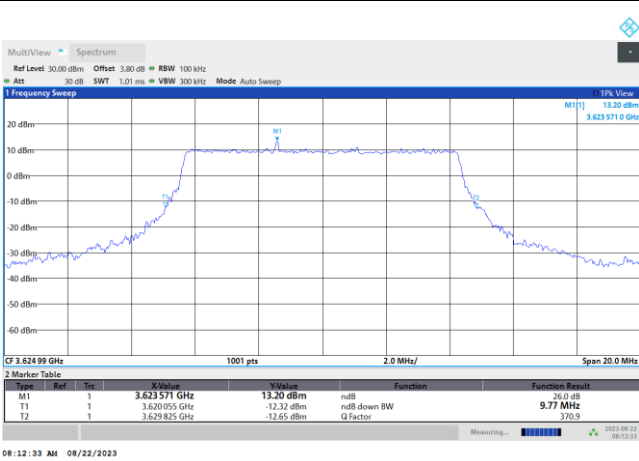

16QAM

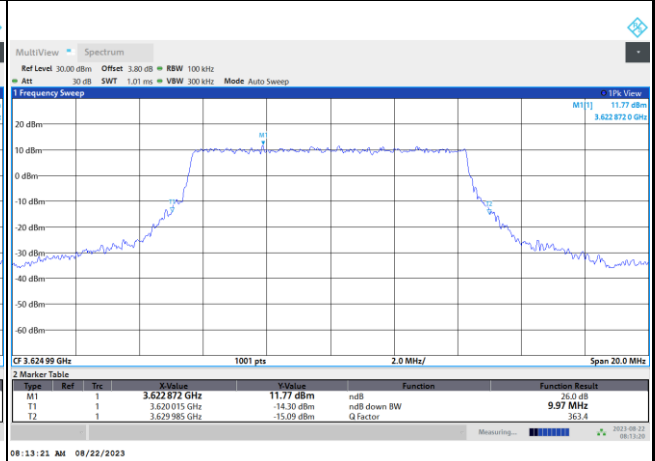

64QAM

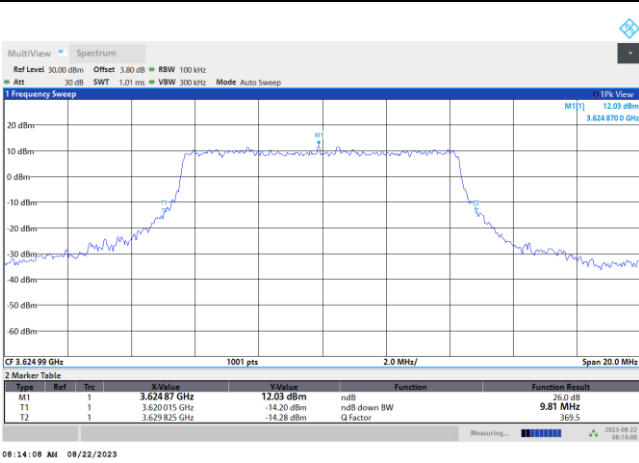

256QAM

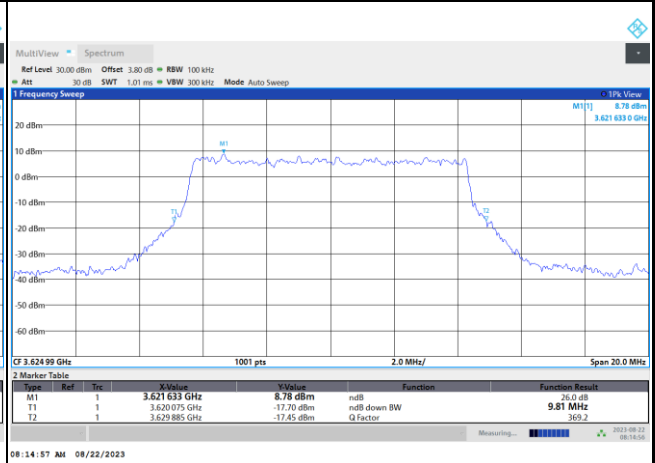



FR1 n48 / 15MHz / DFT-S OFDM / Middle Channel / Full RB

PI/2 BPSK

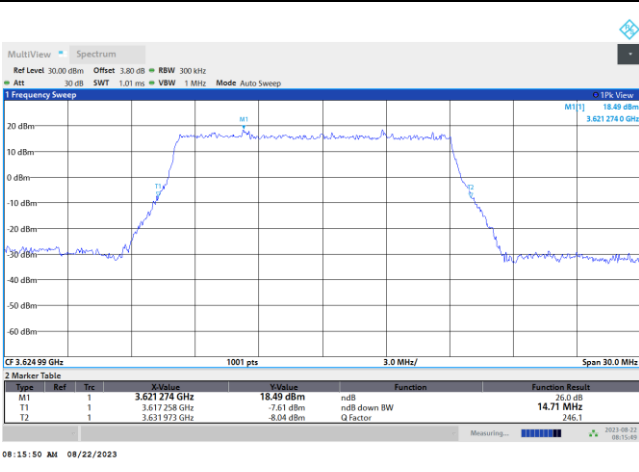

FR1 n48 / 15MHz / CP OFDM / Middle Channel / Full RB

QPSK

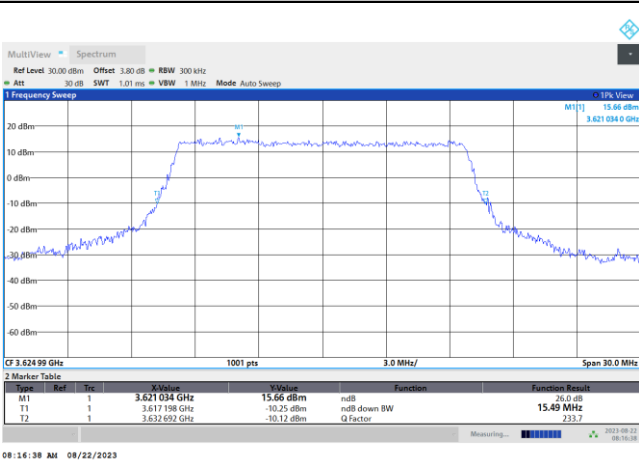

16QAM

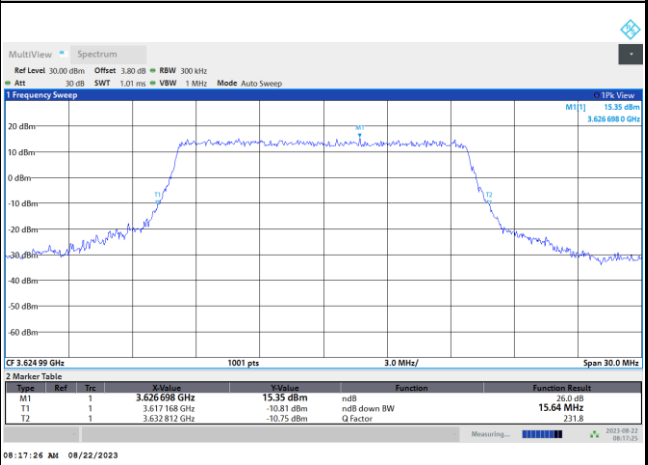

64QAM

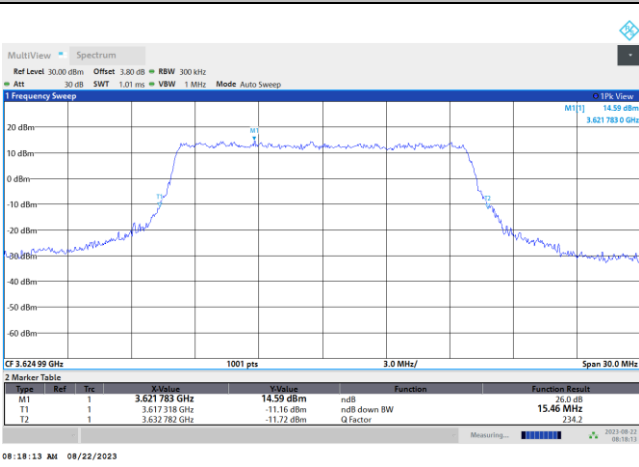

256QAM

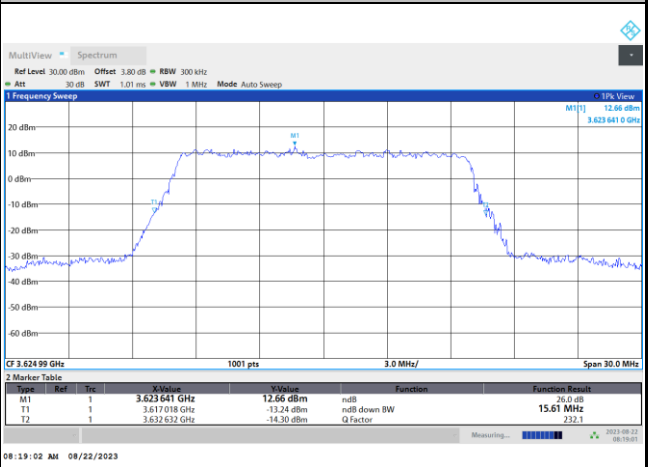



FR1 n48 / 20MHz / DFT-S OFDM / Middle Channel / Full RB

PI/2 BPSK

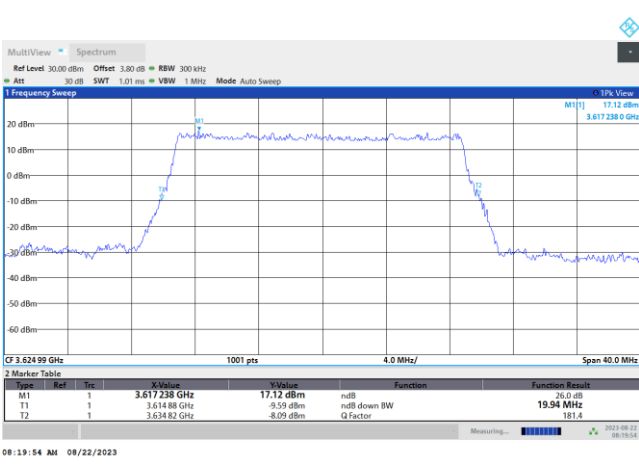

FR1 n48 / 20MHz / CP OFDM / Middle Channel / Full RB

QPSK

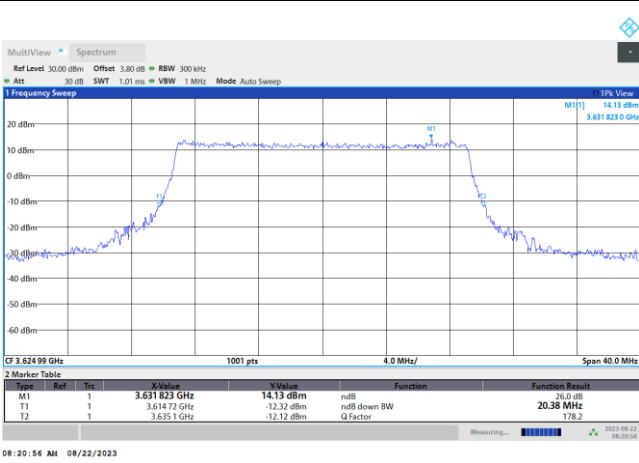

16QAM

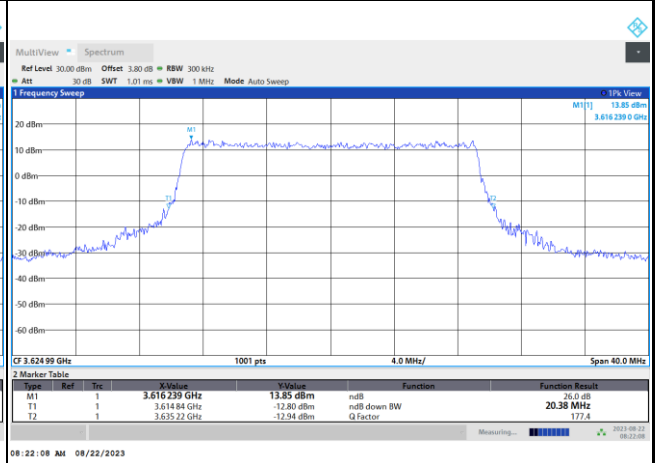

64QAM

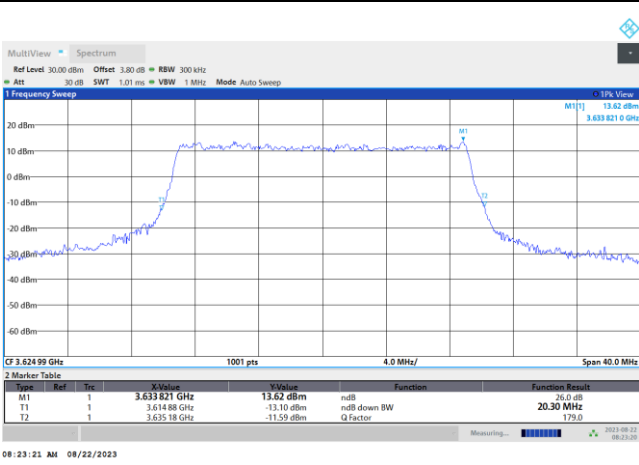

256QAM

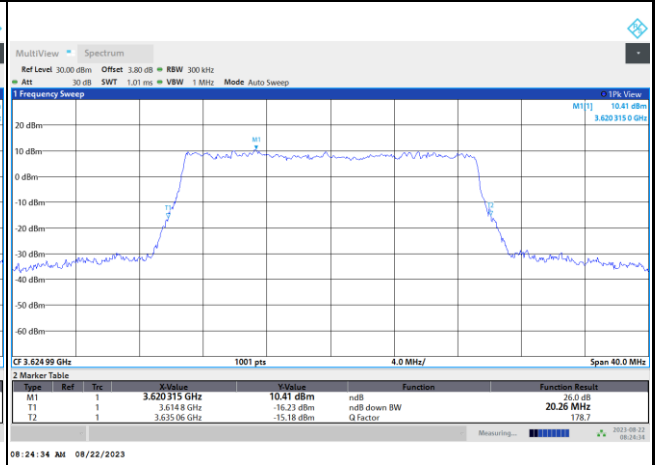



FR1 n48 / 40MHz / DFT-S OFDM / Middle Channel / Full RB

PI/2 BPSK

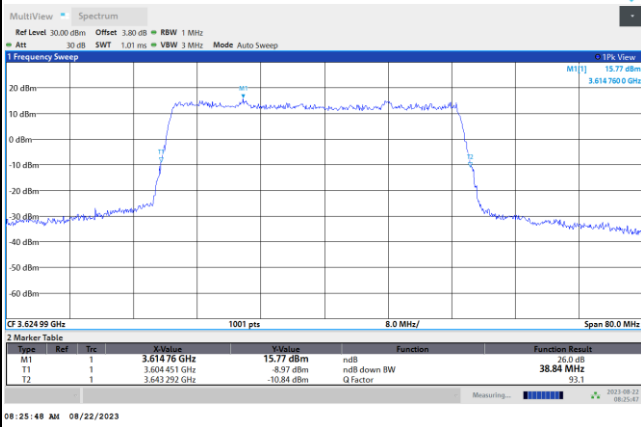

FR1 n48 / 40MHz / CP OFDM / Middle Channel / Full RB

QPSK

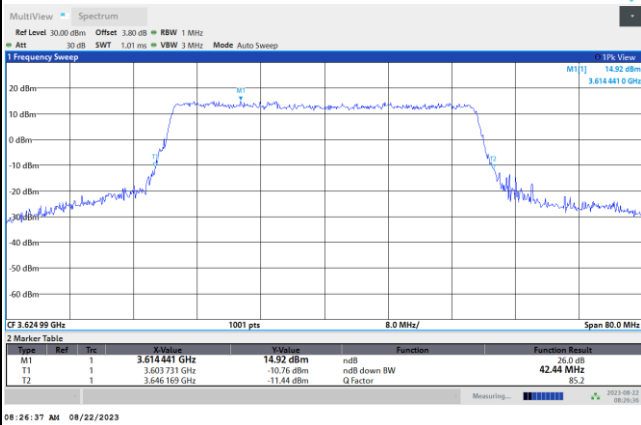

16QAM

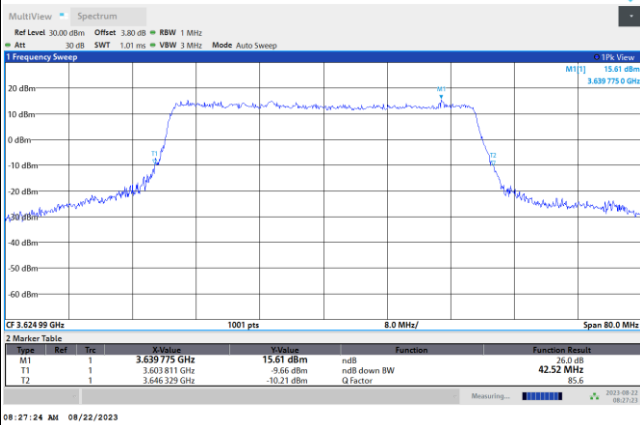

64QAM

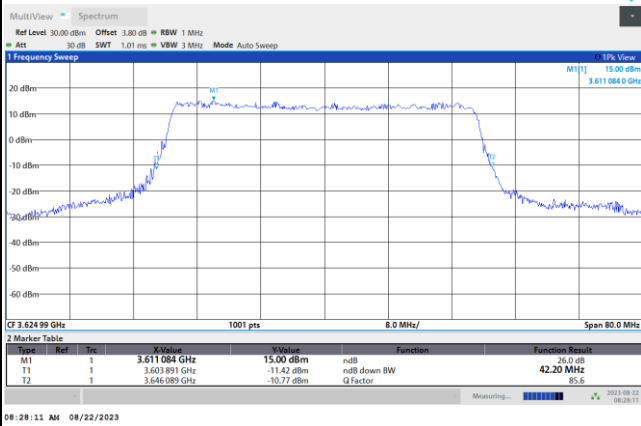

256QAM

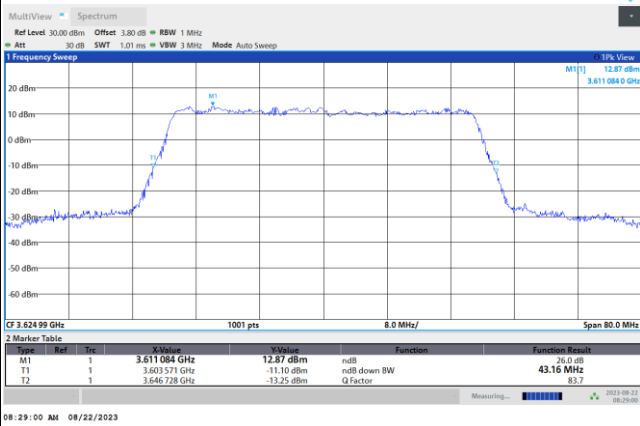



Occupied Bandwidth

Mode	FR1 n48 : OB BW(MHz) / DFT-S OFDM							
BW	10MHz	15MHz	20MHz	30MHz	40MHz	50MHz	60MHz	70MHz
Mod.	PI/2 BPSK	PI/2 BPSK	PI/2 BPSK	PI/2 BPSK	PI/2 BPSK	PI/2 BPSK	PI/2 BPSK	PI/2 BPSK
Middle CH	8.63	13.04	17.99	-	36.17	-	-	-
BW	80MHz	90MHz	100MHz					
Mod.	PI/2 BPSK	PI/2 BPSK	PI/2 BPSK					
Middle CH	-	-	-					

Mode	FR1 n48 : OB BW(MHz) / CP OFDM							
BW	10MHz		15MHz		20MHz		30MHz	
Mod.	QPSK	16QAM	QPSK	16QAM	QPSK	16QAM	QPSK	16QAM
Middle CH	8.62	8.61	13.73	13.66	18.33	18.33	-	-
Mod.	64QAM	256QAM	64QAM	256QAM	64QAM	256QAM	64QAM	256QAM
Middle CH	8.63	8.60	13.76	13.78	18.29	18.30	-	-
BW	40MHz		50MHz		60MHz		70MHz	
Mod.	QPSK	16QAM	QPSK	16QAM	QPSK	16QAM	QPSK	16QAM
Middle CH	38.19	38.17	-	-	-	-	-	-
Mod.	64QAM	256QAM	64QAM	256QAM	64QAM	256QAM	64QAM	256QAM
Middle CH	38.25	38.46	-	-	-	-	-	-
BW	80MHz		90MHz		100MHz			
Mod.	QPSK	16QAM	QPSK	16QAM	QPSK	16QAM		
Middle CH	-	-	-	-	-	-		
Mod.	64QAM	256QAM	64QAM	256QAM	64QAM	256QAM		
Middle CH	-	-	-	-	-	-		



FR1 n48 / 10MHz / DFT-S OFDM / Middle Channel / Full RB

PI/2 BPSK

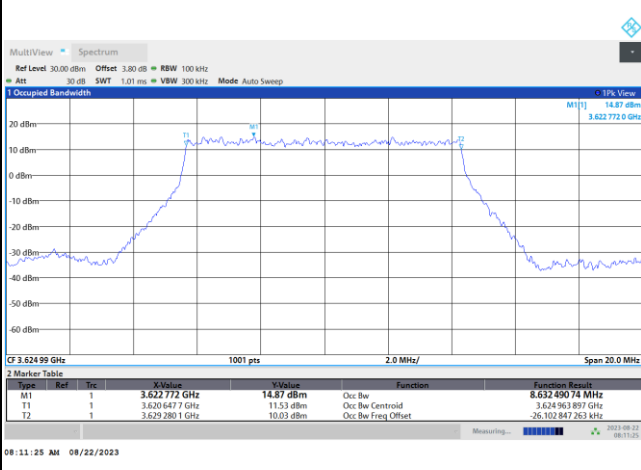

FR1 n48 / 10MHz / CP OFDM / Middle Channel / Full RB

QPSK

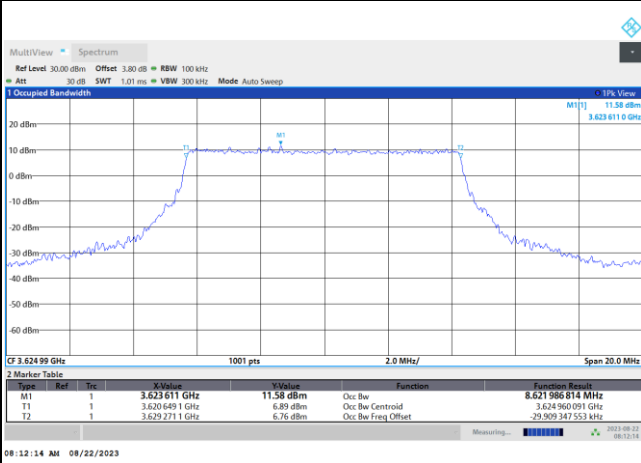

16QAM

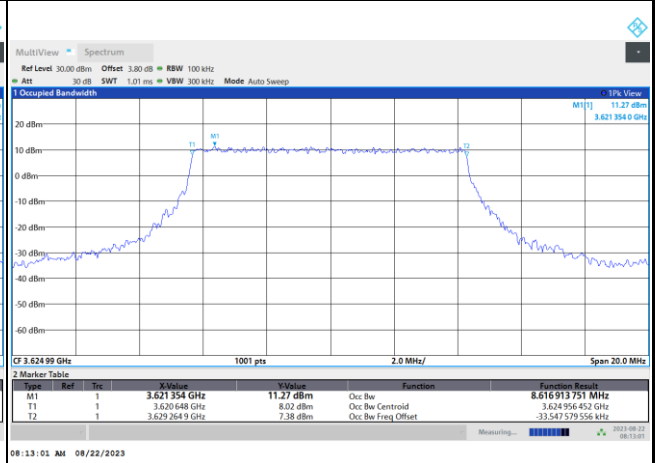

64QAM

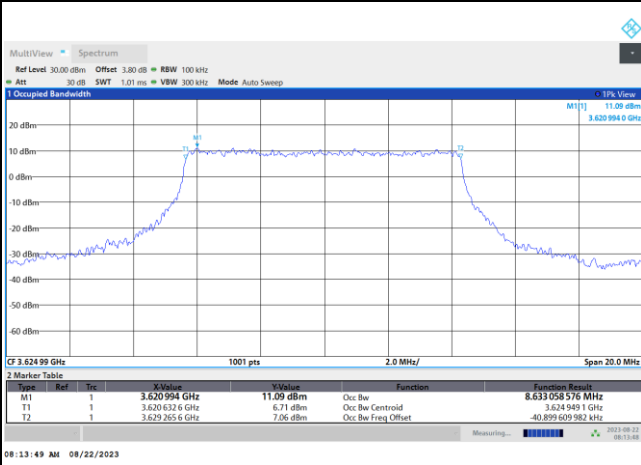

256QAM

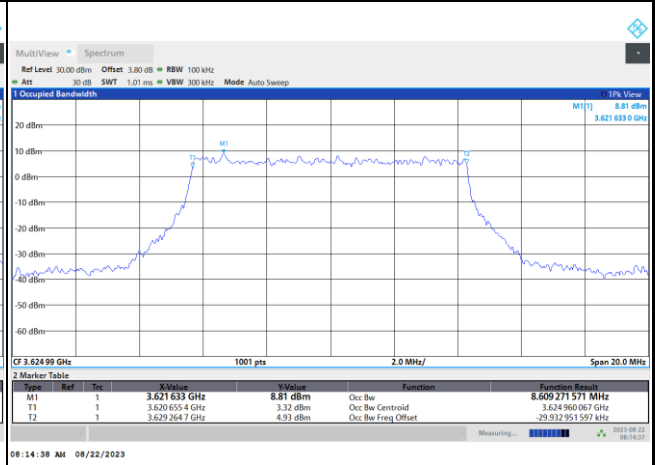



FR1 n48 / 15MHz / DFT-S OFDM / Middle Channel / Full RB

PI/2 BPSK

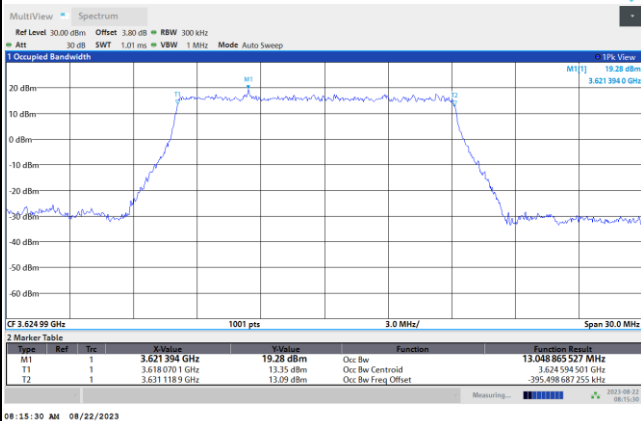

FR1 n48 / 15MHz / CP OFDM / Middle Channel / Full RB

QPSK

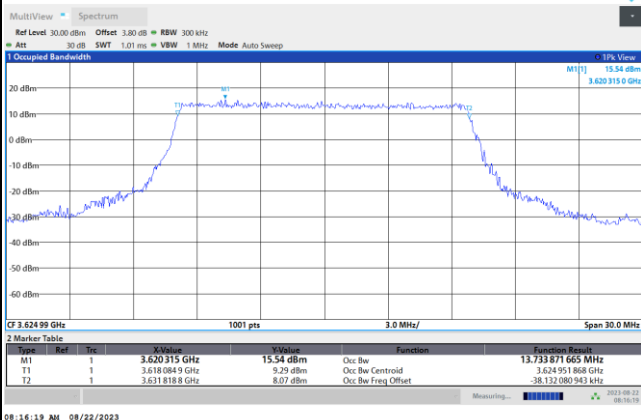

16QAM

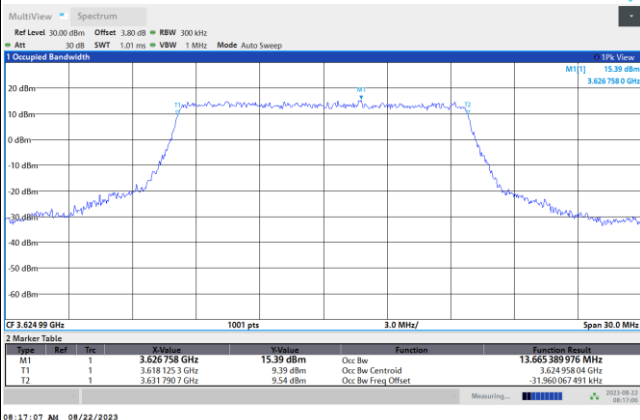

64QAM

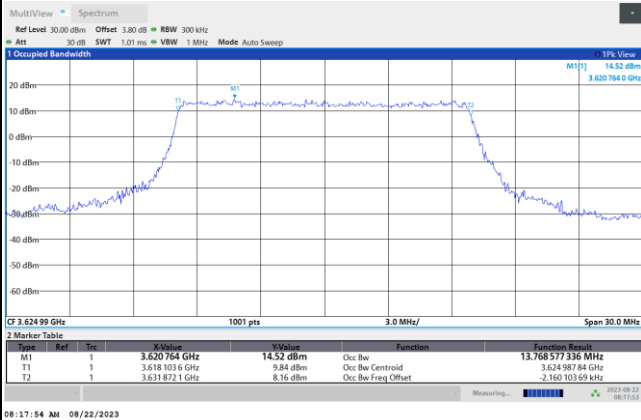

256QAM

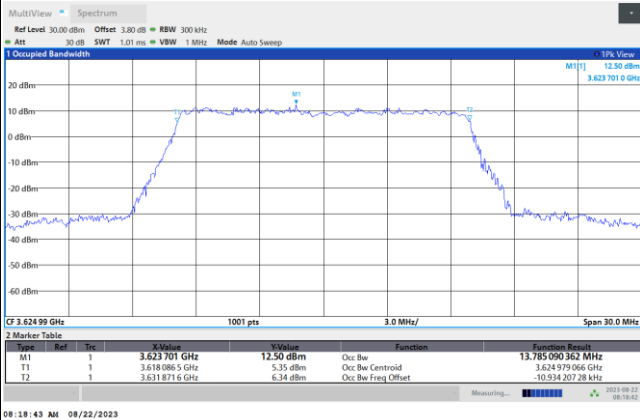



FR1 n48 / 20MHz / DFT-S OFDM / Middle Channel / Full RB

PI/2 BPSK

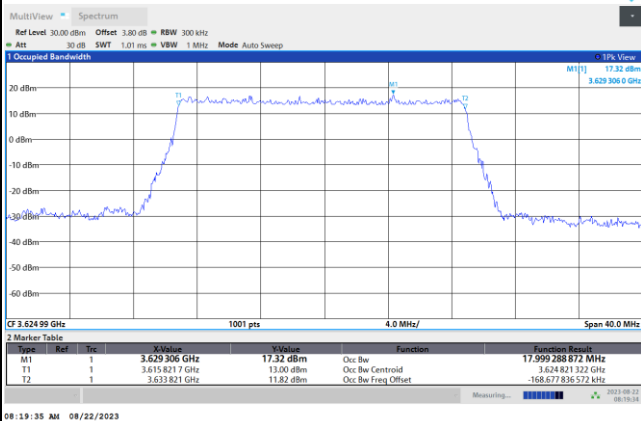

FR1 n48 / 20MHz / CP OFDM / Middle Channel / Full RB

QPSK

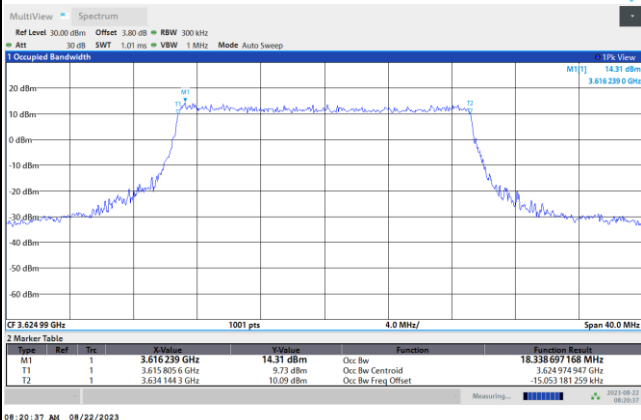

16QAM

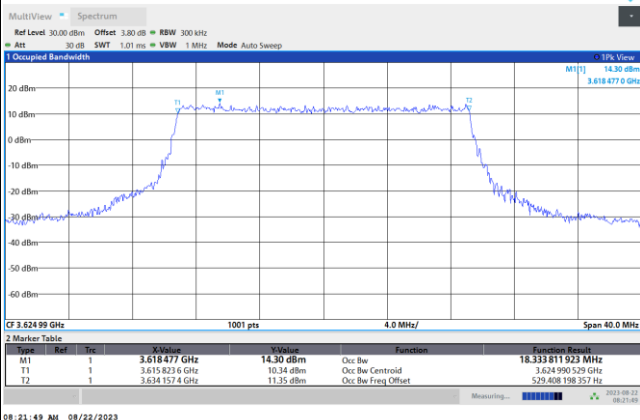

64QAM

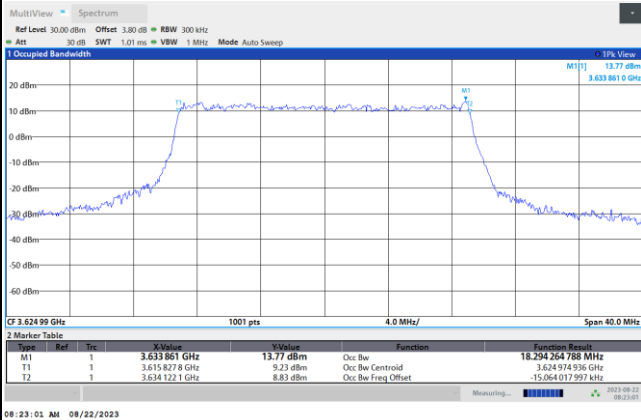

256QAM

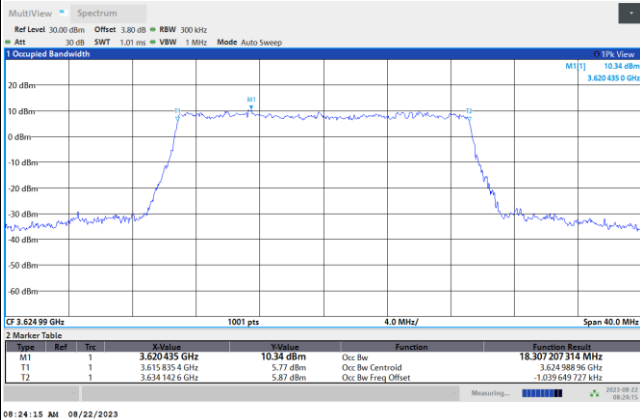



FR1 n48 / 40MHz / DFT-S OFDM / Middle Channel / Full RB

PI/2 BPSK

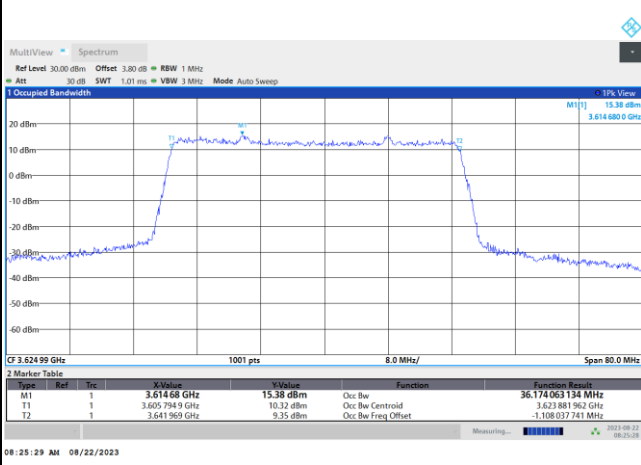

FR1 n48 / 40MHz / CP OFDM / Middle Channel / Full RB

QPSK

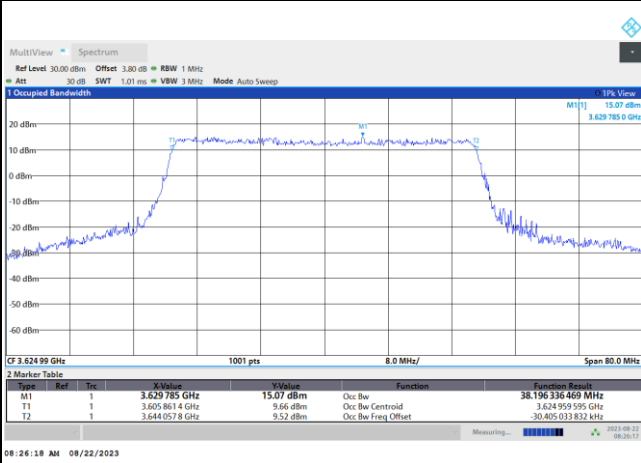

16QAM

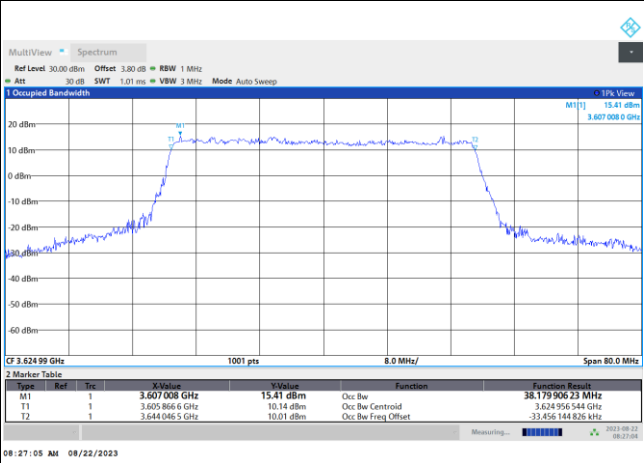

64QAM

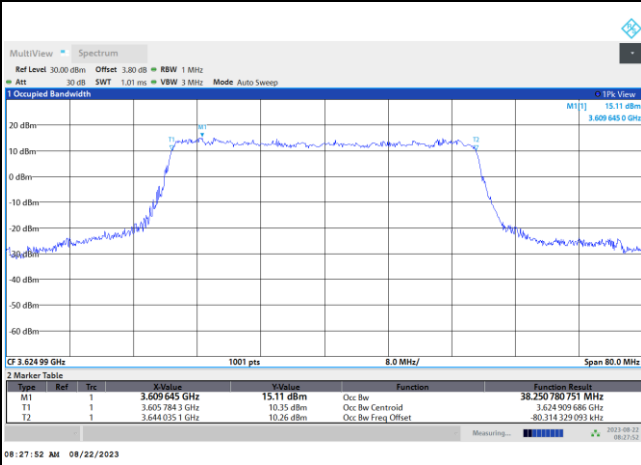

256QAM

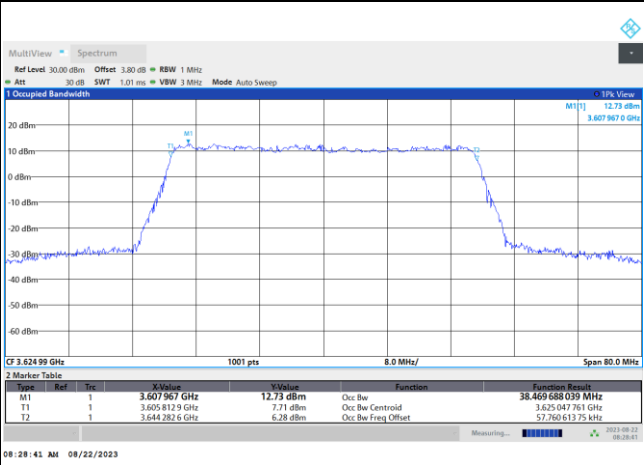



Unwanted Emission (MASK)

FR1 n48 / 10MHz / DFT-S OFDM / PI/2 BPSK

Lowest Channel

1RB0

1RBmax

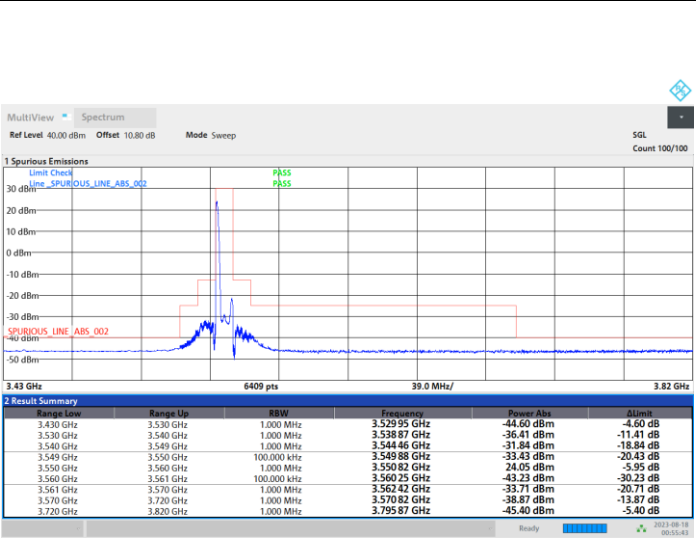

12:55:44 AM 08/18/2023

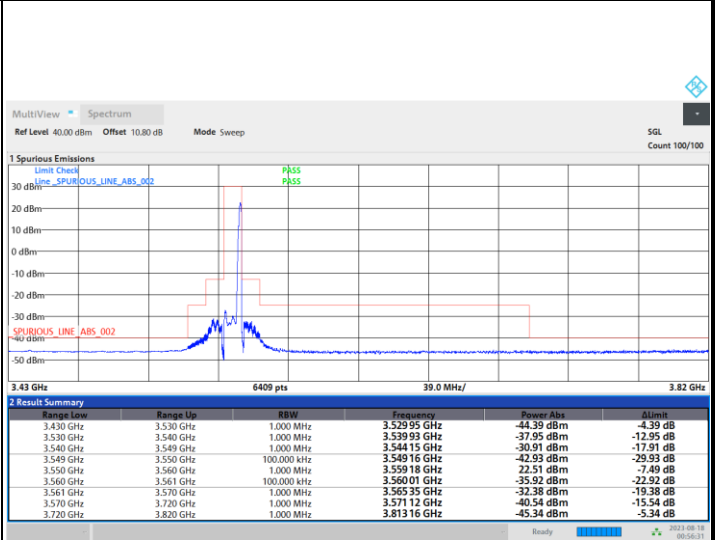

12:56:32 AM 08/18/2023

Full RB

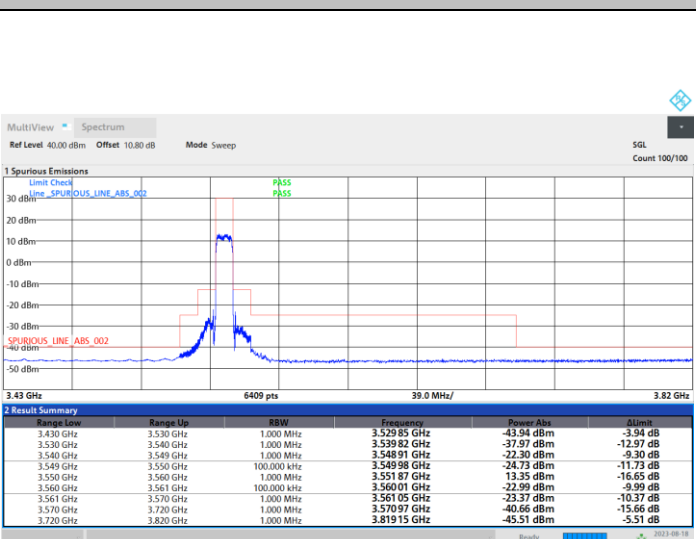

12:53:03 AM 08/18/2023



FR1 n48 / 10MHz / DFT-S OFDM / PI/2 BPSK

Middle Channel

1RB0

1RBmax

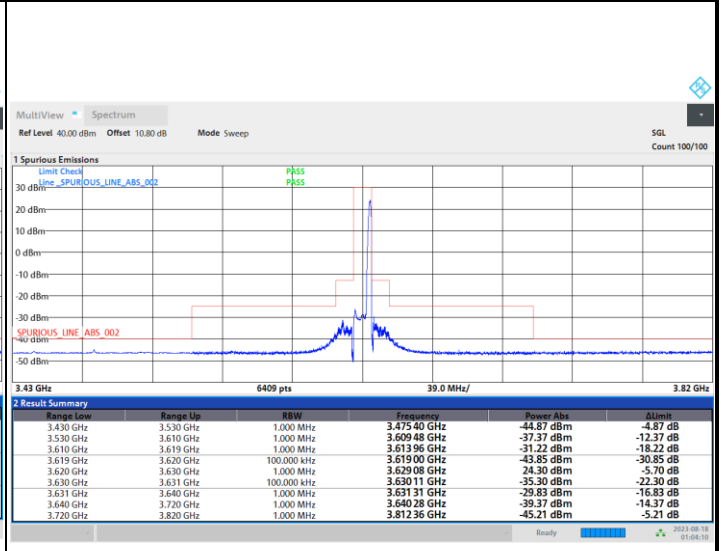
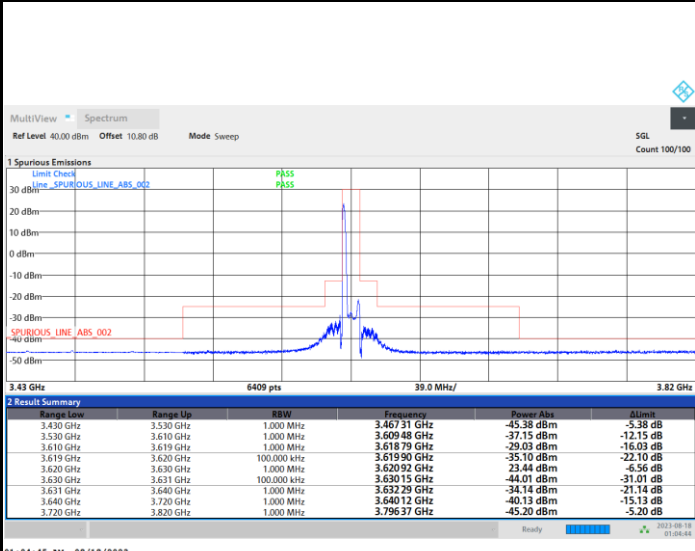

Full RB

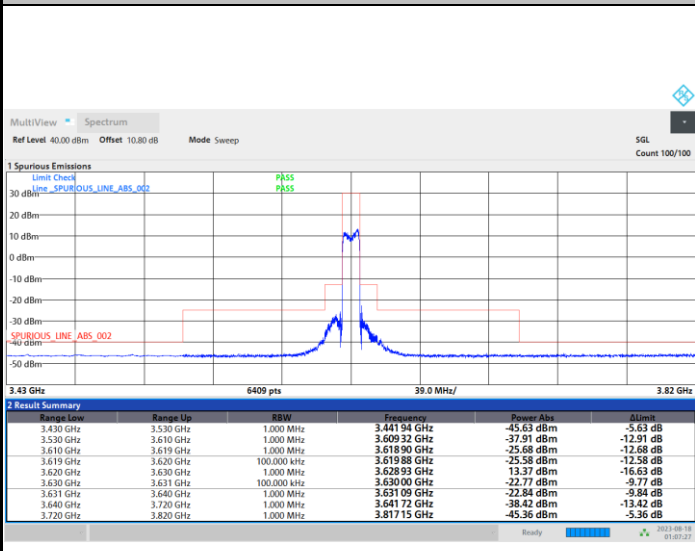



FR1 n48 / 10MHz / DFT-S OFDM / PI/2 BPSK

Highest Channel

1RB0

1RBmax

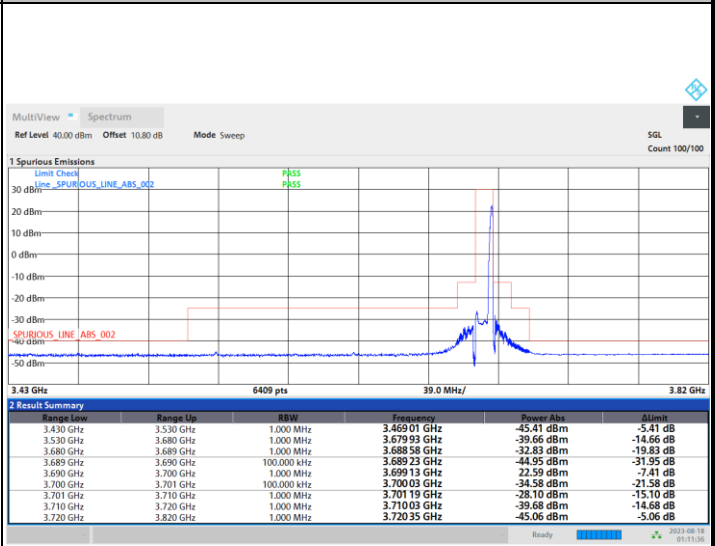
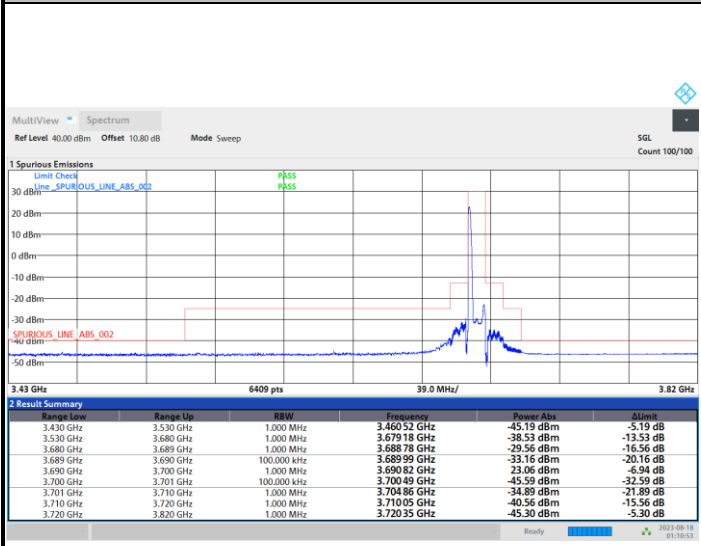

Full RB

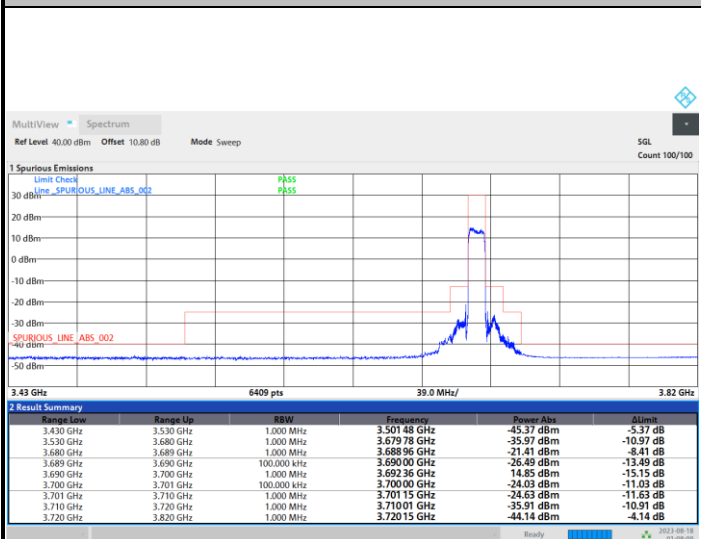



FR1 n48 / 10MHz / DFT-S OFDM / QPSK

Lowest Channel

1RB0

1RBmax

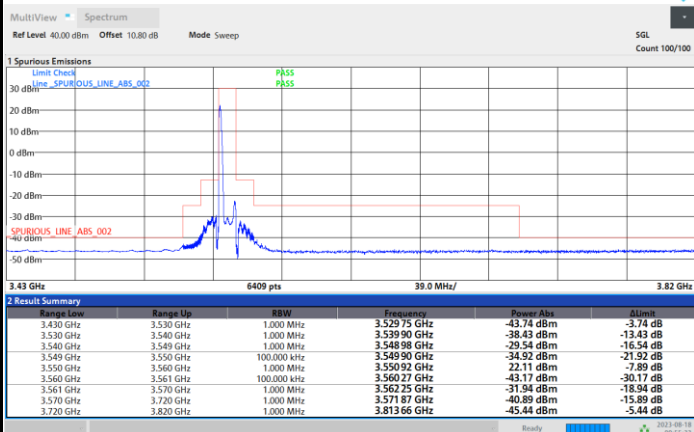

12:55:23 AM 08/18/2023

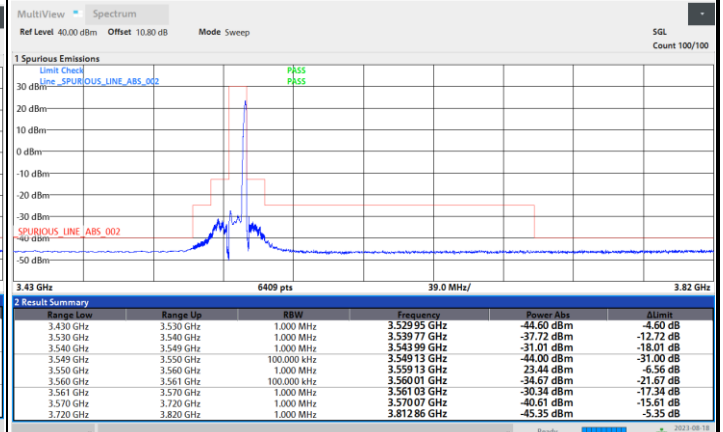

12:56:54 AM 08/18/2023

Full RB

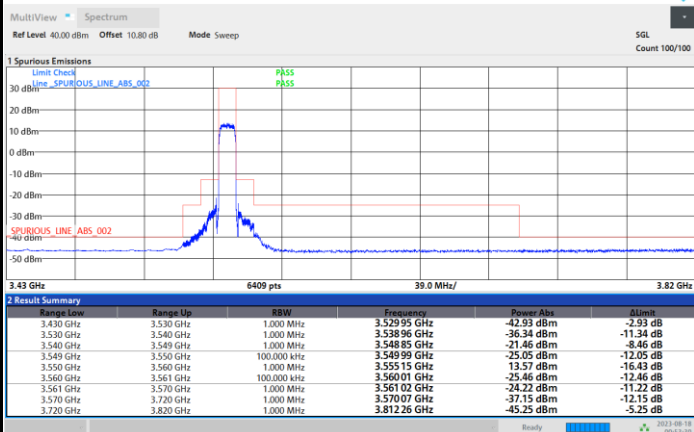

12:53:31 AM 08/18/2023



FR1 n48 / 10MHz / DFT-S OFDM / QPSK

Middle Channel

1RB0

1RBmax

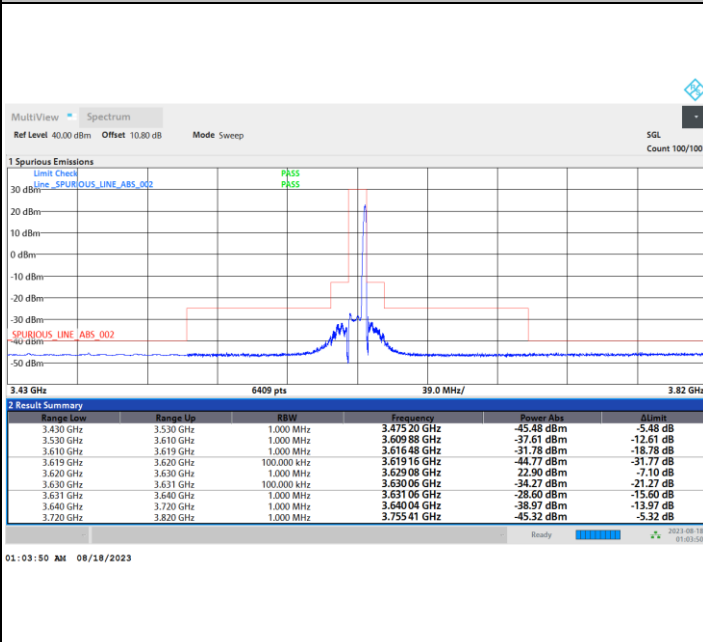
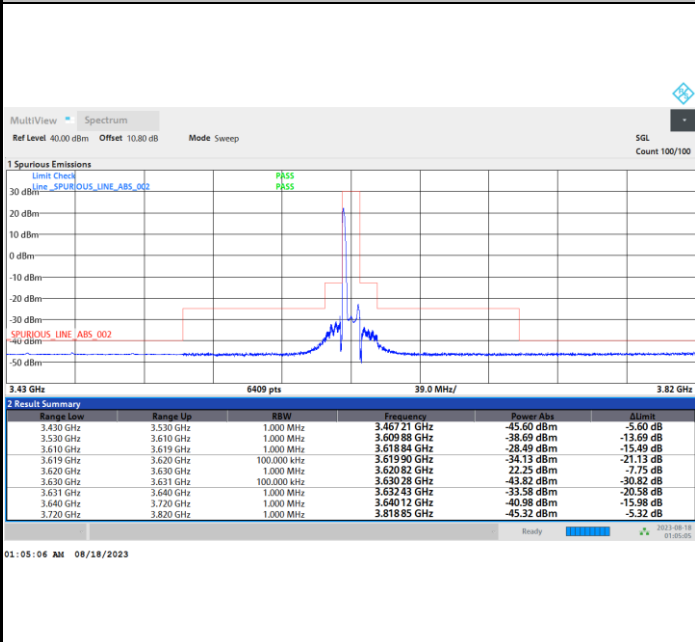

Full RB

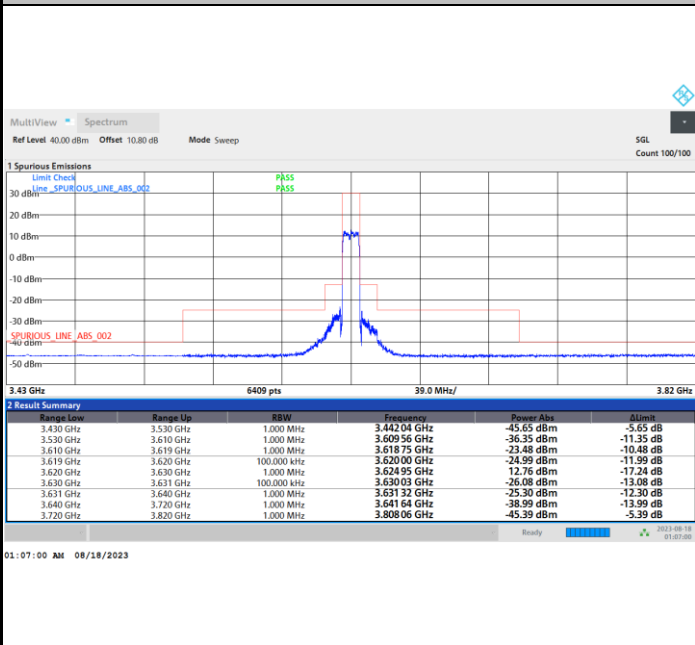



FR1 n48 / 10MHz / DFT-S OFDM / QPSK

Highest Channel

1RB0

1RBmax

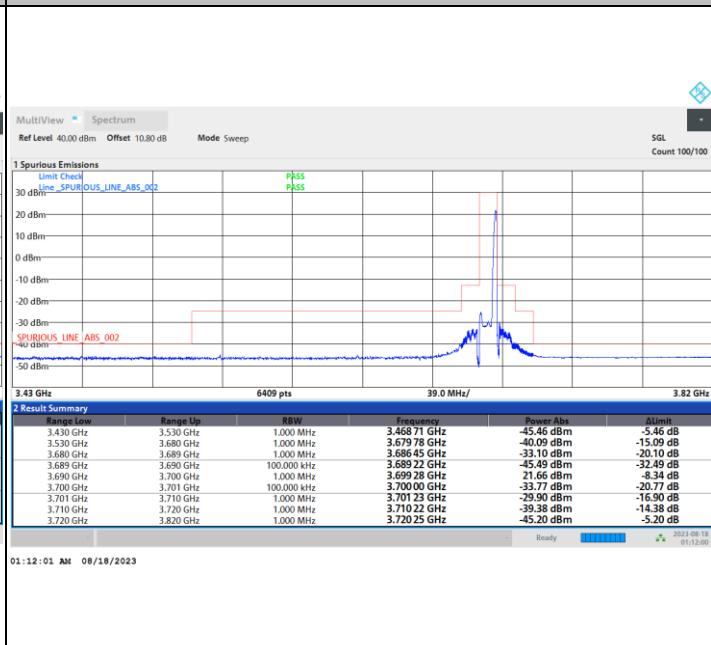
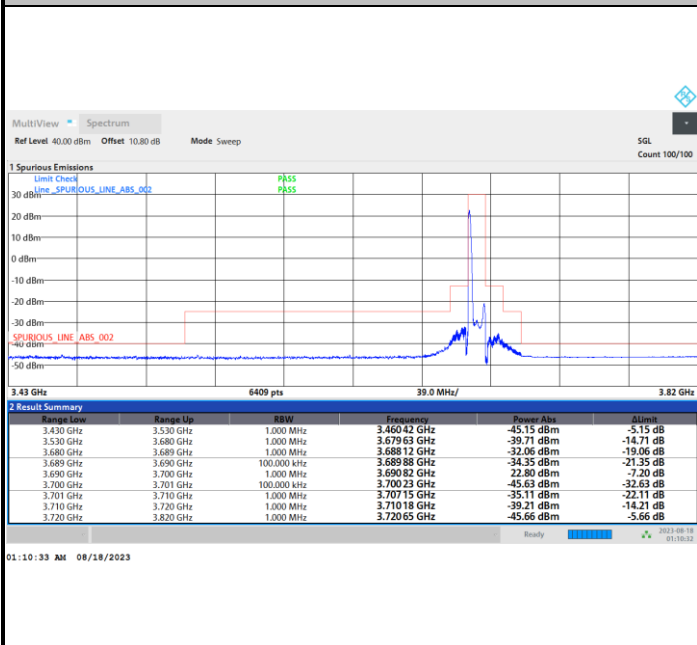

Full RB

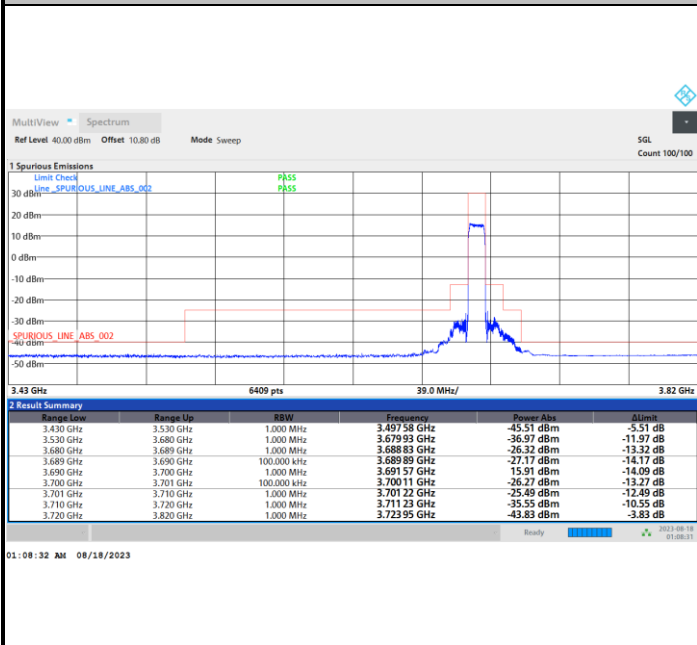



FR1 n48 / 10MHz / DFT-S OFDM / 16QAM

Lowest Channel

1RB0

1RBmax

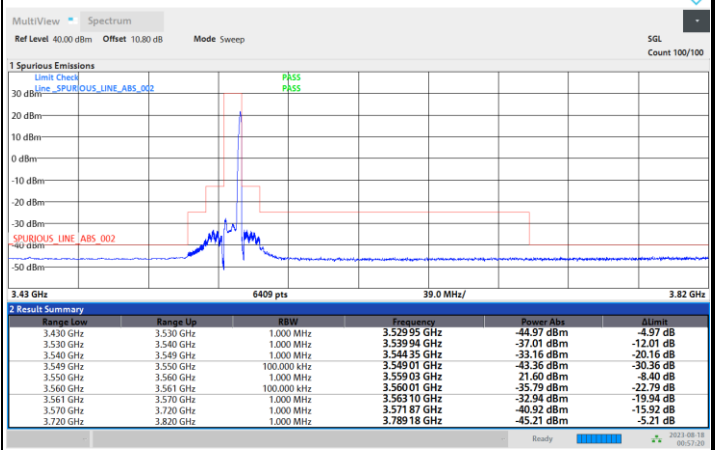
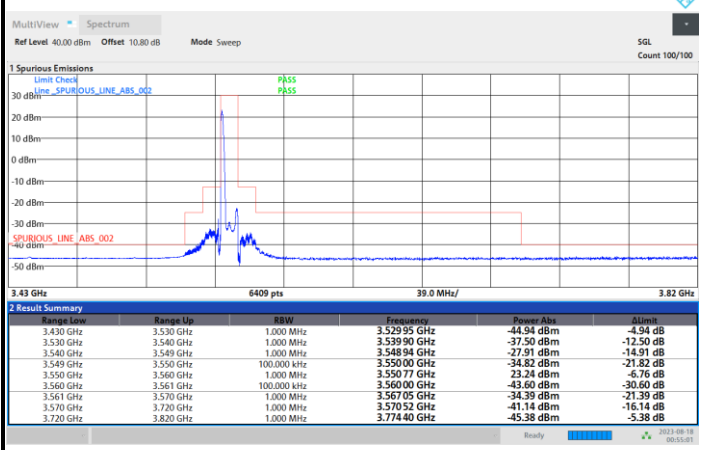

Full RB

