



FCC RADIO TEST REPORT

FCC ID : A4RG0DZQ
Equipment : Phone
Applicant : Google LLC
1600 Amphitheatre Parkway,
Mountain View, California, 94043 USA
Standard : FCC Part 15 Subpart C §15.225

The product was received on Sep. 15, 2022 and testing was performed from Sep. 19, 2022 to Sep. 29, 2022. We, Sporton International Inc. EMC & Wireless Communications Laboratory, would like to declare that the tested sample has been evaluated in accordance with the test procedures and has been in compliance with the applicable technical standards.

The test results in this report apply exclusively to the tested model / sample. Without written approval from Sporton International Inc. EMC & Wireless Communications Laboratory, the test report shall not be reproduced except in full.

Approved by: Louis Wu

Sporton International Inc. EMC & Wireless Communications Laboratory
No. 52, Huaya 1st Rd., Guishan Dist., Taoyuan City 333, Taiwan (R.O.C.)



Table of Contents

History of this test report.....	3
Summary of Test Result.....	4
1. General Description	5
1.1 Product Feature of Equipment Under Test	5
1.2 Product Specification of Equipment Under Test	5
1.3 Modification of EUT	5
1.4 Testing Location	6
1.5 Applicable Standards.....	6
2. Test Configuration of Equipment Under Test.....	7
2.1 Descriptions of Test Mode	7
2.2 Connection Diagram of Test System	8
2.3 Table for Supporting Units	9
2.4 EUT Operation Test Setup	9
3. Test Results	10
3.1 AC Power Line Conducted Emissions Measurement	10
3.2 20dB and 99% OBW Spectrum Bandwidth Measurement.....	12
3.3 Frequency Stability Measurement	13
3.4 Field Strength of Fundamental Emissions and Mask Measurement.....	14
3.5 Radiated Emissions Measurement	16
3.6 Antenna Requirements.....	19
4. List of Measuring Equipment	20
5. Uncertainty of Evaluation	21
Appendix A. Test Results of Conducted Emission Test	
Appendix B. Test Results of Near Field Test Items	
B1. Test Result of 20dB Spectrum Bandwidth	
B2. Test Result of Frequency Stability	
Appendix C. Test Results of Radiated Test Items	
C1. Test Result of Field Strength of Fundamental Emissions	
C2. Results of Radiated Emissions (9 kHz~30MHz)	
C3. Results of Radiated Emissions (30MHz~1GHz)	
Appendix D. Setup Photographs	



History of this test report

Report No.	Version	Description	Issue Date
FR241215-02D	01	Initial issue of report	Nov. 24, 2022
FR241215-02D	02	Revise AC Conducted Emission setup photo	Dec. 08, 2022



Summary of Test Result

Report Clause	Ref Std. Clause	Test Items	Result (PASS/FAIL)	Remark
3.1	15.207	AC Power Line Conducted Emissions	Pass	14.18 dB under the limit at 27.120MHz
3.2	15.215(c)	20dB Spectrum Bandwidth	Pass	-
	2.1049	99% OBW Spectrum Bandwidth	Reporting only	-
3.3	15.225(e)	Frequency Stability	Pass	-
3.4	15.225(a)(b)(c)	Field Strength of Fundamental Emissions	Pass	Max level 20.86 dB μ V/m at 13.560 MHz
3.5	15.225(d) 15.209	Radiated Spurious Emissions	Pass	6.47 dB under the limit at 40.800MHz
3.6	15.203	Antenna Requirements	Pass	-

Declaration of Conformity:

- The test results (PASS/FAIL) with all measurement uncertainty excluded are presented in accordance with the regulation limits or requirements declared by manufacturers. It's means measurement values may risk exceeding the limit of regulation standards, if measurement uncertainty is include in test results.
- The measurement uncertainty please refer to report "Uncertainty of Evaluation".

Comments and Explanations:

The product specifications of the EUT presented in the report are declared by the manufacturer who shall take full responsibility for the authenticity.

Reviewed by: William Chen

Report Producer: Cindy Liu



1. General Description

1.1 Product Feature of Equipment Under Test

Product Feature	
Equipment	Phone
FCC ID	A4RG0DZQ
EUT supports Radios application	GSM/EGPRS/WCDMA/HSPA/LTE/5G NR/ NFC/GNSS/WPT Client WLAN 11b/g/n HT20 WLAN 11a/n HT20/HT40 WLAN 11ac VHT20/VHT40/VHT80 WLAN 11ax HE20/HE40/HE80 Bluetooth BR/EDR/LE

Remark: The above EUT's information was declared by manufacturer.

EUT Information List	
S/N	Performed Test Item
28291FQHN00123	Conducted Emission
28291FQHN00133	Radiated Spurious Emission
28291FQHN00133	RF Near Field

1.2 Product Specification of Equipment Under Test

Product Specification is subject to this standard	
Tx/Rx Frequency	13.553 ~ 13.567MHz
Channel Number	1
Antenna Type	Loop Antenna
Type of Modulation	ASK

Remark: The above EUT's information was declared by manufacturer. Please refer to Comments and Explanations in report summary.

1.3 Modification of EUT

No modifications made to the EUT during the testing.



1.4 Testing Location

Test Site	Sporton International Inc. EMC & Wireless Communications Laboratory		
Test Site Location	No.52, Huaya 1st Rd., Guishan Dist., Taoyuan City 333, Taiwan (R.O.C.) TEL: +886-3-327-3456 FAX: +886-3-328-4978		
Test Site No.	Sporton Site No.		
	TH03-HY	CO05-HY	03CH07-HY
Test Engineer	Ryan Lee	Tom Lee	Jesse Wang and Stan Hsieh
Temperature	22~24°C	23~26°C	23.8~24.1°C
Relative Humidity	53~55%	45~55%	59.6~61.7%

Note: The test site complies with ANSI C63.4 2014 requirement.

FCC designation No.: TW1190

1.5 Applicable Standards

According to the specifications declared by the manufacturer, the EUT must comply with the requirements of the following standards:

- ♦ FCC Part 15 Subpart C §15.225
- ♦ FCC KDB 414788 D01 Radiated Test Site v01r01
- ♦ ANSI C63.10-2013

Remark:

1. All the test items were validated and recorded in accordance with the standards without any modification during the testing.
2. The TAF code is not including all the FCC KDB listed without accreditation.



2. Test Configuration of Equipment Under Test

2.1 Descriptions of Test Mode

Investigation has been done on all the possible configurations.

The following table is a list of the test modes shown in this test report.

Test Items	
AC Power Line Conducted Emissions	Field Strength of Fundamental Emissions
20dB Spectrum Bandwidth	Frequency Stability
Radiated Emissions 9kHz~30MHz	Radiated Emissions 30MHz~1GHz

The EUT pre-scanned in reader mode with NFC tag (four NFC type A, B, F, V) and without reading tag. Based on the highest field strength of fundamental and spurious emissions, the worst case type (type F) was recorded in this report.

The measured emission level of the EUT was maximized by rotating the EUT on a turntable, adjusting the orientation of the EUT and EUT antenna in three orthogonal axis (X: flat, Y: portrait, Z: landscape), and Accessory (Adapter or Earphone), adjusting the measurement antenna orientation, following C63.10 exploratory test procedures and only the worst case emissions were reported in this report.

Test Cases	
AC Conducted Emission	Mode 1: GSM850 Idle + WLAN Idle + Bluetooth Idle + NFC Read + USB Cable 2 (Type C) (Charging from Adapter 1)
Remark:	
<ol style="list-style-type: none"> For Radiated Test Cases, the tests were performed with Adapter 1 and USB Cable 2. During the preliminary test, both charging modes (Adapter mode and WPT client mode) were verified. It is determined that the adaptor mode is the worst case for official test. 	

2.2 Connection Diagram of Test System

<Radiated Spurious Emission with Adapter Mode>

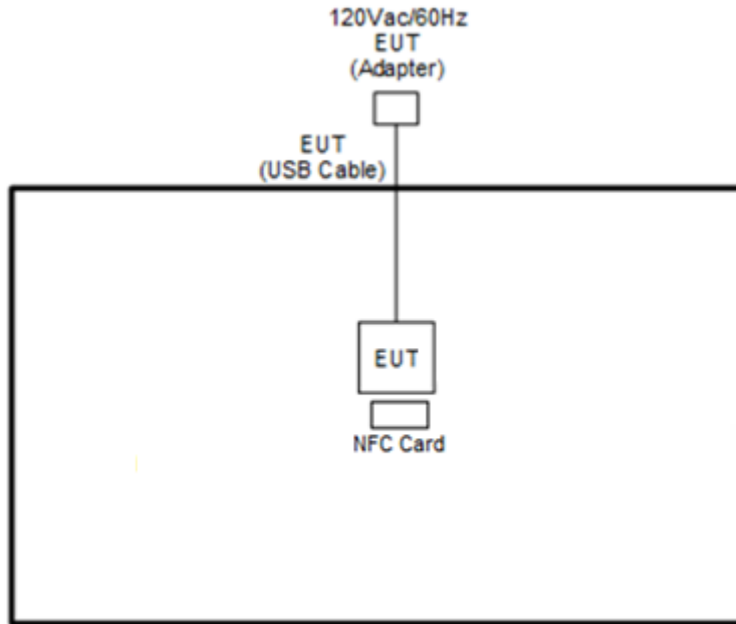

<Radiated Spurious Emission with Earphone Mode>

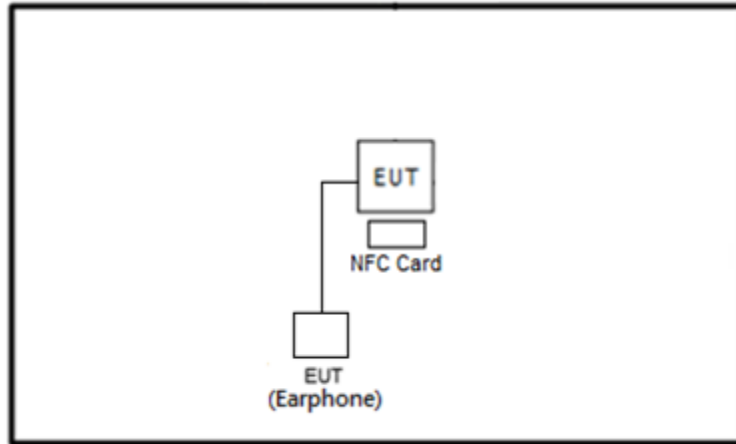

<AC Conducted Emission Mode>

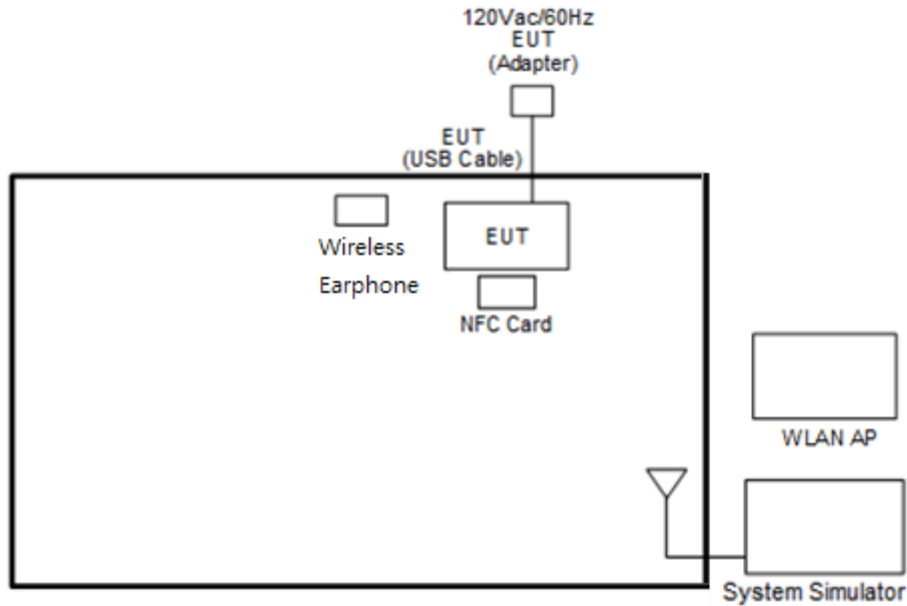

2.3 Table for Supporting Units

Item	Equipment	Brand Name	Model Name	FCC ID	Data Cable	Power Cord
1.	System Simulator	Anritsu	MT8820C	N/A	N/A	Unshielded, 1.8 m
2.	Wireless Earphone	Google	G1007/G1008	A4RG1007/ A4RG1008	N/A	N/A
3.	WLAN AP	ASUS	RT-AC66U	MSQ-RTAC66U	N/A	Unshielded, 1.8 m
4.	NFC Card	N/A	N/A	N/A	N/A	N/A

2.4 EUT Operation Test Setup

The EUT is programmed to be in continuously transmitting mode.

The ancillary equipment, NFC card, is used to make the EUT (NFC) continuously transmitting signal (Power Level: Default) at 13.56MHz and is placed around 0 cm gap to the EUT.



3. Test Results

3.1 AC Power Line Conducted Emissions Measurement

3.1.1 Limit of AC Conducted Emission

For equipment that is designed to be connected to the public utility (AC) power line, the radio frequency voltage that is conducted back onto the AC power line on any frequency or frequencies within the band 150 kHz to 30 MHz shall not exceed the limits in the following table.

Frequency of Emission (MHz)	Conducted Limit (dB μ V)	
	Quasi-Peak	Average
0.15-0.5	66 to 56*	56 to 46*
0.5-5	56	46
5-30	60	50

*Decreases with the logarithm of the frequency.

For terminal test result, the testing follows FCC KDB 174176.

3.1.2 Measuring Instruments

Please refer to the measuring equipment list in this test report.

3.1.3 Test Procedures

1. The EUT is placed 0.4 meter away from the conducting wall of the shielding room, and is kept at least 80 centimeters from any other grounded conducting surface.
2. Connect EUT to the power mains through a line impedance stabilization network (LISN).
3. All the support units are connecting to the other LISN.
4. The LISN provides 50 ohm coupling impedance for the measuring instrument.
5. The FCC states that a 50 ohm, 50 microhenry LISN shall be used.
6. Both Line and Neutral shall be tested in order to find out the maximum conducted emission.
7. The frequency range from 150 kHz to 30 MHz is scanned.
8. Set the test-receiver system to Peak Detect Function and specified bandwidth (IF Bandwidth = 9 kHz) with Maximum Hold Mode. Then measurement is also conducted by Average Detector and Quasi-Peak Detector Function respectively.

3.1.4 Test setup

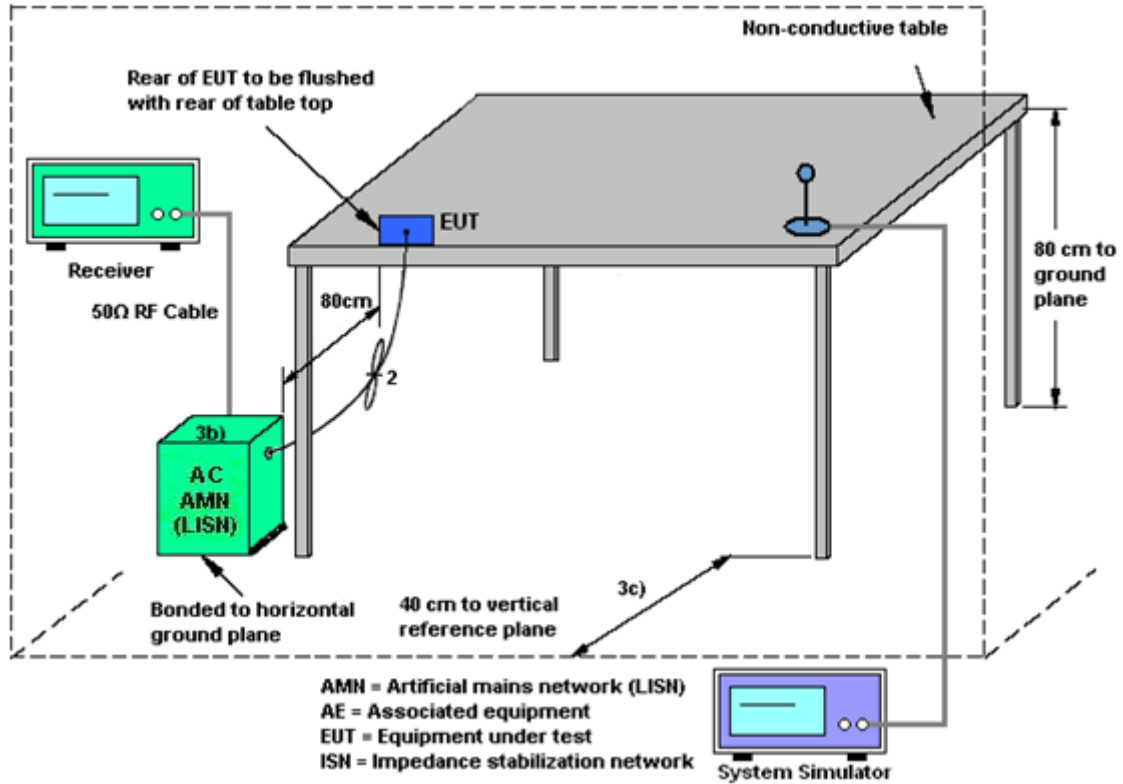

3.1.5 Test Result of AC Conducted Emission

Please refer to Appendix A.

Note:

(1) with antenna

Remark: 13.560MHz is the NFC RF fundamental signal.

(2) with dummy load

Remark: Only the fundamental NFC signal needs to be retested per C63.4.

3.2 20dB and 99% OBW Spectrum Bandwidth Measurement

3.2.1 Limit

Intentional radiators must be designed to ensure that the 20 dB and 99% emission bandwidth in the specific band 13.553~13.567 MHz.

3.2.2 Measuring Instruments

Please refer to the measuring equipment list in this test report.

3.2.3 Test Procedures

1. The spectrum analyzer connected via a receive antenna placed near the EUT in peak Max Hold Mode.
2. The resolution bandwidth of 1 kHz and the video bandwidth of 3 kHz were used.
3. Measured the spectrum width with power higher than 20 dB below carrier.
4. Measured the 99% OBW.

3.2.4 Test Setup

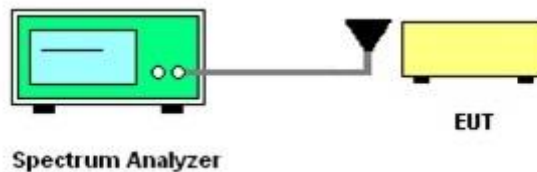

3.2.5 Test Result of Near Field Test Items

Please refer to Appendix B.

3.3 Frequency Stability Measurement

3.3.1 Limit

The frequency tolerance of the carrier signal shall be maintained within +/- 0.01% (100ppm) of the operating frequency over a temperature variation of -20 degrees to +50 degrees C at normal supply voltage, and for a variation in the primary supply voltage from 85% to 115% of the rated supply voltage at a temperature of 20 degrees C. For battery operated equipment, the equipment tests shall be performed by using a new battery.

3.3.2 Measuring Instruments

Please refer to the measuring equipment list in this test report.

3.3.3 Test Procedures

1. The spectrum analyzer connected via a receive antenna placed near the EUT.
2. EUT has transmitted signal and fixed channelize.
3. Set the spectrum analyzer span to view the entire emissions bandwidth.
4. Set RBW = 1 kHz, VBW = 3 kHz with peak detector and maxhold settings.
5. The f_c is declaring of channel frequency. Then the frequency error formula is $(f_c - f) / f_c \times 10^6$ ppm and the limit is less than ± 100 ppm.
6. Extreme temperature rule is -20°C~50°C.

3.3.4 Test Setup

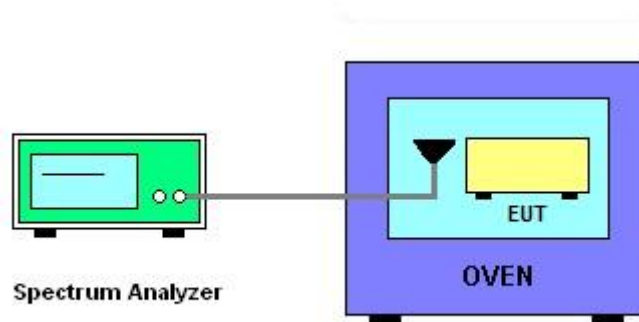

3.3.5 Test Result of Near Field Test Items

Please refer to Appendix B.



3.4 Field Strength of Fundamental Emissions and Mask Measurement

3.4.1 Limit

Rules and specifications	FCC CFR 47 Part 15 section 15.225			
Description	Compliance with the spectrum mask is tested with RBW set to 9kHz.			
Freq. of Emission (MHz)	Field Strength (μV/m) at 30m	Field Strength (dBμV/m) at 30m	Field Strength (dBμV/m) at 10m	Field Strength (dBμV/m) at 3m
1.705~13.110	30	29.5	48.58	69.5
13.110~13.410	106	40.5	59.58	80.5
13.410~13.553	334	50.5	69.58	90.5
13.553~13.567	15848	84.0	103.08	124.0
13.567~13.710	334	50.5	69.58	90.5
13.710~14.010	106	40.5	59.58	80.5
14.010~30.000	30	29.5	48.58	69.5

Remark:

1. The field strength test result is in 3m test distance, follow test rules the test data use distance extrapolation factor and reported in this report at 30m test result.
2. Distance extrapolation factor = 40 log (specific distance / test distance) (dB)

3.4.2 Measuring Instruments

Please refer to the measuring equipment list in this test report.

3.4.3 Test Procedures

1. Configure the EUT according to ANSI C63.10. The EUT is placed on the top of the turntable 0.8 meter above ground. The phase center of the loop receiving antenna mounted antenna tower is placed 3 meters far away from the turntable.
 2. Power on the EUT and all the supporting units. The turntable is rotated by 360 degrees to determine the position of the highest radiation.
 3. The height of the receiving antenna is fixed at one meter above ground to find the maximum emissions field strength.
 4. For Fundamental emissions, use the receiver to measure QP reading.
 5. When the radiated emissions limits are expressed in terms of the average value of the emissions, and pulsed operation is employed, the measurement field strength shall be determined by averaging over one complete pulse train, including blanking intervals, as long as the pulse train does not exceed 0.1 seconds. As an alternative (provided the transmitter operates for longer than 0.1 seconds) or in cases where the pulse train exceeds 0.1 seconds, the measured field strength shall be determined from the average absolute voltage during a 0.1 second interval during which the field strength is at its maximum value.
 6. Compliance with the spectrum mask is tested with RBW set to 9 kHz.
- Note: Emission level (dB μ V/m) = 20 log Emission level (μ V/m).

3.4.4 Test Setup

For radiated test below 30MHz

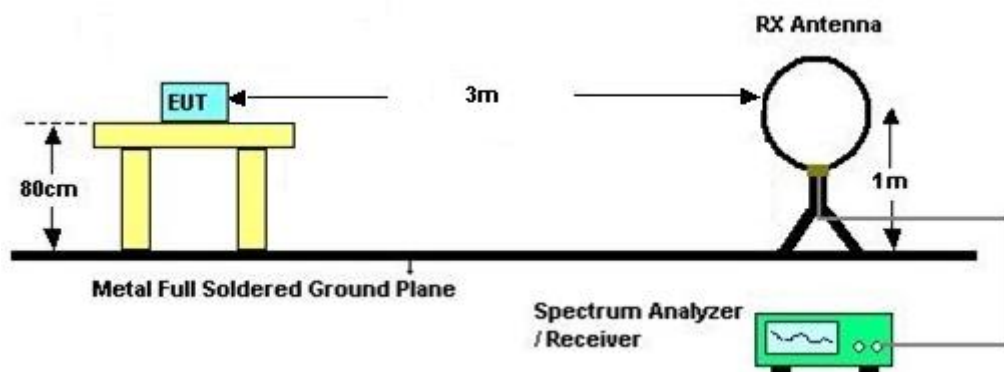

3.4.5 Test Result of Field Strength of Fundamental Emissions and Mask

Please refer to Appendix C.



3.5 Radiated Emissions Measurement

3.5.1 Limit

The field strength of any emissions which appear outside of 13.110 ~14.010MHz band shall not exceed the general radiated emissions limits.

Frequencies (MHz)	Field Strength (µV/m)	Measurement Distance (meters)
0.009~0.490	2400/F(kHz)	300
0.490~1.705	24000/F(kHz)	30
1.705~30.0	30	30
30~88	100	3
88~216	150	3
216~960	200	3
Above 960	500	3

3.5.2 Measuring Instruments

Please refer to the measuring equipment list in this test report.

3.5.3 Measuring Instrument Setting

The following table is the setting of receiver:

Receiver Parameter	Setting
Attenuation	Auto
Frequency Range: 9kHz~150kHz	RBW 200Hz for QP
Frequency Range: 150kHz~30MHz	RBW 9kHz for QP
Frequency Range: 30MHz~1000MHz	RBW 120kHz for Peak

Note: The emission limits shown in the above table are based on measurements employing a CISPR quasi-peak detector except for the frequency bands 9-90 kHz and 110-490 kHz. Radiated emission limits in these two bands are based on measurements employing an average detector.



3.5.4 Test Procedures

1. Configure the EUT according to ANSI C63.10. The EUT is placed on the top of the turntable 0.8 meter above ground. The phase center of the receiving antenna mounted on the top of a height-variable antenna tower is placed 3 meters far away from the turntable.
2. Power on the EUT and all the supporting units. The turntable is rotated by 360 degrees to determine the position of the highest radiation.
3. The height of the broadband receiving antenna is varied between one meter and four meters above ground to find the maximum emissions field strength of both horizontal and vertical polarization.
4. For each suspected emissions, the antenna tower is scanned (from 1 M to 4 M) and then the turntable is rotated (from 0 degree to 360 degrees) to find the maximum reading.
5. Set the test-receiver system to Peak or CISPR quasi-peak Detect Function with specified bandwidth under Maximum Hold Mode.
6. When the radiated emissions limits are expressed in terms of the average value of the emissions, and pulsed operation is employed, the measurement field strength shall be determined by averaging over one complete pulse train, including blanking intervals, as long as the pulse train does not exceed 0.1 seconds. As an alternative (provided the transmitter operates for longer than 0.1 seconds) or in cases where the pulse train exceeds 0.1 seconds, the measured field strength shall be determined from the average absolute voltage during a 0.1 second interval during which the field strength is at its maximum value.
7. In case the emission is lower than 30 MHz, loop antenna has to be used for measurement and the recorded data shall be QP measured by receiver.
8. Radiated testing below 1 GHz is performed by adjusting the antenna tower from 1 m to 4 m and by rotating the turn table from 0 degree to 360 degrees to find the peak maximum hold reading. When there is no suspected emission found and the emission level is with at least 6 dB margin against QP limit line, the position is marked as “-“.

3.5.5 Test Setup

For radiated test below 30MHz

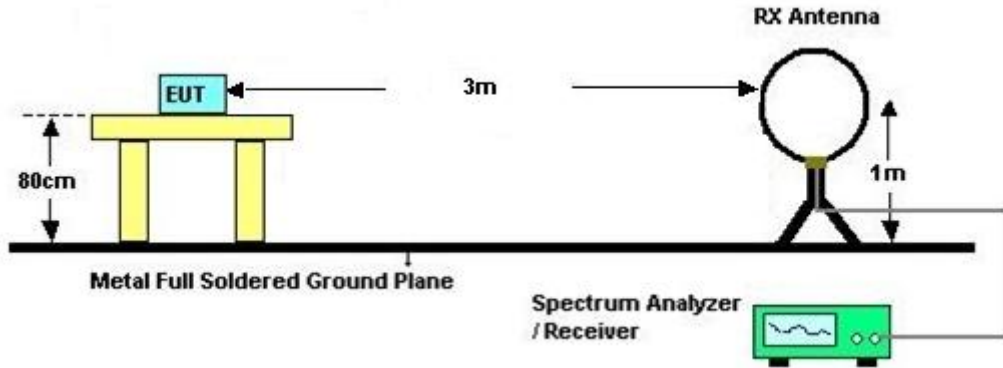

For radiated test above 30MHz

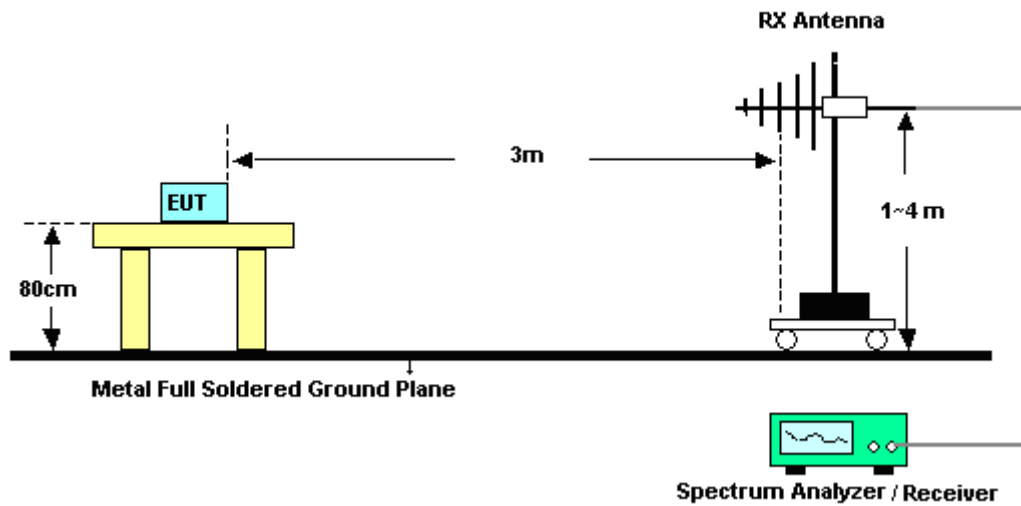

3.5.6 Test Result of Radiated Emissions Measurement

Please refer to Appendix C.

Remark: There is adequate comparison measurement of both open-field test site and alternative test site - semi-Anechoic chamber according to 414788 D01 Radiated Test Site v01r01, and the result came out very similar.



3.6 Antenna Requirements

3.6.1 Standard Applicable

Except for special regulations, the Low-power Radio-frequency Devices must not be equipped with any jacket for installing an antenna with extension cable. An intentional radiator shall be designed to ensure that no antenna other than that furnished by the responsible party shall be used with the device. The use of a permanently attached antenna or of an antenna that uses a unique coupling to the intentional radiator shall be considered sufficient to comply with the provisions of this Section. The manufacturer may design the unit so that the user can replace a broken antenna, but the use of a standard antenna jack or electrical connector is prohibited.

The use of a permanently attached antenna or of an antenna that uses a unique coupling to the intentional radiator shall be considered sufficient to comply with the rule.

3.6.2 Antenna Anti-Replacement Construction

An embedded-in antenna design is used.



4. List of Measuring Equipment

Instrument	Brand Name	Model No.	Serial No.	Characteristics	Calibration Date	Test Date	Due Date	Remark
Bilog Antenna	TESEQ	CBL 6111D & 00800N1D01N-06	35419 & 03	30MHz~1GHz	Apr. 24, 2022	Sep. 27, 2022~Sep. 28, 2022	Apr. 23, 2023	Radiation (03CH07-HY)
Preamplifier	COM-POWER	PA-103A	161241	10MHz~1GHz	Oct. 04, 2021	Sep. 27, 2022~Sep. 28, 2022	Oct. 03, 2022	Radiation (03CH07-HY)
Loop Antenna	TESEQ	HLA 6120	31244	9 kHz~30 MHz	Mar. 18, 2022	Sep. 27, 2022~Sep. 28, 2022	Mar. 17, 2023	Radiation (03CH07-HY)
Spectrum Analyzer	Agilent	N9030A	MY52350276	3Hz~44GHz	Jul. 22, 2022	Sep. 27, 2022~Sep. 28, 2022	Jul. 21, 2023	Radiation (03CH07-HY)
RF Cable	HUBER + SUHNER	SUCOFLEX 104	MY15682/4	30MHz to 18GHz	Feb. 23, 2022	Sep. 27, 2022~Sep. 28, 2022	Feb. 22, 2023	Radiation (03CH07-HY)
RF Cable	HUBER + SUHNER	SUCOFLEX 104	MY24971/4	9kHz to 18GHz	Feb. 23, 2022	Sep. 27, 2022~Sep. 28, 2022	Feb. 22, 2023	Radiation (03CH07-HY)
RF Cable	HUBER + SUHNER	SUCOFLEX 104	MY28655/4	9kHz to 18GHz	Feb. 23, 2022	Sep. 27, 2022~Sep. 28, 2022	Feb. 22, 2023	Radiation (03CH07-HY)
Controller	EMEC	EM1000	N/A	Control Ant Mast	N/A	Sep. 27, 2022~Sep. 28, 2022	N/A	Radiation (03CH07-HY)
Controller	MF	MF-7802	N/A	Control Turn table	N/A	Sep. 27, 2022~Sep. 28, 2022	N/A	Radiation (03CH07-HY)
Antenna Mast	EMEC	AM-BS-4500E	N/A	Boresight mast 1M~4M	N/A	Sep. 27, 2022~Sep. 28, 2022	N/A	Radiation (03CH07-HY)
Turn Table	ChainTek	Chaintek 3000	N/A	0~360 Degree	N/A	Sep. 27, 2022~Sep. 28, 2022	N/A	Radiation (03CH07-HY)
Software	Audix	E3	N/A	N/A	N/A	Sep. 27, 2022~Sep. 28, 2022	N/A	Radiation (03CH07-HY)
USB Data Logger	TECPEL	TR-32	HE17XB2495	N/A	Mar. 07, 2022	Sep. 27, 2022~Sep. 28, 2022	Mar. 06, 2023	Radiation (03CH07-HY)
EMI Test Receiver	Agilent	N9038A(MXE)	MY53290053	20Hz~26.5GHz	May 27, 2022	Sep. 27, 2022~Sep. 28, 2022	May 26, 2023	Radiation (03CH07-HY)
AC Power Source	ChainTek	APC-1000W	N/A	N/A	N/A	Sep. 19, 2022~Sep. 23, 2022	N/A	Conduction (CO05-HY)
EMI Test Receiver	Rohde & Schwarz	ESR3	102388	9kHz~3.6GHz	Dec. 01, 2021	Sep. 19, 2022~Sep. 23, 2022	Nov. 30, 2022	Conduction (CO05-HY)
Hygrometer	Testo	608-H1	34913912	N/A	Nov. 17, 2021	Sep. 19, 2022~Sep. 23, 2022	Nov. 16, 2022	Conduction (CO05-HY)
LISN	Rohde & Schwarz	ENV216	100081	9kHz~30MHz	Nov. 16, 2021	Sep. 19, 2022~Sep. 23, 2022	Nov. 15, 2022	Conduction (CO05-HY)
Software	Rohde & Schwarz	EMC32	N/A	N/A	N/A	Sep. 19, 2022~Sep. 23, 2022	N/A	Conduction (CO05-HY)
Pulse Limiter	SCHWARZBECK	VTSD 9561-F N	00691	N/A	Aug. 01, 2022	Sep. 19, 2022~Sep. 23, 2022	Jul. 31, 2023	Conduction (CO05-HY)
LISN Cable	MVE	RG-400	260260	N/A	Dec. 30, 2021	Sep. 19, 2022~Sep. 23, 2022	Dec. 29, 2022	Conduction (CO05-HY)
Hygrometer	TECPEL	DTM-303B	TP210073	N/A	Nov. 16, 2021	Sep. 29, 2022	Nov. 15, 2022	RF Near Field (TH03-HY)
Spectrum Analyzer	Rohde & Schwarz	FSP30	101329	9kHz~30GHz	Sep. 27, 2022	Sep. 29, 2022	Sep. 26, 2023	RF Near Field (TH03-HY)
Temperature & Humidity Cabinet Chamber	ESPEC	LHU-113	1012005860	-20°C~85°C	Dec. 09, 2021	Sep. 29, 2022	Dec. 08, 2022	RF Near Field (TH03-HY)
Nearby field probe	LANGER EMV-TECHNIK	LF-U5	02-559	100 kHz up to 50 MHz	Apr. 04, 2022	Sep. 29, 2022	Apr. 03, 2023	RF Near Field (TH03-HY)



5. Uncertainty of Evaluation

Uncertainty of Conducted Emission Measurement (150 kHz ~ 30 MHz)

Measuring Uncertainty for a Level of Confidence of 95% ($U = 2Uc(y)$)	3.1 dB
---	--------

Uncertainty of Radiated Emission Measurement (9 kHz ~ 30 MHz)

Measuring Uncertainty for a Level of Confidence of 95% ($U = 2Uc(y)$)	3.7 dB
---	--------

Uncertainty of Radiated Emission Measurement (30 MHz ~ 1000 MHz)

Measuring Uncertainty for a Level of Confidence of 95% ($U = 2Uc(y)$)	5.1 dB
---	--------



Appendix A. Test Results of Conducted Emission Test

Test Engineer :	Tom Lee	Temperature :	23~26°C
		Relative Humidity :	45~55%

Original

Report NO : 241215-02
 Test Mode : Mode 1
 Test Voltage : 120Vac/60Hz
 Phase : Line

Full Spectrum

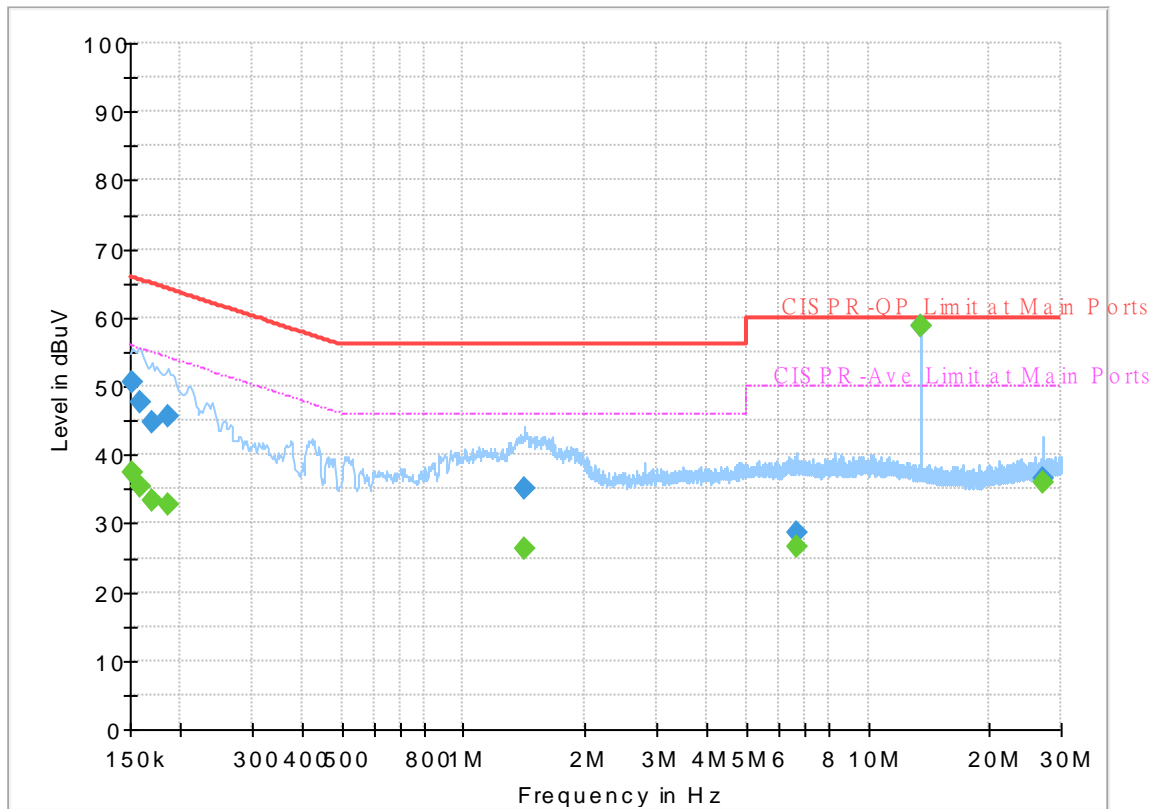

Final_Result

Frequency (MHz)	QuasiPeak (dBuV)	CAverage (dBuV)	Limit (dBuV)	Margin (dB)	Line	Filter	Corr. (dB)
0.152250	---	37.36	55.88	18.52	L1	OFF	19.8
0.152250	50.62	---	65.88	15.26	L1	OFF	19.8
0.159000	---	35.25	55.52	20.27	L1	OFF	19.8
0.159000	47.52	---	65.52	18.00	L1	OFF	19.8
0.170250	---	33.23	54.95	21.72	L1	OFF	19.8
0.170250	44.73	---	64.95	20.22	L1	OFF	19.8
0.186000	---	32.79	54.21	21.42	L1	OFF	19.8
0.186000	45.61	---	64.21	18.60	L1	OFF	19.8
1.414500	---	26.39	46.00	19.61	L1	OFF	19.9
1.414500	35.10	---	56.00	20.90	L1	OFF	19.9
6.693000	---	26.62	50.00	23.38	L1	OFF	20.1
6.693000	28.52	---	60.00	31.48	L1	OFF	20.1
13.560000	---	58.69	50.00	-8.69	L1	OFF	20.3
13.560000	58.63	---	60.00	1.37	L1	OFF	20.3
27.120000	---	35.82	50.00	14.18	L1	OFF	20.7
27.120000	36.67	---	60.00	23.33	L1	OFF	20.7

Report NO : 241215-02
 Test Mode : Mode 1
 Test Voltage : 120Vac/60Hz
 Phase : Neutral

Full Spectrum

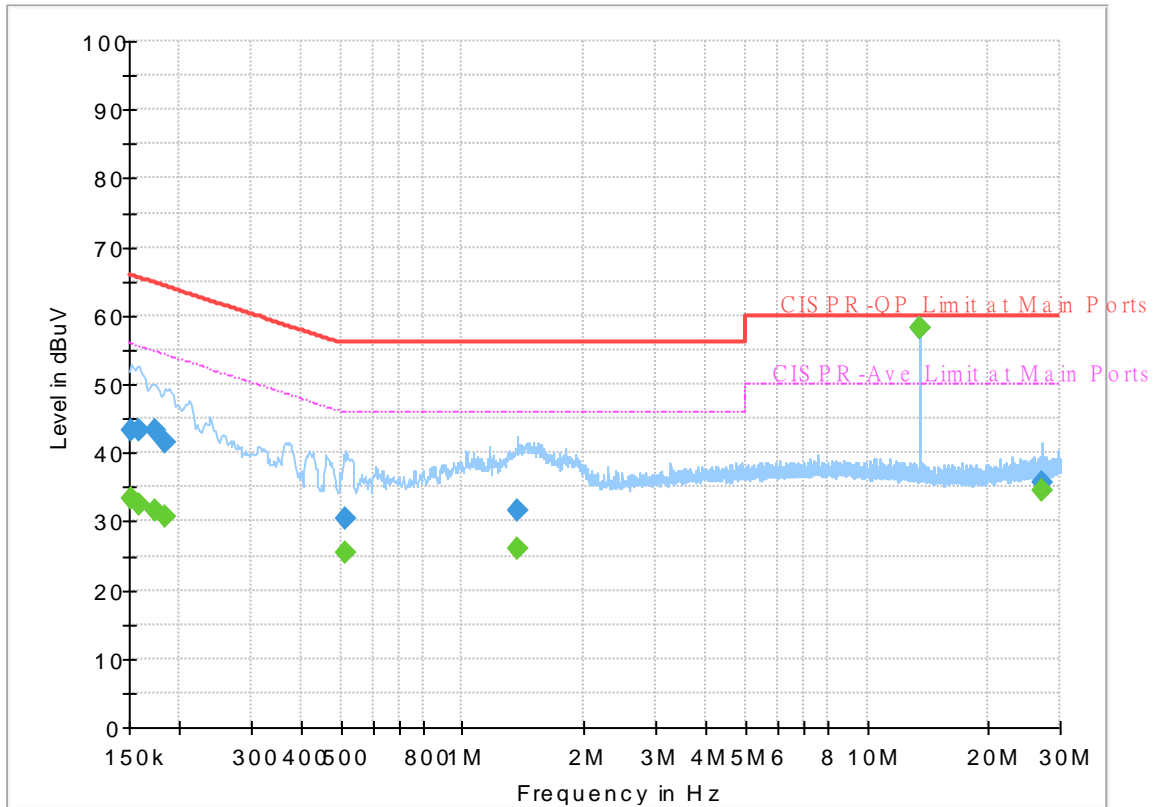

Final_Result

Frequency (MHz)	QuasiPeak (dBuV)	CAverage (dBuV)	Limit (dBuV)	Margin (dB)	Line	Filter	Corr. (dB)
0.152250	---	33.37	55.88	22.51	N	OFF	19.8
0.152250	43.36	---	65.88	22.52	N	OFF	19.8
0.159000	---	32.45	55.52	23.07	N	OFF	19.8
0.159000	43.17	---	65.52	22.35	N	OFF	19.8
0.174750	---	31.65	54.73	23.08	N	OFF	19.8
0.174750	43.15	---	64.73	21.58	N	OFF	19.8
0.183750	---	30.72	54.31	23.59	N	OFF	19.8
0.183750	41.61	---	64.31	22.70	N	OFF	19.8
0.514500	---	25.42	46.00	20.58	N	OFF	19.8
0.514500	30.27	---	56.00	25.73	N	OFF	19.8
1.367250	---	25.90	46.00	20.10	N	OFF	19.9
1.367250	31.65	---	56.00	24.35	N	OFF	19.9
13.560000	---	58.21	50.00	-8.21	N	OFF	20.4
13.560000	58.14	---	60.00	1.86	N	OFF	20.4
27.120000	---	34.56	50.00	15.44	N	OFF	20.8
27.120000	35.53	---	60.00	24.47	N	OFF	20.8

Terminal

Report NO : 241215-02
 Test Mode : Mode 1
 Test Voltage : 120Vac/60Hz
 Phase : Line

Full Spectrum

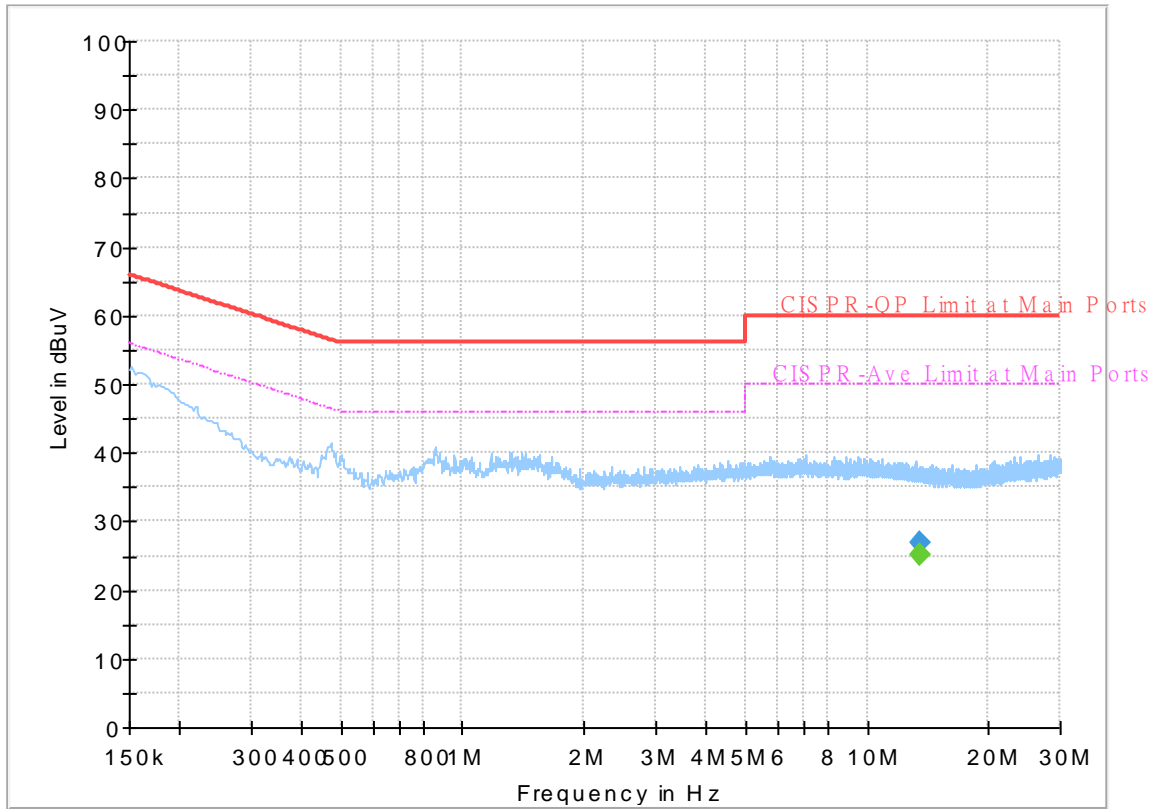

Final_Result

Frequency (MHz)	QuasiPeak (dBuV)	CAverage (dBuV)	Limit (dBuV)	Margin (dB)	Line	Filter	Corr. (dB)
13.560000	---	25.27	50.00	24.73	L1	OFF	20.3
13.560000	26.90	---	60.00	33.10	L1	OFF	20.3

Report NO : 241215-02
 Test Mode : Mode 1
 Test Voltage : 120Vac/60Hz
 Phase : Neutral

Full Spectrum

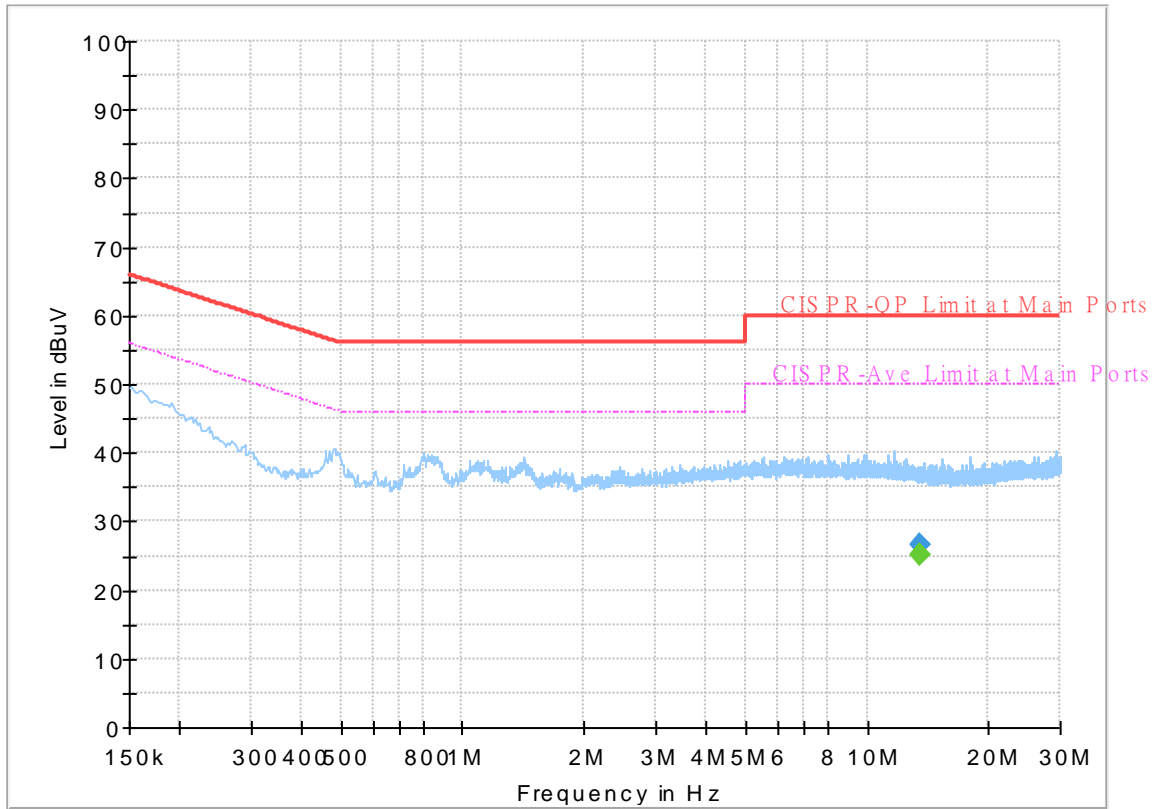

Final_Result

Frequency (MHz)	QuasiPeak (dBuV)	CAverage (dBuV)	Limit (dBuV)	Margin (dB)	Line	Filter	Corr. (dB)
13.560000	---	25.23	50.00	24.77	N	OFF	20.4
13.560000	26.74	---	60.00	33.26	N	OFF	20.4



Appendix B. Test Results of Near Field Test Items

B1. Test Result of 20dB Spectrum Bandwidth

Test mode	NFC Tx	Test Frequency (MHz)	13.56
20dB Bandwidth (kHz)	2.640	99% OccupiedBW(kHz)	2.240
Frequency range (MHz)	$f_L > 13.553$	13.55868	Test Result
	$f_H < 13.567$	13.56132	Complies

Remark: Because the measured signal is CW adjusting the RBW per C63.10 would not be practical since measured bandwidth will always follow the RBW and the result will be approximately twice the RBW.



B2. Test Result of Frequency Stability

Voltage vs. Frequency Stability		Temperature vs. Frequency Stability		
Voltage (Vdc)	Measurement Frequency (MHz)	Temperature (°C)	Time	Measurement Frequency (MHz)
3.85	13.560000	-20	0	13.560060
			2	13.560060
			5	13.560080
			10	13.560060
3.6	13.560000	-10	0	13.560070
			2	13.560060
			5	13.560060
			10	13.560070
4.45	13.560000	0	0	13.560040
			2	13.560040
			5	13.560050
			10	13.560060
		10	0	13.560020
			2	13.560020
			5	13.560020
			10	13.560020
		20	0	13.560000
			2	13.560000
			5	13.560000
			10	13.560000
		30	0	13.560040
			2	13.560040
			5	13.560030
			10	13.560020
		40	0	13.560000
			2	13.560000
			5	13.560000
			10	13.560000



Voltage vs. Frequency Stability		Temperature vs. Frequency Stability		
Voltage (Vdc)	Measurement Frequency (MHz)	Temperature (°C)	Time	Measurement Frequency (MHz)
		50	0	13.559980
			2	13.559980
			5	13.559970
			10	13.559980
Max.Deviation (MHz)	0.000000	Max.Deviation (MHz)		0.000080
Max.Deviation (ppm)	0.0000	Max.Deviation (ppm)		5.8997
Limit	FS < ±100 ppm	Limit		FS < ±100 ppm
Test Result	PASS	Test Result		PASS



Appendix C. Test Results of Radiated Test Items

C1. Test Result of Field Strength of Fundamental Emissions

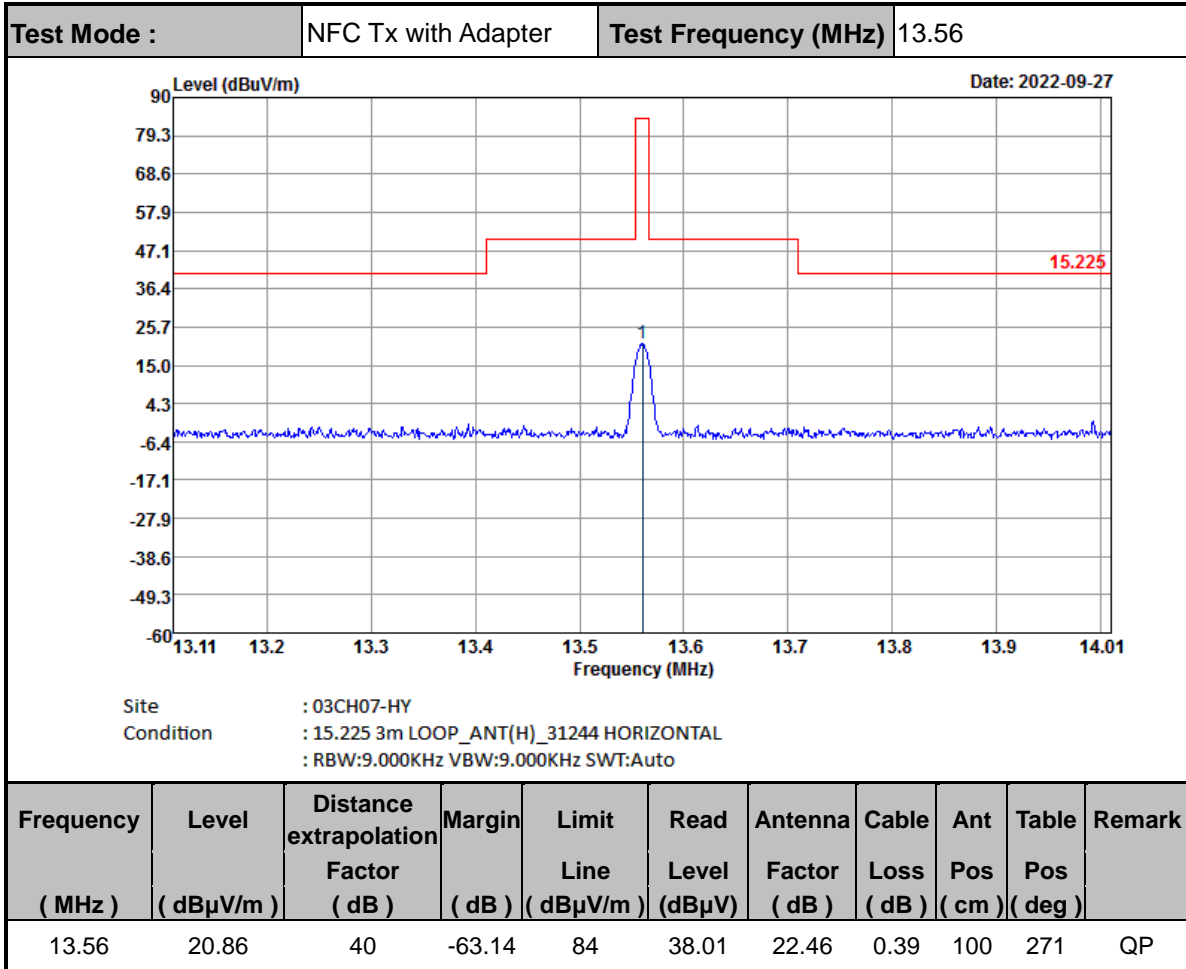



Test Mode :	NFC Tx with Adapter	Test Frequency (MHz)	13.56
-------------	---------------------	----------------------	-------

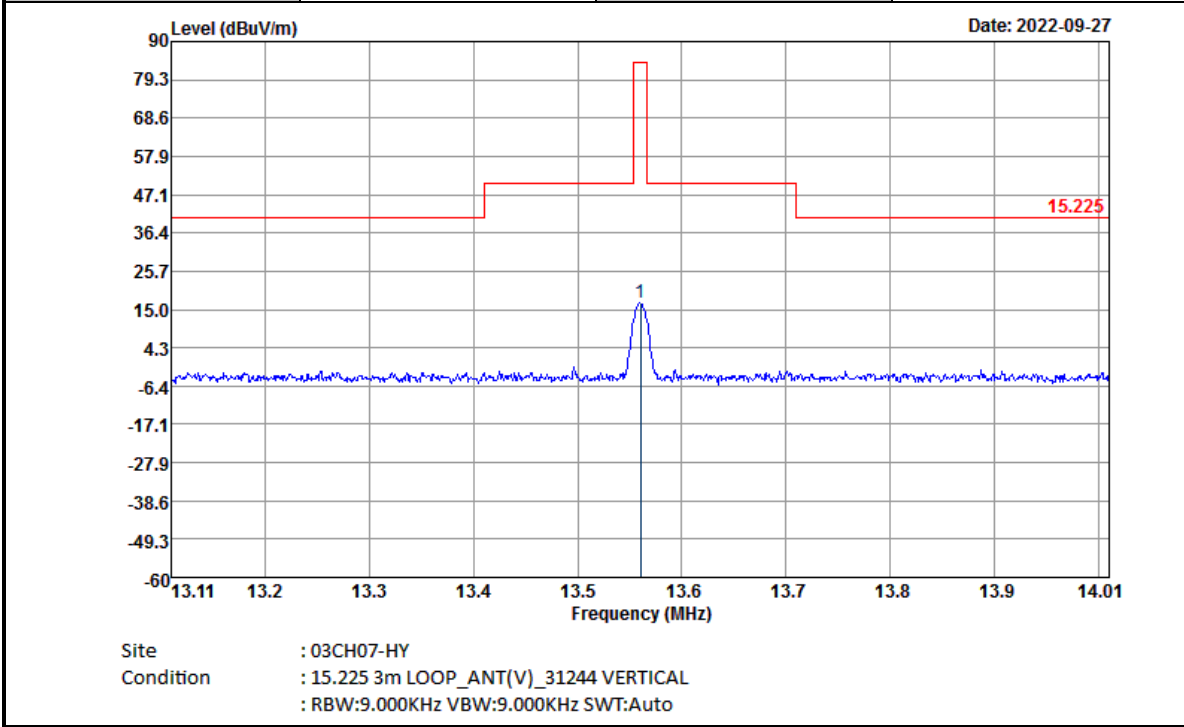

Frequency (MHz)	Level (dBμV/m)	Distance extrapolation Factor (dB)	Margin (dB)	Limit Line (dBμV/m)	Read Level (dBμV)	Antenna Factor (dB)	Cable Loss (dB)	Ant Pos (cm)	Table Pos (deg)	Remark
13.56	16.73	40	-67.27	84	33.88	22.46	0.39	100	356	QP

Note :

1. Distance extrapolation factor = 40 log (specific distance / test distance) (dB)
2. Level = Antenna Factor + Cable Loss + Read Level - Distance extrapolation factor.

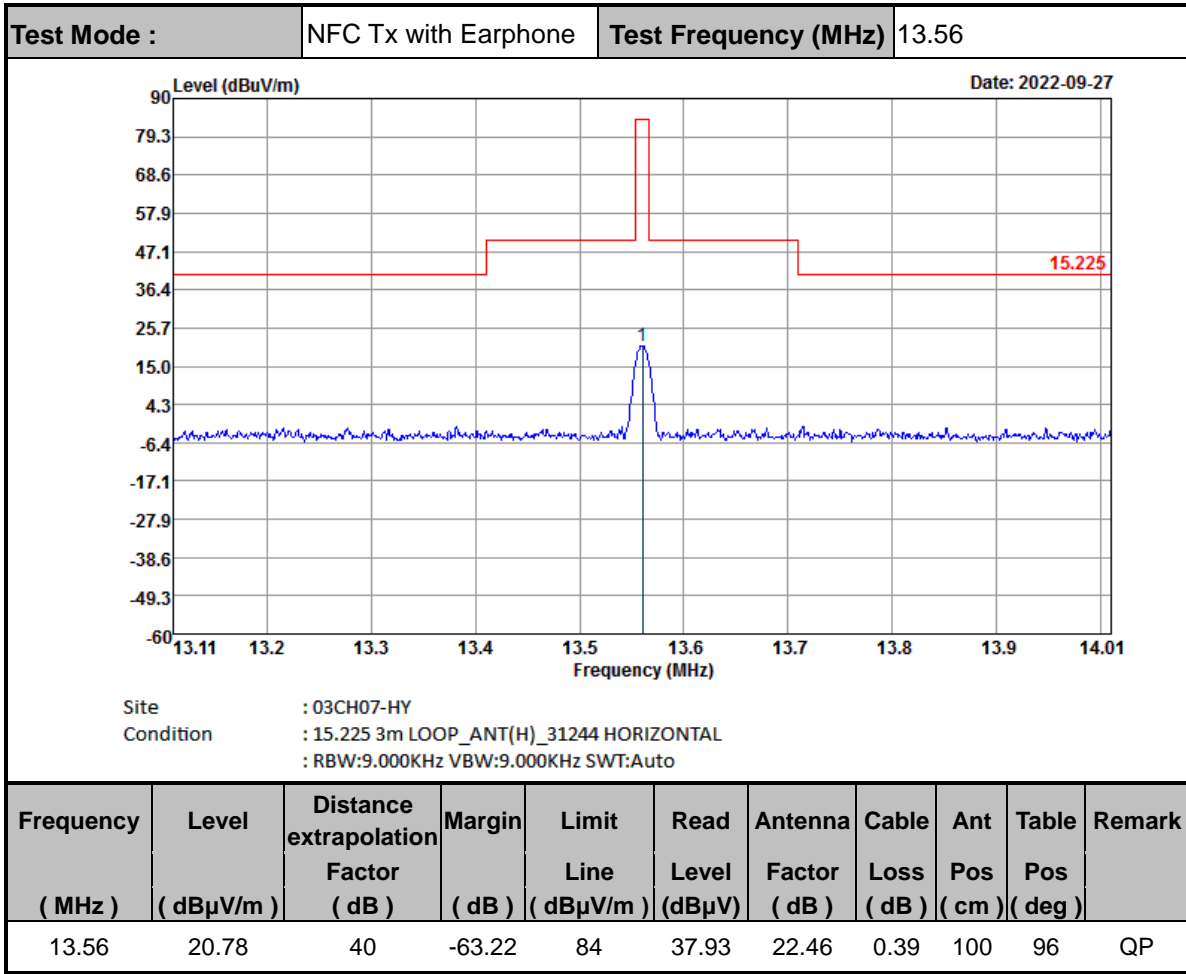



Test Mode :	NFC Tx with Earphone	Test Frequency (MHz)	13.56
--------------------	----------------------	-----------------------------	-------

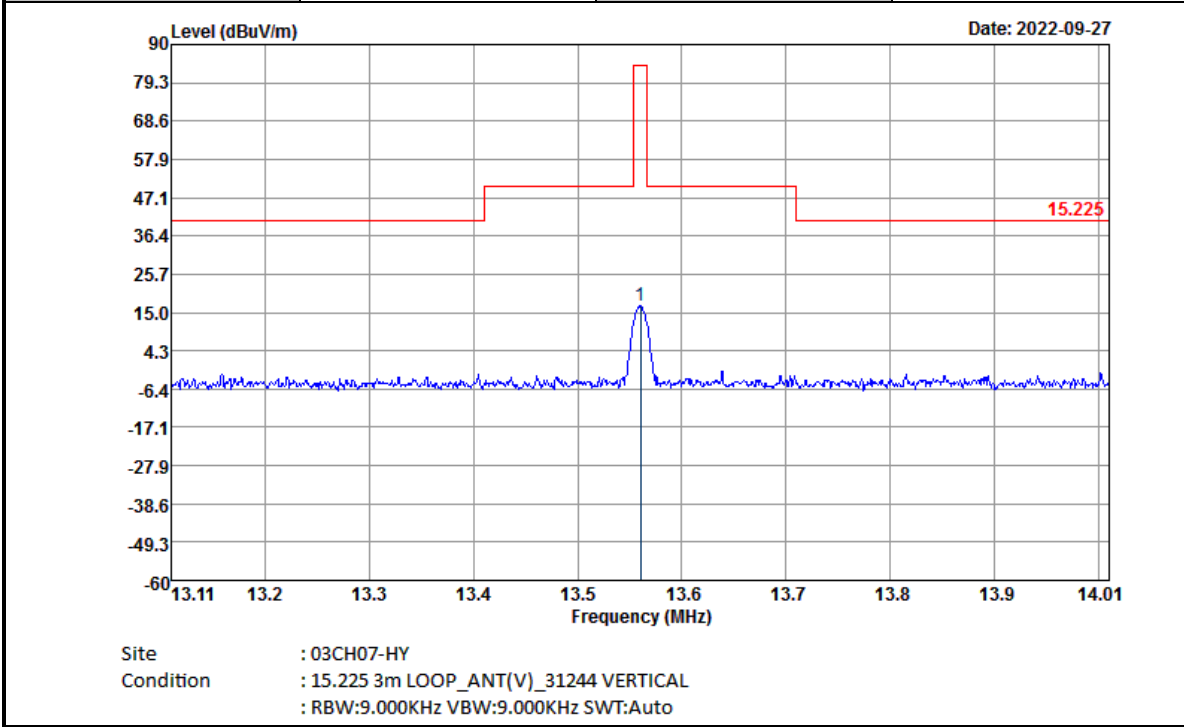

Frequency (MHz)	Level (dBμV/m)	Distance extrapolation Factor (dB)	Margin (dB)	Limit Line (dBμV/m)	Read Level (dBμV)	Antenna Factor (dB)	Cable Loss (dB)	Ant Pos (cm)	Table Pos (deg)	Remark
13.56	16.69	40	-67.31	84	33.84	22.46	0.39	100	12	QP

Note :

1. Distance extrapolation factor = 40 log (specific distance / test distance) (dB)
2. Level = Antenna Factor + Cable Loss + Read Level - Distance extrapolation factor.

C2. Results of Radiated Spurious Emissions (9 kHz~30MHz)

Test Mode :	NFC Tx with Adapter	Polarization :	Horizontal
--------------------	---------------------	-----------------------	------------

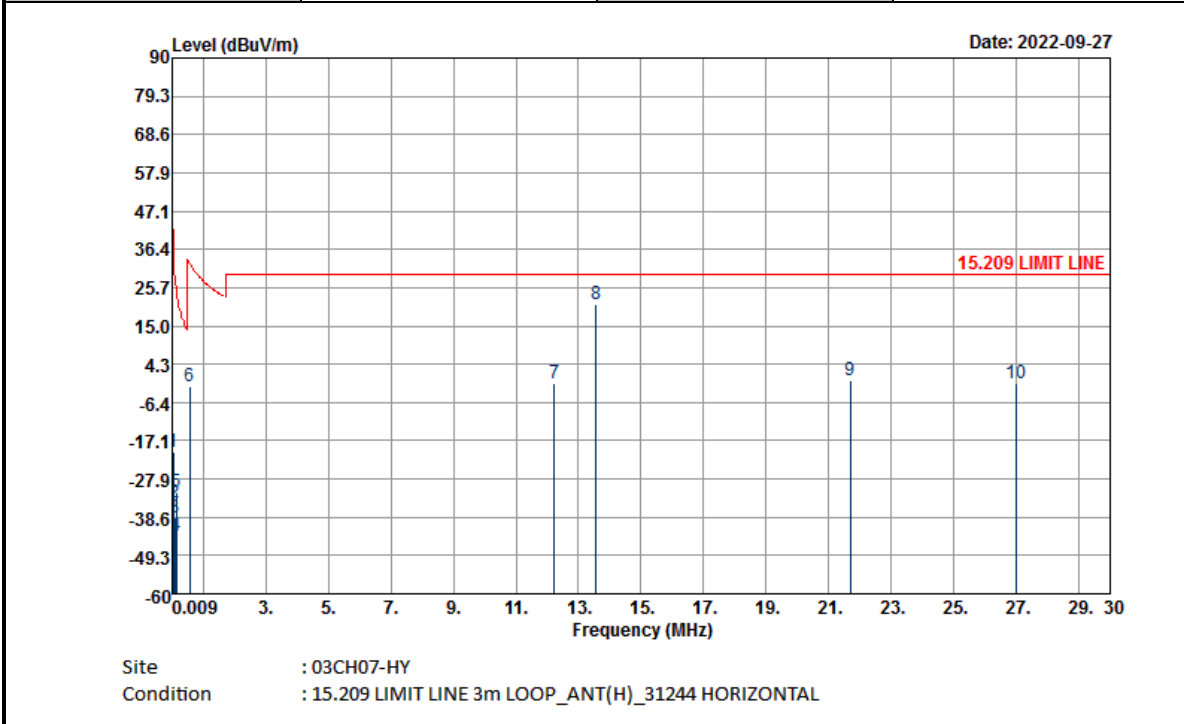

Frequency (MHz)	Level (dBμV/m)	Distance extrapolation Factor (dB)	Margin (dB)	Limit Line (dBμV/m)	Read Level (dBμV)	Antenna Factor (dB)	Cable Loss (dB)	Ant Pos (cm)	Table Pos (deg)	Remark
0.05011	-20.33	80	-53.94	33.61	38.85	20.8	0.02	-	-	Average
0.0684	-34.67	80	-65.57	30.9	24.91	20.4	0.02	-	-	Average
0.09892	-38.65	80	-66.35	27.7	21.61	19.72	0.02	-	-	QP
0.11308	-43.52	80	-70.06	26.54	16.73	19.73	0.02	-	-	Average
0.15068	-31.73	80	-55.77	24.04	28.41	19.83	0.03	-	-	Average
0.57261	-1.8	40	-34.25	32.45	17.91	20.21	0.08	-	-	QP
12.224	-0.89	40	-30.39	29.5	16.42	22.32	0.37	-	-	QP
13.56	20.86	40	-8.64	29.5	38.01	22.46	0.39	-	-	QP
21.697	-0.37	40	-29.87	29.5	15.94	23.13	0.56	-	-	QP
26.995	-1.22	40	-30.72	29.5	14.79	23.24	0.75	-	-	QP



Test Mode :	NFC Tx with Adapter	Polarization :	Vertical
-------------	---------------------	----------------	----------

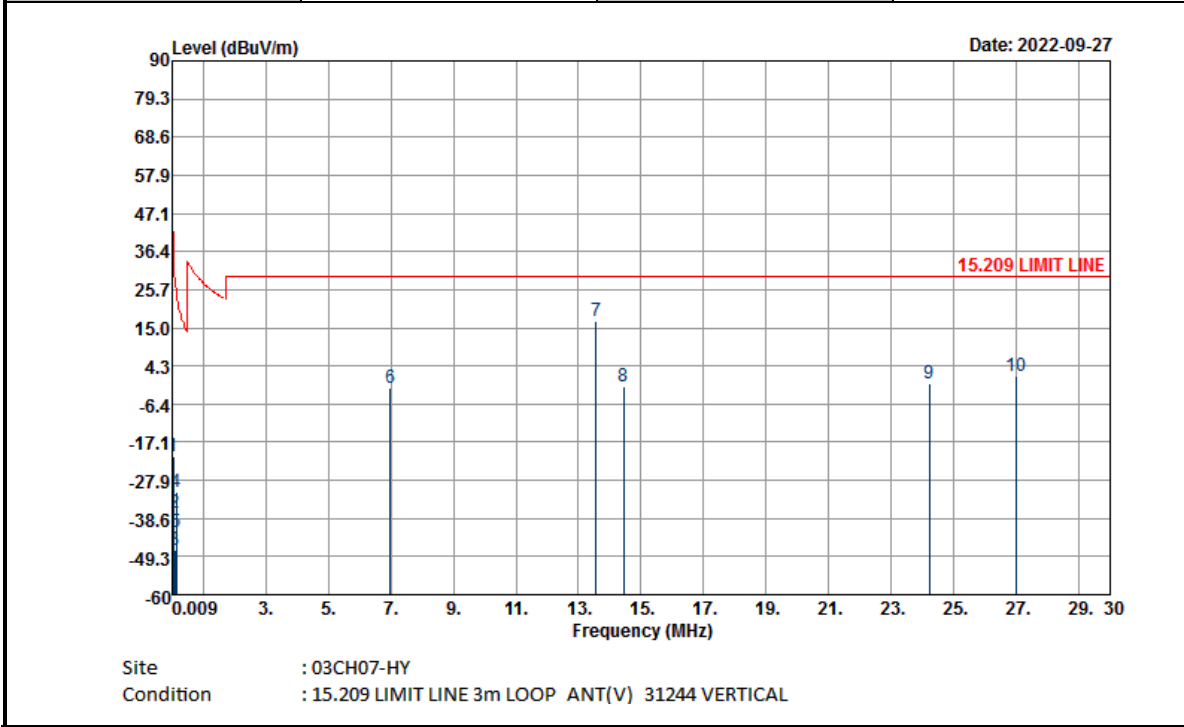

Frequency (MHz)	Level (dBμV/m)	Distance extrapolation Factor (dB)	Margin (dB)	Limit Line (dBμV/m)	Read Level (dBμV)	Antenna Factor (dB)	Cable Loss (dB)	Ant Pos (cm)	Table Pos (deg)	Remark
0.05011	-21.14	80	-54.75	33.61	38.04	20.8	0.02	-	-	Average
0.06342	-37.03	80	-68.59	31.56	22.45	20.5	0.02	-	-	Average
0.09444	-47.29	80	-75.39	28.1	12.87	19.82	0.02	-	-	QP
0.15	-31.31	80	-55.39	24.08	28.83	19.83	0.03	-	-	Average
0.15	-42.45	80	-66.53	24.08	17.69	19.83	0.03	-	-	Average
6.971	-1.99	40	-31.49	29.5	16.71	21.01	0.29	-	-	QP
13.56	16.73	40	-12.77	29.5	33.88	22.46	0.39	-	-	QP
14.44	-1.61	40	-31.11	29.5	15.44	22.54	0.41	-	-	QP
24.226	-0.63	40	-30.13	29.5	15.59	23.18	0.6	-	-	QP
27.005	1.45	40	-28.05	29.5	17.46	23.24	0.75	-	-	QP



Test Mode :	NFC Tx with Earphone	Polarization :	Horizontal
--------------------	----------------------	-----------------------	------------

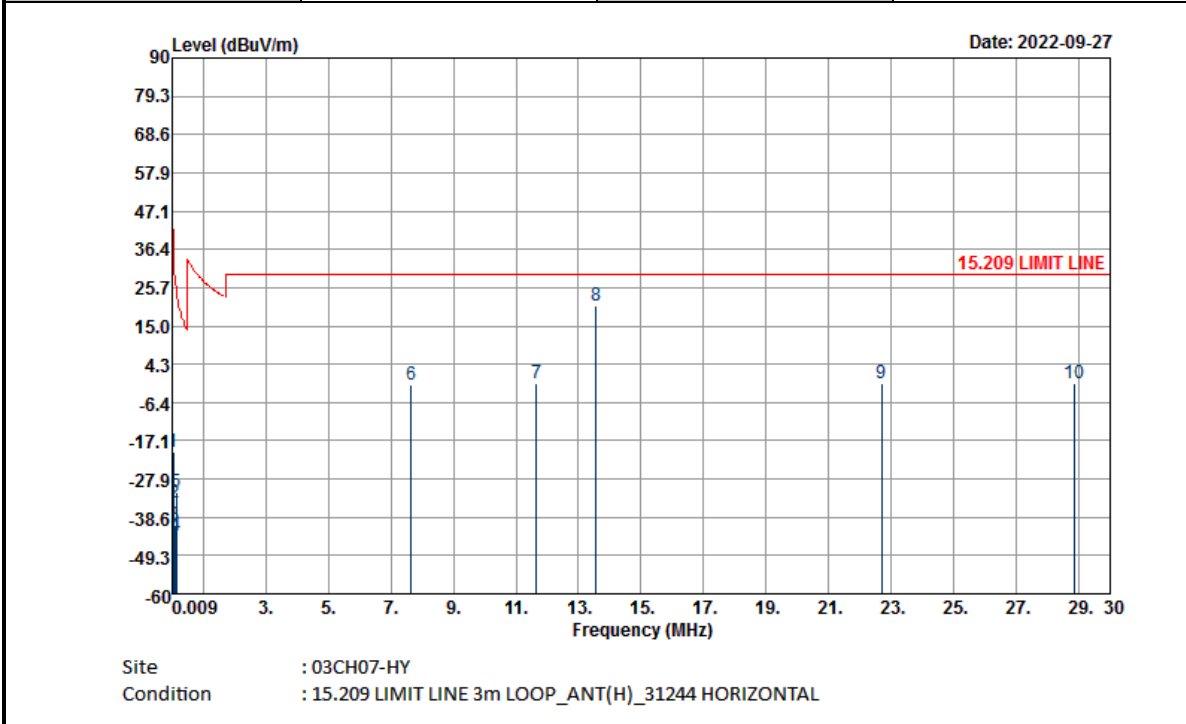

Frequency (MHz)	Level (dBμV/m)	Distance extrapolation Factor (dB)	Margin (dB)	Limit Line (dBμV/m)	Read Level (dBμV)	Antenna Factor (dB)	Cable Loss (dB)	Ant Pos (cm)	Table Pos (deg)	Remark
0.05011	-20.25	80	-53.86	33.61	38.93	20.8	0.02	-	-	Average
0.06843	-34.52	80	-65.42	30.9	25.07	20.39	0.02	-	-	Average
0.09048	-40.61	80	-69.08	28.47	19.46	19.91	0.02	-	-	QP
0.11312	-43.71	80	-70.24	26.53	16.54	19.73	0.02	-	-	Average
0.15034	-31.75	80	-55.81	24.06	28.39	19.83	0.03	-	-	Average
7.647	-1.36	40	-30.86	29.5	17.09	21.25	0.3	-	-	QP
11.656	-1.12	40	-30.62	29.5	16.25	22.27	0.36	-	-	QP
13.56	20.78	40	-8.72	29.5	37.93	22.46	0.39	-	-	QP
22.687	-1.18	40	-30.68	29.5	15.1	23.15	0.57	-	-	QP
28.865	-1.11	40	-30.61	29.5	14.72	23.28	0.89	-	-	QP



Test Mode : NFC Tx with Earphone Polarization : Vertical

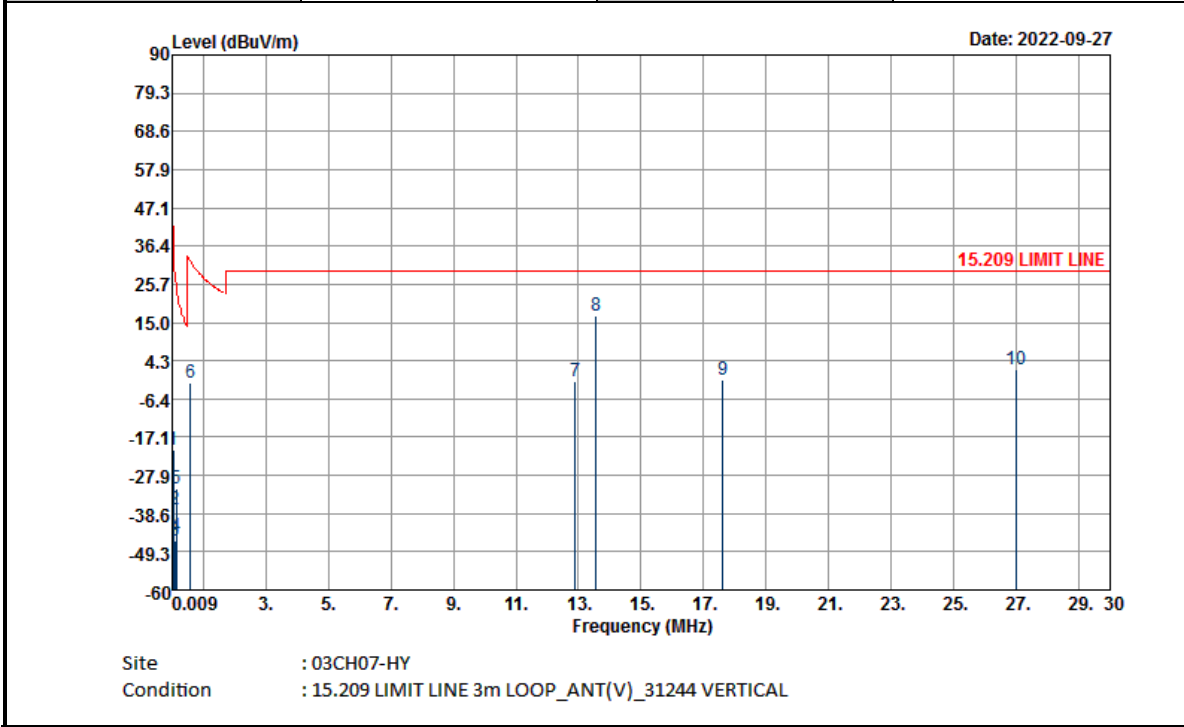

Frequency (MHz)	Level (dBμV/m)	Distance extrapolation Factor (dB)	Margin (dB)	Limit Line (dBμV/m)	Read Level (dBμV)	Antenna Factor (dB)	Cable Loss (dB)	Ant Pos (cm)	Table Pos (deg)	Remark
0.05011	-20.7	80	-54.31	33.61	38.48	20.8	0.02	-	-	Average
0.06828	-37.31	80	-68.23	30.92	22.27	20.4	0.02	-	-	Average
0.10016	-46.29	80	-73.88	27.59	13.99	19.7	0.02	-	-	QP
0.15	-45.15	80	-69.23	24.08	14.99	19.83	0.03	-	-	Average
0.15102	-31.77	80	-55.79	24.02	28.37	19.83	0.03	-	-	Average
0.60265	-1.76	40	-33.76	32	17.93	20.22	0.09	-	-	QP
12.888	-1.3	40	-30.8	29.5	15.93	22.39	0.38	-	-	QP
13.56	16.69	40	-12.81	29.5	33.84	22.46	0.39	-	-	QP
17.611	-0.94	40	-30.44	29.5	15.72	22.86	0.48	-	-	QP
27.005	1.88	40	-27.62	29.5	17.89	23.24	0.75	-	-	QP

Note :

1. The amplitude of spurious emissions which are attenuated by more than 20dB below the permissible value has no need to be reported.
2. Distance extrapolation factor = 40 log (specific distance / test distance) (dB)
3. Level = Antenna Factor + Cable Loss + Read Level - Distance extrapolation factor.
4. 13.56 MHz is fundamental signal which can be ignored.



C3. Results of Radiated Spurious Emissions (30MHz~1GHz)

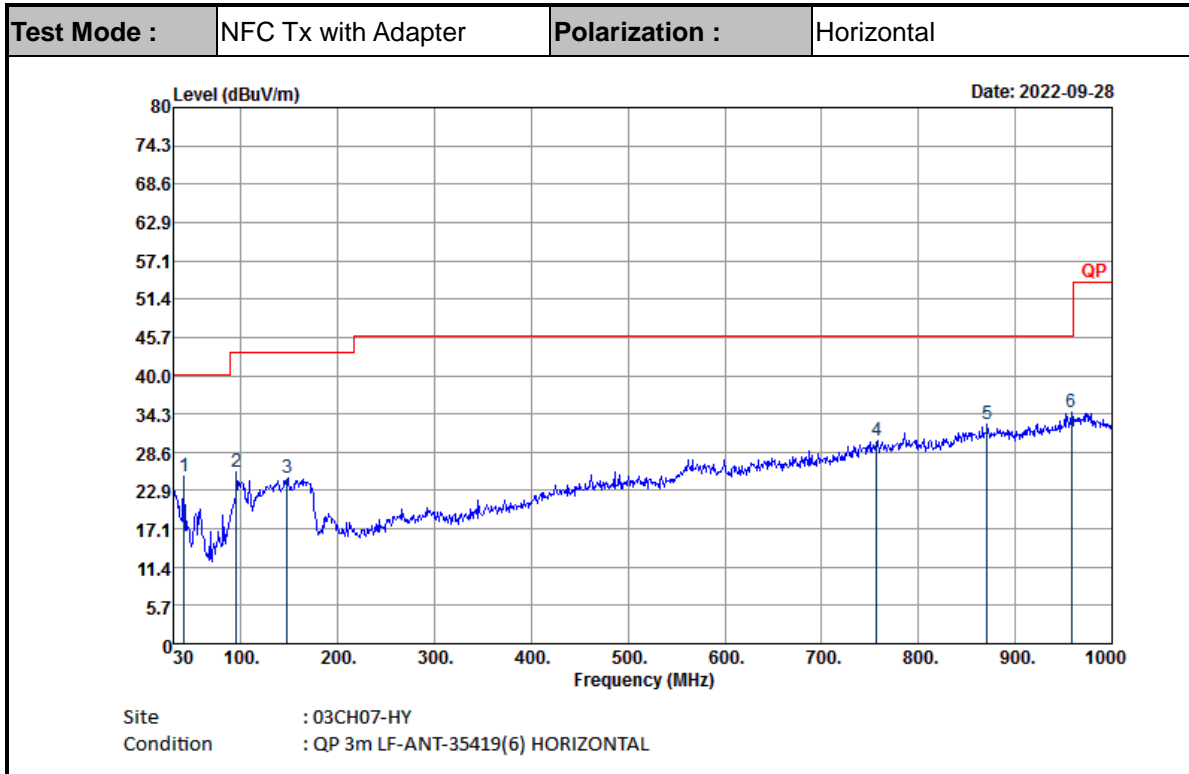

Frequency (MHz)	Level (dBμV/m)	Margin (dB)	Limit Line (dBμV/m)	Read Level (dBμV)	Antenna Factor (dB)	Cable Loss (dB)	Preamp Factor (dB)	Ant Pos (cm)	Table Pos (deg)	Remark
40.8	24.89	-15.11	40	34.98	19.03	0.94	30.06	-	-	Peak
94.8	25.7	-17.8	43.5	38.87	15.26	1.55	29.98	-	-	Peak
147.72	24.75	-18.75	43.5	35.47	17.21	1.95	29.88	-	-	Peak
757.1	30.2	-15.8	46	27.29	27.71	4.6	29.4	-	-	Peak
870.5	32.66	-13.34	46	27.9	28.76	4.96	28.96	-	-	Peak
958	34.52	-11.48	46	27.23	30.71	5.21	28.63	-	-	Peak



Test Mode :	NFC Tx with Adapter	Polarization :	Vertical
-------------	---------------------	----------------	----------

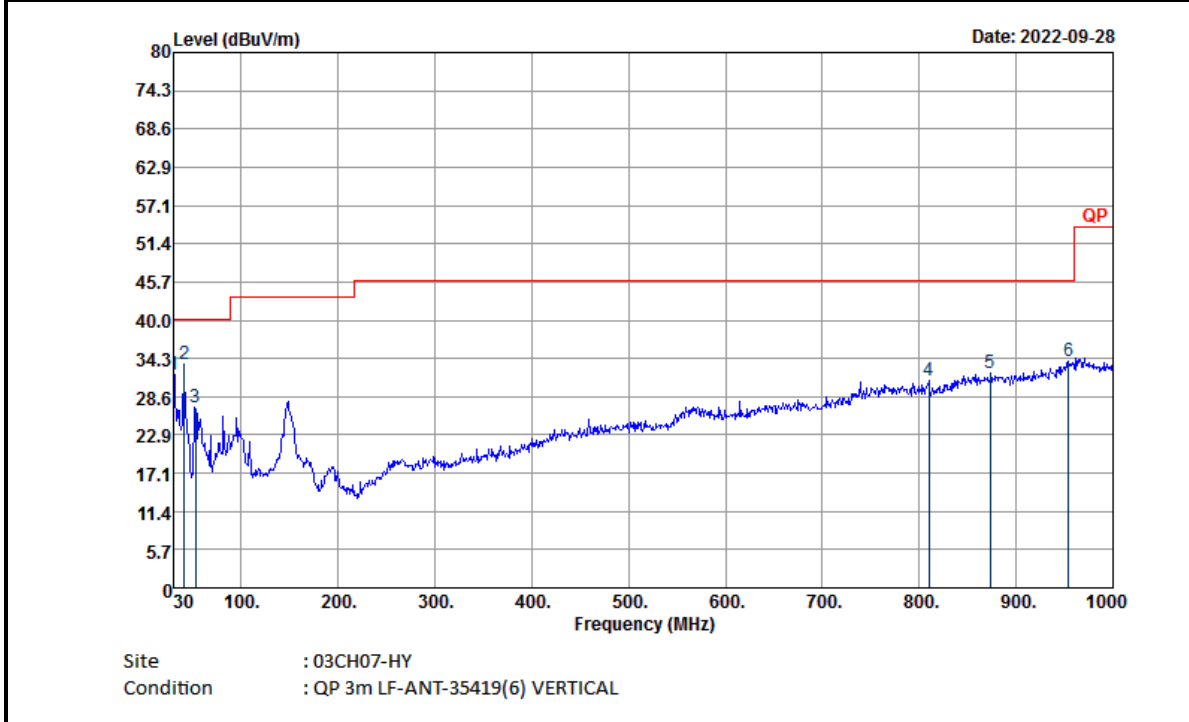

Frequency (MHz)	Level (dBμV/m)	Margin (dB)	Limit Line (dBμV/m)	Read Level (dBμV)	Antenna Factor (dB)	Cable Loss (dB)	Preamp Factor (dB)	Ant Pos (cm)	Table Pos (deg)	Remark
30	31.86	-8.14	40	36.43	24.57	0.97	30.11	-	-	Peak
40.8	33.53	-6.47	40	43.62	19.03	0.94	30.06	-	-	Peak
52.41	26.87	-13.13	40	42.62	13.2	1.08	30.03	-	-	Peak
809.6	30.88	-15.12	46	27.74	27.57	4.78	29.21	-	-	Peak
873.3	32.06	-13.94	46	27.24	28.79	4.97	28.94	-	-	Peak
953.8	33.84	-12.16	46	26.8	30.49	5.19	28.64	-	-	Peak



Test Mode :	NFC Tx with Earphone	Polarization :	Horizontal
--------------------	----------------------	-----------------------	------------

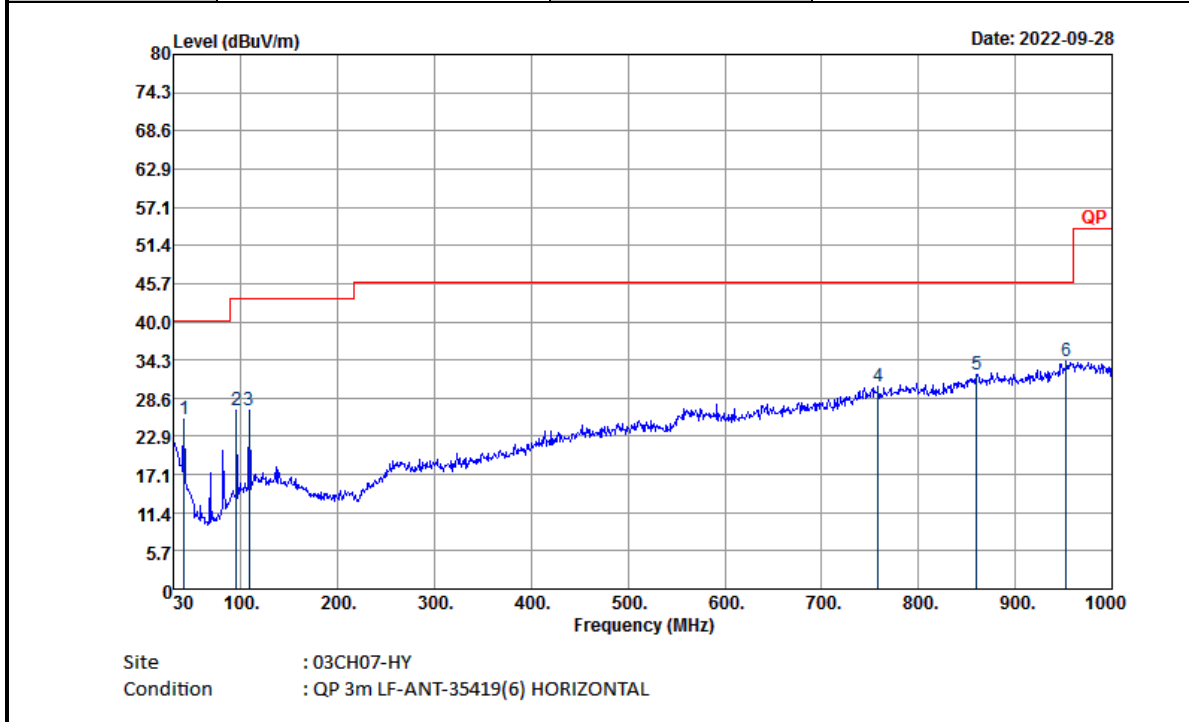

Frequency (MHz)	Level (dB μ V/m)	Margin (dB)	Limit Line (dB μ V/m)	Read Level (dB μ V)	Antenna Factor (dB)	Cable Loss (dB)	Preamp Factor (dB)	Ant Pos (cm)	Table Pos (deg)	Remark
40.8	25.35	-14.65	40	35.44	19.03	0.94	30.06	-	-	Peak
94.8	26.84	-16.66	43.5	40.01	15.26	1.55	29.98	-	-	Peak
108.57	26.85	-16.65	43.5	38.41	16.73	1.68	29.97	-	-	Peak
758.5	30.21	-15.79	46	27.29	27.72	4.6	29.4	-	-	Peak
860	32.17	-13.83	46	27.43	28.83	4.92	29.01	-	-	Peak
952.4	34.2	-11.8	46	27.22	30.43	5.19	28.64	-	-	Peak



Test Mode :	NFC Tx with Earphone	Polarization :	Vertical
-------------	----------------------	----------------	----------

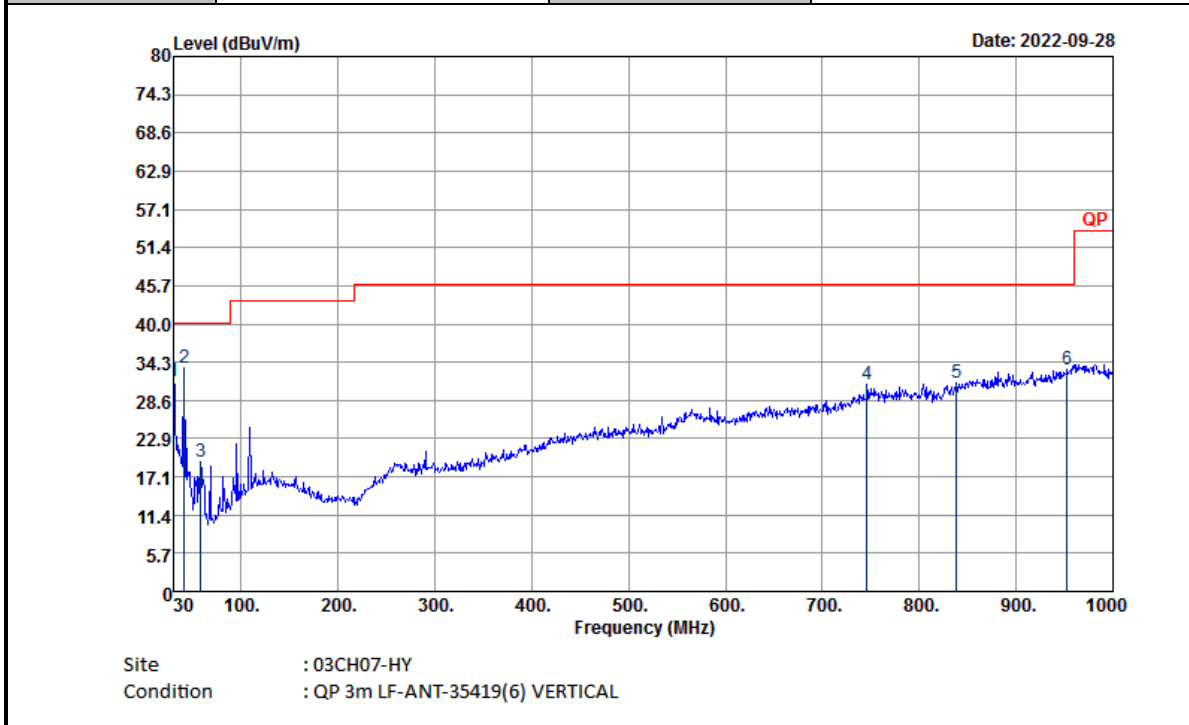

Frequency (MHz)	Level (dBμV/m)	Margin (dB)	Limit Line (dBμV/m)	Read Level (dBμV)	Antenna Factor (dB)	Cable Loss (dB)	Preamp Factor (dB)	Ant Pos (cm)	Table Pos (deg)	Remark
30	31.45	-8.55	40	36.02	24.57	0.97	30.11	-	-	Peak
40.8	33.38	-6.62	40	43.47	19.03	0.94	30.06	-	-	Peak
58.08	19.39	-20.61	40	36.4	11.87	1.16	30.04	-	-	Peak
745.9	30.89	-15.11	46	28.23	27.54	4.56	29.44	-	-	Peak
838.3	31.11	-14.89	46	27.06	28.29	4.86	29.1	-	-	Peak
952.4	33.29	-12.71	46	26.31	30.43	5.19	28.64	-	-	Peak

Note:

1. The amplitude of spurious emissions which are attenuated by more than 20dB below the permissible value has no need to be reported.
2. Emission level (dBμV/m) = 20 log Emission level (μV/m).
3. Corrected Reading: Antenna Factor + Cable Loss + Read Level - Preamp Factor= Level.
4. The emission position marked as "-" means no suspected emission found with sufficient margin against limit line or noise floor only.

————THE END————