



FCC RADIO TEST REPORT

FCC ID : A4RGHL1X
Equipment : Phone
Applicant : Google LLC
1600 Amphitheatre Parkway,
Mountain View, California, 94043 USA
Standard : FCC 47 CFR Part 2, 27

The product was received on Sep. 14, 2022 and testing was performed from Oct. 03, 2022 to Nov. 08, 2022. We, Sporton International Inc. EMC & Wireless Communications Laboratory, would like to declare that the tested sample has been evaluated in accordance with the test procedures given in ANSI / TIA-603-E and has been in compliance with the applicable technical standards.

The test results in this report apply exclusively to the tested model / sample. Without written approval of Sporton International Inc. EMC & Wireless Communications Laboratory, the test report shall not be reproduced except in full.

Louis Wu

Approved by: Louis Wu

Sporton International Inc. EMC & Wireless Communications Laboratory

No. 52, Huaya 1st Rd., Guishan Dist., Taoyuan City 333, Taiwan (R.O.C.)



Table of Contents

History of this test report..... 3

Summary of Test Result..... 4

1 General Description 5

 1.1 Product Feature of Equipment Under Test..... 5

 1.2 Product Specification of Equipment Under Test..... 6

 1.3 Modification of EUT 6

 1.4 Testing Location 7

 1.5 Applicable Standards..... 7

2 Test Configuration of Equipment Under Test 8

 2.1 Test Mode..... 8

 2.2 Connection Diagram of Test System..... 9

 2.3 Support Unit used in test configuration and system 9

 2.4 Measurement Results Explanation Example..... 10

 2.5 Frequency List of Low/Middle/High Channels 11

3 Conducted Test Items..... 12

 3.1 Measuring Instruments 12

 3.2 Conducted Output Power and EIRP..... 13

 3.3 Peak-to-Average Ratio 14

 3.4 Occupied Bandwidth..... 15

 3.5 Conducted Band Edge 16

 3.6 Conducted Spurious Emission 17

 3.7 Frequency Stability 18

4 Radiated Test Items 19

 4.1 Measuring Instruments 19

 4.2 Radiated Spurious Emission Measurement 21

5 List of Measuring Equipment..... 22

6 Uncertainty of Evaluation 24

Appendix A. Test Results of Conducted Test

Appendix B. Test Results of Radiated Test

Appendix C. Test Setup Photographs



Summary of Test Result

Report Clause	Ref Std. Clause	Test Items	Result (PASS/FAIL)	Remark
3.2	§2.1046	Conducted Output Power	Reporting only	-
	§27.50 (k)(3)	Equivalent Isotropic Radiated Power (n77)	Pass	
3.3	§27.50 (k)(4)	Peak-to-Average Ratio	Pass	-
3.4	§2.1049	Occupied Bandwidth	Reporting only	-
3.5	§2.1051	Conducted Band Edge Measurement (n77)	Pass	-
	§27.53 (n)(2)			
3.6	§2.1051	Conducted Spurious Emission (n77)	Pass	-
	§27.53 (n)(2)			
3.7	§2.1055	Frequency Stability Temperature & Voltage	Pass	-
	§27.54			
4.2	§2.1053 §27.53 (n)(2)	Radiated Spurious Emission (n77)	Pass	Under limit 16.55 dB at 13809.000 MHz for Primary Antenna Under limit 16.90 dB at 13809.000 MHz for ASDIV Antenna

Declaration of Conformity:

- The test results (PASS/FAIL) with all measurement uncertainty excluded are presented in accordance with the regulation limits or requirements declared by manufacturers. It's means measurement values may risk exceeding the limit of regulation standards, if measurement uncertainty is include in test results.
- The measurement uncertainty please refer to this report "Uncertainty of Evaluation".

Comments and Explanations:

The product specifications of the EUT presented in the report are declared by the manufacturer who shall take full responsibility for the authenticity.

Reviewed by: William Chen
Report Producer: Rachel Hsieh



1 General Description

1.1 Product Feature of Equipment Under Test

Product Feature	
Equipment	Phone
FCC ID	A4RGHL1X
EUT supports Radios application	GSM/EGPRS/WCDMA/HSPA/LTE/5G NR/ NFC/GNSS/WPT Client WLAN 11b/g/n HT20 WLAN 11a/n HT20/HT40 WLAN 11ac VHT20/VHT40/VHT80 WLAN 11ax HE20/HE40/HE80 Bluetooth BR/EDR/LE

Remark: The above EUT's information was declared by manufacturer.

EUT Information List	
S/N	Performed Test Item
28251FQHN00142	Conducted Measurement EIRP
28261FQHN00058	Radiated Spurious Emission



1.2 Product Specification of Equipment Under Test

Product Specification is subject to this standard	
Tx Frequency	5G NR n77: 3455.01 MHz ~ 3544.98 MHz
Rx Frequency	5G NR n77: 3455.01 MHz ~ 3544.98 MHz
Bandwidth	5G NR n77: 10MHz / 15MHz / 20MHz / 25MHz / 30MHz / 40MHz / 50MHz / 60MHz / 70MHz / 80MHz / 90MHz / 100MHz
Maximum Output Power to Antenna	<Primary Antenna> 24.72 dBm 27.03 dBm for HPUE <ASDIV Antenna> 24.20 dBm 26.20 dBm for HPUE
Antenna Type	<Primary Antenna> : <Ant. 6> : IFA Antenna <ASDIV Antenna> : <Ant. 2> : IFA Antenna <SRS diversity Antenna> : <Ant. 1> : IFA Antenna <Ant. 5> : IFA Antenna
Type of Modulation	PI/2 BPSK / QPSK / 16QAM / 64QAM / 256QAM

<Primary Antenna>

Radio Tech	Band Number	Antenna name	Gain
5G NR	n77	ANT6	-1.2

<ASDIV Antenna>

Radio Tech	Band Number	Antenna name	Gain
5G NR	n77	ANT2	-1.8

<SRS diversity Antenna>

Radio Tech	Band Number	Antenna name	Gain
5G NR	n77	ANT1	-2.8
5G NR	n77	ANT5	-3.4

Remark: The above EUT's information was declared by manufacturer. Please refer to Comments and Explanations in report summary.

1.3 Modification of EUT

No modifications are made to the EUT during all test items.



1.4 Testing Location

Test Site	Sporton International Inc. EMC & Wireless Communications Laboratory
Test Site Location	No.52, Huaya 1st Rd., Guishan Dist., Taoyuan City 333, Taiwan (R.O.C.) TEL: +886-3-327-3456 FAX: +886-3-328-4978
Test Site No.	Sporton Site No.
	TH03-HY
Test Engineer	Sherry Wu
Temperature (°C)	23.5~25
Relative Humidity (%)	48~52

Test Site	Sporton International Inc. Wensan Laboratory.
Test Site Location	No.58, Aly. 75, Ln. 564, Wenhua 3rd, Rd., Guishan Dist., Taoyuan City 333010, Taiwan (R.O.C.) TEL: +886-3-327-0868 FAX: +886-3-327-0855
Test Site No.	Sporton Site No.
	03CH12-HY (TAF Code: 3786)
Test Engineer	Jack Cheng, Tim Lee, Wilson Wu and Jesse Fan
Temperature (°C)	20~25
Relative Humidity (%)	50~60
Remark	The Radiated Spurious Emission test item subcontracted to Sporton International Inc. Wensan Laboratory.

Note: The test site complies with ANSI C63.4 2014 requirement.

FCC Designation No.: TW1190 and TW3786

1.5 Applicable Standards

According to the specifications of the manufacturer, the EUT must comply with the requirements of the following standards:

- ♦ ANSI C63.26-2015
- ♦ ANSI / TIA-603-E
- ♦ FCC 47 CFR Part 2, 27
- ♦ FCC KDB 971168 D01 Power Meas. License Digital Systems v03r01
- ♦ FCC KDB 412172 D01 Determining ERP and EIRP v01r01
- ♦ FCC KDB 414788 D01 Radiated Test Site v01r01.

Remark:

1. All test items were verified and recorded according to the standards and without any deviation during the test.
2. This EUT has also been tested and complied with the requirements of FCC Part 15, Subpart B, recorded in a separate test report.
3. The TAF code is not including all the FCC KDB listed without accreditation.

2.2 Connection Diagram of Test System

<EUT with Adapter>

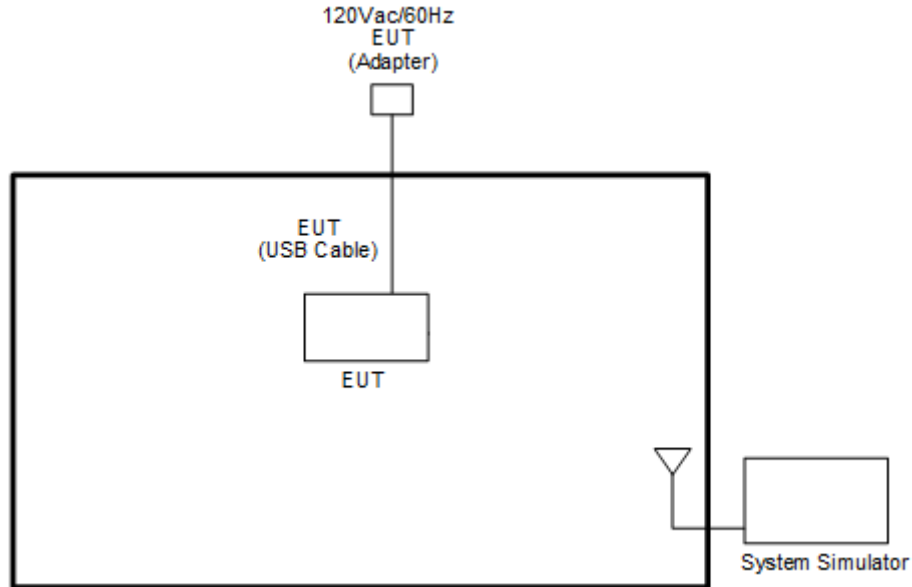

<EUT without Accessory>

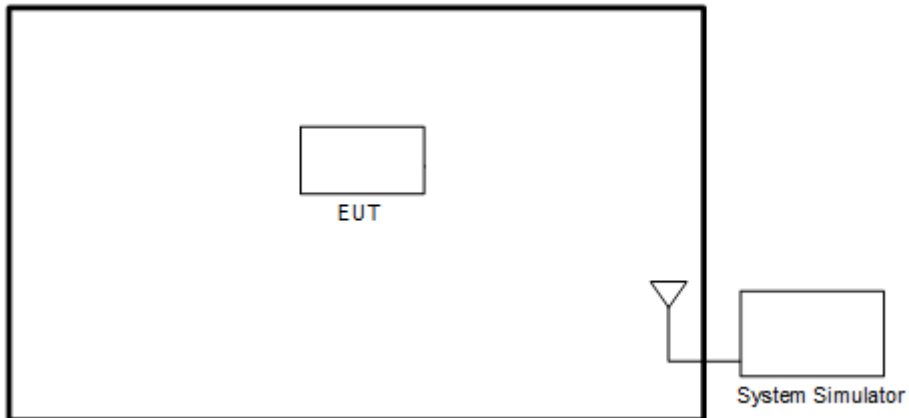

2.3 Support Unit used in test configuration and system

Item	Equipment	Brand Name	Model No.	FCC ID	Data Cable	Power Cord
1.	5G Wireless Test Platform	Anritsu	MT8000A	N/A	N/A	Unshielded, 1.8 m
2.	System Simulator	Anritsu	MT8821C	N/A	N/A	Unshielded, 1.8 m



2.4 Measurement Results Explanation Example

For all conducted test items:

The offset level is set in the spectrum analyzer to compensate the RF cable loss and attenuator factor between EUT conducted output port and spectrum analyzer. With the offset compensation, the spectrum analyzer reading level is exactly the EUT RF output level.

The spectrum analyzer offset is derived from RF cable loss and attenuator factor.

$$\text{Offset} = \text{RF cable loss} + \text{attenuator factor}.$$

Following shows an offset computation example with cable loss 4.2 dB and 10dB attenuator.

Example :

$$\begin{aligned} \text{Offset(dB)} &= \text{RF cable loss(dB)} + \text{attenuator factor(dB)}. \\ &= 4.2 + 10 = 14.2 \text{ (dB)} \end{aligned}$$



2.5 Frequency List of Low/Middle/High Channels

5G NR Band n77 Channel and Frequency List				
BW [MHz]	Channel/Frequency(MHz)	Lowest	Middle	Highest
100	Channel	-	633334	-
	Frequency	-	3500.01	-
90	Channel	633000	633334	633666
	Frequency	3495	3500.01	3504.99
80	Channel	632668	633334	634000
	Frequency	3490.02	3500.01	3510
70	Channel	632334	633334	634332
	Frequency	3485.01	3500.01	3514.98
60	Channel	632000	633334	634666
	Frequency	3480	3500.01	3519.99
50	Channel	631668	633334	635000
	Frequency	3475.02	3500.01	3525
40	Channel	631334	633334	635332
	Frequency	3470.01	3500.01	3529.98
30	Channel	631000	633334	635666
	Frequency	3465	3500.01	3534.99
25	Channel	647500	656000	664500
	Frequency	3712.5	3840	3967.5
20	Channel	630668	633334	636000
	Frequency	3460.02	3500.01	3540
15	Channel	630500	633334	636166
	Frequency	3457.5	3500.01	3542.49
10	Channel	630334	633334	636332
	Frequency	3455.01	3500.01	3544.98

3 Conducted Test Items

3.1 Measuring Instruments

See list of measuring instruments of this test report.

3.1.1 Test Setup

3.1.2 Conducted Output Power

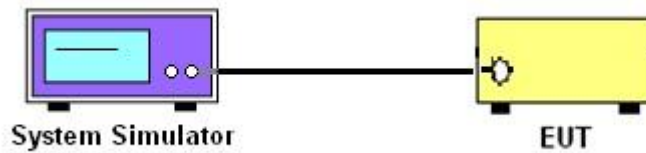

3.1.3 Peak-to-Average Ratio, Occupied Bandwidth ,Conducted Band-Edge and Conducted Spurious Emission

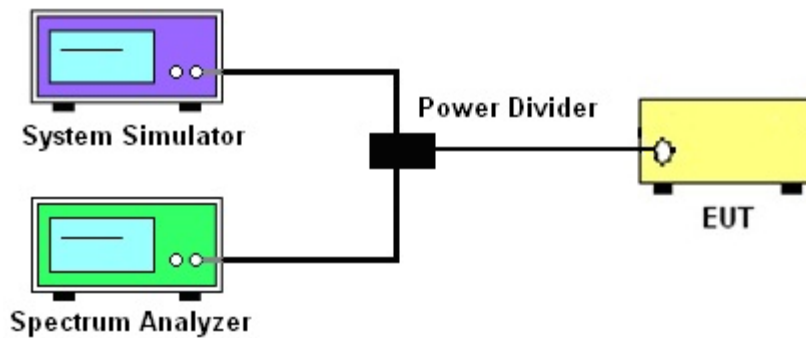

3.1.4 Frequency Stability

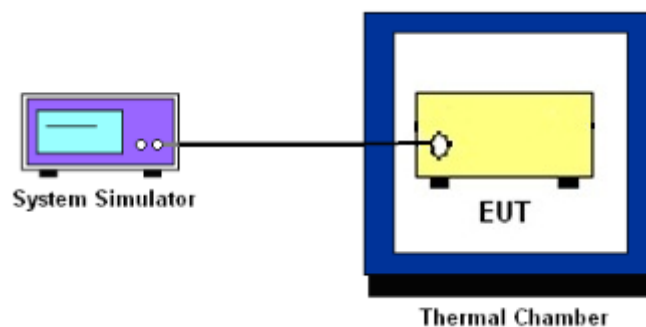

3.1.5 Test Result of Conducted Test

Please refer to Appendix A.



3.2 Conducted Output Power and EIRP

3.2.1 Description of the Conducted Output Power Measurement and EIRP Measurement

A system simulator was used to establish communication with the EUT. Its parameters were set to force the EUT transmitting at maximum output power. The measured power in the radio frequency on the transmitter output terminals shall be reported.

The EIRP of mobile transmitters must not exceed 1 Watts for 5G NR n77

According to KDB 412172 D01 Power Approach,

$EIRP = P_T + G_T - L_C$, $ERP = EIRP - 2.15$, where

P_T = transmitter output power in dBm

G_T = gain of the transmitting antenna in dBi

L_C = signal attenuation in the connecting cable between the transmitter and antenna in dB

3.2.2 Test Procedures

1. The transmitter output port was connected to the system simulator.
2. Set EUT at maximum power through the system simulator.
3. Select lowest, middle, and highest channels for each band and different modulation.
4. Measure and record the power level from the system simulator.



3.3 Peak-to-Average Ratio

3.3.1 Description of the PAR Measurement

Power Complementary Cumulative Distribution Function (CCDF) curves provide a means for characterizing the power peaks of a digitally modulated signal on a statistical basis. A CCDF curve depicts the probability of the peak signal amplitude exceeding the average power level. Most contemporary measurement instrumentation include the capability to produce CCDF curves for an input signal provided that the instrument's resolution bandwidth can be set wide enough to accommodate the entire input signal bandwidth. In measuring transmissions in this band using an average power technique, the peak-to-average ratio (PAR) of the transmission may not exceed 13 dB.

3.3.2 Test Procedures

The testing follows ANSI C63.26-2015 Section 5.2.6

1. The EUT was connected to spectrum and system simulator via a power divider.
2. Set the CCDF (Complementary Cumulative Distribution Function) option in spectrum analyzer.
3. The highest RF powers were measured and recorded the maximum PAPR level associated with a probability of 0.1 %.
4. Record the deviation as Peak to Average Ratio.



3.4 Occupied Bandwidth

3.4.1 Description of Occupied Bandwidth Measurement

The occupied bandwidth is the width of a frequency band such that, below the lower and above the upper frequency limits, the mean powers emitted are each equal to a specified percentage 0.5% of the total mean transmitted power.

The 26 dB emission bandwidth is defined as the frequency range between two points, one above and one below the carrier frequency, at which the spectral density of the emission is attenuated 26 dB below the maximum in-band spectral density of the modulated signal. Spectral density (power per unit bandwidth) is to be measured with a detector of resolution bandwidth equal to approximately 1.0% of the emission bandwidth.

3.4.2 Test Procedures

The testing follows ANSI C63.26-2015 Section 5.4.3 (26dB) and Section 5.4.4 (99OB)

1. The EUT was connected to spectrum analyzer and system simulator via a power divider.
2. The spectrum analyzer center frequency is set to the nominal EUT channel center frequency. The span range for the spectrum analyzer shall be between two and five times the anticipated OBW.
3. The nominal resolution bandwidth (RBW) shall be in the range of 1 to 5 % of the anticipated OBW, and the VBW shall be at least 3 times the RBW.
4. Set the detection mode to peak, and the trace mode to max hold.
5. Determine the reference value: Set the EUT to transmit a modulated signal. Allow the trace to stabilize. Set the spectrum analyzer marker to the highest level of the displayed trace.
(this is the reference value)
6. Determine the “-26 dB down amplitude” as equal to (Reference Value – X).
7. Place two markers, one at the lowest and the other at the highest frequency of the envelope of the spectral display such that each marker is at or slightly below the “-X dB down amplitude” determined in step 6. If a marker is below this “-X dB down amplitude” value it shall be placed as close as possible to this value. The OBW is the positive frequency difference between the two markers.
8. Use the 99 % power bandwidth function of the spectrum analyzer and report the measured bandwidth.



3.5 Conducted Band Edge

3.5.1 Description of Conducted Band Edge Measurement

27.53 (n)(2)

(2) For mobile operations in the 3450-3550 MHz band, the conducted power of any emission outside the licensee's authorized bandwidth shall not exceed -13 dBm/MHz. Compliance with this paragraph (n)(2) is based on the use of measurement instrumentation employing a resolution bandwidth of 1 megahertz or greater. However, in the 1 megahertz bands immediately outside and adjacent to the licensee's frequency block, a resolution bandwidth of at least one percent of the emission bandwidth of the fundamental emission of the transmitter may be employed, but limited to a maximum of 200 kHz. In the bands between 1 and 5 MHz removed from the licensee's frequency block, the minimum resolution bandwidth for the measurement shall be 500 kHz. The emission bandwidth is defined as the width of the signal between two points, one below the carrier center frequency and one above the carrier center frequency, outside of which all emissions are attenuated at least 26 dB below the transmitter power.

3.5.2 Test Procedures

The testing follows FCC KDB 971168 D01 v03r01 Section 6.1.

1. The EUT was connected to spectrum analyzer and system simulator via a power divider.
2. The band edges of low and high channels for the highest RF powers were measured.
3. For $EBW < 20\text{MHz}$, set $RBW \geq 1\%$ EBW in the 1MHz band immediately outside and adjacent to the band edge.
4. For $EBW \geq 20\text{MHz}$, set $RBW = 200\text{kHz}$ in the 1MHz band immediately outside and adjacent to the band edge.
5. Between 1 ~5 MHz from the band edge, $RBW=500$ kHz was used.
6. Set spectrum analyzer with RMS detector.
7. The RF fundamental frequency should be excluded against the limit line in the operating frequency band.
8. Checked that all the results comply with the emission limit line.

The limit line is derived from $43 + 10\log(P)\text{dB}$ below the transmitter power P(Watts)



3.6 Conducted Spurious Emission

3.6.1 Description of Conducted Spurious Emission Measurement

The power of any emission outside of the authorized operating frequency ranges must be lower than the transmitter power (P) by a factor of at least $43 + 10 \log (P)$ dB.

It is measured by means of a calibrated spectrum analyzer and scanned from 30 MHz up to a frequency including its 10th harmonic.

3.6.2 Test Procedures

The testing follows FCC KDB 971168 D01 v03r01 Section 6.1.

1. The EUT was connected to spectrum analyzer and system simulator via a power divider.
2. The RF output of EUT was connected to the spectrum analyzer by RF cable and attenuator.
The path loss was compensated to the results for each measurement.
3. The middle channel for the highest RF power within the transmitting frequency was measured.
4. The conducted spurious emission for the whole frequency range was taken.
5. Make the measurement with the spectrum analyzer's RBW = 1MHz, VBW = 3MHz.
6. Set spectrum analyzer with RMS detector.
7. Taking the record of maximum spurious emission.
8. The RF fundamental frequency should be excluded against the limit line in the operating frequency band.
9. The limit line is derived from $43 + 10\log(P)$ dB below the transmitter power P(Watts)



3.7 Frequency Stability

3.7.1 Description of Frequency Stability Measurement

27.54

The frequency stability shall be sufficient to ensure that the fundamental emission stays within the authorized frequency block.

3.7.2 Test Procedures for Temperature Variation

The testing follows FCC KDB 971168 D01 v03r01 Section 9.0.

1. The EUT was set up in the thermal chamber and connected with the system simulator.
2. With power OFF, the temperature was decreased to -30°C and the EUT was stabilized before testing. Power was applied and the maximum change in frequency was recorded within one minute.
3. With power OFF, the temperature was raised in 10°C step up to 50°C . The EUT was stabilized at each step for at least half an hour. Power was applied and the maximum frequency change was recorded within one minute.

3.7.3 Test Procedures for Voltage Variation

The testing follows FCC KDB 971168 D01 v03r01 Section 9.0.

1. The EUT was placed in a temperature chamber at $20\pm 5^{\circ}\text{C}$ and connected with the system simulator.
2. The power supply voltage to the EUT was varied from 85% to 115% of the nominal value measured at the input to the EUT.
3. The variation in frequency was measured for the worst case.

4 Radiated Test Items

4.1 Measuring Instruments

See list of measuring instruments of this test report.

4.1.1 Test Setup

For radiated test below 30MHz

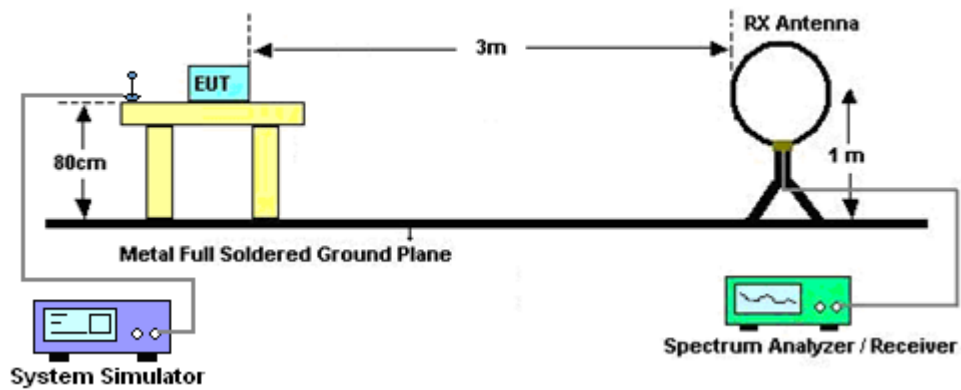

For radiated test from 30MHz to 1GHz

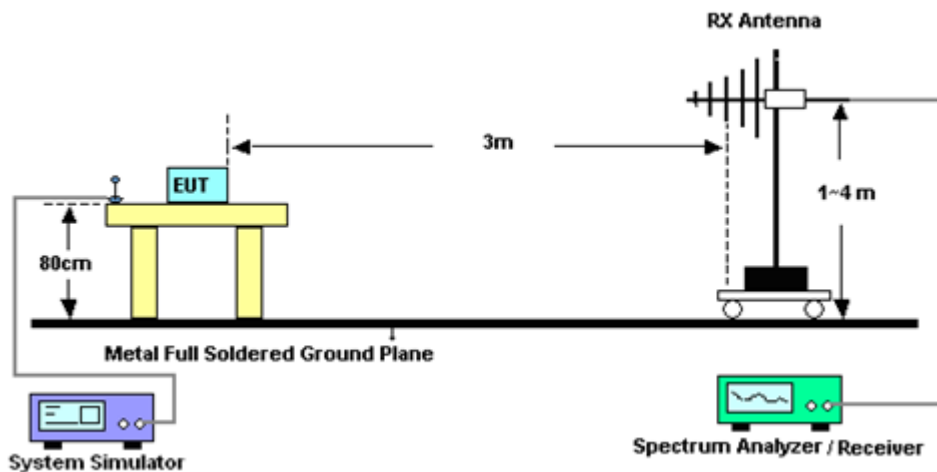

For radiated test from 1GHz to 18GHz

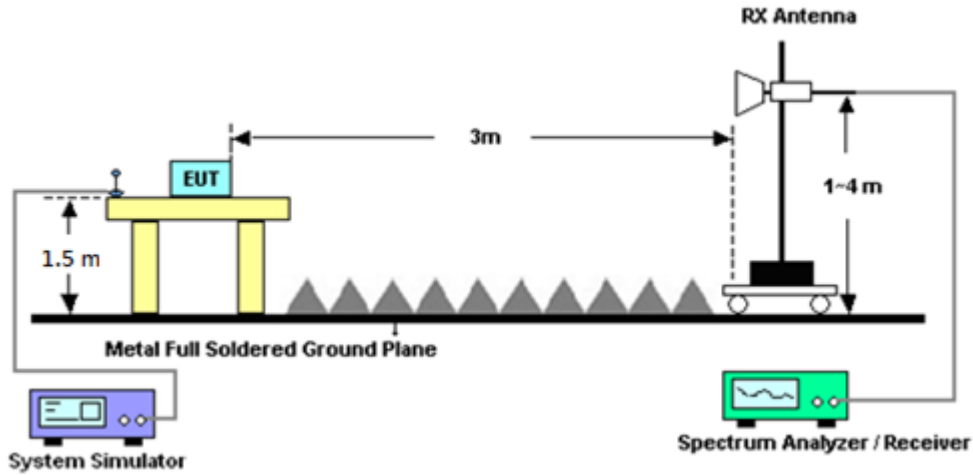

For radiated test above 18GHz

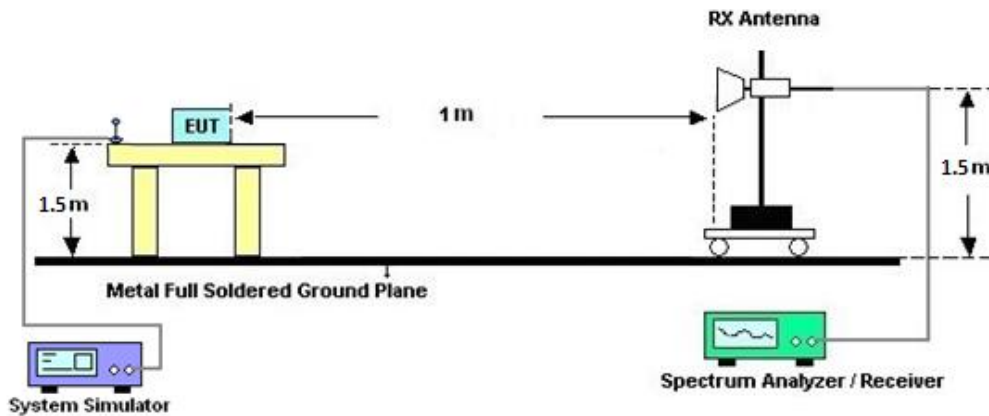

4.1.2 Test Result of Radiated Test

Please refer to Appendix B.

Note:

The low frequency, which started from 9 kHz to 30MHz, was pre-scanned and the result which was 20dB lower than the limit line was not reported.

There is adequate comparison measurement of both open-field test site and alternative test site - semi-Anechoic chamber according to 414788 D01 Radiated Test Site v01r01, and the result came out very similar.



4.2 Radiated Spurious Emission Measurement

4.2.1 Description of Radiated Spurious Emission Measurement

The radiated spurious emission was measured by substitution method according to ANSI / TIA-603-E. The power of any emission outside of the authorized operating frequency ranges must be attenuated below the transmitter power (P) by a factor of at least $43 + 10 \log (P)$ dB. The spectrum is scanned from 30 MHz up to a frequency including its 10th harmonic.

4.2.2 Test Procedures

The testing follows FCC KDB 971168 D01 v03r01 Section 7 and ANSI / TIA-603-E Section 2.2.12.

1. The EUT was placed on a turntable with 0.8 meter for frequency below 1GHz and 1.5 meter for frequency above 1GHz respectively above ground.
2. The EUT was set 3 meters from the receiving antenna, which was mounted on the antenna tower.
3. The table was rotated 360 degrees to determine the position of the highest spurious emission.
4. The height of the receiving antenna is varied between one meter and four meters to search the maximum spurious emission for both horizontal and vertical polarizations.
5. Make the measurement with the spectrum analyzer's RBW = 1MHz, VBW = 3MHz, taking the record of maximum spurious emission.
6. A horn antenna was substituted in place of the EUT and was driven by a signal generator.
7. Tune the output power of signal generator to the same emission level with EUT maximum spurious emission.
8. Taking the record of output power at antenna port.
9. Repeat step 7 to step 8 for another polarization.
10. The RF fundamental frequency should be excluded against the limit line in the operating frequency band.

The limit line is derived from $43 + 10\log(P)$ dB below the transmitter power P(Watts)

$EIRP \text{ (dBm)} = S.G. \text{ Power} - Tx \text{ Cable Loss} + Tx \text{ Antenna Gain}$

$ERP \text{ (dBm)} = EIRP - 2.15$



5 List of Measuring Equipment

Instrument	Brand Name	Model No.	Serial No.	Characteristics	Calibration Date	Test Date	Due Date	Remark
Loop Antenna	Rohde & Schwarz	HFH2-Z2	100488	9 kHz~30 MHz	May 13, 2022	Oct. 24, 2022~ Oct. 25, 2022	May 12, 2023	Radiation (03CH12-HY)
Horn Antenna	SCHWARZBECK	BBHA 9120 D	9120D-1328	1GHz~18GHz	Dec. 03, 2021	Oct. 24, 2022~ Oct. 25, 2022	Dec. 02, 2022	Radiation (03CH12-HY)
Bilog Antenna	TESEQ	CBL 6111D & 00800N1D01N -06	40103 & 07	30MHz~1GHz	Apr. 24, 2022	Oct. 24, 2022~ Oct. 25, 2022	Apr. 23, 2023	Radiation (03CH12-HY)
Bilog Antenna	TESEQ	CBL 6111D & N-6-06	35414 & AT-N0602	30MHz~1GHz	Oct. 08, 2022	Oct. 24, 2022~ Oct. 25, 2022	Oct. 07, 2023	Radiation (03CH12-HY)
Horn Antenna	SCHWARZBECK	BBHA 9120 D	9120D-1212	1GHz~18GHz	Mar 10, 2022	Oct. 24, 2022~ Oct. 25, 2022	Mar 09, 2023	Radiation (03CH12-HY)
SHF-EHF Horn Antenna	SCHWARZBECK	BBHA 9170	BBHA91702 51	18GHz~40GHz	Nov. 30, 2021	Oct. 24, 2022~ Oct. 25, 2022	Nov. 29, 2022	Radiation (03CH12-HY)
SHF-EHF Horn Antenna	SCHWARZBECK	BBHA 9170	BBHA91705 76	18GHz~40GHz	May 14, 2022	Oct. 24, 2022~ Oct. 25, 2022	May 13, 2023	Radiation (03CH12-HY)
Preamplifier	COM-POWER	PA-103	161075	10MHz~1GHz	Mar. 23, 2022	Oct. 24, 2022~ Oct. 25, 2022	Mar. 22, 2023	Radiation (03CH12-HY)
Preamplifier	Aglient	8449B	3008A02375	1GHz~26.5GHz	May 24, 2022	Oct. 24, 2022~ Oct. 25, 2022	May 23, 2023	Radiation (03CH12-HY)
Preamplifier	E-INSTRUMENT TECH LTD.	ERA-100M-18 G-56-01-A70	EC1900249	1GHz-18GHz	Dec. 22, 2021	Oct. 24, 2022~ Oct. 25, 2022	Dec. 21, 2022	Radiation (03CH12-HY)
Preamplifier	E-INSTRUMENT TECH LTD.	ERA-100M-18 G-56-01-A70	EC1900269	1GHz-18GHz	Dec. 27, 2021	Oct. 24, 2022~ Oct. 25, 2022	Dec. 26, 2022	Radiation (03CH12-HY)
Preamplifier	EMEC	EM18G40G	060715	18GHz~40GHz	Dec. 24, 2021	Oct. 24, 2022~ Oct. 25, 2022	Dec. 23, 2022	Radiation (03CH12-HY)
Spectrum Analyzer	Keysight	N9010A	MY53470118	10Hz~44GHz	Jan. 12, 2022	Oct. 24, 2022~ Oct. 25, 2022	Jan. 11, 2023	Radiation (03CH12-HY)
RF Cable	HUBER + SUHNER	SUCOFLEX 104	MY9837/4PE	9kHz~30MHz	Mar. 10, 2022	Oct. 24, 2022~ Oct. 25, 2022	Mar. 09, 2023	Radiation (03CH12-HY)
RF Cable	HUBER + SUHNER	SUCOFLEX 126E	0058/126E	30MHz~18GHz	Dec. 10, 2021	Oct. 24, 2022~ Oct. 25, 2022	Dec. 09, 2022	Radiation (03CH12-HY)
RF Cable	HUBER + SUHNER	SUCOFLEX 102	505134/2	30MHz~40GHz	Feb. 21, 2022	Oct. 24, 2022~ Oct. 25, 2022	Feb. 20, 2023	Radiation (03CH12-HY)
RF Cable	HUBER + SUHNER	SUCOFLEX 102	803953/2	30MHz~40GHz	Mar. 08, 2022	Oct. 24, 2022~ Oct. 25, 2022	Mar. 07, 2023	Radiation (03CH12-HY)
Filter	Wainwright	WHKX8-5872. 5-6750-18000- 40ST	SN2	6.75GHz High Pass Filter	Mar. 15, 2022	Oct. 24, 2022~ Oct. 25, 2022	Mar. 14, 2023	Radiation (03CH12-HY)
Filter	Wainwright	WHKX12-1080 -1200-15000-6 0SS	SN1	1.2GHz High Pass Filter	Mar. 15, 2022	Oct. 24, 2022~ Oct. 25, 2022	Mar. 14, 2023	Radiation (03CH12-HY)



Instrument	Brand Name	Model No.	Serial No.	Characteristics	Calibration Date	Test Date	Due Date	Remark
Hygrometer	TECPEL	DTM-303B	TP140325	N/A	Nov. 26, 2021	Oct. 24, 2022~ Oct. 25, 2022	Nov. 25, 2022	Radiation (03CH12-HY)
Controller	E MEC	EM1000	N/A	Control Turn table & Ant Mast	N/A	Oct. 24, 2022~ Oct. 25, 2022	N/A	Radiation (03CH12-HY)
Antenna Mast	E MEC	AM-BS-4500-B	N/A	1m~4m	N/A	Oct. 24, 2022~ Oct. 25, 2022	N/A	Radiation (03CH12-HY)
Turn Table	E MEC	TT2000	N/A	0~360 Degree	N/A	Oct. 24, 2022~ Oct. 25, 2022	N/A	Radiation (03CH12-HY)
Software	Audix	E3 6.2009-8-24	RK-000989	N/A	N/A	Oct. 24, 2022~ Oct. 25, 2022	N/A	Radiation (03CH12-HY)
Programmable Power Supply	GW Instek	PSS-2005	EL890001	0V~64V ;0A~6A	Sep. 29, 2022	Oct. 03, 2022 ~ Nov. 08, 2022	Sep. 28, 2023	Conducted (TH03-HY)
Signal Analyzer	Rohde & Schwarz	FSV3044	101048	10Hz~44GHz	May 05, 2022	Oct. 03, 2022 ~ Nov. 08, 2022	May 04, 2023	Conducted (TH03-HY)
Temperature Chamber	ESPEC	SH-641	92013720	-40℃ ~90℃	Sep. 09, 2021	Oct. 03, 2022 ~ Nov. 08, 2022	Sep. 06, 2023	Conducted (TH03-HY)
Base Station (Measure)	Anritsu	MT8000A	6262134933	FR1	Jun. 13, 2022	Oct. 03, 2022 ~ Nov. 08, 2022	Jun. 22, 2023	Conducted (TH03-HY)



6 Uncertainty of Evaluation

Uncertainty of Radiated Emission Measurement (30 MHz ~ 1000 MHz)

Measuring Uncertainty for a Level of Confidence of 95% ($U = 2Uc(y)$)	3.31 dB
---	---------

Uncertainty of Radiated Emission Measurement (1 GHz ~ 18 GHz)

Measuring Uncertainty for a Level of Confidence of 95% ($U = 2Uc(y)$)	3.25 dB
---	---------

Uncertainty of Radiated Emission Measurement (18 GHz ~ 40 GHz)

Measuring Uncertainty for a Level of Confidence of 95% ($U = 2Uc(y)$)	3.81 dB
---	---------



Appendix A. Test Results of Conducted Test

Conducted Output Power(Average power) and EIRP

<Primary Antenna>

NR n77 Maximum Average Power [dBm] (GT - LC = -1.2 dB)										
BW [MHz]	RB Size	RB Offset	Mod	Lowest	Middle	Highest	EIRP (dBm)	EIRP(W)		
10	1	1	PI/2 BPSK	24.30	24.36	24.62	23.42	0.2198		
10	1	22		24.25	24.56	24.54				
10	12	6		24.34	24.50	24.54				
10	1	0		23.87	23.87	24.11				
10	1	23		23.75	24.05	24.08				
10	24	0		23.83	24.13	24.02				
10	1	1	QPSK	24.32	24.38	24.57			22.59	0.1816
10	1	22		24.23	24.52	24.52				
10	12	6		24.33	24.59	24.54				
10	1	0		23.32	23.43	23.57				
10	1	23		23.22	23.56	23.53				
10	24	0		23.33	23.58	23.52				
10	1	1	16-QAM	23.46	23.50	23.79	22.59	0.1816		
10	1	1	64-QAM	21.83	21.93	22.19				
10	1	1	256-QAM	19.88	19.78	19.98				
Limit	EIRP < 1W			Result			Pass			

NR n77 Maximum Average Power [dBm] (GT - LC = -1.2 dB)										
BW [MHz]	RB Size	RB Offset	Mod	Lowest	Middle	Highest	EIRP (dBm)	EIRP(W)		
15	1	1	PI/2 BPSK	24.36	24.29	24.57	23.39	0.2183		
15	1	36		24.19	24.46	24.39				
15	18	9		24.31	24.49	24.59				
15	1	0		23.88	23.78	24.02				
15	1	37		23.75	23.93	24.05				
15	36	0		23.76	24.01	24.07				
15	1	1	QPSK	24.35	24.25	24.55			22.30	0.1698
15	1	36		24.26	24.42	24.50				
15	18	9		24.23	24.48	24.57				
15	1	0		23.35	23.25	23.45				
15	1	37		23.26	23.41	23.48				
15	36	0		23.34	23.49	23.56				
15	1	1	16-QAM	23.43	23.11	23.50	22.30	0.1698		
15	1	1	64-QAM	22.12	21.84	22.04				
15	1	1	256-QAM	20.04	19.61	20.05				
Limit	EIRP < 1W			Result			Pass			



NR n77 Maximum Average Power [dBm] (GT - LC = -1.2 dB)										
BW [MHz]	RB Size	RB Offset	Mod	Lowest	Middle	Highest	EIRP (dBm)	EIRP(W)		
20	1	1	PI/2 BPSK	24.24	24.18	24.19	23.31	0.2143		
20	1	49		24.12	24.22	24.24				
20	25	12		24.17	24.44	24.35				
20	1	0		23.75	23.75	23.74				
20	1	50		23.61	23.77	23.79				
20	50	0		23.61	23.99	23.84				
20	1	1	QPSK	24.25	24.22	24.22			22.24	0.1675
20	1	49		24.07	24.26	24.29				
20	25	12		24.18	24.51	24.35				
20	1	0		23.25	23.24	23.26				
20	1	50		23.08	23.27	23.31				
20	50	0		23.19	22.51	23.37				
20	1	1	16-QAM	23.31	23.44	23.37	22.24	0.1675		
20	1	1	64-QAM	21.63	21.74	21.83				
20	1	1	256-QAM	19.64	19.60	19.59				
Limit	EIRP < 1W			Result			Pass			

NR n77 Maximum Average Power [dBm] (GT - LC = -1.2 dB)										
BW [MHz]	RB Size	RB Offset	Mod	Lowest	Middle	Highest	EIRP (dBm)	EIRP(W)		
25	1	1	PI/2 BPSK	24.21	24.41	24.19	23.31	0.2143		
25	1	63		23.93	24.27	24.20				
25	32	16		24.22	24.51	24.32				
25	1	0		23.77	23.92	23.77				
25	1	64		23.51	23.80	23.75				
25	64	0		23.75	23.98	23.79				
25	1	1	QPSK	24.32	24.37	24.22			22.32	0.1706
25	1	63		24.01	24.26	24.20				
25	32	16		24.24	24.51	24.31				
25	1	0		23.28	23.46	23.28				
25	1	64		22.98	23.27	23.24				
25	64	0		23.27	23.50	23.31				
25	1	1	16-QAM	23.47	23.52	23.41	22.32	0.1706		
25	1	1	64-QAM	21.90	21.94	21.63				
25	1	1	256-QAM	19.55	19.95	19.76				
Limit	EIRP < 1W			Result			Pass			



NR n77 Maximum Average Power [dBm] (GT - LC = -1.2 dB)										
BW [MHz]	RB Size	RB Offset	Mod	Lowest	Middle	Highest	EIRP (dBm)	EIRP(W)		
30	1	1	PI/2 BPSK	24.29	24.42	24.35	23.34	0.2158		
30	1	76		23.91	24.25	24.37				
30	36	18		24.22	24.54	24.31				
30	1	0		23.80	23.89	23.79				
30	1	77		23.50	23.70	23.85				
30	75	0		23.73	24.00	23.85				
30	1	1	QPSK	24.29	24.40	24.35			22.32	0.1706
30	1	76		23.97	24.22	24.37				
30	36	18		24.22	24.54	24.30				
30	1	0		23.37	23.42	23.35				
30	1	77		23.04	23.22	23.35				
30	75	0		23.29	23.51	23.43				
30	1	1	16-QAM	23.40	23.52	23.39	22.32	0.1706		
30	1	1	64-QAM	21.89	21.91	21.93				
30	1	1	256-QAM	19.80	19.92	19.97				
Limit	EIRP < 1W			Result			Pass			

NR n77 Maximum Average Power [dBm] (GT - LC = -1.2 dB)										
BW [MHz]	RB Size	RB Offset	Mod	Lowest	Middle	Highest	EIRP (dBm)	EIRP(W)		
40	1	1	PI/2 BPSK	24.33	24.50	24.57	23.45	0.2213		
40	1	104		24.37	24.25	24.30				
40	50	25		24.27	24.65	24.30				
40	1	0		23.90	24.01	24.03				
40	1	105		23.85	23.76	23.77				
40	100	0		23.81	24.13	23.87				
40	1	1	QPSK	24.40	24.42	24.53			22.57	0.1807
40	1	104		24.34	24.19	24.30				
40	50	25		24.28	24.63	24.32				
40	1	0		23.37	23.49	23.55				
40	1	105		23.34	23.17	23.24				
40	100	0		23.32	23.56	23.35				
40	1	1	16-QAM	23.40	23.49	23.77	22.57	0.1807		
40	1	1	64-QAM	21.94	21.99	22.13				
40	1	1	256-QAM	20.17	20.10	19.92				
Limit	EIRP < 1W			Result			Pass			



NR n77 Maximum Average Power [dBm] (GT - LC = -1.2 dB)										
BW [MHz]	RB Size	RB Offset	Mod	Lowest	Middle	Highest	EIRP (dBm)	EIRP(W)		
50	1	1	PI/2 BPSK	24.54	24.30	24.51	23.48	0.2228		
50	1	131		24.45	24.14	24.42				
50	64	32		24.22	24.65	24.20				
50	1	0		24.03	23.80	24.03				
50	1	132		23.92	23.69	23.95				
50	128	0		23.76	24.01	23.74				
50	1	1	QPSK	24.59	24.31	24.48			22.41	0.1742
50	1	131		24.41	24.19	24.41				
50	64	32		24.20	24.68	24.20				
50	1	0		23.52	23.28	23.46				
50	1	132		23.40	23.16	23.45				
50	128	0		23.25	23.58	23.28				
50	1	1	16-QAM	23.37	23.57	23.61	22.41	0.1742		
50	1	1	64-QAM	22.08	22.03	22.08				
50	1	1	256-QAM	19.92	19.65	20.03				
Limit	EIRP < 1W			Result			Pass			

NR n77 Maximum Average Power [dBm] (GT - LC = -1.2 dB)										
BW [MHz]	RB Size	RB Offset	Mod	Lowest	Middle	Highest	EIRP (dBm)	EIRP(W)		
60	1	1	PI/2 BPSK	23.72	23.60	23.82	23.31	0.2143		
60	1	160		24.23	24.02	24.15				
60	81	40		24.16	24.51	24.30				
60	1	0		23.20	23.07	23.31				
60	1	161		23.68	23.53	23.66				
60	162	0		23.84	23.82	23.84				
60	1	1	QPSK	23.67	23.61	23.81			21.56	0.1432
60	1	160		24.20	24.02	24.17				
60	81	40		24.15	24.50	24.37				
60	1	0		22.69	22.59	22.84				
60	1	161		23.18	23.00	23.21				
60	162	0		23.36	23.42	23.36				
60	1	1	16-QAM	22.63	22.76	22.74	21.56	0.1432		
60	1	1	64-QAM	21.07	20.95	21.28				
60	1	1	256-QAM	19.24	19.10	19.31				
Limit	EIRP < 1W			Result			Pass			



NR n77 Maximum Average Power [dBm] (GT - LC = -1.2 dB)								
BW [MHz]	RB Size	RB Offset	Mod	Lowest	Middle	Highest	EIRP (dBm)	EIRP(W)
70	1	1	PI/2 BPSK	23.78	23.67	23.87	23.36	0.2168
70	1	187		23.94	24.09	24.25		
70	90	45		24.29	24.56	24.42		
70	1	0		23.26	23.31	23.39		
70	1	188		23.46	23.50	23.73		
70	180	0		23.83	23.86	23.90		
70	1	1	QPSK	23.91	23.76	23.87		
70	1	187		24.16	24.05	24.23		
70	90	45		24.46	24.53	24.41		
70	1	0		22.93	22.80	22.86		
70	1	188		23.12	23.00	23.25		
70	180	0		23.49	23.42	23.40		
70	1	1	16-QAM	22.90	22.76	22.93	21.73	0.1489
70	1	1	64-QAM	21.36	21.32	21.32		
70	1	1	256-QAM	19.35	19.18	19.40		
Limit	EIRP < 1W			Result			Pass	

NR n77 Maximum Average Power [dBm] (GT - LC = -1.2 dB)								
BW [MHz]	RB Size	RB Offset	Mod	Lowest	Middle	Highest	EIRP (dBm)	EIRP(W)
80	1	1	PI/2 BPSK	23.89	24.01	23.90	23.42	0.2198
80	1	215		24.12	24.32	24.42		
80	108	54		24.35	24.58	24.54		
80	1	0		23.38	23.45	23.44		
80	1	216		23.65	23.81	23.89		
80	216	0		23.82	24.03	24.02		
80	1	1	QPSK	23.86	23.94	23.92		
80	1	215		24.12	24.32	24.36		
80	108	54		24.35	24.62	24.53		
80	1	0		22.86	22.92	22.92		
80	1	216		23.13	23.30	23.41		
80	216	0		23.30	23.57	23.52		
80	1	1	16-QAM	23.03	22.96	23.05	21.85	0.1531
80	1	1	64-QAM	21.36	21.41	21.42		
80	1	1	256-QAM	19.50	19.40	19.40		
Limit	EIRP < 1W			Result			Pass	



NR n77 Maximum Average Power [dBm] (GT - LC = -1.2 dB)								
BW [MHz]	RB Size	RB Offset	Mod	Lowest	Middle	Highest	EIRP (dBm)	EIRP(W)
90	1	1	PI/2 BPSK	24.04	24.15	24.01	23.52	0.2249
90	1	243		24.28	24.36	24.43		
90	120	60		24.36	24.65	24.70		
90	1	0		23.51	23.63	23.56		
90	1	244		23.74	23.90	23.98		
90	243	0		23.80	24.10	24.17		
90	1	1	QPSK	23.99	24.15	24.00		
90	1	243		24.22	24.38	24.45		
90	120	60		24.40	24.69	24.72		
90	1	0		23.06	23.17	23.06		
90	1	244		23.24	23.33	23.47		
90	243	0		23.35	23.66	23.65		
90	1	1	16-QAM	22.96	23.06	23.10	21.90	0.1549
90	1	1	64-QAM	21.62	21.72	21.44		
90	1	1	256-QAM	19.65	19.74	19.71		
Limit	EIRP < 1W			Result			Pass	

NR n77 Maximum Average Power [dBm] (GT - LC = -1.2 dB)								
BW [MHz]	RB Size	RB Offset	Mod	Lowest	Middle	Highest	EIRP (dBm)	EIRP(W)
100	1	1	PI/2 BPSK	-	24.17	-	23.46	0.2218
100	1	271		-	24.34	-		
100	135	67		-	24.66	-		
100	1	0		-	23.69	-		
100	1	272		-	23.84	-		
100	270	0		-	24.12	-		
100	1	1	QPSK	-	24.22	-		
100	1	271		-	24.40	-		
100	135	67		-	24.61	-		
100	1	0		-	23.19	-		
100	1	272		-	23.40	-		
100	270	0		-	23.63	-		
100	1	1	16-QAM	-	23.30	-	22.10	0.1622
100	1	1	64-QAM	-	21.56	-		
100	1	1	256-QAM	-	19.49	-		
Limit	EIRP < 1W			Result			Pass	



NR n77 HPUE Maximum Average Power [dBm] (GT - LC = -1.2 dB)								
BW [MHz]	RB Size	RB Offset	Mod	Lowest	Middle	Highest	EIRP (dBm)	EIRP(W)
10	1	1	PI/2 BPSK	26.06	26.13	26.24	25.11	0.3243
10	1	22		26.03	26.26	26.13		
10	12	6		26.04	26.31	26.17		
10	1	0		22.58	22.60	22.68		
10	1	23		22.49	22.78	22.62		
10	24	0		25.52	25.81	25.74		
10	1	1	QPSK	26.02	26.12	26.22		
10	1	22		26.01	26.29	26.12		
10	12	6		26.05	26.30	26.18		
10	1	0		22.57	22.67	22.77		
10	1	23		22.47	22.72	22.64		
10	24	0		25.01	25.33	25.17		
10	1	1	16-QAM	24.89	25.09	25.42	24.22	0.2642
10	1	1	64-QAM	23.75	23.66	23.70		
10	1	1	256-QAM	21.44	21.45	21.57		
Limit	EIRP < 1W			Result			Pass	

NR n77 HPUE Maximum Average Power [dBm] (GT - LC = -1.2 dB)								
BW [MHz]	RB Size	RB Offset	Mod	Lowest	Middle	Highest	EIRP (dBm)	EIRP(W)
15	1	1	PI/2 BPSK	26.08	26.11	26.24	25.13	0.3258
15	1	36		26.07	26.27	26.13		
15	18	9		26.01	26.31	26.20		
15	1	0		22.55	22.65	22.76		
15	1	37		22.55	22.76	22.65		
15	36	0		25.33	25.81	25.72		
15	1	1	QPSK	26.05	26.14	26.22		
15	1	36		26.05	26.28	26.16		
15	18	9		26.05	26.33	26.25		
15	1	0		22.58	22.62	22.78		
15	1	37		22.51	22.79	22.64		
15	36	0		25.01	25.33	25.25		
15	1	1	16-QAM	25.11	25.31	25.31	24.11	0.2576
15	1	1	64-QAM	23.64	23.67	23.78		
15	1	1	256-QAM	21.61	21.75	21.74		
Limit	EIRP < 1W			Result			Pass	



NR n77 HPUE Maximum Average Power [dBm] (GT - LC = -1.2 dB)										
BW [MHz]	RB Size	RB Offset	Mod	Lowest	Middle	Highest	EIRP (dBm)	EIRP(W)		
20	1	1	PI/2 BPSK	26.36	26.50	26.16	25.56	0.3597		
20	1	49		26.33	26.45	26.08				
20	25	12		26.36	26.76	26.18				
20	1	0		22.83	22.95	22.61				
20	1	50		22.87	22.94	22.62				
20	50	0		25.54	26.06	25.64				
20	1	1	QPSK	26.40	26.44	26.15			24.15	0.2600
20	1	49		26.31	26.41	26.11				
20	25	12		26.39	26.64	26.20				
20	1	0		22.92	23.01	22.68				
20	1	50		22.81	22.93	22.61				
20	50	0		25.01	25.56	25.17				
20	1	1	16-QAM	25.31	25.35	25.08	24.15	0.2600		
20	1	1	64-QAM	23.94	23.73	23.55				
20	1	1	256-QAM	21.94	21.99	21.63				
Limit	EIRP < 1W			Result			Pass			

NR n77 HPUE Maximum Average Power [dBm] (GT - LC = -1.2 dB)										
BW [MHz]	RB Size	RB Offset	Mod	Lowest	Middle	Highest	EIRP (dBm)	EIRP(W)		
25	1	1	PI/2 BPSK	26.46	26.57	26.50	25.46	0.3516		
25	1	63		26.25	26.43	26.37				
25	32	16		26.45	26.66	26.51				
25	1	0		22.91	23.07	22.97				
25	1	64		22.75	22.94	22.91				
25	64	0		25.91	26.07	26.05				
25	1	1	QPSK	26.43	26.58	26.50			24.55	0.2851
25	1	63		26.14	26.40	26.42				
25	32	16		26.45	26.64	26.54				
25	1	0		22.99	23.11	23.05				
25	1	64		22.70	22.92	22.90				
25	64	0		25.43	25.61	25.52				
25	1	1	16-QAM	25.67	25.75	25.34	24.55	0.2851		
25	1	1	64-QAM	24.04	24.12	24.20				
25	1	1	256-QAM	21.90	22.13	21.85				
Limit	EIRP < 1W			Result			Pass			



NR n77 HPUE Maximum Average Power [dBm] (GT - LC = -1.2 dB)								
BW [MHz]	RB Size	RB Offset	Mod	Lowest	Middle	Highest	EIRP (dBm)	EIRP(W)
30	1	1	PI/2 BPSK	26.62	26.78	26.62	25.60	0.3631
30	1	76		26.31	26.53	26.54		
30	36	18		26.55	26.80	26.61		
30	1	0		22.98	23.24	23.05		
30	1	77		22.80	23.02	23.11		
30	75	0		26.07	26.25	26.20		
30	1	1	QPSK	26.59	26.77	26.60		
30	1	76		26.34	26.50	26.59		
30	36	18		26.56	26.78	26.60		
30	1	0		23.05	23.22	23.15		
30	1	77		22.79	22.99	23.06		
30	75	0		25.55	25.81	25.74		
30	1	1	16-QAM	25.77	25.72	25.67	24.57	0.2864
30	1	1	64-QAM	23.97	24.33	23.92		
30	1	1	256-QAM	21.94	22.24	21.96		
Limit	EIRP < 1W			Result			Pass	

NR n77 HPUE Maximum Average Power [dBm] (GT - LC = -1.2 dB)								
BW [MHz]	RB Size	RB Offset	Mod	Lowest	Middle	Highest	EIRP (dBm)	EIRP(W)
40	1	1	PI/2 BPSK	26.58	26.70	26.70	25.59	0.3622
40	1	104		26.55	26.45	26.53		
40	50	25		26.52	26.74	26.60		
40	1	0		23.15	23.24	23.25		
40	1	105		23.07	22.97	22.99		
40	100	0		26.05	26.22	25.98		
40	1	1	QPSK	26.63	26.77	26.78		
40	1	104		26.57	26.41	26.49		
40	50	25		26.57	26.79	26.57		
40	1	0		23.11	23.27	23.26		
40	1	105		23.04	22.97	22.97		
40	100	0		25.54	25.74	25.57		
40	1	1	16-QAM	25.84	25.70	25.75	24.64	0.2911
40	1	1	64-QAM	24.21	24.08	24.33		
40	1	1	256-QAM	22.03	22.20	22.24		
Limit	EIRP < 1W			Result			Pass	



NR n77 HPUE Maximum Average Power [dBm] (GT - LC = -1.2 dB)								
BW [MHz]	RB Size	RB Offset	Mod	Lowest	Middle	Highest	EIRP (dBm)	EIRP(W)
50	1	1	PI/2 BPSK	26.71	26.61	27.03	25.83	0.3828
50	1	131		26.53	26.39	26.44		
50	64	32		26.46	26.76	26.55		
50	1	0		23.24	23.05	23.45		
50	1	132		23.08	22.89	22.91		
50	128	0		25.99	26.12	26.11		
50	1	1	QPSK	26.65	26.60	26.98		
50	1	131		26.61	26.36	26.37		
50	64	32		26.47	26.74	26.57		
50	1	0		23.21	23.06	23.53		
50	1	132		23.06	22.86	22.83		
50	128	0		25.46	25.70	25.61		
50	1	1	16-QAM	25.66	25.51	25.87	24.67	0.2931
50	1	1	64-QAM	24.20	24.04	24.32		
50	1	1	256-QAM	22.04	21.95	22.43		
Limit	EIRP < 1W			Result			Pass	

NR n77 HPUE Maximum Average Power [dBm] (GT - LC = -1.2 dB)								
BW [MHz]	RB Size	RB Offset	Mod	Lowest	Middle	Highest	EIRP (dBm)	EIRP(W)
60	1	1	PI/2 BPSK	26.20	26.07	26.30	25.54	0.3581
60	1	160		26.43	26.34	26.45		
60	81	40		26.47	26.73	26.63		
60	1	0		22.63	22.63	22.73		
60	1	161		22.98	22.84	22.91		
60	162	0		26.08	26.22	26.16		
60	1	1	QPSK	26.21	26.09	26.24		
60	1	160		26.40	26.30	26.45		
60	81	40		26.54	26.74	26.63		
60	1	0		22.69	22.60	22.76		
60	1	161		22.95	22.88	22.96		
60	162	0		25.67	25.73	25.64		
60	1	1	16-QAM	25.43	25.01	25.34	24.23	0.2649
60	1	1	64-QAM	23.70	23.63	23.67		
60	1	1	256-QAM	21.54	21.62	21.67		
Limit	EIRP < 1W			Result			Pass	



NR n77 HPUE Maximum Average Power [dBm] (GT - LC = -1.2 dB)								
BW [MHz]	RB Size	RB Offset	Mod	Lowest	Middle	Highest	EIRP (dBm)	EIRP(W)
70	1	1	PI/2 BPSK	26.29	26.22	26.31	25.53	0.3573
70	1	187		26.30	26.38	26.53		
70	90	45		26.65	26.73	26.63		
70	1	0		22.73	22.75	22.88		
70	1	188		22.79	22.84	23.01		
70	180	0		26.12	26.12	26.17		
70	1	1	QPSK	26.26	26.27	26.37		
70	1	187		26.28	26.35	26.54		
70	90	45		26.64	26.72	26.69		
70	1	0		22.75	22.74	22.87		
70	1	188		22.81	22.79	22.99		
70	180	0		25.62	25.66	25.66		
70	1	1	16-QAM	25.18	25.45	25.41	24.25	0.2661
70	1	1	64-QAM	23.74	23.73	23.64		
70	1	1	256-QAM	21.67	21.81	21.94		
Limit	EIRP < 1W			Result			Pass	

NR n77 HPUE Maximum Average Power [dBm] (GT - LC = -1.2 dB)								
BW [MHz]	RB Size	RB Offset	Mod	Lowest	Middle	Highest	EIRP (dBm)	EIRP(W)
80	1	1	PI/2 BPSK	26.19	26.29	26.25	25.56	0.3597
80	1	215		26.37	26.52	26.47		
80	108	54		26.45	26.76	26.65		
80	1	0		22.70	22.81	22.76		
80	1	216		22.78	22.98	22.95		
80	216	0		25.94	26.20	26.02		
80	1	1	QPSK	26.21	26.30	26.23		
80	1	215		26.34	26.45	26.43		
80	108	54		26.50	26.73	26.63		
80	1	0		22.72	22.79	22.72		
80	1	216		22.78	22.89	22.93		
80	216	0		25.45	25.69	25.60		
80	1	1	16-QAM	25.14	25.37	25.17	24.17	0.2612
80	1	1	64-QAM	23.71	23.71	23.66		
80	1	1	256-QAM	21.81	21.60	21.77		
Limit	EIRP < 1W			Result			Pass	



NR n77 HPUE Maximum Average Power [dBm] (GT - LC = -1.2 dB)								
BW [MHz]	RB Size	RB Offset	Mod	Lowest	Middle	Highest	EIRP (dBm)	EIRP(W)
90	1	1	PI/2 BPSK	26.32	26.37	26.25	25.59	0.3622
90	1	243		26.40	26.46	26.51		
90	120	60		26.46	26.70	26.77		
90	1	0		22.90	22.90	22.82		
90	1	244		22.89	22.92	22.97		
90	243	0		25.92	26.18	26.23		
90	1	1	QPSK	26.36	26.39	26.29		
90	1	243		26.32	26.40	26.54		
90	120	60		26.50	26.79	26.76		
90	1	0		22.85	22.89	22.86		
90	1	244		22.85	22.89	23.01		
90	243	0		25.46	25.70	25.70		
90	1	1	16-QAM	25.45	25.35	25.33	24.25	0.2661
90	1	1	64-QAM	23.75	23.90	23.86		
90	1	1	256-QAM	21.83	21.90	21.76		
Limit	EIRP < 1W			Result			Pass	

NR n77 HPUE Maximum Average Power [dBm] (GT - LC = -1.2 dB)								
BW [MHz]	RB Size	RB Offset	Mod	Lowest	Middle	Highest	EIRP (dBm)	EIRP(W)
100	1	1	PI/2 BPSK	-	26.42	-	25.53	0.3573
100	1	271		-	26.45	-		
100	135	67		-	26.73	-		
100	1	0		-	22.94	-		
100	1	272		-	23.03	-		
100	270	0		-	26.15	-		
100	1	1	QPSK	-	26.43	-		
100	1	271		-	26.46	-		
100	135	67		-	26.72	-		
100	1	0		-	22.98	-		
100	1	272		-	22.98	-		
100	270	0		-	25.76	-		
100	1	1	16-QAM	-	25.54	-	24.34	0.2716
100	1	1	64-QAM	-	24.06	-		
100	1	1	256-QAM	-	21.95	-		
Limit	EIRP < 1W			Result			Pass	



<ASDIV Antenna>

NR n77 Maximum Average Power [dBm] (GT - LC = -1.8 dB)								
BW [MHz]	RB Size	RB Offset	Mod	Lowest	Middle	Highest	EIRP (dBm)	EIRP(W)
10	1	1	PI/2 BPSK	23.23	23.22	24.09	22.29	0.1694
10	1	22		23.23	23.50	23.93		
10	12	6		23.18	23.39	23.87		
10	1	0		22.69	22.85	23.48		
10	1	23		22.74	23.03	23.47		
10	24	0		22.76	22.96	23.48		
10	1	1	QPSK	23.16	23.33	23.94		
10	1	22		23.15	23.45	24.00		
10	12	6		23.33	23.57	23.94		
10	1	0		22.14	22.24	23.06		
10	1	23		22.08	22.50	22.94		
10	24	0		22.29	22.50	22.96		
10	1	1	16-QAM	22.34	22.40	23.23	21.43	0.1390
10	1	1	64-QAM	20.64	20.77	21.67		
10	1	1	256-QAM	18.82	18.62	19.32		
Limit	EIRP < 1W			Result			Pass	

NR n77 Maximum Average Power [dBm] (GT - LC = -1.8 dB)								
BW [MHz]	RB Size	RB Offset	Mod	Lowest	Middle	Highest	EIRP (dBm)	EIRP(W)
15	1	1	PI/2 BPSK	23.25	23.15	23.87	22.26	0.1683
15	1	36		23.14	23.40	23.78		
15	18	9		23.28	23.30	24.06		
15	1	0		22.79	22.61	23.48		
15	1	37		22.72	22.77	23.37		
15	36	0		22.74	22.95	23.44		
15	1	1	QPSK	23.25	23.10	23.93		
15	1	36		23.19	23.34	23.88		
15	18	9		23.10	23.46	23.88		
15	1	0		22.23	22.13	22.92		
15	1	37		22.25	22.37	22.88		
15	36	0		22.30	22.37	22.94		
15	1	1	16-QAM	22.24	21.99	22.92	21.12	0.1294
15	1	1	64-QAM	20.99	20.84	21.49		
15	1	1	256-QAM	18.94	18.60	19.39		
Limit	EIRP < 1W			Result			Pass	



NR n77 Maximum Average Power [dBm] (GT - LC = -1.8 dB)								
BW [MHz]	RB Size	RB Offset	Mod	Lowest	Middle	Highest	EIRP (dBm)	EIRP(W)
20	1	1	PI/2 BPSK	23.20	23.05	23.68	21.99	0.1581
20	1	49		23.02	23.15	23.63		
20	25	12		23.04	23.35	23.79		
20	1	0		22.67	22.70	23.17		
20	1	50		22.44	22.69	23.21		
20	50	0		22.57	22.94	23.24		
20	1	1	QPSK	23.17	23.20	23.66		
20	1	49		22.97	23.18	23.72		
20	25	12		23.17	23.31	23.68		
20	1	0		22.12	22.15	22.69		
20	1	50		22.00	22.23	22.69		
20	50	0		21.99	21.38	22.73		
20	1	1	16-QAM	22.17	22.38	22.78	20.98	0.1253
20	1	1	64-QAM	20.48	20.66	21.17		
20	1	1	256-QAM	18.61	18.43	18.89		
Limit	EIRP < 1W			Result			Pass	

NR n77 Maximum Average Power [dBm] (GT - LC = -1.8 dB)								
BW [MHz]	RB Size	RB Offset	Mod	Lowest	Middle	Highest	EIRP (dBm)	EIRP(W)
25	1	1	PI/2 BPSK	23.15	23.32	23.56	22.00	0.1585
25	1	63		22.83	23.20	23.54		
25	32	16		23.04	23.46	23.80		
25	1	0		22.71	22.76	23.16		
25	1	64		22.37	22.78	23.08		
25	64	0		22.67	22.88	23.13		
25	1	1	QPSK	23.27	23.26	23.72		
25	1	63		22.83	23.25	23.52		
25	32	16		23.16	23.32	23.69		
25	1	0		22.22	22.34	22.61		
25	1	64		21.91	22.17	22.64		
25	64	0		22.13	22.35	22.71		
25	1	1	16-QAM	22.31	22.39	22.79	20.99	0.1256
25	1	1	64-QAM	20.85	20.78	20.97		
25	1	1	256-QAM	18.38	18.86	19.19		
Limit	EIRP < 1W			Result			Pass	



NR n77 Maximum Average Power [dBm] (GT - LC = -1.8 dB)										
BW [MHz]	RB Size	RB Offset	Mod	Lowest	Middle	Highest	EIRP (dBm)	EIRP(W)		
30	1	1	PI/2 BPSK	23.19	23.41	23.80	22.05	0.1603		
30	1	76		22.73	23.20	23.84				
30	36	18		23.12	23.34	23.66				
30	1	0		22.78	22.81	23.24				
30	1	77		22.43	22.61	23.18				
30	75	0		22.70	22.91	23.25				
30	1	1	QPSK	23.10	23.36	23.76			20.95	0.1245
30	1	76		22.78	23.18	23.85				
30	36	18		23.10	23.43	23.61				
30	1	0		22.28	22.25	22.72				
30	1	77		21.99	22.07	22.65				
30	75	0		22.14	22.51	22.92				
30	1	1	16-QAM	22.31	22.42	22.75	20.95	0.1245		
30	1	1	64-QAM	20.74	20.89	21.26				
30	1	1	256-QAM	18.77	18.86	19.32				
Limit	EIRP < 1W			Result			Pass			

NR n77 Maximum Average Power [dBm] (GT - LC = -1.8 dB)										
BW [MHz]	RB Size	RB Offset	Mod	Lowest	Middle	Highest	EIRP (dBm)	EIRP(W)		
40	1	1	PI/2 BPSK	23.29	23.31	23.90	22.22	0.1667		
40	1	104		23.29	23.22	23.61				
40	50	25		23.19	23.48	23.66				
40	1	0		22.86	22.90	23.36				
40	1	105		22.80	22.60	23.08				
40	100	0		22.76	23.11	23.21				
40	1	1	QPSK	23.30	23.25	24.02			21.43	0.1390
40	1	104		23.20	23.03	23.66				
40	50	25		23.25	23.52	23.65				
40	1	0		22.35	22.44	22.95				
40	1	105		22.33	22.16	22.71				
40	100	0		22.32	22.48	22.66				
40	1	1	16-QAM	22.38	22.45	23.23	21.43	0.1390		
40	1	1	64-QAM	20.79	20.88	21.46				
40	1	1	256-QAM	19.17	18.93	19.34				
Limit	EIRP < 1W			Result			Pass			



NR n77 Maximum Average Power [dBm] (GT - LC = -1.8 dB)										
BW [MHz]	RB Size	RB Offset	Mod	Lowest	Middle	Highest	EIRP (dBm)	EIRP(W)		
50	1	1	PI/2 BPSK	23.52	23.18	23.92	22.12	0.1629		
50	1	131		23.31	23.11	23.91				
50	64	32		23.20	23.63	23.51				
50	1	0		22.94	22.69	23.49				
50	1	132		22.82	22.65	23.30				
50	128	0		22.62	22.83	23.18				
50	1	1	QPSK	23.41	23.24	23.88			21.17	0.1309
50	1	131		23.27	23.14	23.75				
50	64	32		23.12	23.60	23.54				
50	1	0		22.35	22.18	22.96				
50	1	132		22.33	22.13	22.84				
50	128	0		22.06	22.52	22.78				
50	1	1	16-QAM	22.28	22.39	22.97	21.17	0.1309		
50	1	1	64-QAM	21.01	21.03	21.42				
50	1	1	256-QAM	18.91	18.61	19.40				
Limit	EIRP < 1W			Result			Pass			

NR n77 Maximum Average Power [dBm] (GT - LC = -1.8 dB)										
BW [MHz]	RB Size	RB Offset	Mod	Lowest	Middle	Highest	EIRP (dBm)	EIRP(W)		
60	1	1	PI/2 BPSK	22.52	22.56	23.28	21.91	0.1552		
60	1	160		23.19	22.93	23.48				
60	81	40		23.05	23.42	23.71				
60	1	0		22.03	21.93	22.80				
60	1	161		22.68	22.36	22.99				
60	162	0		22.65	22.77	23.23				
60	1	1	QPSK	22.66	22.54	23.21			20.35	0.1084
60	1	160		23.03	22.91	23.66				
60	81	40		22.99	23.47	23.71				
60	1	0		21.52	21.54	22.25				
60	1	161		22.08	21.99	22.55				
60	162	0		22.25	22.22	22.81				
60	1	1	16-QAM	21.53	21.74	22.15	20.35	0.1084		
60	1	1	64-QAM	20.05	19.82	20.69				
60	1	1	256-QAM	18.15	17.99	18.78				
Limit	EIRP < 1W			Result			Pass			



NR n77 Maximum Average Power [dBm] (GT - LC = -1.8 dB)								
BW [MHz]	RB Size	RB Offset	Mod	Lowest	Middle	Highest	EIRP (dBm)	EIRP(W)
70	1	1	PI/2 BPSK	22.68	22.47	23.32	21.95	0.1567
70	1	187		22.77	23.05	23.69		
70	90	45		23.23	23.50	23.75		
70	1	0		22.09	22.14	22.87		
70	1	188		22.42	22.35	23.22		
70	180	0		22.83	22.85	23.29		
70	1	1	QPSK	22.86	22.56	23.22		
70	1	187		23.02	23.01	23.64		
70	90	45		23.31	23.45	23.74		
70	1	0		21.85	21.67	22.24		
70	1	188		22.00	21.92	22.73		
70	180	0		22.48	22.25	22.84		
70	1	1	16-QAM	21.78	21.57	22.33	20.53	0.1130
70	1	1	64-QAM	20.26	20.15	20.76		
70	1	1	256-QAM	18.29	18.05	18.79		
Limit	EIRP < 1W			Result			Pass	

NR n77 Maximum Average Power [dBm] (GT - LC = -1.8 dB)								
BW [MHz]	RB Size	RB Offset	Mod	Lowest	Middle	Highest	EIRP (dBm)	EIRP(W)
80	1	1	PI/2 BPSK	22.76	22.85	23.24	22.17	0.1648
80	1	215		22.98	23.29	23.75		
80	108	54		23.17	23.55	23.88		
80	1	0		22.29	22.27	22.86		
80	1	216		22.62	22.77	23.37		
80	216	0		22.67	22.94	23.32		
80	1	1	QPSK	22.73	22.94	23.25		
80	1	215		23.05	23.14	23.68		
80	108	54		23.29	23.53	23.97		
80	1	0		21.79	21.76	22.37		
80	1	216		21.94	22.16	22.86		
80	216	0		22.29	22.38	22.90		
80	1	1	16-QAM	21.86	21.77	22.43	20.63	0.1156
80	1	1	64-QAM	20.34	20.31	20.90		
80	1	1	256-QAM	18.40	18.24	18.81		
Limit	EIRP < 1W			Result			Pass	



NR n77 Maximum Average Power [dBm] (GT - LC = -1.8 dB)										
BW [MHz]	RB Size	RB Offset	Mod	Lowest	Middle	Highest	EIRP (dBm)	EIRP(W)		
90	1	1	PI/2 BPSK	22.96	23.05	23.47	22.40	0.1738		
90	1	243		23.17	23.34	23.75				
90	120	60		23.19	23.59	24.18				
90	1	0		22.41	22.44	23.03				
90	1	244		22.71	22.78	23.40				
90	243	0		22.74	23.07	23.52				
90	1	1	QPSK	22.84	23.10	23.47			20.70	0.1175
90	1	243		23.14	23.32	23.89				
90	120	60		23.31	23.58	24.20				
90	1	0		21.91	22.02	22.41				
90	1	244		22.16	22.25	22.93				
90	243	0		22.28	22.56	22.99				
90	1	1	16-QAM	21.89	21.97	22.50	20.70	0.1175		
90	1	1	64-QAM	20.61	20.69	20.83				
90	1	1	256-QAM	18.61	18.58	19.17				
Limit	EIRP < 1W			Result			Pass			

NR n77 Maximum Average Power [dBm] (GT - LC = -1.8 dB)										
BW [MHz]	RB Size	RB Offset	Mod	Lowest	Middle	Highest	EIRP (dBm)	EIRP(W)		
100	1	1	PI/2 BPSK	-	23.13	-	21.82	0.1521		
100	1	271		-	23.25	-				
100	135	67		-	23.62	-				
100	1	0		-	22.54	-				
100	1	272		-	22.67	-				
100	270	0		-	23.03	-				
100	1	1	QPSK	-	23.17	-			20.38	0.1091
100	1	271		-	23.28	-				
100	135	67		-	23.42	-				
100	1	0		-	22.07	-				
100	1	272		-	22.29	-				
100	270	0		-	22.45	-				
100	1	1	16-QAM	-	22.18	-	20.38	0.1091		
100	1	1	64-QAM	-	20.53	-				
100	1	1	256-QAM	-	18.35	-				
Limit	EIRP < 1W			Result			Pass			



NR n77 HPUE Maximum Average Power [dBm] (GT - LC = -1.8 dB)								
BW [MHz]	RB Size	RB Offset	Mod	Lowest	Middle	Highest	EIRP (dBm)	EIRP(W)
10	1	1	PI/2 BPSK	26.15	25.08	25.87	24.40	0.2754
10	1	22		26.12	25.07	25.73		
10	12	6		26.20	25.26	25.83		
10	1	0		22.59	21.56	22.33		
10	1	23		22.64	21.59	22.32		
10	24	0		25.62	24.70	25.47		
10	1	1	QPSK	26.06	25.01	25.95		
10	1	22		26.05	25.15	25.87		
10	12	6		26.05	25.25	25.96		
10	1	0		22.70	21.66	22.44		
10	1	23		22.51	21.62	22.39		
10	24	0		25.06	24.14	24.89		
10	1	1	16-QAM	24.96	24.04	25.19	23.39	0.2183
10	1	1	64-QAM	23.95	22.46	23.47		
10	1	1	256-QAM	21.54	20.36	21.29		
Limit	EIRP < 1W			Result			Pass	

NR n77 HPUE Maximum Average Power [dBm] (GT - LC = -1.8 dB)								
BW [MHz]	RB Size	RB Offset	Mod	Lowest	Middle	Highest	EIRP (dBm)	EIRP(W)
15	1	1	PI/2 BPSK	26.18	24.99	25.93	24.39	0.2748
15	1	36		26.13	25.07	25.79		
15	18	9		26.17	25.13	26.00		
15	1	0		22.67	21.54	22.48		
15	1	37		22.61	21.69	22.38		
15	36	0		25.43	24.73	25.34		
15	1	1	QPSK	26.19	25.07	25.91		
15	1	36		26.11	25.25	25.82		
15	18	9		26.10	25.24	25.95		
15	1	0		22.60	21.61	22.54		
15	1	37		22.68	21.70	22.39		
15	36	0		25.12	24.22	24.93		
15	1	1	16-QAM	25.23	24.27	25.01	23.43	0.2203
15	1	1	64-QAM	23.84	22.61	23.40		
15	1	1	256-QAM	21.62	20.69	21.35		
Limit	EIRP < 1W			Result			Pass	



NR n77 HPUE Maximum Average Power [dBm] (GT - LC = -1.8 dB)								
BW [MHz]	RB Size	RB Offset	Mod	Lowest	Middle	Highest	EIRP (dBm)	EIRP(W)
20	1	1	PI/2 BPSK	26.17	25.35	25.77	24.40	0.2754
20	1	49		26.10	25.40	25.77		
20	25	12		26.20	25.67	25.94		
20	1	0		23.01	21.93	22.31		
20	1	50		22.92	21.94	22.35		
20	50	0		25.56	24.95	25.39		
20	1	1	QPSK	26.15	25.34	25.86		
20	1	49		26.17	25.28	25.82		
20	25	12		26.11	25.56	25.92		
20	1	0		23.00	21.99	22.35		
20	1	50		22.87	21.85	22.30		
20	50	0		25.21	24.53	24.86		
20	1	1	16-QAM	25.34	24.26	24.76	23.54	0.2259
20	1	1	64-QAM	24.06	22.53	23.22		
20	1	1	256-QAM	21.99	20.86	21.30		
Limit	EIRP < 1W			Result			Pass	

NR n77 HPUE Maximum Average Power [dBm] (GT - LC = -1.8 dB)								
BW [MHz]	RB Size	RB Offset	Mod	Lowest	Middle	Highest	EIRP (dBm)	EIRP(W)
25	1	1	PI/2 BPSK	26.15	25.41	26.16	24.39	0.2748
25	1	63		26.14	25.26	26.00		
25	32	16		26.13	25.56	26.15		
25	1	0		22.91	21.97	22.59		
25	1	64		22.80	21.76	22.65		
25	64	0		25.92	24.95	25.70		
25	1	1	QPSK	26.13	25.56	26.14		
25	1	63		26.19	25.39	26.06		
25	32	16		26.16	25.45	26.11		
25	1	0		23.19	21.94	22.80		
25	1	64		22.84	21.90	22.54		
25	64	0		25.60	24.52	25.16		
25	1	1	16-QAM	25.81	24.61	25.03	24.01	0.2518
25	1	1	64-QAM	24.14	22.95	23.81		
25	1	1	256-QAM	22.03	21.02	21.46		
Limit	EIRP < 1W			Result			Pass	



NR n77 HPUE Maximum Average Power [dBm] (GT - LC = -1.8 dB)								
BW [MHz]	RB Size	RB Offset	Mod	Lowest	Middle	Highest	EIRP (dBm)	EIRP(W)
30	1	1	PI/2 BPSK	26.10	25.60	26.19	24.39	0.2748
30	1	76		26.16	25.49	26.18		
30	36	18		26.17	25.78	26.14		
30	1	0		23.14	22.14	22.83		
30	1	77		22.94	21.87	22.71		
30	75	0		26.13	25.24	25.89		
30	1	1	QPSK	26.12	25.73	26.11		
30	1	76		26.18	25.44	26.16		
30	36	18		26.18	25.62	26.10		
30	1	0		23.11	22.04	22.91		
30	1	77		22.86	21.80	22.75		
30	75	0		25.61	24.70	25.43		
30	1	1	16-QAM	25.90	24.54	25.30	24.10	0.2570
30	1	1	64-QAM	24.13	23.21	23.57		
30	1	1	256-QAM	22.08	21.23	21.62		
Limit	EIRP < 1W			Result			Pass	

NR n77 HPUE Maximum Average Power [dBm] (GT - LC = -1.8 dB)								
BW [MHz]	RB Size	RB Offset	Mod	Lowest	Middle	Highest	EIRP (dBm)	EIRP(W)
40	1	1	PI/2 BPSK	26.15	25.52	26.19	24.39	0.2748
40	1	104		26.18	25.41	26.16		
40	50	25		26.11	25.62	26.18		
40	1	0		23.27	22.12	23.01		
40	1	105		23.12	21.92	22.67		
40	100	0		26.10	25.03	25.67		
40	1	1	QPSK	26.15	25.59	26.13		
40	1	104		26.16	25.29	26.15		
40	50	25		26.16	25.68	26.18		
40	1	0		23.22	22.24	22.93		
40	1	105		23.06	21.93	22.73		
40	100	0		25.59	24.72	25.28		
40	1	1	16-QAM	26.02	24.52	25.39	24.22	0.2642
40	1	1	64-QAM	24.25	23.00	24.07		
40	1	1	256-QAM	22.07	21.09	22.03		
Limit	EIRP < 1W			Result			Pass	



NR n77 HPUE Maximum Average Power [dBm] (GT - LC = -1.8 dB)										
BW [MHz]	RB Size	RB Offset	Mod	Lowest	Middle	Highest	EIRP (dBm)	EIRP(W)		
50	1	1	PI/2 BPSK	26.18	25.46	26.14	24.38	0.2742		
50	1	131		26.17	25.29	26.15				
50	64	32		26.12	25.60	26.10				
50	1	0		23.40	21.98	23.21				
50	1	132		23.21	21.77	22.54				
50	128	0		26.05	24.97	25.72				
50	1	1	QPSK	26.12	25.41	26.16			24.38	0.2742
50	1	131		26.16	25.23	26.03				
50	64	32		26.11	25.66	26.18				
50	1	0		23.32	21.98	23.30				
50	1	132		23.19	21.75	22.58				
50	128	0		25.57	24.63	25.40				
50	1	1	16-QAM	25.84	24.43	25.48	24.04	0.2535		
50	1	1	64-QAM	24.36	23.02	23.94				
50	1	1	256-QAM	22.10	20.85	22.20				
Limit	EIRP < 1W			Result			Pass			

NR n77 HPUE Maximum Average Power [dBm] (GT - LC = -1.8 dB)										
BW [MHz]	RB Size	RB Offset	Mod	Lowest	Middle	Highest	EIRP (dBm)	EIRP(W)		
60	1	1	PI/2 BPSK	26.17	25.00	25.92	24.40	0.2754		
60	1	160		26.12	25.22	26.13				
60	81	40		26.18	25.69	26.20				
60	1	0		22.79	21.58	22.45				
60	1	161		23.03	21.64	22.71				
60	162	0		26.17	25.05	25.86				
60	1	1	QPSK	26.15	24.90	26.01			24.40	0.2754
60	1	160		26.11	25.11	26.17				
60	81	40		26.14	25.60	26.14				
60	1	0		22.85	21.56	22.41				
60	1	161		23.11	21.88	22.73				
60	162	0		25.74	24.64	25.35				
60	1	1	16-QAM	25.60	23.81	25.00	23.80	0.2399		
60	1	1	64-QAM	23.79	22.61	23.41				
60	1	1	256-QAM	21.58	20.44	21.31				
Limit	EIRP < 1W			Result			Pass			



NR n77 HPUE Maximum Average Power [dBm] (GT - LC = -1.8 dB)								
BW [MHz]	RB Size	RB Offset	Mod	Lowest	Middle	Highest	EIRP (dBm)	EIRP(W)
70	1	1	PI/2 BPSK	26.10	25.20	26.00	24.40	0.2754
70	1	187		26.20	25.26	26.14		
70	90	45		26.17	25.65	26.10		
70	1	0		22.88	21.57	22.53		
70	1	188		22.90	21.77	22.69		
70	180	0		26.19	25.10	25.93		
70	1	1	QPSK	26.15	25.07	26.02		
70	1	187		26.16	25.30	26.17		
70	90	45		26.11	25.57	26.19		
70	1	0		22.84	21.67	22.56		
70	1	188		22.95	21.63	22.68		
70	180	0		25.68	24.58	25.44		
70	1	1	16-QAM	25.18	24.27	25.14	23.38	0.2178
70	1	1	64-QAM	23.77	22.65	23.30		
70	1	1	256-QAM	21.87	20.73	21.70		
Limit	EIRP < 1W			Result			Pass	

NR n77 HPUE Maximum Average Power [dBm] (GT - LC = -1.8 dB)								
BW [MHz]	RB Size	RB Offset	Mod	Lowest	Middle	Highest	EIRP (dBm)	EIRP(W)
80	1	1	PI/2 BPSK	26.11	25.19	25.94	24.39	0.2748
80	1	215		26.14	25.34	26.08		
80	108	54		26.11	25.66	26.10		
80	1	0		22.89	21.74	22.50		
80	1	216		22.80	21.93	22.67		
80	216	0		26.12	25.10	25.63		
80	1	1	QPSK	26.11	25.29	26.02		
80	1	215		26.13	25.34	26.12		
80	108	54		26.19	25.60	26.14		
80	1	0		22.84	21.63	22.48		
80	1	216		22.81	21.72	22.67		
80	216	0		25.59	24.62	25.29		
80	1	1	16-QAM	25.26	24.31	24.79	23.46	0.2218
80	1	1	64-QAM	23.76	22.69	23.38		
80	1	1	256-QAM	21.88	20.46	21.53		
Limit	EIRP < 1W			Result			Pass	



NR n77 HPUE Maximum Average Power [dBm] (GT - LC = -1.8 dB)								
BW [MHz]	RB Size	RB Offset	Mod	Lowest	Middle	Highest	EIRP (dBm)	EIRP(W)
90	1	1	PI/2 BPSK	26.13	25.22	25.95	24.38	0.2742
90	1	243		26.17	25.28	26.12		
90	120	60		26.17	25.52	26.12		
90	1	0		22.93	21.79	22.45		
90	1	244		22.93	21.90	22.63		
90	243	0		26.00	25.01	25.87		
90	1	1	QPSK	26.13	25.21	26.07		
90	1	243		26.12	25.36	26.16		
90	120	60		26.13	25.66	26.18		
90	1	0		22.89	21.72	22.65		
90	1	244		22.92	21.86	22.75		
90	243	0		25.49	24.59	25.40		
90	1	1	16-QAM	25.45	24.18	25.13	23.65	0.2317
90	1	1	64-QAM	23.89	22.84	23.50		
90	1	1	256-QAM	21.97	20.71	21.42		
Limit	EIRP < 1W			Result			Pass	

NR n77 HPUE Maximum Average Power [dBm] (GT - LC = -1.8 dB)								
BW [MHz]	RB Size	RB Offset	Mod	Lowest	Middle	Highest	EIRP (dBm)	EIRP(W)
100	1	1	PI/2 BPSK	-	25.23	-	23.90	0.2455
100	1	271		-	25.45	-		
100	135	67		-	25.70	-		
100	1	0		-	21.82	-		
100	1	272		-	21.86	-		
100	270	0		-	25.13	-		
100	1	1	QPSK	-	25.31	-		
100	1	271		-	25.32	-		
100	135	67		-	25.66	-		
100	1	0		-	21.88	-		
100	1	272		-	21.92	-		
100	270	0		-	24.59	-		
100	1	1	16-QAM	-	24.54	-	22.74	0.1879
100	1	1	64-QAM	-	22.91	-		
100	1	1	256-QAM	-	20.81	-		
Limit	EIRP < 1W			Result			Pass	



FR1 n77_HPUE

Peak-to-Average Ratio

Mode	FR1 n77 / 20MHz / DFT-S OFDM				
Mod.	PI/2 BPSK	QPSK	16QAM	64QAM	Limit: 13dB
RB Size	Full RB	Full RB	Full RB	Full RB	Result
Middle CH	4.56	5.24	5.98	6.14	PASS
Mode	FR1 n77 / 20MHz / DFT-S OFDM				
Mod.	256QAM				Limit: 13dB
RB Size	Full RB				Result
Middle CH	6.72				PASS



FR1 n77 / 20MHz / DFT-S OFDM / Middle Channel / Full RB

PI/2 BPSK

QPSK

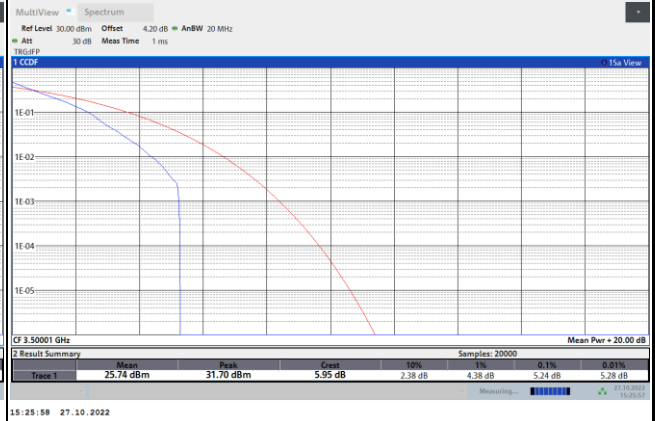
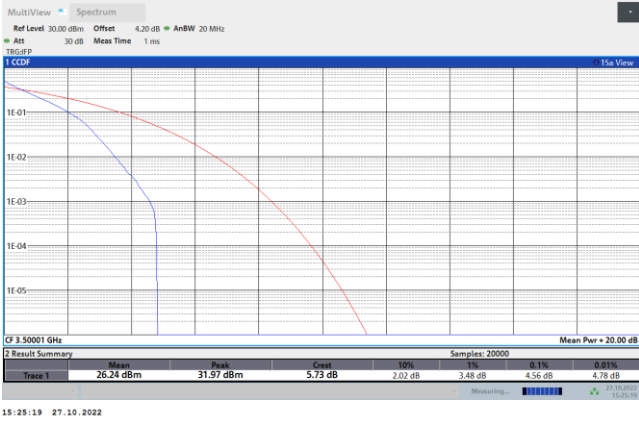

16QAM

64QAM

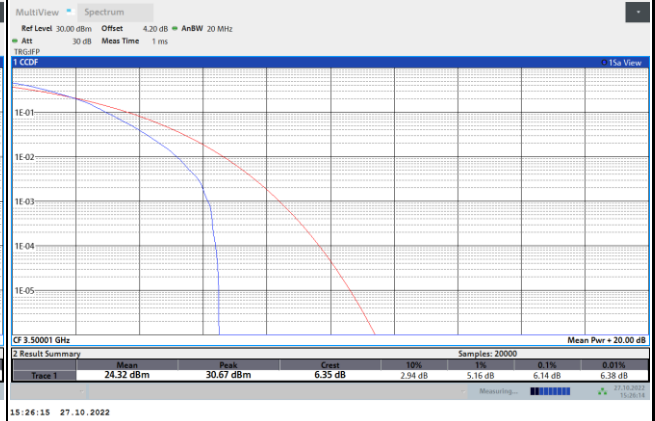
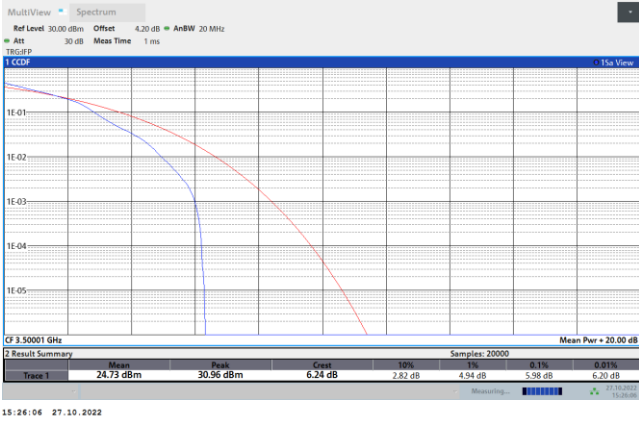

256QAM

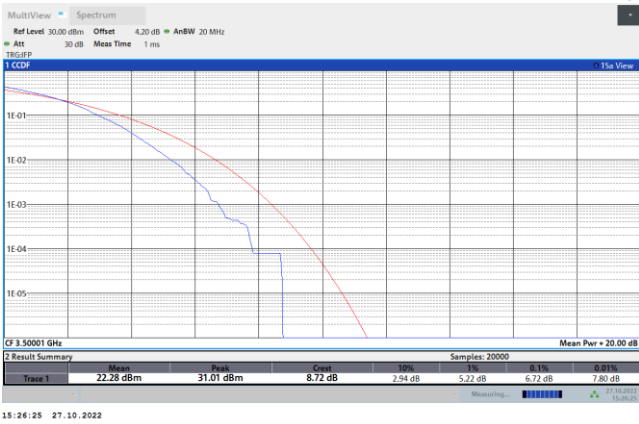



26dB Bandwidth

Mode	FR1 n77 : 26dB BW(MHz) / DFT-S OFDM							
BW	10MHz	15MHz	20MHz	25MHz	30MHz	40MHz	50MHz	60MHz
Mod.	PI/2 BPSK	PI/2 BPSK	PI/2 BPSK	PI/2 BPSK	PI/2 BPSK	PI/2 BPSK	PI/2 BPSK	PI/2 BPSK
Middle CH	9.09	13.67	19.02	24.08	28.23	38.28	48.15	60.54
BW	70MHz	80MHz	90MHz	100MHz				
Mod.	PI/2 BPSK	PI/2 BPSK	PI/2 BPSK	PI/2 BPSK				
Middle CH	67.27	80.24	90.27	99.90				

Mode	FR1 n77 : 26dB BW(MHz) / CP OFDM							
BW	10MHz		15MHz		20MHz		25MHz	
Mod.	QPSK	16QAM	QPSK	16QAM	QPSK	16QAM	QPSK	16QAM
Middle CH	9.49	9.13	14.42	15.02	19.18	19.86	24.23	24.28
Mod.	64QAM	256QAM	64QAM	256QAM	64QAM	256QAM	64QAM	256QAM
Middle CH	9.55	9.17	14.66	14.69	19.30	19.30	24.43	24.38
BW	30MHz		40MHz		50MHz		60MHz	
Mod.	QPSK	16QAM	QPSK	16QAM	QPSK	16QAM	QPSK	16QAM
Middle CH	29.01	29.13	40.68	40.60	50.35	50.05	60.90	60.42
Mod.	64QAM	256QAM	64QAM	256QAM	64QAM	256QAM	64QAM	256QAM
Middle CH	28.95	28.83	40.84	40.28	50.25	50.05	60.66	60.90
BW	70MHz		80MHz		90MHz		100MHz	
Mod.	QPSK	16QAM	QPSK	16QAM	QPSK	16QAM	QPSK	16QAM
Middle CH	70.49	70.21	80.88	80.56	90.99	90.99	101.30	100.30
Mod.	64QAM	256QAM	64QAM	256QAM	64QAM	256QAM	64QAM	256QAM
Middle CH	70.91	70.77	80.88	80.40	90.81	90.45	101.50	100.50



FR1 n77 / 10MHz / DFT-S OFDM / Middle Channel / Full RB

PI/2 BPSK

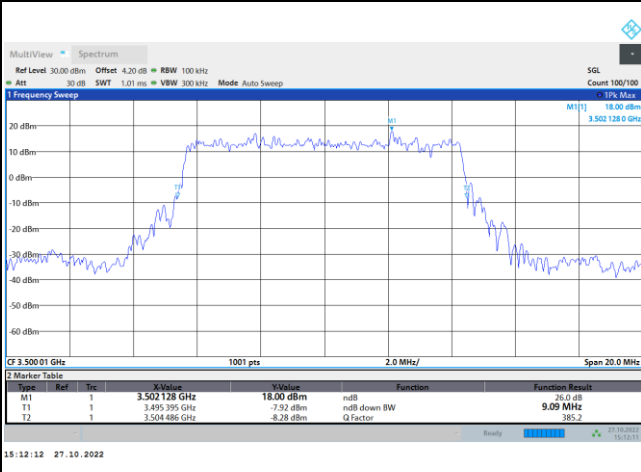

FR1 n77 / 10MHz / CP OFDM / Middle Channel / Full RB

QPSK

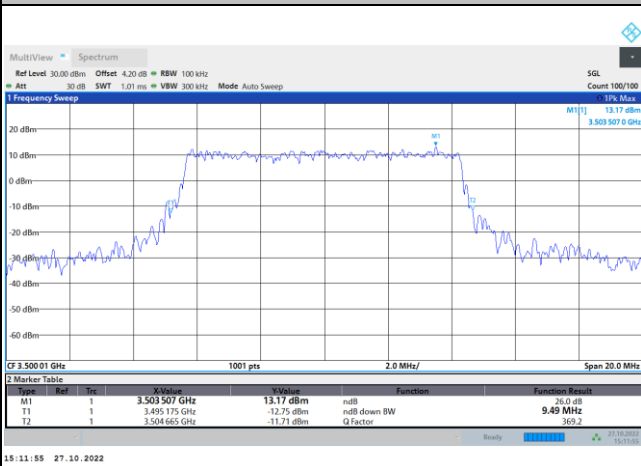

16QAM

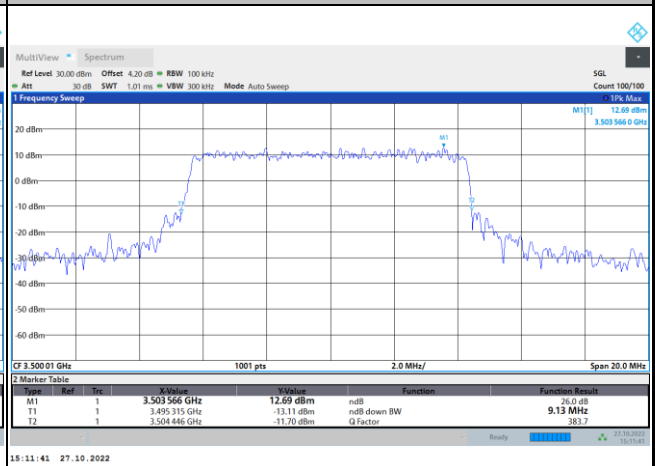

64QAM

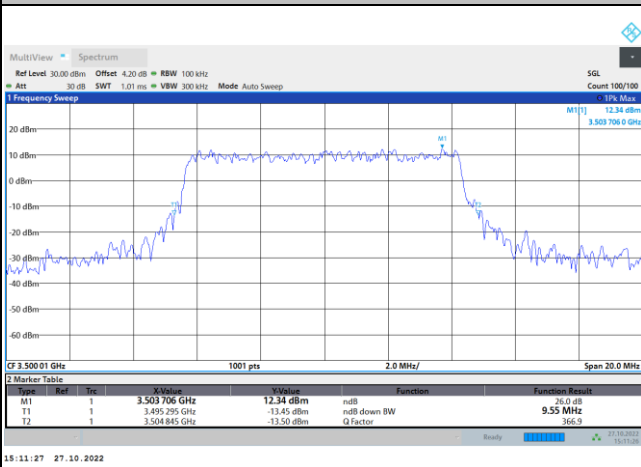

256QAM

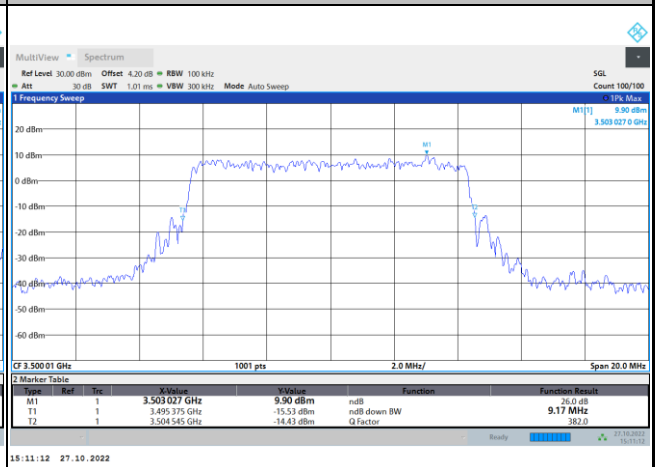



FR1 n77 / 15MHz / DFT-S OFDM / Middle Channel / Full RB

PI/2 BPSK

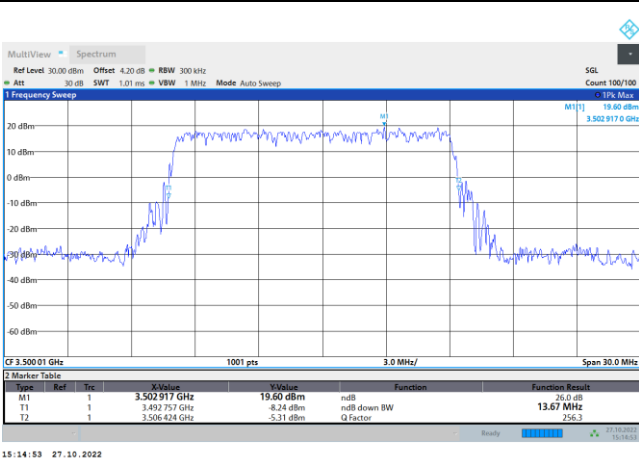

FR1 n77 / 15MHz / CP OFDM / Middle Channel / Full RB

QPSK

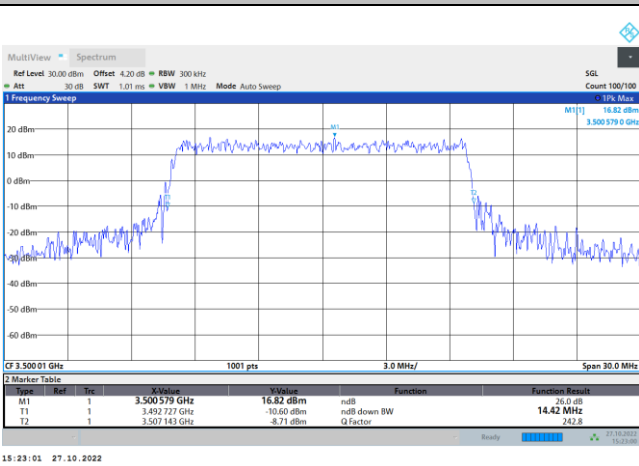

16QAM

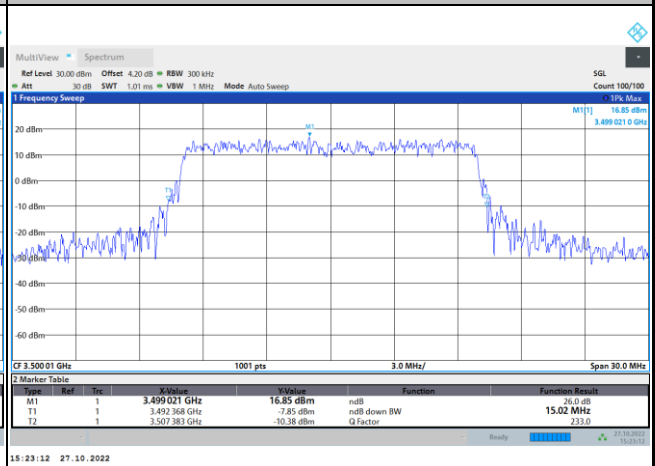

64QAM

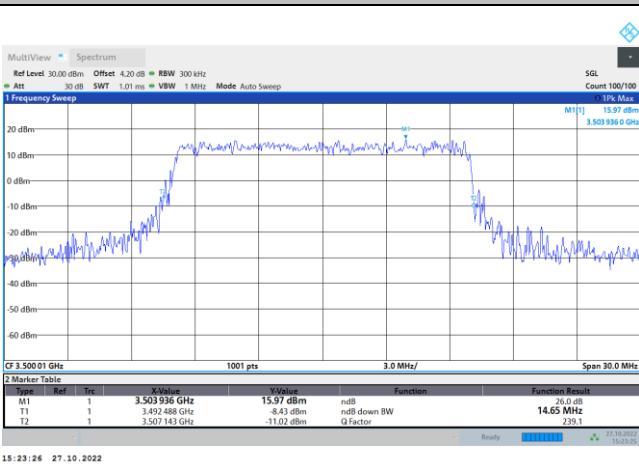

256QAM

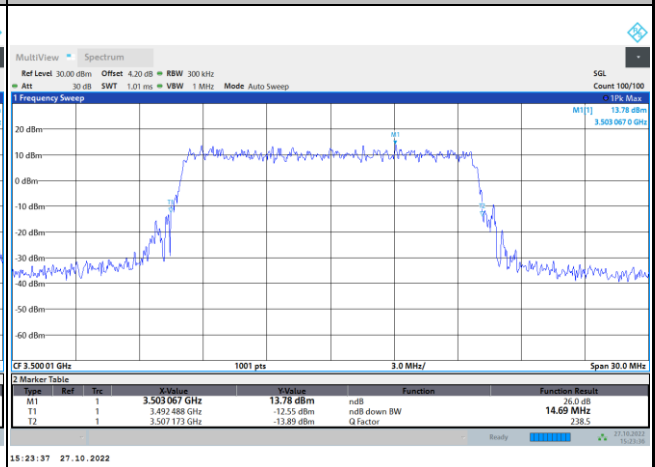



FR1 n77 / 20MHz / DFT-S OFDM / Middle Channel / Full RB

PI/2 BPSK

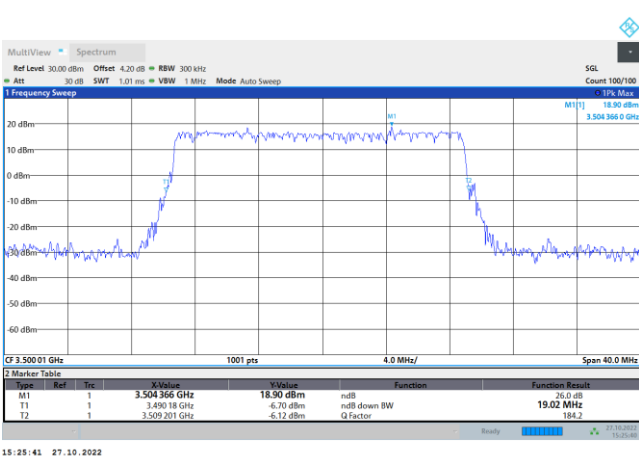

FR1 n77 / 20MHz / CP OFDM / Middle Channel / Full RB

QPSK

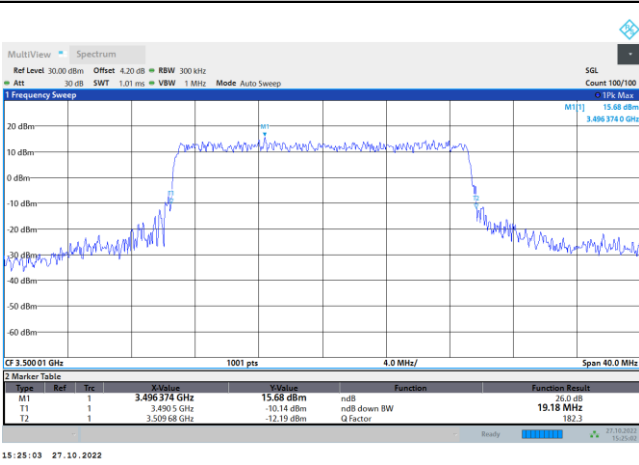

16QAM

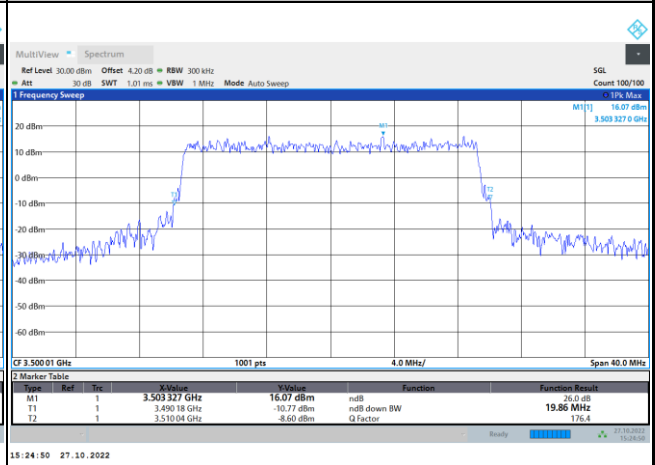

64QAM

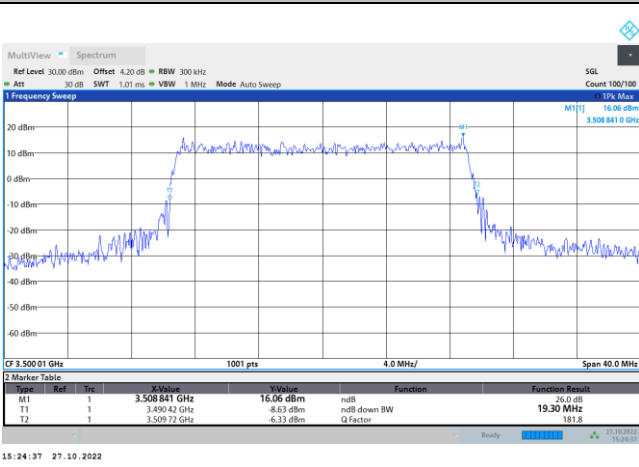

256QAM

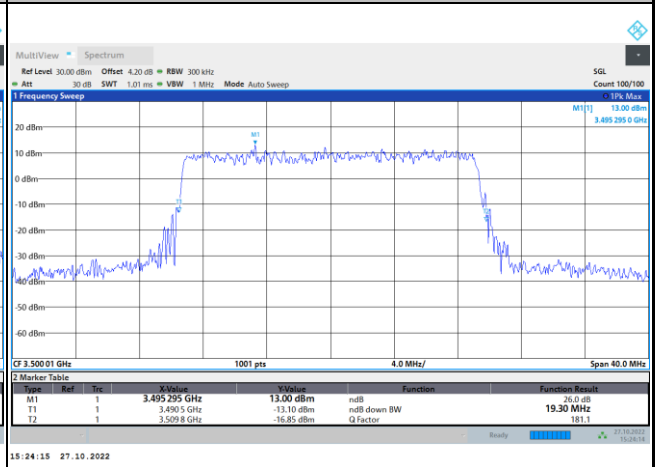



FR1 n77 / 25MHz / DFT-S OFDM / Middle Channel / Full RB

PI/2 BPSK

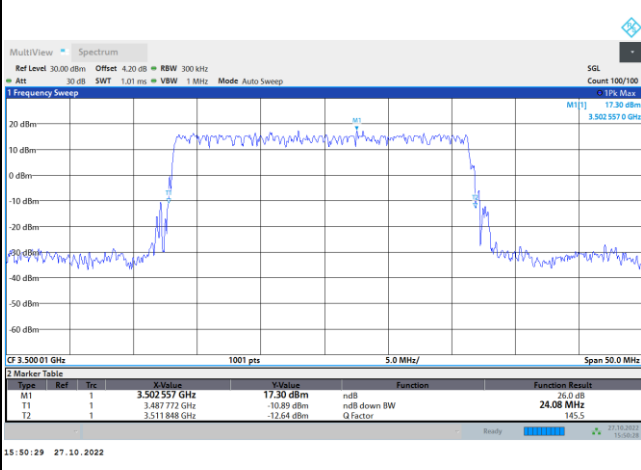

FR1 n77 / 25MHz / CP OFDM / Middle Channel / Full RB

QPSK

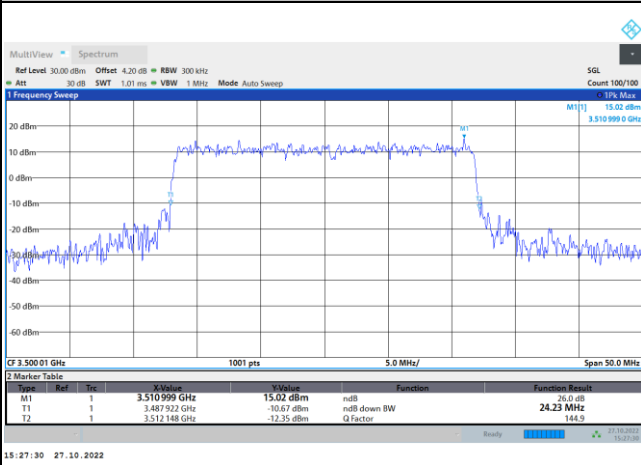

16QAM

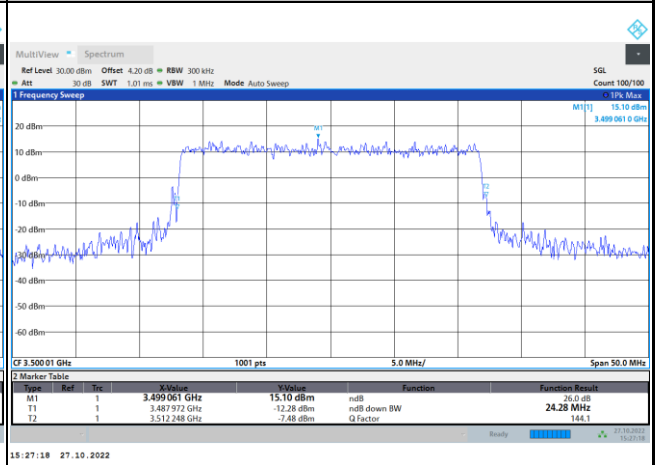

64QAM

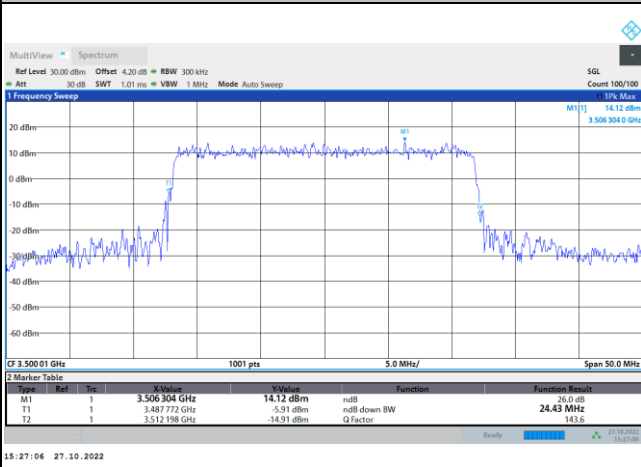

256QAM

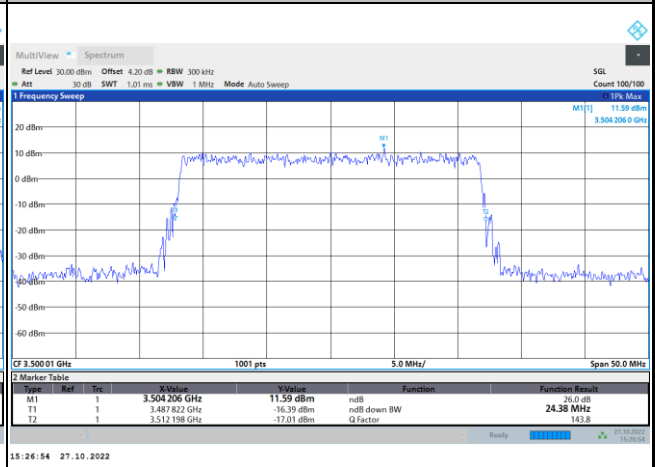



FR1 n77 / 30MHz / DFT-S OFDM / Middle Channel / Full RB

PI/2 BPSK

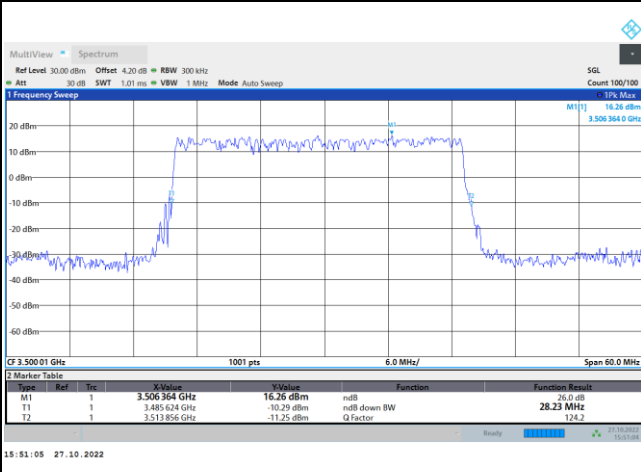

FR1 n77 / 30MHz / CP OFDM / Middle Channel / Full RB

QPSK

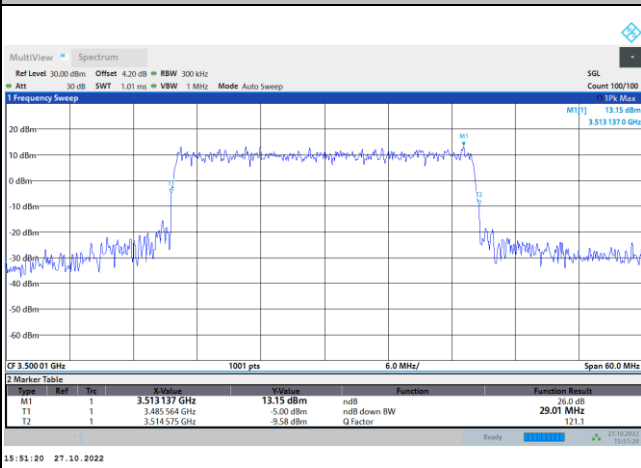

16QAM

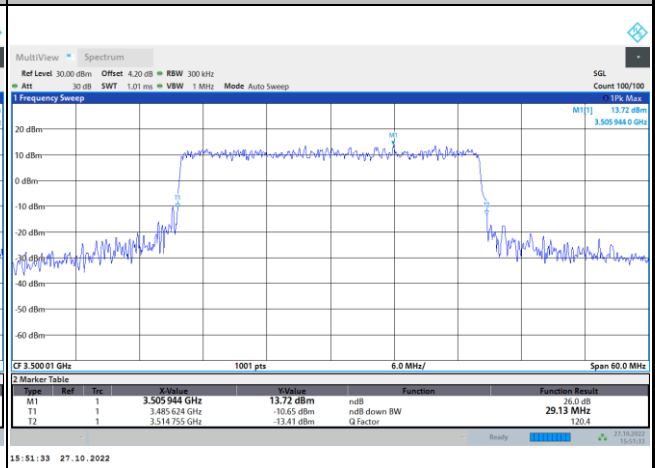

64QAM

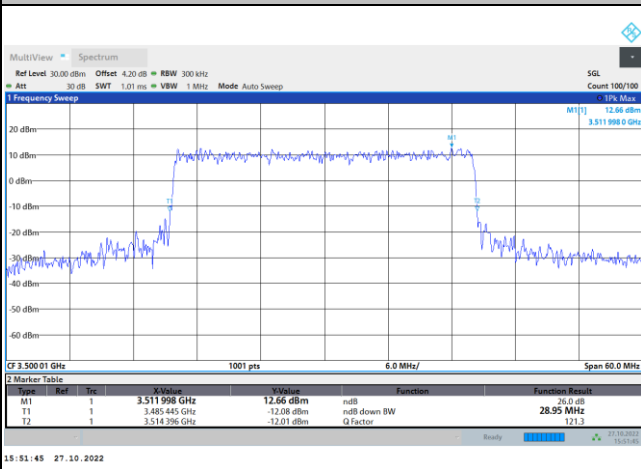

256QAM

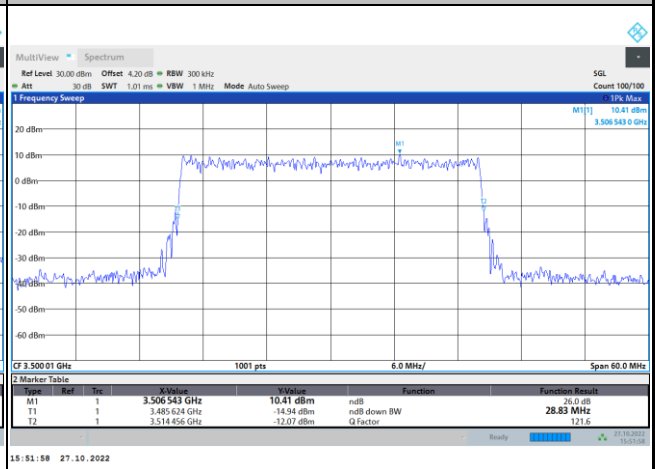



FR1 n77 / 40MHz / DFT-S OFDM / Middle Channel / Full RB

PI/2 BPSK

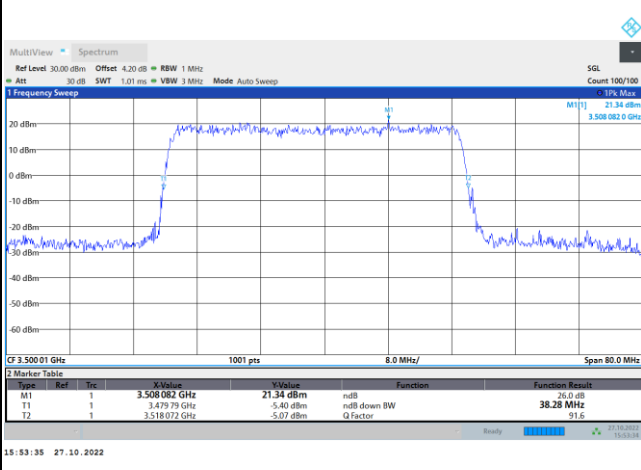

FR1 n77 / 40MHz / CP OFDM / Middle Channel / Full RB

QPSK

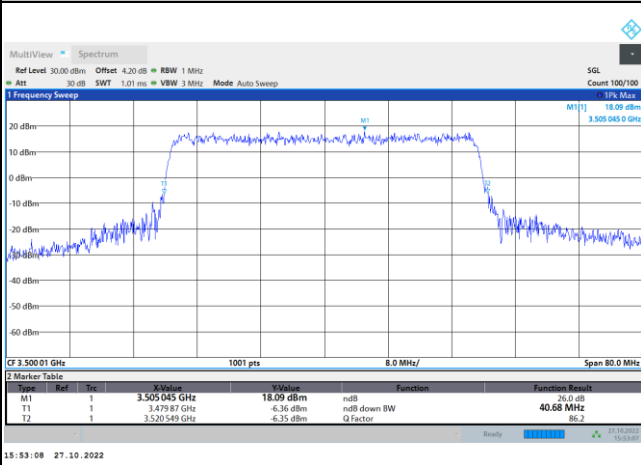

16QAM

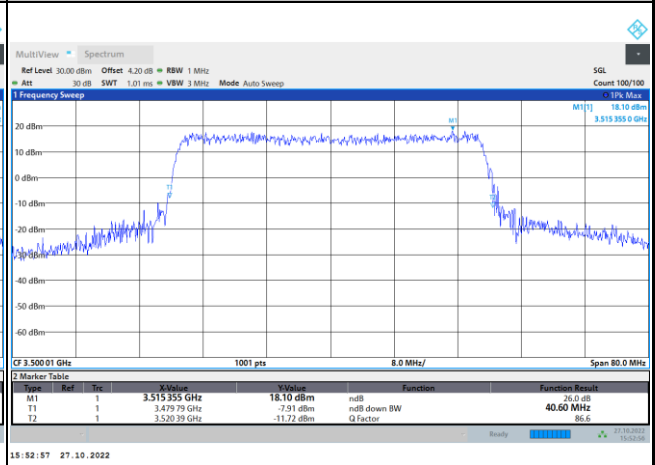

64QAM

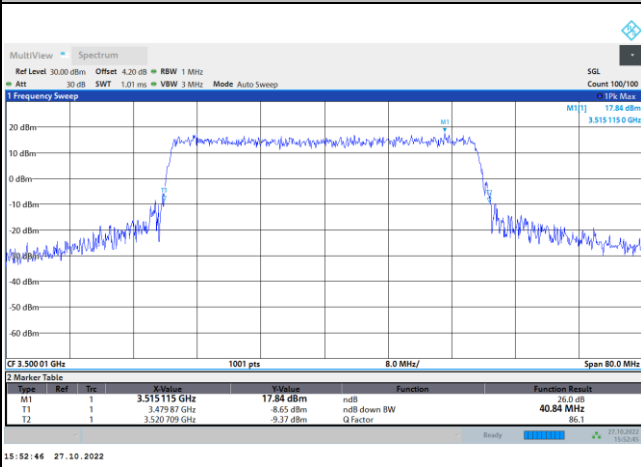

256QAM

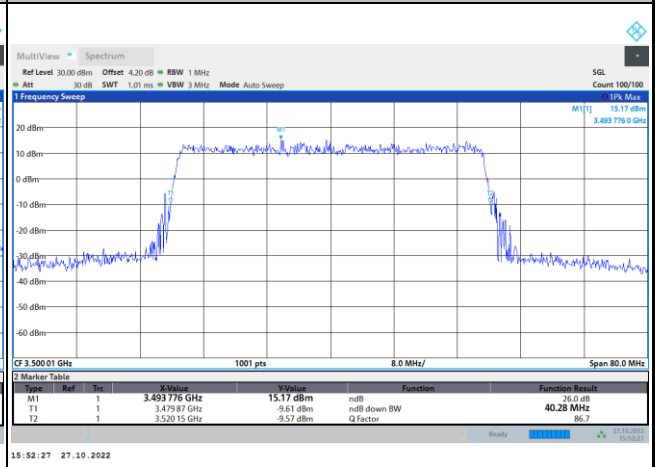



FR1 n77 / 50MHz / DFT-S OFDM / Middle Channel / Full RB

PI/2 BPSK

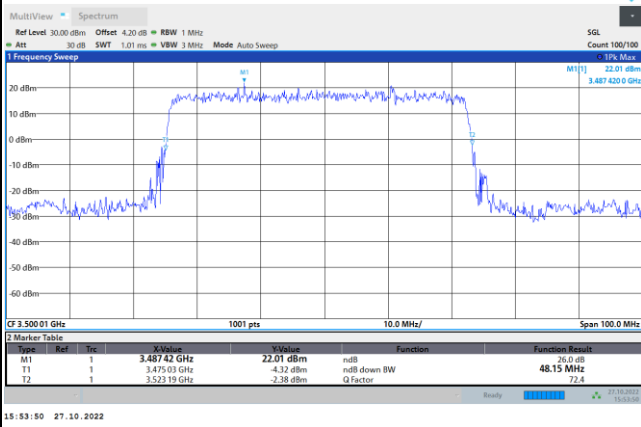

FR1 n77 / 50MHz / CP OFDM / Middle Channel / Full RB

QPSK

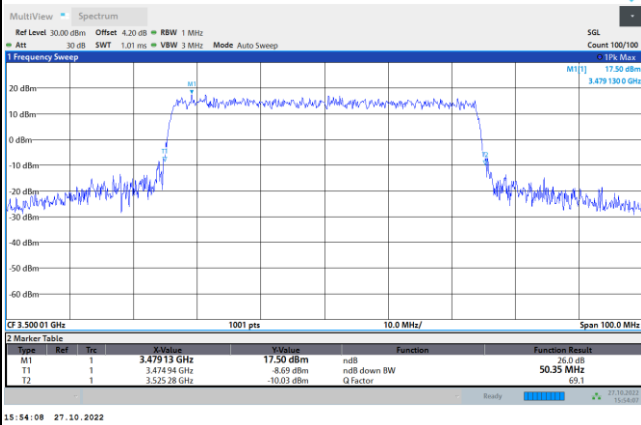

16QAM

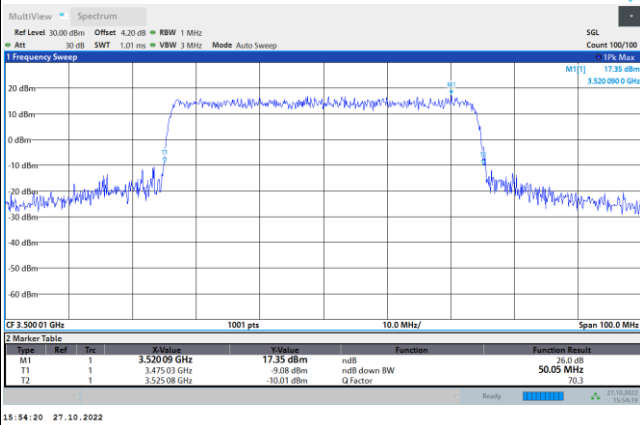

64QAM

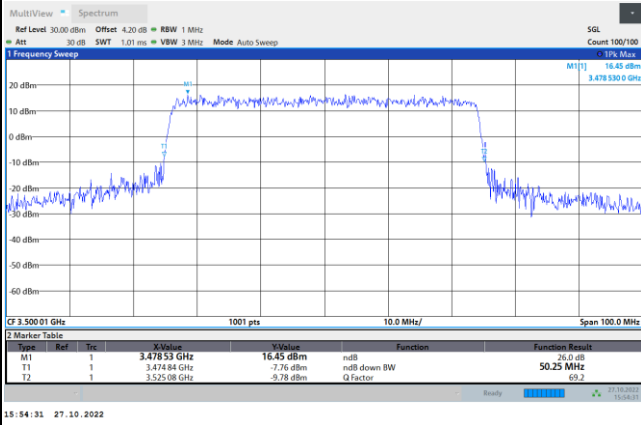

256QAM

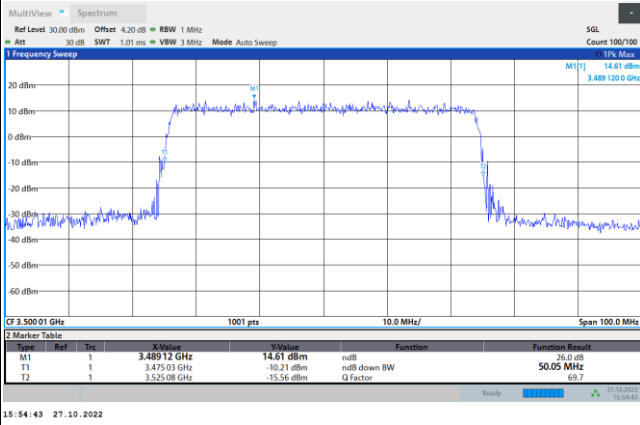



FR1 n77 / 60MHz / DFT-S OFDM / Middle Channel / Full RB

PI/2 BPSK

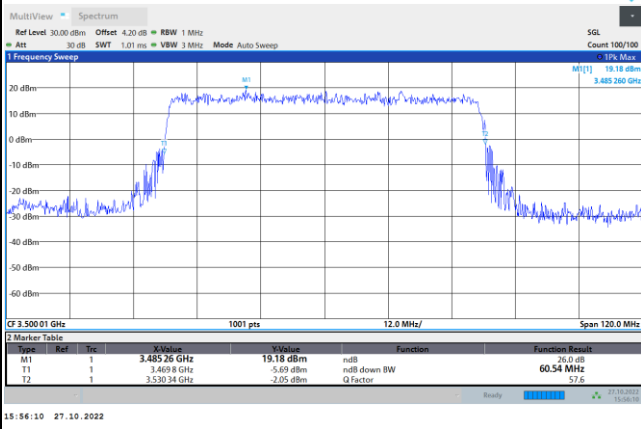

FR1 n77 / 60MHz / CP OFDM / Middle Channel / Full RB

QPSK

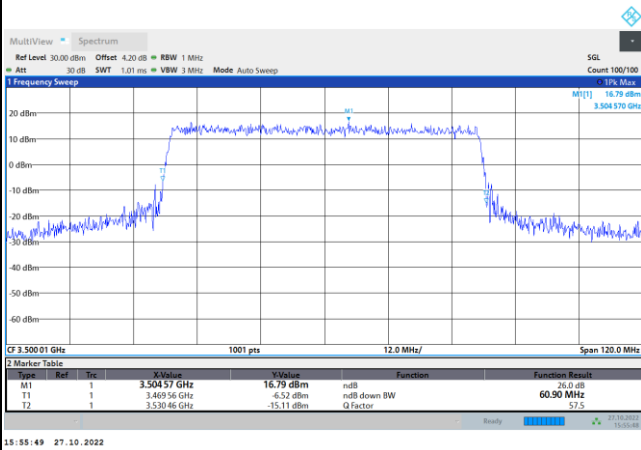

16QAM

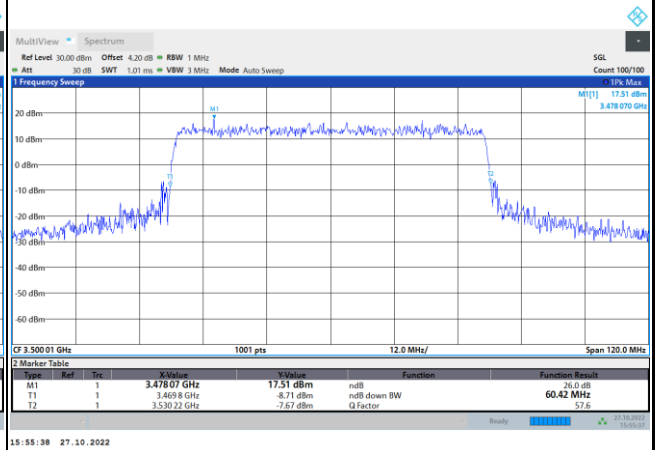

64QAM

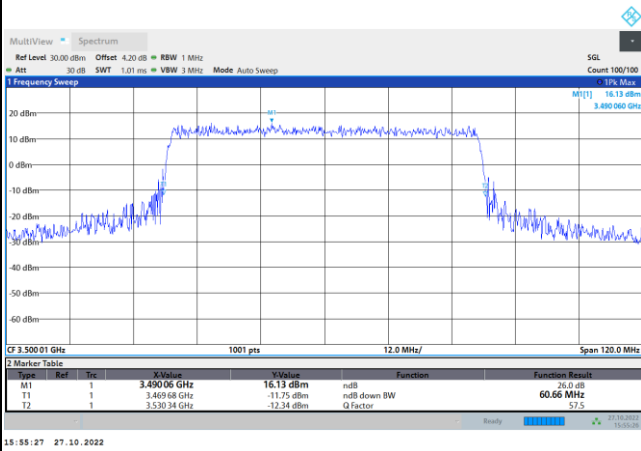

256QAM

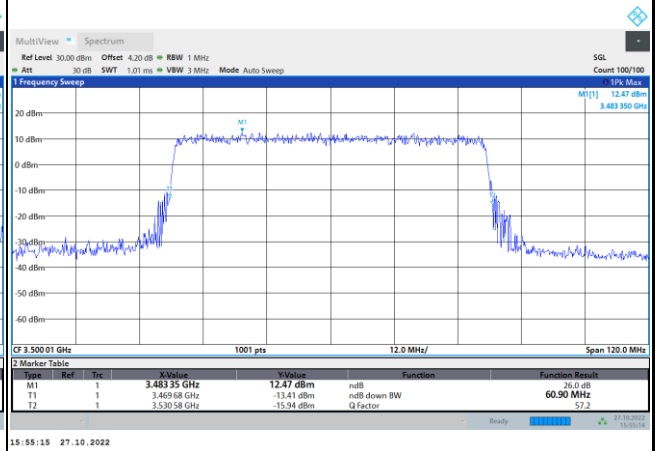



FR1 n77 / 70MHz / DFT-S OFDM / Middle Channel / Full RB

PI/2 BPSK

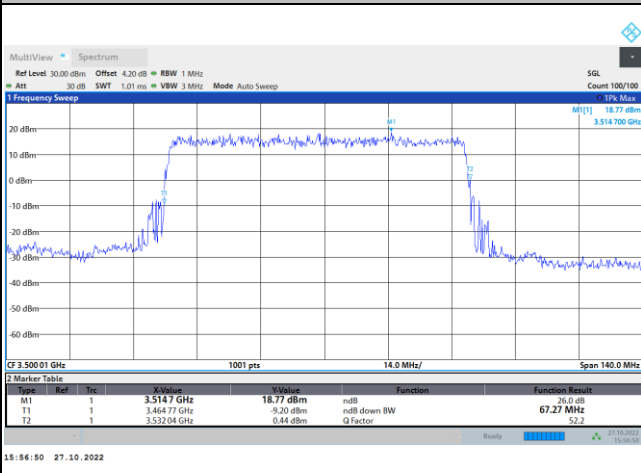

FR1 n77 / 70MHz / CP OFDM / Middle Channel / Full RB

QPSK

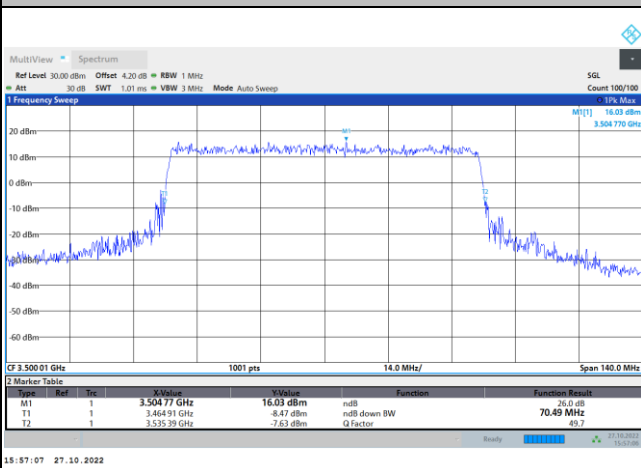

16QAM

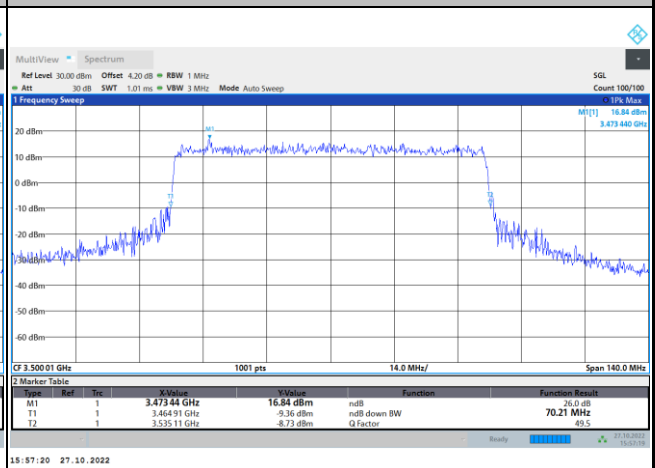

64QAM

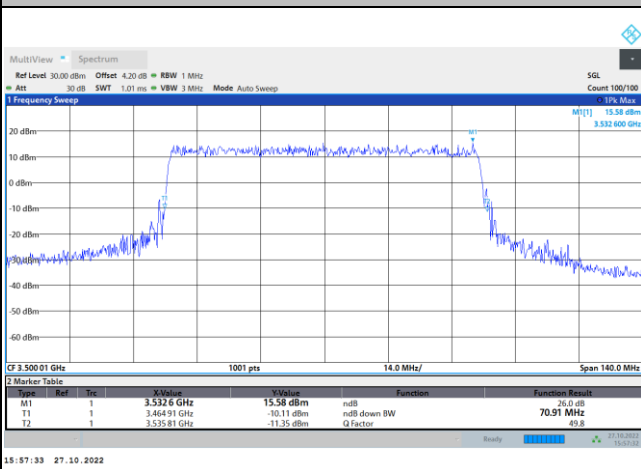

256QAM

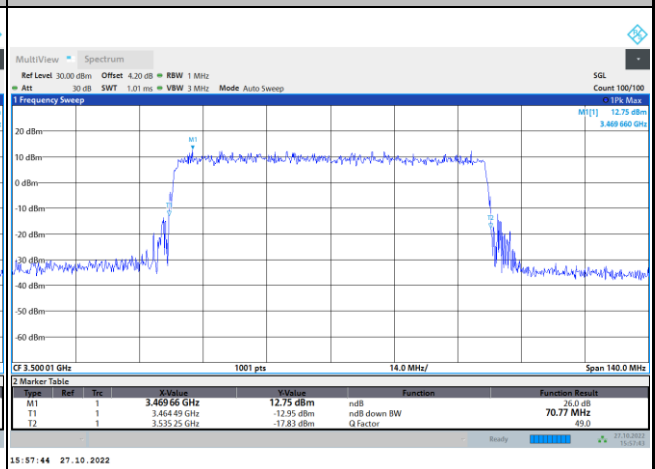



FR1 n77 / 80MHz / DFT-S OFDM / Middle Channel / Full RB

PI/2 BPSK

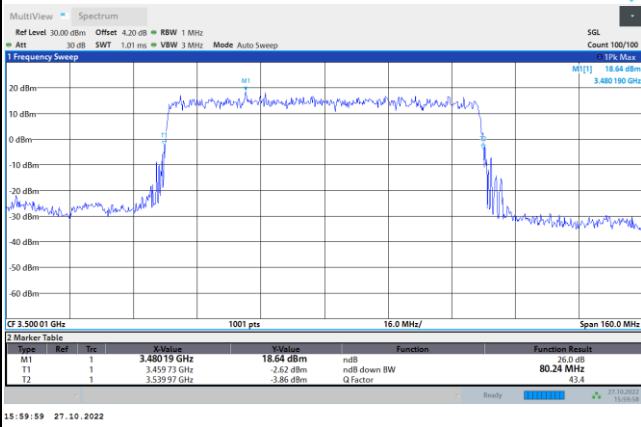

FR1 n77 / 80MHz / CP OFDM / Middle Channel / Full RB

QPSK

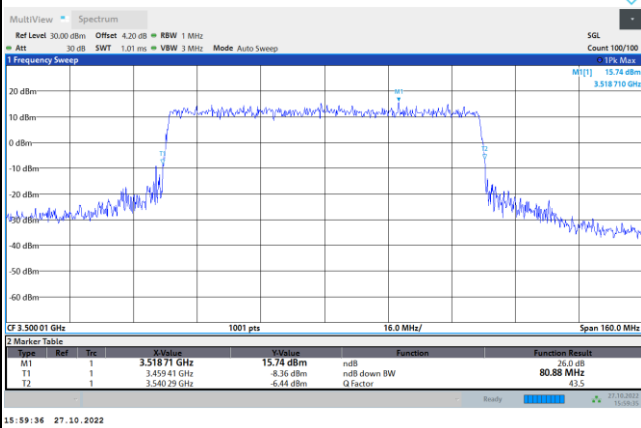

16QAM

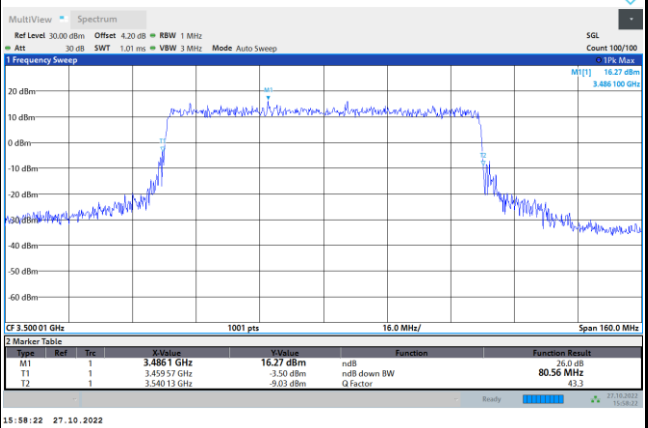

64QAM

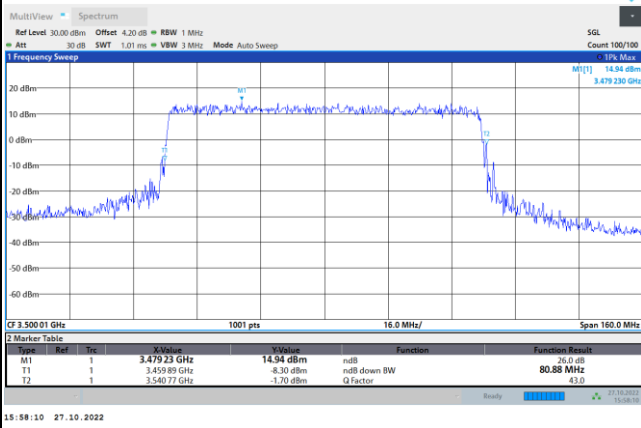

256QAM

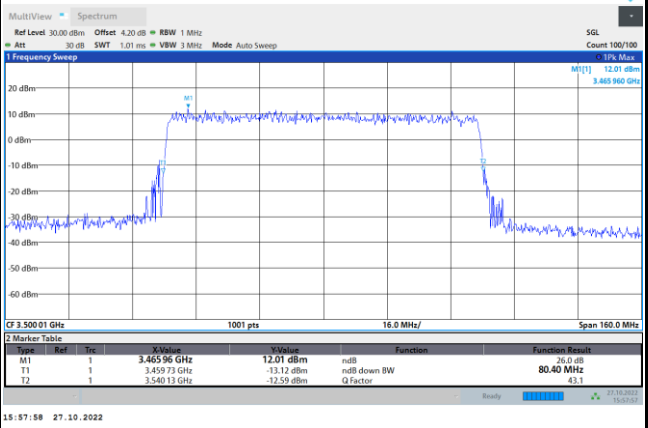



FR1 n77 / 90MHz / DFT-S OFDM / Middle Channel / Full RB

PI/2 BPSK



FR1 n77 / 90MHz / CP OFDM / Middle Channel / Full RB

QPSK

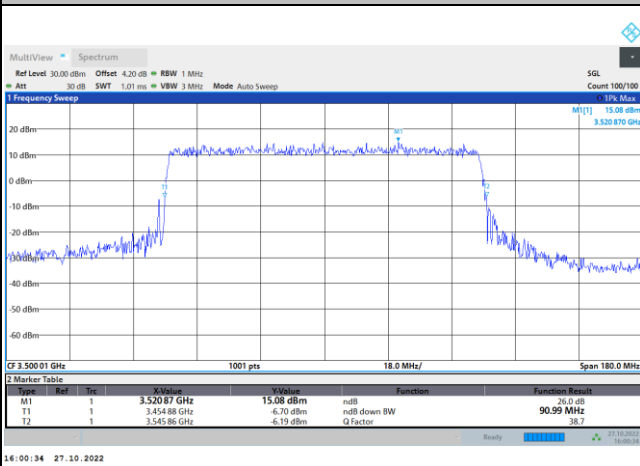

16QAM

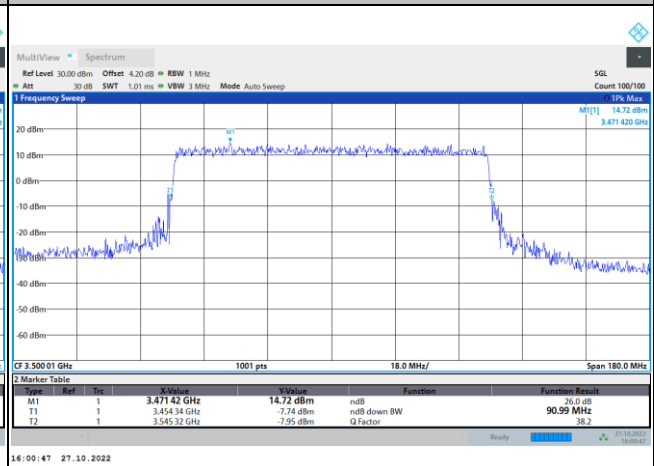

64QAM

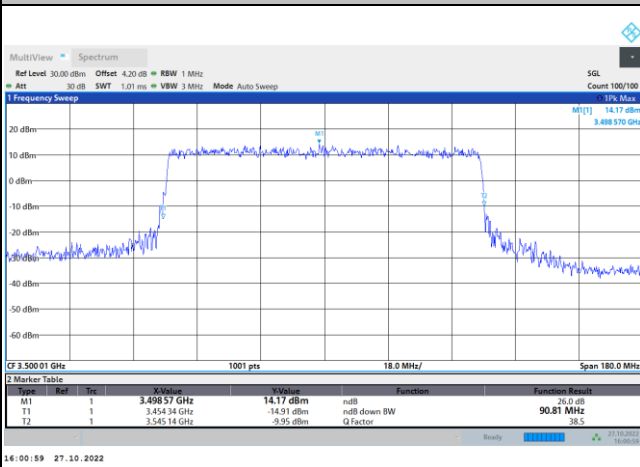

256QAM

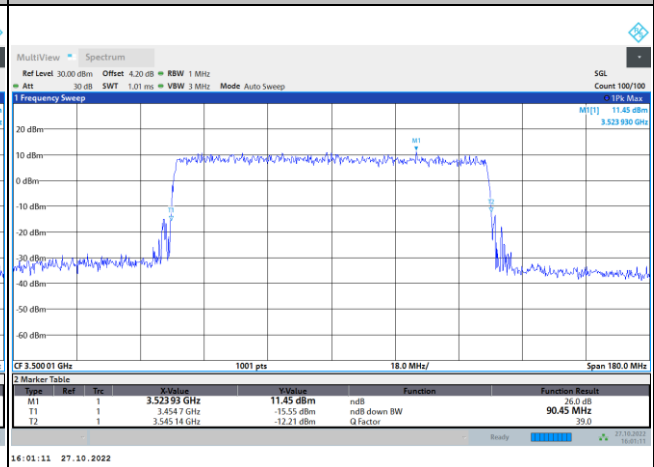



FR1 n77 / 100MHz / DFT-S OFDM / Middle Channel / Full RB

PI/2 BPSK

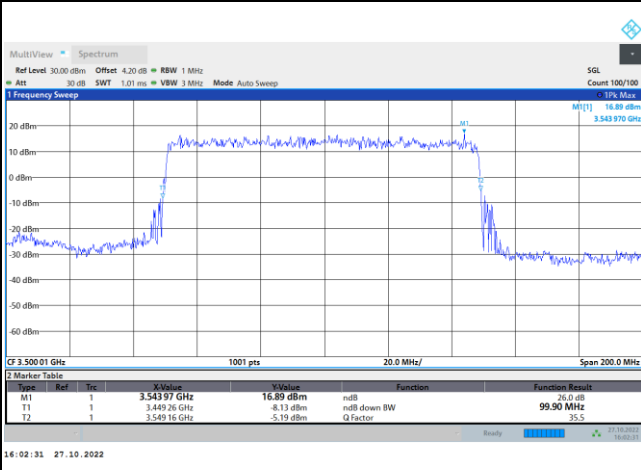

FR1 n77 / 100MHz / CP OFDM / Middle Channel / Full RB

QPSK

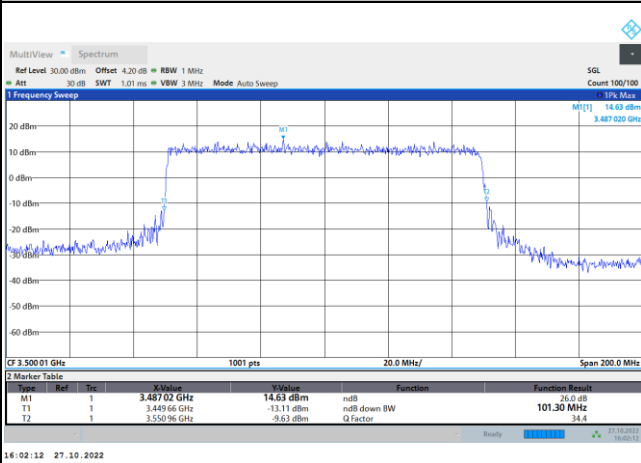

16QAM

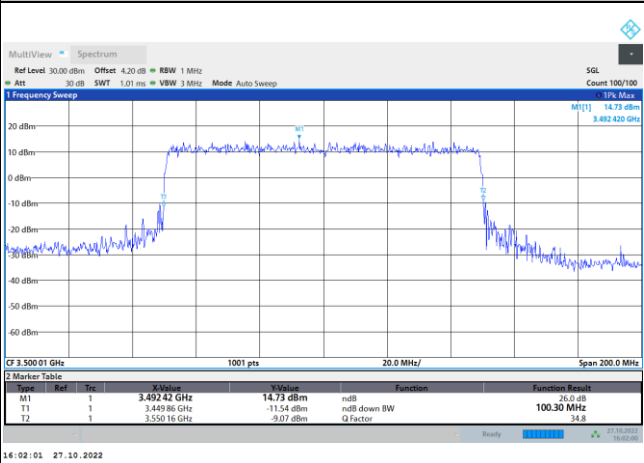

64QAM

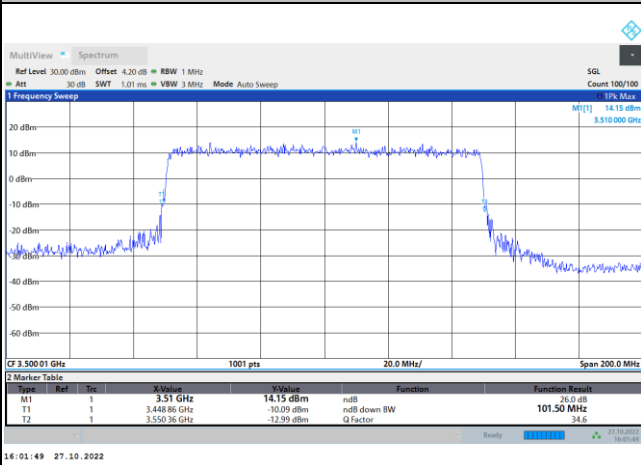

256QAM

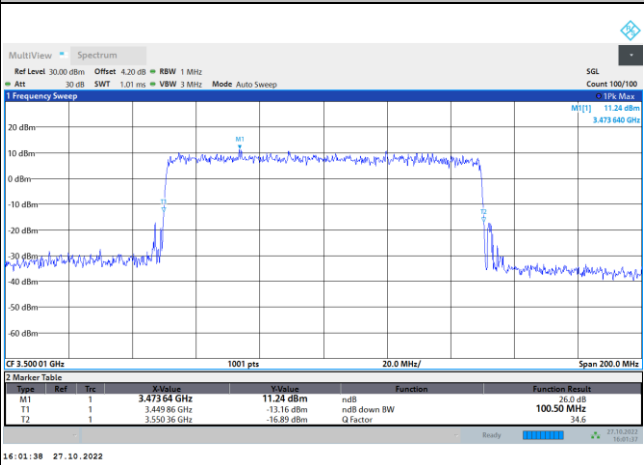



Occupied Bandwidth

Mode	FR1 n77 : OB BW(MHz) / DFT-S OFDM							
BW	10MHz	15MHz	20MHz	25MHz	30MHz	40MHz	50MHz	60MHz
Mod.	PI/2 BPSK	PI/2 BPSK	PI/2 BPSK	PI/2 BPSK	PI/2 BPSK	PI/2 BPSK	PI/2 BPSK	PI/2 BPSK
Middle CH	8.59	12.94	17.93	22.88	26.82	36.05	45.88	57.87
BW	70MHz	80MHz	90MHz	100MHz				
Mod.	PI/2 BPSK	PI/2 BPSK	PI/2 BPSK	PI/2 BPSK				
Middle CH	64.32	77.22	86.65	96.19				

Mode	FR1 n77 : OB BW(MHz) / CP OFDM							
BW	10MHz		15MHz		20MHz		25MHz	
Mod.	QPSK	16QAM	QPSK	16QAM	QPSK	16QAM	QPSK	16QAM
Middle CH	8.59	8.61	13.64	13.72	18.26	18.26	23.26	23.27
Mod.	64QAM	256QAM	64QAM	256QAM	64QAM	256QAM	64QAM	256QAM
Middle CH	8.61	8.60	13.66	13.62	18.21	18.28	23.27	23.23
BW	30MHz		40MHz		50MHz		60MHz	
Mod.	QPSK	16QAM	QPSK	16QAM	QPSK	16QAM	QPSK	16QAM
Middle CH	27.83	27.87	38.19	38.21	47.55	47.57	57.97	57.80
Mod.	64QAM	256QAM	64QAM	256QAM	64QAM	256QAM	64QAM	256QAM
Middle CH	27.73	27.88	38.04	38.26	47.54	47.52	58.05	57.85
BW	70MHz		80MHz		90MHz		100MHz	
Mod.	QPSK	16QAM	QPSK	16QAM	QPSK	16QAM	QPSK	16QAM
Middle CH	67.52	67.50	77.18	77.29	87.49	87.36	97.26	97.29
Mod.	64QAM	256QAM	64QAM	256QAM	64QAM	256QAM	64QAM	256QAM
Middle CH	67.46	67.47	77.50	77.41	87.35	87.49	97.41	97.29



FR1 n77 / 10MHz / DFT-S OFDM / Middle Channel / Full RB

PI/2 BPSK

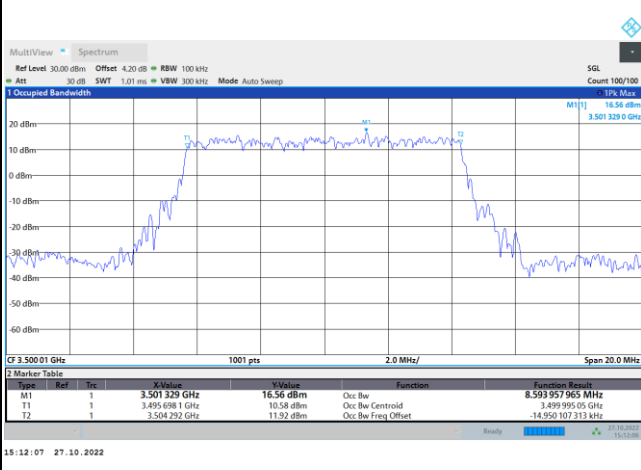

FR1 n77 / 10MHz / CP OFDM / Middle Channel / Full RB

QPSK

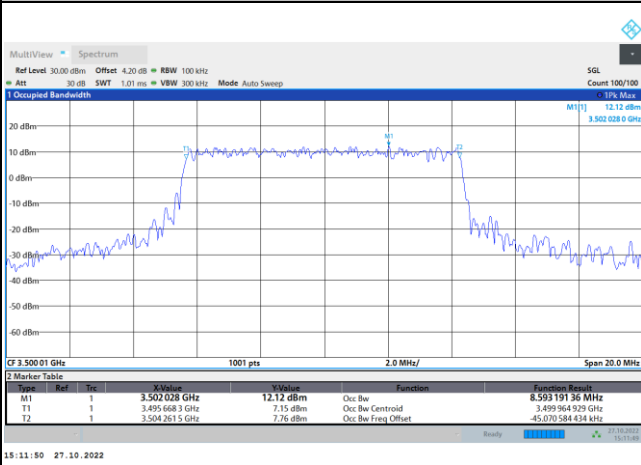

16QAM

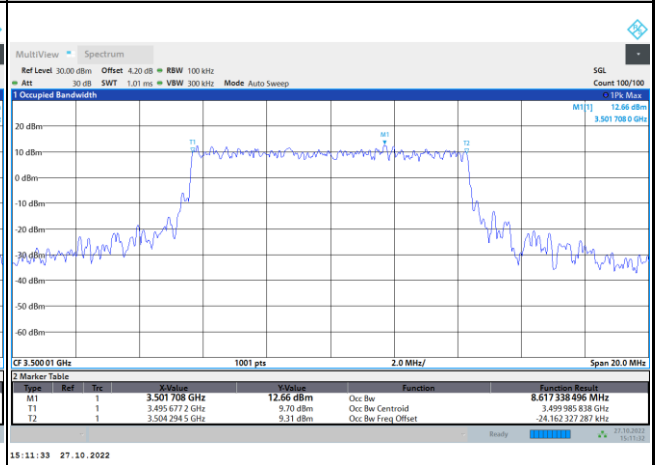

64QAM

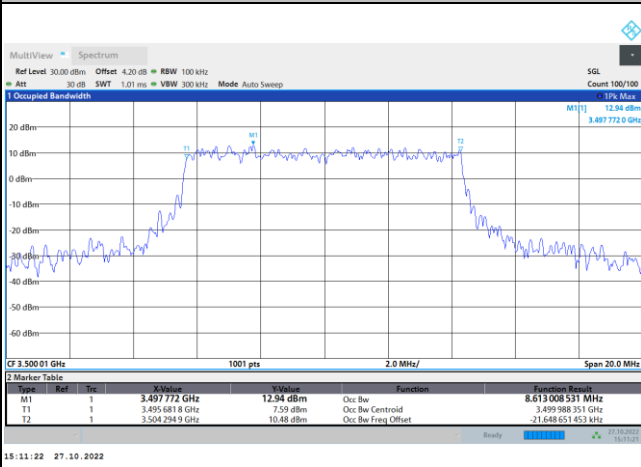

256QAM

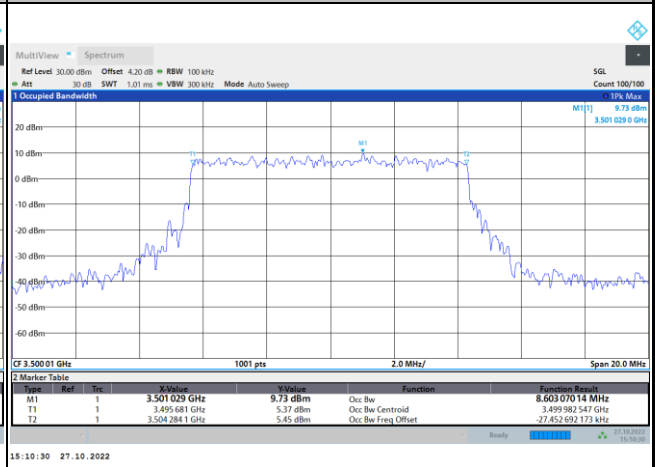



FR1 n77 / 15MHz / DFT-S OFDM / Middle Channel / Full RB

PI/2 BPSK

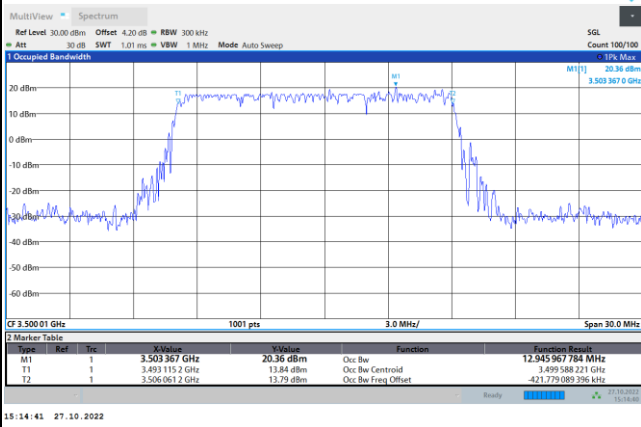

FR1 n77 / 15MHz / CP OFDM / Middle Channel / Full RB

QPSK

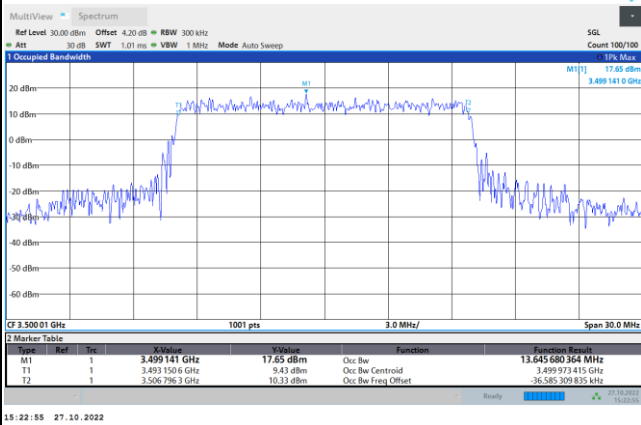

16QAM

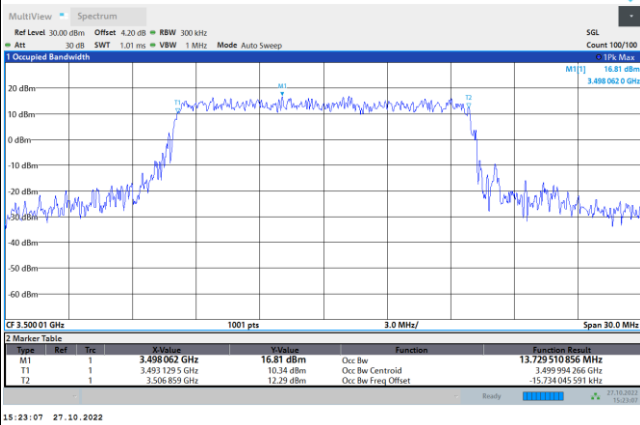

64QAM

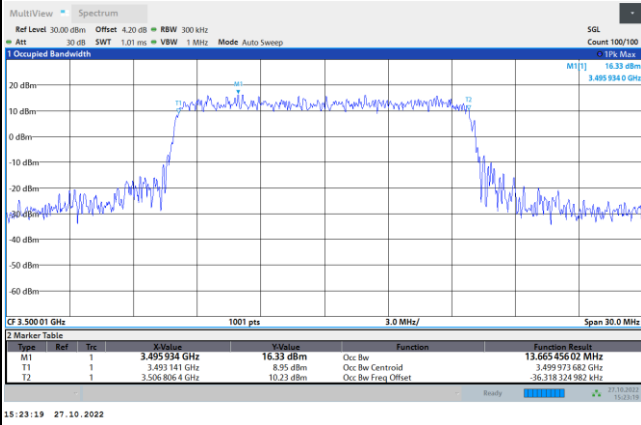

256QAM

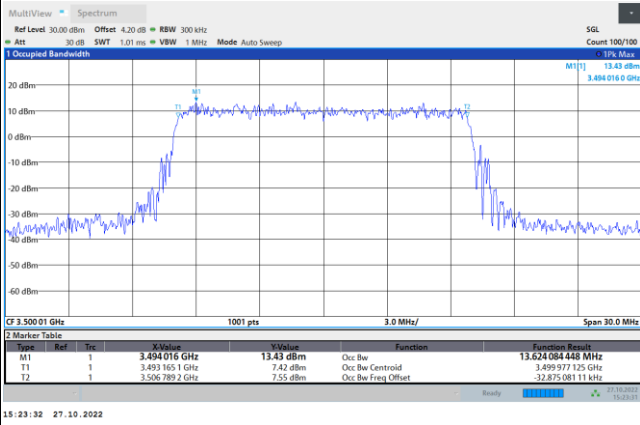



FR1 n77 / 20MHz / DFT-S OFDM / Middle Channel / Full RB

PI/2 BPSK

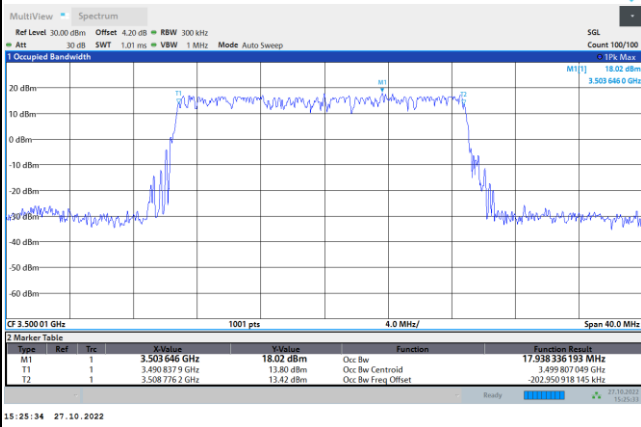

FR1 n77 / 20MHz / CP OFDM / Middle Channel / Full RB

QPSK

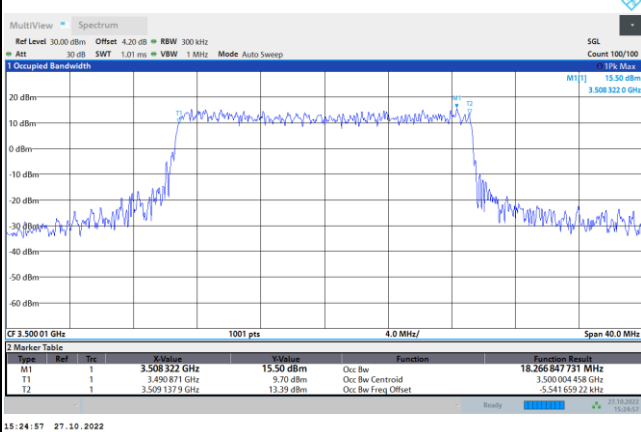

16QAM

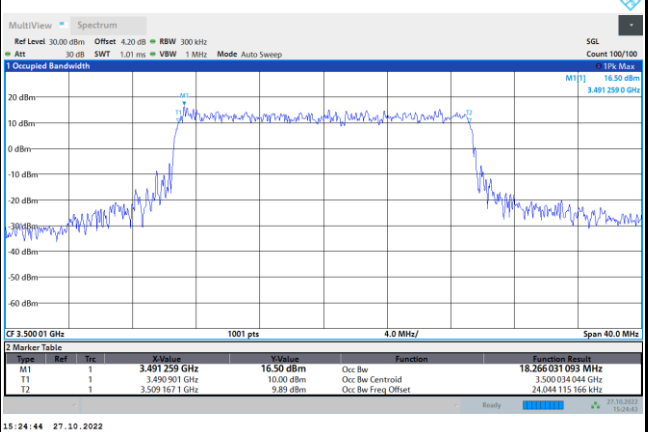

64QAM

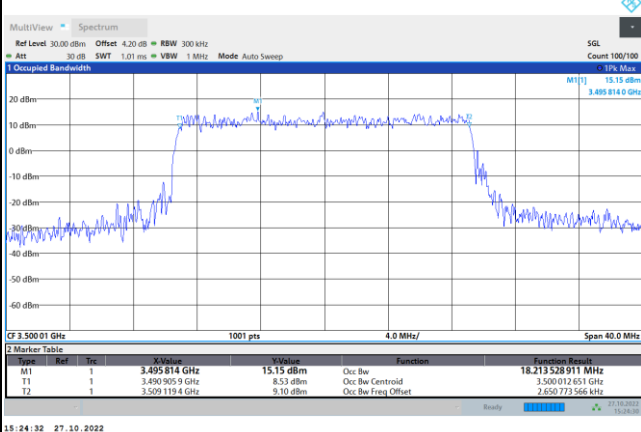

256QAM

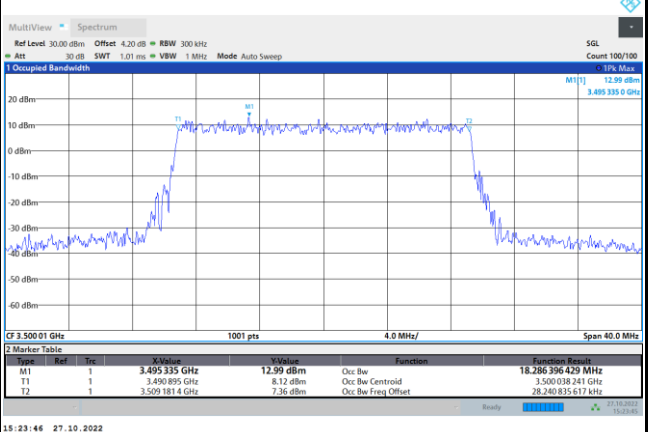



FR1 n77 / 25MHz / DFT-S OFDM / Middle Channel / Full RB

PI/2 BPSK

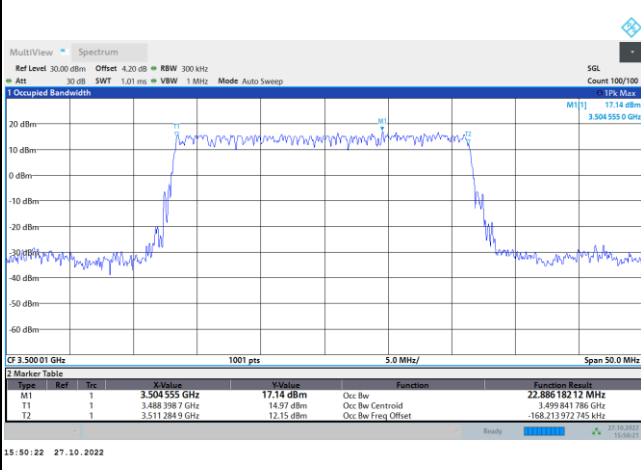

FR1 n77 / 25MHz / CP OFDM / Middle Channel / Full RB

QPSK

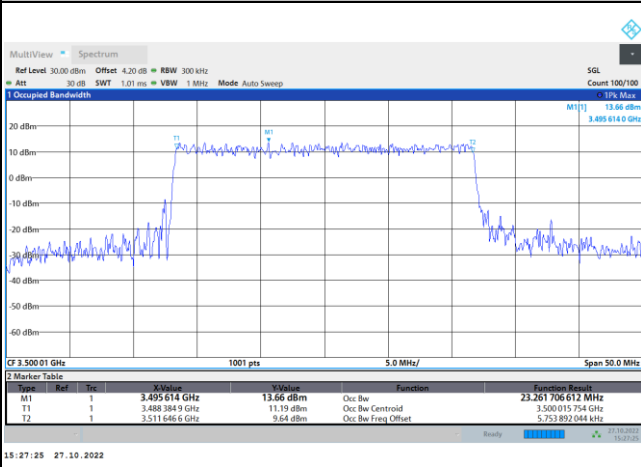

16QAM

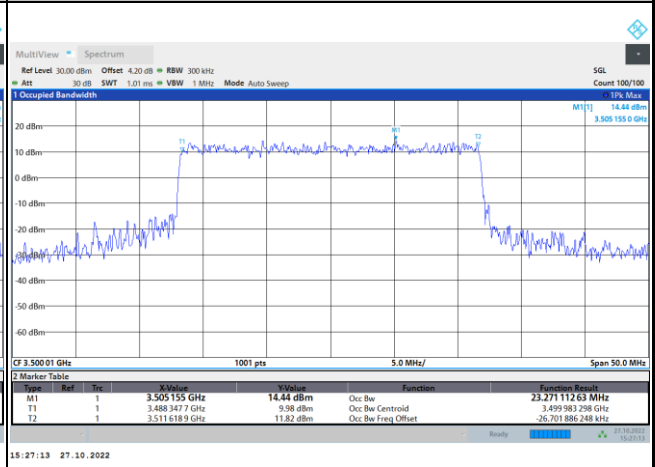

64QAM

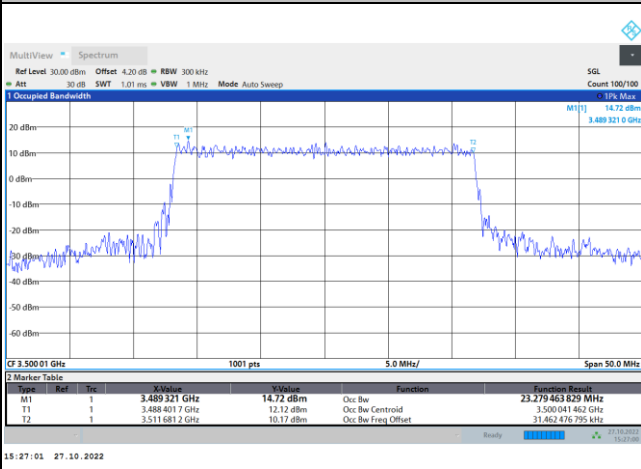

256QAM

