



# FCC RADIO TEST REPORT

**FCC ID** : A4RGHL1X  
**Equipment** : Phone  
**Applicant** : Google LLC  
1600 Amphitheatre Parkway,  
Mountain View, California, 94043 USA  
**Standard** : FCC 47 CFR Part 2, 27

The product was received on Sep. 14, 2022 and testing was performed from Oct. 03, 2022 to Nov. 08, 2022. We, Sporton International Inc. EMC & Wireless Communications Laboratory, would like to declare that the tested sample has been evaluated in accordance with the test procedures given in ANSI / TIA-603-E and has been in compliance with the applicable technical standards.

The test results in this report apply exclusively to the tested model / sample. Without written approval of Sporton International Inc. EMC & Wireless Communications Laboratory, the test report shall not be reproduced except in full.

*Louis Wu*

Approved by: Louis Wu

**Sporton International Inc. EMC & Wireless Communications Laboratory**

No. 52, Huaya 1st Rd., Guishan Dist., Taoyuan City 333, Taiwan (R.O.C.)



# Table of Contents

**History of this test report..... 3**

**Summary of Test Result..... 4**

**1 General Description ..... 5**

    1.1 Product Feature of Equipment Under Test..... 5

    1.2 Product Specification of Equipment Under Test..... 6

    1.3 Modification of EUT ..... 6

    1.4 Testing Location ..... 7

    1.5 Applicable Standards..... 7

**2 Test Configuration of Equipment Under Test ..... 8**

    2.1 Test Mode..... 8

    2.2 Connection Diagram of Test System..... 9

    2.3 Support Unit used in test configuration and system ..... 10

    2.4 Measurement Results Explanation Example..... 10

    2.5 Frequency List of Low/Middle/High Channels ..... 11

**3 Conducted Test Items ..... 12**

    3.1 Measuring Instruments ..... 12

    3.2 Conducted Output Power and EIRP..... 13

    3.3 Peak-to-Average Ratio ..... 14

    3.4 Occupied Bandwidth..... 15

    3.5 Conducted Band Edge ..... 16

    3.6 Conducted Spurious Emission ..... 17

    3.7 Frequency Stability ..... 18

**4 Radiated Test Items ..... 19**

    4.1 Measuring Instruments ..... 19

    4.2 Radiated Spurious Emission Measurement ..... 21

**5 List of Measuring Equipment..... 22**

**6 Uncertainty of Evaluation ..... 24**

**Appendix A. Test Results of Conducted Test**

**Appendix B. Test Results of Radiated Test**

**Appendix C. Test Setup Photographs**





### Summary of Test Result

Report Clause	Ref Std. Clause	Test Items	Result (PASS/FAIL)	Remark
3.2	§2.1046	Conducted Output Power	Reporting only	-
	§27.50 (j)(3)	Equivalent Isotropic Radiated Power (n77)	Pass	
3.3	§27.50 (j)(4)	Peak-to-Average Ratio	Pass	-
3.4	§2.1049	Occupied Bandwidth	Reporting only	-
3.5	§2.1051 §27.53 (l)(2)	Conducted Band Edge Measurement (n77)	Pass	-
3.6	§2.1051 §27.53 (l)(2)	Conducted Spurious Emission (n77)	Pass	-
3.7	§2.1055 §27.54	Frequency Stability Temperature & Voltage	Pass	-
4.2	§2.1051 §27.53 (l)(2)	Radiated Spurious Emission (n77)	Pass	Under limit 15.18 dB at 14809.000 MHz for Primary Antenna Under limit 15.57 dB at 14805.000 MHz for ASDIV Antenna

**Declaration of Conformity:**

- The test results (PASS/FAIL) with all measurement uncertainty excluded are presented in accordance with the regulation limits or requirements declared by manufacturers. It's means measurement values may risk exceeding the limit of regulation standards, if measurement uncertainty is include in test results.
- The measurement uncertainty please refer to this report "Uncertainty of Evaluation".

**Comments and Explanations:**

The product specifications of the EUT presented in the report are declared by the manufacturer who shall take full responsibility for the authenticity.

**Reviewed by: William Chen**

**Report Producer: Lucy Wu**



# 1 General Description

## 1.1 Product Feature of Equipment Under Test

Product Feature	
Equipment	Phone
FCC ID	A4RGHL1X
EUT supports Radios application	GSM/EGPRS/WCDMA/HSPA/LTE/5G NR/ NFC/GNSS/WPT Client WLAN 11b/g/n HT20 WLAN 11a/n HT20/HT40 WLAN 11ac VHT20/VHT40/VHT80 WLAN 11ax HE20/HE40/HE80 Bluetooth BR/EDR/LE

**Remark:** The above EUT's information was declared by manufacturer.

EUT Information List	
S/N	Performed Test Item
28251FQHN00142	Conducted Measurement EIRP
28261FQHN00058	Radiated Spurious Emission



## 1.2 Product Specification of Equipment Under Test

Product Specification is subject to this standard	
<b>Tx Frequency</b>	5G NR n77: 3705 MHz ~ 3975 MHz
<b>Rx Frequency</b>	5G NR n77: 3705 MHz ~ 3975 MHz
<b>Bandwidth</b>	5G NR n77: 10MHz / 15MHz / 20MHz / 25MHz / 30MHz / 40MHz / 50MHz / 60MHz / 70MHz / 80MHz / 90MHz / 100MHz
<b>Maximum Output Power to Antenna</b>	<b>&lt;Primary Antenna&gt;</b> 24.78 dBm 26.57 dBm for HPUE <b>&lt;ASDIV Antenna&gt;</b> 24.69 dBm 26.20 dBm for HPUE
<b>Antenna Type</b>	<b>&lt;Primary Antenna&gt;</b> : <b>&lt;Ant. 6&gt;</b> : IFA Antenna <b>&lt;ASDIV Antenna&gt;</b> : <b>&lt;Ant. 2&gt;</b> : IFA Antenna <b>&lt;SRS diversity Antenna&gt;</b> : <b>&lt;Ant. 1&gt;</b> : ILA Antenna <b>&lt;Ant. 5&gt;</b> : IFA Antenna
<b>Type of Modulation</b>	PI/2 BPSK / QPSK / 16QAM / 64QAM / 256QAM

### <Primary Antenna>

Radio Tech	Band Number	Antenna name	Gain
5G NR	n77	ANT6	-1.2

### <ASDIV Antenna>

Radio Tech	Band Number	Antenna name	Gain
5G NR	n77	ANT2	-1.8

### <SRS diversity Antenna >

Radio Tech	Band Number	Antenna name	Gain
5G NR	n77	ANT1	-2.8
5G NR	n77	ANT5	-3.4

**Remark:** The above EUT's information was declared by manufacturer. Please refer to Comments and Explanations in report summary.

## 1.3 Modification of EUT

No modifications are made to the EUT during all test items.



### 1.4 Testing Location

<b>Test Site</b>	Sporton International Inc. EMC & Wireless Communications Laboratory
<b>Test Site Location</b>	No.52, Huaya 1st Rd., Guishan Dist., Taoyuan City 333, Taiwan (R.O.C.) TEL: +886-3-327-3456 FAX: +886-3-328-4978
<b>Test Site No.</b>	<b>Sporton Site No.</b>
	TH03-HY
<b>Test Engineer</b>	Sherry Wu
<b>Temperature (°C)</b>	23.5~25
<b>Relative Humidity (%)</b>	48~52

<b>Test Site</b>	Sporton International Inc. Wensan Laboratory.
<b>Test Site Location</b>	No.58, Aly. 75, Ln. 564, Wenhua 3rd, Rd., Guishan Dist., Taoyuan City 333010, Taiwan (R.O.C.) TEL: +886-3-327-0868 FAX: +886-3-327-0855
<b>Test Site No.</b>	<b>Sporton Site No.</b>
	03CH12-HY (TAF Code: 3786)
<b>Test Engineer</b>	Jack Cheng, Tim Lee, Wilson Wu and Jesse Fan
<b>Temperature (°C)</b>	20~25
<b>Relative Humidity (%)</b>	50~60
<b>Remark</b>	The Radiated Spurious Emission test item subcontracted to Sporton International Inc. Wensan Laboratory.

**Note:** The test site complies with ANSI C63.4 2014 requirement.

FCC Designation No.: TW1190 and TW3786

### 1.5 Applicable Standards

According to the specifications of the manufacturer, the EUT must comply with the requirements of the following standards:

- ♦ ANSI C63.26-2015
- ♦ ANSI / TIA-603-E
- ♦ FCC 47 CFR Part 2, 27
- ♦ FCC KDB 971168 D01 Power Meas. License Digital Systems v03r01
- ♦ FCC KDB 412172 D01 Determining ERP and EIRP v01r01
- ♦ FCC KDB 414788 D01 Radiated Test Site v01r01

**Remark:**

1. All test items were verified and recorded according to the standards and without any deviation during the test.
2. This EUT has also been tested and complied with the requirements of FCC Part 15, Subpart B, recorded in a separate test report.
3. The TAF code is not including all the FCC KDB listed without accreditation.



## 2 Test Configuration of Equipment Under Test

### 2.1 Test Mode

Antenna port conducted and radiated test items listed below are performed according to KDB 971168 D01 Power Meas. License Digital Systems v03r01 with maximum output power.

For radiated measurement, the measured emission level of the EUT was maximized by rotating the EUT on a turntable, adjusting the orientation of the EUT and EUT antenna in three orthogonal axis (X: flat, Y: portrait, Z: landscape) and Accessory (Adapter or Earphone), and adjusting the measurement antenna orientation, following C63.26 exploratory test procedures and only the worst case emissions were reported in this report.

Test Items	NR Band	Bandwidth (MHz)												Modulation					RB #			Test Channel				
		10	15	20	25	30	40	50	60	70	80	90	100	PI/2 BPSK	QPSK	16QAM	64QAM	256QAM	1	Half	Full	L	M	H		
Max. Output Power	n77	v	v	v	v	v	v	v	v	v	v	v	v	v	v	v	v	v	v	v	v	v	v	v	v	v
Peak-to-Average Ratio	n77			v										v	v	v	v	v			v				v	
26dB and 99% Bandwidth	n77	v	v	v	v	v	v	v	v	v	v	v	v	v	v	v	v	v			v				v	
Conducted Band Edge	n77	v	v	v	v	v	v	v	v	v	v	v	v	v	v	v	v	v	v		v	v				v
Conducted Spurious Emission	n77	v																		v				v	v	v
Frequency Stability	n77			v										v										v		v
E.I.R.P	n77	v	v	v	v	v	v	v	v	v	v	v	v	v	v	v	v	v	Max. Power							
Radiated Spurious Emission	n77	Worst Case																				v	v	v		
Remark	<ol style="list-style-type: none"> <li>The mark "v" means that this configuration is chosen for testing</li> <li>The mark "-" means that this bandwidth is not supported.</li> <li>The device is investigated from 30MHz to 10 times of fundamental signal for radiated spurious emission test under different RB size/offset and modulations in exploratory test. Subsequently, only the worst case emissions are reported.</li> <li>For radiated measurement, pre-scanned in two modes, DFT-s OFDM and CP OFDM. The worst cases (DFT-s OFDM) were recorded in this report, and the worst modes of FR1 and LTE for simultaneous transmission were verified and compliant..</li> <li>Test combination is EN-DC 66A-n77A</li> <li>All the radiated test cases were performed with Adapter 1 and USB Cable 2.</li> <li>During the preliminary test, both charging modes (Adapter mode and WPT Client mode) were verified. It is determined that the adaptor mode is the worst case for official test.</li> <li>One representative bandwidth is selected to perform PAR and frequency stability.</li> </ol>																									



## 2.2 Connection Diagram of Test System

<EUT with Adapter>

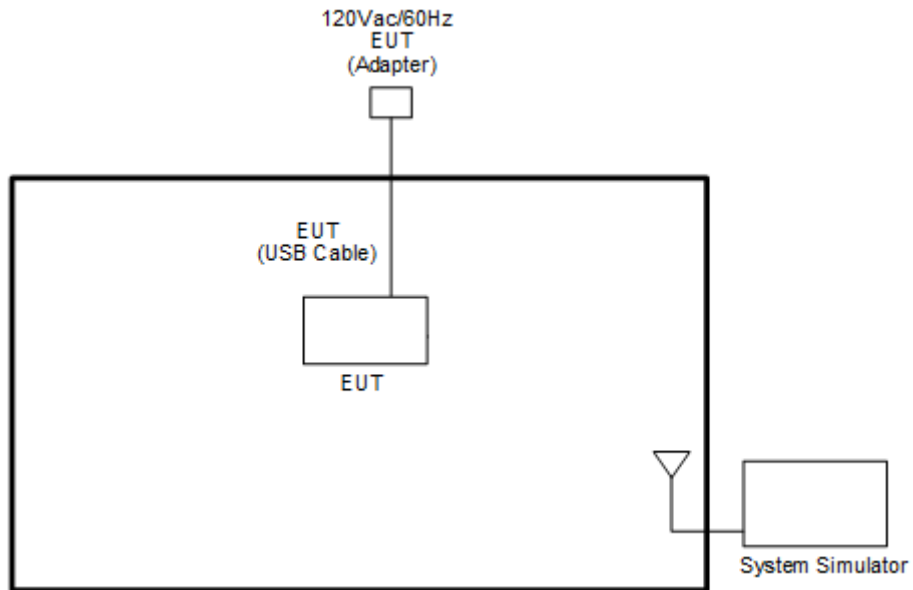

<EUT with Earphone>

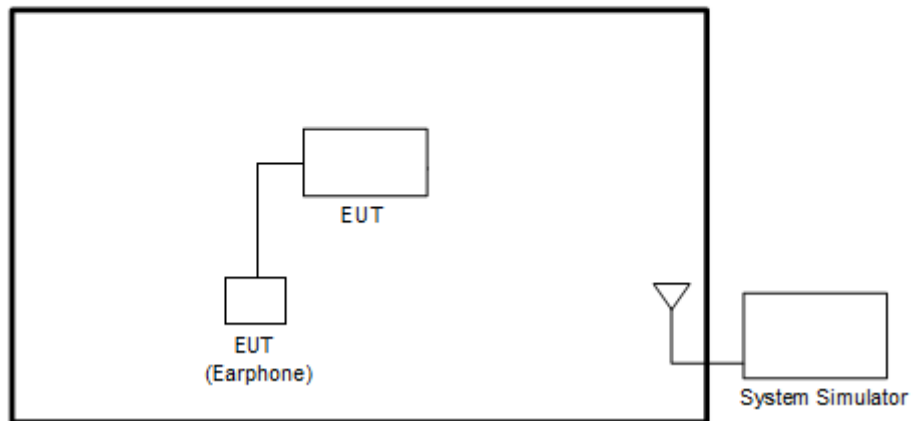

<EUT without Accessory>

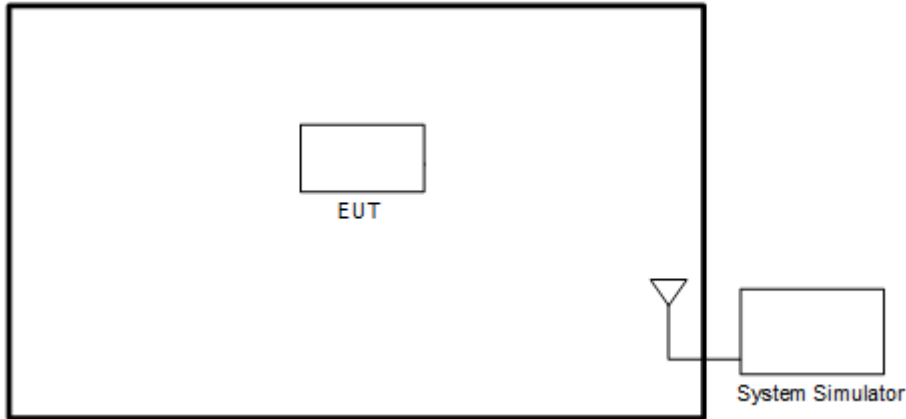

### 2.3 Support Unit used in test configuration and system

Item	Equipment	Brand Name	Model No.	FCC ID	Data Cable	Power Cord
1.	System Simulator	Anritsu	MT8821C	N/A	N/A	Unshielded, 1.8 m
2.	5G Wireless Test Platform	Anritsu	MT8000A	N/A	N/A	Unshielded, 1.8 m

### 2.4 Measurement Results Explanation Example

**For all conducted test items:**

The offset level is set in the spectrum analyzer to compensate the RF cable loss and attenuator factor between EUT conducted output port and spectrum analyzer. With the offset compensation, the spectrum analyzer reading level is exactly the EUT RF output level.

The spectrum analyzer offset is derived from RF cable loss and attenuator factor.

*Offset = RF cable loss + attenuator factor.*

Following shows an offset computation example with cable loss 4.2 dB and 10dB attenuator.

Example :

$$\begin{aligned}
 \text{Offset(dB)} &= \text{RF cable loss(dB)} + \text{attenuator factor(dB)}. \\
 &= 4.2 + 10 = 14.2 \text{ (dB)}
 \end{aligned}$$



### 2.5 Frequency List of Low/Middle/High Channels

5G NR n77 Channel and Frequency List				
BW [MHz]	Channel/Frequency(MHz)	Lowest	Middle	Highest
100	Channel	650000	656000	662000
	Frequency	3750	3840	3930
90	Channel	649668	656000	662332
	Frequency	3745.02	3840	3934.98
80	Channel	649334	656000	662666
	Frequency	3740.01	3840	3939.99
70	Channel	649000	656000	663000
	Frequency	3735	3840	3945
60	Channel	648668	656000	663332
	Frequency	3730.02	3840	3949.98
50	Channel	648334	656000	663666
	Frequency	3725.01	3840	3954.99
40	Channel	648000	656000	664000
	Frequency	3720	3840	3960
30	Channel	647668	656000	664332
	Frequency	3715.02	3840	3965
25	Channel	647500	656000	664500
	Frequency	3712.5	3840	3967.5
20	Channel	647334	656000	664666
	Frequency	3710.01	3840	3969.99
15	Channel	647168	656000	664832
	Frequency	3707.52	3840	3972.48
10	Channel	647000	656000	665000
	Frequency	3705	3840	3975

### 3 Conducted Test Items

#### 3.1 Measuring Instruments

See list of measuring instruments of this test report.

##### 3.1.1 Test Setup

##### 3.1.2 Conducted Output Power

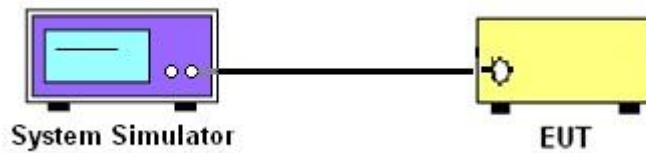

##### 3.1.3 Peak-to-Average Ratio, Occupied Bandwidth ,Conducted Band-Edge and Conducted Spurious Emission

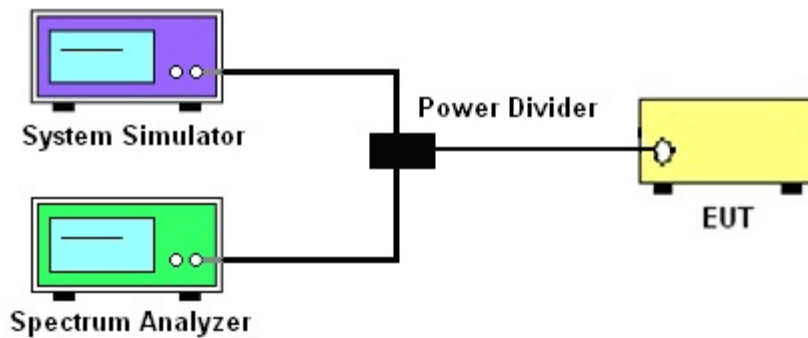

##### 3.1.4 Frequency Stability

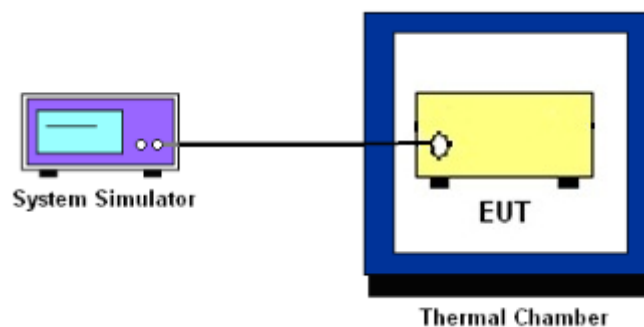

##### 3.1.5 Test Result of Conducted Test

Please refer to Appendix A.



## 3.2 Conducted Output Power and EIRP

### 3.2.1 Description of the Conducted Output Power Measurement and EIRP Measurement

A system simulator was used to establish communication with the EUT. Its parameters were set to force the EUT transmitting at maximum output power. The measured power in the radio frequency on the transmitter output terminals shall be reported.

The EIRP of mobile transmitters must not exceed 1 Watts for 5G NR n77

According to KDB 412172 D01 Power Approach,

$EIRP = P_T + G_T - L_C$ , where

$P_T$  = transmitter output power in dBm

$G_T$  = gain of the transmitting antenna in dBi

$L_C$  = signal attenuation in the connecting cable between the transmitter and antenna in dB

### 3.2.2 Test Procedures

1. The transmitter output port was connected to the system simulator.
2. Set EUT at maximum power through the system simulator.
3. Select lowest, middle, and highest channels for each band and different modulation.
4. Measure and record the power level from the system simulator.



## **3.3 Peak-to-Average Ratio**

### **3.3.1 Description of the PAR Measurement**

Power Complementary Cumulative Distribution Function (CCDF) curves provide a means for characterizing the power peaks of a digitally modulated signal on a statistical basis. A CCDF curve depicts the probability of the peak signal amplitude exceeding the average power level. Most contemporary measurement instrumentation include the capability to produce CCDF curves for an input signal provided that the instrument's resolution bandwidth can be set wide enough to accommodate the entire input signal bandwidth. In measuring transmissions in this band using an average power technique, the peak-to-average ratio (PAR) of the transmission may not exceed 13 dB.

### **3.3.2 Test Procedures**

The testing follows ANSI C63.26-2015 Section 5.2.6

1. The EUT was connected to spectrum and system simulator via a power divider.
2. Set the CCDF (Complementary Cumulative Distribution Function) option in spectrum analyzer.
3. The highest RF powers were measured and recorded the maximum PAPR level associated with a probability of 0.1 %.
4. Record the deviation as Peak to Average Ratio.



## **3.4 Occupied Bandwidth**

### **3.4.1 Description of Occupied Bandwidth Measurement**

The occupied bandwidth is the width of a frequency band such that, below the lower and above the upper frequency limits, the mean powers emitted are each equal to a specified percentage 0.5% of the total mean transmitted power.

The 26 dB emission bandwidth is defined as the frequency range between two points, one above and one below the carrier frequency, at which the spectral density of the emission is attenuated 26 dB below the maximum in-band spectral density of the modulated signal. Spectral density (power per unit bandwidth) is to be measured with a detector of resolution bandwidth equal to approximately 1.0% of the emission bandwidth.

### **3.4.2 Test Procedures**

The testing follows ANSI C63.26-2015 Section 5.4.3 (26dB) and Section 5.4.4 (99OB)

1. The EUT was connected to spectrum analyzer and system simulator via a power divider.
2. The spectrum analyzer center frequency is set to the nominal EUT channel center frequency. The span range for the spectrum analyzer shall be between two and five times the anticipated OBW.
3. The nominal resolution bandwidth (RBW) shall be in the range of 1 to 5 % of the anticipated OBW, and the VBW shall be at least 3 times the RBW.
4. Set the detection mode to peak, and the trace mode to max hold.
5. Determine the reference value: Set the EUT to transmit a modulated signal. Allow the trace to stabilize. Set the spectrum analyzer marker to the highest level of the displayed trace.  
(this is the reference value)
6. Determine the “-26 dB down amplitude” as equal to (Reference Value – X).
7. Place two markers, one at the lowest and the other at the highest frequency of the envelope of the spectral display such that each marker is at or slightly below the “-X dB down amplitude” determined in step 6. If a marker is below this “-X dB down amplitude” value it shall be placed as close as possible to this value. The OBW is the positive frequency difference between the two markers.
8. Use the 99 % power bandwidth function of the spectrum analyzer and report the measured bandwidth.



## **3.5 Conducted Band Edge**

### **3.5.1 Description of Conducted Band Edge Measurement**

27.53 (l)(2)

For mobile operations in the 3700-3980 MHz band, the conducted power of any emission outside the licensee's authorized bandwidth shall not exceed  $-13$  dBm/MHz. Compliance with this paragraph (l)(2) is based on the use of measurement instrumentation employing a resolution bandwidth of 1 megahertz or greater. However, in the 1 megahertz bands immediately outside and adjacent to the licensee's frequency block, the minimum resolution bandwidth for the measurement shall be either one percent of the emission bandwidth of the fundamental emission of the transmitter or 350 kHz. In the bands between 1 and 5 MHz removed from the licensee's frequency block, the minimum resolution bandwidth for the measurement shall be 500 kHz. The emission bandwidth is defined as the width of the signal between two points, one below the carrier center frequency and one above the carrier center frequency, outside of which all emissions are attenuated at least 26 dB below the transmitter power.

### **3.5.2 Test Procedures**

The testing follows FCC KDB 971168 D01 v03r01 Section 6.1.

1. The EUT was connected to spectrum analyzer and system simulator via a power divider.
2. The band edges of low and high channels for the highest RF powers were measured.
3. Set RBW  $\geq 1\%$  EBW in the 1MHz band immediately outside and adjacent to the band edge.
4. Beyond the 1 MHz band from the band edge, RBW=1MHz was used.
5. Set spectrum analyzer with RMS detector.
6. The RF fundamental frequency should be excluded against the limit line in the operating frequency band.
7. Checked that all the results comply with the emission limit line.

The limit line is derived from  $43 + 10\log(P)$ dB below the transmitter power P(Watts)





## 3.6 Conducted Spurious Emission

### 3.6.1 Description of Conducted Spurious Emission Measurement

The power of any emission outside of the authorized operating frequency ranges must be lower than the transmitter power (P) by a factor of at least  $43 + 10 \log (P)$  dB.

### 3.6.2 Test Procedures

The testing follows FCC KDB 971168 D01 v03r01 Section 6.1.

1. The EUT was connected to spectrum analyzer and system simulator via a power divider.
2. The RF output of EUT was connected to the spectrum analyzer by RF cable and attenuator. The path loss was compensated to the results for each measurement.
3. The middle channel for the highest RF power within the transmitting frequency was measured.
4. The conducted spurious emission for the whole frequency range was taken.
5. Make the measurement with the spectrum analyzer's RBW = 1MHz, VBW = 3MHz.
6. Set spectrum analyzer with RMS detector.
7. Taking the record of maximum spurious emission.
8. The RF fundamental frequency should be excluded against the limit line in the operating frequency band.
9. The limit line is derived from  $43 + 10\log(P)$ dB below the transmitter power P(Watts)



### 3.7 Frequency Stability

#### 3.7.1 Description of Frequency Stability Measurement

27.54

The frequency stability shall be sufficient to ensure that the fundamental emission stays within the authorized frequency block.

#### 3.7.2 Test Procedures for Temperature Variation

The testing follows FCC KDB 971168 D01 v03r01 Section 9.0.

1. The EUT was set up in the thermal chamber and connected with the system simulator.
2. With power OFF, the temperature was decreased to  $-30^{\circ}\text{C}$  and the EUT was stabilized before testing. Power was applied and the maximum change in frequency was recorded within one minute.
3. With power OFF, the temperature was raised in  $10^{\circ}\text{C}$  step up to  $50^{\circ}\text{C}$ . The EUT was stabilized at each step for at least half an hour. Power was applied and the maximum frequency change was recorded within one minute.

#### 3.7.3 Test Procedures for Voltage Variation

The testing follows FCC KDB 971168 D01 v03r01 Section 9.0.

1. The EUT was placed in a temperature chamber at  $20\pm 5^{\circ}\text{C}$  and connected with the system simulator.
2. The power supply voltage to the EUT was varied from 85% to 115% of the nominal value measured at the input to the EUT.
3. The variation in frequency was measured for the worst case.

## 4 Radiated Test Items

### 4.1 Measuring Instruments

See list of measuring instruments of this test report.

#### 4.1.1 Test Setup

For radiated emissions below 30MHz

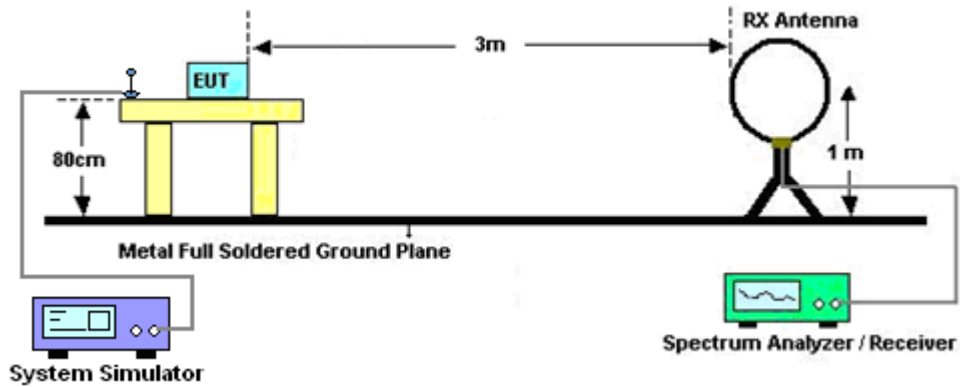

For radiated test from 30MHz to 1GHz

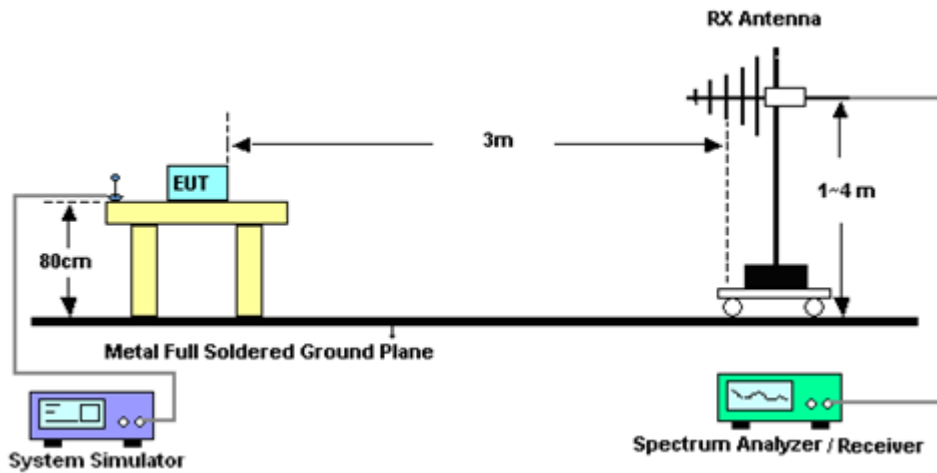

For radiated test from 1GHz to 18GHz

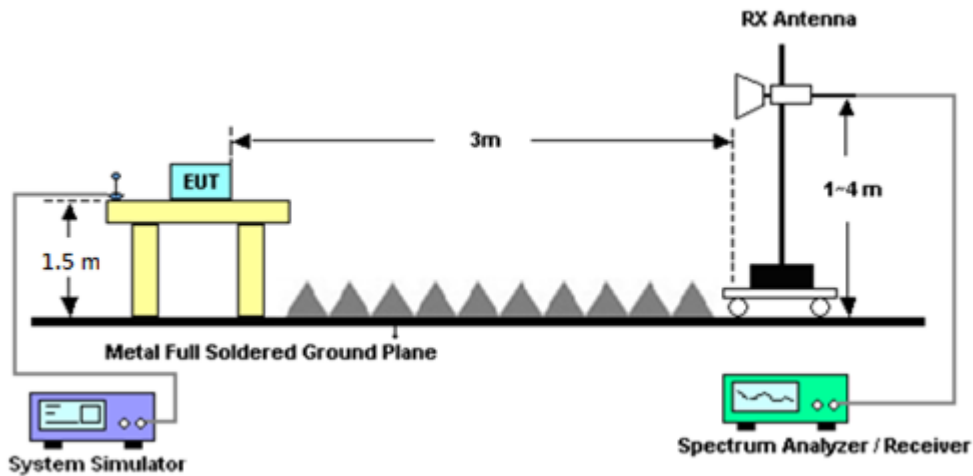

For radiated test above 18GHz

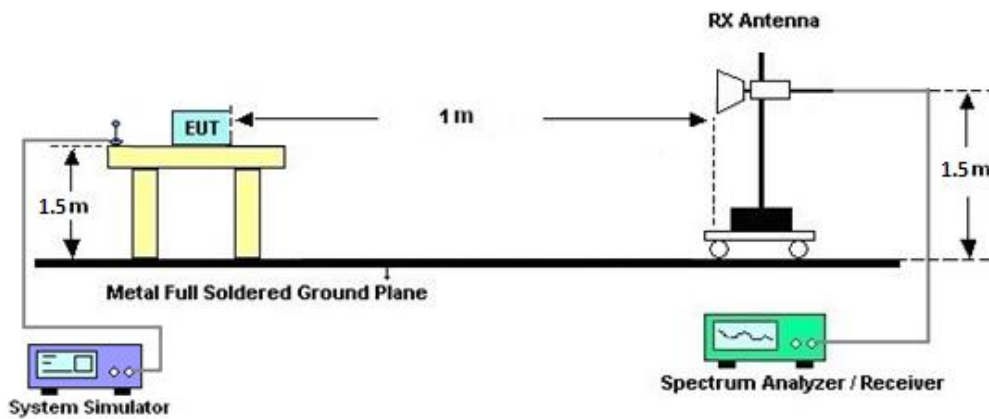

#### 4.1.2 Test Result of Radiated Test

Please refer to Appendix B.

**Note:**

The low frequency, which started from 9 kHz to 30MHz, was pre-scanned and the result which was 20dB lower than the limit line was not reported.

There is adequate comparison measurement of both open-field test site and alternative test site - semi-Anechoic chamber according to 414788 D01 Radiated Test Site v01r01, and the result came out very similar.



## 4.2 Radiated Spurious Emission Measurement

### 4.2.1 Description of Radiated Spurious Emission Measurement

The radiated spurious emission was measured by substitution method according to ANSI / TIA-603-E. The power of any emission outside of the authorized operating frequency ranges must be attenuated below the transmitter power (P) by a factor of at least  $43 + 10 \log (P)$  dB.

### 4.2.2 Test Procedures

The testing follows FCC KDB 971168 D01 v03r01 Section 7 and ANSI / TIA-603-E Section 2.2.12.

1. The EUT was placed on a turntable with 0.8 meter for frequency below 1GHz and 1.5 meter for frequency above 1GHz respectively above ground.
2. The EUT was set 3 meters from the receiving antenna, which was mounted on the antenna tower.
3. The table was rotated 360 degrees to determine the position of the highest spurious emission.
4. The height of the receiving antenna is varied between one meter and four meters to search the maximum spurious emission for both horizontal and vertical polarizations.
5. Make the measurement with the spectrum analyzer's RBW = 1MHz, VBW = 3MHz, taking the record of maximum spurious emission.
6. A horn antenna was substituted in place of the EUT and was driven by a signal generator.
7. Tune the output power of signal generator to the same emission level with EUT maximum spurious emission.
8. Taking the record of output power at antenna port.
9. Repeat step 7 to step 8 for another polarization.
10. The RF fundamental frequency should be excluded against the limit line in the operating frequency band.

The limit line is derived from  $43 + 10\log(P)$ dB below the transmitter power P(Watts)



## 5 List of Measuring Equipment

Instrument	Brand Name	Model No.	Serial No.	Characteristics	Calibration Date	Test Date	Due Date	Remark
Loop Antenna	Rohde & Schwarz	HFH2-Z2	100488	9 kHz~30 MHz	May 13, 2022	Oct. 24, 2022~ Oct. 25, 2022	May 12, 2023	Radiation (03CH12-HY)
Horn Antenna	SCHWARZBECK	BBHA 9120 D	9120D-1328	1GHz~18GHz	Dec. 03, 2021	Oct. 24, 2022~ Oct. 25, 2022	Dec. 02, 2022	Radiation (03CH12-HY)
Bilog Antenna	TESEQ	CBL 6111D & 00800N1D01N-06	40103 & 07	30MHz~1GHz	Apr. 24, 2022	Oct. 24, 2022~ Oct. 25, 2022	Apr. 23, 2023	Radiation (03CH12-HY)
Bilog Antenna	TESEQ	CBL 6111D & N-6-06	35414 & AT-N0602	30MHz~1GHz	Oct. 08, 2022	Oct. 24, 2022~ Oct. 25, 2022	Oct. 07, 2023	Radiation (03CH12-HY)
Horn Antenna	SCHWARZBECK	BBHA 9120 D	9120D-1212	1GHz~18GHz	Mar. 10, 2022	Oct. 24, 2022~ Oct. 25, 2022	Mar. 09, 2023	Radiation (03CH12-HY)
SHF-EHF Horn Antenna	SCHWARZBECK	BBHA 9170	BBHA91702 51	18GHz~40GHz	Nov. 30, 2021	Oct. 24, 2022~ Oct. 25, 2022	Nov. 29, 2022	Radiation (03CH12-HY)
SHF-EHF Horn Antenna	SCHWARZBECK	BBHA 9170	BBHA91705 76	18GHz~40GHz	May 14, 2022	Oct. 24, 2022~ Oct. 25, 2022	May 13, 2023	Radiation (03CH12-HY)
Preamplifier	COM-POWER	PA-103	161075	10MHz~1GHz	Mar. 23, 2022	Oct. 24, 2022~ Oct. 25, 2022	Mar. 22, 2023	Radiation (03CH12-HY)
Preamplifier	Aglient	8449B	3008A02375	1GHz~26.5GHz	May 24, 2022	Oct. 24, 2022~ Oct. 25, 2022	May 23, 2023	Radiation (03CH12-HY)
Preamplifier	E-INSTRUMENT TECH LTD.	ERA-100M-18 G-56-01-A70	EC1900249	1GHz-18GHz	Dec. 22, 2021	Oct. 24, 2022~ Oct. 25, 2022	Dec. 21, 2022	Radiation (03CH12-HY)
Preamplifier	E-INSTRUMENT TECH LTD.	ERA-100M-18 G-56-01-A70	EC1900269	1GHz-18GHz	Dec. 27, 2021	Oct. 24, 2022~ Oct. 25, 2022	Dec. 26, 2022	Radiation (03CH12-HY)
Preamplifier	EMEC	EM18G40G	060715	18GHz~40GHz	Dec. 24, 2021	Oct. 24, 2022~ Oct. 25, 2022	Dec. 23, 2022	Radiation (03CH12-HY)
Spectrum Analyzer	Keysight	N9010A	MY53470118	10Hz~44GHz	Jan. 12, 2022	Oct. 24, 2022~ Oct. 25, 2022	Jan. 11, 2023	Radiation (03CH12-HY)
RF Cable	HUBER + SUHNER	SUCOFLEX 104	MY9837/4PE	9kHz~30MHz	Mar. 10, 2022	Oct. 24, 2022~ Oct. 25, 2022	Mar. 09, 2023	Radiation (03CH12-HY)
RF Cable	HUBER + SUHNER	SUCOFLEX 126E	0058/126E	30MHz~18GHz	Dec. 10, 2021	Oct. 24, 2022~ Oct. 25, 2022	Dec. 09, 2022	Radiation (03CH12-HY)
RF Cable	HUBER + SUHNER	SUCOFLEX 102	505134/2	30MHz~40GHz	Feb. 21, 2022	Oct. 24, 2022~ Oct. 25, 2022	Feb. 20, 2023	Radiation (03CH12-HY)
RF Cable	HUBER + SUHNER	SUCOFLEX 102	803953/2	30MHz~40GHz	Mar. 08, 2022	Oct. 24, 2022~ Oct. 25, 2022	Mar. 07, 2023	Radiation (03CH12-HY)
Filter	Wainwright	WHKX8-5872. 5-6750-18000-40ST	SN2	6.75GHz High Pass Filter	Mar. 15, 2022	Oct. 24, 2022~ Oct. 25, 2022	Mar. 14, 2023	Radiation (03CH12-HY)
Filter	Wainwright	WHKX12-1080 -1200-15000-60SS	SN1	1.2GHz High Pass Filter	Mar. 15, 2022	Oct. 24, 2022~ Oct. 25, 2022	Mar. 14, 2023	Radiation (03CH12-HY)
Hygrometer	TECEPEL	DTM-303B	TP140325	N/A	Nov. 26, 2021	Oct. 24, 2022~ Oct. 25, 2022	Nov. 25, 2022	Radiation (03CH12-HY)
Controller	EMEC	EM1000	N/A	Control Turn table & Ant Mast	N/A	Oct. 24, 2022~ Oct. 25, 2022	N/A	Radiation (03CH12-HY)
Antenna Mast	EMEC	AM-BS-4500-B	N/A	1m~4m	N/A	Oct. 24, 2022~ Oct. 25, 2022	N/A	Radiation (03CH12-HY)
Turn Table	EMEC	TT2000	N/A	0~360 Degree	N/A	Oct. 24, 2022~ Oct. 25, 2022	N/A	Radiation (03CH12-HY)
Software	Audix	E3 6.2009-8-24	RK-000989	N/A	N/A	Oct. 24, 2022~ Oct. 25, 2022	N/A	Radiation (03CH12-HY)



Instrument	Brand Name	Model No.	Serial No.	Characteristics	Calibration Date	Test Date	Due Date	Remark
Programmable Power Supply	GW Instek	PSS-2005	EL890001	0V~64V ;0A~6A	Sep. 29, 2022	Oct. 03, 2022~ Nov. 08, 2022	Sep. 28, 2023	Conducted (TH03-HY)
Signal Analyzer	Rohde & Schwarz	FSV3044	101048	10Hz~44GHz	May 05, 2022	Oct. 03, 2022~ Nov. 08, 2022	May 04, 2023	Conducted (TH03-HY)
Temperature Chamber	ESPEC	SH-641	92013720	-40℃ ~90℃	Sep. 07, 2022	Oct. 03, 2022~ Nov. 08, 2022	Sep. 06, 2023	Conducted (TH03-HY)
Base Station (Measure)	Anritsu	MT8821C	6262116730	LTE	Jun. 15, 2022	Oct. 03, 2022~ Nov. 08, 2022	Jun. 14, 2023	Conducted (TH03-HY)
Base Station (Measure)	Anritsu	MT8000A	6262134933	FR1	Jun. 13, 2022	Oct. 03, 2022~ Nov. 08, 2022	Jun. 22, 2023	Conducted (TH03-HY)



## 6 Uncertainty of Evaluation

### Uncertainty of Radiated Emission Measurement (30 MHz ~ 1000 MHz)

Measuring Uncertainty for a Level of Confidence of 95% ( $U = 2Uc(y)$ )	3.31 dB
---	---------

### Uncertainty of Radiated Emission Measurement (1 GHz ~ 18 GHz)

Measuring Uncertainty for a Level of Confidence of 95% ( $U = 2Uc(y)$ )	3.25 dB
---	---------

### Uncertainty of Radiated Emission Measurement (18 GHz ~ 40 GHz)

Measuring Uncertainty for a Level of Confidence of 95% ( $U = 2Uc(y)$ )	3.81 dB
---	---------





## Appendix A. Test Results of Conducted Test

### Conducted Output Power(Average power and EIRP)

#### <Primary Antenna>

NR n77 Maximum Average Power [dBm] (GT - LC = -1.2 dB)								
BW [MHz]	RB Size	RB Offset	Mod	Lowest	Middle	Highest	EIRP (dBm)	EIRP(W)
10	1	1	PI/2 BPSK	24.35	24.12	24.13	23.30	0.2138
10	1	22		24.48	24.01	24.04		
10	12	6		24.50	24.15	24.16		
10	1	0		23.86	23.67	23.67		
10	1	23		23.98	23.57	23.57		
10	24	0		23.97	23.65	23.66		
10	1	1	QPSK	24.37	24.19	24.16		
10	1	22		24.50	24.09	24.06		
10	12	6		24.47	24.20	24.19		
10	1	0		23.35	23.28	23.21		
10	1	23		23.48	23.18	23.10		
10	24	0		23.50	23.18	23.16		
10	1	1	16-QAM	23.31	23.46	23.04	22.26	0.1683
10	1	1	64-QAM	21.74	21.79	21.85		
10	1	1	256-QAM	19.75	19.79	19.65		
Limit	EIRP < 1W			Result			Pass	

NR n77 Maximum Average Power [dBm] (GT - LC = -1.2 dB)								
BW [MHz]	RB Size	RB Offset	Mod	Lowest	Middle	Highest	EIRP (dBm)	EIRP(W)
15	1	1	PI/2 BPSK	24.45	24.26	24.42	23.36	0.2168
15	1	36		24.52	24.12	24.47		
15	18	9		24.56	24.19	24.50		
15	1	0		23.92	23.79	23.82		
15	1	37		23.82	23.57	23.95		
15	36	0		24.02	23.66	24.00		
15	1	1	QPSK	24.40	24.25	24.41		
15	1	36		24.54	24.10	24.42		
15	18	9		24.56	24.18	24.50		
15	1	0		23.41	23.24	23.31		
15	1	37		23.32	23.09	23.43		
15	36	0		23.56	23.18	23.47		
15	1	1	16-QAM	23.57	23.37	23.52	22.37	0.1726
15	1	1	64-QAM	21.85	21.87	21.86		
15	1	1	256-QAM	20.01	19.76	20.01		
Limit	EIRP < 1W			Result			Pass	



NR n77 Maximum Average Power [dBm] (GT - LC = -1.2 dB)										
BW [MHz]	RB Size	RB Offset	Mod	Lowest	Middle	Highest	EIRP (dBm)	EIRP(W)		
20	1	1	PI/2 BPSK	24.44	24.33	24.23	23.41	0.2193		
20	1	49		24.34	24.05	24.45				
20	25	12		24.61	24.15	24.45				
20	1	0		23.93	23.80	23.73				
20	1	50		23.86	23.34	23.89				
20	50	0		24.14	23.65	24.00				
20	1	1	QPSK	24.44	24.25	24.26			23.41	0.2193
20	1	49		24.30	24.03	24.38				
20	25	12		24.61	24.15	24.42				
20	1	0		23.43	23.26	23.23				
20	1	50		23.36	22.81	23.38				
20	50	0		23.61	23.16	23.45				
20	1	1	16-QAM	23.45	23.25	23.21	22.25	0.1679		
20	1	1	64-QAM	21.88	21.68	21.67				
20	1	1	256-QAM	19.97	19.72	19.75				
Limit	EIRP < 1W			Result			Pass			

NR n77 Maximum Average Power [dBm] (GT - LC = -1.2 dB)										
BW [MHz]	RB Size	RB Offset	Mod	Lowest	Middle	Highest	EIRP (dBm)	EIRP(W)		
25	1	1	PI/2 BPSK	24.53	24.33	24.38	23.55	0.2265		
25	1	63		24.75	23.79	24.32				
25	32	16		24.66	24.16	24.39				
25	1	0		24.05	23.71	23.93				
25	1	64		24.25	23.35	23.85				
25	64	0		24.15	23.67	23.88				
25	1	1	QPSK	24.51	24.22	24.44			23.55	0.2265
25	1	63		24.72	23.82	24.29				
25	32	16		24.71	24.15	24.38				
25	1	0		23.53	23.25	23.45				
25	1	64		23.73	22.83	23.30				
25	64	0		23.67	23.18	23.37				
25	1	1	16-QAM	23.41	23.24	23.55	22.35	0.1718		
25	1	1	64-QAM	21.93	21.67	22.08				
25	1	1	256-QAM	19.86	19.75	19.83				
Limit	EIRP < 1W			Result			Pass			



NR n77 Maximum Average Power [dBm] (GT - LC = -1.2 dB)								
BW [MHz]	RB Size	RB Offset	Mod	Lowest	Middle	Highest	EIRP (dBm)	EIRP(W)
30	1	1	PI/2 BPSK	24.47	24.30	24.54	23.40	0.2188
30	1	76		24.60	23.84	24.45		
30	36	18		24.56	24.20	24.31		
30	1	0		23.96	23.88	24.05		
30	1	77		24.08	23.35	23.95		
30	75	0		23.86	23.69	23.82		
30	1	1	QPSK	24.43	24.29	24.56		
30	1	76		24.56	23.85	24.42		
30	36	18		24.55	24.11	24.33		
30	1	0		23.43	23.30	23.55		
30	1	77		23.57	22.83	23.45		
30	75	0		23.33	23.22	23.36		
30	1	1	16-QAM	23.37	23.32	23.55	22.35	0.1718
30	1	1	64-QAM	21.95	21.74	22.25		
30	1	1	256-QAM	20.03	20.31	20.07		
Limit	EIRP < 1W			Result			Pass	

NR n77 Maximum Average Power [dBm] (GT - LC = -1.2 dB)								
BW [MHz]	RB Size	RB Offset	Mod	Lowest	Middle	Highest	EIRP (dBm)	EIRP(W)
40	1	1	PI/2 BPSK	24.55	24.44	24.43	23.35	0.2163
40	1	104		24.51	24.30	24.26		
40	50	25		24.47	24.12	24.11		
40	1	0		24.01	23.93	23.91		
40	1	105		23.93	23.76	23.75		
40	100	0		23.95	23.67	23.68		
40	1	1	QPSK	24.49	24.43	24.46		
40	1	104		24.47	24.23	24.23		
40	50	25		24.51	24.12	24.13		
40	1	0		23.51	23.42	23.43		
40	1	105		23.45	23.25	23.27		
40	100	0		23.45	23.20	23.17		
40	1	1	16-QAM	23.57	23.35	23.58	22.38	0.1730
40	1	1	64-QAM	21.97	21.99	22.10		
40	1	1	256-QAM	19.89	19.97	20.12		
Limit	EIRP < 1W			Result			Pass	



NR n77 Maximum Average Power [dBm] (GT - LC = -1.2 dB)								
BW [MHz]	RB Size	RB Offset	Mod	Lowest	Middle	Highest	EIRP (dBm)	EIRP(W)
50	1	1	PI/2 BPSK	24.58	24.45	24.58	23.55	0.2265
50	1	131		24.45	23.88	24.29		
50	64	32		24.75	24.15	24.48		
50	1	0		24.08	23.97	24.07		
50	1	132		23.88	23.44	23.83		
50	128	0		24.23	23.75	24.05		
50	1	1	QPSK	24.55	24.50	24.60		
50	1	131		24.35	23.97	24.33		
50	64	32		24.68	24.20	24.47		
50	1	0		23.54	23.51	23.67		
50	1	132		23.35	22.97	23.31		
50	128	0		23.72	23.22	23.55		
50	1	1	16-QAM	23.47	23.51	23.75	22.55	0.1799
50	1	1	64-QAM	22.20	21.93	22.15		
50	1	1	256-QAM	20.01	19.79	20.15		
Limit	EIRP < 1W			Result			Pass	

NR n77 Maximum Average Power [dBm] (GT - LC = -1.2 dB)								
BW [MHz]	RB Size	RB Offset	Mod	Lowest	Middle	Highest	EIRP (dBm)	EIRP(W)
60	1	1	PI/2 BPSK	24.04	23.89	23.85	23.58	0.2280
60	1	160		24.43	23.80	24.32		
60	81	40		24.75	24.13	24.51		
60	1	0		23.53	23.40	23.37		
60	1	161		24.01	23.31	23.78		
60	162	0		24.26	23.68	24.08		
60	1	1	QPSK	24.01	23.93	23.86		
60	1	160		24.42	23.80	24.27		
60	81	40		24.78	24.18	24.52		
60	1	0		23.03	22.90	22.90		
60	1	161		23.55	22.79	23.30		
60	162	0		23.74	23.22	23.59		
60	1	1	16-QAM	23.10	22.92	22.94	21.90	0.1549
60	1	1	64-QAM	21.35	21.43	21.52		
60	1	1	256-QAM	19.49	19.34	19.50		
Limit	EIRP < 1W			Result			Pass	



NR n77 Maximum Average Power [dBm] (GT - LC = -1.2 dB)								
BW [MHz]	RB Size	RB Offset	Mod	Lowest	Middle	Highest	EIRP (dBm)	EIRP(W)
70	1	1	PI/2 BPSK	24.12	24.01	23.66	23.45	0.2213
70	1	187		24.40	23.94	24.14		
70	90	45		24.65	24.21	24.38		
70	1	0		23.66	23.50	23.24		
70	1	188		23.89	23.38	23.70		
70	180	0		24.11	23.75	23.87		
70	1	1	QPSK	24.08	23.96	23.73		
70	1	187		24.35	23.85	24.17		
70	90	45		24.63	24.23	24.38		
70	1	0		23.10	22.97	22.74		
70	1	188		23.37	22.89	23.18		
70	180	0		23.64	23.23	23.36		
70	1	1	16-QAM	22.99	23.04	22.73	21.84	0.1528
70	1	1	64-QAM	21.66	21.38	21.32		
70	1	1	256-QAM	19.61	19.59	19.37		
Limit	EIRP < 1W			Result			Pass	

NR n77 Maximum Average Power [dBm] (GT - LC = -1.2 dB)								
BW [MHz]	RB Size	RB Offset	Mod	Lowest	Middle	Highest	EIRP (dBm)	EIRP(W)
80	1	1	PI/2 BPSK	24.15	24.07	23.72	23.45	0.2213
80	1	215		24.35	23.91	24.28		
80	108	54		24.60	24.21	24.40		
80	1	0		23.67	23.62	23.23		
80	1	216		23.74	23.40	23.75		
80	216	0		24.13	23.71	23.90		
80	1	1	QPSK	24.12	24.03	23.71		
80	1	215		24.27	23.81	24.23		
80	108	54		24.65	24.21	24.43		
80	1	0		23.11	23.06	22.72		
80	1	216		23.28	22.97	23.31		
80	216	0		23.66	23.25	23.37		
80	1	1	16-QAM	23.31	23.14	22.73	22.11	0.1626
80	1	1	64-QAM	21.65	21.56	21.45		
80	1	1	256-QAM	19.48	19.54	19.10		
Limit	EIRP < 1W			Result			Pass	



NR n77 Maximum Average Power [dBm] (GT - LC = -1.2 dB)								
BW [MHz]	RB Size	RB Offset	Mod	Lowest	Middle	Highest	EIRP (dBm)	EIRP(W)
90	1	1	PI/2 BPSK	24.20	24.14	23.63	23.42	0.2198
90	1	243		24.14	23.86	24.23		
90	120	60		24.59	24.20	24.45		
90	1	0		23.73	23.70	23.14		
90	1	244		23.70	23.36	23.81		
90	243	0		24.17	23.75	23.85		
90	1	1	QPSK	24.30	24.17	23.61		
90	1	243		24.25	23.83	24.25		
90	120	60		24.62	24.20	24.41		
90	1	0		23.27	23.16	22.59		
90	1	244		23.22	22.85	23.23		
90	243	0		23.68	23.22	23.37		
90	1	1	16-QAM	23.44	23.20	22.51	22.24	0.1675
90	1	1	64-QAM	21.75	21.60	21.04		
90	1	1	256-QAM	19.68	19.66	19.17		
Limit	EIRP < 1W			Result			Pass	

NR n77 Maximum Average Power [dBm] (GT - LC = -1.2 dB)								
BW [MHz]	RB Size	RB Offset	Mod	Lowest	Middle	Highest	EIRP (dBm)	EIRP(W)
100	1	1	PI/2 BPSK	24.28	24.26	23.83	23.53	0.2254
100	1	271		24.26	23.80	24.25		
100	135	67		24.73	24.21	24.25		
100	1	0		23.80	23.75	23.34		
100	1	272		23.74	23.33	23.80		
100	270	0		24.21	23.76	23.75		
100	1	1	QPSK	24.30	24.20	23.82		
100	1	271		24.26	23.79	24.25		
100	135	67		24.64	24.21	24.26		
100	1	0		23.24	23.19	22.83		
100	1	272		23.18	22.77	23.22		
100	270	0		23.71	23.21	23.27		
100	1	1	16-QAM	23.25	23.23	22.85	22.05	0.1603
100	1	1	64-QAM	21.90	21.73	21.50		
100	1	1	256-QAM	19.74	19.61	19.40		
Limit	EIRP < 1W			Result			Pass	



NR n77 HPUE Maximum Average Power [dBm] (GT - LC = -1.2 dB)								
BW [MHz]	RB Size	RB Offset	Mod	Lowest	Middle	Highest	EIRP (dBm)	EIRP(W)
10	1	1	PI/2 BPSK	25.91	26.29	26.15	25.09	0.3228
10	1	22		26.09	26.21	25.98		
10	12	6		26.03	26.26	26.11		
10	1	0		22.43	22.82	22.63		
10	1	23		22.53	22.77	22.51		
10	24	0		25.54	25.75	25.58		
10	1	1	QPSK	25.94	26.28	26.10		
10	1	22		26.06	26.26	26.05		
10	12	6		26.07	26.27	26.09		
10	1	0		22.44	22.79	22.64		
10	1	23		22.57	22.74	22.49		
10	24	0		24.04	25.25	25.05		
10	1	1	16-QAM	25.02	25.33	25.23	24.13	0.2588
10	1	1	64-QAM	23.30	23.79	23.66		
10	1	1	256-QAM	21.38	21.79	21.65		
Limit	EIRP < 1W			Result			Pass	

NR n77 HPUE Maximum Average Power [dBm] (GT - LC = -1.2 dB)								
BW [MHz]	RB Size	RB Offset	Mod	Lowest	Middle	Highest	EIRP (dBm)	EIRP(W)
15	1	1	PI/2 BPSK	26.18	26.02	26.39	25.19	0.3304
15	1	36		26.23	25.83	26.28		
15	18	9		26.27	25.93	26.32		
15	1	0		22.74	22.51	22.65		
15	1	37		22.58	22.41	22.77		
15	36	0		25.77	25.42	25.86		
15	1	1	QPSK	26.19	26.05	26.34		
15	1	36		26.21	25.89	26.28		
15	18	9		26.25	25.90	26.30		
15	1	0		22.77	22.58	22.67		
15	1	37		22.48	22.37	22.75		
15	36	0		25.29	24.98	25.35		
15	1	1	16-QAM	25.17	25.20	25.42	24.22	0.2642
15	1	1	64-QAM	23.79	23.60	23.77		
15	1	1	256-QAM	21.73	21.63	21.82		
Limit	EIRP < 1W			Result			Pass	



NR n77 HPUE Maximum Average Power [dBm] (GT - LC = -1.2 dB)								
BW [MHz]	RB Size	RB Offset	Mod	Lowest	Middle	Highest	EIRP (dBm)	EIRP(W)
20	1	1	PI/2 BPSK	26.21	26.11	26.12	25.15	0.3273
20	1	49		26.11	25.89	26.24		
20	25	12		26.35	26.01	26.30		
20	1	0		22.73	22.62	22.61		
20	1	50		22.64	22.19	22.72		
20	50	0		25.82	25.50	25.80		
20	1	1	QPSK	26.25	26.11	26.11		
20	1	49		26.11	25.94	26.22		
20	25	12		26.34	25.98	26.31		
20	1	0		22.71	22.52	22.60		
20	1	50		22.64	22.21	22.69		
20	50	0		25.30	25.01	25.26		
20	1	1	16-QAM	25.24	25.01	24.92	24.04	0.2535
20	1	1	64-QAM	23.82	23.62	23.49		
20	1	1	256-QAM	21.64	21.83	21.71		
Limit	EIRP < 1W			Result			Pass	

NR n77 HPUE Maximum Average Power [dBm] (GT - LC = -1.2 dB)								
BW [MHz]	RB Size	RB Offset	Mod	Lowest	Middle	Highest	EIRP (dBm)	EIRP(W)
25	1	1	PI/2 BPSK	26.26	26.10	26.29	25.27	0.3365
25	1	63		26.47	25.76	26.17		
25	32	16		26.37	25.57	26.27		
25	1	0		22.77	22.54	22.83		
25	1	64		22.98	22.26	22.69		
25	64	0		25.85	25.52	25.82		
25	1	1	QPSK	26.25	26.05	26.32		
25	1	63		26.45	25.69	26.10		
25	32	16		26.36	25.06	26.28		
25	1	0		22.72	22.57	22.78		
25	1	64		22.95	22.18	22.78		
25	64	0		25.36	25.00	25.29		
25	1	1	16-QAM	25.12	25.21	25.31	24.11	0.2576
25	1	1	64-QAM	23.73	23.66	23.94		
25	1	1	256-QAM	21.72	21.44	21.84		
Limit	EIRP < 1W			Result			Pass	





NR n77 HPUE Maximum Average Power [dBm] (GT - LC = -1.2 dB)										
BW [MHz]	RB Size	RB Offset	Mod	Lowest	Middle	Highest	EIRP (dBm)	EIRP(W)		
30	1	1	PI/2 BPSK	26.25	26.05	26.45	25.25	0.3350		
30	1	76		26.40	25.74	26.36				
30	36	18		26.31	26.01	26.23				
30	1	0		22.65	22.61	22.87				
30	1	77		22.86	22.25	22.80				
30	75	0		25.62	25.52	25.74				
30	1	1	QPSK	26.21	26.08	26.40			25.25	0.3350
30	1	76		26.38	25.71	26.35				
30	36	18		26.31	26.03	26.24				
30	1	0		22.73	22.58	2.92				
30	1	77		22.83	22.23	22.78				
30	75	0		25.12	25.02	25.26				
30	1	1	16-QAM	25.22	25.12	25.45	24.25	0.2661		
30	1	1	64-QAM	23.72	23.66	24.01				
30	1	1	256-QAM	21.65	21.54	21.97				
Limit	EIRP < 1W			Result			Pass			

NR n77 HPUE Maximum Average Power [dBm] (GT - LC = -1.2 dB)										
BW [MHz]	RB Size	RB Offset	Mod	Lowest	Middle	Highest	EIRP (dBm)	EIRP(W)		
40	1	1	PI/2 BPSK	26.24	26.23	26.33	25.18	0.3296		
40	1	104		26.17	25.79	26.23				
40	50	25		26.25	26.02	26.12				
40	1	0		22.75	22.74	22.82				
40	1	105		22.73	22.31	22.69				
40	100	0		25.69	25.50	25.68				
40	1	1	QPSK	26.27	26.21	26.38			25.18	0.3296
40	1	104		26.28	26.26	26.17				
40	50	25		26.19	26.04	26.11				
40	1	0		22.79	22.77	22.73				
40	1	105		22.72	22.32	22.65				
40	100	0		25.16	25.02	25.13				
40	1	1	16-QAM	25.35	25.34	25.47	24.27	0.2673		
40	1	1	64-QAM	23.83	23.60	23.91				
40	1	1	256-QAM	21.69	21.58	21.74				
Limit	EIRP < 1W			Result			Pass			



NR n77 HPUE Maximum Average Power [dBm] (GT - LC = -1.2 dB)								
BW [MHz]	RB Size	RB Offset	Mod	Lowest	Middle	Highest	EIRP (dBm)	EIRP(W)
50	1	1	PI/2 BPSK	26.30	26.28	26.44	25.33	0.3412
50	1	131		26.18	25.83	26.22		
50	64	32		26.52	26.10	26.41		
50	1	0		22.84	22.83	22.95		
50	1	132		22.74	22.27	22.76		
50	128	0		25.97	25.56	25.93		
50	1	1	QPSK	26.33	26.30	26.50		
50	1	131		26.19	25.85	26.28		
50	64	32		26.53	26.06	26.45		
50	1	0		22.84	22.83	22.96		
50	1	132		22.68	22.37	22.75		
50	128	0		25.51	25.03	25.48		
50	1	1	16-QAM	25.48	25.32	25.58	24.38	0.2742
50	1	1	64-QAM	23.79	23.93	24.04		
50	1	1	256-QAM	21.75	21.95	21.95		
Limit	EIRP < 1W			Result			Pass	

NR n77 HPUE Maximum Average Power [dBm] (GT - LC = -1.2 dB)								
BW [MHz]	RB Size	RB Offset	Mod	Lowest	Middle	Highest	EIRP (dBm)	EIRP(W)
60	1	1	PI/2 BPSK	25.79	25.70	25.69	25.37	0.3443
60	1	160		26.23	25.66	26.12		
60	81	40		26.57	26.05	26.41		
60	1	0		22.30	22.23	22.24		
60	1	161		22.79	22.15	22.65		
60	162	0		25.99	25.58	25.98		
60	1	1	QPSK	25.80	25.71	25.79		
60	1	160		22.83	25.63	26.19		
60	81	40		26.56	26.10	24.62		
60	1	0		22.29	22.22	22.28		
60	1	161		22.84	22.13	22.67		
60	162	0		25.56	25.07	25.46		
60	1	1	16-QAM	24.71	24.76	24.89	23.69	0.2339
60	1	1	64-QAM	23.31	23.13	23.16		
60	1	1	256-QAM	21.40	21.28	21.30		
Limit	EIRP < 1W			Result			Pass	



NR n77 HPUE Maximum Average Power [dBm] (GT - LC = -1.2 dB)								
BW [MHz]	RB Size	RB Offset	Mod	Lowest	Middle	Highest	EIRP (dBm)	EIRP(W)
70	1	1	PI/2 BPSK	25.84	25.82	25.69	25.23	0.3334
70	1	187		26.08	25.67	26.10		
70	90	45		26.43	26.03	26.22		
70	1	0		22.31	22.25	22.17		
70	1	188		22.65	22.20	22.59		
70	180	0		25.87	25.55	25.77		
70	1	1	QPSK	25.88	25.82	25.71		
70	1	187		26.10	25.75	26.12		
70	90	45		26.33	26.11	26.23		
70	1	0		22.33	22.31	22.19		
70	1	188		22.57	22.19	22.54		
70	180	0		25.36	25.09	25.24		
70	1	1	16-QAM	24.95	24.75	24.73	23.75	0.2371
70	1	1	64-QAM	23.22	23.27	23.19		
70	1	1	256-QAM	21.34	21.42	21.25		
Limit	EIRP < 1W			Result			Pass	

NR n77 HPUE Maximum Average Power [dBm] (GT - LC = -1.2 dB)								
BW [MHz]	RB Size	RB Offset	Mod	Lowest	Middle	Highest	EIRP (dBm)	EIRP(W)
80	1	1	PI/2 BPSK	25.90	25.88	25.69	25.24	0.3342
80	1	215		26.10	25.69	26.18		
80	108	54		26.44	26.07	26.28		
80	1	0		22.38	22.42	22.23		
80	1	216		22.51	22.21	22.68		
80	216	0		25.90	25.57	25.83		
80	1	1	QPSK	25.86	25.87	25.69		
80	1	215		26.09	25.74	26.16		
80	108	54		26.37	26.05	26.26		
80	1	0		22.41	22.40	22.22		
80	1	216		22.57	22.17	22.66		
80	216	0		25.42	25.06	25.32		
80	1	1	16-QAM	24.86	24.89	24.77	23.69	0.2339
80	1	1	64-QAM	23.39	23.42	23.15		
80	1	1	256-QAM	21.21	21.57	21.24		
Limit	EIRP < 1W			Result			Pass	



NR n77 HPUE Maximum Average Power [dBm] (GT - LC = -1.2 dB)								
BW [MHz]	RB Size	RB Offset	Mod	Lowest	Middle	Highest	EIRP (dBm)	EIRP(W)
90	1	1	PI/2 BPSK	26.05	26.01	25.66	25.24	0.3342
90	1	243		26.05	25.69	26.26		
90	120	60		26.44	26.12	26.35		
90	1	0		22.56	22.59	22.04		
90	1	244		22.62	22.20	22.77		
90	243	0		25.99	25.61	25.79		
90	1	1	QPSK	26.05	26.04	25.58		
90	1	243		26.06	25.72	26.19		
90	120	60		26.41	26.08	26.34		
90	1	0		22.53	22.52	22.07		
90	1	244		22.51	22.26	22.67		
90	243	0		25.52	25.14	25.33		
90	1	1	16-QAM	25.11	24.88	24.67	23.91	0.2460
90	1	1	64-QAM	23.44	23.68	23.20		
90	1	1	256-QAM	21.44	21.50	21.11		
Limit	EIRP < 1W			Result			Pass	

NR n77 HPUE Maximum Average Power [dBm] (GT - LC = -1.2 dB)								
BW [MHz]	RB Size	RB Offset	Mod	Lowest	Middle	Highest	EIRP (dBm)	EIRP(W)
100	1	1	PI/2 BPSK	26.07	26.02	25.74	25.34	0.3420
100	1	271		26.13	25.69	26.19		
100	135	67		26.49	26.10	26.22		
100	1	0		22.61	22.60	22.32		
100	1	272		22.58	22.17	22.77		
100	270	0		26.01	25.58	25.69		
100	1	1	QPSK	26.05	26.05	25.77		
100	1	271		26.13	25.66	26.25		
100	135	67		26.54	26.09	26.23		
100	1	0		22.58	22.55	22.30		
100	1	272		22.63	22.21	22.73		
100	270	0		25.47	25.03	25.20		
100	1	1	16-QAM	25.08	24.98	24.92	23.88	0.2443
100	1	1	64-QAM	23.54	23.55	23.25		
100	1	1	256-QAM	21.67	21.74	21.15		
Limit	EIRP < 1W			Result			Pass	



<ASDIV Antenna>

NR n77 Maximum Average Power [dBm] (GT - LC = -1.8 dB)								
BW [MHz]	RB Size	RB Offset	Mod	Lowest	Middle	Highest	EIRP (dBm)	EIRP(W)
10	1	1	PI/2 BPSK	24.32	23.96	23.96	22.66	0.1845
10	1	22		24.41	23.81	23.91		
10	12	6		24.46	24.12	24.05		
10	1	0		23.81	23.58	23.63		
10	1	23		23.91	23.53	23.46		
10	24	0		23.95	23.63	23.63		
10	1	1	QPSK	24.34	24.06	24.02		
10	1	22		24.33	24.04	23.97		
10	12	6		24.33	24.19	24.01		
10	1	0		23.31	23.19	23.01		
10	1	23		23.44	23.03	23.08		
10	24	0		23.38	23.04	22.99		
10	1	1	16-QAM	23.28	23.42	23.02	21.62	0.1452
10	1	1	64-QAM	21.60	21.70	21.77		
10	1	1	256-QAM	19.62	19.60	19.58		
Limit	EIRP < 1W			Result			Pass	

NR n77 Maximum Average Power [dBm] (GT - LC = -1.8 dB)								
BW [MHz]	RB Size	RB Offset	Mod	Lowest	Middle	Highest	EIRP (dBm)	EIRP(W)
15	1	1	PI/2 BPSK	24.33	24.20	24.34	22.72	0.1871
15	1	36		24.49	23.92	24.33		
15	18	9		24.52	24.13	24.42		
15	1	0		23.80	23.60	23.80		
15	1	37		23.79	23.37	23.84		
15	36	0		23.94	23.54	23.99		
15	1	1	QPSK	24.25	24.06	24.32		
15	1	36		24.42	23.98	24.37		
15	18	9		24.38	24.08	24.32		
15	1	0		23.26	23.07	23.13		
15	1	37		23.20	22.89	23.39		
15	36	0		23.51	23.03	23.43		
15	1	1	16-QAM	23.50	23.25	23.33	21.70	0.1479
15	1	1	64-QAM	21.82	21.86	21.69		
15	1	1	256-QAM	19.96	19.59	19.88		
Limit	EIRP < 1W			Result			Pass	



NR n77 Maximum Average Power [dBm] (GT - LC = -1.8 dB)										
BW [MHz]	RB Size	RB Offset	Mod	Lowest	Middle	Highest	EIRP (dBm)	EIRP(W)		
20	1	1	PI/2 BPSK	24.34	24.26	24.14	22.75	0.1884		
20	1	49		24.22	24.03	24.43				
20	25	12		24.55	24.05	24.32				
20	1	0		23.84	23.78	23.68				
20	1	50		23.71	23.27	23.80				
20	50	0		24.05	23.57	23.86				
20	1	1	QPSK	24.27	24.16	24.06			21.50	0.1413
20	1	49		24.18	23.90	24.32				
20	25	12		24.48	24.09	24.34				
20	1	0		23.24	23.15	23.19				
20	1	50		23.31	22.66	23.38				
20	50	0		23.54	23.00	23.41				
20	1	1	16-QAM	23.30	23.20	23.09	21.50	0.1413		
20	1	1	64-QAM	21.83	21.60	21.62				
20	1	1	256-QAM	19.89	19.53	19.70				
Limit	EIRP < 1W			Result			Pass			

NR n77 Maximum Average Power [dBm] (GT - LC = -1.8 dB)										
BW [MHz]	RB Size	RB Offset	Mod	Lowest	Middle	Highest	EIRP (dBm)	EIRP(W)		
25	1	1	PI/2 BPSK	24.40	24.21	24.28	22.86	0.1932		
25	1	63		24.57	23.69	24.15				
25	32	16		24.62	23.97	24.34				
25	1	0		23.92	23.64	23.91				
25	1	64		24.22	23.31	23.69				
25	64	0		23.96	23.50	23.88				
25	1	1	QPSK	24.38	24.20	24.30			21.60	0.1445
25	1	63		24.61	23.69	24.21				
25	32	16		24.66	24.00	24.29				
25	1	0		23.36	23.12	23.28				
25	1	64		23.63	22.73	23.14				
25	64	0		23.53	23.08	23.18				
25	1	1	16-QAM	23.22	23.23	23.40	21.60	0.1445		
25	1	1	64-QAM	21.76	21.61	21.95				
25	1	1	256-QAM	19.75	19.71	19.82				
Limit	EIRP < 1W			Result			Pass			



NR n77 Maximum Average Power [dBm] (GT - LC = -1.8 dB)										
BW [MHz]	RB Size	RB Offset	Mod	Lowest	Middle	Highest	EIRP (dBm)	EIRP(W)		
30	1	1	PI/2 BPSK	24.40	24.28	24.34	22.78	0.1897		
30	1	76		24.58	23.79	24.44				
30	36	18		24.42	24.07	24.21				
30	1	0		23.82	23.84	23.89				
30	1	77		23.98	23.28	23.92				
30	75	0		23.80	23.66	23.69				
30	1	1	QPSK	24.34	24.11	24.36			21.74	0.1493
30	1	76		24.40	23.70	24.27				
30	36	18		24.42	24.01	24.23				
30	1	0		23.36	23.20	23.41				
30	1	77		23.51	22.68	23.40				
30	75	0		23.21	23.15	23.34				
30	1	1	16-QAM	23.31	23.14	23.54	21.74	0.1493		
30	1	1	64-QAM	21.78	21.56	22.17				
30	1	1	256-QAM	20.02	20.18	19.94				
Limit	EIRP < 1W			Result			Pass			

NR n77 Maximum Average Power [dBm] (GT - LC = -1.8 dB)										
BW [MHz]	RB Size	RB Offset	Mod	Lowest	Middle	Highest	EIRP (dBm)	EIRP(W)		
40	1	1	PI/2 BPSK	24.48	24.36	24.36	22.70	0.1862		
40	1	104		24.45	24.11	24.08				
40	50	25		24.30	24.04	23.98				
40	1	0		23.91	23.90	23.84				
40	1	105		23.92	23.76	23.74				
40	100	0		23.75	23.65	23.68				
40	1	1	QPSK	24.41	24.27	24.31			21.59	0.1442
40	1	104		24.27	24.21	24.06				
40	50	25		24.50	24.07	23.96				
40	1	0		23.44	23.23	23.43				
40	1	105		23.25	23.21	23.20				
40	100	0		23.33	23.06	23.14				
40	1	1	16-QAM	23.37	23.32	23.39	21.59	0.1442		
40	1	1	64-QAM	21.83	21.85	21.94				
40	1	1	256-QAM	19.83	19.88	20.06				
Limit	EIRP < 1W			Result			Pass			



NR n77 Maximum Average Power [dBm] (GT - LC = -1.8 dB)										
BW [MHz]	RB Size	RB Offset	Mod	Lowest	Middle	Highest	EIRP (dBm)	EIRP(W)		
50	1	1	PI/2 BPSK	24.49	24.40	24.54	22.89	0.1945		
50	1	131		24.28	23.85	24.20				
50	64	32		24.69	23.97	24.38				
50	1	0		23.94	23.79	23.98				
50	1	132		23.84	23.35	23.81				
50	128	0		24.17	23.57	23.98				
50	1	1	QPSK	24.53	24.38	24.46			21.87	0.1538
50	1	131		24.33	23.89	24.22				
50	64	32		24.52	24.02	24.38				
50	1	0		23.45	23.39	23.63				
50	1	132		23.29	22.94	23.29				
50	128	0		23.66	23.14	23.55				
50	1	1	16-QAM	23.42	23.51	23.67	21.87	0.1538		
50	1	1	64-QAM	22.01	21.87	22.11				
50	1	1	256-QAM	19.84	19.75	20.04				
Limit	EIRP < 1W			Result			Pass			

NR n77 Maximum Average Power [dBm] (GT - LC = -1.8 dB)										
BW [MHz]	RB Size	RB Offset	Mod	Lowest	Middle	Highest	EIRP (dBm)	EIRP(W)		
60	1	1	PI/2 BPSK	23.96	23.75	23.78	22.89	0.1945		
60	1	160		24.33	23.63	24.16				
60	81	40		24.65	24.04	24.47				
60	1	0		23.50	23.21	23.34				
60	1	161		23.96	23.31	23.62				
60	162	0		24.17	23.56	23.93				
60	1	1	QPSK	23.89	23.89	23.67			21.28	0.1343
60	1	160		24.40	23.64	24.09				
60	81	40		24.69	24.00	24.47				
60	1	0		22.95	22.90	22.82				
60	1	161		23.49	22.67	23.16				
60	162	0		23.62	23.04	23.52				
60	1	1	16-QAM	23.08	22.90	22.84	21.28	0.1343		
60	1	1	64-QAM	21.19	21.38	21.33				
60	1	1	256-QAM	19.37	19.27	19.35				
Limit	EIRP < 1W			Result			Pass			





NR n77 Maximum Average Power [dBm] (GT - LC = -1.8 dB)								
BW [MHz]	RB Size	RB Offset	Mod	Lowest	Middle	Highest	EIRP (dBm)	EIRP(W)
70	1	1	PI/2 BPSK	24.03	23.93	23.63	22.82	0.1914
70	1	187		24.20	23.82	23.94		
70	90	45		24.62	24.11	24.27		
70	1	0		23.66	23.31	23.06		
70	1	188		23.88	23.29	23.59		
70	180	0		24.07	23.71	23.82		
70	1	1	QPSK	23.89	23.95	23.68		
70	1	187		24.19	23.80	24.00		
70	90	45		24.49	24.03	24.32		
70	1	0		22.98	22.81	22.58		
70	1	188		23.36	22.86	23.18		
70	180	0		23.63	23.07	23.17		
70	1	1	16-QAM	22.87	23.03	22.69	21.23	0.1327
70	1	1	64-QAM	21.62	21.30	21.27		
70	1	1	256-QAM	19.46	19.57	19.34		
Limit	EIRP < 1W			Result			Pass	

NR n77 Maximum Average Power [dBm] (GT - LC = -1.8 dB)								
BW [MHz]	RB Size	RB Offset	Mod	Lowest	Middle	Highest	EIRP (dBm)	EIRP(W)
80	1	1	PI/2 BPSK	24.06	23.99	23.62	22.68	0.1854
80	1	215		24.30	23.90	24.11		
80	108	54		24.48	24.10	24.29		
80	1	0		23.63	23.53	23.12		
80	1	216		23.56	23.25	23.72		
80	216	0		23.94	23.55	23.81		
80	1	1	QPSK	24.08	23.97	23.67		
80	1	215		24.08	23.79	24.18		
80	108	54		24.46	24.11	24.42		
80	1	0		22.95	23.01	22.71		
80	1	216		23.11	22.81	23.17		
80	216	0		23.54	23.14	23.18		
80	1	1	16-QAM	23.24	23.04	22.72	21.44	0.1393
80	1	1	64-QAM	21.52	21.39	21.35		
80	1	1	256-QAM	19.31	19.35	18.92		
Limit	EIRP < 1W			Result			Pass	



NR n77 Maximum Average Power [dBm] (GT - LC = -1.8 dB)										
BW [MHz]	RB Size	RB Offset	Mod	Lowest	Middle	Highest	EIRP (dBm)	EIRP(W)		
90	1	1	PI/2 BPSK	24.15	24.08	23.49	22.67	0.1849		
90	1	243		23.95	23.67	24.16				
90	120	60		24.42	24.12	24.30				
90	1	0		23.59	23.57	22.97				
90	1	244		23.66	23.35	23.79				
90	243	0		24.11	23.71	23.78				
90	1	1	QPSK	24.12	24.08	23.53			21.59	0.1442
90	1	243		24.14	23.81	24.21				
90	120	60		24.47	24.11	24.32				
90	1	0		23.15	23.10	22.42				
90	1	244		23.03	22.75	23.19				
90	243	0		23.60	23.12	23.37				
90	1	1	16-QAM	23.39	23.19	22.47	21.59	0.1442		
90	1	1	64-QAM	21.62	21.48	21.04				
90	1	1	256-QAM	19.66	19.53	19.00				
Limit	EIRP < 1W			Result			Pass			

NR n77 Maximum Average Power [dBm] (GT - LC = -1.8 dB)										
BW [MHz]	RB Size	RB Offset	Mod	Lowest	Middle	Highest	EIRP (dBm)	EIRP(W)		
100	1	1	PI/2 BPSK	24.13	24.21	23.79	22.79	0.1901		
100	1	271		24.11	23.61	24.20				
100	135	67		24.54	24.05	24.25				
100	1	0		23.65	23.57	23.33				
100	1	272		23.57	23.28	23.68				
100	270	0		24.15	23.68	23.64				
100	1	1	QPSK	24.30	24.16	23.76			21.39	0.1377
100	1	271		24.22	23.60	24.21				
100	135	67		24.59	24.13	24.08				
100	1	0		23.11	23.12	22.75				
100	1	272		23.06	22.69	23.13				
100	270	0		23.59	23.19	23.13				
100	1	1	16-QAM	23.19	23.12	22.75	21.39	0.1377		
100	1	1	64-QAM	21.84	21.60	21.37				
100	1	1	256-QAM	19.56	19.58	19.32				
Limit	EIRP < 1W			Result			Pass			



NR n77 HPUE Maximum Average Power [dBm] (GT - LC = -1.8 dB)								
BW [MHz]	RB Size	RB Offset	Mod	Lowest	Middle	Highest	EIRP (dBm)	EIRP(W)
10	1	1	PI/2 BPSK	25.21	25.01	26.10	24.30	0.2692
10	1	22		25.36	24.98	25.91		
10	12	6		25.17	25.03	25.93		
10	1	0		21.58	21.59	22.48		
10	1	23		21.73	21.38	22.45		
10	24	0		24.69	24.39	25.43		
10	1	1	QPSK	25.17	24.91	26.07		
10	1	22		25.20	25.05	25.95		
10	12	6		25.37	25.02	26.04		
10	1	0		21.61	21.43	22.63		
10	1	23		21.84	21.35	22.40		
10	24	0		23.18	23.95	24.87		
10	1	1	16-QAM	24.30	24.03	25.11	23.31	0.2143
10	1	1	64-QAM	22.55	22.49	23.58		
10	1	1	256-QAM	20.53	20.52	21.50		
Limit	EIRP < 1W			Result			Pass	

NR n77 HPUE Maximum Average Power [dBm] (GT - LC = -1.8 dB)								
BW [MHz]	RB Size	RB Offset	Mod	Lowest	Middle	Highest	EIRP (dBm)	EIRP(W)
15	1	1	PI/2 BPSK	25.40	24.64	26.19	24.39	0.2748
15	1	36		25.37	24.59	26.11		
15	18	9		25.52	24.57	26.11		
15	1	0		21.93	21.16	22.48		
15	1	37		21.74	21.11	22.67		
15	36	0		25.04	24.06	25.82		
15	1	1	QPSK	25.31	24.84	26.10		
15	1	36		25.47	24.62	26.17		
15	18	9		25.45	24.62	26.11		
15	1	0		21.96	21.29	22.67		
15	1	37		21.61	21.16	22.71		
15	36	0		24.41	23.76	25.32		
15	1	1	16-QAM	24.43	23.94	25.40	23.60	0.2291
15	1	1	64-QAM	22.90	22.33	23.67		
15	1	1	256-QAM	20.98	20.32	21.69		
Limit	EIRP < 1W			Result			Pass	



NR n77 HPUE Maximum Average Power [dBm] (GT - LC = -1.8 dB)								
BW [MHz]	RB Size	RB Offset	Mod	Lowest	Middle	Highest	EIRP (dBm)	EIRP(W)
20	1	1	PI/2 BPSK	25.40	24.76	26.01	24.39	0.2748
20	1	49		25.27	24.51	26.19		
20	25	12		25.52	24.69	26.14		
20	1	0		21.83	21.42	22.50		
20	1	50		21.86	20.80	22.56		
20	50	0		25.02	24.11	25.75		
20	1	1	QPSK	25.54	24.72	26.09		
20	1	49		25.25	24.59	26.14		
20	25	12		25.47	24.77	26.17		
20	1	0		21.94	21.20	22.50		
20	1	50		21.89	20.84	22.62		
20	50	0		24.43	23.62	25.10		
20	1	1	16-QAM	24.53	23.77	24.76	22.96	0.1977
20	1	1	64-QAM	22.95	22.39	23.39		
20	1	1	256-QAM	20.84	20.50	21.53		
Limit	EIRP < 1W			Result			Pass	

NR n77 HPUE Maximum Average Power [dBm] (GT - LC = -1.8 dB)								
BW [MHz]	RB Size	RB Offset	Mod	Lowest	Middle	Highest	EIRP (dBm)	EIRP(W)
25	1	1	PI/2 BPSK	25.48	24.75	26.17	24.37	0.2735
25	1	63		25.61	24.50	26.07		
25	32	16		25.56	24.36	26.15		
25	1	0		21.98	21.32	22.68		
25	1	64		22.09	20.99	22.52		
25	64	0		25.11	24.31	25.79		
25	1	1	QPSK	25.49	24.80	26.11		
25	1	63		25.55	24.47	25.96		
25	32	16		25.53	23.75	26.16		
25	1	0		21.94	21.34	22.61		
25	1	64		22.07	20.96	22.78		
25	64	0		24.58	23.62	25.25		
25	1	1	16-QAM	24.27	23.85	25.26	23.46	0.2218
25	1	1	64-QAM	23.02	22.46	23.85		
25	1	1	256-QAM	20.88	20.21	21.82		
Limit	EIRP < 1W			Result			Pass	



NR n77 HPUE Maximum Average Power [dBm] (GT - LC = -1.8 dB)								
BW [MHz]	RB Size	RB Offset	Mod	Lowest	Middle	Highest	EIRP (dBm)	EIRP(W)
30	1	1	PI/2 BPSK	25.53	24.78	26.18	24.39	0.2748
30	1	76		25.56	24.39	26.10		
30	36	18		25.54	24.74	26.16		
30	1	0		21.91	21.24	22.73		
30	1	77		22.06	20.89	22.65		
30	75	0		24.80	24.18	25.68		
30	1	1	QPSK	25.50	24.77	26.19		
30	1	76		25.55	24.32	26.12		
30	36	18		25.45	24.69	26.14		
30	1	0		21.98	21.22	22.86		
30	1	77		22.09	20.89	22.71		
30	75	0		24.37	23.73	25.11		
30	1	1	16-QAM	24.39	23.81	25.27	23.47	0.2223
30	1	1	64-QAM	22.98	22.26	23.98		
30	1	1	256-QAM	20.82	20.15	21.85		
Limit	EIRP < 1W			Result			Pass	

NR n77 HPUE Maximum Average Power [dBm] (GT - LC = -1.8 dB)								
BW [MHz]	RB Size	RB Offset	Mod	Lowest	Middle	Highest	EIRP (dBm)	EIRP(W)
40	1	1	PI/2 BPSK	25.40	24.97	26.16	24.38	0.2742
40	1	104		25.28	24.46	26.18		
40	50	25		25.40	24.65	26.11		
40	1	0		21.89	21.50	22.71		
40	1	105		21.87	21.03	22.61		
40	100	0		24.94	24.12	25.61		
40	1	1	QPSK	25.54	24.91	26.15		
40	1	104		25.38	24.94	26.09		
40	50	25		25.36	24.81	26.04		
40	1	0		21.91	21.52	22.68		
40	1	105		21.95	20.98	22.64		
40	100	0		24.41	23.78	24.93		
40	1	1	16-QAM	24.60	23.99	25.47	23.67	0.2328
40	1	1	64-QAM	23.10	22.29	23.77		
40	1	1	256-QAM	20.85	20.30	21.59		
Limit	EIRP < 1W			Result			Pass	



NR n77 HPUE Maximum Average Power [dBm] (GT - LC = -1.8 dB)								
BW [MHz]	RB Size	RB Offset	Mod	Lowest	Middle	Highest	EIRP (dBm)	EIRP(W)
50	1	1	PI/2 BPSK	25.52	24.99	26.12	24.38	0.2742
50	1	131		25.43	24.52	26.14		
50	64	32		25.72	24.85	26.12		
50	1	0		22.08	21.60	22.94		
50	1	132		21.86	20.88	22.69		
50	128	0		25.16	24.22	25.79		
50	1	1	QPSK	25.45	25.10	26.15		
50	1	131		25.31	24.49	26.18		
50	64	32		25.80	24.68	26.16		
50	1	0		22.05	21.45	22.80		
50	1	132		21.81	21.00	22.57		
50	128	0		24.81	23.77	25.31		
50	1	1	16-QAM	24.67	24.01	25.57	23.77	0.2382
50	1	1	64-QAM	22.99	22.68	23.86		
50	1	1	256-QAM	20.89	20.66	21.81		
Limit	EIRP < 1W			Result			Pass	

NR n77 HPUE Maximum Average Power [dBm] (GT - LC = -1.8 dB)								
BW [MHz]	RB Size	RB Offset	Mod	Lowest	Middle	Highest	EIRP (dBm)	EIRP(W)
60	1	1	PI/2 BPSK	25.06	24.49	25.51	24.33	0.2710
60	1	160		25.42	24.35	26.03		
60	81	40		25.82	24.72	26.12		
60	1	0		21.52	20.98	22.19		
60	1	161		21.97	20.85	22.46		
60	162	0		25.14	24.34	25.94		
60	1	1	QPSK	24.99	24.39	25.61		
60	1	160		22.11	24.29	26.13		
60	81	40		25.71	24.74	24.54		
60	1	0		21.40	20.93	22.12		
60	1	161		22.04	20.83	22.62		
60	162	0		24.68	23.68	25.31		
60	1	1	16-QAM	23.91	23.37	24.72	22.92	0.1959
60	1	1	64-QAM	22.43	21.92	23.14		
60	1	1	256-QAM	20.56	20.07	21.29		
Limit	EIRP < 1W			Result			Pass	



NR n77 HPUE Maximum Average Power [dBm] (GT - LC = -1.8 dB)								
BW [MHz]	RB Size	RB Offset	Mod	Lowest	Middle	Highest	EIRP (dBm)	EIRP(W)
70	1	1	PI/2 BPSK	24.98	24.43	25.69	24.37	0.2735
70	1	187		25.20	24.39	26.06		
70	90	45		25.65	24.67	26.14		
70	1	0		21.54	20.92	22.17		
70	1	188		21.77	20.86	22.53		
70	180	0		24.99	24.33	25.69		
70	1	1	QPSK	25.08	24.58	25.57		
70	1	187		25.36	24.47	25.94		
70	90	45		25.53	24.73	26.17		
70	1	0		21.53	21.03	22.17		
70	1	188		21.68	20.89	22.47		
70	180	0		24.64	23.86	25.23		
70	1	1	16-QAM	24.24	23.40	24.73	22.93	0.1963
70	1	1	64-QAM	22.46	21.88	23.03		
70	1	1	256-QAM	20.63	20.20	21.06		
Limit	EIRP < 1W			Result			Pass	

NR n77 HPUE Maximum Average Power [dBm] (GT - LC = -1.8 dB)								
BW [MHz]	RB Size	RB Offset	Mod	Lowest	Middle	Highest	EIRP (dBm)	EIRP(W)
80	1	1	PI/2 BPSK	25.11	24.56	25.61	24.36	0.2729
80	1	215		25.38	24.48	26.04		
80	108	54		25.55	24.78	26.10		
80	1	0		21.56	21.04	22.11		
80	1	216		21.72	20.84	22.53		
80	216	0		25.17	24.27	25.70		
80	1	1	QPSK	25.11	24.57	25.54		
80	1	215		25.27	24.36	26.00		
80	108	54		25.52	24.77	26.16		
80	1	0		21.67	21.13	22.10		
80	1	216		21.71	20.83	22.63		
80	216	0		24.67	23.86	25.17		
80	1	1	16-QAM	24.05	23.64	24.63	22.83	0.1919
80	1	1	64-QAM	22.54	22.06	23.02		
80	1	1	256-QAM	20.49	20.17	21.08		
Limit	EIRP < 1W			Result			Pass	



NR n77 HPUE Maximum Average Power [dBm] (GT - LC = -1.8 dB)								
BW [MHz]	RB Size	RB Offset	Mod	Lowest	Middle	Highest	EIRP (dBm)	EIRP(W)
90	1	1	PI/2 BPSK	25.28	24.63	25.65	24.40	0.2754
90	1	243		25.30	24.41	26.12		
90	120	60		25.61	24.92	26.19		
90	1	0		21.71	21.26	21.87		
90	1	244		21.81	20.94	22.75		
90	243	0		25.12	24.32	25.71		
90	1	1	QPSK	25.27	24.77	25.42	24.40	0.2754
90	1	243		25.24	24.51	26.09		
90	120	60		25.60	24.82	26.20		
90	1	0		21.78	21.15	21.92		
90	1	244		21.70	21.04	22.65		
90	243	0		24.74	23.75	25.17		
90	1	1	16-QAM	24.23	23.61	24.58	22.78	0.1897
90	1	1	64-QAM	22.56	22.44	23.07		
90	1	1	256-QAM	20.62	20.26	21.10		
Limit	EIRP < 1W			Result			Pass	

NR n77 HPUE Maximum Average Power [dBm] (GT - LC = -1.8 dB)								
BW [MHz]	RB Size	RB Offset	Mod	Lowest	Middle	Highest	EIRP (dBm)	EIRP(W)
100	1	1	PI/2 BPSK	25.21	24.63	25.64	24.39	0.2748
100	1	271		25.40	24.34	26.15		
100	135	67		25.65	24.90	26.05		
100	1	0		21.76	21.22	22.22		
100	1	272		21.80	20.82	22.69		
100	270	0		25.23	24.18	25.53		
100	1	1	QPSK	25.29	24.81	25.76	24.39	0.2748
100	1	271		25.32	24.39	26.06		
100	135	67		25.78	24.82	26.19		
100	1	0		21.83	21.20	22.28		
100	1	272		21.77	20.98	22.59		
100	270	0		24.60	23.72	25.02		
100	1	1	16-QAM	24.19	23.63	24.73	22.93	0.1963
100	1	1	64-QAM	22.67	22.22	23.17		
100	1	1	256-QAM	20.90	20.38	20.95		
Limit	EIRP < 1W			Result			Pass	





# FR1 n77\_HPUE

## Peak-to-Average Ratio

Mode	FR1 n77 / 20MHz / DFT-S OFDM				
Mod.	PI/2 BPSK	QPSK	16QAM	64QAM	Limit: 13dB
RB Size	Full RB	Full RB	Full RB	Full RB	Result
Middle CH	4.56	5.50	6.20	6.24	PASS
Mode	FR1 n77 / 20MHz / DFT-S OFDM				
Mod.	256QAM				Limit: 13dB
RB Size	Full RB				Result
Middle CH	6.74				PASS



FR1 n77 / 20MHz / DFT-S OFDM / Middle Channel / Full RB

PI/2 BPSK

QPSK

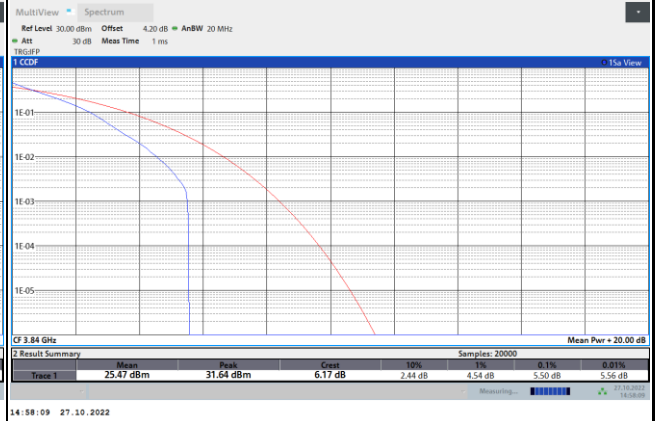
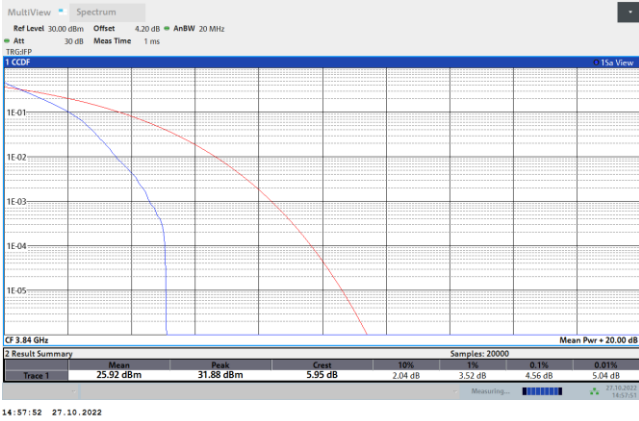

16QAM

64QAM

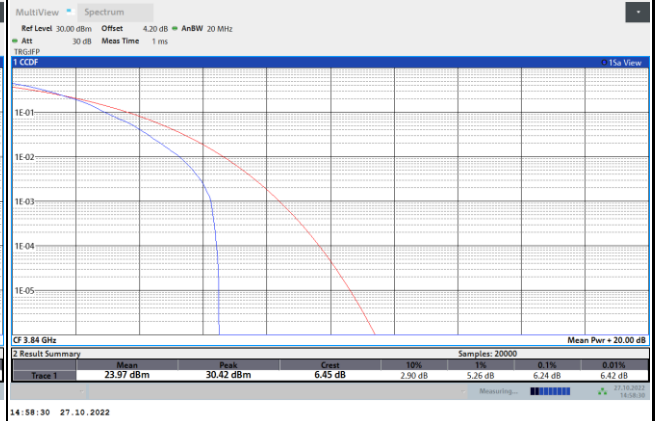
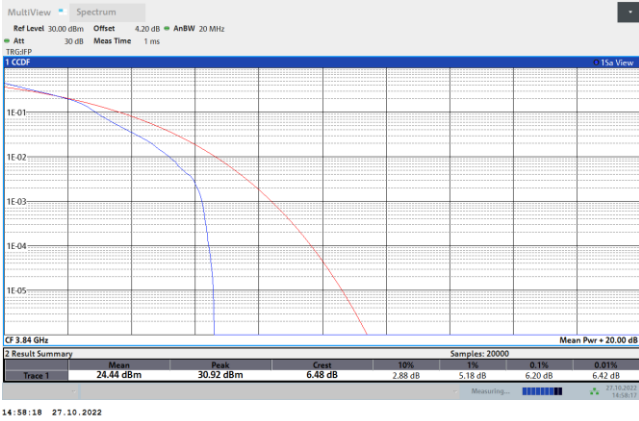

256QAM

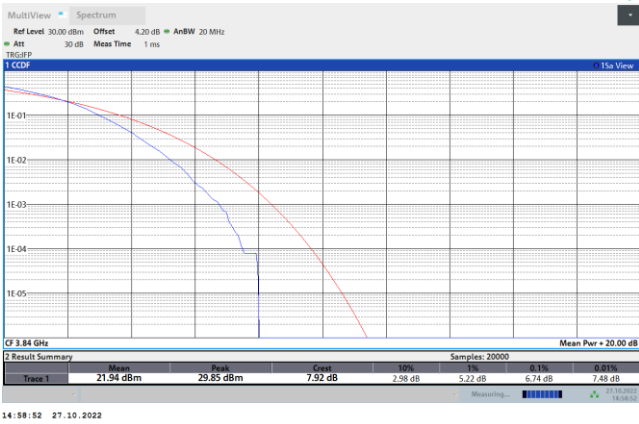



**26dB Bandwidth**

Mode	FR1 n77 : 26dB BW(MHz) / DFT-S OFDM							
BW	10MHz	15MHz	20MHz	25MHz	30MHz	40MHz	50MHz	60MHz
Mod.	PI/2 BPSK	PI/2 BPSK	PI/2 BPSK	PI/2 BPSK	PI/2 BPSK	PI/2 BPSK	PI/2 BPSK	PI/2 BPSK
Middle CH	8.97	13.79	18.98	23.98	27.75	38.28	48.65	60.90
BW	70MHz	80MHz	90MHz	100MHz				
Mod.	PI/2 BPSK	PI/2 BPSK	PI/2 BPSK	PI/2 BPSK				
Middle CH	67.27	80.88	90.09	100.10				

Mode	FR1 n77 : 26dB BW(MHz) / CP OFDM							
BW	10MHz		15MHz		20MHz		25MHz	
Mod.	QPSK	16QAM	QPSK	16QAM	QPSK	16QAM	QPSK	16QAM
Middle CH	9.73	9.33	14.60	14.42	19.18	19.14	24.43	24.48
Mod.	64QAM	256QAM	64QAM	256QAM	64QAM	256QAM	64QAM	256QAM
Middle CH	9.29	9.13	14.45	14.81	19.14	19.18	24.28	24.33
BW	30MHz		40MHz		50MHz		60MHz	
Mod.	QPSK	16QAM	QPSK	16QAM	QPSK	16QAM	QPSK	16QAM
Middle CH	29.07	29.07	40.52	40.36	50.35	50.05	60.90	61.26
Mod.	64QAM	256QAM	64QAM	256QAM	64QAM	256QAM	64QAM	256QAM
Middle CH	29.13	29.13	40.60	40.60	50.25	50.15	60.66	60.78
BW	70MHz		80MHz		90MHz		100MHz	
Mod.	QPSK	16QAM	QPSK	16QAM	QPSK	16QAM	QPSK	16QAM
Middle CH	70.63	70.21	80.56	80.56	90.63	90.45	101.10	100.30
Mod.	64QAM	256QAM	64QAM	256QAM	64QAM	256QAM	64QAM	256QAM
Middle CH	70.49	70.63	80.24	80.40	90.63	90.63	101.70	100.70



FR1 n77 / 10MHz / DFT-S OFDM / Middle Channel / Full RB

PI/2 BPSK

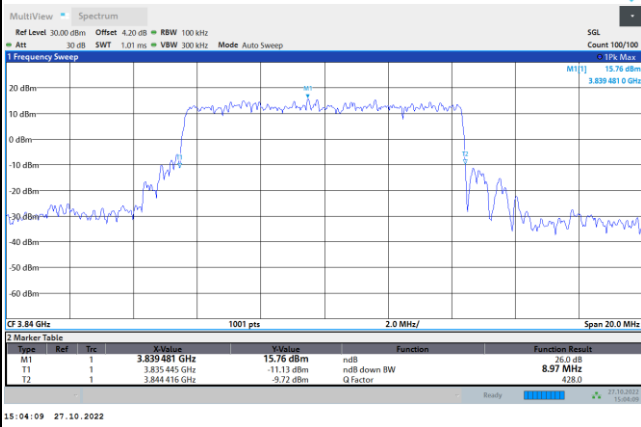

FR1 n77 / 10MHz / CP OFDM / Middle Channel / Full RB

QPSK

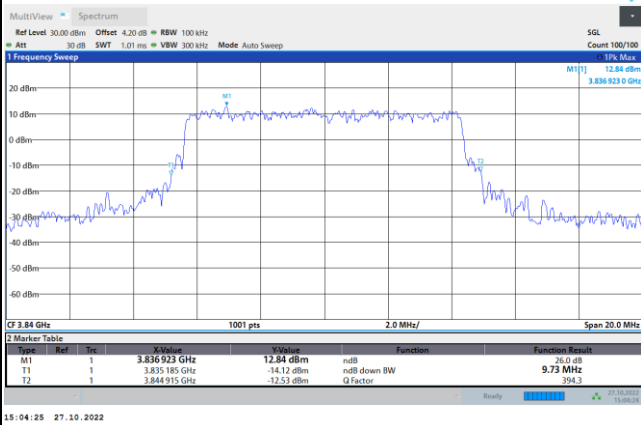

16QAM

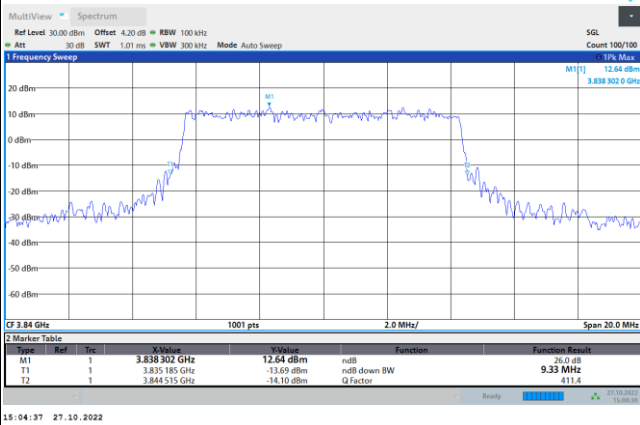

64QAM

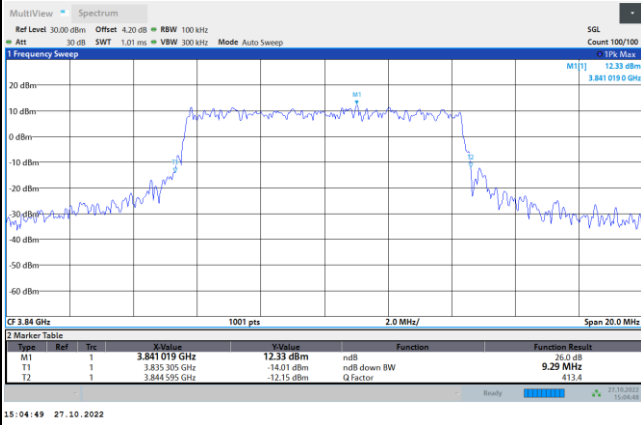

256QAM

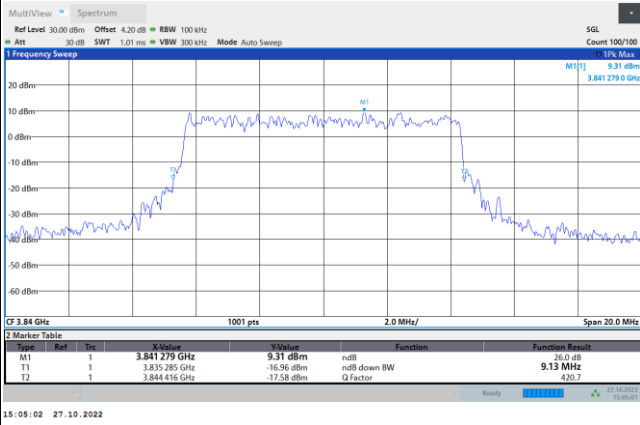



FR1 n77 / 15MHz / DFT-S OFDM / Middle Channel / Full RB

PI/2 BPSK

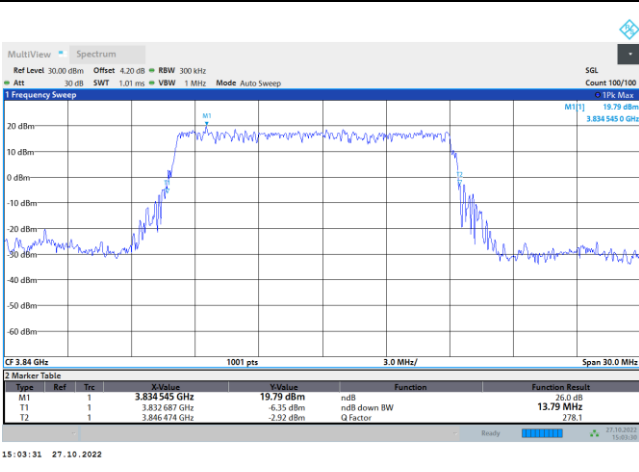

FR1 n77 / 15MHz / CP OFDM / Middle Channel / Full RB

QPSK

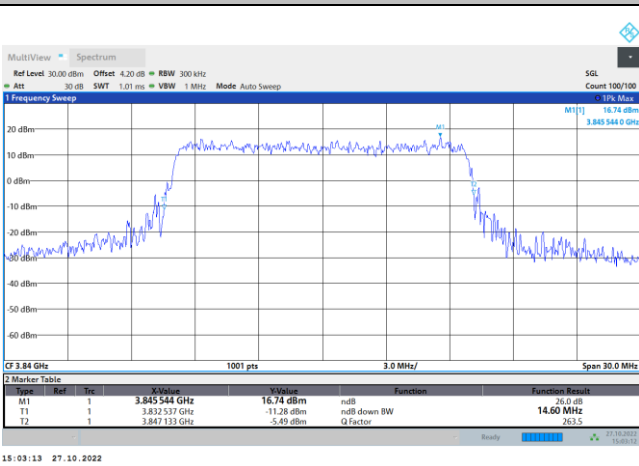

16QAM

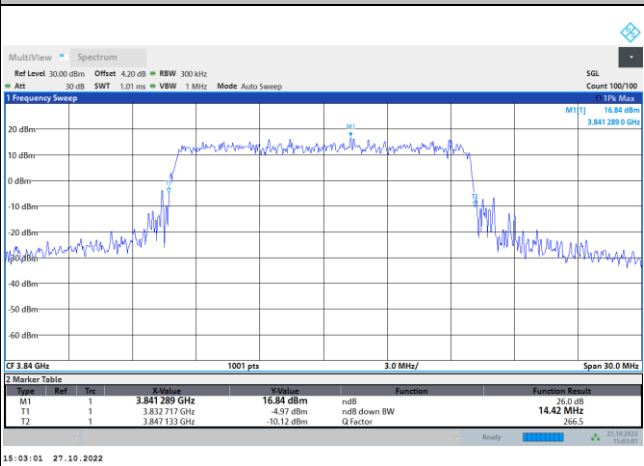

64QAM

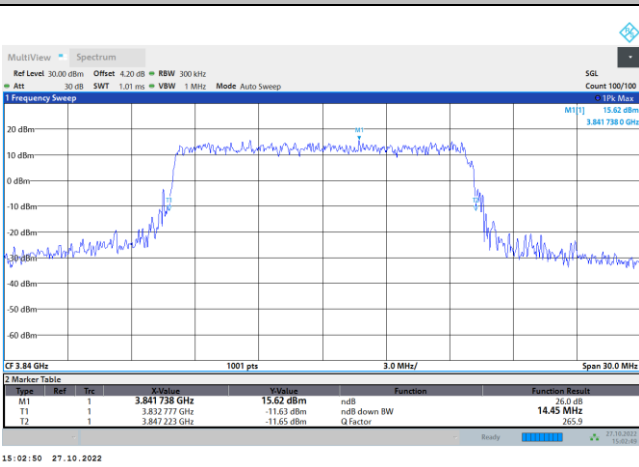

256QAM

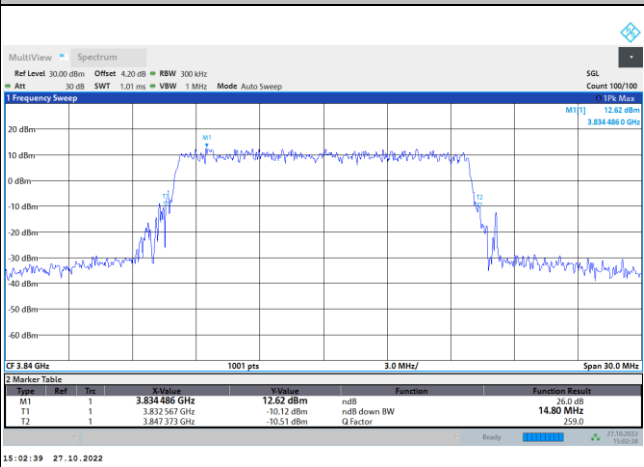



FR1 n77 / 20MHz / DFT-S OFDM / Middle Channel / Full RB

PI/2 BPSK

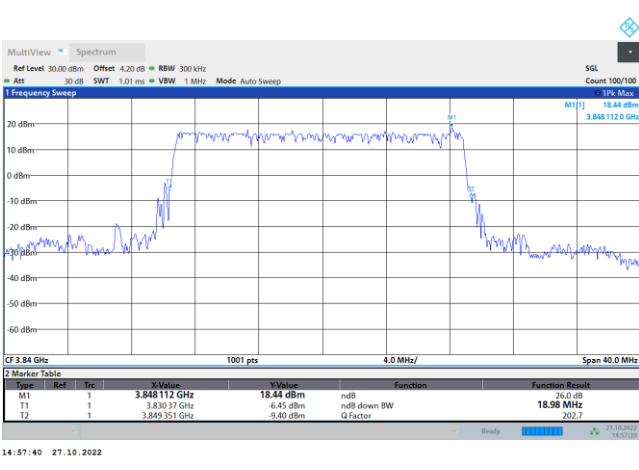

FR1 n77 / 20MHz / CP OFDM / Middle Channel / Full RB

QPSK

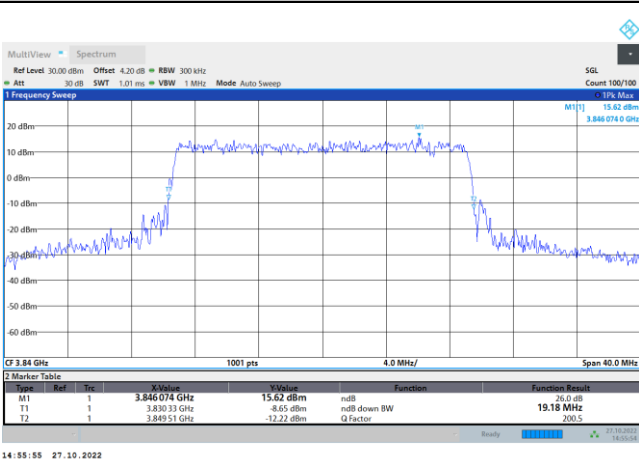

16QAM

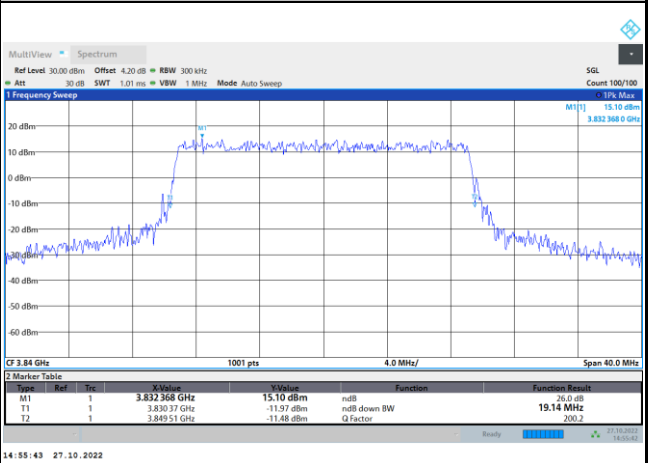

64QAM

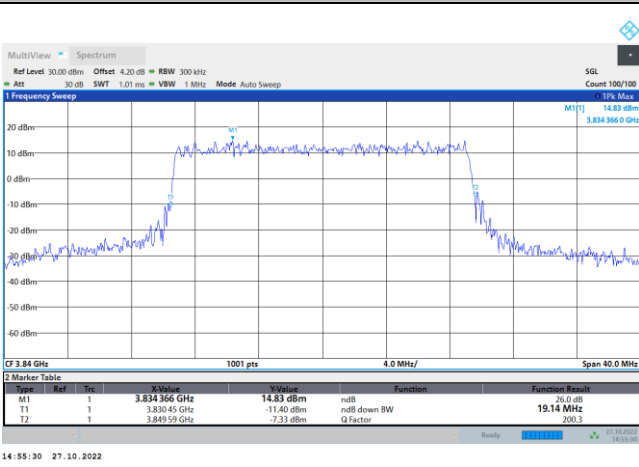

256QAM

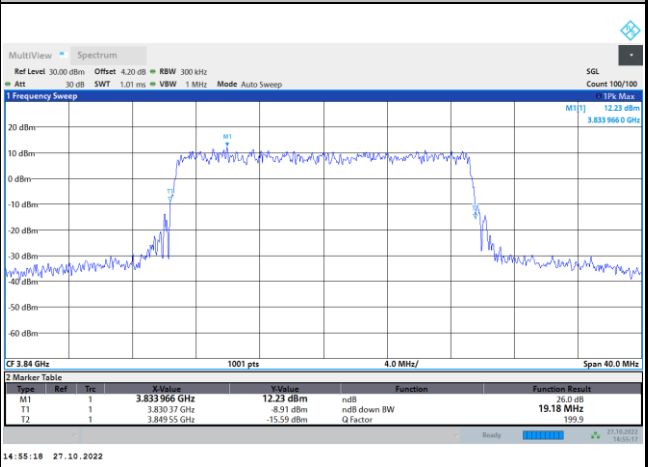



FR1 n77 / 25MHz / DFT-S OFDM / Middle Channel / Full RB

PI/2 BPSK

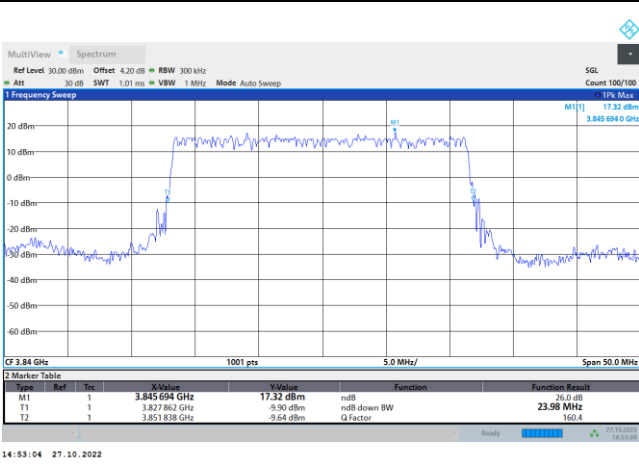

FR1 n77 / 25MHz / CP OFDM / Middle Channel / Full RB

QPSK

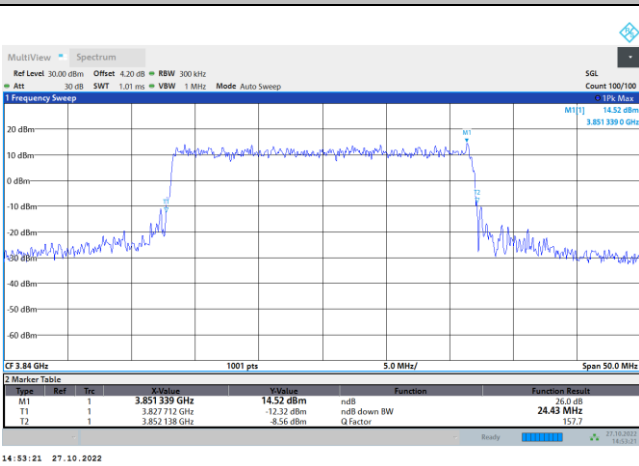

16QAM

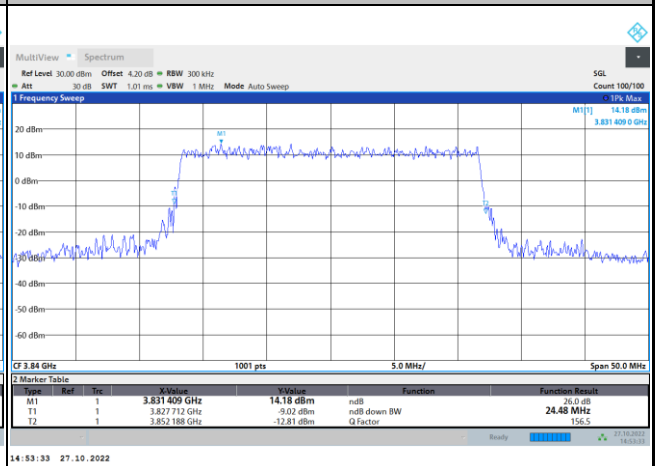

64QAM

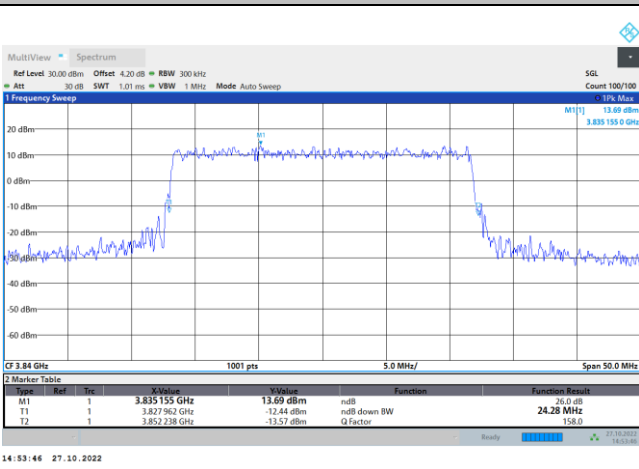

256QAM

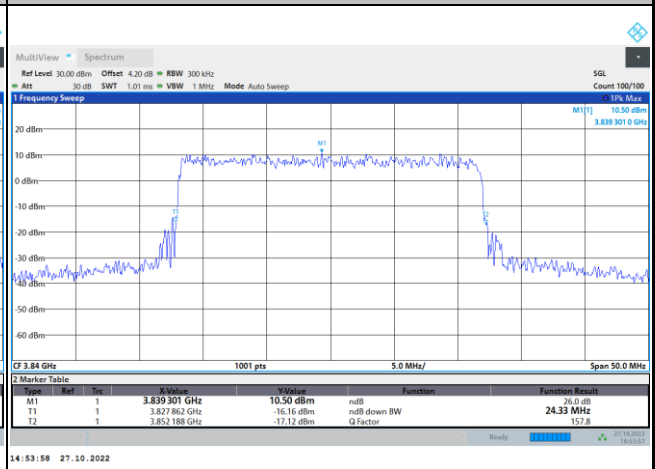



FR1 n77 / 30MHz / DFT-S OFDM / Middle Channel / Full RB

PI/2 BPSK

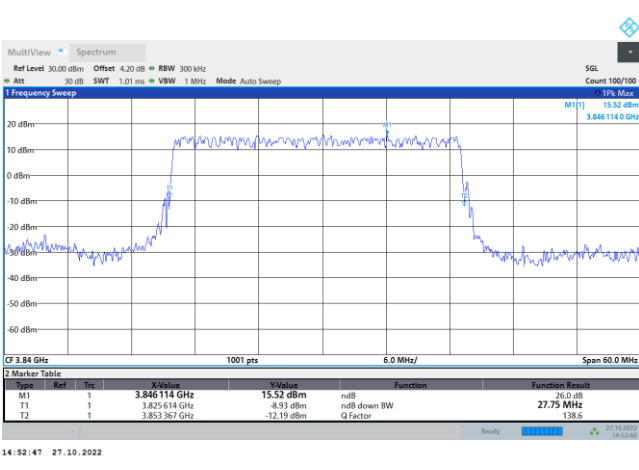

FR1 n77 / 30MHz / CP OFDM / Middle Channel / Full RB

QPSK

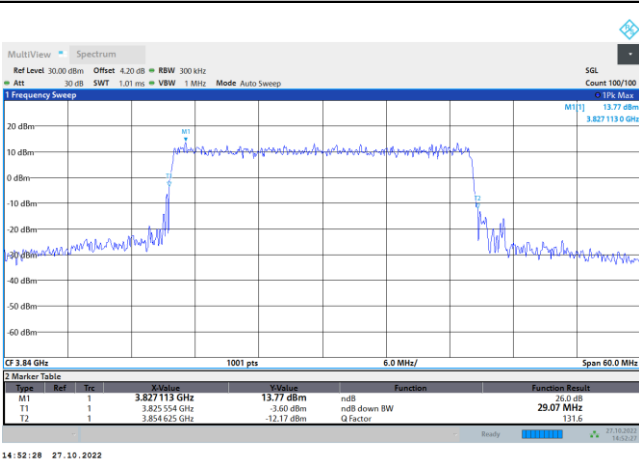

16QAM

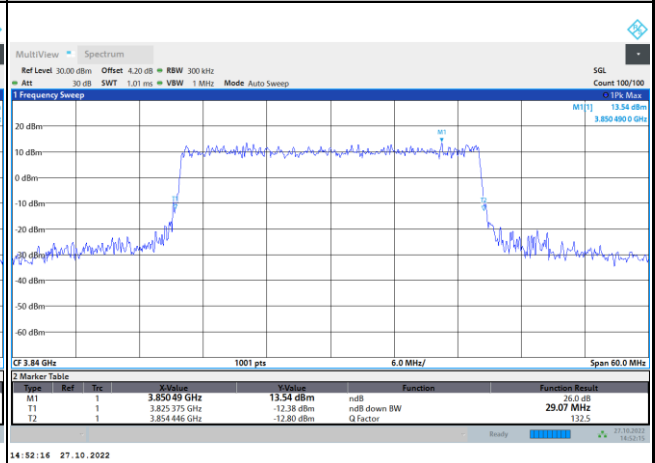

64QAM

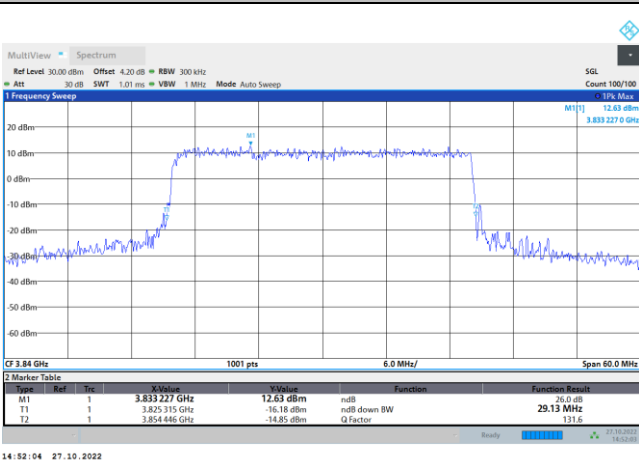

256QAM

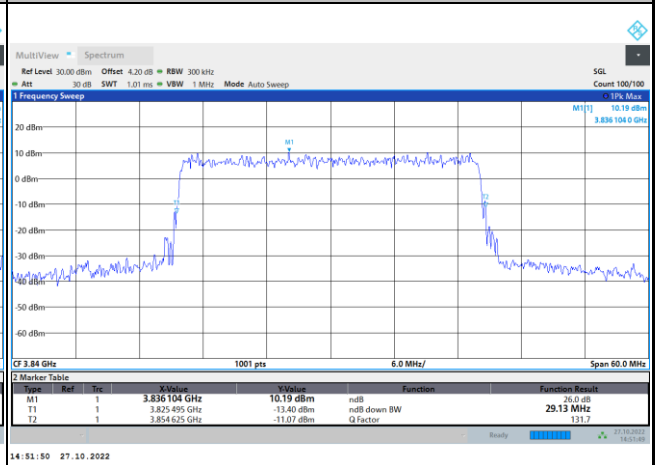





FR1 n77 / 40MHz / DFT-S OFDM / Middle Channel / Full RB

PI/2 BPSK

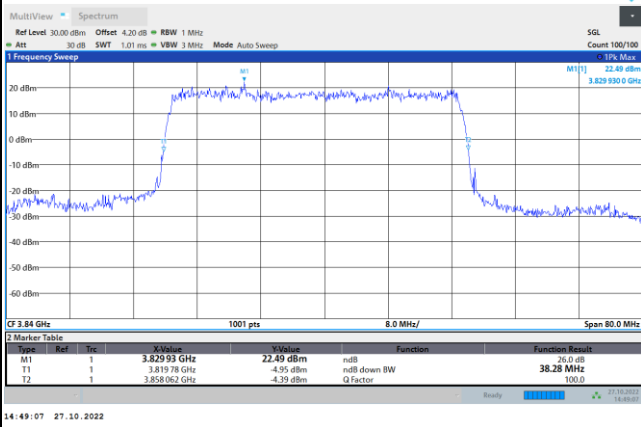

FR1 n77 / 40MHz / CP OFDM / Middle Channel / Full RB

QPSK

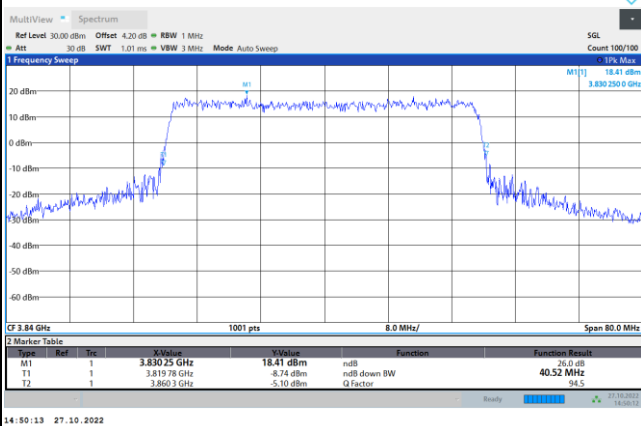

16QAM

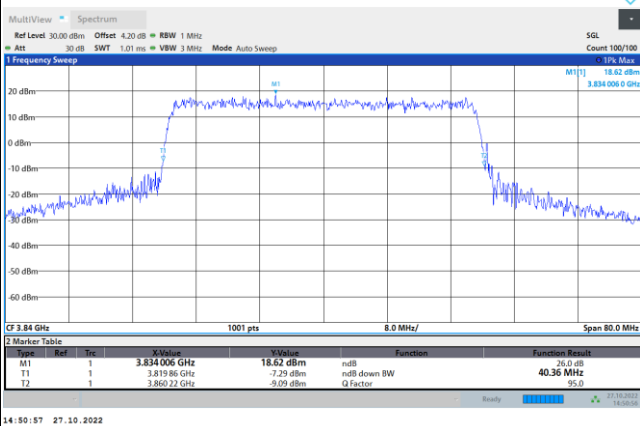

64QAM

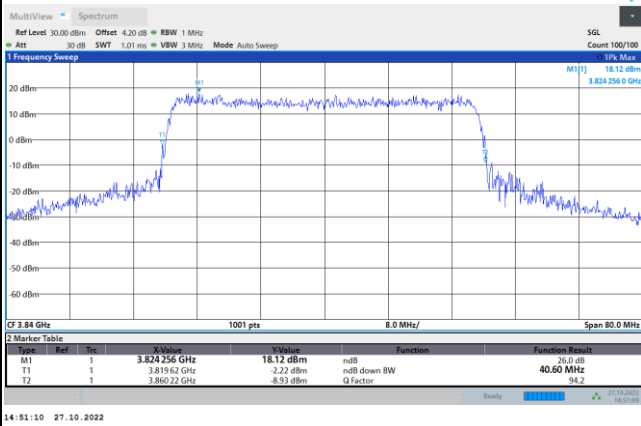

256QAM

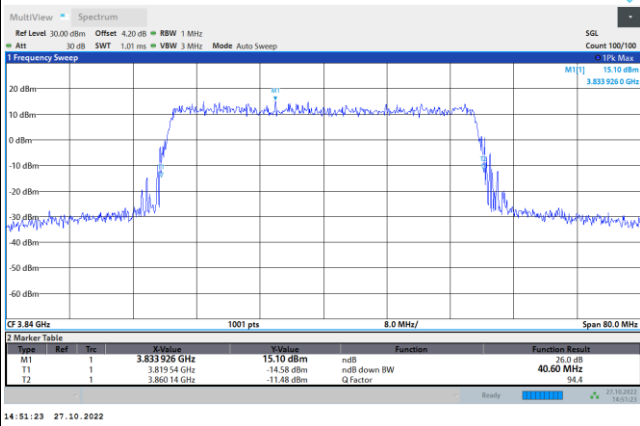



FR1 n77 / 50MHz / DFT-S OFDM / Middle Channel / Full RB

PI/2 BPSK

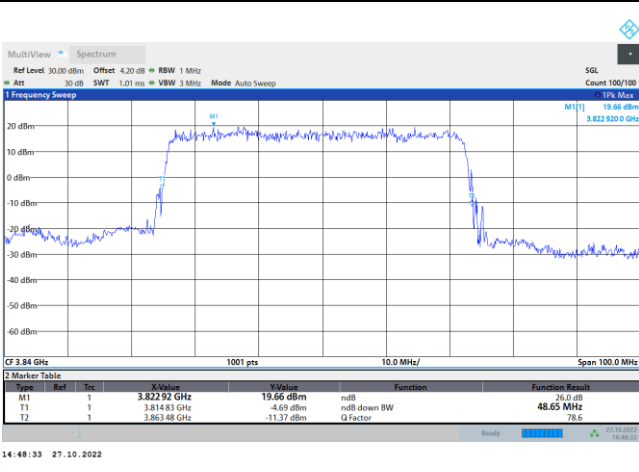

FR1 n77 / 50MHz / CP OFDM / Middle Channel / Full RB

QPSK

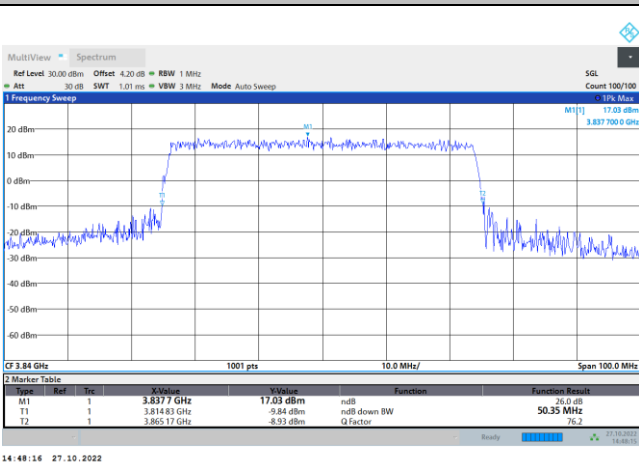

16QAM

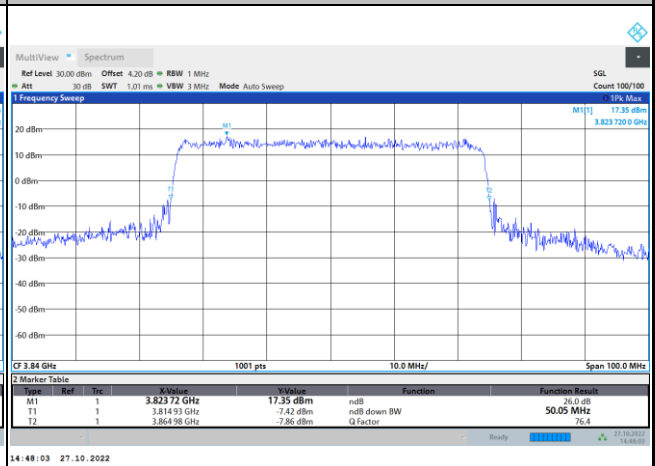

64QAM

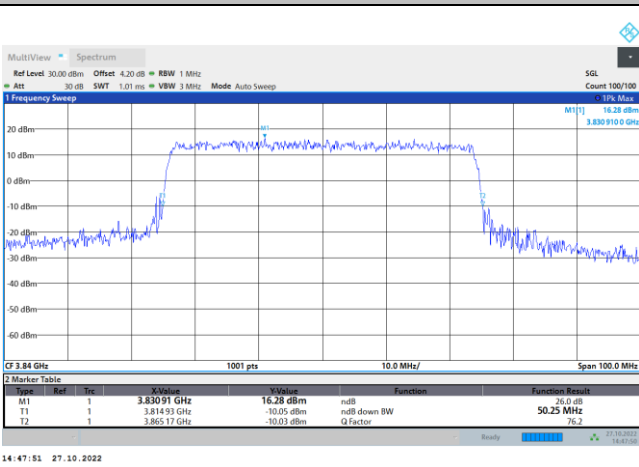

256QAM

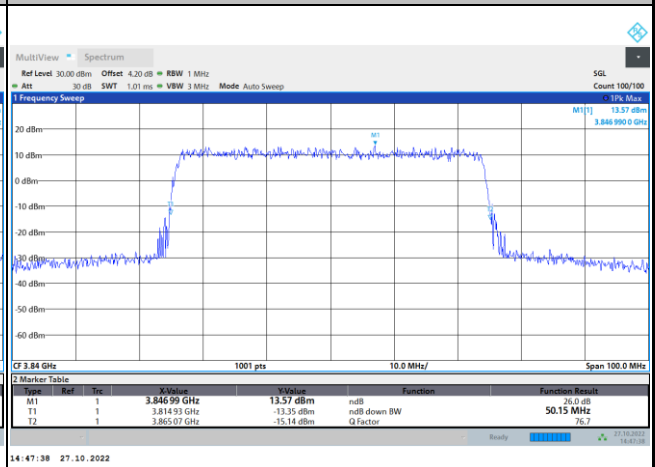



FR1 n77 / 60MHz / DFT-S OFDM / Middle Channel / Full RB

PI/2 BPSK

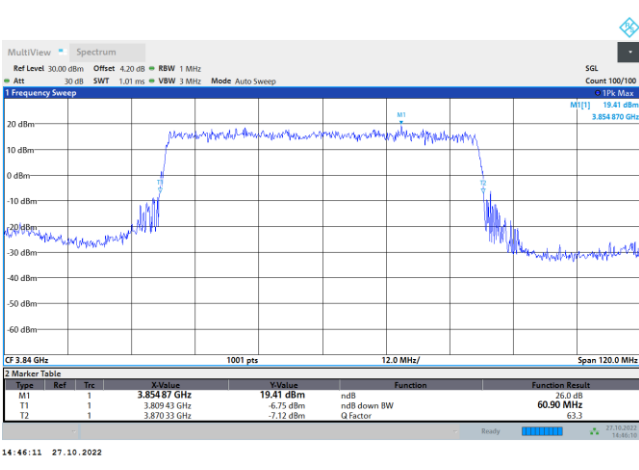

FR1 n77 / 60MHz / CP OFDM / Middle Channel / Full RB

QPSK

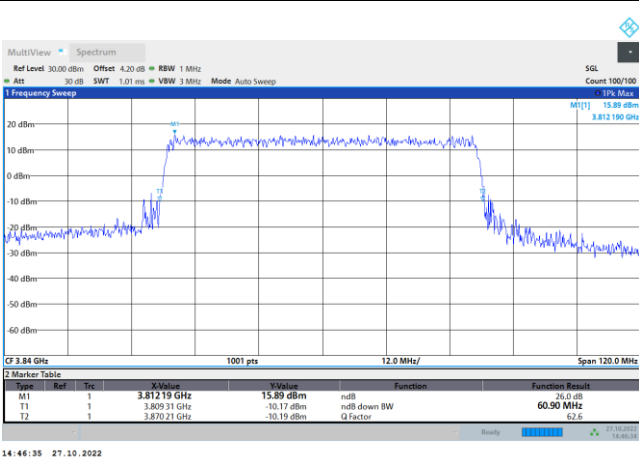

16QAM

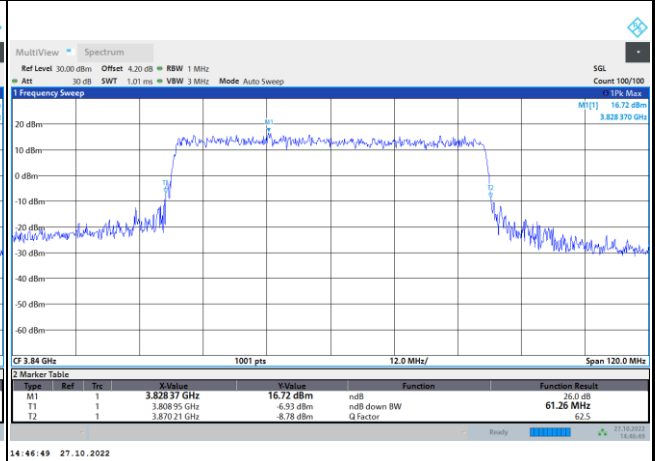

64QAM

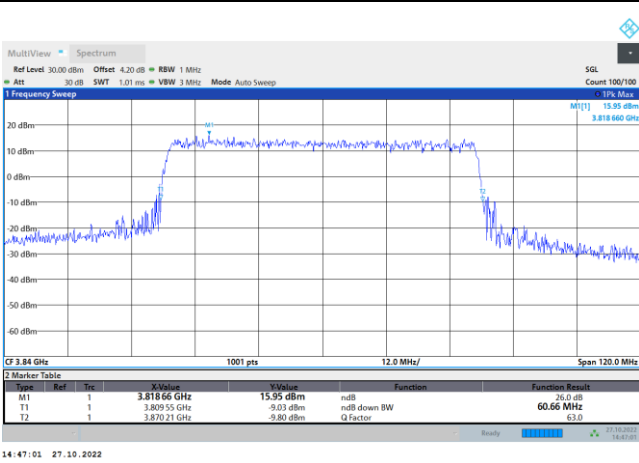

256QAM

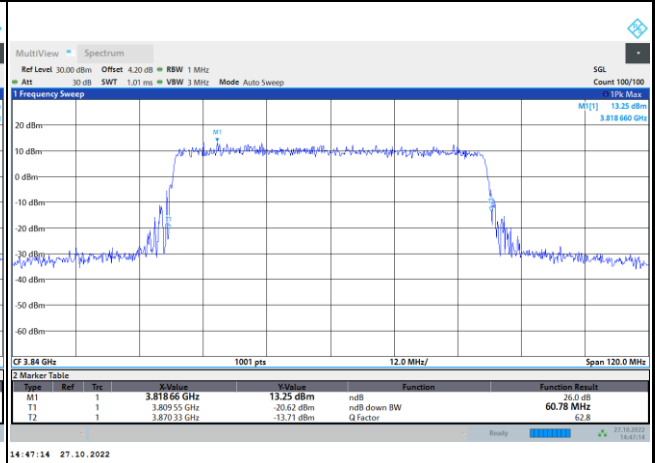



FR1 n77 / 70MHz / DFT-S OFDM / Middle Channel / Full RB

PI/2 BPSK

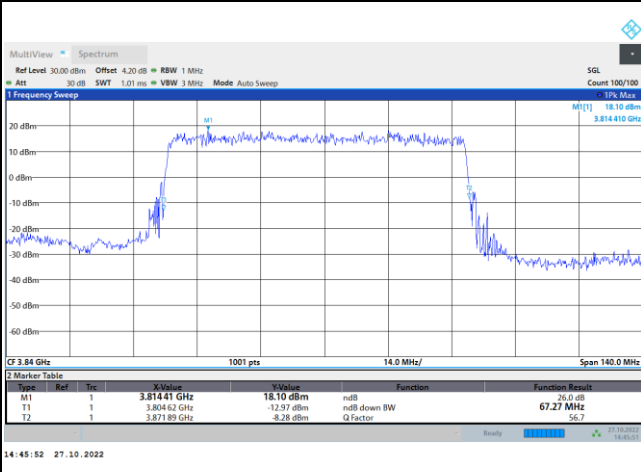

FR1 n77 / 70MHz / CP OFDM / Middle Channel / Full RB

QPSK

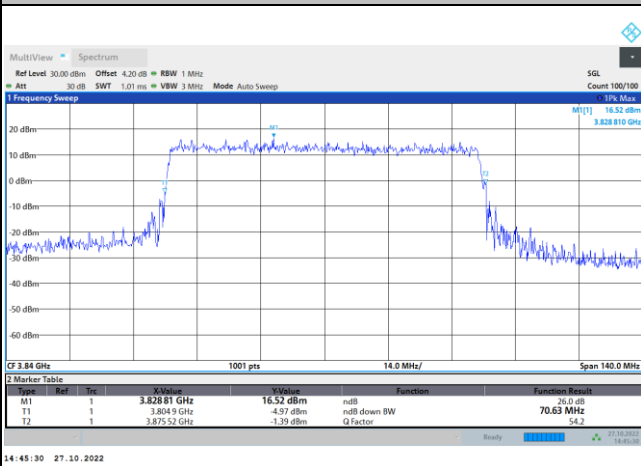

16QAM

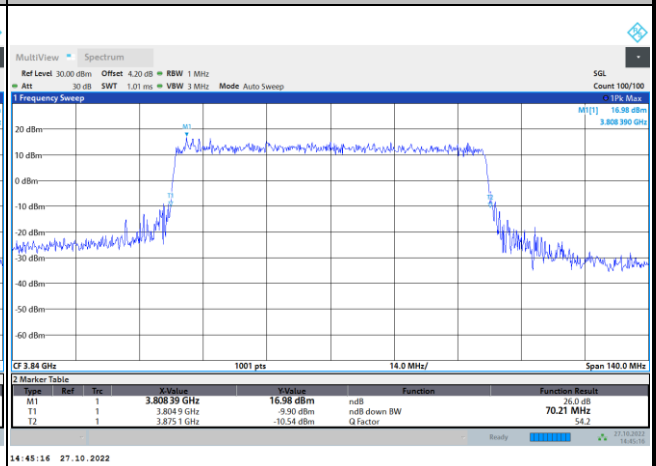

64QAM

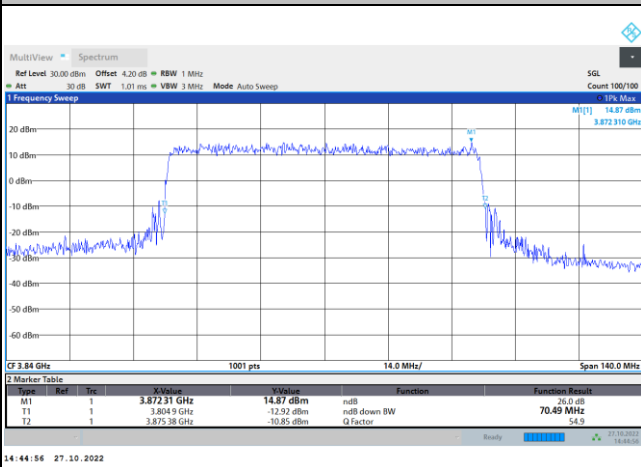

256QAM

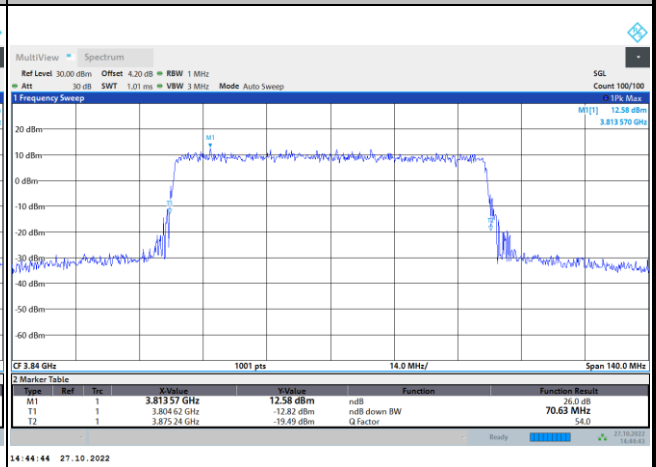



FR1 n77 / 80MHz / DFT-S OFDM / Middle Channel / Full RB

PI/2 BPSK

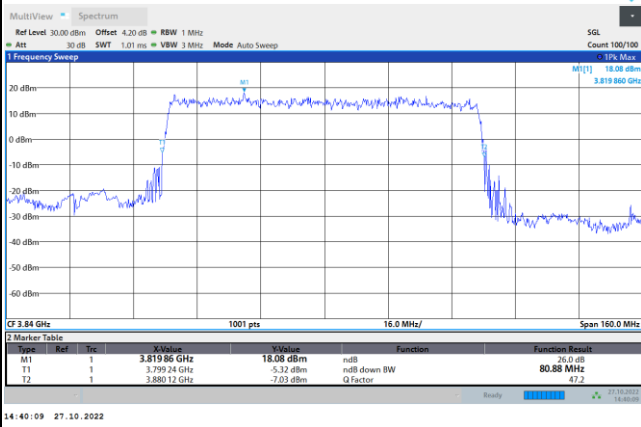

FR1 n77 / 80MHz / CP OFDM / Middle Channel / Full RB

QPSK

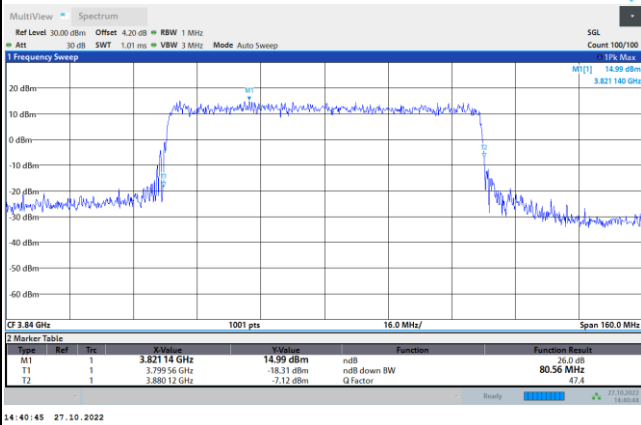

16QAM

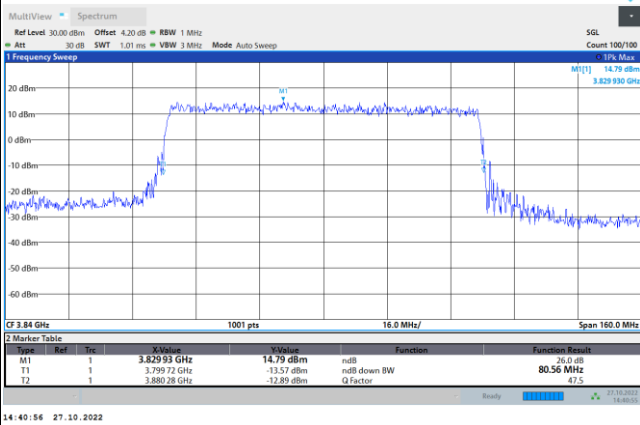

64QAM

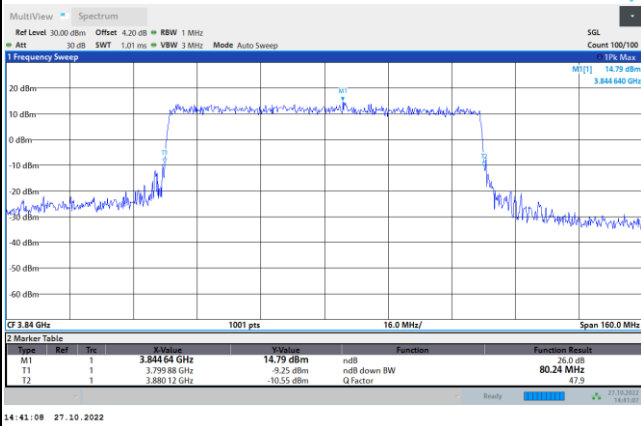

256QAM

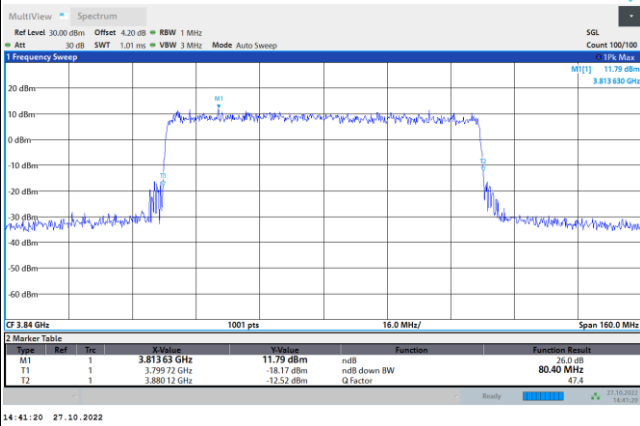



FR1 n77 / 90MHz / DFT-S OFDM / Middle Channel / Full RB

PI/2 BPSK

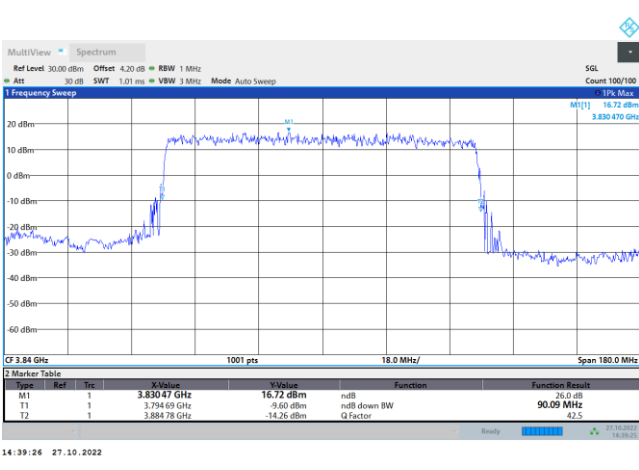

FR1 n77 / 90MHz / CP OFDM / Middle Channel / Full RB

QPSK

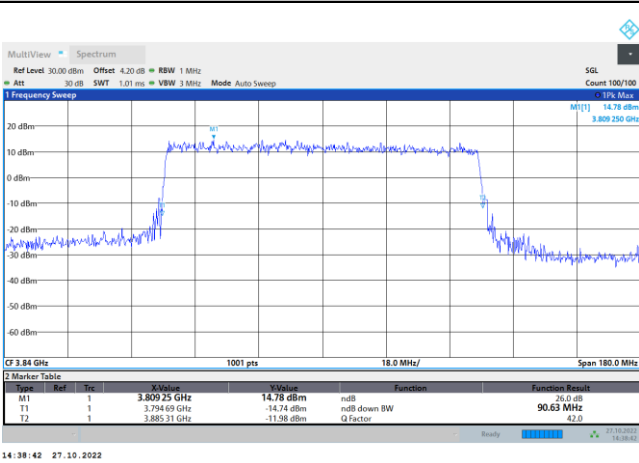

16QAM

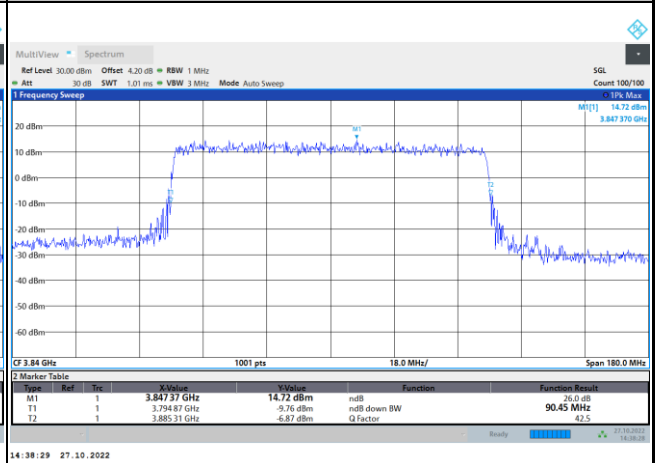

64QAM

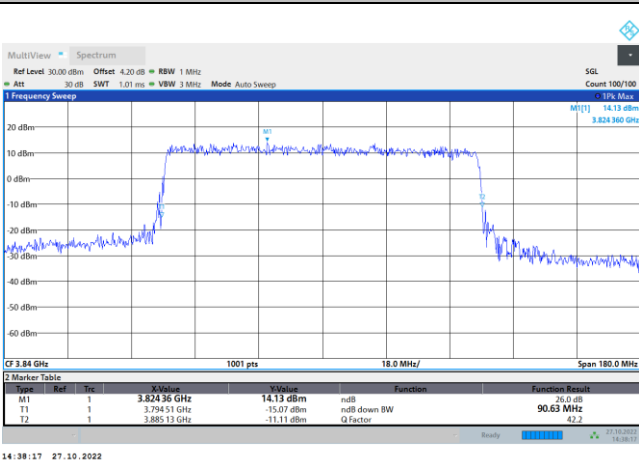

256QAM

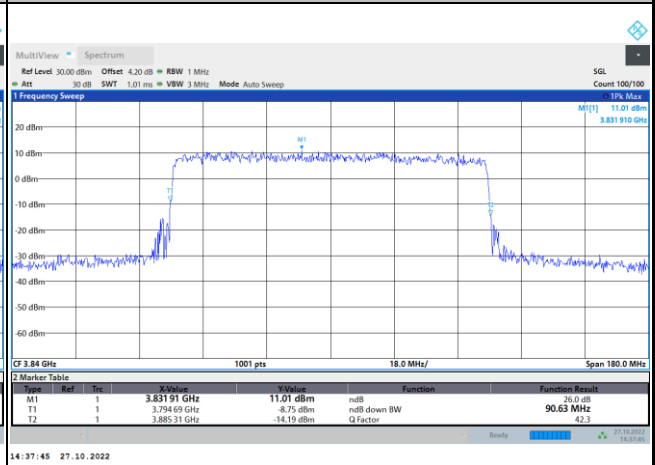



FR1 n77 / 100MHz / DFT-S OFDM / Middle Channel / Full RB

PI/2 BPSK

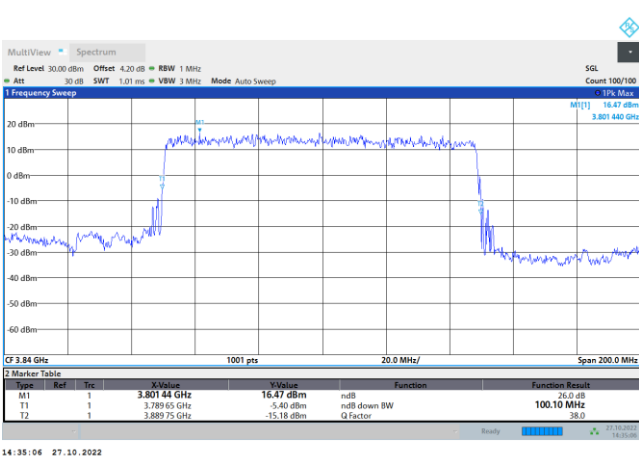

FR1 n77 / 100MHz / CP OFDM / Middle Channel / Full RB

QPSK

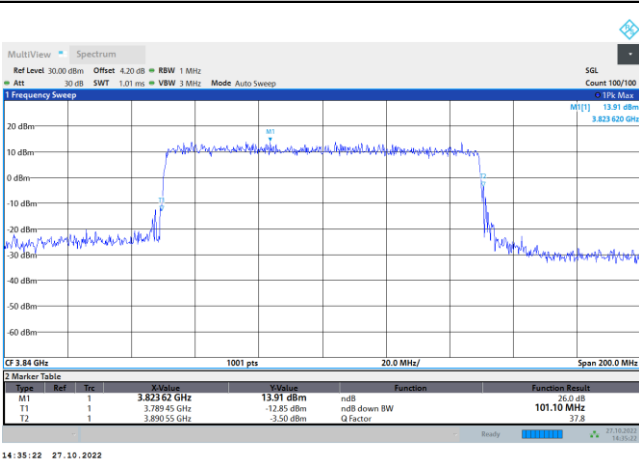

16QAM

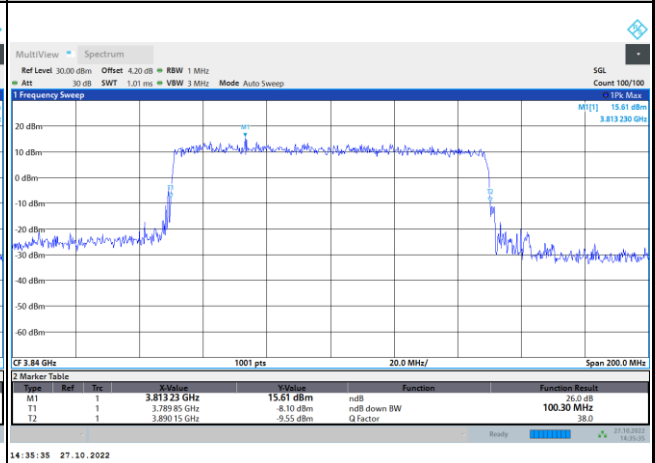

64QAM

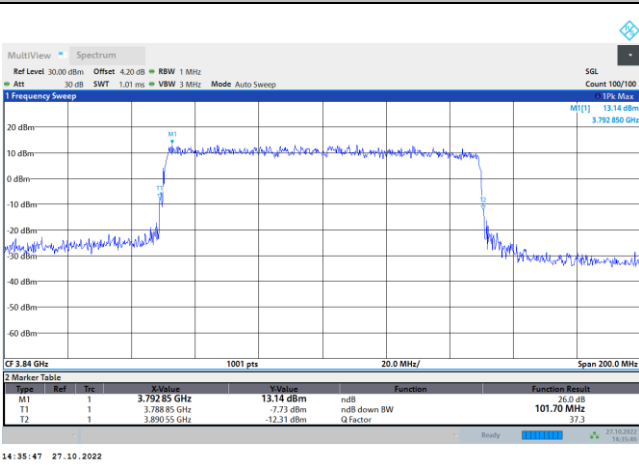

256QAM

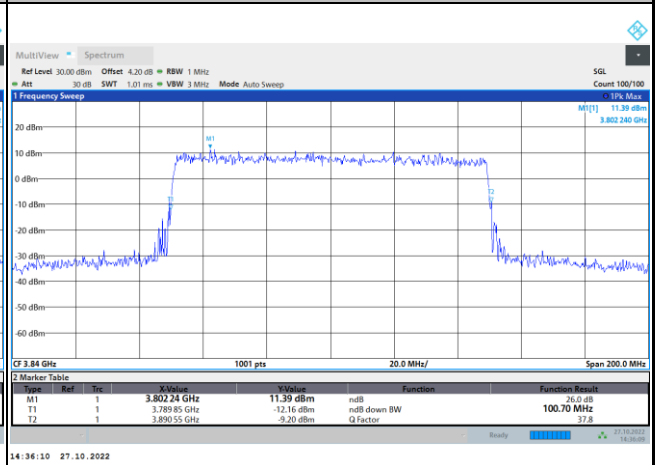



## Occupied Bandwidth

Mode	FR1 n77 : OB BW(MHz) / DFT-S OFDM							
BW	10MHz	15MHz	20MHz	25MHz	30MHz	40MHz	50MHz	60MHz
Mod.	PI/2 BPSK	PI/2 BPSK	PI/2 BPSK	PI/2 BPSK	PI/2 BPSK	PI/2 BPSK	PI/2 BPSK	PI/2 BPSK
Middle CH	8.59	12.94	17.91	22.84	26.77	36.04	45.89	58.02
BW	70MHz	80MHz	90MHz	100MHz				
Mod.	PI/2 BPSK	PI/2 BPSK	PI/2 BPSK	PI/2 BPSK				
Middle CH	64.26	77.33	86.64	96.16				

Mode	FR1 n77 : OB BW(MHz) / CP OFDM							
BW	10MHz		15MHz		20MHz		25MHz	
Mod.	QPSK	16QAM	QPSK	16QAM	QPSK	16QAM	QPSK	16QAM
Middle CH	8.59	8.58	13.63	13.57	18.24	18.22	23.26	23.18
Mod.	64QAM	256QAM	64QAM	256QAM	64QAM	256QAM	64QAM	256QAM
Middle CH	8.59	8.56	13.70	13.62	18.23	18.26	23.23	23.22
BW	30MHz		40MHz		50MHz		60MHz	
Mod.	QPSK	16QAM	QPSK	16QAM	QPSK	16QAM	QPSK	16QAM
Middle CH	27.87	27.82	38.16	38.13	47.45	47.54	57.75	58.00
Mod.	64QAM	256QAM	64QAM	256QAM	64QAM	256QAM	64QAM	256QAM
Middle CH	27.86	27.80	38.13	38.11	47.52	47.58	57.88	57.82
BW	70MHz		80MHz		90MHz		100MHz	
Mod.	QPSK	16QAM	QPSK	16QAM	QPSK	16QAM	QPSK	16QAM
Middle CH	67.44	67.21	77.31	77.44	87.43	87.28	97.25	97.22
Mod.	64QAM	256QAM	64QAM	256QAM	64QAM	256QAM	64QAM	256QAM
Middle CH	67.44	67.37	77.40	77.37	87.48	87.32	97.34	97.15





FR1 n77 / 10MHz / DFT-S OFDM / Middle Channel / Full RB

PI/2 BPSK

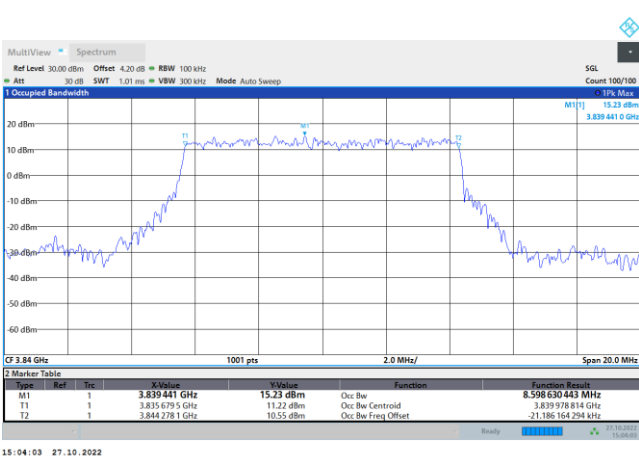

FR1 n77 / 10MHz / CP OFDM / Middle Channel / Full RB

QPSK

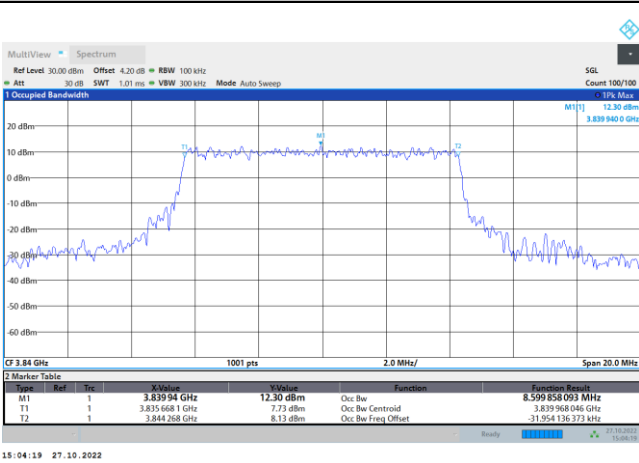

16QAM

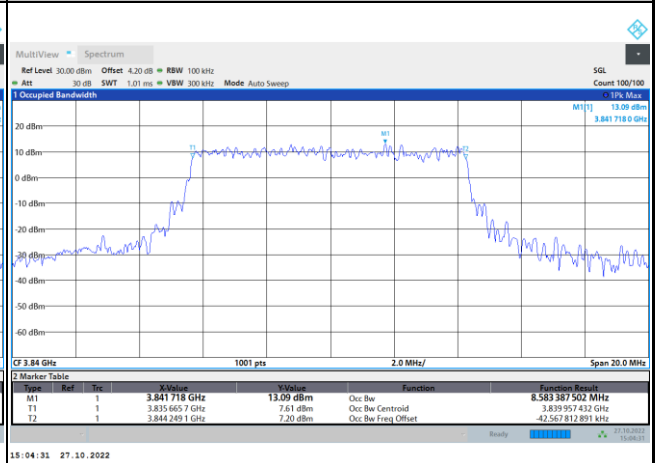

64QAM

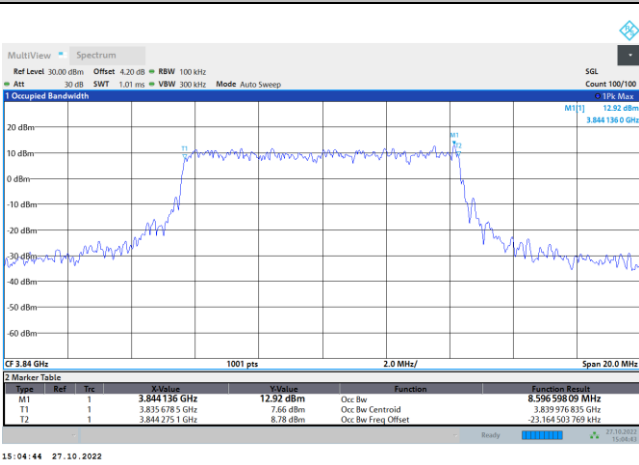

256QAM

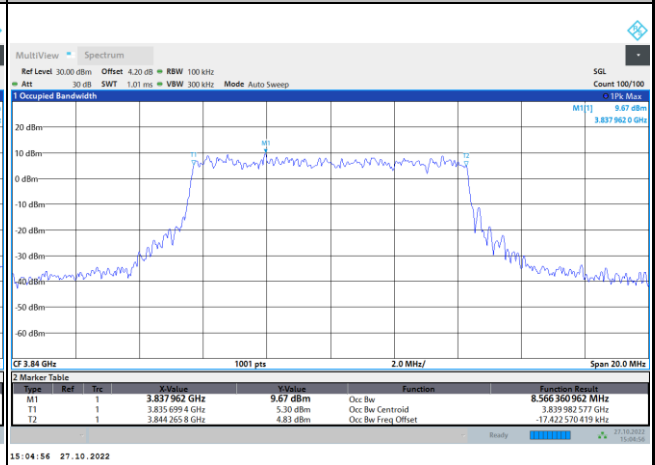



FR1 n77 / 15MHz / DFT-S OFDM / Middle Channel / Full RB

PI/2 BPSK

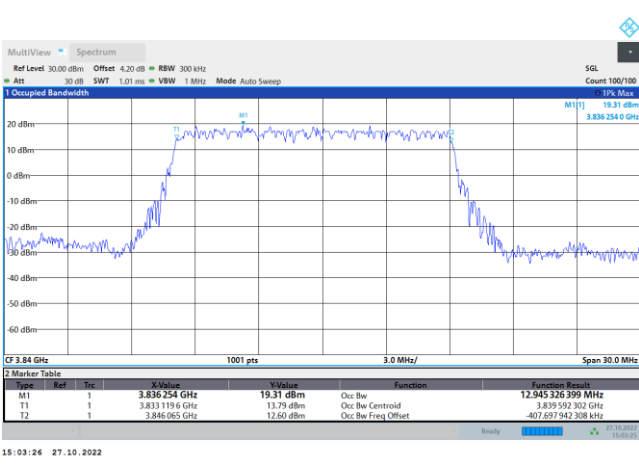

FR1 n77 / 15MHz / CP OFDM / Middle Channel / Full RB

QPSK

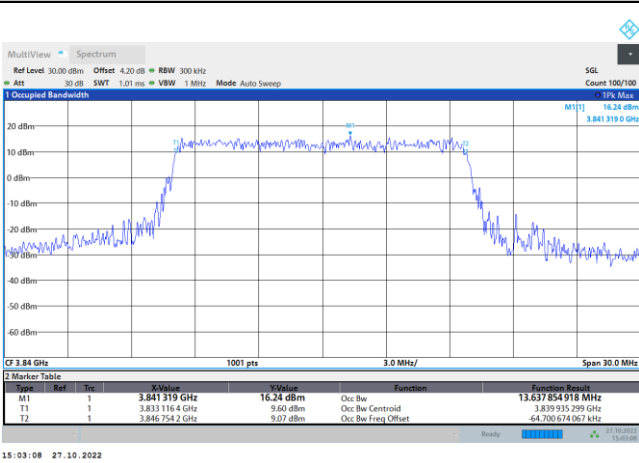

16QAM

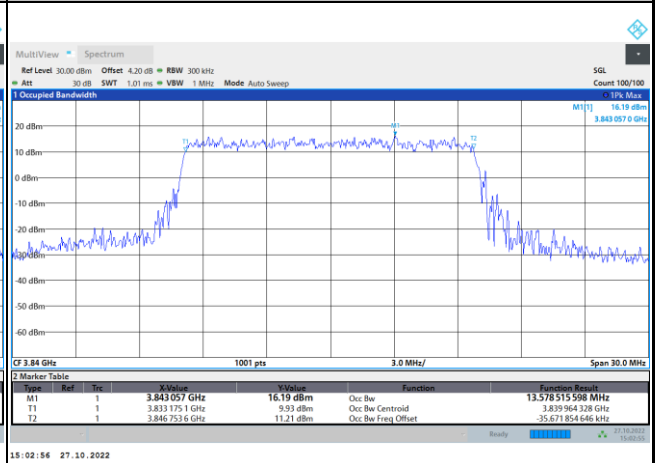

64QAM

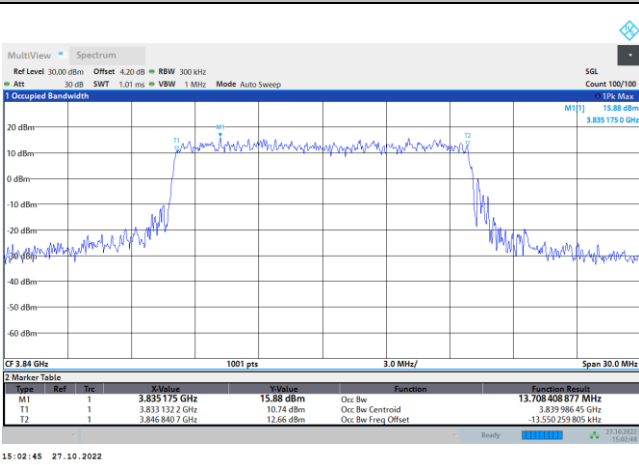

256QAM

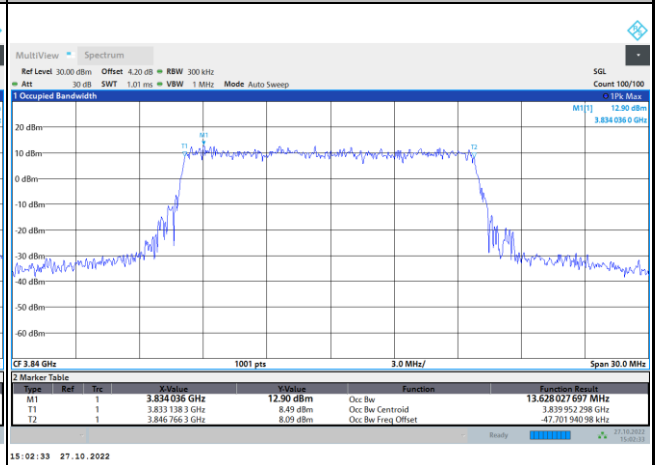



FR1 n77 / 20MHz / DFT-S OFDM / Middle Channel / Full RB

PI/2 BPSK

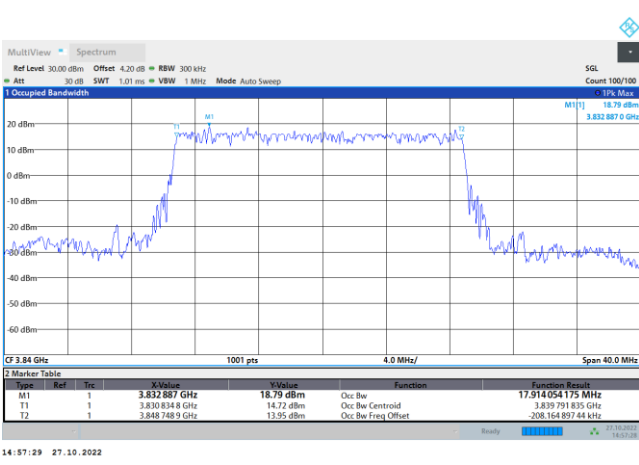

FR1 n77 / 20MHz / CP OFDM / Middle Channel / Full RB

QPSK

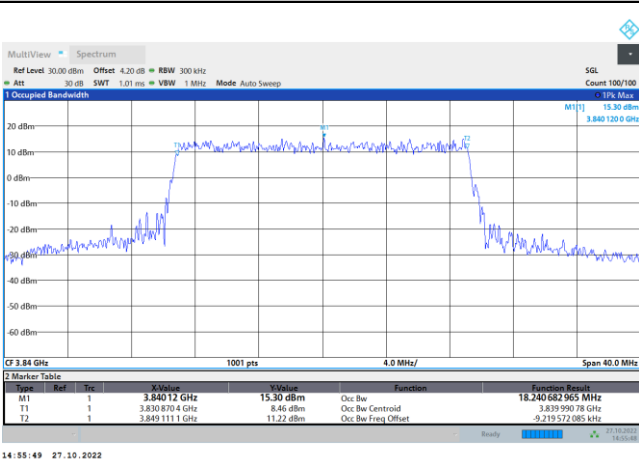

16QAM

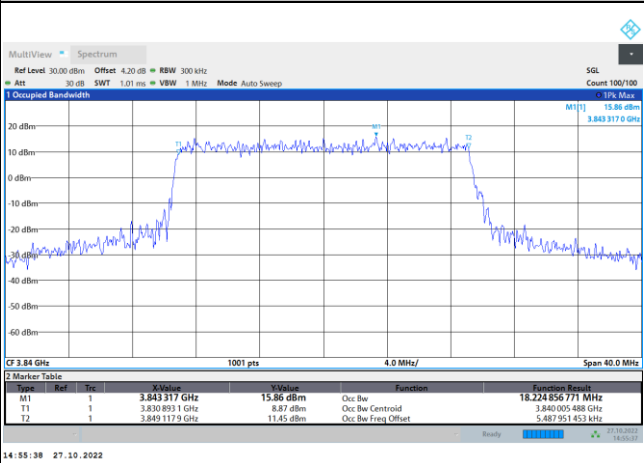

64QAM

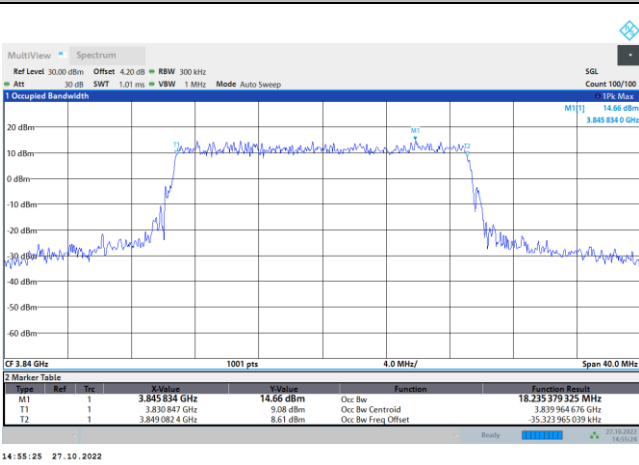

256QAM

