



FCC CO-LOCATION RADIO TEST REPORT

FCC ID : A4RGWKK3
Equipment : Phone
Applicant : Google LLC
1600 Amphitheatre Parkway,
Mountain View, California, 94043 USA
Standard : FCC Part 15 Subpart E §15.407

The product was received on Aug. 02, 2022 and testing was performed from Sep. 02, 2022 to Oct. 05, 2022. We, Sporton International Inc. Wensan Laboratory, would like to declare that the tested sample has been evaluated in accordance with the test procedures and has been in compliance with the applicable technical standards.

The test results in this report apply exclusively to the tested model / sample. Without written approval from Sporton International Inc. Wensan Laboratory, the test report shall not be reproduced except in full.

Louis Wu

Approved by: Louis Wu

Sporton International Inc. Wensan Laboratory

No.58, Aly. 75, Ln. 564, Wenhua 3rd, Rd., Guishan Dist., Taoyuan City 333010, Taiwan (R.O.C.)



Table of Contents

History of this test report.....	3
Summary of Test Result.....	4
1 General Description	5
1.1 Product Feature of Equipment Under Test.....	5
1.2 Product Specification of Equipment Under Test.....	5
1.3 Modification of EUT	6
1.4 Testing Location	6
1.5 Applicable Standards.....	6
2 Test Configuration of Equipment Under Test	7
2.1 Carrier Frequency and Channel	7
2.2 Test Mode.....	7
2.3 Connection Diagram of Test System.....	8
2.4 EUT Operation Test Setup	8
3 Test Result	9
3.1 Unwanted Emissions Measurement.....	9
3.2 Antenna Requirements.....	14
4 List of Measuring Equipment.....	15
5 Uncertainty of Evaluation.....	16
Appendix A. Radiated Spurious Emission	
Appendix B. Radiated Spurious Emission Plots	
Appendix C. Duty Cycle Plots	
Appendix D. Setup Photographs	



History of this test report

Report No.	Version	Description	Issue Date
FR280208-01H	01	Initial issue of report	Nov. 29, 2022



Summary of Test Result

Report Clause	Ref Std. Clause	Test Items	Result (PASS/FAIL)	Remark
3.1	15.407(b)	Unwanted Emissions	Pass	2.44 dB under the limit at 5150.000 MHz
3.2	15.203 15.407(a)	Antenna Requirement	Pass	-

Declaration of Conformity:

1. The test results (PASS/FAIL) with all measurement uncertainty excluded are presented in accordance with the regulation limits or requirements declared by manufacturers. It's means measurement values may risk exceeding the limit of regulation standards, if measurement uncertainty is include in test results.
2. The measurement uncertainty please refer to this report "Uncertainty of Evaluation".

Comments and Explanations:

The product specifications of the EUT presented in the report are declared by the manufacturer who shall take full responsibility for the authenticity.

Reviewed by: William Chen
Report Producer: Ruby Zou



1 General Description

1.1 Product Feature of Equipment Under Test

Product Feature	
Equipment	Phone
FCC ID	A4RGWKK3
EUT supports Radios application	GSM/EGPRS/WCDMA/HSPA/LTE/5G NR/ NFC/GNSS/WPT Client WLAN 11b/g/n HT20 WLAN 11a/n HT20/HT40 WLAN 11ac VHT20/VHT40/VHT80 WLAN 11ax HE20/HE40/HE80 Bluetooth BR/EDR/LE

Remark: The above EUT's information was declared by manufacturer.

EUT Information List	
S/N	Performed Test Item
27221FQHN00000	Radiated Spurious Emission

1.2 Product Specification of Equipment Under Test

Product Specification is subject to this standard			
Tx/Rx Channel Frequency Range	2402 MHz ~ 2480 MHz 5180 MHz ~ 5240 MHz		
Antenna Type / Gain	<Bluetooth> <Ant. 4> : ILA Antenna with gain -1.3 dBi <Ant. 3> : IFA Antenna with gain 0.8 dBi <5150 MHz ~ 5250 MHz> <Ant. 4> : ILA Antenna with gain -3.7 dBi <Ant. 3> : IFA Antenna with gain -3.3 dBi		
Type of Modulation	Bluetooth LE: GFSK 802.11a : OFDM (BPSK / QPSK / 16QAM / 64QAM)		
Antenna Function for Transmitter		Ant. 4	Ant. 3
	Bluetooth-LE	V	-
	802.11 a MIMO	V	V

Remark:

- MIMO Ant. 4+3 is a calculated result from sum of the power MIMO Ant. 4 and MIMO Ant. 3.
- The EUT's information above is declared by manufacturer. Please refer to Comments and Explanations in report summary.



1.3 Modification of EUT

No modifications are made to the EUT during all test items.

1.4 Testing Location

Test Site	Sporton International Inc. Wensan Laboratory
Test Site Location	No.58, Aly. 75, Ln. 564, Wenhua 3rd, Rd., Guishan Dist., Taoyuan City 333010, Taiwan (R.O.C.) TEL: +886-3-327-0868 FAX: +886-3-327-0855
Test Site No.	Sporton Site No. 03CH16-HY

Note: The test site complies with ANSI C63.4 2014 requirement.

FCC designation No.: TW3786

1.5 Applicable Standards

According to the specifications of the manufacturer, the EUT must comply with the requirements of the following standards:

- ♦ FCC Part 15 Subpart E
- ♦ FCC Part 15 Subpart C §15.247
- ♦ FCC KDB Publication No. 558074 D01 15.247 Meas Guidance v05r02
- ♦ FCC KDB 789033 D02 General UNII Test Procedures New Rules v02r01.
- ♦ FCC KDB 414788 D01 Radiated Test Site v01r01.
- ♦ FCC KDB 662911 D01 Multiple Transmitter Output v02r01.
- ♦ ANSI C63.10-2013

Remark:

1. All test items were verified and recorded according to the standards and without any deviation during the test.
2. The TAF code is not including all the FCC KDB listed without accreditation.
3. This EUT has also been tested and complied with the requirements of FCC Part 15, Subpart B, recorded in a separate test report.



2 Test Configuration of Equipment Under Test

The EUT has been associated with peripherals and configuration operated in a manner tended to maximize its emission characteristics in a typical application. Frequency range investigated: radiation emission (9 kHz to the 10th harmonic of the highest fundamental frequency or to 40 GHz, whichever is lower). For radiated measurement, the measured emission level of the EUT was maximized by rotating the EUT on a turntable, adjusting the orientation of the EUT and EUT antenna in three orthogonal axis (X: flat, Y: portrait, Z: landscape) and accessory (Adapter or Earphone), and adjusting the measurement antenna orientation, following C63.10 exploratory test procedures and only the worst case emissions were reported in this report.

2.1 Carrier Frequency and Channel

2400-2483.5 MHz Bluetooth – LE for 2Mbps		5150~5250 MHz 802.11a	
Channel	Freq. (MHz)	Channel	Freq. (MHz)
39	2480	36	5180

2.2 Test Mode

Final test modes are considering the modulation and worse data rates as below table.

<Co-Location>

Test Mode	Modulation	Data Rate
Mode 1	Bluetooth-LE for Ant. 4 + WLAN 5GHz 802.11a for MIMO <Ant. 4+3>	2Mbps + MCS0

Remark:

1. For Radiated Test Cases, the tests were performed with Adapter 1 and USB Cable 2.
2. During the preliminary test, both charging modes (Adapter mode and WPT Client mode) were verified. It is determined that the adaptor mode is the worst case for official test.

2.3 Connection Diagram of Test System

<Co-Location Tx Mode>

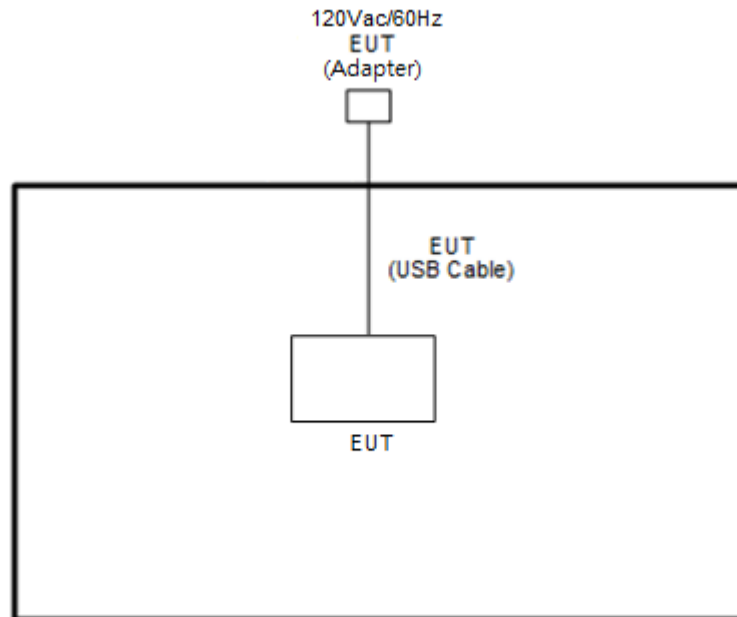

2.4 EUT Operation Test Setup

The RF test items, utility “QRCT4 V4.0.00206” was installed in Notebook which was programmed in order to make the EUT get into the engineering modes to provide channel selection, power level, data rate and the application type and for continuous transmitting signals.



3 Test Result

3.1 Unwanted Emissions Measurement

This section is to measure unwanted emissions through radiated measurement for band edge spurious emissions and out of band emissions measurement.

3.1.1 Limit of Unwanted Emissions

(1) Unwanted spurious emissions fallen in restricted bands shall comply with the general field strength limits as below table:

Frequency (MHz)	Field Strength (microvolts/meter)	Measurement Distance (meters)
0.009 – 0.490	2400/F(kHz)	300
0.490 – 1.705	24000/F(kHz)	30
1.705 – 30.0	30	30
30 – 88	100	3
88 – 216	150	3
216 - 960	200	3
Above 960	500	3

Note: The following formula is used to convert the EIRP to field strength.

$$E = \frac{1000000\sqrt{30P}}{3} \mu\text{V/m, where P is the eirp (Watts)}$$

EIRP (dBm)	Field Strength at 3m (dBμV/m)
- 27	68.3

(2) KDB789033 D02 v02r01 G)2)c)

(i) Sections 15.407(b)(1-3) specifies the unwanted emissions limit for the U-NII-1 and U-NII-2 bands. As specified, emissions above 1000 MHz that are outside of the restricted bands are subject to a peak emission limit of -27 dBm/MHz.

(ii) Section 15.407(b)(4) specifies the unwanted emissions limit for the U-NII-3 band. A band emissions mask is specified in Section 15.407(b)(4)(i). The emission limits are based on the use of a peak detector.



3.1.2 Measuring Instruments

Please refer to the measuring equipment list in this test report.

3.1.3 Test Procedures

1. The testing follows FCC KDB 789033 D02 General UNII Test Procedures New Rules v02r01. Section G) Unwanted emissions measurement.
 - (1) Procedure for Unwanted Emissions Measurements Below 1000MHz
 - RBW = 120 kHz
 - VBW = 300 kHz
 - Detector = Peak
 - Trace mode = max hold
 - (2) Procedure for Peak Unwanted Emissions Measurements Above 1000 MHz
 - RBW = 1 MHz
 - VBW \geq 3 MHz
 - Detector = Peak
 - Sweep time = auto
 - Trace mode = max hold
 - (3) Procedures for Average Unwanted Emissions Measurements Above 1000MHz
 - RBW = 1 MHz
 - VBW = 10 Hz, when duty cycle is no less than 98 percent.
 - VBW \geq 1/T, when duty cycle is less than 98 percent where T is the minimum transmission duration over which the transmitter is on and is transmitting at its maximum power control level for the tested mode of operation.
2. The EUT is placed on a turntable with 0.8 meter for frequency below 1 GHz and 1.5 meter for frequency above 1 GHz respectively above ground.
3. The EUT is set 3 meters away from the receiving antenna which is mounted on the top of a variable height antenna tower.
4. The antenna is a broadband antenna and its height is adjusted between one meter and four meters above ground to find the maximum value of the field strength for both horizontal polarization and vertical polarization of the antenna.
5. For each suspected emission, the EUT is arranged to its worst case and then adjust the antenna tower (from 1 m to 4 m) and turntable (from 0 degree to 360 degrees) to find the maximum reading.

6. Radiated testing below 1 GHz is performed by adjusting the antenna tower from 1 m to 4 m and by rotating the turn table from 0 degree to 360 degrees to find the peak maximum hold reading. When there is no suspected emission found and the emission level is with at least 6 dB margin against QP limit line, the position is marked as “-”.
7. Radiated testing above 1 GHz is performed by adjusting the antenna tower from 1 m to 4 m and by rotating the turn table from 0 degree to 360 degrees to find the peak maximum hold reading for scanning all frequencies. When there is no suspected emission found and the harmonic emission level is with at least 6 dB margin against average limit line, the position is marked as “-”.

3.1.4 Test Setup

For radiated emissions below 30MHz

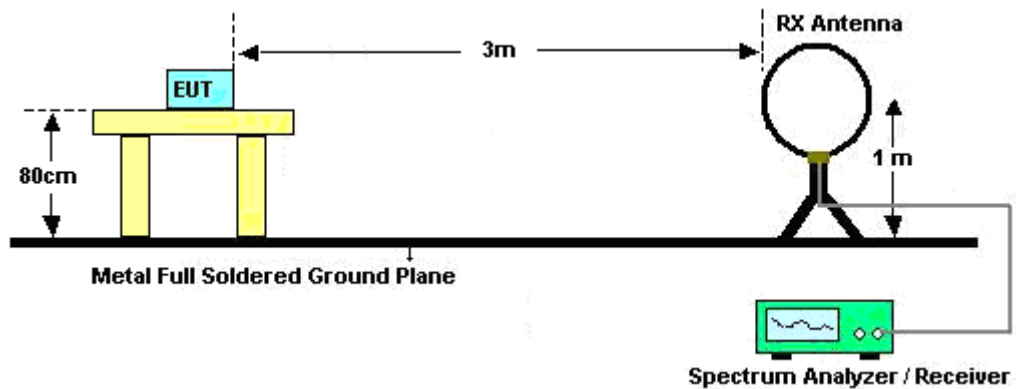

For radiated emissions from 30MHz to 1GHz

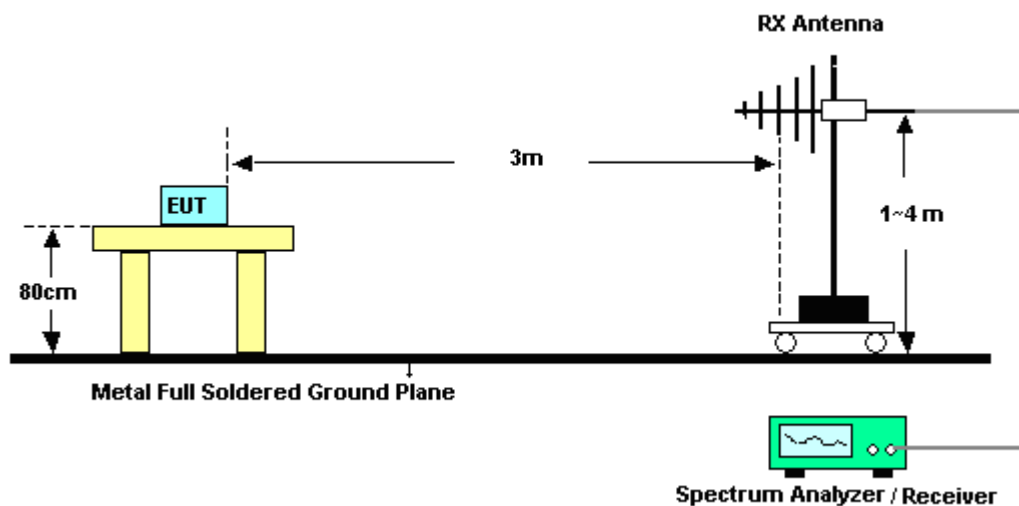

For radiated test from 1GHz to 18GHz

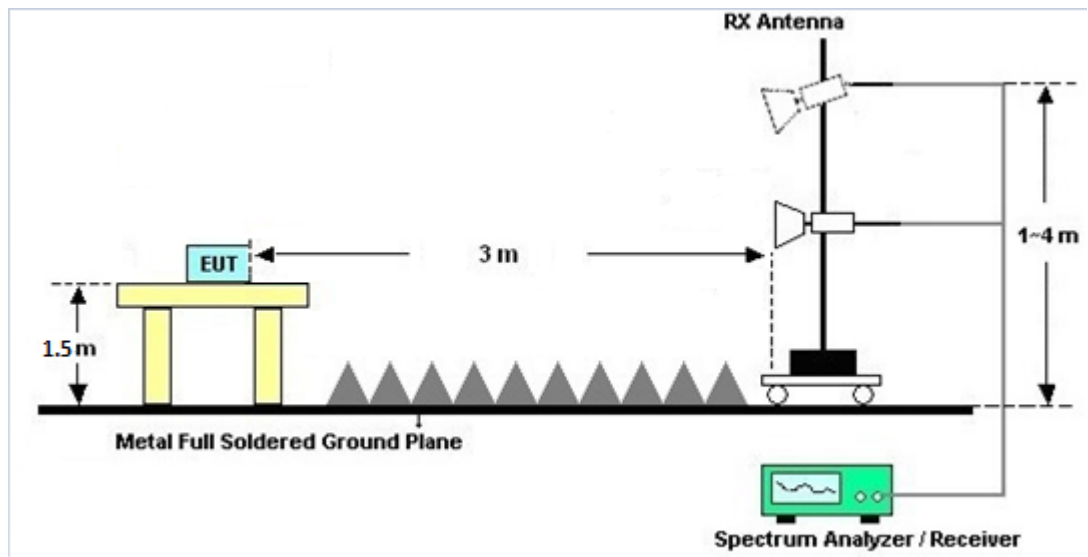

For radiated test above 18GHz

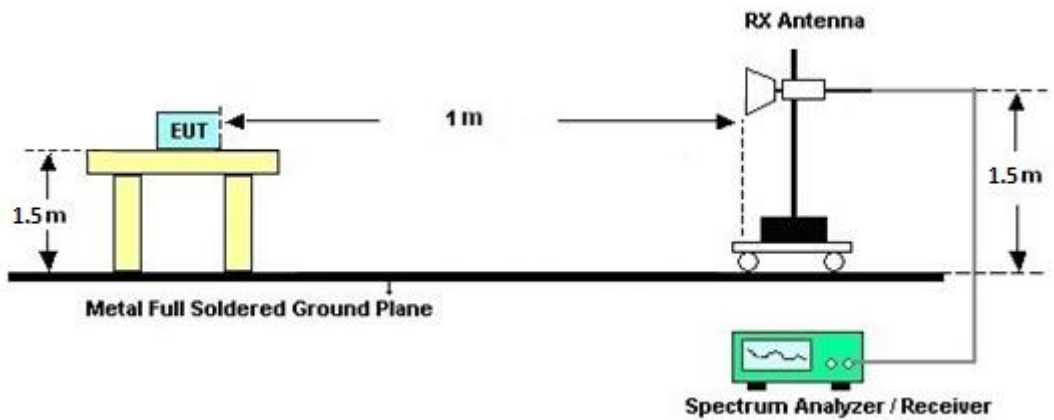



3.1.5 Test Results of Radiated Spurious Emissions (9 kHz ~ 30 MHz)

The low frequency, which started from 9 kHz to 30MHz, was pre-scanned and the result which was 20dB lower than the limit line was not reported.

There is adequate comparison measurement of both open-field test site and alternative test site - semi-Anechoic chamber according to 414788 D01 Radiated Test Site v01r01, and the result came out very similar.

3.1.6 Test Result of Radiated Spurious at Band Edges

Please refer to Appendix A and B.

3.1.7 Duty Cycle

Please refer to Appendix C.

3.1.8 Test Result of Radiated Spurious Emissions (30MHz ~ 10th Harmonic)

Please refer to Appendix A and B.



3.2 Antenna Requirements

3.2.1 Standard Applicable

< Bluetooth-LE and WLAN 5GHz >

The use of a permanently attached antenna or of an antenna that uses a unique coupling to the intentional radiator shall be considered sufficient to comply with the rule.

3.2.2 Antenna Anti-Replacement Construction

An embedded-in antenna design is used.



4 List of Measuring Equipment

Instrument	Brand Name	Model No.	Serial No.	Characteristics	Calibration Date	Test Date	Due Date	Remark
Loop Antenna	Rohde & Schwarz	HFH2-Z2	100488	9 kHz~30 MHz	May 13, 2022	Sep. 02, 2022~ Oct. 05, 2022	May 12, 2023	Radiation (03CH16-HY)
Preamplifier	EMEC	EM18G40G	060801	18GHz~40GHz	Jun. 28, 2022	Sep. 02, 2022~ Oct. 05, 2022	Jun. 27, 2023	Radiation (03CH16-HY)
SHF-EHF Horn Antenna	SCHWARZBECK	BBHA9170	00993	18GHz-40GHz	Nov. 30, 2021	Sep. 02, 2022~ Oct. 05, 2022	Nov. 29, 2022	Radiation (03CH16-HY)
Horn Antenna	SCHWARZBECK	BBHA 9120 D	9120D-1522	1GHz~18GHz	Mar. 10, 2022	Sep. 02, 2022~ Oct. 05, 2022	Mar. 09, 2023	Radiation (03CH16-HY)
Bilog Antenna	TESEQ	CBL 6111D & 00802N1D01N -06	47020 & 06	30MHz~1GHz	Oct. 09, 2021	Sep. 02, 2022~ Oct. 05, 2022	Oct. 08, 2022	Radiation (03CH16-HY)
Controller	EMEC	EM1000	N/A	Control Turn table & Ant Mast	N/A	Sep. 02, 2022~ Oct. 05, 2022	N/A	Radiation (03CH16-HY)
Antenna Mast	EMEC	AM-BS-4500-B	N/A	1m~4m	N/A	Sep. 02, 2022~ Oct. 05, 2022	N/A	Radiation (03CH16-HY)
Turn Table	EMEC	TT2000	N/A	0~360 Degree	N/A	Sep. 02, 2022~ Oct. 05, 2022	N/A	Radiation (03CH16-HY)
EMI Test Receiver	Keysight	N9038A(MXE)	MY57290111	3Hz~26.5GHz	Dec. 15, 2021	Sep. 02, 2022~ Oct. 05, 2022	Dec. 14, 2022	Radiation (03CH16-HY)
Software	Audix	E3 6.2009-8-24	RK-001136	N/A	N/A	Sep. 02, 2022~ Oct. 05, 2022	N/A	Radiation (03CH16-HY)
RF Cable	HUBER + SUHNER	SUCOFLEX 104	805935/4	N/A	Aug. 09, 2022	Sep. 02, 2022~ Oct. 05, 2022	Aug. 08, 2023	Radiation (03CH16-HY)
RF Cable	HUBER + SUHNER	SUCOFLEX 104	802434/4	N/A	Aug. 09, 2022	Sep. 02, 2022~ Oct. 05, 2022	Aug. 08, 2023	Radiation (03CH16-HY)
RF Cable	HUBER + SUHNER	SUCOFLEX 102	EC-A5-300-5 757	N/A	Aug. 09, 2022	Sep. 02, 2022~ Oct. 05, 2022	Aug. 08, 2023	Radiation (03CH16-HY)
Amplifier	SONOMA	310N	371607	9kHz~1GHz	Jul. 04, 2022	Sep. 02, 2022~ Oct. 05, 2022	Jul. 03, 2023	Radiation (03CH16-HY)
Preamplifier	EMEC	EM1G18G	060812	1GHz~18GHz	Dec. 27, 2021	Sep. 02, 2022~ Oct. 05, 2022	Dec. 26, 2022	Radiation (03CH16-HY)
Preamplifier	Keysight	83017A	MY53270264	1GHz~26.5GHz	Dec. 09, 2021	Sep. 02, 2022~ Oct. 05, 2022	Dec. 08, 2022	Radiation (03CH16-HY)



5 Uncertainty of Evaluation

Uncertainty of Radiated Emission Measurement (30 MHz ~ 1000 MHz)

Measuring Uncertainty for a Level of Confidence of 95% ($U = 2Uc(y)$)	5.8 dB
---	--------

Uncertainty of Radiated Emission Measurement (1000 MHz ~ 18000 MHz)

Measuring Uncertainty for a Level of Confidence of 95% ($U = 2Uc(y)$)	5.2 dB
---	--------

Uncertainty of Radiated Emission Measurement (18000 MHz ~ 40000 MHz)

Measuring Uncertainty for a Level of Confidence of 95% ($U = 2Uc(y)$)	5.8 dB
---	--------



Appendix A. Radiated Spurious Emission

Test Engineer :	Andy Yang, Karl Hou and Steven Wu	Temperature :	15~25°C
		Relative Humidity :	50~65%

2.4GHz 2402~2480MHz + Band 1 - 5150~5250MHz

Ant. 4_BLE_CH39 (Band Edge @ 3m)

BLE Ant.	Note	Frequency (MHz)	Level (dBμV/m)	Margin (dB)	Limit Line (dBμV/m)	Read Level (dBμV)	Antenna Factor (dB/m)	Path Loss (dB)	Preamp Factor (dB)	Ant Pos (cm)	Table Pos (deg)	Peak Avg. (P/A)	Pol. (H/V)
BLE CH 39 2480MHz	*	2480	115.76	-	-	100.49	27.82	17.5	30.05	103	243	P	H
	*	2480	114.39	-	-	99.12	27.82	17.5	30.05	103	243	P	H
		2483.56	60.07	-13.93	74	44.77	27.83	17.51	30.04	103	243	P	H
		2483.52	49.53	-4.47	54	34.23	27.83	17.51	30.04	103	243	A	H
												P	H
												A	H
	*	2480	110.47	-	-	95.2	27.82	17.5	30.05	400	76	P	V
	*	2480	109.19	-	-	93.92	27.82	17.5	30.05	400	76	P	V
		2485.2	57.16	-16.84	74	41.85	27.84	17.51	30.04	400	76	P	V
		2495	47.65	-6.35	54	32.29	27.88	17.52	30.04	400	76	A	V
												P	V
												A	V



2.4GHz 2402~2480MHz + Band 1 - 5150~5250MHz
MIMO <Ant. 4+3>_WIFI 802.11a_CH36 (Band Edge @ 3m)

WIFI	Note	Frequency	Level	Margin	Limit	Read	Antenna	Path	Preamp	Ant	Table	Peak	Pol.	
Ant.					Line	Level	Factor	Loss	Factor	Pos	Pos	Avg.		
4+3		(MHz)	(dBμV/m)	(dB)	(dBμV/m)	(dBμV)	(dB/m)	(dB)	(dB)	(cm)	(deg)	(P/A)	(H/V)	
802.11a CH 36 5180MHz		5150	60.18	-13.82	74	45.68	33	10.96	29.46	100	233	P	H	
		5150	51.56	-2.44	54	37.06	33	10.96	29.46	100	233	A	H	
	*	5180	111.39	-	-	96.84	33.06	10.96	29.47	100	233	P	H	
	*	5180	104.04	-	-	89.49	33.06	10.96	29.47	100	233	A	H	
												P	H	
												A	H	
			5150	58.37	-15.63	74	43.87	33	10.96	29.46	300	76	P	V
			5150	49.69	-4.31	54	35.19	33	10.96	29.46	300	76	A	V
	*		5180	108.3	-	-	93.75	33.06	10.96	29.47	300	76	P	V
	*		5180	100.77	-	-	86.22	33.06	10.96	29.47	300	76	A	V
													P	V
													A	V
Remark	1. No other spurious found. 2. All results are PASS against Peak and Average limit line.													



Ant. 4_BLE CH 39 + MIMO <Ant. 4+3>_WIFI 802.11a_CH36 (Harmonic @ 3 m)

WIFI Ant. Simultaneously	Note	Frequency (MHz)	Level (dBμV/m)	Margin (dB)	Limit Line (dBμV/m)	Read Level (dBμV)	Antenna Factor (dB/m)	Path Loss (dB)	Preamp Factor (dB)	Ant Pos (cm)	Table Pos (deg)	Peak Avg. (P/A)	Pol. (H/V)	
BLE CH 39 2480MHz + 802.11a CH 36 5180MHz		4960	57.26	-16.74	74	40.32	33.02	13.33	29.41	-	-	P	H	
		4960	46.75	-7.25	54	29.81	33.02	13.33	29.41	-	-	A	H	
		7440	45.08	-28.92	74	60.55	36.46	13.86	65.79	-	-	P	H	
		10360	47.47	-20.73	68.2	59.19	38.92	16.08	66.72	-	-	P	H	
		15540	47.6	-26.4	74	55.77	37.92	20.04	66.13	-	-	P	H	
														H
														H
														H
														H
														H
			4960	56.12	-17.88	74	39.18	33.02	13.33	29.41	-	-	P	V
			4960	46.62	-7.38	54	29.68	33.02	13.33	29.41	-	-	A	V
			7440	50.46	-23.54	74	65.93	36.46	13.86	65.79	100	298	P	V
			7440	44.92	-9.08	54	60.39	36.46	13.86	65.79	100	298	A	V
			10360	48.16	-20.04	68.2	59.88	38.92	16.08	66.72	-	-	P	V
			15540	47.56	-26.44	74	55.73	37.92	20.04	66.13	-	-	P	V
														V
														V
													V	
													V	
													V	
													V	
Remark	<ol style="list-style-type: none"> No other spurious found. All results are PASS against Peak and Average limit line. The emission position marked as "-" means no suspected emission found with sufficient margin against limit line or noise floor only. 													



Note symbol

*	Fundamental Frequency which can be ignored. However, the level of any unwanted emissions shall not exceed the level of the fundamental frequency.
-	The signal is Unintentional Radiators .
P/A	Peak or Average
H/V	Horizontal or Vertical



A calculation example for radiated spurious emission is shown as below:

WIFI	Note	Frequency	Level	Margin	Limit	Read	Antenna	Path	Preamp	Ant	Table	Peak	Pol.
Ant.					Line	Level	Factor	Loss	Factor	Pos	Pos	Avg.	
Simultaneously		(MHz)	(dBμV/m)	(dB)	(dBμV/m)	(dBμV)	(dB/m)	(dB)	(dB)	(cm)	(deg)	(P/A)	(H/V)
802.11b		2390	55.45	-18.55	74	54.51	32.22	4.58	35.86	103	308	P	H
CH 01													
2412MHz		2390	43.54	-10.46	54	42.6	32.22	4.58	35.86	103	308	A	H

1. Path Loss(dB) = Cable loss(dB) + Filter loss(dB) + Attenuator loss(dB)
2. Level(dBμV/m) = Antenna Factor(dB/m) + Path Loss(dB) + Read Level(dBμV) - Preamp Factor(dB)
3. Margin(dB) = Level(dBμV/m) – Limit Line(dBμV/m)

For Peak Limit @ 2390MHz:

1. Level(dBμV/m)
= Antenna Factor(dB/m) + Path Loss(dB) + Read Level(dBμV) - Preamp Factor(dB)
= 32.22(dB/m) + 4.58(dB) + 54.51(dBμV) – 35.86 (dB)
= 55.45 (dBμV/m)
2. Margin(dB)
= Level(dBμV/m) – Limit Line(dBμV/m)
= 55.45(dBμV/m) – 74(dBμV/m)
= -18.55(dB)

For Average Limit @ 2390MHz:

1. Level(dBμV/m)
= Antenna Factor(dB/m) + Path Loss(dB) + Read Level(dBμV) - Preamp Factor(dB)
= 32.22(dB/m) + 4.58(dB) + 42.6(dBμV) – 35.86 (dB)
= 43.54 (dBμV/m)
2. Margin(dB) = Level(dBμV/m) – Limit Line(dBμV/m)
= 43.54(dBμV/m) – 54(dBμV/m)
= -10.46(dB)

Both peak and average measured complies with the limit line, so test result is “PASS”.



Appendix B. Radiated Spurious Emission Plots

Test Engineer :	Andy Yang, Karl Hou and Steven Wu	Temperature :	15~25°C
		Relative Humidity :	50~65%



2.4GHz 2402~2480MHz + Band 1 - 5150~5250MHz

Ant. 4_BLE_CH39 (Band Edge @ 3m)

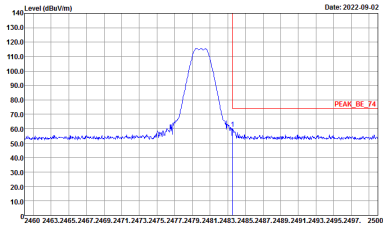
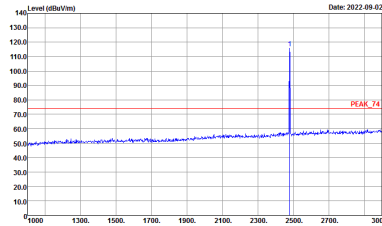
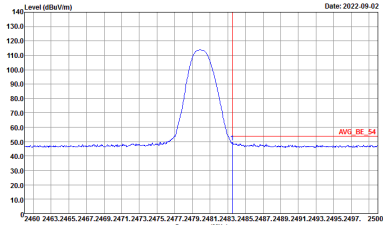
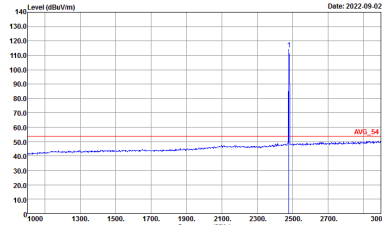
BLE	2.4GHz 2400~2483.5MHz Band Edge @ 3m	
ANT	BLE_CH39 2480MHz	
4	Horizontal	Fundamental
Peak	 <p>Date: 2022-09-02</p> <p>Site : 03CH16-HY Condition : PEAK_BE_74 3m 9120D_1522_220310 HORIZONTAL : RBW:1000.000KHz VBW:3000.000KHz SWT:Auto</p>	 <p>Date: 2022-09-02</p> <p>Site : 03CH16-HY Condition : PEAK_74 3m 9120D_1522_220310 HORIZONTAL : RBW:1000.000KHz VBW:3000.000KHz SWT:Auto</p>
Avg.	 <p>Date: 2022-09-02</p> <p>Site : 03CH16-HY Condition : AVG_BE_54 3m 9120D_1522_220310 HORIZONTAL : RBW:1000.000KHz VBW:10.000KHz SWT:Auto</p>	 <p>Date: 2022-09-02</p> <p>Site : 03CH16-HY Condition : AVG_54 3m 9120D_1522_220310 HORIZONTAL : RBW:1000.000KHz VBW:10.000KHz SWT:Auto</p>

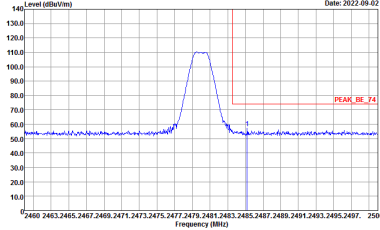
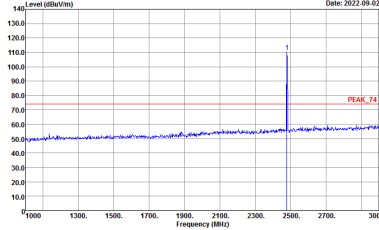
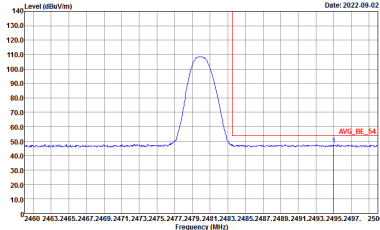
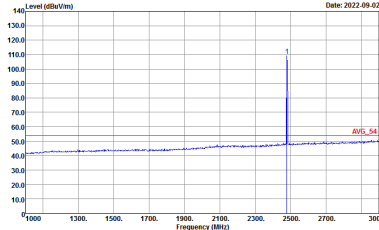

BLE	2.4GHz 2400~2483.5MHz Band Edge @ 3m	
ANT	BLE_CH39 2480MHz	
4	Vertical	Fundamental
Peak	 <p>Site : 03CH16-HY Condition : PEAK_BE_74 3m 9120D_1522_220310 VERTICAL : RBW:1000.000KHz VBW:3000.000KHz SWT:Auto</p>	 <p>Site : 03CH16-HY Condition : PEAK_74 3m 9120D_1522_220310 VERTICAL : RBW:1000.000KHz VBW:3000.000KHz SWT:Auto</p>
Avg.	 <p>Site : 03CH16-HY Condition : AVG_BE_54 3m 9120D_1522_220310 VERTICAL : RBW:1000.000KHz VBW:10.000KHz SWT:Auto</p>	 <p>Site : 03CH16-HY Condition : AVG_54 3m 9120D_1522_220310 VERTICAL : RBW:1000.000KHz VBW:10.000KHz SWT:Auto</p>

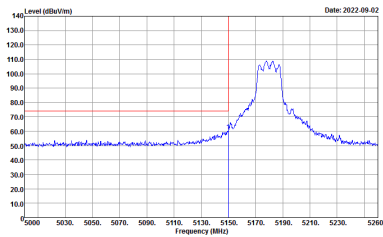
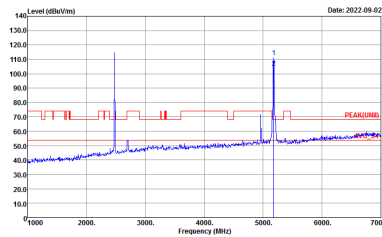
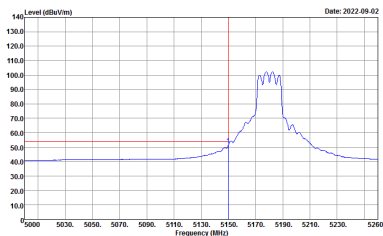

MIMO Ant. <4+3>_WIFI 802.11a_CH36 (Band Edge @ 3m)

WIFI	5150~5250MHz Band Edge @ 3m	
ANT	802.11a CH36 5180MHz	
4+3	Horizontal	Fundamental
Peak	 <p>Site : 03CH16-HY Condition : PEAK_BE_74 3m 91200_1522_220310 HORIZONTAL : RBW:1000.000KHz VBW:3000.000KHz SWT:Auto</p>	 <p>Site : 03CH16-HY Condition : PEAK(LINE) 3m 91200_1522_220310 HORIZONTAL : RBW:1000.000KHz VBW:3000.000KHz SWT:Auto</p>
Avg.	 <p>Site : 03CH16-HY Condition : AVG_BE_54 3m 91200_1522_220310 HORIZONTAL : RBW:1000.000KHz VBW:0.010KHz SWT:Auto</p>	Left blank



WIFI	5150~5250MHz Band Edge @ 3m	
ANT	802.11a CH36 5180MHz	
4+3	Vertical	Fundamental
Peak	<p>Site : 03CH16-HY Condition : PEAK_BE_74 3m 91200_1522_220310 VERTICAL : RBW:1000.000KHz VBW:3000.000KHz SWT:Auto</p>	<p>Site : 03CH16-HY Condition : PEAK(LINE1) 3m 91200_1522_220310 VERTICAL : RBW:1000.000KHz VBW:3000.000KHz SWT:Auto</p>
Avg.	<p>Site : 03CH16-HY Condition : AVG_BE_54 3m 91200_1522_220310 VERTICAL : RBW:1000.000KHz VBW:0.010KHz SWT:Auto</p>	Left blank

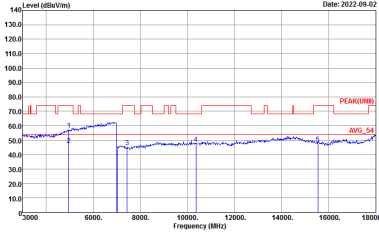
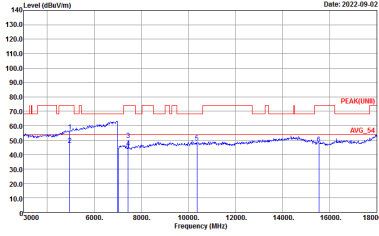

Ant. 4_BLE CH 39 + MIMO <Ant. 4+3>_WIFI 802.11a_CH36 (Harmonic @ 3m)

ANT	BLE_CH39 2480MHZ + 802.11a_CH36 5180MHZ	
Simultaneously	Horizontal	Vertical
<p>Peak Avg.</p>	 <p>Site : 03CH16-HY Condition : PEAK(UNI) 3m 91200_1522_220310 HORIZONTAL Detector : Peak</p>	 <p>Site : 03CH16-HY Condition : PEAK(UNI) 3m 91200_1522_220310 VERTICAL Detector : Peak</p>



Appendix C. Duty Cycle Plots

Antenna	Band	Duty Cycle(%)	T(us)	1/T(kHz)	VBW Setting
4	Bluetooth – LE for 2 Mbps	32.59	204	4.90	10kHz
4+3	802.11a	99.05	-	-	10Hz

<Ant. 4>

MIMO <Ant. 4+3>

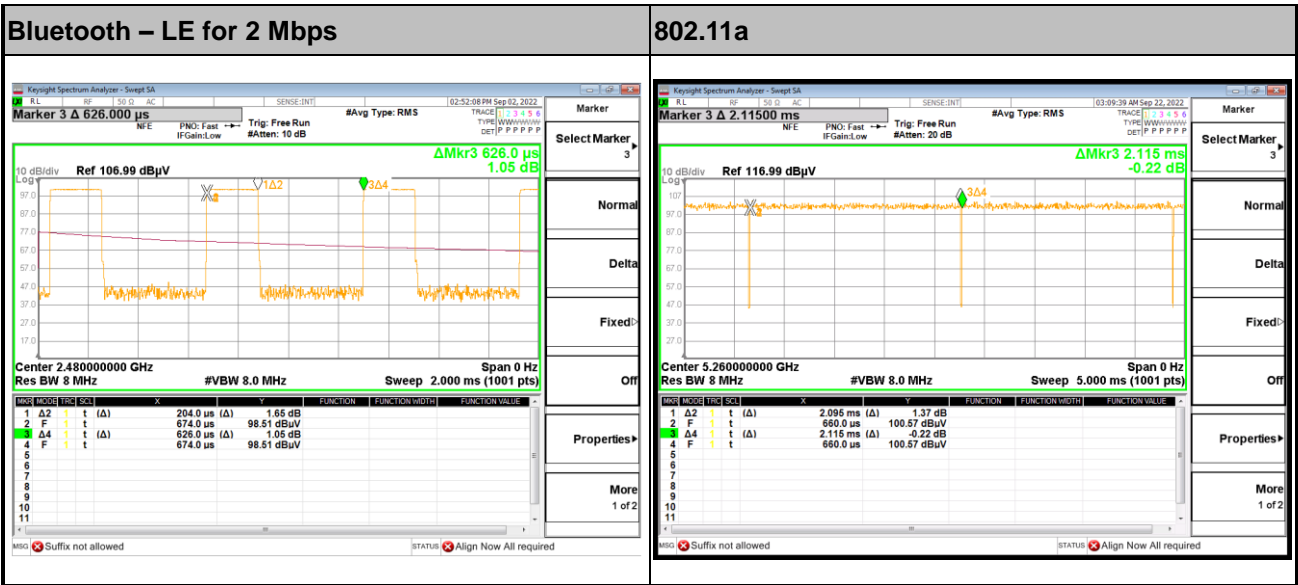

— THE END —