

**LTE BAND 12 EMISSION MASK**

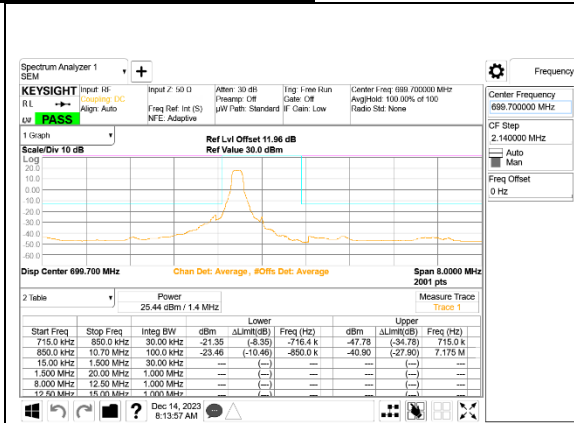

LTE B12 1.4MHz QPSK Low Channel RB1-0, ID:25780

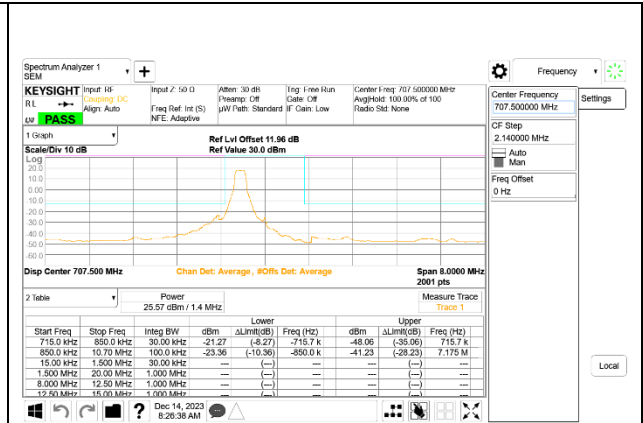

LTE B12 1.4MHz QPSK Middle Channel RB1-0, ID:25780

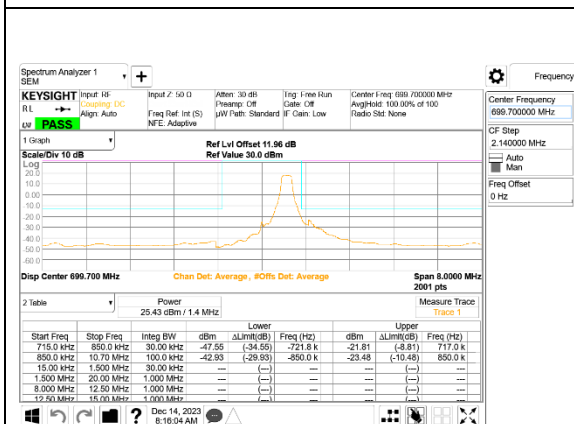

LTE B12 1.4MHz QPSK Low Channel RB1-5, ID:25780

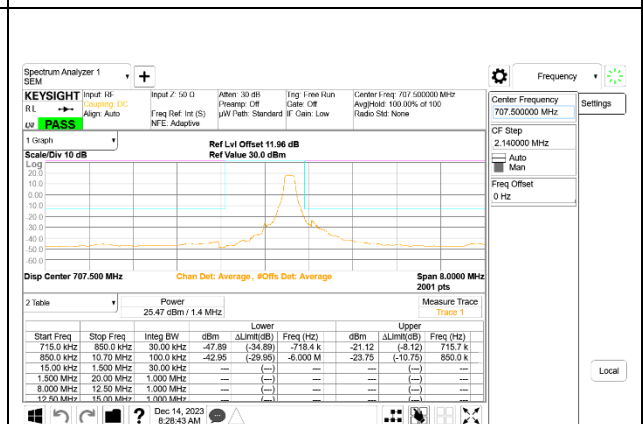

LTE B12 1.4MHz QPSK Middle Channel RB1-5, ID:25780

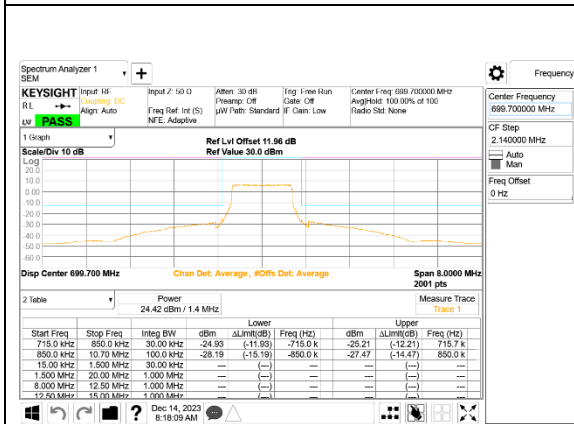

LTE B12 1.4MHz QPSK Low Channel RB6-0, ID:25780

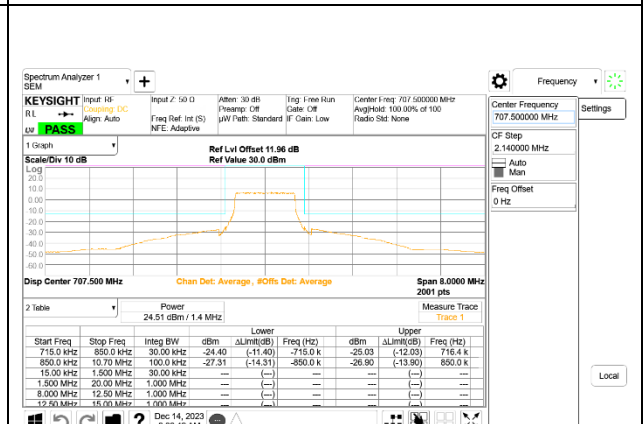

LTE B12 1.4MHz QPSK Middle Channel RB6-0, ID:25780

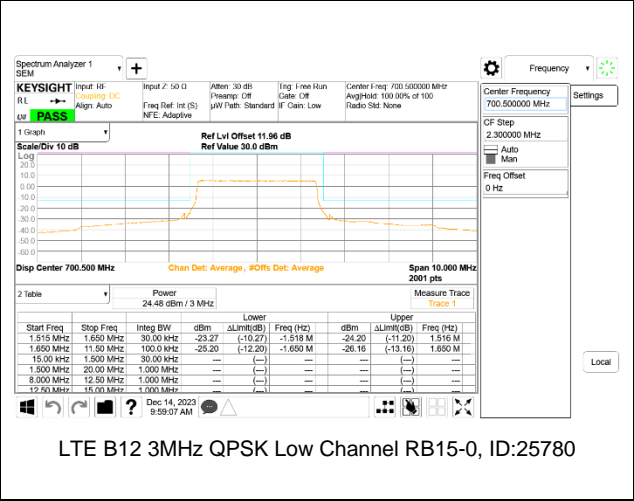
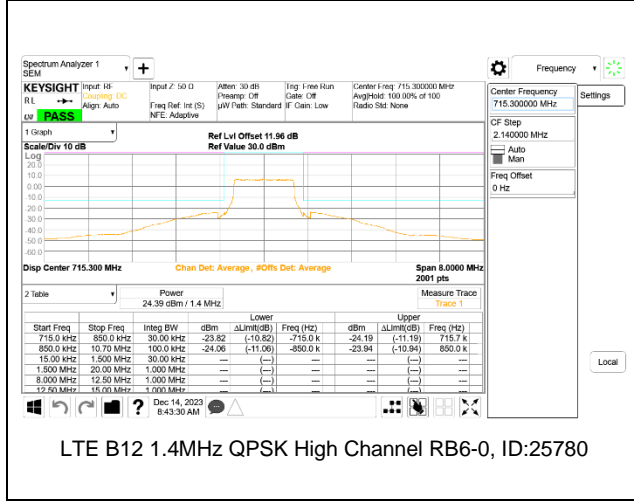
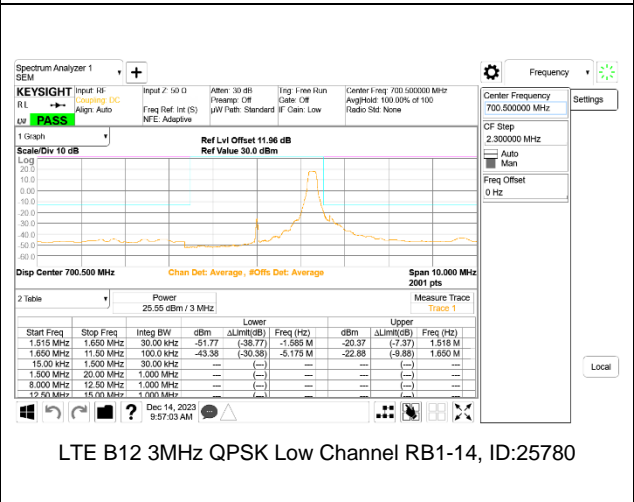
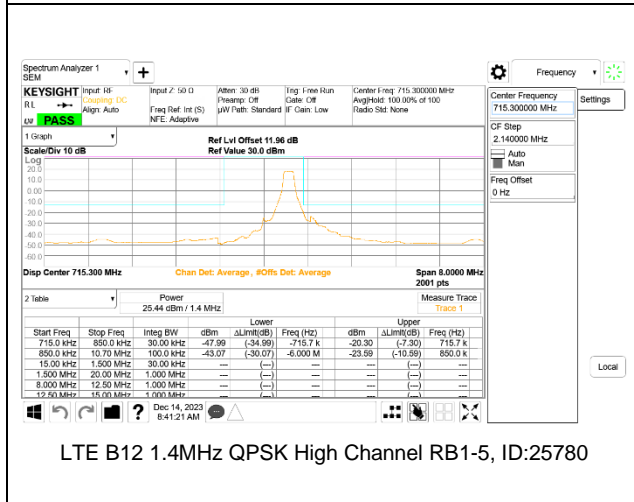
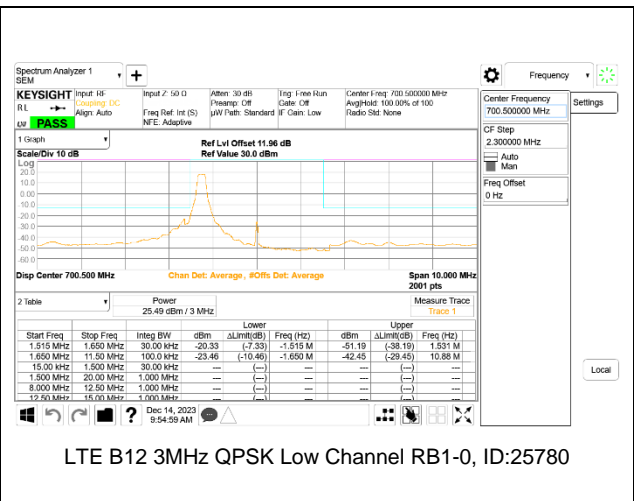
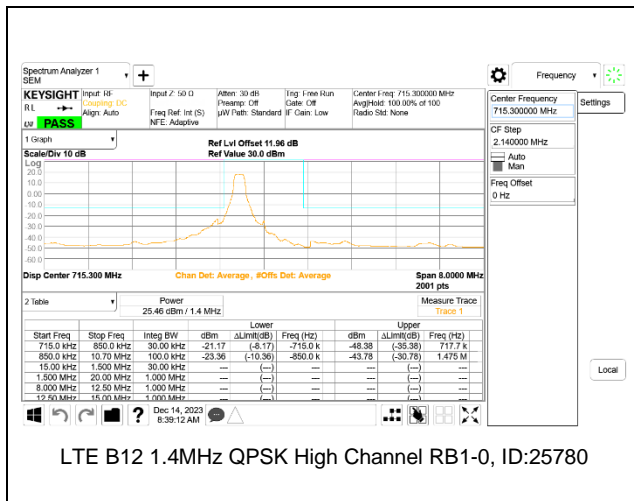

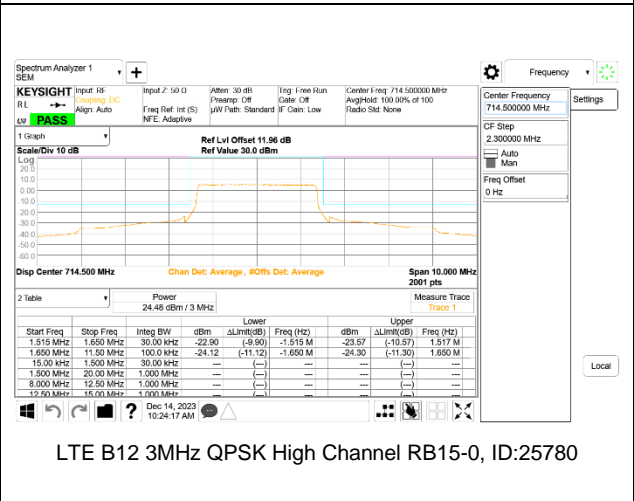
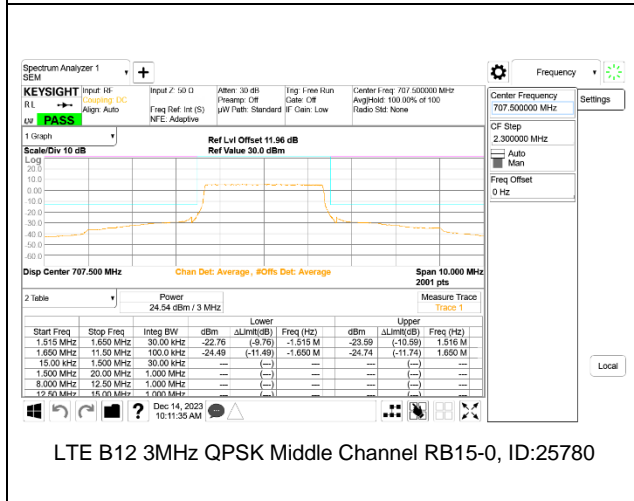
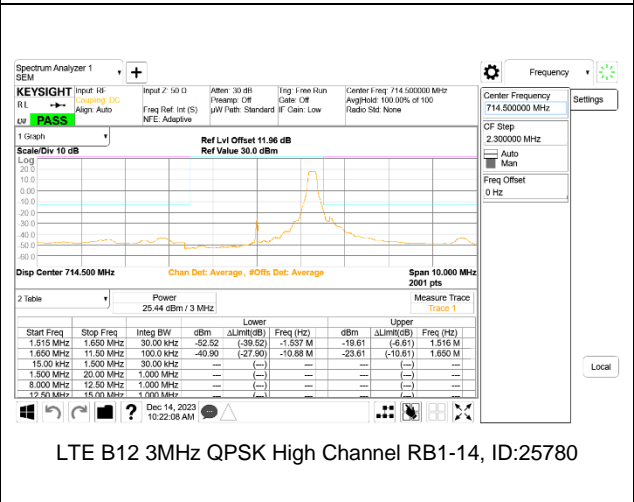
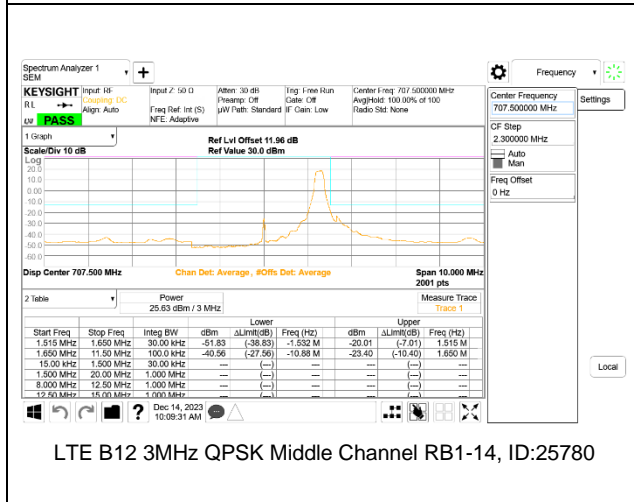
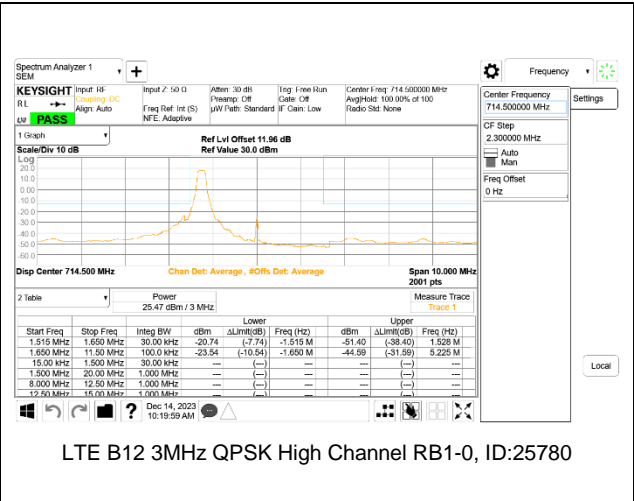
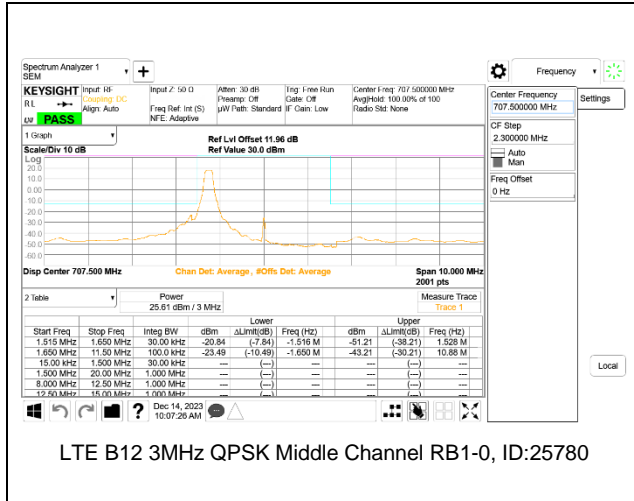

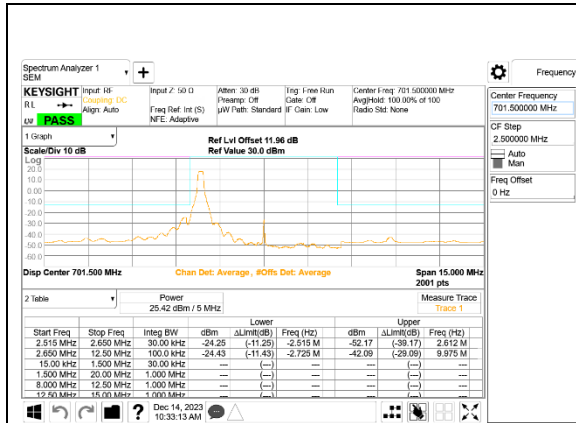

LTE B12 5MHz QPSK Low Channel RB1-0, ID:25780

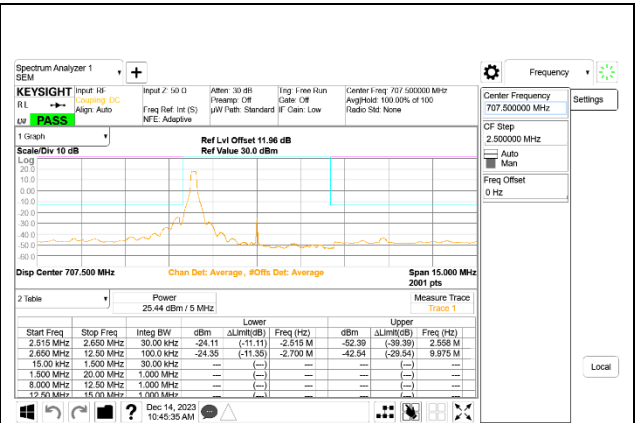

LTE B12 5MHz QPSK Middle Channel RB1-0, ID:25780

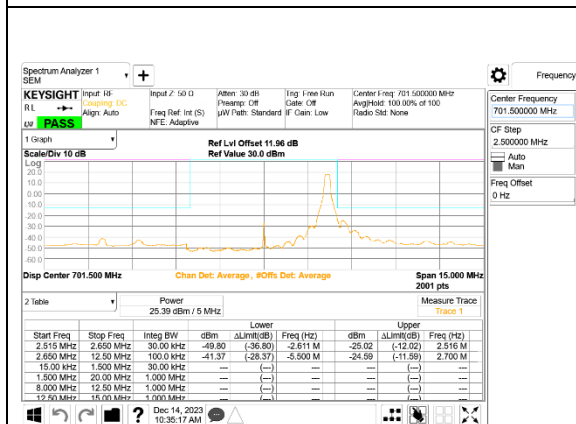

LTE B12 5MHz QPSK Low Channel RB1-24, ID:25780

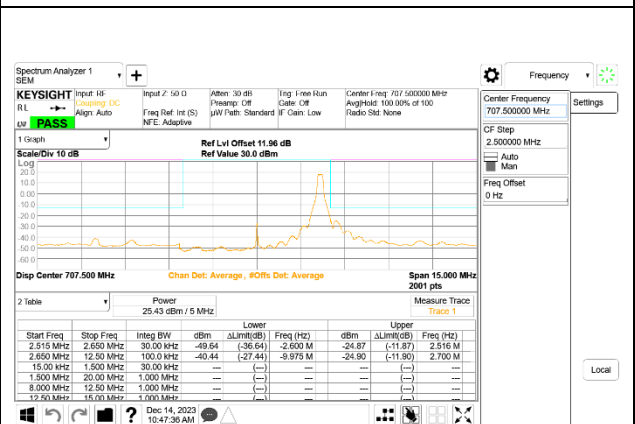

LTE B12 5MHz QPSK Middle Channel RB1-24, ID:25780

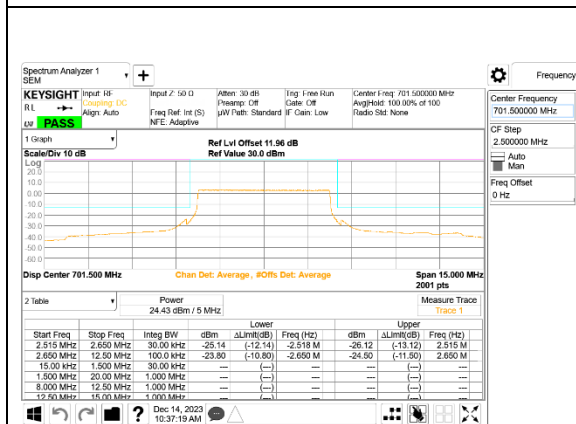

LTE B12 5MHz QPSK Low Channel RB25-0, ID:25780

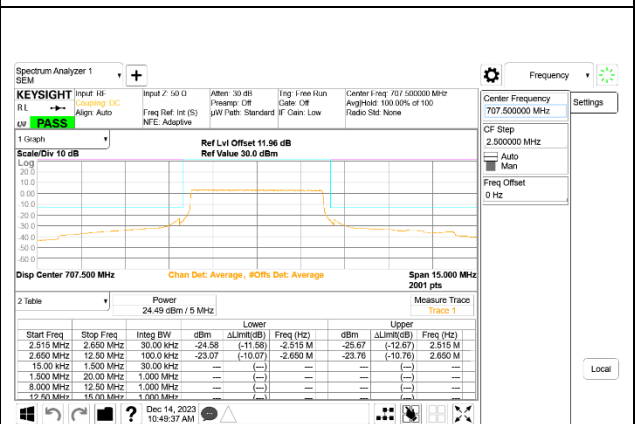

LTE B12 5MHz QPSK Middle Channel RB25-0, ID:25780

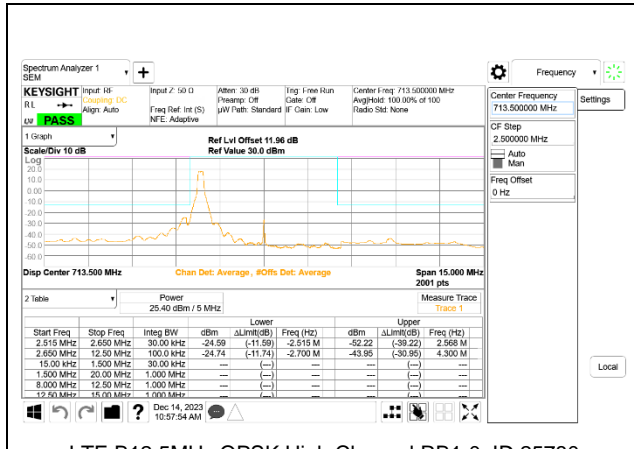

LTE B12 5MHz QPSK High Channel RB1-0, ID:25780

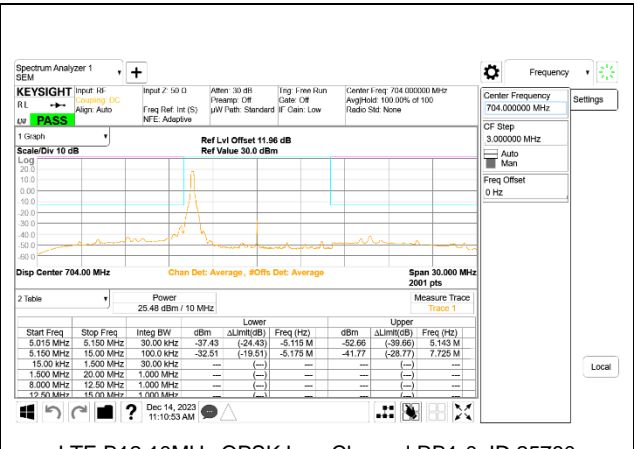

LTE B12 10MHz QPSK Low Channel RB1-0, ID:25780

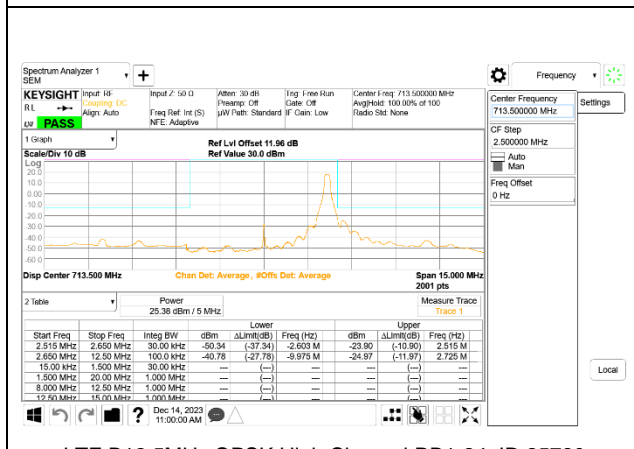

LTE B12 5MHz QPSK High Channel RB1-24, ID:25780

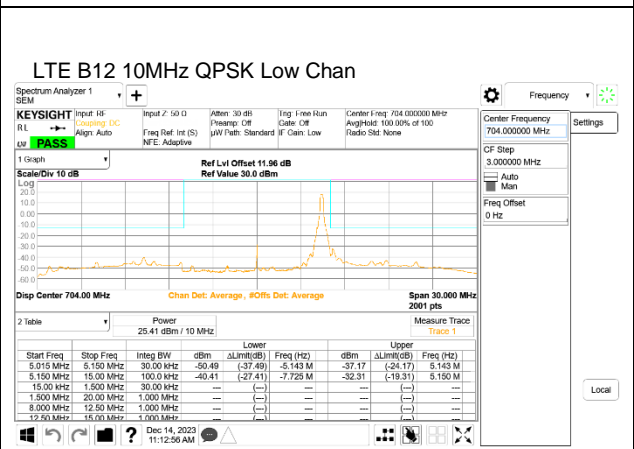

nel RB1-49, ID:25780

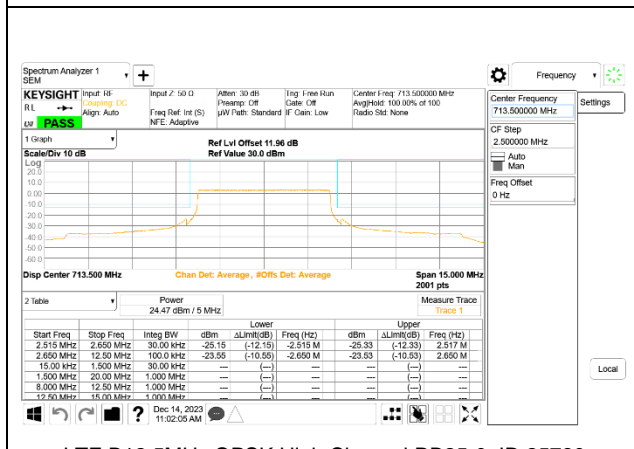

LTE B12 5MHz QPSK High Channel RB25-0, ID:25780

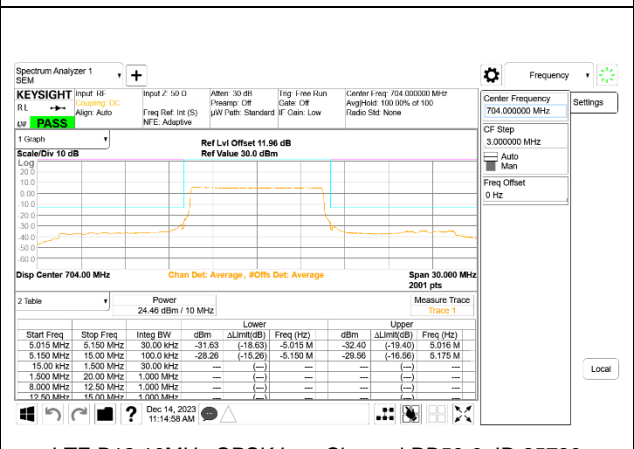

LTE B12 10MHz QPSK Low Channel RB50-0, ID:25780

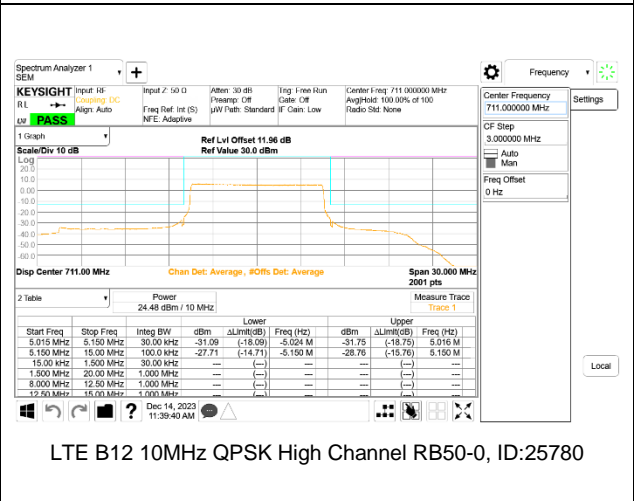
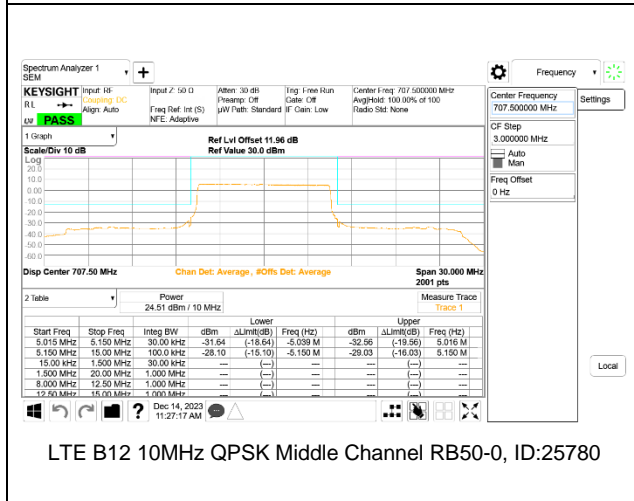
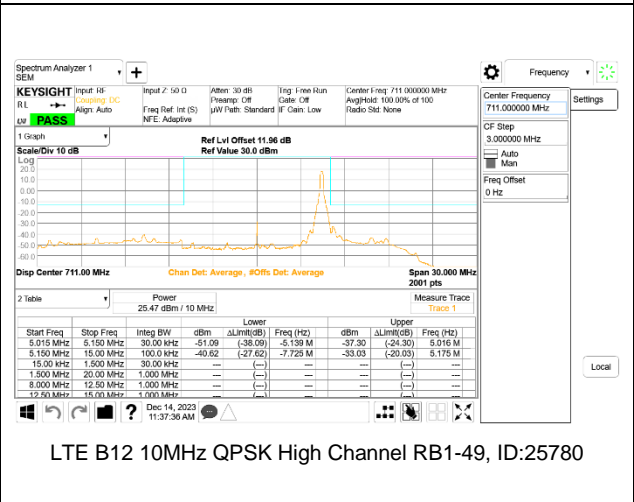
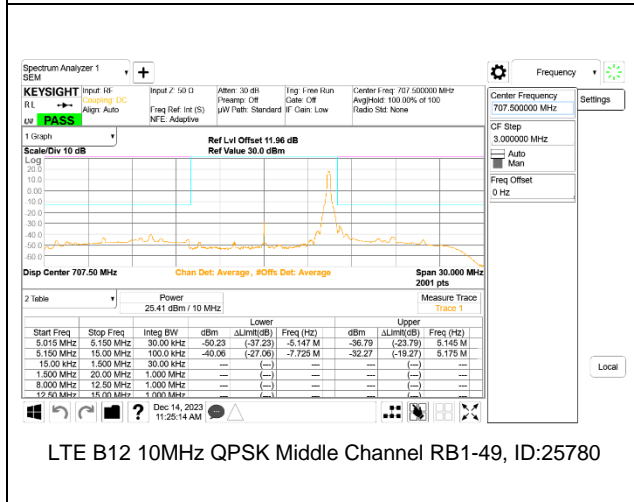
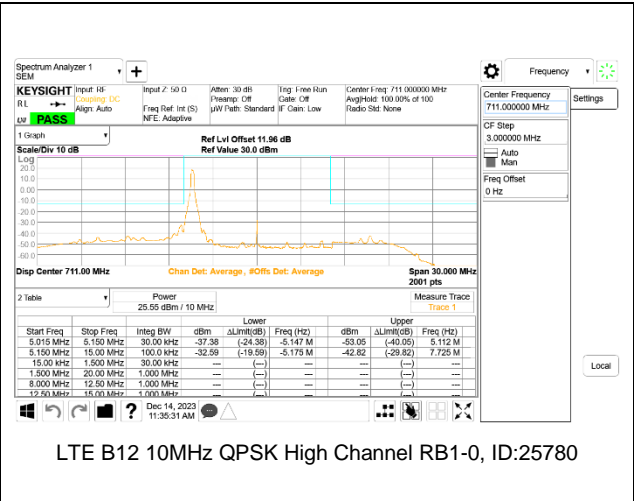
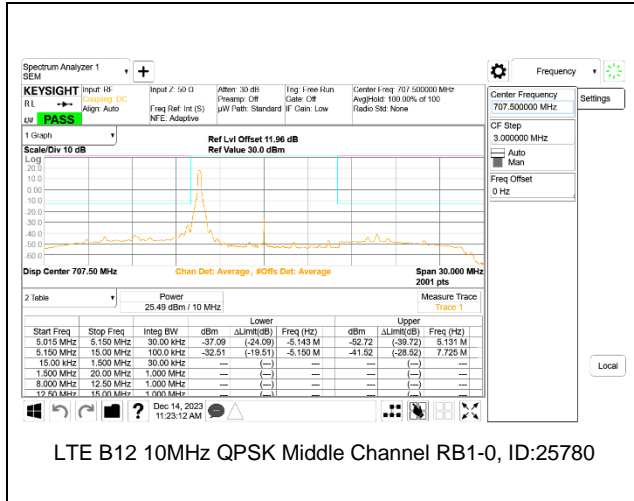

**5G NR n12 EMISSION MASK**

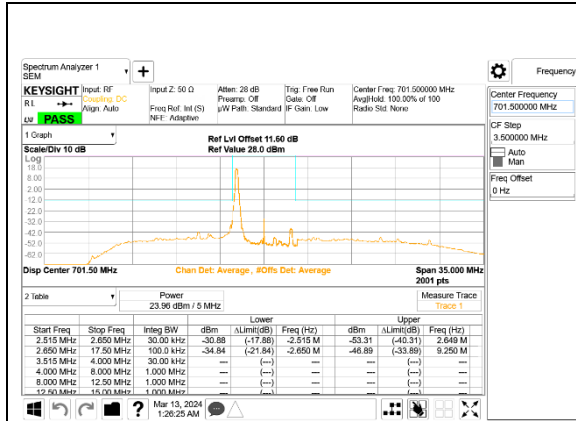

5G NR n12 5MHz BPSK Low Channel RB1-0, ID:28498

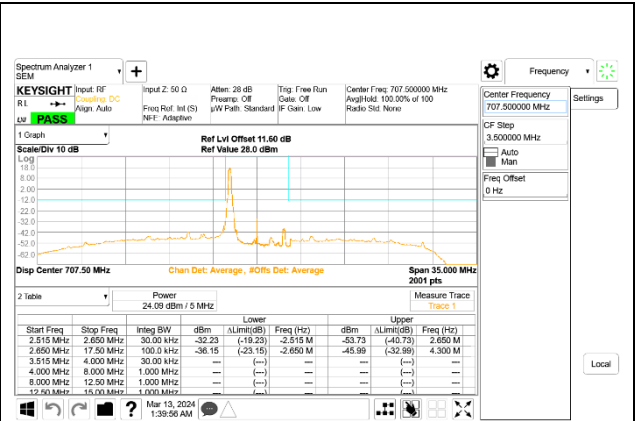

5G NR n12 5MHz BPSK Middle Channel RB1-0, ID:28498

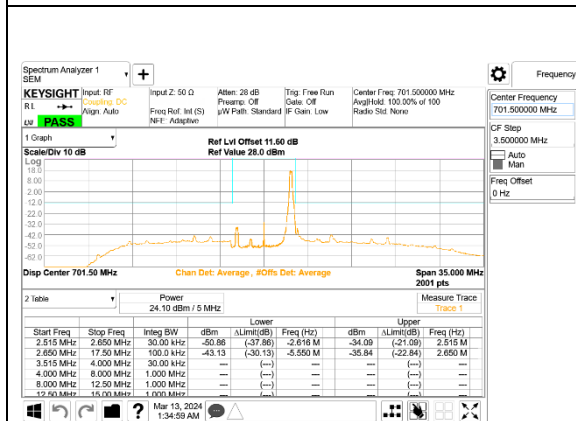

5G NR n12 5MHz BPSK Low Channel RB1-24, ID:28498

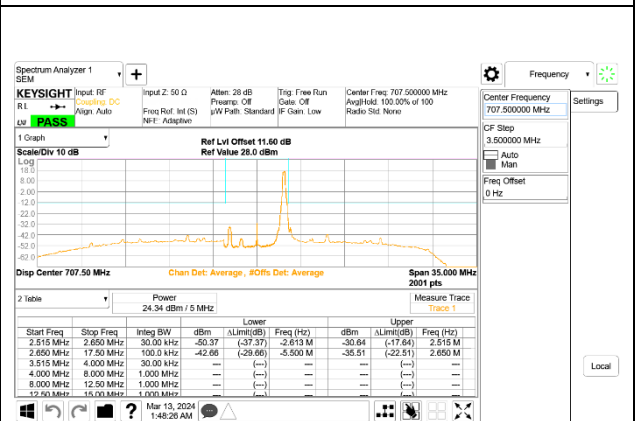

5G NR n12 5MHz BPSK Middle Channel RB1-24, ID:28498

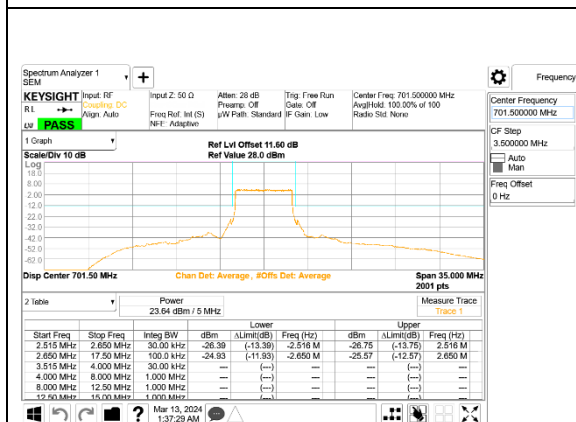

5G NR n12 5MHz BPSK Low Channel RB25-0, ID:28498

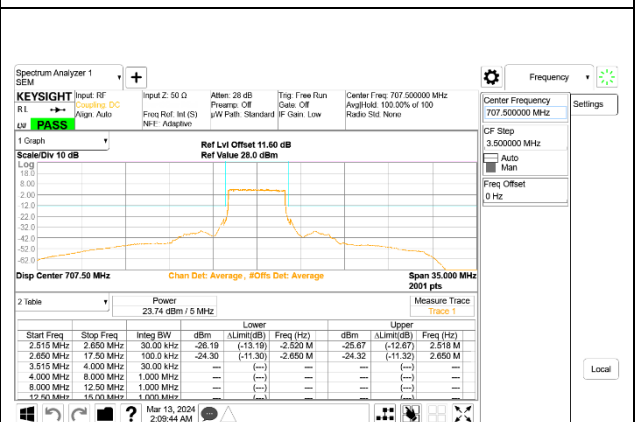

5G NR n12 5MHz BPSK Middle Channel RB25-0, ID:28498

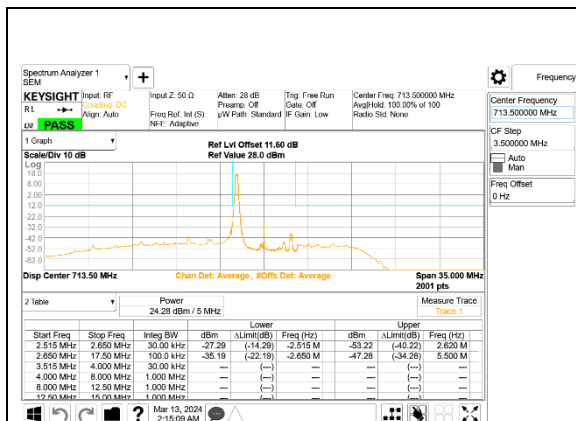

5G NR n12 5MHz BPSK High Channel RB1-0, ID:28498

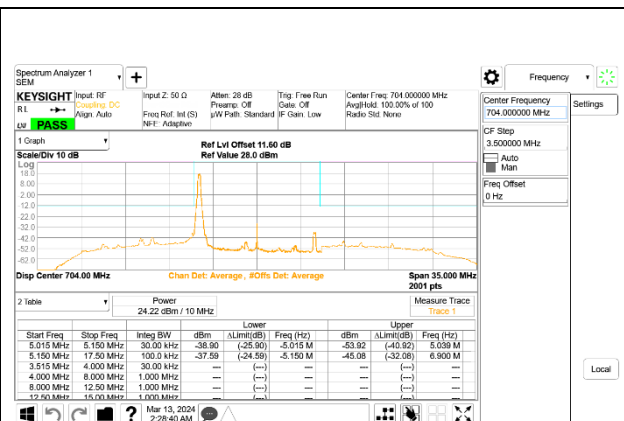

5G NR n12 10MHz BPSK Low Channel RB1-0, ID:28498

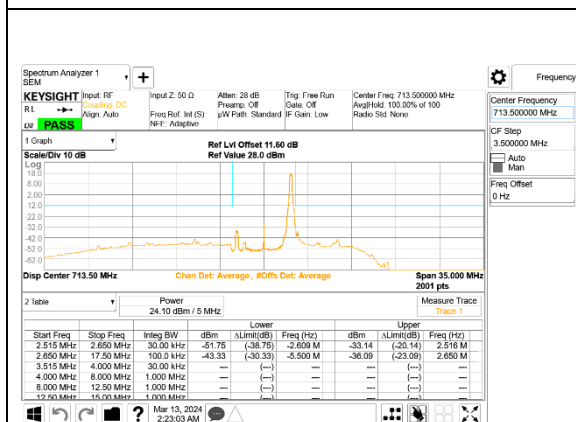

5G NR n12 5MHz BPSK High Channel RB1-24, ID:28498

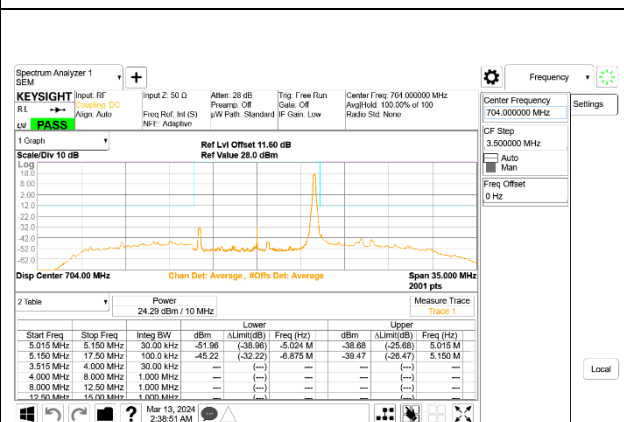

5G NR n12 10MHz BPSK Low Channel RB1-51, ID:28498

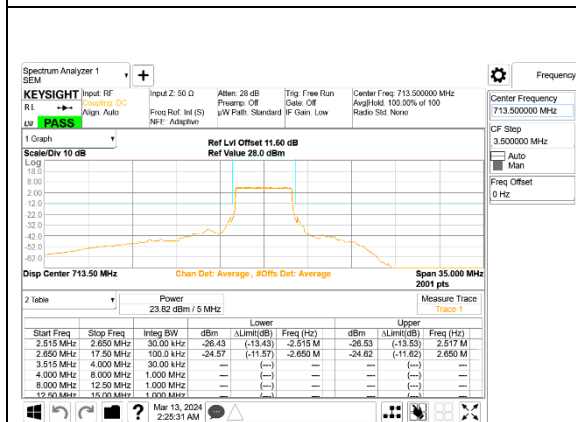

5G NR n12 5MHz BPSK High Channel RB25-0, ID:28498

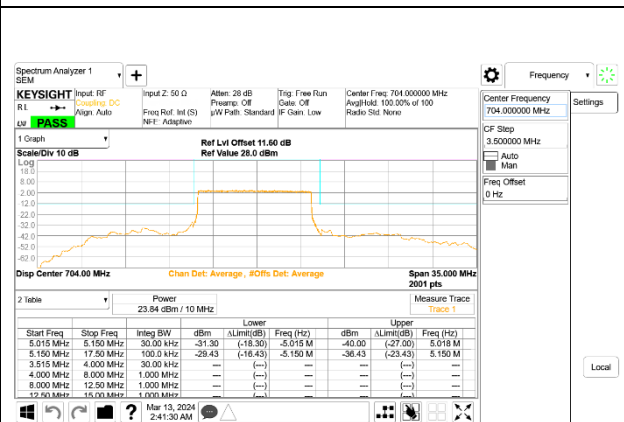

5G NR n12 10MHz BPSK Low Channel RB50-0, ID:28498



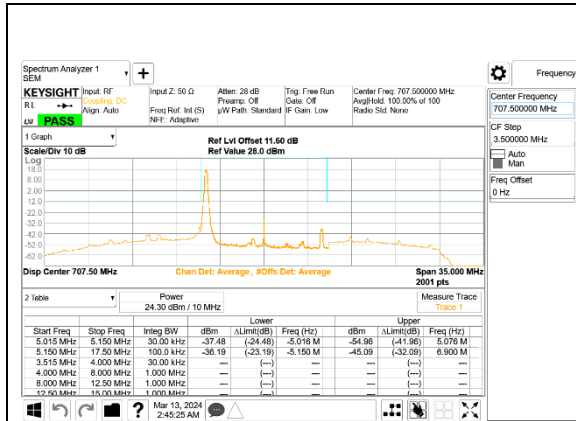

5G NR n12 10MHz BPSK Middle Channel RB1-0, ID:28498

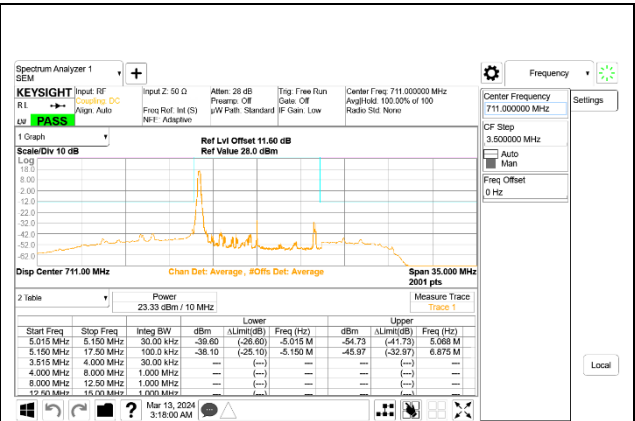

5G NR n12 10MHz BPSK High Channel RB1-0, ID:28498

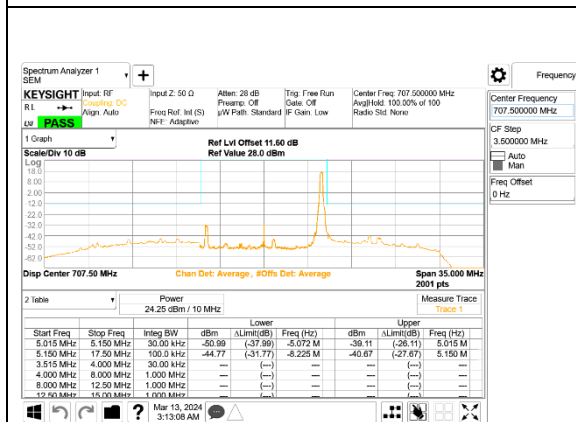

5G NR n12 10MHz BPSK Middle Channel RB1-51, ID:28498

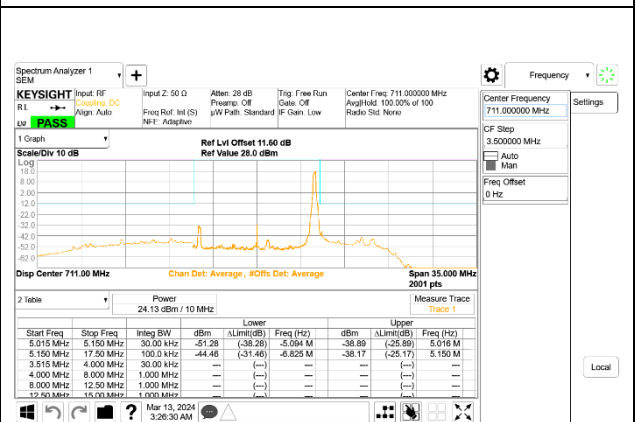

5G NR n12 10MHz BPSK High Channel RB1-51, ID:28498

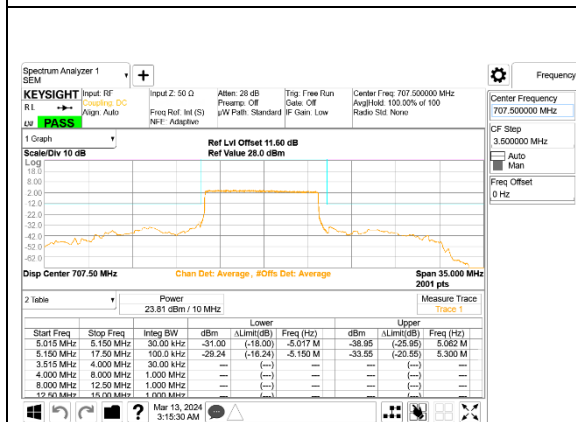

5G NR n12 10MHz BPSK Middle Channel RB50-0, ID:28498

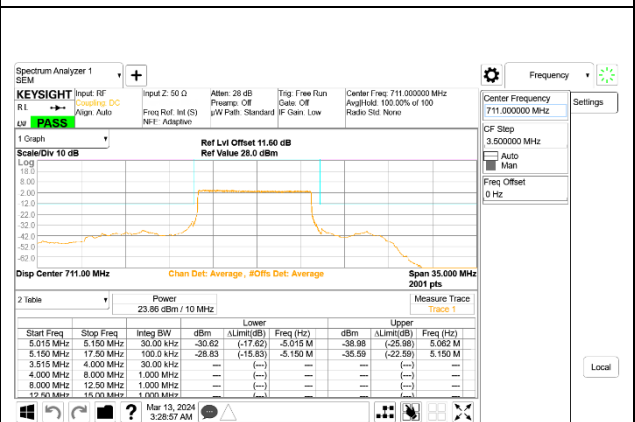

5G NR n12 10MHz BPSK High Channel RB50-0, ID:28498

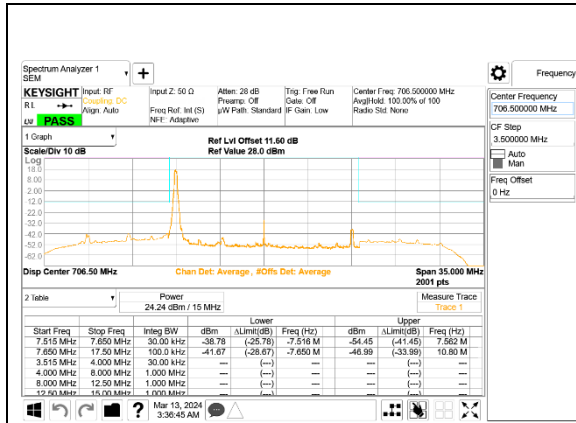

5G NR n12 15MHz BPSK Low Channel RB1-0, ID:28498

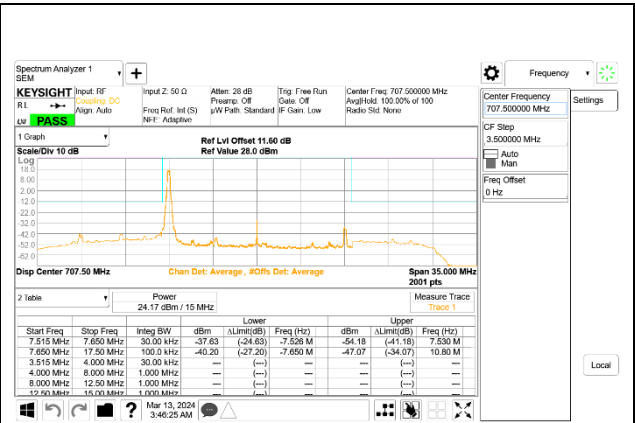

5G NR n12 15MHz BPSK Middle Channel RB1-0, ID:28498

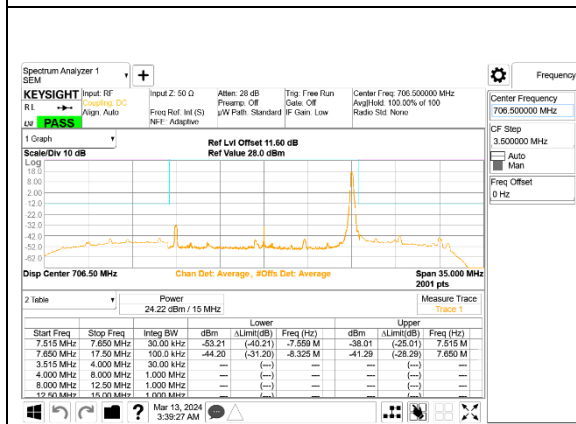

5G NR n12 15MHz BPSK Low Channel RB1-78, ID:28498

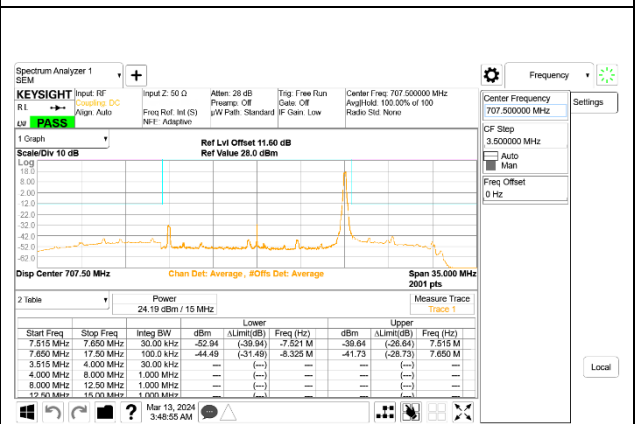

5G NR n12 15MHz BPSK Middle Channel RB1-78, ID:28498

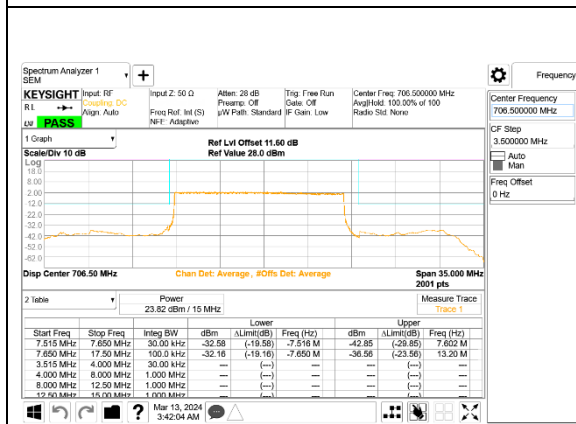

5G NR n12 15MHz BPSK Low Channel RB75-0, ID:28498

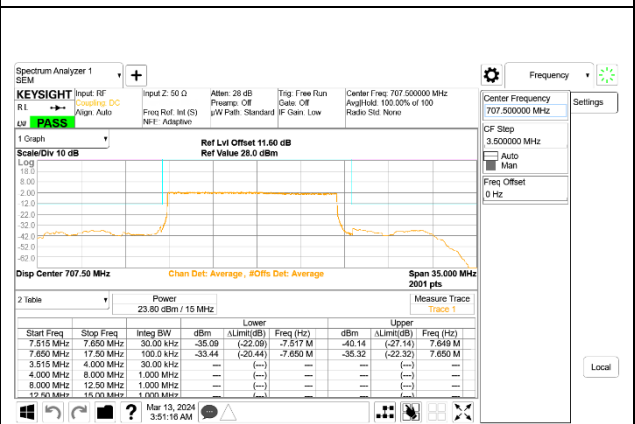

5G NR n12 15MHz BPSK Middle Channel RB75-0, ID:28498

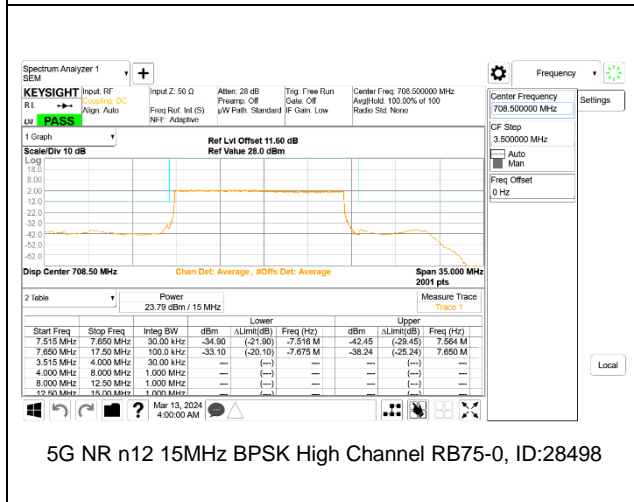
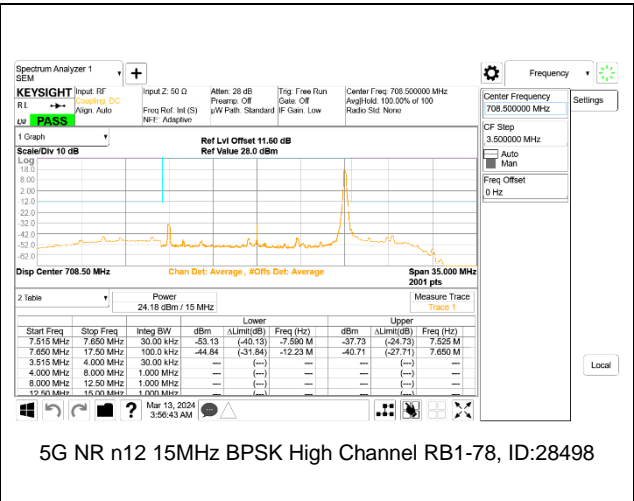
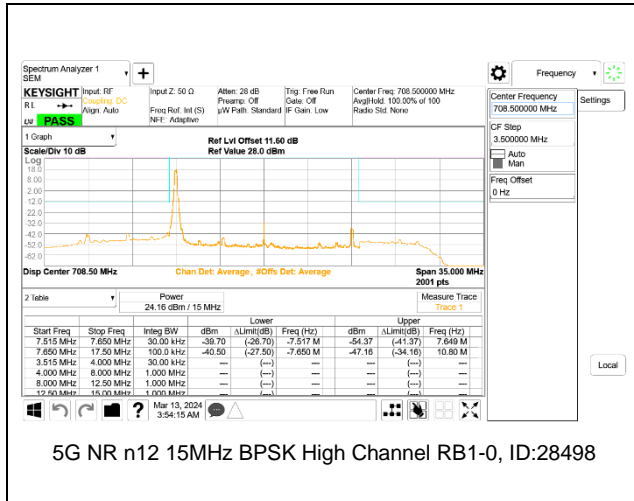

Intentionally Blank

## 9.2.4. LTE BAND 13

### LIMITS

FCC: §27.53

(c) For operations in the 746-758 MHz band and the 776-788 MHz band, the power of any emission outside the licensee's frequency band(s) of operation shall be attenuated below the transmitter power (P) within the licensed band(s) of operation, measured in watts, in accordance with the following:

(2) On any frequency outside the 776-788 MHz band, the power of any emission shall be attenuated outside the band below the transmitter power (P) by at least  $43 + 10 \log (P)$  dB;

(4) On all frequencies between 763-775 MHz and 793-805 MHz, by a factor not less than  $65 + 10 \log (P)$  dB in a 6.25 kHz band segment, for mobile and portable stations;

(5) Compliance with the provisions of paragraphs (c)(2) of this section is based on the use of measurement instrumentation employing a resolution bandwidth of 100 kHz or greater. However, in the 100 kHz bands immediately outside and adjacent to the frequency block, a resolution bandwidth of at least 30 kHz may be employed;

(6) Compliance with the provisions of paragraphs (c)(4) of this section is based on the use of measurement instrumentation such that the reading taken with any resolution bandwidth setting should be adjusted to indicate spectral energy in a 6.25 kHz segment.

(f) Emissions in the band 1559-1610 MHz shall be limited to  $-70$  dBW/MHz equivalent isotropically radiated power (EIRP) for wideband signals. ( $-70$  dBW/MHz =  $-40$  dBm/MHz).

**LTE BAND 13 EMISSION MASK**

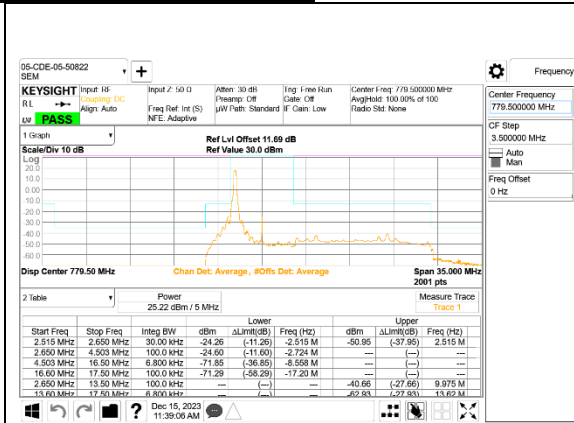

LTE B13 5MHz QPSK Low Channel RB1-0

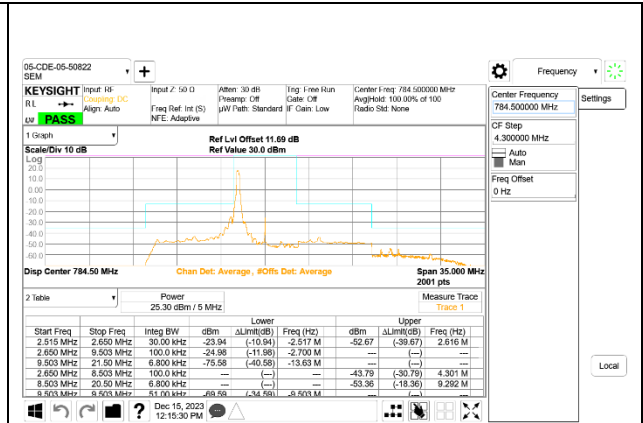

LTE B13 5MHz QPSK High Channel RB1-0

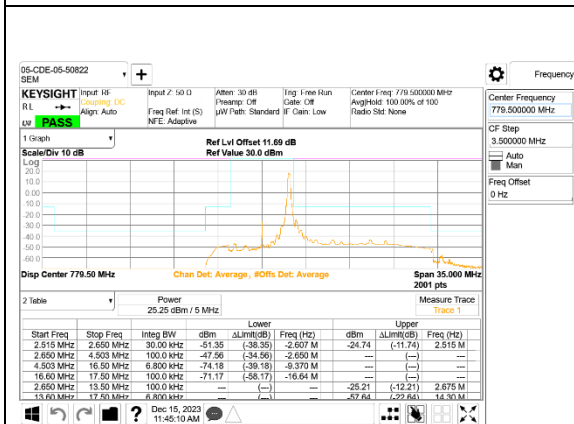

LTE B13 5MHz QPSK Low Channel RB1-24

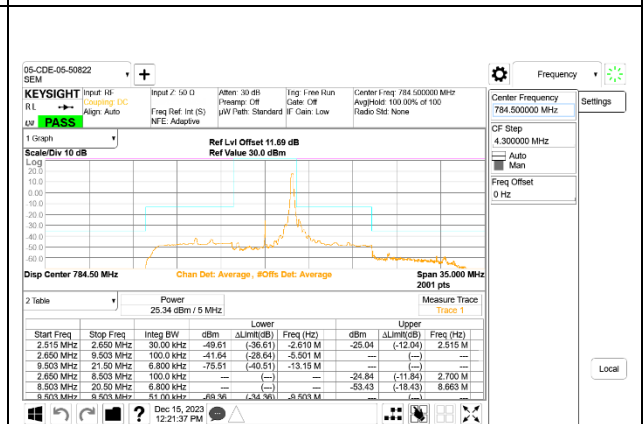

LTE B13 5MHz QPSK High Channel RB1-24

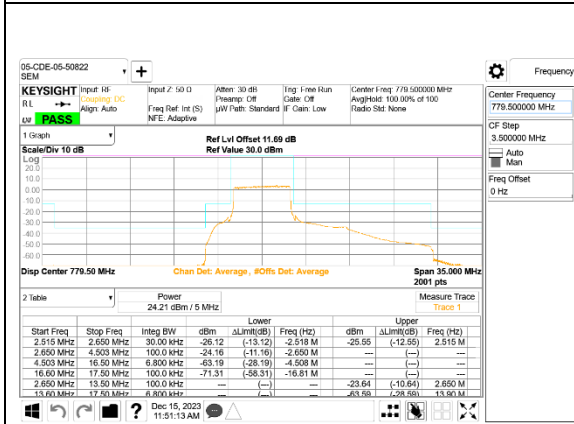

LTE B13 5MHz QPSK Low Channel RB25-0

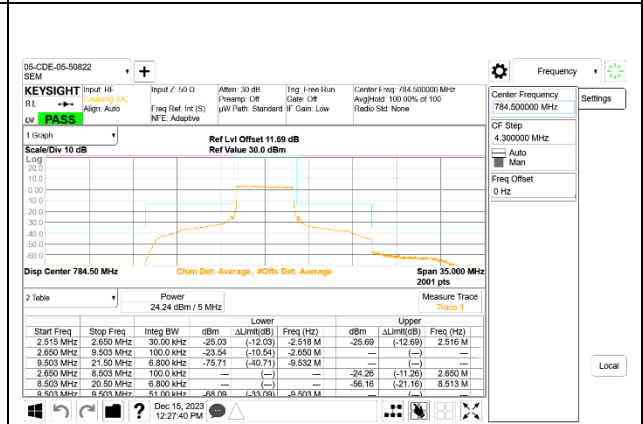

LTE B13 5MHz QPSK High Channel RB25-0

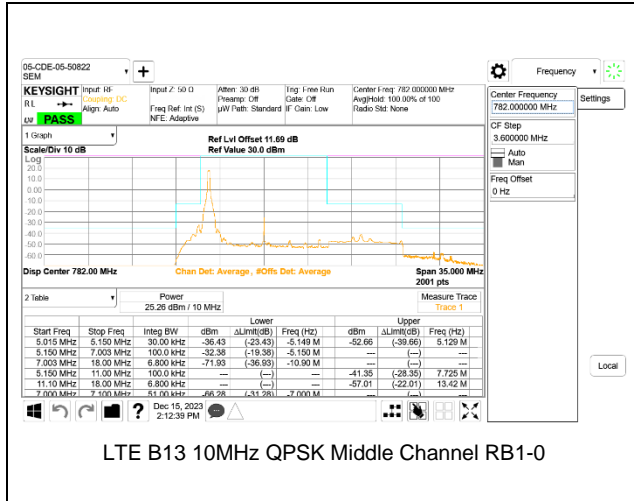

LTE B13 10MHz QPSK Middle Channel RB1-0

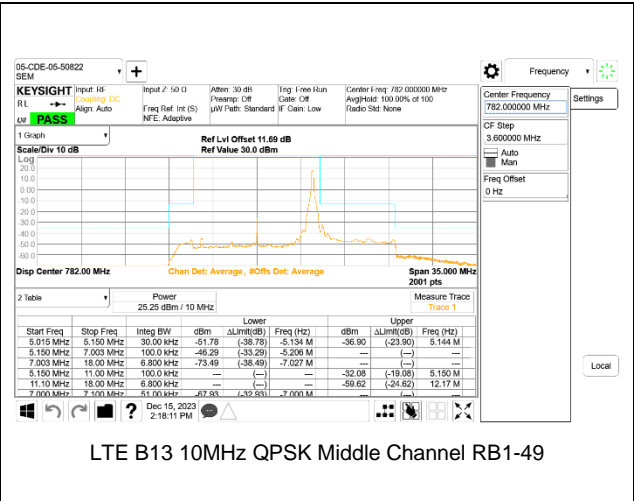

LTE B13 10MHz QPSK Middle Channel RB1-49

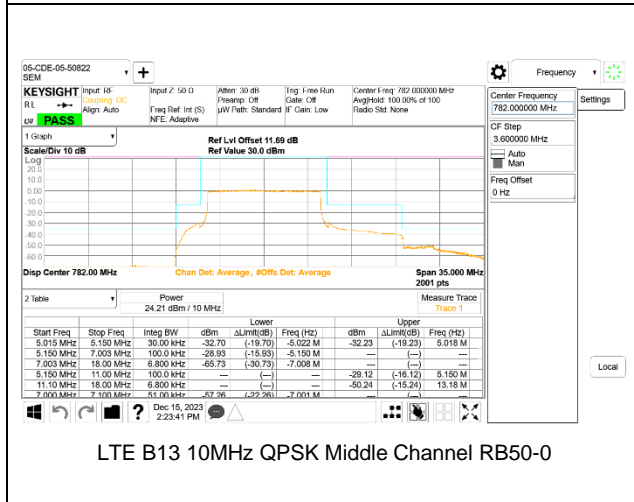

LTE B13 10MHz QPSK Middle Channel RB50-0

Intentionally Blank

## 9.2.5. LTE BAND 14 AND 5G NR n14

### LIMITS

FCC: §90.543 Emission Limitations.

(e) For operations in the 758-768 MHz and the 788-798 MHz bands, the power of any emission outside the licensee's frequency band(s) of operation shall be attenuated below the transmitter power (P) within the licensed band(s) of operation, measured in watts, in accordance with the following:

(2) On all frequencies between 769-775 MHz and 799-805 MHz, by a factor not less than  $65 + 10 \log (P)$  dB in a 6.25 kHz band segment, for mobile and portable stations.

(3) On any frequency between 775-788 MHz, above 805 MHz, and below 758 MHz, by at least  $43 + 10 \log (P)$  dB.

(4) Compliance with the provisions of paragraphs (e)(1) and (2) of this section is based on the use of measurement instrumentation such that the reading taken with any resolution bandwidth setting should be adjusted to indicate spectral energy in a 6.25 kHz segment.

(5) Compliance with the provisions of paragraph (e)(3) of this section is based on the use of measurement instrumentation employing a resolution bandwidth of 100 kHz or greater. However, in the 100 kHz bands immediately outside and adjacent to the frequency block, a resolution bandwidth of 30 kHz may be employed.

(f) For operations in the 758-775 MHz and 788-805 MHz bands, all emissions including harmonics in the band 1559-1610 MHz shall be limited to  $-70$  dBW/MHz equivalent isotropically radiated power (EIRP) for wideband signals, and  $-80$  dBW EIRP for discrete emissions of less than 700 Hz bandwidth. For the purpose of equipment authorization, a transmitter shall be tested with an antenna that is representative of the type that will be used with the equipment in normal operation.

The RSS-140 the limit of  $-35$ dBm / 6.25 kHz is extended out to 806 MHz. The FCC Part 90 limit from 805 MHz to 806 MHz is  $-13$ dBm measured in 100kHz. The 6.25kHz measurement is a more stringent limit (equivalent to  $-25$ dBm / 100kHz) and therefore demonstrates compliance with both limits.

**LTE BAND 14 EMISSION MASK**

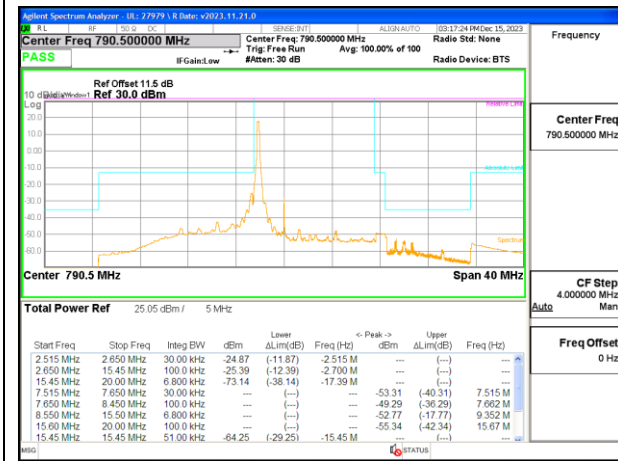

LTE B14 5MHz QPS Low Channel RB1-0, ID:27979

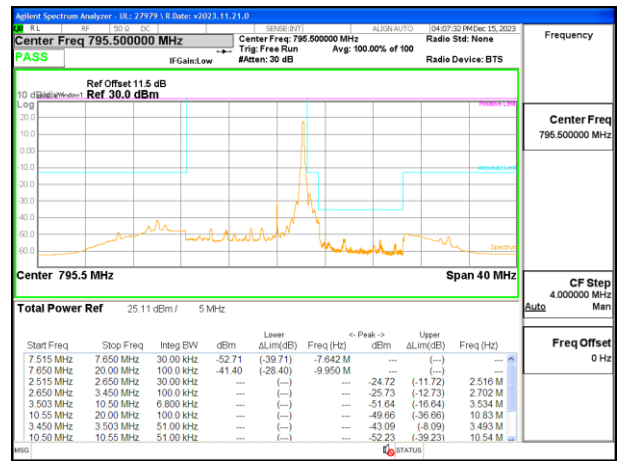

LTE B14 5MHz QPSK High Channel RB1-24, ID:27979

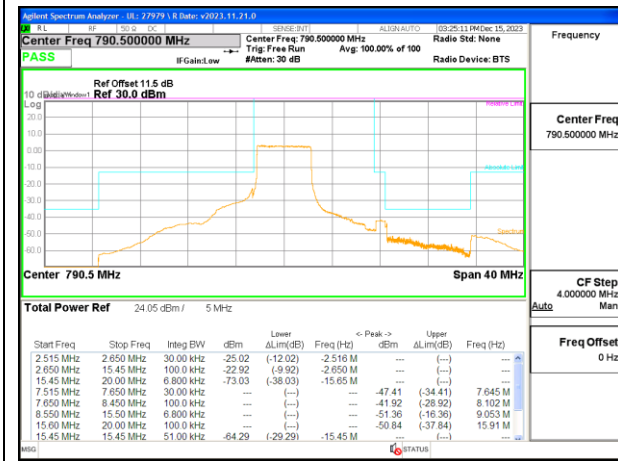

LTE B14 5MHz QPSK Low Channel RB25-0, ID:27979

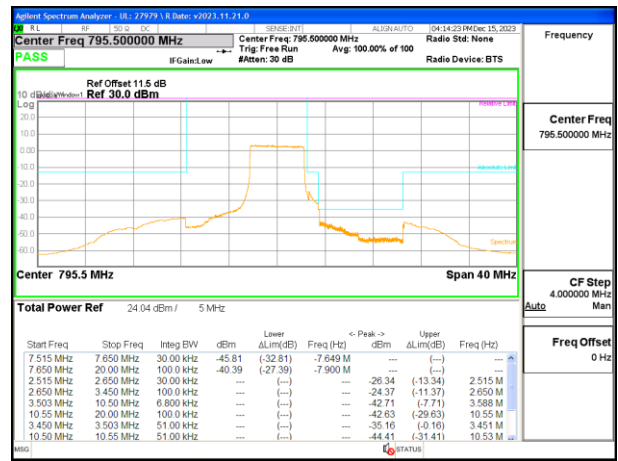

LTE B14 5MHz QPSK High Channel RB25-0, ID:27979

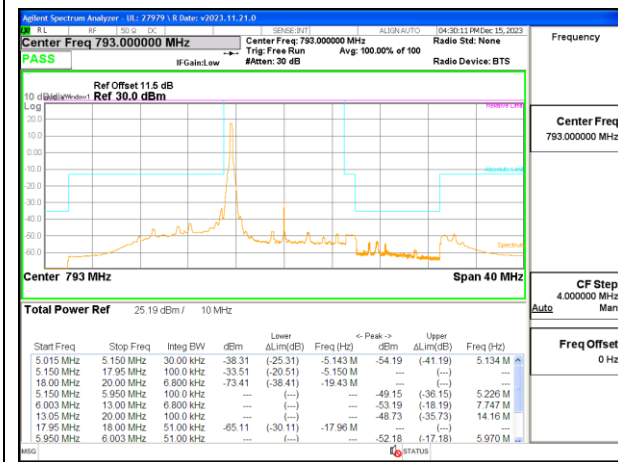

LTE B14 10MHz QPSK Middle Channel RB1-0, ID:27979

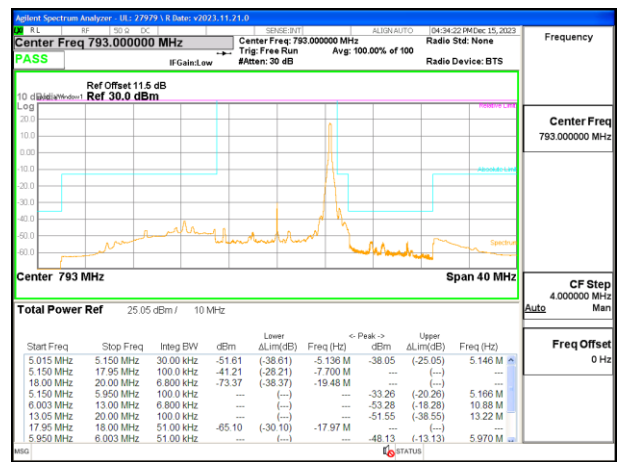

LTE B14 10MHz QPSK Middle Channel RB1-49, ID:27979