



FCC CO-LOCATION RADIO TEST REPORT

FCC ID : A4RG1MNW
Equipment : Phone
Model Name : G1MNW
Applicant : Google LLC
1600 Amphitheatre Parkway,
Mountain View, California, 94043 USA
Standard : FCC Part 15 Subpart E §15.407

The product was received on Apr. 10, 2023 and testing was performed from Apr. 16, 2023 to Jun. 07, 2023. We, Sporton International Inc. Wensan Laboratory, would like to declare that the tested sample has been evaluated in accordance with the test procedures and has been in compliance with the applicable technical standards.

The test results in this report apply exclusively to the tested model / sample. Without written approval from Sporton International Inc. Wensan Laboratory, the test report shall not be reproduced except in full.

Approved by: Louis Wu

Sporton International Inc. Wensan Laboratory

No.58, Aly. 75, Ln. 564, Wenhua 3rd, Rd., Guishan Dist., Taoyuan City 333010, Taiwan (R.O.C.)



Table of Contents

History of this test report..... 3

Summary of Test Result..... 4

1 General Description 5

 1.1 Product Feature of Equipment Under Test..... 5

 1.2 Product Specification of Equipment Under Test..... 6

 1.3 Modification of EUT 6

 1.4 Testing Location 7

 1.5 Applicable Standards..... 7

2 Test Configuration of Equipment Under Test 8

 2.1 Carrier Frequency and Channel 8

 2.2 Test Mode..... 8

 2.3 Connection Diagram of Test System 9

 2.4 EUT Operation Test Setup 9

3 Test Result 10

 3.1 Unwanted Emissions Measurement 10

 3.2 Antenna Requirements 16

4 List of Measuring Equipment..... 17

5 Measurement Uncertainty 18

Appendix A. Radiated Spurious Emission

Appendix B. Radiated Spurious Emission Plots

Appendix C. Duty Cycle Plots

Appendix D. Setup Photographs



History of this test report

Report No.	Version	Description	Issue Date
FR2D0206-01G	01	Initial issue of report	Jun. 28, 2023



Summary of Test Result

Report Clause	Ref Std. Clause	Test Items	Result (PASS/FAIL)	Remark
3.1	15.407(b)	Unwanted Emissions	Pass	2.49 dB under the limit at 17475.00 MHz
3.2	15.203 15.407(a)	Antenna Requirement	Pass	-

Conformity Assessment Condition:

1. The test results (PASS/FAIL) with all measurement uncertainty excluded are presented against the regulation limits or in accordance with the requirements stipulated by the applicant/manufacturer who shall bear all the risks of non-compliance that may potentially occur if measurement uncertainty is taken into account.
2. The measurement uncertainty please refer to each test result in the section "Measurement Uncertainty".

Disclaimer:

The product specifications of the EUT presented in the test report that may affect the test assessments are declared by the manufacturer who shall take full responsibility for the authenticity.

Reviewed by: William Chen

Report Producer: Clio Lo



1 General Description

1.1 Product Feature of Equipment Under Test

Product Feature	
Equipment	Phone
Mode Name	G1MNW
FCC ID	A4RG1MNW
EUT supports Radios application	GSM/EGPRS/WCDMA/HSPA/LTE/5G NR/NFC/GNSS/ UWB/WPT WLAN 11b/g/n HT20 WLAN 11a/n HT20/HT40 WLAN 11ac VHT20/VHT40/VHT80/VHT160 WLAN 11ax HE20/HE40/HE80/HE160 WLAN 11be EHT20/EHT40/EHT80/EHT160 Bluetooth BR/EDR/LE/HR

Remark: The above EUT's information was declared by manufacturer.

EUT Information List	
S/N	Performed Test Item
33141FDJG00048	Radiated Spurious Emission



1.2 Product Specification of Equipment Under Test

Product Specification is subject to this standard										
Tx/Rx Channel Frequency Range	2402 MHz ~ 2480 MHz 5150 MHz ~ 5250 MHz 5725 MHz ~ 5825 MHz 5925 MHz ~ 6425 MHz									
Antenna Type / Gain	<p><Bluetooth-LE> <Ant. 3> : PIFA Antenna with gain -1.9 dBi <Ant. 4> : IFA Antenna with gain 1.0 dBi <2402 MHz ~ 2480 MHz> <Ant. 3> : PIFA Antenna with gain -1.9 dBi <Ant. 4> : IFA Antenna with gain 1.0 dBi <5150 MHz ~ 5250 MHz> <Ant. 3> : PIFA Antenna with gain -2.0 dBi <Ant. 4> : IFA Antenna with gain -5.3 dBi <5725 MHz ~ 5825 MHz> <Ant. 3> : PIFA Antenna with gain -1.2 dBi <Ant. 4> : IFA Antenna with gain -1.6 dBi <5925 MHz ~ 6425 MHz> <Ant. 3> : PIFA Antenna with gain -3.9 dBi <Ant. 4> : IFA Antenna with gain -5.4 dBi</p>									
Type of Modulation	Bluetooth LE: GFSK 802.11g/a: OFDM (BPSK / QPSK / 16QAM / 64QAM)									
Antenna Function for Transmitter	<table border="1"> <thead> <tr> <th></th> <th>Ant. 3</th> <th>Ant. 4</th> </tr> </thead> <tbody> <tr> <td>Bluetooth-LE</td> <td>V</td> <td>V</td> </tr> <tr> <td>802.11g/a MIMO</td> <td>V</td> <td>V</td> </tr> </tbody> </table>		Ant. 3	Ant. 4	Bluetooth-LE	V	V	802.11g/a MIMO	V	V
	Ant. 3	Ant. 4								
Bluetooth-LE	V	V								
802.11g/a MIMO	V	V								

Remark:

1. MIMO Ant. 3+4 is a calculated result from sum of the power MIMO Ant. 3 and MIMO Ant. 4.
2. The EUT's information above is declared by manufacturer. Please refer to Disclaimer in report summary.

1.3 Modification of EUT

No modifications are made to the EUT during all test items.



1.4 Testing Location

Test Site	Sporton International Inc. Wensan Laboratory.
Test Site Location	No.58, Aly. 75, Ln. 564, Wenhua 3rd, Rd., Guishan Dist., Taoyuan City 333010, Taiwan (R.O.C.) TEL: +886-3-327-0868 FAX: +886-3-327-0855
Test Site No.	Sporton Site No. 03CH13-HY

Note: The test site complies with ANSI C63.4 2014 requirement.

FCC designation No.: TW3786

1.5 Applicable Standards

According to the specifications of the manufacturer, the EUT must comply with the requirements of the following standards:

- ♦ FCC Part 15 Subpart E
- ♦ FCC Part 15 Subpart C §15.247
- ♦ FCC KDB Publication No. 558074 D01 15.247 Meas Guidance v05r02
- ♦ FCC KDB 789033 D02 General UNII Test Procedures New Rules v02r01.
- ♦ FCC KDB 414788 D01 Radiated Test Site v01r01.
- ♦ FCC KDB 662911 D01 Multiple Transmitter Output v02r01.
- ♦ ANSI C63.10-2013

Remark:

1. All test items were verified and recorded according to the standards and without any deviation during the test.
2. The TAF code is not including all the FCC KDB listed without accreditation.



2 Test Configuration of Equipment Under Test

The EUT has been associated with peripherals and configuration operated in a manner tended to maximize its emission characteristics in a typical application. Frequency range investigated: radiation emission (9 kHz to the 10th harmonic of the highest fundamental frequency or to 40 GHz, whichever is lower). For radiated measurement, the measured emission level of the EUT was maximized by rotating the EUT on a turntable, adjusting the orientation of the EUT and EUT antenna in three orthogonal axis (X: flat, Y: portrait, Z: landscape), and accessory (Adapter or Earphone) and adjusting the measurement antenna orientation, following C63.10 exploratory test procedures and only the worst case emissions were reported in this report.

2.1 Carrier Frequency and Channel

2400-2483.5 MHz					
Bluetooth – LE for 2Mbps			802.11g		
Channel	Freq. (MHz)		Channel	Freq. (MHz)	
00	2402		6	2437	

5150~5250 MHz		5725~5825 MHz		5925~6425 MHz	
802.11a		802.11a		802.11a	
Channel	Freq. (MHz)	Channel	Freq. (MHz)	Channel	Freq. (MHz)
44	5220	165	5825	1	5955

2.2 Test Mode

Final test modes are considering the modulation and worse data rates as below table.

<Co-Location>

Test Mode	Modulation	Data Rate
Mode 1	WLAN 2.4GHz 802.11g for MIMO < Ant. 3+4> + WLAN 5GHz 802.11a for MIMO < Ant. 3+4>	6Mbps + 6Mbps
Mode 2	WLAN 2.4GHz 802.11g for MIMO < Ant. 3+4> + WLAN 6GHz 802.11a for MIMO < Ant. 3+4>	6Mbps + 6Mbps
Mode 3	WLAN 5GHz 802.11a for MIMO < Ant. 3+4> + Bluetooth-LE for MIMO < Ant. 3+4>	6Mbps + 1Mbps

Remark:

1. For Radiated Test Cases, the tests were performed with Adapter 1 and USB Cable 1.
2. During the preliminary test, both charging modes (Adapter mode and WPT mode) were verified. It is determined that the adaptor mode is the worst case for official test.

2.3 Connection Diagram of Test System

<Co-Location Tx Mode>

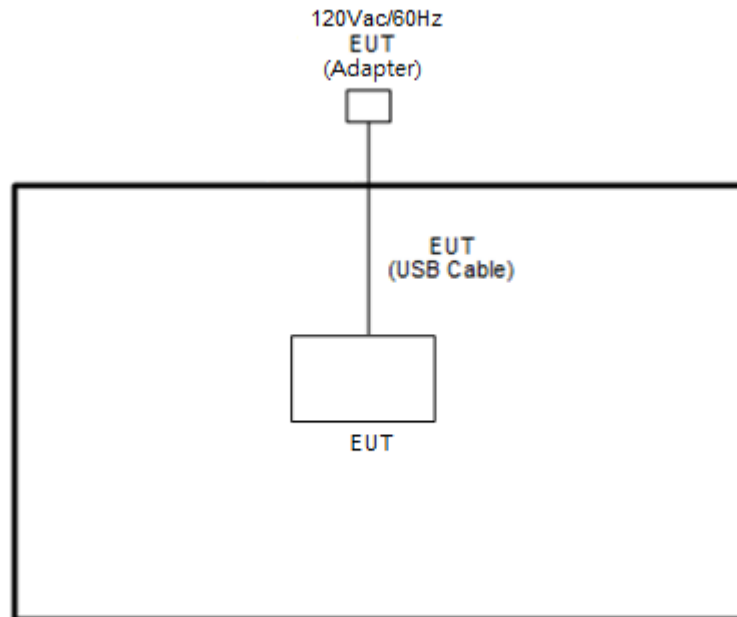

2.4 EUT Operation Test Setup

The RF test items, utility "CMD Version 10.0.19045.2965" was installed in Notebook which was programmed in order to make the EUT get into the engineering modes to provide channel selection, power level, data rate and the application type and for continuous transmitting signals.



3 Test Result

3.1 Unwanted Emissions Measurement

This section is to measure unwanted emissions through radiated measurement for band edge spurious emissions and out of band emissions measurement.

3.1.1 Limit of Unwanted Emissions

<For 2402 MHz ~ 2480 MHz>

In any 100 kHz bandwidth outside the intentional radiator frequency band, all harmonics/spurious must be at least 20 dB below the highest emission level within the authorized band. If the output power of this device is measured by spectrum analyzer, the attenuation under this paragraph shall be 30 dB instead of 20 dB.

<For 5150 MHz ~ 5250 MHz>

For transmitters operating in the 5150-5250 MHz band: all emissions outside of the 5150-5350 MHz band shall not exceed an EIRP of -27dBm/MHz.

<For 5725 MHz ~ 5850 MHz>

For transmitters operating in the 5.725-5.85 GHz band:

15.407(b)(4)(i) All emissions shall be limited to a level of -27 dBm/MHz at 75 MHz or more above or below the band edge increasing linearly to 10 dBm/MHz at 25 MHz above or below the band edge, and from 25 MHz above or below the band edge increasing linearly to a level of 15.6 dBm/MHz at 5 MHz above or below the band edge, and from 5 MHz above or below the band edge increasing linearly to a level of 27 dBm/MHz at the band edge.

<For 5925 MHz ~ 6425 MHz>

For transmitters operating within the 5.925-7.125 GHz band: Any emissions outside of the 5.925-7.125 GHz band must not exceed an e.i.r.p. of -27 dBm/MHz.

EIRP (dBm)	Field Strength at 3m (dBµV/m)
- 27 (RMS)	68.3
- 7 (Peak)	88.3

According 987594 D02 U-NII 6GHz EMC Measurement v01 section G:

Unwanted emissions outside of restricted bands are measured with a RMS detector.

In addition, 15.35(b) applies where the peak emissions must be limited to no more than 20 dB above the average limit



Unwanted spurious emissions fallen in restricted bands shall comply with the general field strength limits as below table:

Frequency (MHz)	Field Strength (microvolts/meter)	Measurement Distance (meters)
0.009 – 0.490	2400/F(kHz)	300
0.490 – 1.705	24000/F(kHz)	30
1.705 – 30.0	30	30
30 – 88	100	3
88 – 216	150	3
216 - 960	200	3
Above 960	500	3

Note: The following formula is used to convert the EIRP to field strength.

$$E = \frac{1000000\sqrt{30P}}{3} \mu\text{V/m, where P is the eirp (Watts)}$$

EIRP (dBm)	Field Strength at 3m (dBμV/m)
- 27	68.3

KDB789033 D02 v02r01 G)2)c)

(i) Sections 15.407(b)(1-3) specifies the unwanted emissions limit for the U-NII-1 and U-NII-2 bands. As specified, emissions above 1000 MHz that are outside of the restricted bands are subject to a peak emission limit of -27 dBm/MHz.

(ii) Section 15.407(b)(4) specifies the unwanted emissions limit for the U-NII-3 band. A band emissions mask is specified in Section 15.407(b)(4)(i). The emission limits are based on the use of a peak detector.



3.1.2 Measuring Instruments

Please refer to the measuring equipment list in this test report.

3.1.3 Test Procedures

1. The testing follows FCC KDB 789033 D02 General UNII Test Procedures New Rules v02r01. Section G) Unwanted emissions measurement.
 - (1) Procedure for Unwanted Emissions Measurements Below 1000MHz
 - RBW = 120 kHz
 - VBW = 300 kHz
 - Detector = Peak
 - Trace mode = max hold
 - (2) Procedure for Peak Unwanted Emissions Measurements Above 1000 MHz
 - RBW = 1 MHz
 - VBW \geq 3 MHz
 - Detector = Peak
 - Sweep time = auto
 - Trace mode = max hold
 - (3) Procedures for Average Unwanted Emissions Measurements Above 1000MHz
 - RBW = 1 MHz
 - VBW = 10 Hz, when duty cycle is no less than 98 percent.
 - VBW \geq 1/T, when duty cycle is less than 98 percent where T is the minimum transmission duration over which the transmitter is on and is transmitting at its maximum power control level for the tested mode of operation.
2. The EUT is placed on a turntable with 0.8 meter for frequency below 1 GHz and 1.5 meter for frequency above 1 GHz respectively above ground.
3. The EUT is set 3 meters away from the receiving antenna which is mounted on the top of a variable height antenna tower.
4. The antenna is a broadband antenna and its height is adjusted between one meter and four meters above ground to find the maximum value of the field strength for both horizontal polarization and vertical polarization of the antenna.
5. For each suspected emission, the EUT is arranged to its worst case and then adjust the antenna tower (from 1 m to 4 m) and turntable (from 0 degree to 360 degrees) to find the maximum reading.

6. Radiated testing below 1 GHz is performed by adjusting the antenna tower from 1 m to 4 m and by rotating the turn table from 0 degree to 360 degrees to find the peak maximum hold reading. When there is no suspected emission found and the emission level is with at least 6 dB margin against QP limit line, the position is marked as “-“.
7. Radiated testing above 1 GHz is performed by adjusting the antenna tower from 1 m to 4 m and by rotating the turn table from 0 degree to 360 degrees to find the peak maximum hold reading for scanning all frequencies. When there is no suspected emission found and the harmonic emission level is with at least 6 dB margin against average limit line, the position is marked as “-“.

3.1.4 Test Setup

For radiated emissions below 30MHz

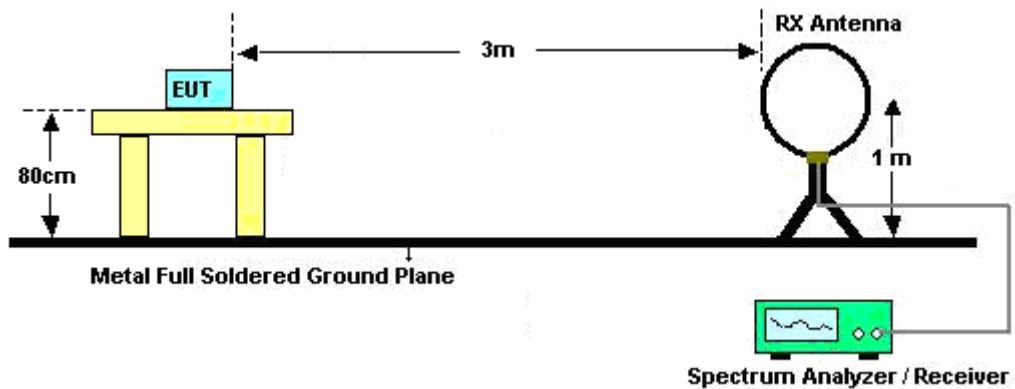

For radiated emissions from 30MHz to 1GHz

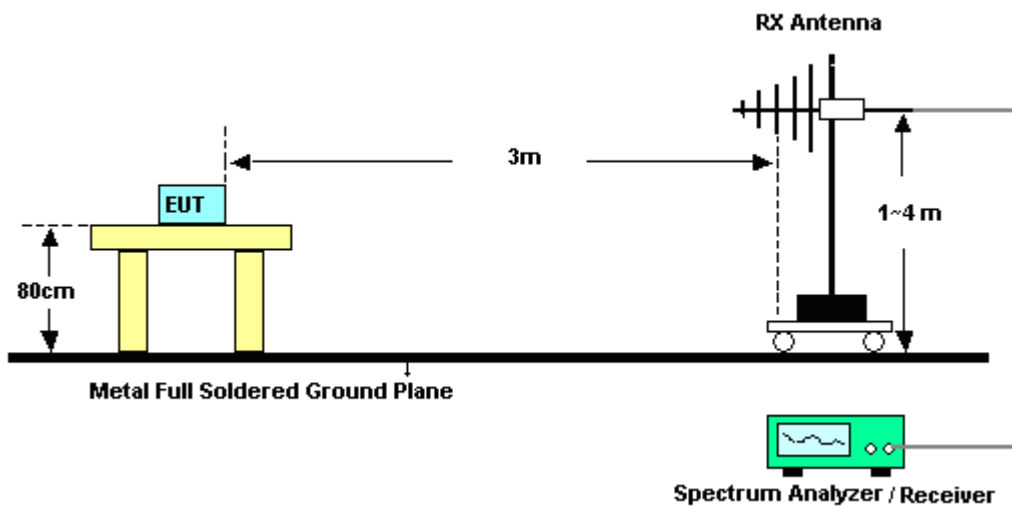

For radiated test from 1GHz to 18GHz

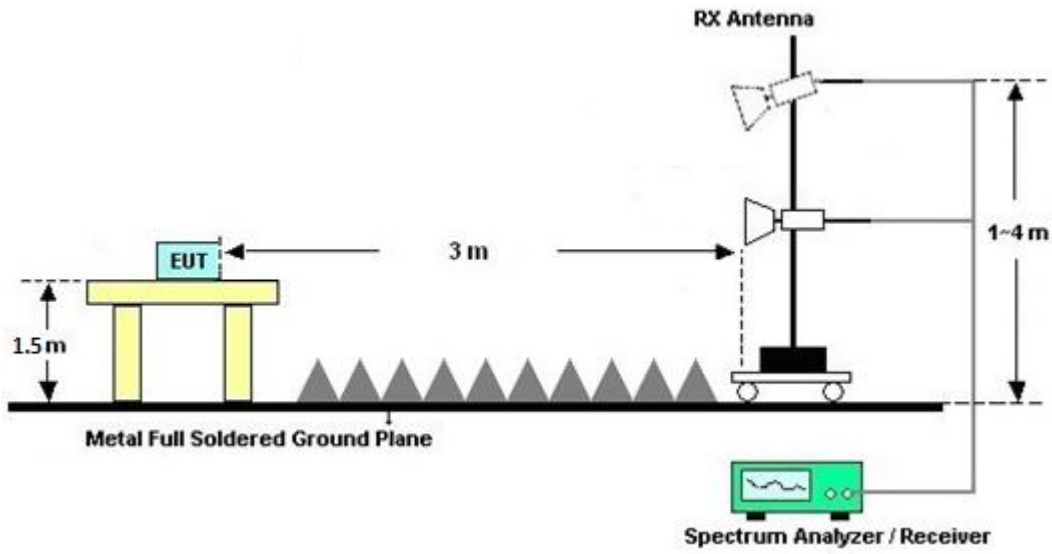

For radiated test above 18GHz

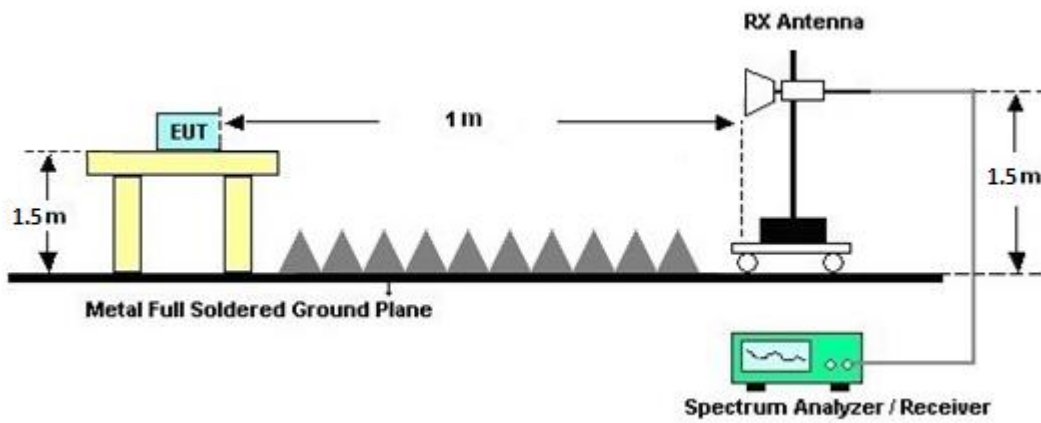



3.1.5 Test Results of Radiated Spurious Emissions (9 kHz ~ 30 MHz)

The low frequency, which started from 9 kHz to 30MHz, was pre-scanned and the result which was 20dB lower than the limit line was not reported.

There is adequate comparison measurement of both open-field test site and alternative test site - semi-Anechoic chamber according to 414788 D01 Radiated Test Site v01r01, and the result came out very similar.

3.1.6 Test Result of Radiated Spurious at Band Edges

Please refer to Appendix A and B.

3.1.7 Duty Cycle

Please refer to Appendix C.

3.1.8 Test Result of Radiated Spurious Emissions (30MHz ~ 10th Harmonic)

Please refer to Appendix A and B.



3.2 Antenna Requirements

3.2.1 Standard Applicable

The use of a permanently attached antenna or of an antenna that uses a unique coupling to the intentional radiator shall be considered sufficient to comply with the rule.

3.2.2 Antenna Anti-Replacement Construction

An embedded-in antenna design is used.



4 List of Measuring Equipment

Instrument	Brand Name	Model No.	Serial No.	Characteristics	Calibration Date	Test Date	Due Date	Remark
Hygrometer	TECEPEL	DTM-303B	TP140325	N/A	Nov. 07, 2022	Apr. 16, 2023~ Jun. 07, 2023	Nov. 06, 2023	Radiation (03CH13-HY)
Loop Antenna	Rohde & Schwarz	HFH2-Z2	100488	9 kHz~30 MHz	Sep. 20, 2022	Apr. 16, 2023~ Jun. 07, 2023	Sep. 19, 2023	Radiation (03CH13-HY)
RF Cable	HUBER + SUHNER	SUCOFLEX 102	803951/2	9K~30M	Mar. 07, 2023	Apr. 16, 2023~ Jun. 07, 2023	Mar. 06, 2024	Radiation (03CH13-HY)
Preamplifier	EMEC	EM18G40G	060715	18GHz~40GHz	Dec. 07, 2022	Apr. 16, 2023~ Jun. 07, 2023	Dec. 06, 2023	Radiation (03CH13-HY)
SHF-EHF Horn Antenna	SCHWARZBECK	BBHA9170	00993	18GHz-40GHz	Nov. 24, 2022	Apr. 16, 2023~ Jun. 07, 2023	Nov. 23, 2023	Radiation (03CH13-HY)
RF Cable	HUBER + SUHNER	SUCOFLEX 102	803953/2	30MHz~40GHz	Dec. 20, 2022	Apr. 16, 2023~ Jun. 07, 2023	Dec. 19, 2023	Radiation (03CH13-HY)
Amplifier	SONOMA	310N	187282	9kHz~1GHz	Dec. 14, 2022	Apr. 16, 2023~ Jun. 07, 2023	Dec. 13, 2023	Radiation (03CH13-HY)
Bilog Antenna	TESEQ	CBL 6111D & 00800N1D01N-06	40103 & 07	30MHz~1GHz	Apr. 24, 2022	Apr. 16, 2023~ Apr. 22, 2023	Apr. 23, 2023	Radiation (03CH13-HY)
Bilog Antenna	TESEQ	CBL 6111D & 00800N1D01N-06	40103 & 07	30MHz~1GHz	Apr. 23, 2023	Apr. 23, 2023~ Jun. 07, 2023	Apr. 22, 2024	Radiation (03CH13-HY)
Horn Antenna	SCHWARZBECK	BBHA 9120 D	9120D-1326	1GHz~18GHz	Aug. 24, 2022	Apr. 16, 2023~ Jun. 07, 2023	Aug. 23, 2023	Radiation (03CH13-HY)
Preamplifier	MITEQ	AMF-7D-00101800-30-10P	1590074	1GHz~18GHz	May 17, 2022	Apr. 16, 2023~ May 15, 2023	May 16, 2023	Radiation (03CH13-HY)
Preamplifier	MITEQ	AMF-7D-00101800-30-10P	1590074	1GHz~18GHz	May 16, 2023	May 16, 2023~ Jun. 07, 2023	May 15, 2024	Radiation (03CH13-HY)
Preamplifier	Keysight	83017A	MY53270147	1GHz~26.5GHz	Oct. 25, 2022	Apr. 16, 2023~ Jun. 07, 2023	Oct. 24, 2023	Radiation (03CH13-HY)
Spectrum Analyzer	Keysight	N9010A	MY55370526	10Hz~44GHz	Mar. 23, 2023	Apr. 16, 2023~ Jun. 07, 2023	Mar. 22, 2024	Radiation (03CH13-HY)
Filter	Wainwright	WLK4-1000-1530-8000-40SS	SN12	1.53GHz Low Pass Filter	Sep. 13, 2022	Apr. 16, 2023~ Jun. 07, 2023	Sep. 12, 2023	Radiation (03CH13-HY)
Filter	Wainwright	WHKX12-2700-3000-18000-60SS	SN2	3GHz High Pass Filter	Jul. 11, 2022	Apr. 16, 2023~ Jun. 07, 2023	Jul. 10, 2023	Radiation (03CH13-HY)
Filter	Wainwright	WHKX8-5872.5-6750-18000-40ST	SN5	6.75GHz High Pass Filter	Mar. 09, 2023	Apr. 16, 2023~ Jun. 07, 2023	Mar. 08, 2024	Radiation (03CH13-HY)
Filter	Wainwright	WHKX6-7268-9200-26500-40CD	SN4	9GHz High Pass Filter	May 24, 2022	Apr. 16, 2023~ May 22, 2023	May 23, 2023	Radiation (03CH13-HY)
Filter	Wainwright	WHKX6-7268-9200-26500-40CD	SN4	9GHz High Pass Filter	May 23, 2023	May 23, 2023~ Jun. 07, 2023	May 22, 2024	Radiation (03CH13-HY)
Notch Filter	Wainwright	WRCQV14-5425-5825-6525-6925-60SS	SN1	N/A	Jan. 07, 2023	Apr. 16, 2023~ Jun. 07, 2023	Jan. 06, 2024	Radiation (03CH13-HY)
RF Cable	HUBER + SUHNER	SUCOFLEX 126E	0030/126E	30MHz~18GHz	Feb. 08, 2023	Apr. 16, 2023~ Jun. 07, 2023	Feb. 07, 2024	Radiation (03CH13-HY)
RF Cable	HUBER + SUHNER	SUCOFLEX 104	804793/4	30MHz~18GHz	Feb. 08, 2023	Apr. 16, 2023~ Jun. 07, 2023	Feb. 07, 2024	Radiation (03CH13-HY)
RF Cable	HUBER + SUHNER	SUCOFLEX 104	MY24961/4	30MHz~18GHz	Feb. 08, 2023	Apr. 16, 2023~ Jun. 07, 2023	Feb. 07, 2024	Radiation (03CH13-HY)
Controller	EMEC	EM1000	N/A	Control Turn table & Ant Mast	N/A	Apr. 16, 2023~ Jun. 07, 2023	N/A	Radiation (03CH13-HY)
Antenna Mast	EMEC	AM-BS-4500-B	N/A	1m~4m	N/A	Apr. 16, 2023~ Jun. 07, 2023	N/A	Radiation (03CH13-HY)
Turn Table	EMEC	TT2000	N/A	0~360 Degree	N/A	Apr. 16, 2023~ Jun. 07, 2023	N/A	Radiation (03CH13-HY)
Software	Audix	N/A	RK-001124	N/A	N/A	Apr. 16, 2023~ Jun. 07, 2023	N/A	Radiation (03CH13-HY)



5 Measurement Uncertainty

Uncertainty of Radiated Emission Measurement (30 MHz ~ 1000 MHz)

Measuring Uncertainty for a Level of Confidence of 95% ($U = 2Uc(y)$)	6.5 dB
---	--------

Uncertainty of Radiated Emission Measurement (1000 MHz ~ 6000 MHz)

Measuring Uncertainty for a Level of Confidence of 95% ($U = 2Uc(y)$)	4.4 dB
---	--------

Uncertainty of Radiated Emission Measurement (6000 MHz ~ 18000 MHz)

Measuring Uncertainty for a Level of Confidence of 95% ($U = 2Uc(y)$)	4.8 dB
---	--------

Uncertainty of Radiated Emission Measurement (18000 MHz ~ 40000 MHz)

Measuring Uncertainty for a Level of Confidence of 95% ($U = 2Uc(y)$)	5.3 dB
---	--------



Appendix A. Radiated Spurious Emission

Test Engineer :	Jacky Hung, Mancy Chou, Michael Liu and	Temperature :	20~25°C
	Rain Lee	Relative Humidity :	50~60%



2.4GHz 2402~2480MHz + Band 4 - 5725~5825MHz

802.11g_Tx_Ch06 + 802.11a_Tx_Ch165 (Band Edge @ 3m)

WIFI	Note	Frequency	Level	Margin	Limit	Read	Antenna	Path	Preamp	Ant	Table	Peak	Pol.	
Ant.					Line	Level	Factor	Loss	Factor	Pos	Pos	Avg.		
Simultaneously		(MHz)	(dBμV/m)	(dB)	(dBμV/m)	(dBμV)	(dB/m)	(dB)	(dB)	(cm)	(deg)	(P/A)	(H/V)	
802.11g CH 06 2437MHz		2389.8	56.05	-17.95	74	42.03	27.46	14.34	27.78	100	98	P	H	
		2389.2	45.17	-8.83	54	31.15	27.46	14.34	27.78	100	98	A	H	
	*	2437	112.81	-	-	98.46	27.72	14.39	27.76	100	98	P	H	
	*	2437	105.35	-	-	91	27.72	14.39	27.76	100	98	A	H	
		2497.34	55.85	-18.15	74	41.25	27.89	14.45	27.74	100	98	P	H	
		2484.88	45.52	-8.48	54	30.96	27.87	14.44	27.75	100	98	A	H	
		2364.3	56.13	-17.87	74	42.24	27.36	14.32	27.79	393	79	P	V	
		2387.25	44.71	-9.29	54	30.7	27.45	14.34	27.78	393	79	A	V	
	*	2437	111.62	-	-	97.27	27.72	14.39	27.76	393	79	P	V	
	*	2437	104.07	-	-	89.72	27.72	14.39	27.76	393	79	A	V	
		2483.62	56.34	-17.66	74	41.78	27.87	14.44	27.75	393	79	P	V	
		2483.62	45.29	-8.71	54	30.73	27.87	14.44	27.75	393	79	A	V	
	802.11a CH 165 5825MHz	*	5825	102.72	-	-	89.02	34.25	6.93	27.48	100	85	P	H
		*	5825	95.72	-	-	82.02	34.25	6.93	27.48	100	85	A	H
		5852	54.66	-62.98	117.64	40.9	34.31	6.94	27.49	100	85	P	H	
		5871	54.69	-51.63	106.32	40.87	34.38	6.94	27.5	100	85	P	H	
		5908.8	54.06	-26.09	80.15	40.11	34.5	6.96	27.51	100	85	P	H	
		5941	54.44	-13.76	68.2	40.48	34.5	6.97	27.51	100	85	P	H	
*		5825	104.09	-	-	90.39	34.25	6.93	27.48	313	115	P	V	
*		5825	97.3	-	-	83.6	34.25	6.93	27.48	313	115	A	V	
		5851.6	53.52	-65.03	118.55	39.76	34.31	6.94	27.49	313	115	P	V	
		5874.8	55.02	-50.24	105.26	41.17	34.4	6.95	27.5	313	115	P	V	
		5875	54.46	-50.74	105.2	40.61	34.4	6.95	27.5	313	115	P	V	
		5945.8	53.72	-14.48	68.2	39.77	34.5	6.97	27.52	313	115	P	V	
Remark	1. No other spurious found. 2. All results are PASS against Peak and Average limit line.													



802.11g_Tx_Ch06 + 802.11a_Tx_Ch165 (Harmonic @ 3m)

WIFI Ant. Simultaneously	Note	Frequency (MHz)	Level (dBμV/m)	Margin (dB)	Limit Line (dBμV/m)	Read Level (dBμV)	Antenna Factor (dB/m)	Path Loss (dB)	Preamp Factor (dB)	Ant Pos (cm)	Table Pos (deg)	Peak Avg. (P/A)	Pol. (H/V)	
802.11g CH 06 2437MHz + 802.11a CH 165 5825MHz		4874	54.66	-19.34	74	42.74	32.65	6.75	27.48	100	100	P	H	
		4874	44.52	-9.48	54	32.6	32.65	6.75	27.48	100	100	A	H	
		7311	43.95	-30.05	74	55.05	36.96	9.27	57.33	-	-	P	H	
		11650	45.04	-28.96	74	51.46	38.6	11.05	56.07	-	-	P	H	
		17475	59.59	-8.61	68.2	63.77	38.85	13.98	57.01	300	57	P	H	
														H
														H
														H
														H
														H
														H
														H
														H
			4874	54.35	-19.65	74	42.43	32.65	6.75	27.48	400	80	P	V
			4874	44.61	-9.39	54	32.69	32.65	6.75	27.48	400	80	A	V
			7311	45.06	-28.94	74	56.16	36.96	9.27	57.33	-	-	P	V
			11650	44.96	-29.04	74	51.38	38.6	11.05	56.07	-	-	P	V
			17475	65.71	-2.49	68.2	69.89	38.85	13.98	57.01	100	60	P	V
														V
														V
													V	
													V	
													V	
													V	
													V	
Remark	1. No other spurious found. 2. All results are PASS against Peak and Average limit line. 3. The emission position marked as "-" means no suspected emission found with sufficient margin against limit line or noise floor only.													



Emission below 1GHz

802.11g_Tx_Ch06 + 802.11a_Tx_Ch165 (LF @ 3m)

WIFI	Note	Frequency	Level	Margin	Limit	Read	Antenna	Path	Preamp	Ant	Table	Peak	Pol.	
Ant.					Line	Level	Factor	Loss	Factor	Pos	Pos	Avg.		
Simultaneously		(MHz)	(dBμV/m)	(dB)	(dBμV/m)	(dBμV)	(dB/m)	(dB)	(dB)	(cm)	(deg)	(P/A)	(H/V)	
802.11g CH 06 2437MHz + 802.11a CH 165 5825MHz LF		30.81	22.86	-17.14	40	29.51	24.69	0.82	32.16	-	-	P	H	
		128.01	19.14	-24.36	43.5	32.27	17.73	1.27	32.13	-	-	P	H	
		260.04	20.1	-25.9	46	30.42	20.03	1.71	32.06	-	-	P	H	
		587.7	27.21	-18.79	46	31.19	25.91	2.08	31.97	-	-	P	H	
		943.3	33.87	-12.13	46	31.47	30.37	3.05	31.02	-	-	P	H	
		967.1	34.19	-19.81	54	30.78	31.12	3.09	30.8	-	-	A	H	
			31.62	23.08	-16.92	40	30.22	24.21	0.81	32.16	-	-	P	V
			135.3	17.51	-25.99	43.5	30.62	17.69	1.3	32.1	-	-	P	V
			262.47	19.9	-26.1	46	29.99	20.25	1.72	32.06	-	-	P	V
			575.8	27.51	-18.49	46	31.32	26.05	2.16	32.02	-	-	P	V
		954.5	33.77	-12.23	46	30.78	30.84	3.07	30.92	-	-	P	V	
		995.8	33.78	-20.22	54	30.64	30.49	3.15	30.5	-	-	A	V	
Remark	<ol style="list-style-type: none"> No other spurious found. All results are PASS against limit line. The emission position marked as "-" means no suspected emission found and emission level has at least 6dB margin against limit or emission is noise floor only. 													



2.4GHz 2402~2480MHz + Band 5 - 5925~6425MHz

802.11g_Tx_Ch06 + 802.11a_Tx_Ch01 (Band Edge @ 3m)

WIFI	Note	Frequency	Level	Margin	Limit	Read	Antenna	Path	Preamp	Ant	Table	Peak	Pol.
Ant.					Line	Level	Factor	Loss	Factor	Pos	Pos	Avg.	
Simultaneously		(MHz)	(dBμV/m)	(dB)	(dBμV/m)	(dBμV)	(dB/m)	(dB)	(dB)	(cm)	(deg)	(P/A)	(H/V)
802.11g CH 06 2437MHz		2328.2	54.49	-19.51	74	40.7	27.3	14.29	27.8	131	146	P	H
		2389.52	44.82	-9.18	54	30.8	27.46	14.34	27.78	131	146	A	H
	*	2437	113.07	-	-	98.72	27.72	14.39	27.76	131	146	P	H
	*	2437	105.34	-	-	90.99	27.72	14.39	27.76	131	146	A	H
		2483.55	54.63	-19.37	74	40.07	27.87	14.44	27.75	131	146	P	H
		2483.76	45.17	-8.83	54	30.61	27.87	14.44	27.75	131	146	A	H
		2386.44	54.4	-19.6	74	40.39	27.45	14.34	27.78	110	102	P	V
		2389.94	44.66	-9.34	54	30.64	27.46	14.34	27.78	110	102	A	V
	*	2437	112.88	-	-	98.53	27.72	14.39	27.76	110	102	P	V
	*	2437	105.46	-	-	91.11	27.72	14.39	27.76	110	102	A	V
		2496.57	54.9	-19.1	74	40.3	27.89	14.45	27.74	110	102	P	V
		2483.83	45.44	-8.56	54	30.88	27.87	14.44	27.75	110	102	A	V
	802.11a CH 01 5955MHz		5911.1	59.15	-29.05	88.2	44.72	34.5	7.44	27.51	100	122	P
		5924.4	47.61	-20.59	68.2	33.17	34.5	7.45	27.51	100	122	A	H
*		5955	107.88	-	-	93.44	34.48	7.48	27.52	100	122	P	H
*		5955	99.94	-	-	85.5	34.48	7.48	27.52	100	122	A	H
													H
													H
		5913.62	58.5	-29.7	88.2	44.07	34.5	7.44	27.51	100	317	P	V
		5924.96	46.07	-22.13	68.2	31.63	34.5	7.45	27.51	100	317	A	V
*		5955	104.61	-	-	90.17	34.48	7.48	27.52	100	317	P	V
*		5955	96.11	-	-	81.67	34.48	7.48	27.52	100	317	A	V
													V
												V	
Remark	1. No other spurious found. 2. All results are PASS against Peak and Average limit line.												



2.4GHz 2402~2480MHz + Band 5 - 5925~6425MHz

802.11g_Tx_Ch06 + 802.11a_Tx_Ch01 (Harmonic @ 3m)

WIFI	Note	Frequency	Level	Margin	Limit	Read	Antenna	Path	Preamp	Ant	Table	Peak	Pol.	
Ant.					Line	Level	Factor	Loss	Factor	Pos	Pos	Avg.		
Simultaneously		(MHz)	(dBμV/m)	(dB)	(dBμV/m)	(dBμV)	(dB/m)	(dB)	(dB)	(cm)	(deg)	(P/A)	(H/V)	
802.11g CH 06 2437MHz + 802.11a CH 01 5955MHz		4874	51.91	-22.09	74	39.99	32.65	6.75	27.48	400	339	P	H	
		4874	44.65	-9.35	54	32.73	32.65	6.75	27.48	400	339	A	H	
		7311	44.6	-29.4	74	54.69	36.96	9.78	56.83	-	-	P	H	
		11910	44.96	-29.04	74	51.36	38.63	10.9	55.93	-	-	P	H	
		17865	64.36	-9.64	74	65.93	41.15	13.97	56.69	310	64	P	H	
		17865	47.99	-6.01	54	49.56	41.15	13.97	56.69	310	64	A	H	
														H
														H
														H
														H
														H
														H
														H
			4874	52.43	-21.57	74	40.51	32.65	6.75	27.48	205	192	P	V
			4874	44.65	-9.35	54	32.73	32.65	6.75	27.48	205	192	A	V
			7311	45.09	-28.91	74	55.18	36.96	9.78	56.83	-	-	P	V
			11910	44.61	-29.39	74	51.01	38.63	10.9	55.93	-	-	P	V
			17865	64.41	-9.59	74	65.98	41.15	13.97	56.69	226	12	P	V
			17865	47.74	-6.26	54	49.31	41.15	13.97	56.69	226	12	A	V
														V
													V	
													V	
													V	
													V	
													V	
Remark	<ol style="list-style-type: none"> No other spurious found. All results are PASS against Peak and Average limit line. The emission position marked as "-" means no suspected emission found with sufficient margin against limit line or noise floor only. 													



2.4GHz 2402~2480MHz + Band 1 - 5150~5250MHz

BLE_Tx_C00 + 802.11a_Tx_Ch44 (Band Edge @ 3m)

BLE + WIFI	Note	Frequency	Level	Margin	Limit	Read	Antenna	Path	Preamp	Ant	Table	Peak	Pol.	
Ant.					Line	Level	Factor	Loss	Factor	Pos	Pos	Avg.		
Simultaneously		(MHz)	(dBμV/m)	(dB)	(dBμV/m)	(dBμV)	(dB/m)	(dB)	(dB)	(cm)	(deg)	(P/A)	(H/V)	
BLE CH 00 2402MHz		2338.35	55.24	-18.76	74	41.43	27.3	14.3	27.79	106	92	P	H	
		2389.275	44.35	-9.65	54	30.33	27.46	14.34	27.78	106	92	A	H	
	*	2402	110.18	-	-	96.09	27.51	14.35	27.77	106	92	P	H	
	*	2402	107.47	-	-	93.38	27.51	14.35	27.77	106	92	A	H	
													H	
														H
			2383.08	54.94	-19.06	74	40.95	27.43	14.34	27.78	397	119	P	V
			2376.255	44.27	-9.73	54	30.31	27.41	14.33	27.78	397	119	A	V
	*		2402	107.19	-	-	93.1	27.51	14.35	27.77	397	119	P	V
	*		2402	105.33	-	-	91.24	27.51	14.35	27.77	397	119	A	V
														V
														V
802.11a CH 44 5220MHz		5081.38	54.64	-19.36	74	42.32	33.27	6.5	27.45	100	272	P	H	
		5104.52	44.95	-9.05	54	32.66	33.2	6.54	27.45	100	272	A	H	
	*	5220	107.92	-	-	95.47	33.16	6.72	27.43	100	272	P	H	
	*	5220	102.83	-	-	90.38	33.16	6.72	27.43	100	272	A	H	
			5454.4	53.09	-20.91	74	40.57	33.1	6.83	27.41	100	272	P	H
			5455.52	43.66	-10.34	54	31.14	33.1	6.83	27.41	100	272	A	H
			5076.7	55.51	-18.49	74	43.18	33.29	6.49	27.45	312	111	P	V
			5067.08	45	-9	54	32.65	33.33	6.47	27.45	312	111	A	V
	*		5220	107	-	-	94.55	33.16	6.72	27.43	312	111	P	V
	*		5220	101.66	-	-	89.21	33.16	6.72	27.43	312	111	A	V
			5371.24	52.38	-21.62	74	39.87	33.1	6.83	27.42	312	111	P	V
			5439.56	43.66	-10.34	54	31.14	33.1	6.83	27.41	312	111	A	V
Remark	1. No other spurious found. 2. All results are PASS against Peak and Average limit line.													



BLE_Tx_C00 + 802.11a_Tx_Ch44 (Harmonic @ 3m)

BLE + WIFI Ant. Simultaneously	Note	Frequency (MHz)	Level (dBμV/m)	Margin (dB)	Limit Line (dBμV/m)	Read Level (dBμV)	Antenna Factor (dB/m)	Path Loss (dB)	Preamp Factor (dB)	Ant Pos (cm)	Table Pos (deg)	Peak Avg. (P/A)	Pol. (H/V)	
BLE CH 00 2402MHz + 802.11a CH 44 5220MHz		4804	51.01	-22.99	74	39.83	32.42	6.24	27.48	100	272	P	H	
		4804	44.14	-9.86	54	32.96	32.42	6.24	27.48	100	272	A	H	
		10440	45.14	-23.06	68.2	51.75	39.1	10.76	56.47	-	-	P	H	
		15660	55.16	-18.84	74	61.06	37.88	12.59	56.37	100	79	P	H	
		15660	43.96	-10.04	54	49.86	37.88	12.59	56.37	100	79	A	H	
														H
														H
														H
														H
														H
														H
														H
														H
			4804	53.2	-20.8	74	42.02	32.42	6.24	27.48	312	111	P	V
			4804	44.83	-9.17	54	33.65	32.42	6.24	27.48	312	111	A	V
			10440	45.54	-22.66	68.2	52.15	39.1	10.76	56.47	-	-	P	V
			15660	62.19	-11.81	74	68.09	37.88	12.59	56.37	100	79	P	V
			15660	48.37	-5.63	54	54.27	37.88	12.59	56.37	100	79	A	V
														V
														V
													V	
													V	
													V	
													V	
													V	
Remark	<ol style="list-style-type: none"> No other spurious found. All results are PASS against Peak and Average limit line. The emission position marked as "-" means no suspected emission found with sufficient margin against limit line or noise floor only. 													



Note symbol

*	Fundamental Frequency which can be ignored. However, tEHT level of any unwanted emissions shall not exceed tEHT level of tEHT fundamental frequency.
!	Test result is over limit line.
P/A	Peak or Average
H/V	Horizontal or Vertical



A calculation example for radiated spurious emission is shown as below:

WIFI	Note	Frequency	Level	Margin	Limit	Read	Antenna	Path	Preamp	Ant	Table	Peak	Pol.
Ant.		(MHz)	(dBμV/m)	(dB)	(dBμV/m)	(dBμV)	(dB/m)	(dB)	(dB)	(cm)	(deg)	(P/A)	(H/V)
3+4													
802.11a		5150	55.45	-18.55	74	54.51	32.22	4.58	35.86	103	308	P	H
CH 36													
5180MHz		5150	43.54	-10.46	54	42.6	32.22	4.58	35.86	103	308	A	H

1. Path Loss(dB) = Cable loss(dB) + Filter loss(dB) + Attenuator loss(dB)
2. Level(dBμV/m) =
Antenna Factor(dB/m) + Path Loss(dB) + Read Level(dBμV) - Preamp Factor(dB)
3. Margin(dB) = Level(dBμV/m) – Limit Line(dBμV/m)

For Peak Limit @ 2390MHz:

1. Level(dBμV/m)
= Antenna Factor(dB/m) + Path Loss(dB) + Read Level(dBμV) - Preamp Factor(dB)
= 32.22(dB/m) + 4.58(dB) + 54.51(dBμV) – 35.86 (dB)
= 55.45 (dBμV/m)
2. Margin(dB)
= Level(dBμV/m) – Limit Line(dBμV/m)
= 55.45(dBμV/m) – 74(dBμV/m)
= -18.55(dB)

For Average Limit @ 2390MHz:

1. Level(dBμV/m)
= Antenna Factor(dB/m) + Path Loss(dB) + Read Level(dBμV) - Preamp Factor(dB)
= 32.22(dB/m) + 4.58(dB) + 42.6(dBμV) – 35.86 (dB)
= 43.54 (dBμV/m)
2. Margin(dB)
= Level(dBμV/m) – Limit Line(dBμV/m)
= 43.54(dBμV/m) – 54(dBμV/m)
= -10.46(dB)

Both peak and average measured complies with the limit line, so test result is “PASS”.



Appendix B. Radiated Spurious Emission Plots

Test Engineer :	Jacky Hung, Mancy Chou, Michael Liu and	Temperature :	20~25°C
	Rain Lee	Relative Humidity :	50~60%

Note symbol

-L	Low channel location
-R	High channel location



2.4GHz 2402~2480MHz + Band 4 - 5725~5825MHz

802.11g_Tx_Ch06 + 802.11a_Tx_Ch165 (Band Edge @ 3m)

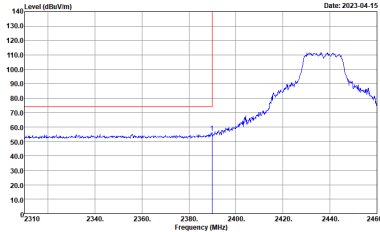
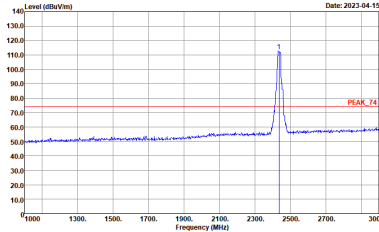
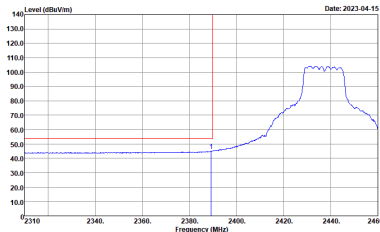
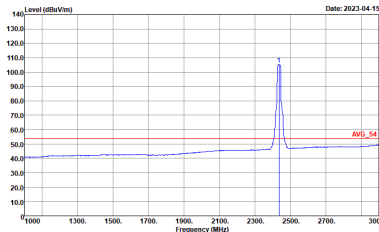
WIFI	2.4GHz 2400~2483.5MHz Band Edge @ 3m	
ANT	802.11g CH06 2437MHz - L	
3+4	Horizontal	Fundamental
Peak	 <p>Site : 03CH13-HY Condition : PEAK_BE_74 3m HORN_91200_1326 HORIZONTAL : RBW:1000.000kHz VBW:3000.000kHz SWT:Auto</p>	 <p>Site : 03CH13-HY Condition : PEAK_74 3m HORN_91200_1326 HORIZONTAL : RBW:1000.000kHz VBW:3000.000kHz SWT:Auto</p>
Avg.	 <p>Site : 03CH13-HY Condition : AVG_BE_54 3m HORN_91200_1326 HORIZONTAL : RBW:1000.000kHz VBW:1000kHz SWT:Auto</p>	 <p>Site : 03CH13-HY Condition : AVG_54 3m HORN_91200_1326 HORIZONTAL : RBW:1000.000kHz VBW:1000kHz SWT:Auto</p>

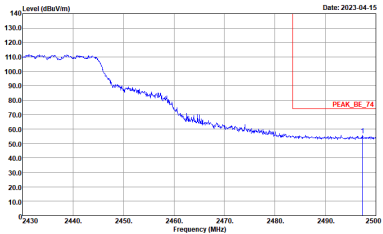
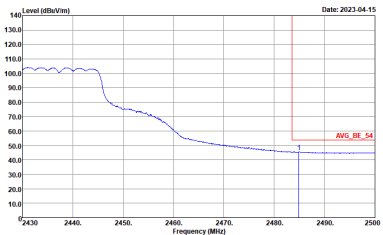

WIFI	2.4GHz 2400~2483.5MHz Band Edge @ 3m	
ANT	802.11g CH06 2437MHz - R	
3+4	Horizontal	Fundamental
<p>Peak</p>	 <p>Date: 2023-04-15</p> <p>Site : 03CH13+HY Condition : PEAK_BE_74 3m HORN_91200_1326 HORIZONTAL : RBW:1000.000KHz VBW:3000.000KHz SWT:Auto</p>	<p>Left blank</p>
<p>Avg.</p>	 <p>Date: 2023-04-15</p> <p>Site : 03CH13+HY Condition : AVG_BE_54 3m HORN_91200_1326 HORIZONTAL : RBW:1000.000KHz VBW:1.000KHz SWT:Auto</p>	<p>Left blank</p>



WIFI	2.4GHz 2400~2483.5MHz Band Edge @ 3m	
ANT	802.11g CH06 2437MHz - L	
3+4	Vertical	Fundamental
Peak	<p>Level (dBm/100kHz) vs Frequency (MHz) for Peak Vertical. The plot shows a signal rising from approximately 50 dBm/100kHz at 2380 MHz to a peak of about 110 dBm/100kHz at 2437 MHz. A red horizontal line is drawn at approximately 75 dBm/100kHz. The x-axis ranges from 2310 to 2460 MHz. The y-axis ranges from 10.0 to 140.0 dBm/100kHz. Date: 2023-04-15.</p> <p>Site : 03CH13-HY Condition : PEAK_BE_74 3m HORN_91200_1326 VERTICAL : RBW:1000.000kHz VBW:3000.000kHz SWT:Auto</p>	<p>Level (dBm/100kHz) vs Frequency (MHz) for Peak Fundamental. The plot shows a sharp peak at 2437 MHz reaching approximately 110 dBm/100kHz. A red horizontal line is drawn at approximately 75 dBm/100kHz, labeled 'PEAK_74'. The x-axis ranges from 1000 to 3000 MHz. The y-axis ranges from 10.0 to 140.0 dBm/100kHz. Date: 2023-04-15.</p> <p>Site : 03CH13-HY Condition : PEAK_74 3m HORN_91200_1326 VERTICAL : RBW:1000.000kHz VBW:3000.000kHz SWT:Auto</p>
Avg.	<p>Level (dBm/100kHz) vs Frequency (MHz) for Avg Vertical. The plot shows a signal rising from approximately 50 dBm/100kHz at 2380 MHz to a peak of about 110 dBm/100kHz at 2437 MHz. A red horizontal line is drawn at approximately 54 dBm/100kHz. The x-axis ranges from 2310 to 2460 MHz. The y-axis ranges from 10.0 to 140.0 dBm/100kHz. Date: 2023-04-15.</p> <p>Site : 03CH13-HY Condition : AVG_BE_54 3m HORN_91200_1326 VERTICAL : RBW:1000.000kHz VBW:1000kHz SWT:Auto</p>	<p>Level (dBm/100kHz) vs Frequency (MHz) for Avg Fundamental. The plot shows a sharp peak at 2437 MHz reaching approximately 110 dBm/100kHz. A red horizontal line is drawn at approximately 54 dBm/100kHz, labeled 'AVG_54'. The x-axis ranges from 1000 to 3000 MHz. The y-axis ranges from 10.0 to 140.0 dBm/100kHz. Date: 2023-04-15.</p> <p>Site : 03CH13-HY Condition : AVG_54 3m HORN_91200_1326 VERTICAL : RBW:1000.000kHz VBW:1000kHz SWT:Auto</p>

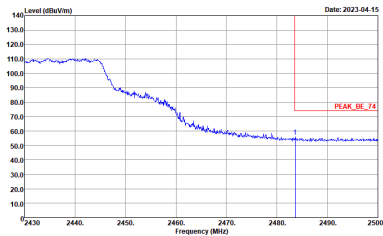
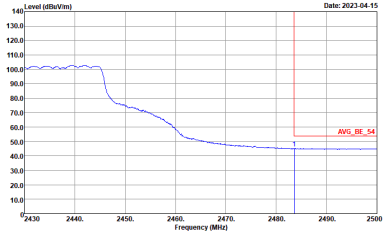

WIFI	2.4GHz 2400~2483.5MHz Band Edge @ 3m	
ANT	802.11g CH06 2437MHz - R	
3+4	Vertical	Fundamental
<p>Peak</p>	 <p>Site : 03CH13+HY Condition : PEAK_BE_74 3m HORN_91200_1326 VERTICAL : RBW:1000.000kHz VBW:3000.000kHz SWT:Auto</p>	<p>Left Blank</p>
<p>Avg.</p>	 <p>Site : 03CH13+HY Condition : AVG_BE_54 3m HORN_91200_1326 VERTICAL : RBW:1000.000kHz VBW:1.000kHz SWT:Auto</p>	<p>Left Blank</p>

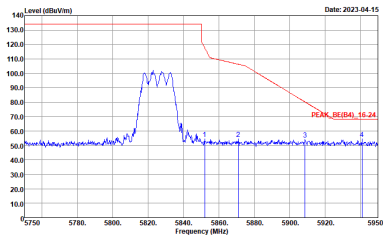
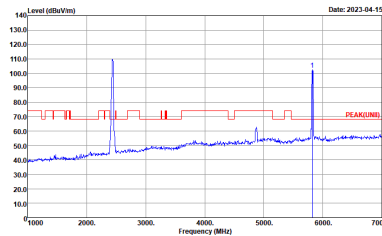
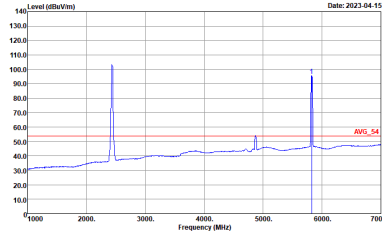

WIFI	Band 4 5725~5850MHz Band Edge @ 3m	
ANT	802.11a CH165 5825MHz	
3+4	Horizontal	Fundamental
Peak	 <p>Site : 03CH13-HY Condition : PEAK_86(84)_16-24 3m HORN_91200_1326 HORIZONTAL : RBW:1000.000kHz VBW:3000.000kHz SWT:Auto</p>	 <p>Site : 03CH13-HY Condition : PEAK(LINE) 3m HORN_91200_1326 HORIZONTAL : RBW:1000.000kHz VBW:3000.000kHz SWT:Auto</p>
Avg.	Left blank	 <p>Site : 03CH13-HY Condition : AVG_54 3m HORN_91200_1326 HORIZONTAL : RBW:1000.000kHz VBW:1.000kHz SWT:Auto</p>

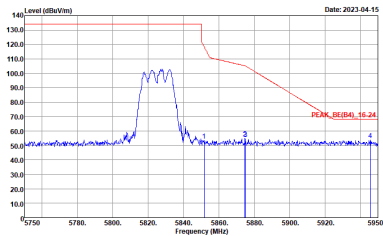
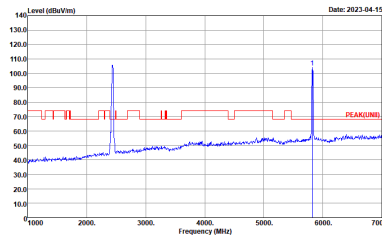
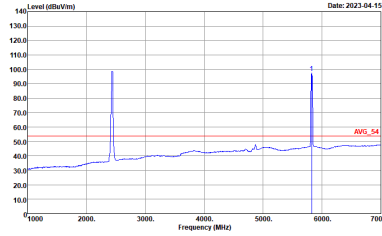

WIFI	Band 4 5725~5850MHz Band Edge @ 3m	
ANT	802.11a CH165 5825MHz	
3+4	Vertical	Fundamental
Peak	 <p>Site : 03CH13-HY Condition : PEAK_82(84)_16-24 3m HORN_91200_1326 VERTICAL : RBW:1000.000KHz VBW:3000.000KHz SWT:Auto</p>	 <p>Site : 03CH13-HY Condition : PEAK(LMB) 3m HORN_91200_1326 VERTICAL : RBW:1000.000KHz VBW:3000.000KHz SWT:Auto</p>
Avg.	Left blank	 <p>Site : 03CH13-HY Condition : AVG_54 3m HORN_91200_1326 VERTICAL : RBW:1000.000KHz VBW:1.000KHz SWT:Auto</p>

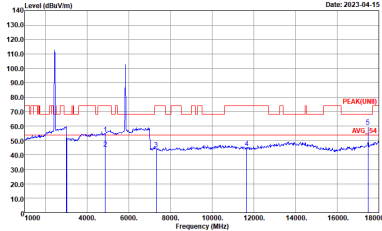
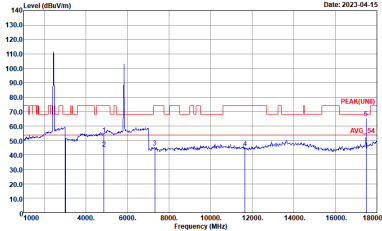

802.11g_Tx_Ch06 + 802.11a_Tx_Ch165 (Harmonic @ 3m)

WIFI	2.4GHz 2402~2480MHz + Band 4 - 5725~5825MHz	
ANT	802.11g_Tx_Ch06 + 802.11a_Tx_Ch165	
Simultaneously	Horizontal	Vertical
Peak Avg.	 <p>Site : 03CH13-HY Condition : PEAK[UNIT] 3m HORN_9120D_1326 HORIZONTAL</p>	 <p>Site : 03CH13-HY Condition : PEAK[UNIT] 3m HORN_9120D_1326 VERTICAL</p>



WIFI	2.4GHz 2402~2480MHz + Band 4 - 5725~5825MHz	
ANT	802.11g_Tx_Ch06 + 802.11a_Tx_Ch165	
Simultaneously	Horizontal	Vertical
Avg.		
Avg.		



Emission below 1GHz

802.11g_Tx_Ch06 + 802.11a_Tx_Ch165 (LF @ 3m)

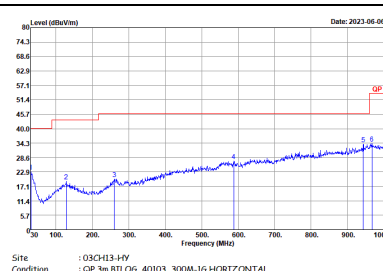
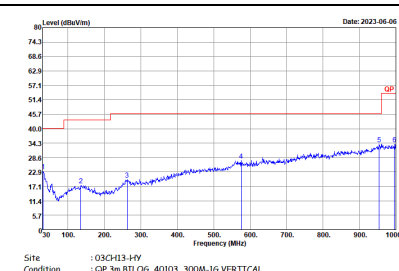
WIFI	2.4GHz 2402~2480MHz + Band 4 - 5725~5825MHz	
ANT	802.11g_Tx_Ch06 + 802.11a_Tx_Ch165	
Simultaneously	Horizontal	Vertical
QP / Peak	 <p>Site : 03CH13-HY Condition : QP 3m BIL06_40103_300M-16-HORIZONTAL</p>	 <p>Site : 03CH13-HY Condition : QP 3m BIL06_40103_300M-16-VERTICAL</p>



2.4GHz 2402~2480MHz + Band 5 - 5925~6425MHz

802.11g_Tx_Ch06 + 802.11a_Tx_Ch01 (Band Edge @ 3m)

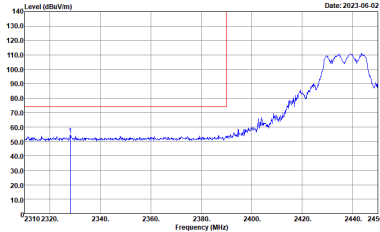
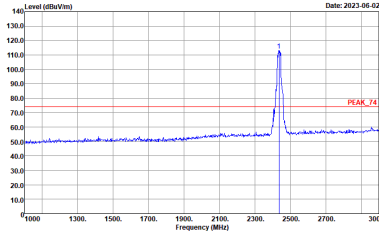
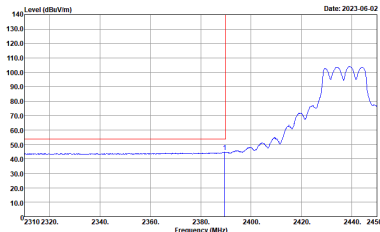
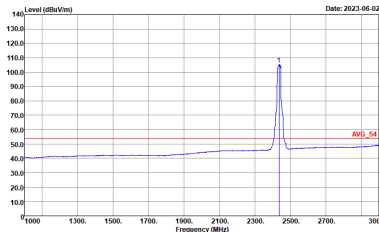
WIFI	2.4GHz 2400~2483.5MHz Band Edge @ 3m	
ANT	802.11g CH06 2437MHz - L	
3+4	Horizontal	Fundamental
Peak	 <p>Site : 03CH13-HY Condition : PEAK_BE_74 3m HORN_9120D_1326 HORIZONTAL : RBW:1000.000kHz VBW:3000.000kHz SWT:Auto</p>	 <p>Site : 03CH13-HY Condition : PEAK_74 3m HORN_9120D_1326 HORIZONTAL : RBW:1000.000kHz VBW:3000.000kHz SWT:Auto</p>
Avg.	 <p>Site : 03CH13-HY Condition : AVG_BE_54 3m HORN_9120D_1326 HORIZONTAL : RBW:1000.000kHz VBW:1.000kHz SWT:Auto</p>	 <p>Site : 03CH13-HY Condition : AVG_54 3m HORN_9120D_1326 HORIZONTAL : RBW:1000.000kHz VBW:1.000kHz SWT:Auto</p>

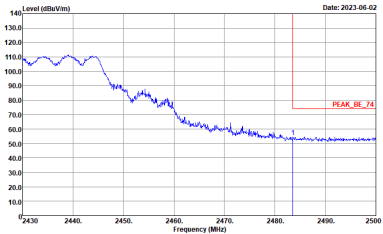
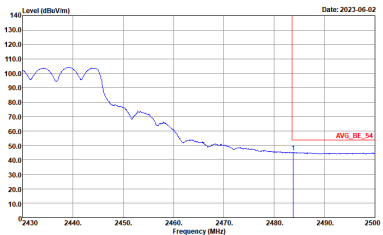

WIFI	2.4GHz 2400~2483.5MHz Band Edge @ 3m	
ANT	802.11g CH06 2437MHz - R	
3+4	Horizontal	Fundamental
<p>Peak</p>	 <p>Date: 2023-06-02</p> <p>Site : 03CH13-HY Condition : PEAK_BE_74 3m HORN_91200_1326 HORIZONTAL : RBW:1000.000kHz VBW:3000.000kHz SWT:Auto</p>	<p>Left blank</p>
<p>Avg.</p>	 <p>Date: 2023-06-02</p> <p>Site : 03CH13-HY Condition : AVG_BE_54 3m HORN_91200_1326 HORIZONTAL : RBW:1000.000kHz VBW:1.000kHz SWT:Auto</p>	<p>Left blank</p>

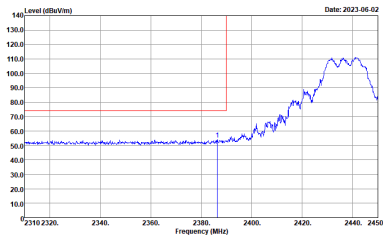
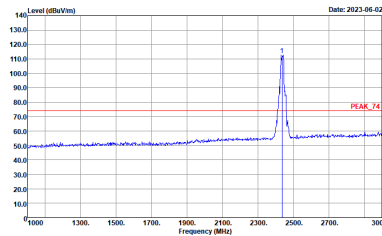
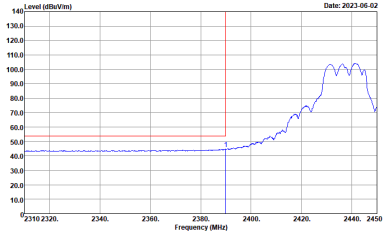
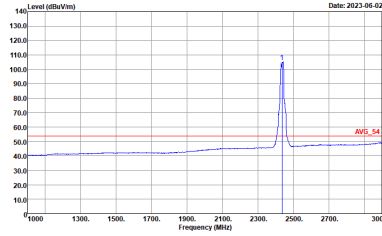

WIFI	2.4GHz 2400~2483.5MHz Band Edge @ 3m	
ANT	802.11g CH06 2437MHz - L	
3+4	Vertical	Fundamental
Peak	 <p>Date: 2023-06-02</p> <p>Site : 03CH13-HY Condition : PEAK_BE_74 3m HORN_9120D_1326 VERTICAL : RBW:1000.000kHz VBW:3000.000kHz SWT:Auto</p>	 <p>Date: 2023-06-02</p> <p>Site : 03CH13-HY Condition : PEAK_74 3m HORN_9120D_1326 VERTICAL : RBW:1000.000kHz VBW:3000.000kHz SWT:Auto</p>
Avg.	 <p>Date: 2023-06-02</p> <p>Site : 03CH13-HY Condition : AVG_BE_54 3m HORN_9120D_1326 VERTICAL : RBW:1000.000kHz VBW:1.000kHz SWT:Auto</p>	 <p>Date: 2023-06-02</p> <p>Site : 03CH13-HY Condition : AVG_54 3m HORN_9120D_1326 VERTICAL : RBW:1000.000kHz VBW:1.000kHz SWT:Auto</p>

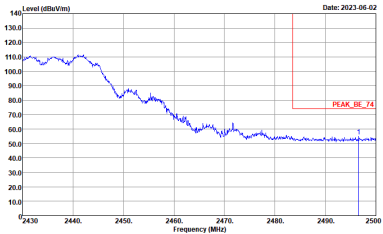
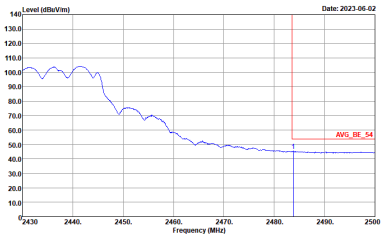

WIFI	2.4GHz 2400~2483.5MHz Band Edge @ 3m	
ANT	802.11g CH06 2437MHz - R	
3+4	Vertical	Fundamental
<p>Peak</p>	 <p>Date: 2023-06-02</p> <p>Site : 03CH13-HY Condition : PEAK_BE_74 3m HORN_9120D_1326 VERTICAL : RBW:1000.000kHz VBW:3000.000kHz SWT:Auto</p>	<p>Left Blank</p>
<p>Avg.</p>	 <p>Date: 2023-06-02</p> <p>Site : 03CH13-HY Condition : AVG_BE_54 3m HORN_9120D_1326 VERTICAL : RBW:1000.000kHz VBW:1.000kHz SWT:Auto</p>	<p>Left Blank</p>

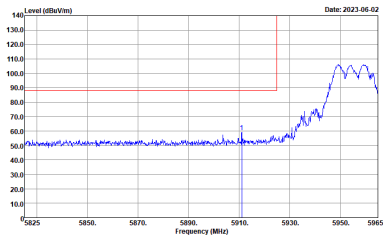
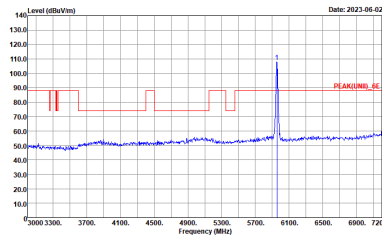
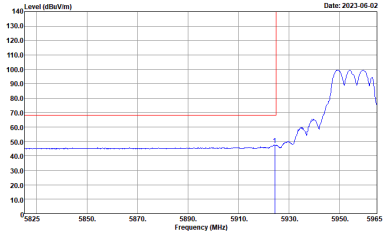
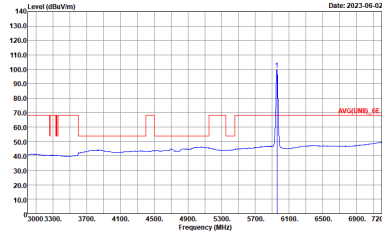

WIFI	Band 5 5925~6425MHz Band Edge @ 3m	
ANT	802.11a CH01 5955MHz	
3+4	Horizontal	Fundamental
Peak	 <p>Level (dBV/m) vs Frequency (MHz) plot for Horizontal Peak. The y-axis ranges from 10.0 to 140.0 dBV/m, and the x-axis ranges from 5825 to 5965 MHz. A red line indicates the peak level at approximately 135 dBV/m around 5955 MHz. A blue line shows the noise floor around 50 dBV/m.</p> <p>Site : 03CH13-HY Condition : PEAK_BE(UNIT)_6E 3m HORN_91200_1326 HORIZONTAL : RBW:1000.000kHz VBW:3000.000kHz SWT:Auto</p>	 <p>Level (dBV/m) vs Frequency (MHz) plot for Fundamental Peak. The y-axis ranges from 10.0 to 140.0 dBV/m, and the x-axis ranges from 3000 to 7200 MHz. A red line indicates the peak level at approximately 135 dBV/m around 5955 MHz. A blue line shows the noise floor around 50 dBV/m.</p> <p>Site : 03CH13-HY Condition : PEAK(UNIT)_6E 3m HORN_91200_1326 HORIZONTAL : RBW:1000.000kHz VBW:3000.000kHz SWT:Auto</p>
Avg.	 <p>Level (dBV/m) vs Frequency (MHz) plot for Horizontal Avg. The y-axis ranges from 10.0 to 140.0 dBV/m, and the x-axis ranges from 5825 to 5965 MHz. A red line indicates the average level at approximately 70 dBV/m around 5955 MHz. A blue line shows the noise floor around 50 dBV/m.</p> <p>Site : 03CH13-HY Condition : AVG_BE(UNIT)_6E 3m HORN_91200_1326 HORIZONTAL : RBW:1000.000kHz VBW:1.000kHz SWT:Auto</p>	 <p>Level (dBV/m) vs Frequency (MHz) plot for Fundamental Avg. The y-axis ranges from 10.0 to 140.0 dBV/m, and the x-axis ranges from 3000 to 7200 MHz. A red line indicates the average level at approximately 70 dBV/m around 5955 MHz. A blue line shows the noise floor around 50 dBV/m.</p> <p>Site : 03CH13-HY Condition : AVG(UNIT)_6E 3m HORN_91200_1326 HORIZONTAL : RBW:1000.000kHz VBW:1.000kHz SWT:Auto</p>

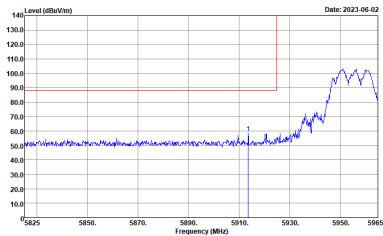
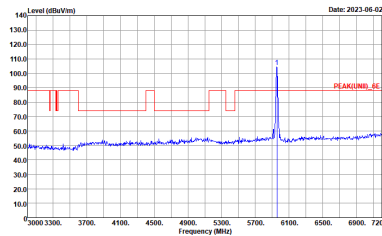
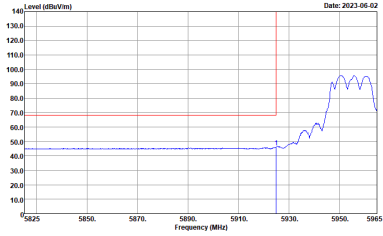
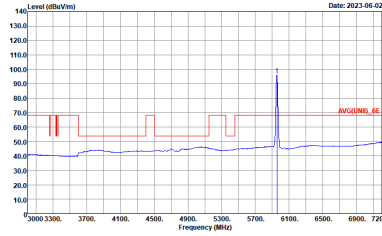

WIFI	Band 5 5925~6425MHz Band Edge @ 3m	
ANT	802.11a CH01 5955MHz	
3+4	Vertical	Fundamental
Peak	 <p>Level (dBV/m) vs Frequency (MHz) plot for Vertical Peak. The y-axis ranges from 10.0 to 140.0 dBV/m, and the x-axis ranges from 5825 to 5965 MHz. A red line indicates the peak level at approximately 90 dBV/m. A blue line shows the noise floor. The date is 2023-06-02.</p> <p>Site : 03CH13-HY Condition : PEAK_BE(UNIT)_6E 3m HORN_91200_1326 VERTICAL : RBW:1000.000kHz VBW:3000.000kHz SWT:Auto</p>	 <p>Level (dBV/m) vs Frequency (MHz) plot for Fundamental Peak. The y-axis ranges from 10.0 to 140.0 dBV/m, and the x-axis ranges from 3000 to 7200 MHz. A red line indicates the peak level at approximately 90 dBV/m. A blue line shows the noise floor. The date is 2023-06-02.</p> <p>Site : 03CH13-HY Condition : PEAK(UNIT)_6E 3m HORN_91200_1326 VERTICAL : RBW:1000.000kHz VBW:3000.000kHz SWT:Auto</p>
Avg.	 <p>Level (dBV/m) vs Frequency (MHz) plot for Vertical Avg. The y-axis ranges from 10.0 to 140.0 dBV/m, and the x-axis ranges from 5825 to 5965 MHz. A red line indicates the average level at approximately 70 dBV/m. A blue line shows the noise floor. The date is 2023-06-02.</p> <p>Site : 03CH13-HY Condition : AVG_BE(UNIT)_6E 3m HORN_91200_1326 VERTICAL : RBW:1000.000kHz VBW:1.000kHz SWT:Auto</p>	 <p>Level (dBV/m) vs Frequency (MHz) plot for Fundamental Avg. The y-axis ranges from 10.0 to 140.0 dBV/m, and the x-axis ranges from 3000 to 7200 MHz. A red line indicates the average level at approximately 70 dBV/m. A blue line shows the noise floor. The date is 2023-06-02.</p> <p>Site : 03CH13-HY Condition : AVG(UNIT)_6E 3m HORN_91200_1326 VERTICAL : RBW:1000.000kHz VBW:1.000kHz SWT:Auto</p>

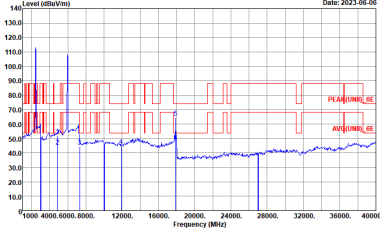
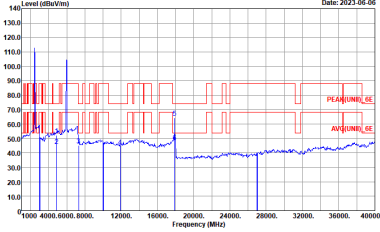

802.11g_Tx_Ch06 + 802.11a_Tx_Ch01 (Harmonic @ 3m)

WIFI	2.4GHz 2402~2480MHz + Band 5 - 5925~6425MHz	
ANT	802.11g_Tx_Ch06 + 802.11a_Tx_Ch01	
Simultaneously	Horizontal	Vertical
Peak Avg.	 <p>Site : 03CH13-HY Condition : PEAK(UNIT)_0E 1m SHF_993_1124 HORIZONTAL</p>	 <p>Site : 03CH13-HY Condition : PEAK(UNIT)_0E 1m SHF_993_1124 VERTICAL</p>



WIFI	2.4GHz 2402~2480MHz + Band 5 - 5925~6425MHz	
ANT	802.11g_Tx_Ch06 + 802.11a_Tx_Ch01	
Simultaneously	Horizontal	Vertical
Avg.	<p>Site : 03CH13-HY Condition : AV6(UNIT)_6E 3m HORN_9120D_1326 HORIZONTAL</p>	<p>Site : 03CH13-HY Condition : AV6(UNIT)_6E 3m HORN_9120D_1326 VERTICAL</p>
Avg.	<p>Site : 03CH13-HY Condition : AV6(UNIT)_6E 3m HORN_9120D_1326 HORIZONTAL</p>	<p>Site : 03CH13-HY Condition : AV6(UNIT)_6E 3m HORN_9120D_1326 VERTICAL</p>



2.4GHz 2402~2480MHz + Band 1 - 5150~5250MHz
 BLE_Tx_C00 + 802.11a_Tx_Ch44 (Band Edge @ 3m)

BLE+ WIFI	2.4GHz 2400~2483.5MHz Band Edge @ 3m	
ANT	BLE CH00 2402MHz	
3+4	Horizontal	Fundamental
Peak	<p>Site : 03CH13-HY Condition : PEAK_BE_74 3m HORN_91200_1326 HORIZONTAL : RBW:1000.000kHz VBW:3000.000kHz SWT:Auto</p>	<p>Site : 03CH13-HY Condition : PEAK_74 3m HORN_91200_1326 HORIZONTAL : RBW:1000.000kHz VBW:3000.000kHz SWT:Auto</p>
Avg.	<p>Site : 03CH13-HY Condition : AVG_BE_54 3m HORN_91200_1326 HORIZONTAL : RBW:1000.000kHz VBW:1000kHz SWT:Auto</p>	<p>Site : 03CH13-HY Condition : AVG_54 3m HORN_91200_1326 HORIZONTAL : RBW:1000.000kHz VBW:1000kHz SWT:Auto</p>



<p>BLE+ WIFI</p>	<p>2.4GHz 2400~2483.5MHz Band Edge @ 3m</p>	
<p>ANT</p>	<p>BLE CH00 2402MHz</p>	
<p>3+4</p>	<p>Vertical</p>	<p>Fundamental</p>
<p>Peak</p>	<p>Site : 03CH13-HY Condition : PEAK_BE_74 3m HORN_91200_1326 VERTICAL : RBW:1000.000KHz VBW:3000.000KHz SWT:Auto</p>	<p>Site : 03CH13-HY Condition : PEAK_74 3m HORN_91200_1326 VERTICAL : RBW:1000.000KHz VBW:3000.000KHz SWT:Auto</p>
<p>Avg.</p>	<p>Site : 03CH13-HY Condition : AVG_BE_54 3m HORN_91200_1326 VERTICAL : RBW:1000.000KHz VBW:1000KHz SWT:Auto</p>	<p>Site : 03CH13-HY Condition : AVG_54 3m HORN_91200_1326 VERTICAL : RBW:1000.000KHz VBW:1000KHz SWT:Auto</p>

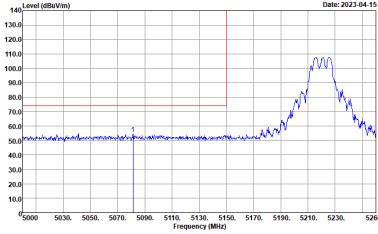
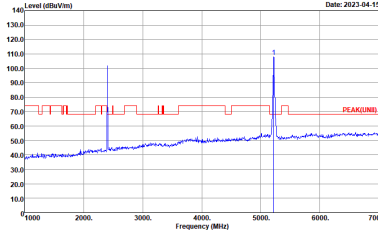
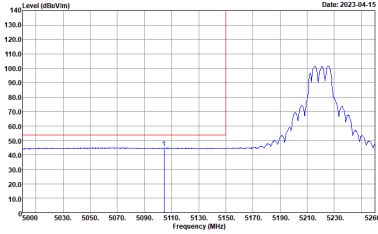
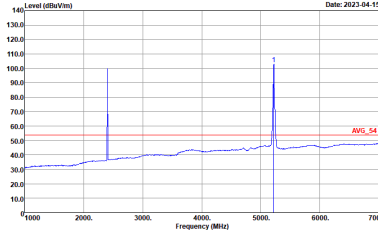

<p>BLE+ WIFI</p>	<p>Band 1 5150~5250MHz Band Edge @ 3m</p>	
<p>ANT</p>	<p>802.11a CH44 5220MHz - L</p>	
<p>3+4</p>	<p>Horizontal</p>	<p>Fundamental</p>
<p>Peak</p>	 <p>Level (dBm/100MHz) vs Frequency (MHz) plot for Horizontal orientation. The plot shows a peak at approximately 5220 MHz. The y-axis ranges from 10.0 to 140.0 dBm/100MHz, and the x-axis ranges from 5000 to 5260 MHz. A red vertical line is drawn at the peak frequency. The date is 2023-04-15.</p> <p>Site : 03CH13-HY Condition : PEAK_BE_74 3m HORN_91200_1326 HORIZONTAL : RBW:1000.000KHz VBW:3000.000KHz SWT:Auto</p>	 <p>Level (dBm/100MHz) vs Frequency (MHz) plot for Fundamental orientation. The plot shows a peak at approximately 5220 MHz. The y-axis ranges from 10.0 to 140.0 dBm/100MHz, and the x-axis ranges from 1000 to 7000 MHz. A red vertical line is drawn at the peak frequency. The date is 2023-04-15.</p> <p>Site : 03CH13-HY Condition : PEAK(FUND) 3m HORN_91200_1326 HORIZONTAL : RBW:1000.000KHz VBW:3000.000KHz SWT:Auto</p>
<p>Avg.</p>	 <p>Level (dBm/100MHz) vs Frequency (MHz) plot for Horizontal orientation. The plot shows a peak at approximately 5220 MHz. The y-axis ranges from 10.0 to 140.0 dBm/100MHz, and the x-axis ranges from 5000 to 5260 MHz. A red vertical line is drawn at the peak frequency. The date is 2023-04-15.</p> <p>Site : 03CH13-HY Condition : AVG_BE_54 3m HORN_91200_1326 HORIZONTAL : RBW:1000.000KHz VBW:1000KHz SWT:Auto</p>	 <p>Level (dBm/100MHz) vs Frequency (MHz) plot for Fundamental orientation. The plot shows a peak at approximately 5220 MHz. The y-axis ranges from 10.0 to 140.0 dBm/100MHz, and the x-axis ranges from 1000 to 7000 MHz. A red vertical line is drawn at the peak frequency. The date is 2023-04-15.</p> <p>Site : 03CH13-HY Condition : AVG_54 3m HORN_91200_1326 HORIZONTAL : RBW:1000.000KHz VBW:1000KHz SWT:Auto</p>



<p>BLE+ WIFI</p>	<p>Band 1 5150~5250MHz Band Edge @ 3m</p>	
<p>ANT</p>	<p>802.11a CH44 5220MHz - R</p>	
<p>3+4</p>	<p>Horizontal</p>	<p>Fundamental</p>
<p>Peak</p>	<p>Site : 03CH13-HY Condition : PEAK_BE_74 3m HORN_91200_1326 HORIZONTAL : RBW:1000.000KHz VBW:3000.000KHz SWT:Auto</p>	<p>Left blank</p>
<p>Avg.</p>	<p>Site : 03CH13-HY Condition : AVG_BE_54 3m HORN_91200_1326 HORIZONTAL : RBW:1000.000KHz VBW:1.000KHz SWT:Auto</p>	<p>Left blank</p>



<p>BLE+ WIFI</p>	<p>Band 1 5150~5250MHz Band Edge @ 3m</p>	
<p>ANT</p>	<p>802.11a CH44 5220MHz - L</p>	
<p>3+4</p>	<p>Vertical</p>	<p>Fundamental</p>
<p>Peak</p>		
<p>Avg.</p>		

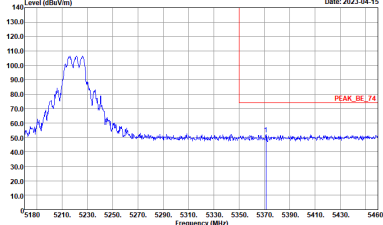
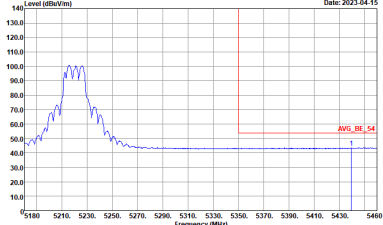

<p>BLE+ WIFI</p>	<p align="center">Band 1 5150~5250MHz Band Edge @ 3m</p>	
<p>ANT</p>	<p align="center">802.11a CH44 5220MHz - R</p>	
<p>3+4</p>	<p align="center">Vertical</p>	<p align="center">Fundamental</p>
<p align="center">Peak</p>	 <p>Site : 03CH13-HY Condition : PEAK_BE_74 3m HORN_91200_1326 VERTICAL : RBW:1000.000KHz VBW:3000.000KHz SWT:Auto</p>	<p align="center">Left blank</p>
<p align="center">Avg.</p>	 <p>Site : 03CH13-HY Condition : AVG_BE_54 3m HORN_91200_1326 VERTICAL : RBW:1000.000KHz VBW:1.000KHz SWT:Auto</p>	<p align="center">Left blank</p>

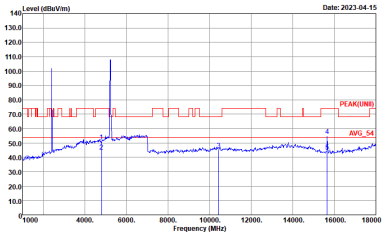
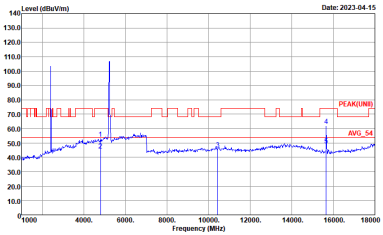

BLE_Tx_C00 + 802.11a_Tx_Ch44 (Harmonic @ 3m)

BLE+WIFI	2.4GHz 2402~2480MHz + Band 1 - 5150~5250MHz Harmonic @ 3m	
ANT	BLE_Tx_C00 + 802.11a_Tx_Ch44	
Simultaneously	Horizontal	Vertical
<p>Peak Avg.</p>	 <p>Site : 03CH13-HY Condition : PEAK(UNIT) 3m HORN_9120D_1326 HORIZONTAL</p>	 <p>Site : 03CH13-HY Condition : PEAK(UNIT) 3m HORN_9120D_1326 VERTICAL</p>



BLE+WIFI	2.4GHz 2402~2480MHz + Band 1 - 5150~5250MHzHarmonic @ 3m	
ANT	BLE_Tx_C00 + 802.11a_Tx_Ch44	
Simultaneously	Horizontal	Vertical
Avg.	<p>Site : 03CH13-HY Condition : AVG_54 3m HORN_9120D_1326 HORIZONTAL</p>	<p>Site : 03CH13-HY Condition : AVG_54 3m HORN_9120D_1326 VERTICAL</p>
Avg.	<p>Site : 03CH13-HY Condition : AVG_54 3m HORN_9120D_1326 HORIZONTAL</p>	<p>Site : 03CH13-HY Condition : AVG_54 3m HORN_9120D_1326 VERTICAL</p>



Appendix C. Duty Cycle Plots

Antenna	Band	Duty Cycle(%)	T(us)	1/T(kHz)	VBW Setting
3+4	Bluetooth –LE for 2Mbps	57.07	1070	0.93	1kHz
3+4	802.11g	93.44	1425	0.70	1kHz
3+4	5GHz 802.11a	93.77	1430	0.70	1kHz
3+4	6GHz 802.11a	93.70	1428	0.70	1kHz

MIMO <Ant. 3+4>

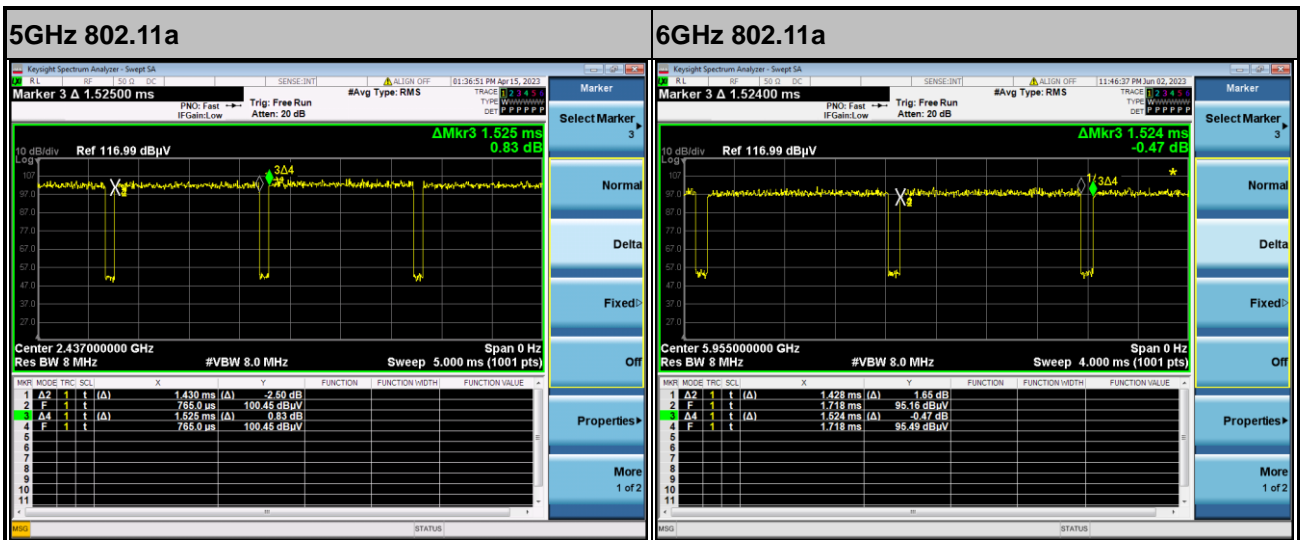
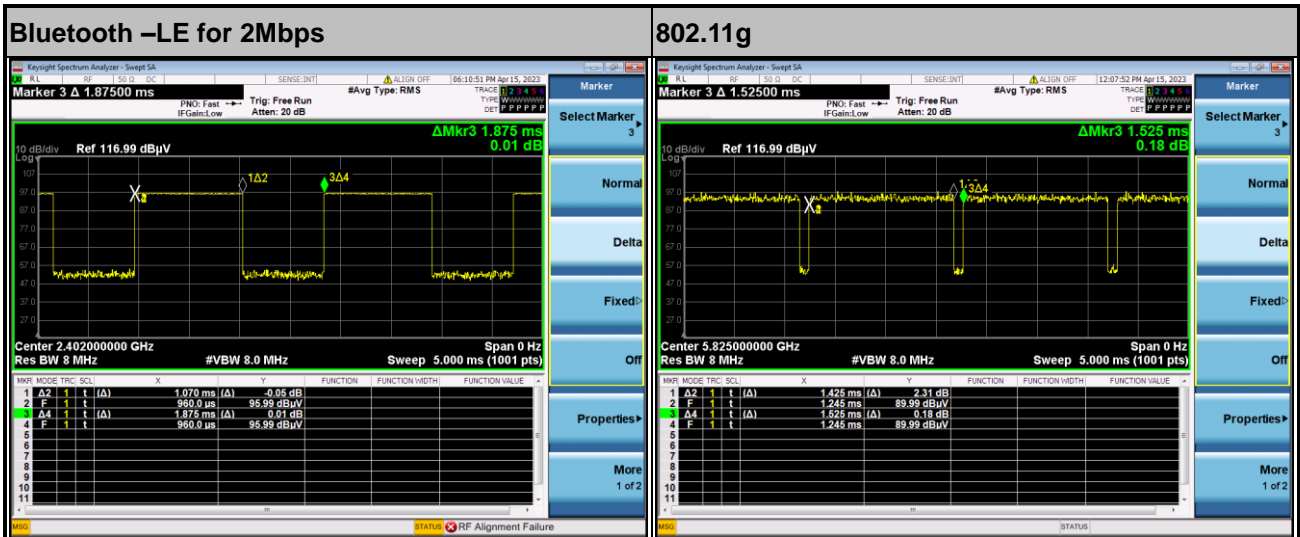

—THE END—