



# FCC RADIO TEST REPORT

FCC ID : A4RGE2AE  
Equipment : Phone  
Applicant : Google LLC  
1600 Amphitheatre Parkway,  
Mountain View, California, 94043 USA  
Standard : FCC 47 CFR Part 2, 22(H), 24(E), 27(L)

The product was received on Mar. 10, 2022 and testing was performed from Mar. 29, 2022 to May 24, 2022. We, Sporton International Inc. EMC & Wireless Communications Laboratory, would like to declare that the tested sample has been evaluated in accordance with the test procedures given in ANSI / TIA-603-E and has been in compliance with the applicable technical standards.

The test results in this report apply exclusively to the tested model / sample. Without written approval from Sporton International Inc. EMC & Wireless Communications Laboratory, the test report shall not be reproduced except in full.

*Louis Wu*

Approved by: Louis Wu

**Sporton International Inc. EMC & Wireless Communications Laboratory**

No. 52, Huaya 1st Rd., Guishan Dist., Taoyuan City 333, Taiwan (R.O.C.)



# Table of Contents

**History of this test report.....3**

**Summary of Test Result.....4**

**1 General Description .....5**

    1.1 Product Feature of Equipment Under Test .....5

    1.2 Product Specification of Equipment Under Test .....6

    1.3 Modification of EUT .....7

    1.4 Testing Location .....8

    1.5 Applicable Standards .....8

**2 Test Configuration of Equipment Under Test .....9**

    2.1 Test Mode.....9

    2.2 Connection Diagram of Test System .....10

    2.3 Support Unit used in test configuration .....10

    2.4 Measurement Results Explanation Example .....10

    2.5 Frequency List of Low/Middle/High Channels.....11

**3 Conducted Test Result .....12**

    3.1 Measuring Instruments.....12

    3.2 Conducted Output Power and ERP/EIRP .....13

    3.3 Peak-to-Average Ratio .....14

    3.4 99% Occupied Bandwidth and 26dB Bandwidth Measurement.....15

    3.5 Conducted Band Edge .....16

    3.6 Conducted Spurious Emission .....17

    3.7 Frequency Stability.....18

**4 Radiated Test Items .....19**

    4.1 Measuring Instruments.....19

    4.2 Test Setup .....19

    4.3 Test Result of Radiated Test.....20

    4.4 Field Strength of Spurious Radiation Measurement .....21

**5 List of Measuring Equipment.....22**

**6 Uncertainty of Evaluation .....24**

**Appendix A. Test Results of Conducted Test**

**Appendix B. Test Results of Radiated Test**

**Appendix C. Setup Photographs**



### History of this test report

Report No.	Version	Description	Issue Date
FG1O2919-05A	01	Initial issue of report	May 31, 2022
FG1O2919-05A	02	<ol style="list-style-type: none"><li>Revise Table of Contents and the remark of summary</li><li>Revise Product Specification and Appendix A2</li><li>Add remark description in test mode</li><li>Remove model name</li></ol>	Jun. 06, 2022



### Summary of Test Result

Report Clause	Ref Std. Clause	Test Items	Result (PASS/FAIL)	Remark
3.2	§2.1046	Conducted Output Power	Pass	-
	§22.913 (a)(5)	Effective Radiated Power (GSM850) (WCDMA Band V)		
	§24.232 (c)	Equivalent Isotropic Radiated Power (GSM1900) (WCDMA Band II)		
	§27.50 (d)(4)	Equivalent Isotropic Radiated Power (WCDMA Band IV)		
3.3	§24.232 (d)	Peak-to-Average Ratio	Pass	-
3.4	§2.1049	Occupied Bandwidth (GSM850) (WCDMA Band V) (GSM1900) (WCDMA Band II) (WCDMA Band IV)	Pass	-
	§22.917 (b)			
	§24.238 (b)			
	§27.53 (g)			
3.5	§2.1051	Band Edge Measurement (GSM850) (WCDMA Band V) (GSM1900) (WCDMA Band II) (WCDMA Band IV)	Pass	-
	§22.917 (a)			
	§24.238 (a)			
	§27.53 (g)			
3.6	§2.1051	Conducted Emission (GSM850) (WCDMA Band V) (GSM1900) (WCDMA Band II) (WCDMA Band IV)	Pass	-
	§22.917 (a)			
	§24.238 (a)			
	§27.53 (g)			
3.7	§2.1055	Frequency Stability Temperature & Voltage	Pass	-
	§22.355			
	§24.235			
	§27.54			
4.4	§2.1053	Field Strength of Spurious Radiation (GSM850) (WCDMA Band V) (GSM1900) (WCDMA Band II) (WCDMA Band IV)	Pass	17.85 dB under the limit at 5639.000 MHz for Primary Antenna 34.06 dB under the limit at 2544.000 MHz for ASDIV Antenna
	§22.917 (a)			
	§24.238 (a)			
	§27.53 (h)			

**Declaration of Conformity:**

- The test results (PASS/FAIL) with all measurement uncertainty excluded are presented in accordance with the regulation limits or requirements declared by manufacturers. It's means measurement values may risk exceeding the limit of regulation standards, if measurement uncertainty is include in test results.
- The measurement uncertainty please refer to this report "Uncertainty of Evaluation".

**Comments and Explanations:**

The product specifications of the EUT presented in the report are declared by the manufacturer who shall take full responsibility for the authenticity.

**Reviewed by: William Chen**

**Report Producer: Clio Lo**



# 1 General Description

## 1.1 Product Feature of Equipment Under Test

Product Feature	
Equipment	Phone
FCC ID	A4RGE2AE
EUT supports Radios application	GSM/EGPRS/WCDMA/HSPA/LTE/5G NR/NFC/GNSS/ WPC/WPT/UWB WLAN 11b/g/n HT20 WLAN 11a/n HT20/HT40 WLAN 11ac VHT20/VHT40/VHT80/VHT160 WLAN 11ax HE20/HE40/HE80/HE160 Bluetooth BR/EDR/LE

**Remark:** The above EUT's information was declared by manufacturer.

EUT Information List	
S/N	Performed Test Item
23061FDH300017	Conducted Measurement ERP/EIRP
22271FDH30003S	Radiated Spurious Emission



## 1.2 Product Specification of Equipment Under Test

Product Specification is subject to this standard	
<b>Tx Frequency</b>	<b>GSM/GPRS/EDGE:</b> 850: 824.2 MHz ~ 848.8 MHz 1900: 1850.2 MHz ~ 1909.8 MHz <b>WCDMA:</b> Band V: 826.4 MHz ~ 846.6 MHz Band II: 1852.4 MHz ~ 1907.6 MHz Band IV: 1712.4 MHz ~ 1752.6 MHz
<b>Rx Frequency</b>	<b>GSM/GPRS/EDGE:</b> 850: 869.2 MHz ~ 893.8 MHz 1900: 1930.2 MHz ~ 1989.8 MHz <b>WCDMA:</b> Band V: 871.4 MHz ~ 891.6 MHz Band II: 1932.4 MHz ~ 1987.6 MHz Band IV: 2112.4 MHz ~ 2152.6 MHz
<b>Maximum Output Power to Antenna</b>	<b>&lt;Primary Antenna&gt;</b> <b>GSM/GPRS/EDGE:</b> <b>&lt;Ant. 0&gt;</b> 850: 32.39 dBm <b>&lt;Ant. 2&gt;</b> 1900: 30.24 dBm <b>WCDMA:</b> <b>&lt;Ant. 0&gt;</b> Band V: 24.56 dBm <b>&lt;Ant. 2&gt;</b> Band II: 24.93 dBm Band IV: 24.60 dBm <b>&lt;ASDIV Antenna&gt;</b> <b>GSM/GPRS/EDGE:</b> <b>&lt;Ant. 1&gt;</b> 850: 32.99 dBm <b>&lt;Ant. 0&gt;</b> 1900: 29.57 dBm <b>WCDMA:</b> <b>&lt;Ant. 1&gt;</b> Band V: 24.58 dBm <b>&lt;Ant. 0&gt;</b> Band II: 24.17 dBm Band IV: 23.80 dBm
<b>Antenna Type</b>	<b>&lt;Primary Antenna&gt;:</b> <b>&lt;Ant. 0&gt;:</b> PIFA Antenna type <b>&lt;Ant. 2&gt;:</b> PIFA Antenna type <b>&lt;ASDIV Antenna&gt;:</b> <b>&lt;Ant. 0&gt;:</b> PIFA Antenna type <b>&lt;Ant. 1&gt;:</b> PIFA Antenna type

Product Specification is subject to this standard	
Type of Modulation	GSM / GPRS: GMSK EDGE(MCS 0-4): GMSK / (MCS 5-9): 8PSK WCDMA: QPSK (Uplink) HSDPA: 64QAM (Downlink) HSUPA: QPSK (Uplink)

**<Primary Antenna>**

Radio Tech	Band Number	Antenna name	Gain
GSM	850	Ant 0	-2.3
GSM	1900	Ant 2	1.5
WCDMA	B2	Ant 2	1.5
WCDMA	B4	Ant 2	-1.2
WCDMA	B5	Ant 0	-2.3

**<ASDIV Antenna>**

Radio Tech	Band Number	Antenna name	Gain
GSM	850	Ant 1	-4.6
GSM	1900	Ant 0	1.4
WCDMA	B2	Ant 0	1.4
WCDMA	B4	Ant 0	-2.6
WCDMA	B5	Ant 1	-4.6

**Remark:** The above EUT's information was declared by manufacturer. Please refer to Comments and Explanations in report summary.

### 1.3 Modification of EUT

No modifications made to the EUT during the testing.



### 1.4 Testing Location

Test Site	Sporton International Inc. EMC & Wireless Communications Laboratory
Test Site Location	No.52, Huaya 1st Rd., Guishan Dist., Taoyuan City 333, Taiwan (R.O.C.) TEL: +886-3-327-3456 FAX: +886-3-328-4978
Test Site No.	<b>Sporton Site No.</b> TH03-HY
Test Engineer	Oscar Chi
Temperature (°C)	23~24
Relative Humidity (%)	54~55

Test Site	Sporton International Inc. Wensan Laboratory
Test Site Location	No.58, Aly. 75, Ln. 564, Wenhua 3rd, Rd., Guishan Dist., Taoyuan City 333010, Taiwan (R.O.C.) TEL: +886-3-327-0868 FAX: +886-3-327-0855
Test Site No.	<b>Sporton Site No.</b> 03CH15-HY (TAF Code: 3786)
Test Engineer	Leo Lee and Bigshow Wang
Temperature (°C)	18~25
Relative Humidity (%)	45~60
Remark	The Radiated Emission test item subcontracted to Sporton International Inc. Wensan Laboratory.

Note: The test site complies with ANSI C63.4 2014 requirement.

FCC Designation No.: TW1190 and TW3786

### 1.5 Applicable Standards

According to the specifications declared by the manufacturer, the EUT must comply with the requirements of the following standards:

- ♦ ANSI C63.26-2015
- ♦ ANSI / TIA-603-E
- ♦ FCC 47 CFR Part 2, 22(H), 24(E), 27(L)
- ♦ FCC KDB 971168 D01 Power Meas. License Digital Systems v03r01
- ♦ FCC KDB 412172 D01 Determining ERP and EIRP v01r01
- ♦ FCC KDB 414788 D01 Radiated Test Site v01r01

**Remark:**

1. All the test items were validated and recorded in accordance with the standards without any modification during the testing.
2. The TAF code is not including all the FCC KDB listed without accreditation.





## 2 Test Configuration of Equipment Under Test

### 2.1 Test Mode

Antenna port conducted and radiated test items were performed according to KDB 971168 D01 Power Meas. License Digital Systems v03r01 with maximum output power.

For radiated measurement, the measured emission level of the EUT was maximized by rotating the EUT on a turntable, adjusting the orientation of the EUT and EUT antenna in three orthogonal axis (X: flat, Y: portrait, Z: landscape) and accessory (Adapter or Earphone), and adjusting the measurement antenna orientation, following C63.26 exploratory test procedures and find <Primary Antenna>: X Plane with Adapter for Cellular Band, Z Plane with Adapter for PCS Band and AWS Band; <ASDIV Antenna>: Z Plane with Adapter for Cellular Band, X Plane with Adapter for PCS Band and AWS Band as worst plane.

Radiated emissions were investigated as following frequency range:

1. 30 MHz to 9000 MHz for GSM850 and WCDMA Band V
2. 30 MHz to 18000 MHz for WCDMA Band IV
3. 30 MHz to 19100 MHz for GSM1900 and WCDMA Band II

All modes, data rates and positions were investigated.

Test modes are chosen to be reported as the worst case configuration below:

Test Modes		
Band	Radiated TCs	Conducted TCs
GSM850	<ul style="list-style-type: none"> <li>■ GPRS Class 8 Link</li> <li>■ EDGE Class 8 Link</li> </ul>	<ul style="list-style-type: none"> <li>■ GPRS Class 8 Link</li> <li>■ EDGE Class 8 Link</li> </ul>
GSM1900	<ul style="list-style-type: none"> <li>■ GPRS Class 8 Link</li> <li>■ EDGE Class 8 Link</li> </ul>	<ul style="list-style-type: none"> <li>■ GPRS Class 8 Link</li> <li>■ EDGE Class 8 Link</li> </ul>
WCDMA Band V	<ul style="list-style-type: none"> <li>■ RMC 12.2Kbps Link</li> </ul>	<ul style="list-style-type: none"> <li>■ RMC 12.2Kbps Link</li> </ul>
WCDMA Band II	<ul style="list-style-type: none"> <li>■ RMC 12.2Kbps Link</li> </ul>	<ul style="list-style-type: none"> <li>■ RMC 12.2Kbps Link</li> </ul>
WCDMA Band IV	<ul style="list-style-type: none"> <li>■ RMC 12.2Kbps Link</li> </ul>	<ul style="list-style-type: none"> <li>■ RMC 12.2Kbps Link</li> </ul>

**Remark:**

1. All the radiated test cases were performed with Adapter 1 and USB Cable 2.
2. During the preliminary test, both charging modes (Adapter mode and WPT Charging mode) were verified. It is determined that the adaptor mode is the worst case for official test.

## 2.2 Connection Diagram of Test System

<EUT with Adapter>

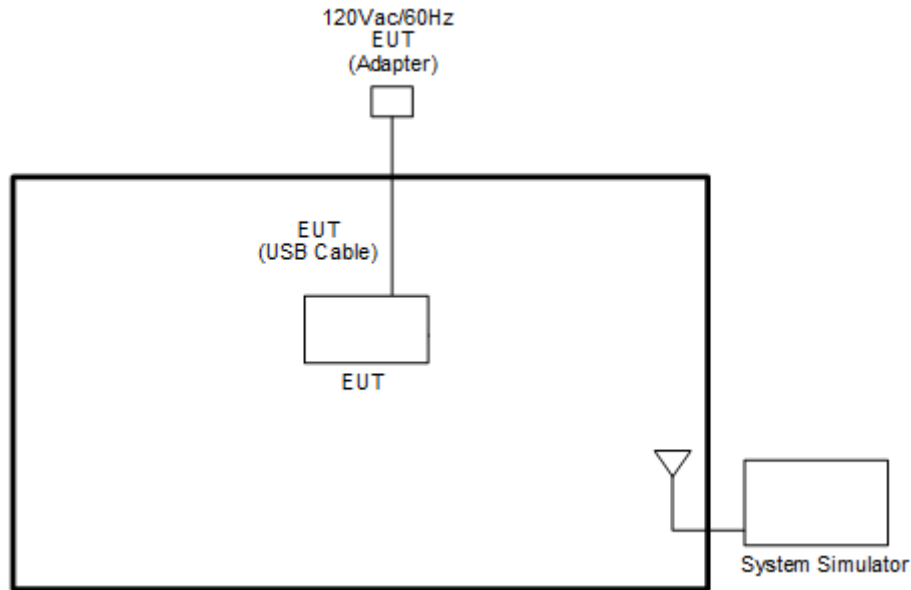

## 2.3 Support Unit used in test configuration

Item	Equipment	Brand Name	Model No.	FCC ID	Data Cable	Power Cord
1.	System Simulator	Anritsu	MT8821C	N/A	N/A	Unshielded, 1.8 m
2.	System Simulator	Anritsu	MT8000A	N/A	N/A	Unshielded, 1.8 m

## 2.4 Measurement Results Explanation Example

**For all conducted test items:**

The offset level is set in the spectrum analyzer to compensate the RF cable loss and attenuator factor between RF conducted output port and spectrum analyzer. With the offset compensation, the spectrum analyzer reading level will be exactly the RF output level.

The spectrum analyzer offset is derived from RF cable loss and attenuator factor.

Offset = RF cable loss + attenuator factor.

The following shows an offset computation example with RF cable loss 4.2 dB and a 10 dB attenuator.

Example:

$$\begin{aligned} \text{Offset(dB)} &= \text{RF cable loss(dB)} + \text{attenuator factor(dB)}. \\ &= 4.2 + 10 = 14.2 \text{ (dB)} \end{aligned}$$



## 2.5 Frequency List of Low/Middle/High Channels

Frequency List				
Band	Channel/Frequency(MHz)	Lowest	Middle	Highest
GSM850	Channel	128	189	251
	Frequency	824.2	836.4	848.8
WCDMA Band V	Channel	4132	4182	4233
	Frequency	826.4	836.4	846.6
GSM1900	Channel	512	661	810
	Frequency	1850.2	1880.0	1909.8
WCDMA Band II	Channel	9262	9400	9538
	Frequency	1852.4	1880.0	1907.6
WCDMA Band IV	Channel	1312	1413	1513
	Frequency	1712.4	1732.6	1752.6

### 3 Conducted Test Result

#### 3.1 Measuring Instruments

Please refer to the measuring equipment list in this test report.

##### 3.1.1 Test Setup

##### 3.1.2 Conducted Output Power

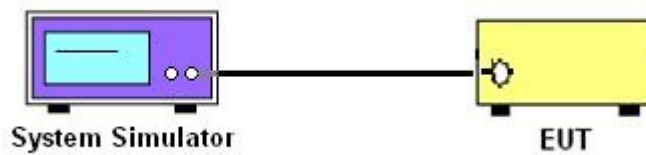

##### 3.1.3 Peak-to-Average Ratio, Occupied Bandwidth, Conducted Band-Edge and Conducted Spurious Emission

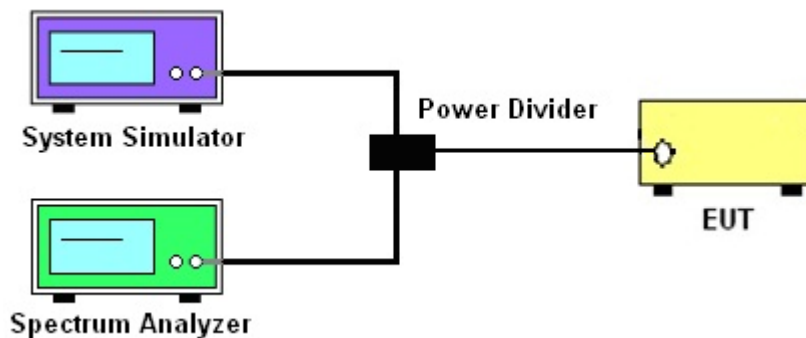

##### 3.1.4 Frequency Stability

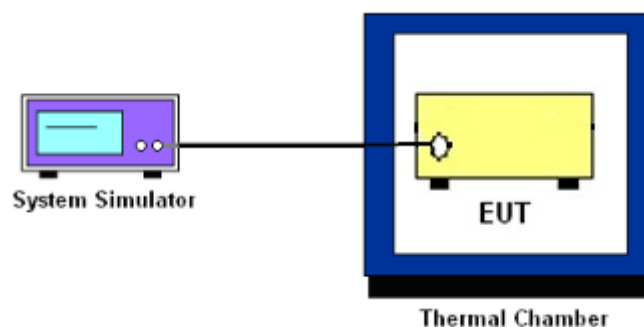

##### 3.1.5 Test Result of Conducted Test

Please refer to Appendix A.



## 3.2 Conducted Output Power and ERP/EIRP

### 3.2.1 Description of the Conducted Output Power and ERP/EIRP

A system simulator was used to establish communication with the EUT. Its parameters were set to enforce EUT transmitting at the maximum power. The measured power in the radio frequency on the transmitter output terminals shall be reported.

The ERP of mobile transmitters must not exceed 7 Watts for GSM850 and WCDMA Band V

The EIRP of mobile transmitters must not exceed 2 Watts for GSM1900 and WCDMA Band II

The EIRP of mobile transmitters must not exceed 1 Watts for WCDMA Band IV

According to KDB 412172 D01 Power Approach,

$EIRP = P_T + G_T - L_C$ ,  $ERP = EIRP - 2.15$ , where

$P_T$  = transmitter output power in dBm

$G_T$  = gain of the transmitting antenna in dBi

$L_C$  = signal attenuation in the connecting cable between the transmitter and antenna in dB

### 3.2.2 Test Procedures

1. The transmitter output port is connected to the system simulator.
2. Set EUT at maximum power through system simulator.
3. Select the lowest, middle, and the highest channels for each band and different modulation.
4. Measure the maximum burst average power for GSM and maximum average power for other modulation signal.



### **3.3 Peak-to-Average Ratio**

#### **3.3.1 Description of the PAR Measurement**

The peak-to-average ratio (PAR) of the transmission may not exceed 13 dB.

#### **3.3.2 Test Procedures**

The testing follows ANSI C63.26-2015 Section 5.2.6

1. The EUT is connected to spectrum analyzer and system simulator via a power divider.
2. Set EUT to transmit at maximum output power.
3. When the duty cycle is less than 98%, then signal gating will be implemented on the spectrum analyzer by triggering from the system simulator.
4. Set the CCDF (Complementary Cumulative Distribution Function) option of the spectrum analyzer.
5. Record the maximum PAPR level associated with a probability of 0.1%.



### 3.4 99% Occupied Bandwidth and 26dB Bandwidth Measurement

#### 3.4.1 Description of 99% Occupied Bandwidth and 26dB Bandwidth Measurement

The occupied bandwidth is the width of a frequency band such that, below the lower and above the upper frequency limits, the mean powers emitted are each equal to a specified percentage 0.5% of the total mean transmitted power.

The 26 dB emission bandwidth is defined as the frequency range between two points, one above and one below the carrier frequency, at which the spectral density of the emission is attenuated 26 dB below the maximum in-band spectral density of the modulated signal. Spectral density (power per unit bandwidth) is to be measured with a detector of resolution bandwidth equal to approximately 1.0% of the emission bandwidth.

#### 3.4.2 Test Procedures

The testing follows ANSI C63.26-2015 Section 5.4.3 (26dB) and Section 5.4.4 (99OB)

1. The EUT is connected to spectrum analyzer and system simulator via a power divider.
2. The spectrum analyzer center frequency is set to the nominal EUT channel center frequency. The span range for the spectrum analyzer shall be between two and five times the anticipated OBW.
3. The nominal resolution bandwidth (RBW) shall be in the range of 1 to 5 % of the anticipated OBW, and the VBW shall be at least 3 times the RBW.
4. Set the detection mode to peak, and the trace mode to max hold.
5. Determine the reference value: Set the EUT to transmit a modulated signal. Allow the trace to stabilize. Set the spectrum analyzer marker to the highest level of the displayed trace.  
(This is the reference value)
6. Determine the “-26 dB down amplitude” as equal to (Reference Value – X).
7. Place two markers, one at the lowest and the other at the highest frequency of the envelope of the spectral display such that each marker is at or slightly below the “-X dB down amplitude” determined in step 6. If a marker is below this “-X dB down amplitude” value it shall be placed as close as possible to this value. The OBW is the positive frequency difference between the two markers.
8. Use the 99 % power bandwidth function of the spectrum analyzer and report the measured bandwidth.



## **3.5 Conducted Band Edge**

### **3.5.1 Description of Conducted Band Edge Measurement**

The power of any emission outside of the authorized operating frequency ranges must be lower than the transmitter power (P) by a factor of at least  $43 + 10 \log (P)$  dB.

### **3.5.2 Test Procedures**

The testing follows FCC KDB 971168 D01 v03r01 Section 6.1.

1. The EUT is connected to the spectrum analyzer and system simulator via a power divider.
2. The RF output of EUT is connected to the spectrum analyzer by an RF cable and attenuator. The path loss is compensated to the results for each measurement.
3. The band edges of low and high channels for the highest RF powers are measured.
4. The RF fundamental frequency shall be excluded against the limit line in the operating frequency band.
5. The limit line is derived from  $43 + 10\log(P)$  dB below the transmitter power P(Watts)





## **3.6 Conducted Spurious Emission**

### **3.6.1 Description of Conducted Spurious Emission Measurement**

The power of any emission outside of the authorized operating frequency ranges must be lower than the transmitter power (P) by a factor of at least  $43 + 10 \log (P)$  dB.

It is measured by means of a calibrated spectrum analyzer and scanned from 30 MHz up to a frequency including its 10<sup>th</sup> harmonic.

### **3.6.2 Test Procedures**

The testing follows FCC KDB 971168 D01 v03r01 Section 6.1.

1. The EUT is connected to the spectrum analyzer and system simulator via a power divider.
2. The RF output of EUT is connected to the spectrum analyzer by an RF cable and attenuator. The path loss is compensated to the results for each measurement.
3. The middle channel for the highest RF power within the transmitting frequency is measured.
4. The conducted spurious emission for the whole frequency range is taken.
5. The RF fundamental frequency shall be excluded against the limit line in the operating frequency band.
6. The limit line is derived from  $43 + 10\log(P)$  dB below the transmitter power P(Watts)



### 3.7 Frequency Stability

#### 3.7.1 Description of Frequency Stability Measurement

22.355

The frequency stability shall be measured by variation of ambient temperature and variation of primary supply voltage to ensure that the fundamental emission stays within the authorized frequency block. The frequency stability of the transmitter shall be maintained within  $\pm 0.00025\%$  ( $\pm 2.5\text{ppm}$ ) of the center frequency.

24.235 & 27.54

The frequency stability shall be sufficient to ensure that the fundamental emission stays within the authorized frequency block.

#### 3.7.2 Test Procedures for Temperature Variation

The testing follows FCC KDB 971168 D01 v03r01 Section 9.0.

1. The EUT is set up in the thermal chamber and connected with the system simulator.
2. With power OFF, the temperature is decreased to  $-30^{\circ}\text{C}$  and the EUT is stabilized before testing. Power is applied and the maximum change in frequency is recorded within one minute.
3. With power OFF, the temperature is raised in  $10^{\circ}\text{C}$  steps up to  $50^{\circ}\text{C}$ . The EUT is stabilized at each step for at least half an hour. Power is applied and the maximum frequency change is recorded within one minute.

#### 3.7.3 Test Procedures for Voltage Variation

The testing follows FCC KDB 971168 D01 v03r01 Section 9.0.

1. The EUT is placed in a temperature chamber at  $20\pm 5^{\circ}\text{C}$  and connected with the system simulator.
2. The power supply voltage to the EUT is varied from 85% to 115% of the nominal value measured at the input to the EUT.
3. The variation in frequency is measured for the worst case.

## 4 Radiated Test Items

### 4.1 Measuring Instruments

Please refer to the measuring equipment list in this test report.

### 4.2 Test Setup

For radiated test below 30MHz

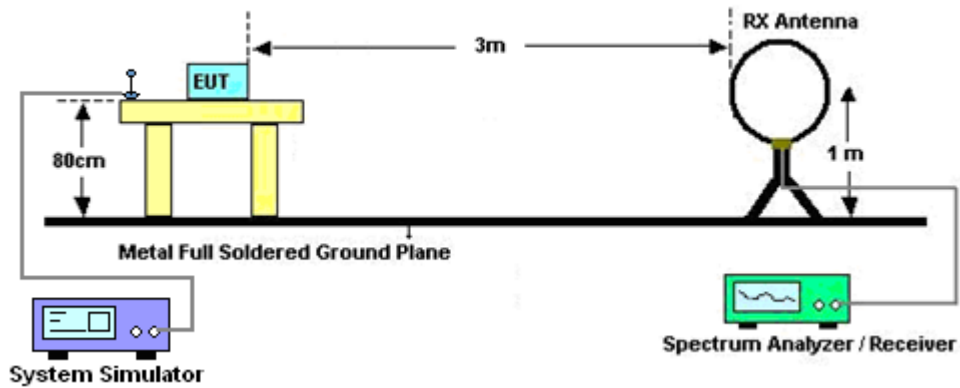

For radiated test from 30MHz to 1GHz

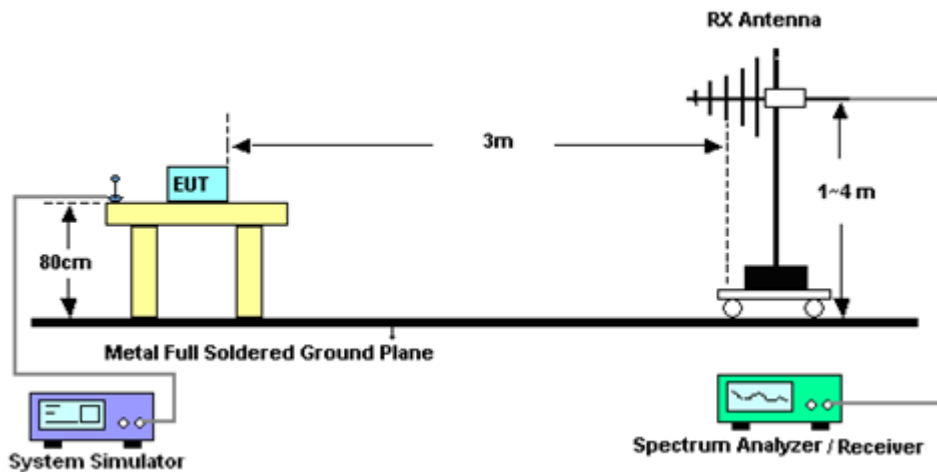

For radiated test from 1GHz to 18GHz

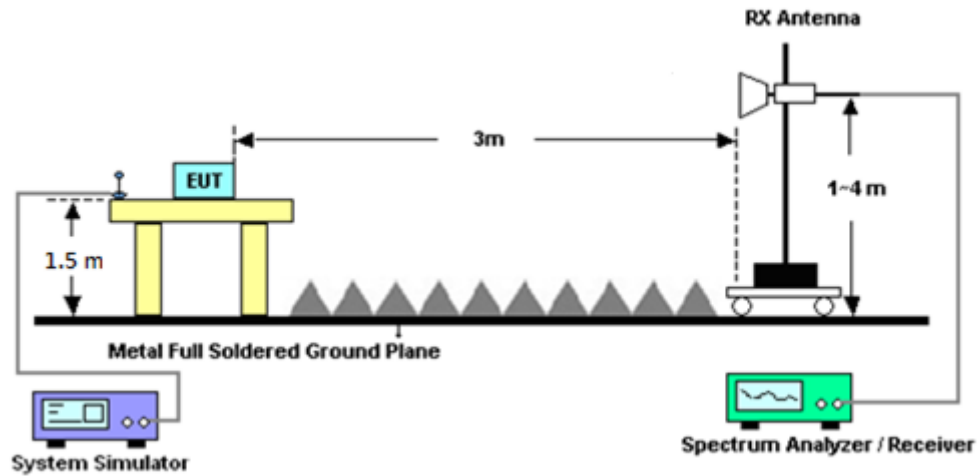

For radiated test above 18GHz

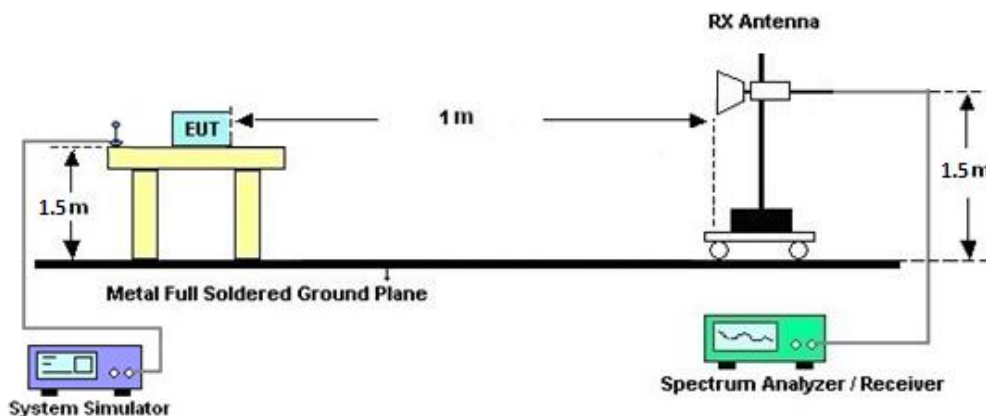

### 4.3 Test Result of Radiated Test

Please refer to Appendix B.

**Note:**

The low frequency, which starts from 9 kHz to 30 MHz, is pre-scanned and the result which is 20 dB lower than the limit line is not reported.

There is adequate comparison measurement of both open-field test site and alternative test site - semi-Anechoic chamber according to 414788 D01 Radiated Test Site v01r01, and the result came out very similar.



## 4.4 Field Strength of Spurious Radiation Measurement

### 4.4.1 Description of Field Strength of Spurious Radiated Measurement

The power of any emission outside of the authorized operating frequency ranges must be attenuated below the transmitter power (P) by a factor of at least  $43 + 10 \log (P)$  dB. The spectrum is scanned from 30 MHz up to a frequency including its 10th harmonic.

### 4.4.2 Test Procedures

The testing follows FCC KDB 971168 D01 v03r01 Section 7 and ANSI / TIA-603-E Section 2.2.12.

1. The EUT is placed on a rotatable wooden table 0.8 meters for frequency below 1 GHz and 1.5 meter for frequency above 1 GHz above the ground.
2. The EUT is set 3 meters away from the receiving antenna, which is mounted on the antenna tower.
3. The table is rotated 360 degrees to determine the position of the highest spurious emission.
4. The height of the receiving antenna is varied between one meter and four meters to search for the maximum spurious emission for both horizontal and vertical polarizations.
5. Make the measurement with the spectrum analyzer's RBW = 1 MHz, VBW = 3 MHz, taking record of maximum spurious emission.
6. A horn antenna is substituted in place of the EUT and is driven by a signal generator.
7. Tune the output power of signal generator to the same emission level with EUT maximum spurious emission.
8. Take the record of output power at antenna port.
9. Repeat step 7 to step 8 for another polarization.
10.  $EIRP (dBm) = S.G. Power - Tx Cable Loss + Tx Antenna Gain$
11.  $ERP (dBm) = EIRP - 2.15$
12. The RF fundamental frequency shall be excluded against the limit line in the operating frequency band.
13. The limit line is derived from  $43 + 10\log(P)$  dB below the transmitter power P(Watts)



## 5 List of Measuring Equipment

Instrument	Brand Name	Model No.	Serial No.	Characteristics	Calibration Date	Test Date	Due Date	Remark
Hygrometer	TECEPEL	DTM-303B	TP210073	N/A	Nov. 16, 2021	Apr. 06, 2022~ May 23, 2022	Nov. 15, 2022	Conducted (TH03-HY)
Spectrum Analyzer	Rohde & Schwarz	FSP30	101329	9kHz~30GHz	Sep. 30, 2021	Apr. 06, 2022~ May 23, 2022	Sep. 29, 2022	Conducted (TH03-HY)
Temperature & Humidity Cabinet Chamber	ESPEC	LHU-113	1012005860	-20°C ~85°C	Dec. 09, 2021	Apr. 06, 2022~ May 23, 2022	Dec. 08, 2022	Conducted (TH03-HY)
Programmable Power Supply	GW Instek	PSS-2005	EL890001	1V~20V 0.5A~4A	Oct. 06, 2021	Apr. 06, 2022~ May 23, 2022	Oct. 05, 2022	Conducted (TH03-HY)
Base Station(Measur e)	Rohde & Schwarz	CMU200	117995	GSM / GPRS / WCDMA / CDMA	Jul. 13, 2021	Apr. 06, 2022~ May 23, 2022	Jul. 12, 2022	Conducted (TH03-HY)
Power Divider	Warison	WCOU-0.4-26.5S-20	#A	N/A	Nov. 01, 2021	Apr. 06, 2022~ May 23, 2022	Oct. 31, 2022	Conducted (TH03-HY)
Loop Antenna	Rohde & Schwarz	HFH2-Z2	100488	9 kHz~30 MHz	Sep. 07, 2021	Mar. 29, 2022~ May 24, 2022	Sep. 06, 2022	Radiation (03CH15-HY)
Bilog Antenna	TESEQ	CBL 6111D & 00800N1D01N-06	37059 & 01	30MHz~1GHz	Oct. 09, 2021	Mar. 29, 2022~ May 24, 2022	Oct. 08, 2022	Radiation (03CH15-HY)
Bilog Antenna	TESEQ	CBL6111D&00800N1D01N-06	35414 & AT-N0602	30MHz to 1GHz	Oct. 09, 2021	Mar. 29, 2022~ May 24, 2022	Oct. 08, 2022	Radiation (03CH15-HY)
Amplifier	SONOMA	310N	363440	9kHz~1GHz	Dec. 30, 2021	Mar. 29, 2022~ May 24, 2022	Dec. 29, 2022	Radiation (03CH15-HY)
Horn Antenna	SCHWARZBECK	BBHA 9120 D	9120D-01620	1-18GHz	Oct. 25, 2021	Mar. 29, 2022~ May 24, 2022	Oct. 24, 2022	Radiation (03CH15-HY)
Horn Antenna	SCHWARZBECK	BBHA 9120 D	9120D-1326	1GHz~18GHz	Oct. 25, 2021	Mar. 29, 2022~ May 24, 2022	Oct. 24, 2022	Radiation (03CH15-HY)
SHF-EHF Horn Antenna	SCHWARZBECK	BBHA 9170	00993	18GHz- 40GHz	Nov. 30, 2021	Mar. 29, 2022~ May 24, 2022	Nov. 29, 2022	Radiation (03CH15-HY)
Preamplifier	Jet-Power	JPA0118-55-303	1710001800 055006	1GHz~18GHz	May 06, 2021	Mar. 29, 2022~ May 04, 2022	May 05, 2022	Radiation (03CH15-HY)
Preamplifier	Jet-Power	JPA0118-55-303	1710001800 055006	1GHz~18GHz	May 05, 2022	May 05, 2022~ May 24, 2022	May 04, 2023	Radiation (03CH15-HY)
Amplifier	E-INSTRUMENT TECH LTD	ERA-10M-7000-MR	EC1900247	10MHz-7GHz	Dec. 03, 2021	Mar. 29, 2022~ May 24, 2022	Dec. 02, 2022	Radiation (03CH15-HY)
Preamplifier	EM Electronics	EM01G18G	060803	1GHz-18GHz	Dec. 16, 2021	Mar. 29, 2022~ May 24, 2022	Dec. 15, 2022	Radiation (03CH15-HY)
Preamplifier	EMEC	EM18G40G	060801	18-40GHz	Jun. 22, 2021	Mar. 29, 2022~ May 24, 2022	Jun. 21, 2022	Radiation (03CH15-HY)
Spectrum Analyzer	Keysight	N9038A	MY54130085	20MHz~8.4GHz	Oct. 21, 2021	Mar. 29, 2022~ May 24, 2022	Oct. 20, 2022	Radiation (03CH15-HY)
Spectrum Analyzer	Keysight	N9010A	MY54200485	10Hz~44GHz	Mar. 07, 2022	Mar. 29, 2022~ May 24, 2022	Mar. 06, 2023	Radiation (03CH15-HY)



Instrument	Brand Name	Model No.	Serial No.	Characteristics	Calibration Date	Test Date	Due Date	Remark
Antenna Mast	ChainTek	MBS-520-1	N/A	1m~4m	N/A	Mar. 29, 2022~ May 24, 2022	N/A	Radiation (03CH15-HY)
Turn Table	ChainTek	T-200-S-1	N/A	0~360 Degree	N/A	Mar. 29, 2022~ May 24, 2022	N/A	Radiation (03CH15-HY)
Software	Audix	E3 6.2009-8-24(k 5)	RK-000451	N/A	N/A	Mar. 29, 2022~ May 24, 2022	N/A	Radiation (03CH15-HY)
RF Cable	HUBER + SUHNER	SUCOFLEX 104, 102E	MY36980/4, MY9838/4PE ,508405/2E	30MHz~18G	Nov. 15, 2021	Mar. 29, 2022~ May 11, 2022	Nov. 14, 2022	Radiation (03CH15-HY)
RF Cable	HUBER + SUHNER	SUCOFLEX 102	804011/2,804 012/2	30MHz-40GHz	Jan. 04, 2022	Mar. 29, 2022~ May 24, 2022	Jan. 03, 2023	Radiation (03CH15-HY)
RF Cable	HUBER + SUHNER	SUCOFLEX 104	MY9837/4PE	9kHz~30MHz	Mar. 10, 2022	Mar. 29, 2022~ May 24, 2022	Mar. 09, 2023	Radiation (03CH15-HY)
Signal Generator	Rohde & Schwarz	SMF100A	101107	0.1Hz~40GHz	Dec. 08, 2021	Mar. 29, 2022~ May 24, 2022	Dec. 07, 2022	Radiation (03CH15-HY)



## 6 Uncertainty of Evaluation

### Uncertainty of Radiated Emission Measurement (30 MHz ~ 1000 MHz)

Measuring Uncertainty for a Level of Confidence of 95% ( $U = 2Uc(y)$ )	2.92 dB
---	---------

### Uncertainty of Radiated Emission Measurement (1 GHz ~ 18 GHz)

Measuring Uncertainty for a Level of Confidence of 95% ( $U = 2Uc(y)$ )	3.72 dB
---	---------

### Uncertainty of Radiated Emission Measurement (18 GHz ~ 40 GHz)

Measuring Uncertainty for a Level of Confidence of 95% ( $U = 2Uc(y)$ )	3.94 dB
---	---------





## Appendix A. Test Results of Conducted Test

### Conducted Output Power(Average power) & ERP / EIRP

#### <Primary Antenna>

GSM850 Maximum Average Power [dBm] (GT - LC = -2.3 dB)					
Channel	128	189	251	ERP (dBm)	ERP (W)
Frequency	824.2	836.4	848.8		
GSM	32.38	32.31	32.30	27.94	0.6223
GPRS class 8	<b>32.39</b>	32.33	32.31		
GPRS class 10	31.89	31.64	31.79		
GPRS class 11	30.25	30.09	30.12		
GPRS class 12	28.85	28.54	28.52		
EGPRS class 8	27.26	27.31	<b>27.34</b>	22.89	0.1945
EGPRS class 10	26.60	26.69	26.67		
EGPRS class 11	26.48	26.53	26.41		
EGPRS class 12	23.77	23.70	23.54		
Limit	ERP < 7W			Result	Pass

GSM1900 Maximum Average Power [dBm] (GT - LC = 1.5 dB)					
Channel	512	661	810	EIRP (dBm)	EIRP (W)
Frequency	1850.2	1880	1909.8		
GSM	30.23	29.98	29.77	31.74	1.4928
GPRS class 8	<b>30.24</b>	30.00	29.79		
GPRS class 10	28.69	28.58	28.33		
GPRS class 11	27.74	27.63	27.62		
GPRS class 12	26.76	26.47	26.38		
EGPRS class 8	25.14	<b>25.15</b>	25.11	26.65	0.4624
EGPRS class 10	23.86	23.76	23.70		
EGPRS class 11	23.83	23.64	23.74		
EGPRS class 12	22.00	22.02	22.04		
Limit	EIRP < 2W			Result	Pass



WCDMA Band V Maximum Average Power [dBm] (GT - LC = -2.3 dB)							
Channel	4132	4182	4233	ERP (dBm)	ERP (W)		
Frequency	826.4	836.4	846.6				
RMC 12.2K	24.52	24.54	<b>24.56</b>	20.11	0.1026		
HSDPA Subtest-1	24.49	24.52	24.52				
HSDPA Subtest-2	24.51	24.49	24.50				
HSDPA Subtest-3	24.04	23.97	24.13				
HSDPA Subtest-4	24.04	24.01	24.04				
HSUPA Subtest-1	23.89	23.84	23.57				
HSUPA Subtest-2	22.19	21.88	21.79				
HSUPA Subtest-3	23.21	23.19	22.85				
HSUPA Subtest-4	21.89	21.87	21.75				
HSUPA Subtest-5	24.55	24.45	24.48				
Limit	ERP < 7W					Result	Pass

WCDMA Band II Maximum Average Power [dBm] (GT - LC = 1.5 dB)							
Channel	9262	9400	9538	EIRP (dBm)	EIRP (W)		
Frequency	1852.4	1880	1907.6				
RMC 12.2K	<b>24.93</b>	24.83	24.84	26.43	0.4395		
HSDPA Subtest-1	24.86	24.90	24.85				
HSDPA Subtest-2	24.71	24.82	24.85				
HSDPA Subtest-3	24.23	24.33	24.36				
HSDPA Subtest-4	23.79	23.88	23.92				
HSUPA Subtest-1	23.63	23.73	23.73				
HSUPA Subtest-2	21.53	21.68	21.71				
HSUPA Subtest-3	23.56	23.80	23.77				
HSUPA Subtest-4	22.14	22.25	22.27				
HSUPA Subtest-5	24.49	24.72	24.74				
Limit	EIRP < 2W					Result	Pass

WCDMA Band IV Maximum Average Power [dBm] (GT - LC = -1.2 dB)							
Channel	1312	1413	1513	EIRP (dBm)	EIRP (W)		
Frequency	1712.4	1732.6	1752.6				
RMC 12.2K	24.52	24.55	<b>24.60</b>	23.40	0.2188		
HSDPA Subtest-1	24.51	24.59	24.51				
HSDPA Subtest-2	24.41	24.54	24.58				
HSDPA Subtest-3	23.97	24.13	24.08				
HSDPA Subtest-4	23.91	24.08	24.12				
HSUPA Subtest-1	23.60	23.59	23.59				
HSUPA Subtest-2	21.40	21.42	21.61				
HSUPA Subtest-3	23.66	23.63	23.72				
HSUPA Subtest-4	21.61	21.75	21.43				
HSUPA Subtest-5	24.34	24.52	24.56				
Limit	EIRP < 1W					Result	Pass



**<ASDIV Antenna>**

<b>GSM850 Maximum Average Power [dBm] (GT - LC = -4.6 dB)</b>					
Channel	128	189	251	ERP (dBm)	ERP (W)
Frequency	824.2	836.4	848.8		
<b>GSM</b>	32.98	32.98	32.75	26.24	0.4207
<b>GPRS class 8</b>	32.99	32.99	32.77		
<b>GPRS class 10</b>	31.84	31.72	31.64		
<b>GPRS class 11</b>	30.44	30.06	29.98		
<b>GPRS class 12</b>	28.96	28.73	28.56		
<b>EGPRS class 8</b>	27.30	27.06	26.91	20.55	0.1135
<b>EGPRS class 10</b>	26.43	26.48	26.74		
<b>EGPRS class 11</b>	26.63	26.61	26.43		
<b>EGPRS class 12</b>	23.68	23.78	23.56		
Limit	ERP < 7W			Result	Pass

<b>GSM1900 Maximum Average Power [dBm] (GT - LC = 1.4 dB)</b>					
Channel	512	661	810	EIRP (dBm)	EIRP (W)
Frequency	1850.2	1880	1909.8		
<b>GSM</b>	29.56	29.48	29.23	30.97	1.2503
<b>GPRS class 8</b>	29.57	29.49	29.24		
<b>GPRS class 10</b>	28.17	28.04	27.67		
<b>GPRS class 11</b>	27.35	27.19	27.01		
<b>GPRS class 12</b>	26.02	26.06	26.03		
<b>EGPRS class 8</b>	24.73	24.46	24.56	26.13	0.4102
<b>EGPRS class 10</b>	23.51	23.35	23.05		
<b>EGPRS class 11</b>	23.34	23.29	23.03		
<b>EGPRS class 12</b>	21.80	21.69	21.30		
Limit	EIRP < 2W			Result	Pass



WCDMA Band V Maximum Average Power [dBm] (GT - LC = -4.6 dB)							
Channel	4132	4182	4233	ERP (dBm)	ERP (W)		
Frequency	826.4	836.4	846.6				
RMC 12.2K	24.58	24.57	24.49	17.83	0.0607		
HSDPA Subtest-1	24.50	24.57	24.41				
HSDPA Subtest-2	24.56	24.56	24.43				
HSDPA Subtest-3	24.16	24.10	23.96				
HSDPA Subtest-4	24.04	24.09	23.89				
HSUPA Subtest-1	23.65	23.73	23.60				
HSUPA Subtest-2	22.03	22.10	21.96				
HSUPA Subtest-3	23.01	23.01	22.89				
HSUPA Subtest-4	21.99	22.09	21.96				
HSUPA Subtest-5	24.50	24.55	24.53				
Limit	ERP < 7W					Result	Pass

WCDMA Band II Maximum Average Power [dBm] (GT - LC = 1.4 dB)							
Channel	9262	9400	9538	EIRP (dBm)	EIRP (W)		
Frequency	1852.4	1880	1907.6				
RMC 12.2K	24.05	24.17	24.16	25.57	0.3606		
HSDPA Subtest-1	24.16	24.11	24.15				
HSDPA Subtest-2	24.08	24.02	24.09				
HSDPA Subtest-3	23.58	23.54	23.58				
HSDPA Subtest-4	23.03	23.10	23.05				
HSUPA Subtest-1	22.64	22.54	22.67				
HSUPA Subtest-2	21.04	20.85	21.03				
HSUPA Subtest-3	22.00	21.86	22.00				
HSUPA Subtest-4	21.07	20.88	20.98				
HSUPA Subtest-5	23.70	23.50	23.60				
Limit	EIRP < 2W					Result	Pass

WCDMA Band IV Maximum Average Power [dBm] (GT - LC = -2.6 dB)							
Channel	1312	1413	1513	EIRP (dBm)	EIRP (W)		
Frequency	1712.4	1732.6	1752.6				
RMC 12.2K	23.65	23.64	23.80	21.20	0.1318		
HSDPA Subtest-1	23.63	23.78	23.76				
HSDPA Subtest-2	23.57	23.75	23.70				
HSDPA Subtest-3	23.09	23.25	23.21				
HSDPA Subtest-4	23.04	23.19	23.25				
HSUPA Subtest-1	22.38	22.41	22.58				
HSUPA Subtest-2	19.80	19.80	21.86				
HSUPA Subtest-3	22.41	22.37	22.61				
HSUPA Subtest-4	19.81	21.53	22.42				
HSUPA Subtest-5	23.40	23.40	23.70				
Limit	EIRP < 1W					Result	Pass



## A2. GSM

### Peak-to-Average Ratio

Mode	GSM850		Limit: 13dB
Mod.	GPRS class 8	EDGE class 8	Result
Lowest CH	0.24	3.12	PASS
Middle CH	0.24	3.16	
Highest CH	0.24	3.08	

Mode	GSM1900		Limit: 13dB
Mod.	GPRS class 8	EDGE class 8	Result
Lowest CH	0.40	3.08	PASS
Middle CH	0.44	3.32	
Highest CH	0.40	3.44	

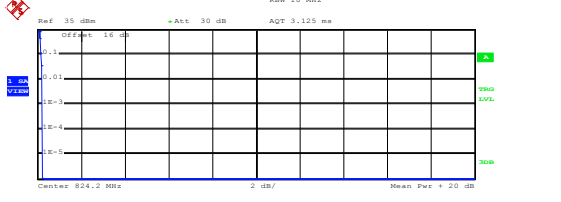
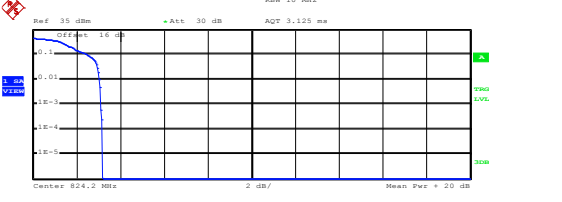
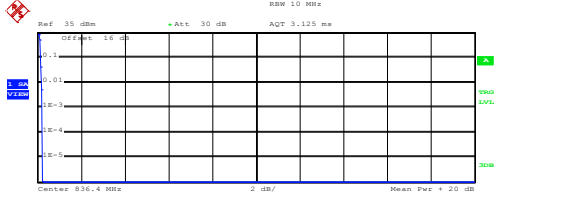
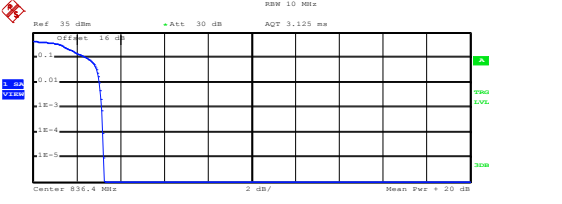
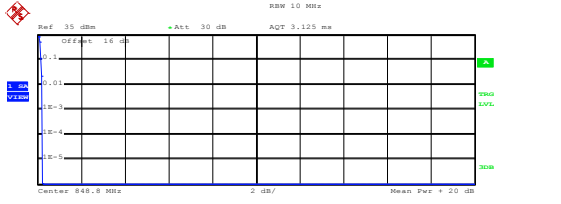
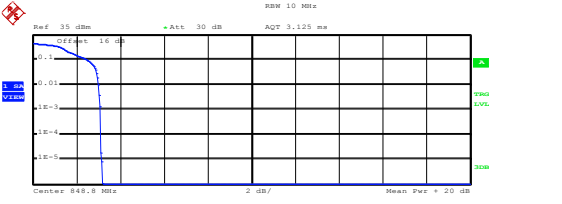

GSM850 (GPRS class 8)	GSM850 (EDGE class 8)
<p style="text-align: center;"><b>Lowest Channel</b></p>  <p>Center 824.2 MHz      2 dB/      Mean Pwr + 20 dB</p> <p>Complementary Cumulative Distribution Function (100000 samples)</p> <p>Trace 1</p> <p>Mean 31.93 dBm Peak 32.15 dBm Crest 0.22 dB</p> <p>10 % 0.16 dB 1 % 0.24 dB .1 % 0.24 dB .01 % 0.24 dB</p> <p>Date: 6.APR.2022 14:29:18</p>	<p style="text-align: center;"><b>Lowest Channel</b></p>  <p>Center 824.2 MHz      2 dB/      Mean Pwr + 20 dB</p> <p>Complementary Cumulative Distribution Function (100000 samples)</p> <p>Trace 1</p> <p>Mean 25.93 dBm Peak 29.11 dBm Crest 3.18 dB</p> <p>10 % 2.52 dB 1 % 3.04 dB .1 % 3.12 dB .01 % 3.20 dB</p> <p>Date: 6.APR.2022 14:45:58</p>
<p style="text-align: center;"><b>Middle Channel</b></p>  <p>Center 836.4 MHz      2 dB/      Mean Pwr + 20 dB</p> <p>Complementary Cumulative Distribution Function (100000 samples)</p> <p>Trace 1</p> <p>Mean 31.84 dBm Peak 32.08 dBm Crest 0.23 dB</p> <p>10 % 0.16 dB 1 % 0.20 dB .1 % 0.24 dB .01 % 0.24 dB</p> <p>Date: 6.APR.2022 14:29:35</p>	<p style="text-align: center;"><b>Middle Channel</b></p>  <p>Center 836.4 MHz      2 dB/      Mean Pwr + 20 dB</p> <p>Complementary Cumulative Distribution Function (100000 samples)</p> <p>Trace 1</p> <p>Mean 25.84 dBm Peak 29.11 dBm Crest 3.27 dB</p> <p>10 % 2.48 dB 1 % 3.04 dB .1 % 3.16 dB .01 % 3.20 dB</p> <p>Date: 6.APR.2022 14:46:14</p>
<p style="text-align: center;"><b>Highest Channel</b></p>  <p>Center 848.8 MHz      2 dB/      Mean Pwr + 20 dB</p> <p>Complementary Cumulative Distribution Function (100000 samples)</p> <p>Trace 1</p> <p>Mean 31.70 dBm Peak 31.93 dBm Crest 0.24 dB</p> <p>10 % 0.16 dB 1 % 0.24 dB .1 % 0.24 dB .01 % 0.24 dB</p> <p>Date: 6.APR.2022 14:29:52</p>	<p style="text-align: center;"><b>Highest Channel</b></p>  <p>Center 848.8 MHz      2 dB/      Mean Pwr + 20 dB</p> <p>Complementary Cumulative Distribution Function (100000 samples)</p> <p>Trace 1</p> <p>Mean 26.07 dBm Peak 29.25 dBm Crest 3.18 dB</p> <p>10 % 2.48 dB 1 % 3.00 dB .1 % 3.08 dB .01 % 3.12 dB</p> <p>Date: 6.APR.2022 14:46:31</p>

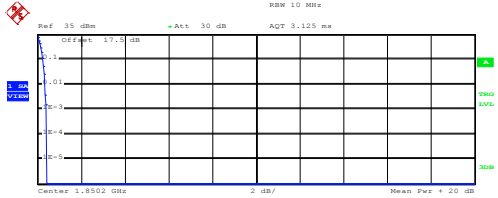
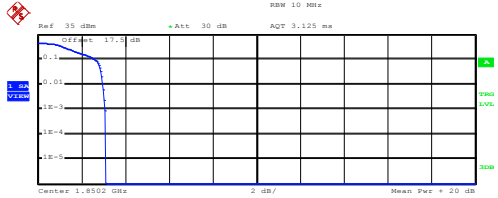
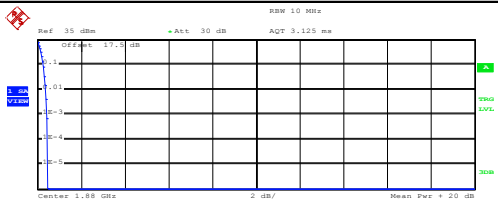
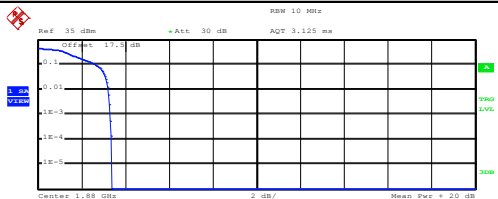
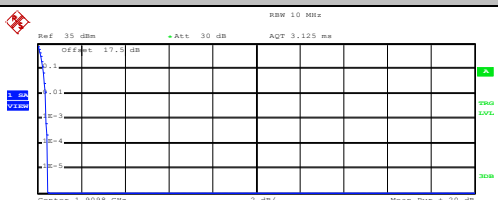
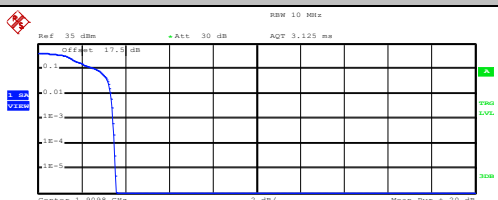

GSM1900 (GPRS class 8)	GSM1900 (EDGE class 8)
<p align="center"><b>Lowest Channel</b></p>  <p>Center 1.8502 GHz      2 dB/      Mean Pwr + 20 dB</p> <p>Complementary Cumulative Distribution Function (100000 samples)</p> <p>Trace 1</p> <p>Mean 27.20 dBm Peak 27.63 dBm Crest 0.43 dB</p> <p>10 % 0.24 dB 1 % 0.36 dB .1 % 0.40 dB .01 % 0.44 dB</p> <p>Date: 6.APR.2022 15:02:50</p>	<p align="center"><b>Lowest Channel</b></p>  <p>Center 1.8502 GHz      2 dB/      Mean Pwr + 20 dB</p> <p>Complementary Cumulative Distribution Function (100000 samples)</p> <p>Trace 1</p> <p>Mean 22.84 dBm Peak 25.94 dBm Crest 3.10 dB</p> <p>10 % 2.60 dB 1 % 2.96 dB .1 % 3.08 dB .01 % 3.12 dB</p> <p>Date: 6.APR.2022 15:17:04</p>
<p align="center"><b>Middle Channel</b></p>  <p>Center 1.88 GHz      2 dB/      Mean Pwr + 20 dB</p> <p>Complementary Cumulative Distribution Function (100000 samples)</p> <p>Trace 1</p> <p>Mean 26.97 dBm Peak 27.42 dBm Crest 0.45 dB</p> <p>10 % 0.28 dB 1 % 0.36 dB .1 % 0.44 dB .01 % 0.48 dB</p> <p>Date: 6.APR.2022 15:03:06</p>	<p align="center"><b>Middle Channel</b></p>  <p>Center 1.88 GHz      2 dB/      Mean Pwr + 20 dB</p> <p>Complementary Cumulative Distribution Function (100000 samples)</p> <p>Trace 1</p> <p>Mean 22.27 dBm Peak 25.66 dBm Crest 3.39 dB</p> <p>10 % 2.68 dB 1 % 3.20 dB .1 % 3.32 dB .01 % 3.36 dB</p> <p>Date: 6.APR.2022 15:17:21</p>
<p align="center"><b>Highest Channel</b></p>  <p>Center 1.9098 GHz      2 dB/      Mean Pwr + 20 dB</p> <p>Complementary Cumulative Distribution Function (100000 samples)</p> <p>Trace 1</p> <p>Mean 26.89 dBm Peak 27.35 dBm Crest 0.46 dB</p> <p>10 % 0.28 dB 1 % 0.36 dB .1 % 0.40 dB .01 % 0.48 dB</p> <p>Date: 6.APR.2022 15:03:22</p>	<p align="center"><b>Highest Channel</b></p>  <p>Center 1.9098 GHz      2 dB/      Mean Pwr + 20 dB</p> <p>Complementary Cumulative Distribution Function (100000 samples)</p> <p>Trace 1</p> <p>Mean 22.24 dBm Peak 25.80 dBm Crest 3.56 dB</p> <p>10 % 2.64 dB 1 % 3.32 dB .1 % 3.44 dB .01 % 3.52 dB</p> <p>Date: 6.APR.2022 15:17:38</p>



**26dB Bandwidth**

Mode	GSM850: 26dB BW(MHz)	
Mod.	GPRS class 8	EDGE class 8
Lowest CH	0.308	0.310
Middle CH	0.313	0.304
Highest CH	0.313	0.303

Mode	GSM1900: 26dB BW(MHz)	
Mod.	GPRS class 8	EDGE class 8
Lowest CH	0.310	0.305
Middle CH	0.312	0.306
Highest CH	0.312	0.305



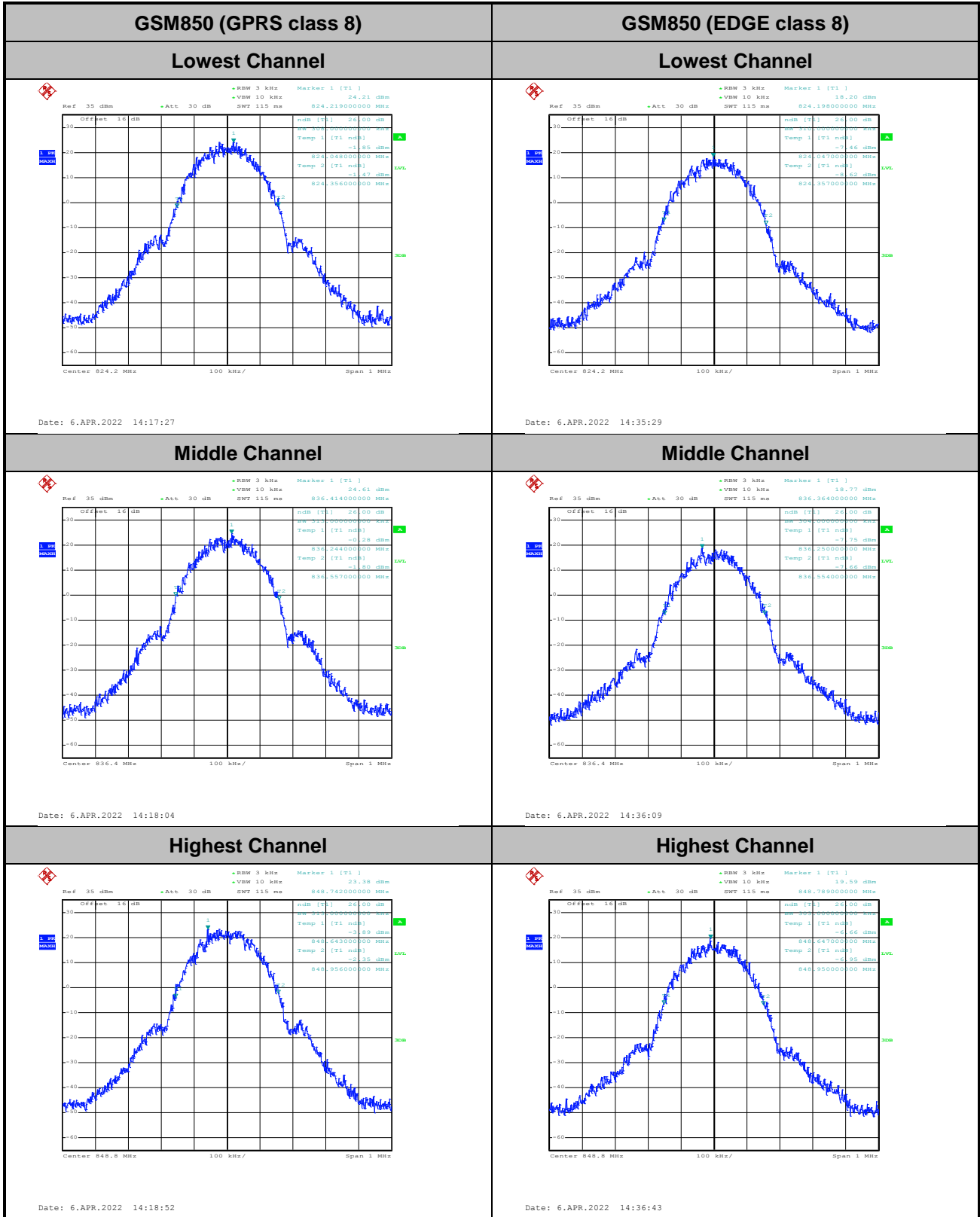

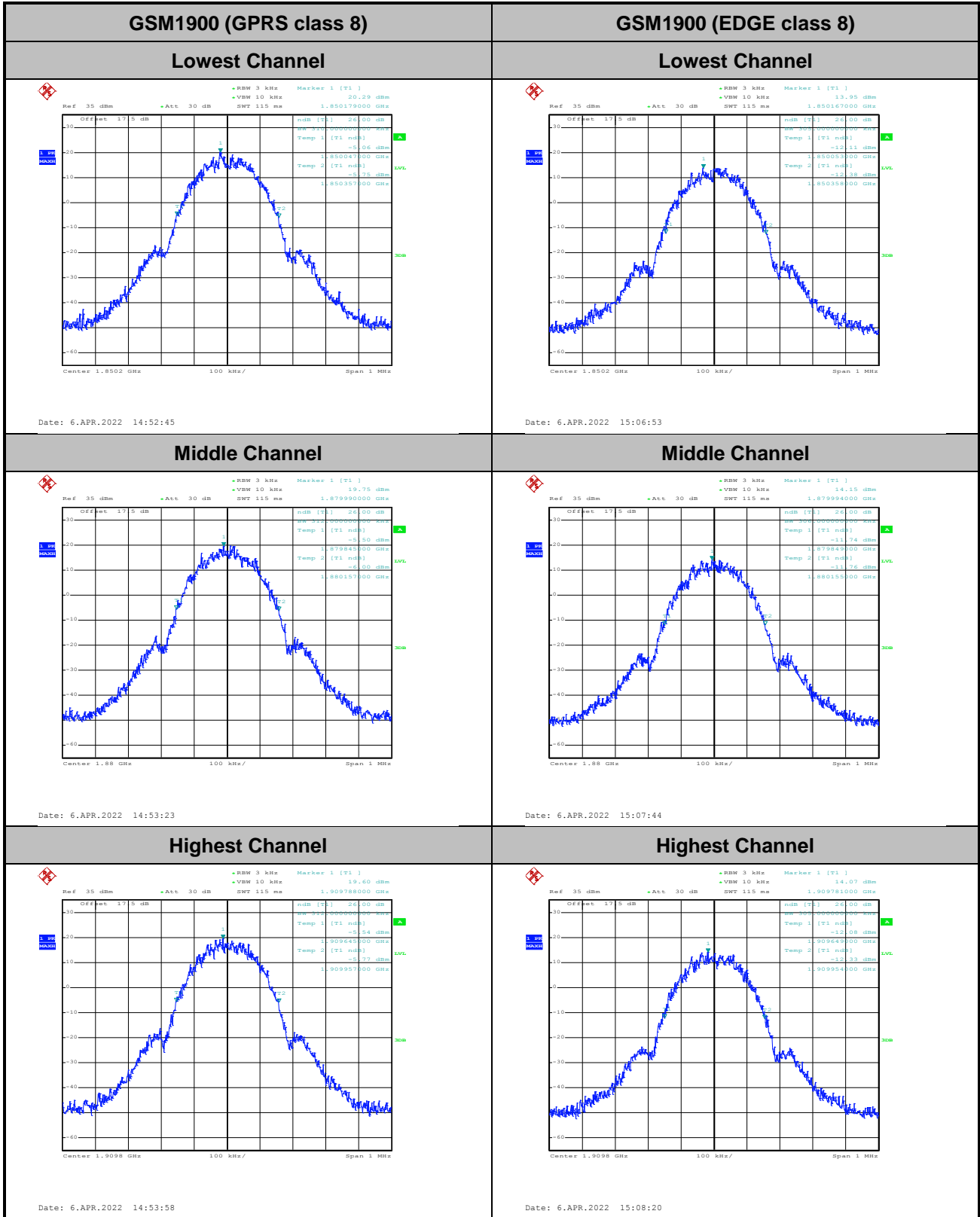



### Occupied Bandwidth

Mode	GSM850: 99% OBW (MHz)	
Mod.	GPRS class 8	EDGE class 8
Lowest CH	0.246	0.255
Middle CH	0.244	0.252
Highest CH	0.243	0.250

Mode	GSM1900: 99% OBW (MHz)	
Mod.	GPRS class 8	EDGE class 8
Lowest CH	0.243	0.247
Middle CH	0.244	0.249
Highest CH	0.246	0.248

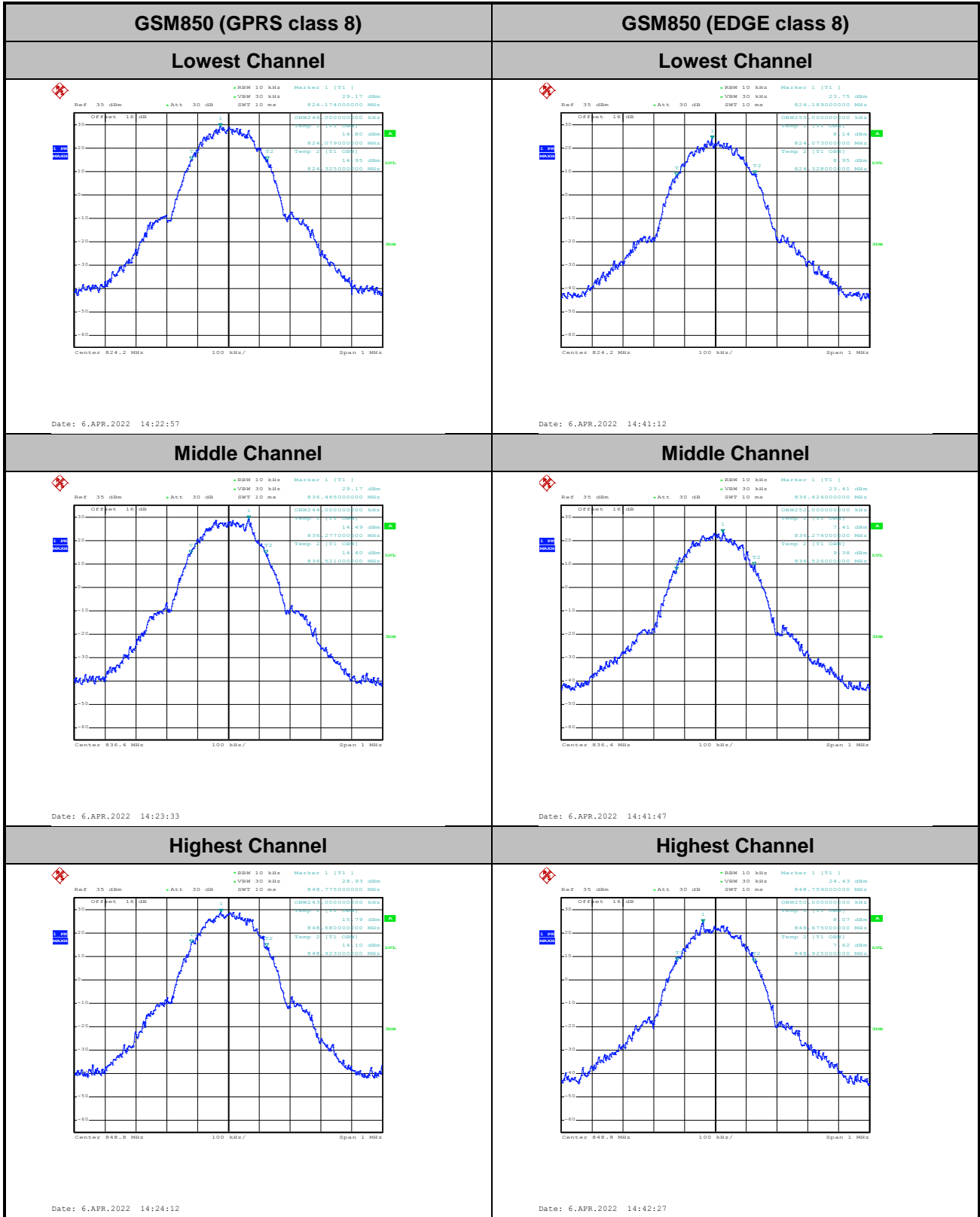



GSM1900 (GPRS class 8)	GSM1900 (EDGE class 8)
<p style="text-align: center;"><b>Lowest Channel</b></p> <p style="text-align: center;">Date: 6.APR.2022 14:57:53</p>	<p style="text-align: center;"><b>Lowest Channel</b></p> <p style="text-align: center;">Date: 6.APR.2022 15:12:09</p>
<p style="text-align: center;"><b>Middle Channel</b></p> <p style="text-align: center;">Date: 6.APR.2022 14:58:26</p>	<p style="text-align: center;"><b>Middle Channel</b></p> <p style="text-align: center;">Date: 6.APR.2022 15:12:44</p>
<p style="text-align: center;"><b>Highest Channel</b></p> <p style="text-align: center;">Date: 6.APR.2022 14:59:17</p>	<p style="text-align: center;"><b>Highest Channel</b></p> <p style="text-align: center;">Date: 6.APR.2022 15:13:17</p>



# Conducted Band Edge

## GSM850 (GPRS class 8)

### Lowest Band Edge

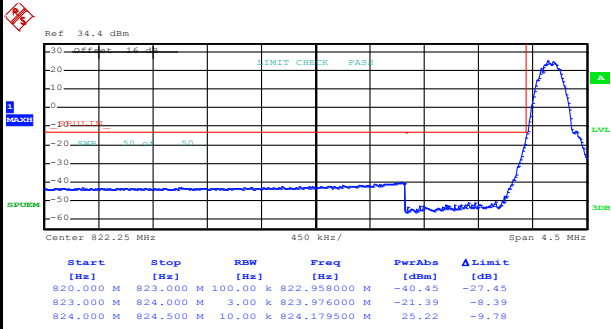

Date: 6.APR.2022 14:25:53

### Highest Band Edge

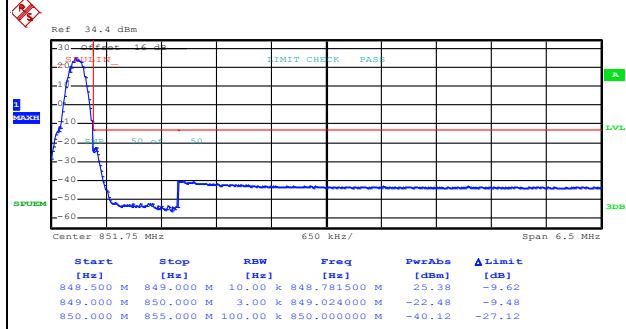

Date: 6.APR.2022 14:28:45

## GSM850 (EDGE class 8)

### Lowest Band Edge

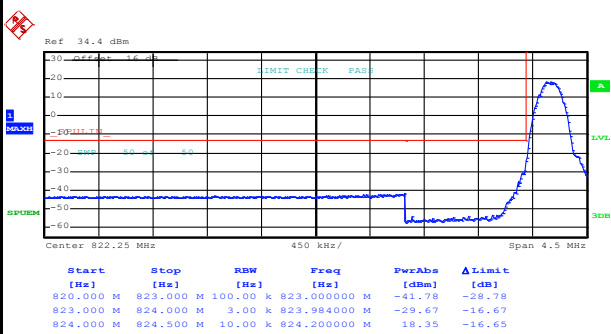

Date: 6.APR.2022 14:44:03

### Highest Band Edge

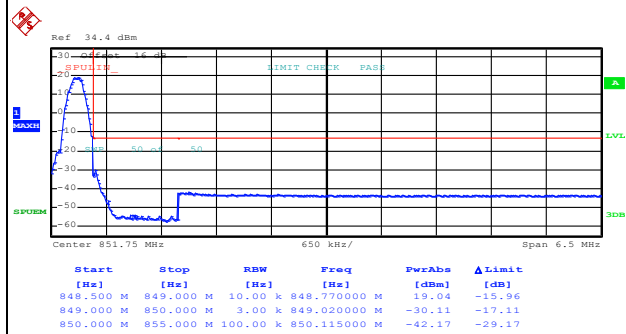

Date: 6.APR.2022 14:45:36



GSM1900 (GPRS class 8)

Lowest Band Edge

Highest Band Edge

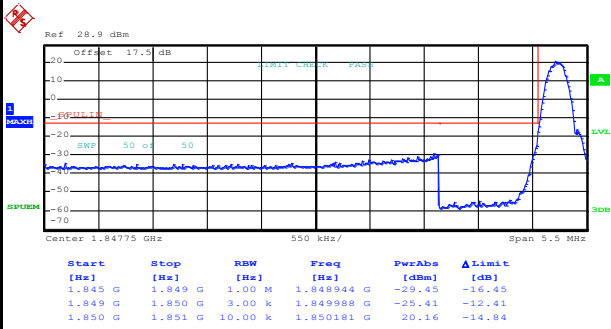

Date: 6.APR.2022 15:00:53

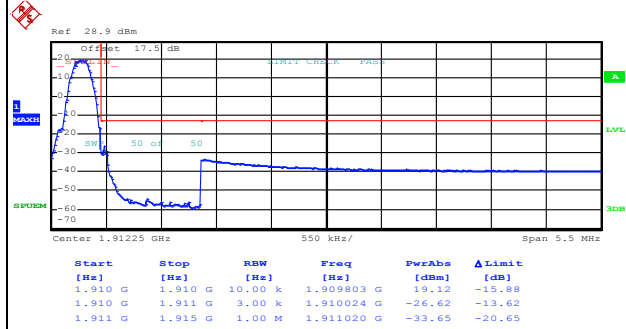

Date: 6.APR.2022 15:02:27

GSM1900 (EDGE class 8)

Lowest Band Edge

Highest Band Edge

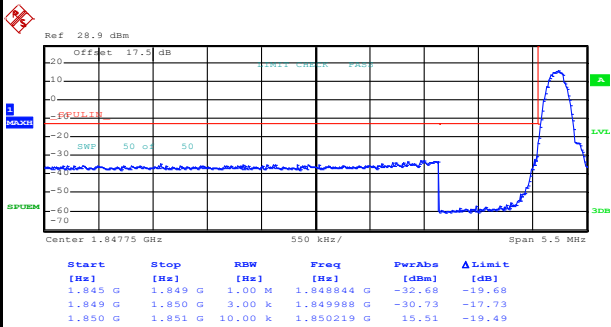

Date: 6.APR.2022 15:15:09

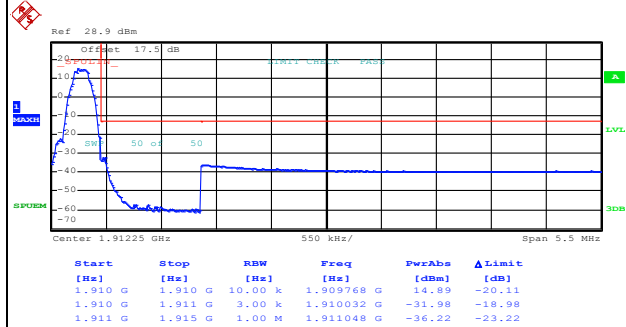

Date: 6.APR.2022 15:16:43



# Conducted Spurious Emission

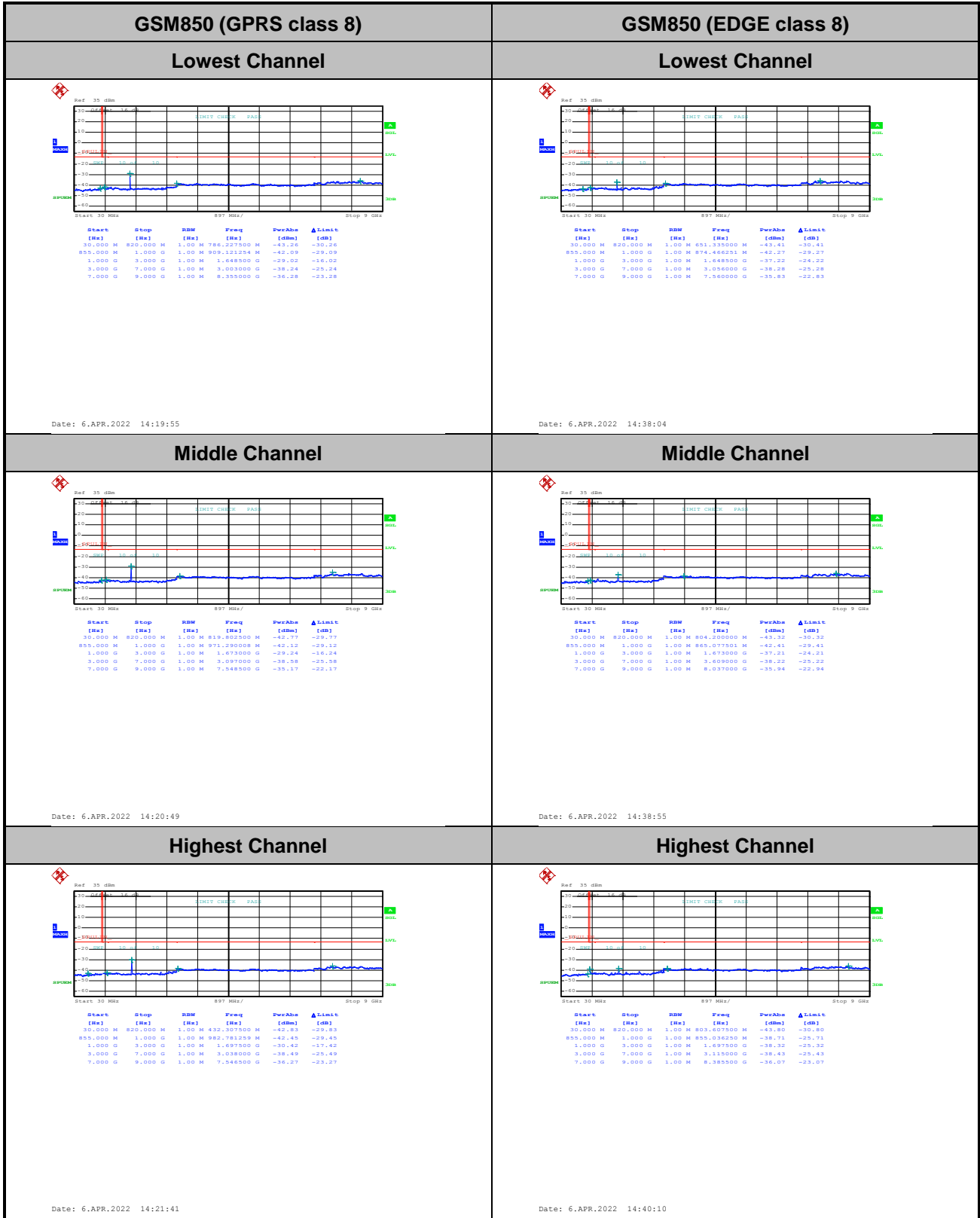



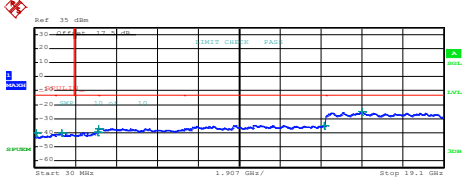
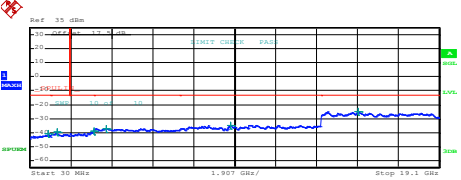
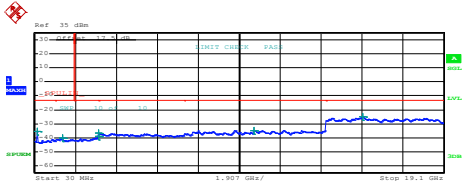
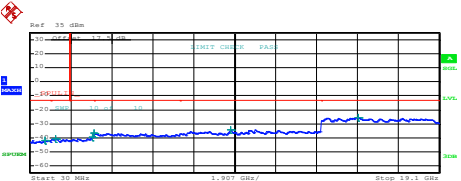
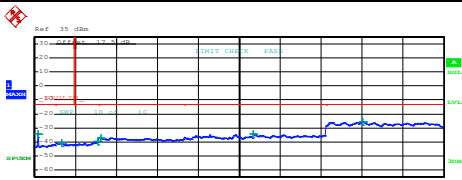
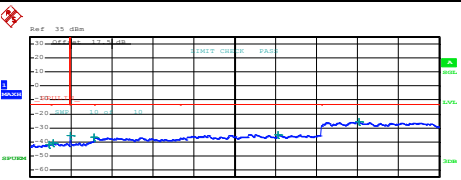

GSM1900 (GPRS class 8)	GSM1900 (EDGE class 8)																																																																																				
Lowest Channel	Lowest Channel																																																																																				
 <table border="1" data-bbox="239 577 638 672"> <thead> <tr> <th>Start [Hz]</th> <th>Stop [Hz]</th> <th>RBW [Hz]</th> <th>Freq [Hz]</th> <th>PwrAve [dBm]</th> <th>ΔLimit [dB]</th> </tr> </thead> <tbody> <tr><td>30,000 M</td><td>1,000 G</td><td>1,000 M</td><td>111,905000 M</td><td>-40.21</td><td>-27.23</td></tr> <tr><td>1,000 G</td><td>1,845 G</td><td>1,000 M</td><td>1,280791 G</td><td>-39.87</td><td>-26.87</td></tr> <tr><td>1,845 G</td><td>3,000 G</td><td>1,000 M</td><td>2,072519 G</td><td>-39.85</td><td>-26.45</td></tr> <tr><td>3,000 G</td><td>7,000 G</td><td>1,000 M</td><td>3,021000 G</td><td>-37.16</td><td>-24.16</td></tr> <tr><td>7,000 G</td><td>13,600 G</td><td>1,000 M</td><td>13,539775 G</td><td>-34.84</td><td>-21.84</td></tr> <tr><td>13,600 G</td><td>19,100 G</td><td>1,000 M</td><td>15,285750 G</td><td>-25.13</td><td>-12.13</td></tr> </tbody> </table> <p>Date: 6.APR.2022 14:55:15</p>	Start [Hz]	Stop [Hz]	RBW [Hz]	Freq [Hz]	PwrAve [dBm]	ΔLimit [dB]	30,000 M	1,000 G	1,000 M	111,905000 M	-40.21	-27.23	1,000 G	1,845 G	1,000 M	1,280791 G	-39.87	-26.87	1,845 G	3,000 G	1,000 M	2,072519 G	-39.85	-26.45	3,000 G	7,000 G	1,000 M	3,021000 G	-37.16	-24.16	7,000 G	13,600 G	1,000 M	13,539775 G	-34.84	-21.84	13,600 G	19,100 G	1,000 M	15,285750 G	-25.13	-12.13	 <table border="1" data-bbox="893 577 1292 672"> <thead> <tr> <th>Start [Hz]</th> <th>Stop [Hz]</th> <th>RBW [Hz]</th> <th>Freq [Hz]</th> <th>PwrAve [dBm]</th> <th>ΔLimit [dB]</th> </tr> </thead> <tbody> <tr><td>30,000 M</td><td>1,000 G</td><td>1,000 M</td><td>873,413000 M</td><td>-41.01</td><td>-28.01</td></tr> <tr><td>1,000 G</td><td>1,845 G</td><td>1,000 M</td><td>1,273780 G</td><td>-39.74</td><td>-26.74</td></tr> <tr><td>1,845 G</td><td>3,000 G</td><td>1,000 M</td><td>2,993660 G</td><td>-39.24</td><td>-26.24</td></tr> <tr><td>3,000 G</td><td>7,000 G</td><td>1,000 M</td><td>3,596000 G</td><td>-37.17</td><td>-24.17</td></tr> <tr><td>7,000 G</td><td>13,600 G</td><td>1,000 M</td><td>9,378475 G</td><td>-34.70</td><td>-21.70</td></tr> <tr><td>13,600 G</td><td>19,100 G</td><td>1,000 M</td><td>15,305687 G</td><td>-24.55</td><td>-11.55</td></tr> </tbody> </table> <p>Date: 6.APR.2022 15:09:26</p>	Start [Hz]	Stop [Hz]	RBW [Hz]	Freq [Hz]	PwrAve [dBm]	ΔLimit [dB]	30,000 M	1,000 G	1,000 M	873,413000 M	-41.01	-28.01	1,000 G	1,845 G	1,000 M	1,273780 G	-39.74	-26.74	1,845 G	3,000 G	1,000 M	2,993660 G	-39.24	-26.24	3,000 G	7,000 G	1,000 M	3,596000 G	-37.17	-24.17	7,000 G	13,600 G	1,000 M	9,378475 G	-34.70	-21.70	13,600 G	19,100 G	1,000 M	15,305687 G	-24.55	-11.55
Start [Hz]	Stop [Hz]	RBW [Hz]	Freq [Hz]	PwrAve [dBm]	ΔLimit [dB]																																																																																
30,000 M	1,000 G	1,000 M	111,905000 M	-40.21	-27.23																																																																																
1,000 G	1,845 G	1,000 M	1,280791 G	-39.87	-26.87																																																																																
1,845 G	3,000 G	1,000 M	2,072519 G	-39.85	-26.45																																																																																
3,000 G	7,000 G	1,000 M	3,021000 G	-37.16	-24.16																																																																																
7,000 G	13,600 G	1,000 M	13,539775 G	-34.84	-21.84																																																																																
13,600 G	19,100 G	1,000 M	15,285750 G	-25.13	-12.13																																																																																
Start [Hz]	Stop [Hz]	RBW [Hz]	Freq [Hz]	PwrAve [dBm]	ΔLimit [dB]																																																																																
30,000 M	1,000 G	1,000 M	873,413000 M	-41.01	-28.01																																																																																
1,000 G	1,845 G	1,000 M	1,273780 G	-39.74	-26.74																																																																																
1,845 G	3,000 G	1,000 M	2,993660 G	-39.24	-26.24																																																																																
3,000 G	7,000 G	1,000 M	3,596000 G	-37.17	-24.17																																																																																
7,000 G	13,600 G	1,000 M	9,378475 G	-34.70	-21.70																																																																																
13,600 G	19,100 G	1,000 M	15,305687 G	-24.55	-11.55																																																																																
Middle Channel	Middle Channel																																																																																				
 <table border="1" data-bbox="239 1093 638 1187"> <thead> <tr> <th>Start [Hz]</th> <th>Stop [Hz]</th> <th>RBW [Hz]</th> <th>Freq [Hz]</th> <th>PwrAve [dBm]</th> <th>ΔLimit [dB]</th> </tr> </thead> <tbody> <tr><td>30,000 M</td><td>1,000 G</td><td>1,000 M</td><td>141,792500 M</td><td>-35.60</td><td>-22.60</td></tr> <tr><td>1,000 G</td><td>1,845 G</td><td>1,000 M</td><td>1,308214 G</td><td>-40.35</td><td>-27.35</td></tr> <tr><td>1,845 G</td><td>3,000 G</td><td>1,000 M</td><td>2,989186 G</td><td>-39.04</td><td>-26.04</td></tr> <tr><td>3,000 G</td><td>7,000 G</td><td>1,000 M</td><td>3,012000 G</td><td>-36.77</td><td>-23.77</td></tr> <tr><td>7,000 G</td><td>13,600 G</td><td>1,000 M</td><td>10,243900 G</td><td>-34.65</td><td>-21.65</td></tr> <tr><td>13,600 G</td><td>19,100 G</td><td>1,000 M</td><td>15,340063 G</td><td>-25.19</td><td>-12.19</td></tr> </tbody> </table> <p>Date: 6.APR.2022 14:56:19</p>	Start [Hz]	Stop [Hz]	RBW [Hz]	Freq [Hz]	PwrAve [dBm]	ΔLimit [dB]	30,000 M	1,000 G	1,000 M	141,792500 M	-35.60	-22.60	1,000 G	1,845 G	1,000 M	1,308214 G	-40.35	-27.35	1,845 G	3,000 G	1,000 M	2,989186 G	-39.04	-26.04	3,000 G	7,000 G	1,000 M	3,012000 G	-36.77	-23.77	7,000 G	13,600 G	1,000 M	10,243900 G	-34.65	-21.65	13,600 G	19,100 G	1,000 M	15,340063 G	-25.19	-12.19	 <table border="1" data-bbox="893 1093 1292 1187"> <thead> <tr> <th>Start [Hz]</th> <th>Stop [Hz]</th> <th>RBW [Hz]</th> <th>Freq [Hz]</th> <th>PwrAve [dBm]</th> <th>ΔLimit [dB]</th> </tr> </thead> <tbody> <tr><td>30,000 M</td><td>1,000 G</td><td>1,000 M</td><td>705,362500 M</td><td>-41.93</td><td>-28.93</td></tr> <tr><td>1,000 G</td><td>1,845 G</td><td>1,000 M</td><td>1,205708 G</td><td>-40.81</td><td>-27.81</td></tr> <tr><td>1,845 G</td><td>3,000 G</td><td>1,000 M</td><td>2,928119 G</td><td>-39.41</td><td>-26.41</td></tr> <tr><td>3,000 G</td><td>7,000 G</td><td>1,000 M</td><td>3,005000 G</td><td>-36.86</td><td>-23.86</td></tr> <tr><td>7,000 G</td><td>13,600 G</td><td>1,000 M</td><td>9,362800 G</td><td>-34.35</td><td>-21.35</td></tr> <tr><td>13,600 G</td><td>19,100 G</td><td>1,000 M</td><td>15,313938 G</td><td>-25.52</td><td>-12.52</td></tr> </tbody> </table> <p>Date: 6.APR.2022 15:10:30</p>	Start [Hz]	Stop [Hz]	RBW [Hz]	Freq [Hz]	PwrAve [dBm]	ΔLimit [dB]	30,000 M	1,000 G	1,000 M	705,362500 M	-41.93	-28.93	1,000 G	1,845 G	1,000 M	1,205708 G	-40.81	-27.81	1,845 G	3,000 G	1,000 M	2,928119 G	-39.41	-26.41	3,000 G	7,000 G	1,000 M	3,005000 G	-36.86	-23.86	7,000 G	13,600 G	1,000 M	9,362800 G	-34.35	-21.35	13,600 G	19,100 G	1,000 M	15,313938 G	-25.52	-12.52
Start [Hz]	Stop [Hz]	RBW [Hz]	Freq [Hz]	PwrAve [dBm]	ΔLimit [dB]																																																																																
30,000 M	1,000 G	1,000 M	141,792500 M	-35.60	-22.60																																																																																
1,000 G	1,845 G	1,000 M	1,308214 G	-40.35	-27.35																																																																																
1,845 G	3,000 G	1,000 M	2,989186 G	-39.04	-26.04																																																																																
3,000 G	7,000 G	1,000 M	3,012000 G	-36.77	-23.77																																																																																
7,000 G	13,600 G	1,000 M	10,243900 G	-34.65	-21.65																																																																																
13,600 G	19,100 G	1,000 M	15,340063 G	-25.19	-12.19																																																																																
Start [Hz]	Stop [Hz]	RBW [Hz]	Freq [Hz]	PwrAve [dBm]	ΔLimit [dB]																																																																																
30,000 M	1,000 G	1,000 M	705,362500 M	-41.93	-28.93																																																																																
1,000 G	1,845 G	1,000 M	1,205708 G	-40.81	-27.81																																																																																
1,845 G	3,000 G	1,000 M	2,928119 G	-39.41	-26.41																																																																																
3,000 G	7,000 G	1,000 M	3,005000 G	-36.86	-23.86																																																																																
7,000 G	13,600 G	1,000 M	9,362800 G	-34.35	-21.35																																																																																
13,600 G	19,100 G	1,000 M	15,313938 G	-25.52	-12.52																																																																																
Highest Channel	Highest Channel																																																																																				
 <table border="1" data-bbox="239 1608 638 1702"> <thead> <tr> <th>Start [Hz]</th> <th>Stop [Hz]</th> <th>RBW [Hz]</th> <th>Freq [Hz]</th> <th>PwrAve [dBm]</th> <th>ΔLimit [dB]</th> </tr> </thead> <tbody> <tr><td>30,000 M</td><td>1,000 G</td><td>1,000 M</td><td>171,602000 M</td><td>-34.47</td><td>-21.47</td></tr> <tr><td>1,000 G</td><td>1,845 G</td><td>1,000 M</td><td>1,276526 G</td><td>-40.85</td><td>-27.85</td></tr> <tr><td>1,845 G</td><td>3,000 G</td><td>1,000 M</td><td>2,974774 G</td><td>-39.71</td><td>-26.71</td></tr> <tr><td>3,000 G</td><td>7,000 G</td><td>1,000 M</td><td>3,133000 G</td><td>-36.99</td><td>-23.99</td></tr> <tr><td>7,000 G</td><td>13,600 G</td><td>1,000 M</td><td>10,215025 G</td><td>-34.48</td><td>-21.48</td></tr> <tr><td>13,600 G</td><td>19,100 G</td><td>1,000 M</td><td>15,320325 G</td><td>-25.53</td><td>-12.53</td></tr> </tbody> </table> <p>Date: 6.APR.2022 14:57:10</p>	Start [Hz]	Stop [Hz]	RBW [Hz]	Freq [Hz]	PwrAve [dBm]	ΔLimit [dB]	30,000 M	1,000 G	1,000 M	171,602000 M	-34.47	-21.47	1,000 G	1,845 G	1,000 M	1,276526 G	-40.85	-27.85	1,845 G	3,000 G	1,000 M	2,974774 G	-39.71	-26.71	3,000 G	7,000 G	1,000 M	3,133000 G	-36.99	-23.99	7,000 G	13,600 G	1,000 M	10,215025 G	-34.48	-21.48	13,600 G	19,100 G	1,000 M	15,320325 G	-25.53	-12.53	 <table border="1" data-bbox="893 1608 1292 1702"> <thead> <tr> <th>Start [Hz]</th> <th>Stop [Hz]</th> <th>RBW [Hz]</th> <th>Freq [Hz]</th> <th>PwrAve [dBm]</th> <th>ΔLimit [dB]</th> </tr> </thead> <tbody> <tr><td>30,000 M</td><td>1,000 G</td><td>1,000 M</td><td>809,547000 M</td><td>-41.81</td><td>-28.81</td></tr> <tr><td>1,000 G</td><td>1,845 G</td><td>1,000 M</td><td>1,086824 G</td><td>-40.94</td><td>-27.94</td></tr> <tr><td>1,845 G</td><td>3,000 G</td><td>1,000 M</td><td>1,913271 G</td><td>-35.76</td><td>-22.76</td></tr> <tr><td>3,000 G</td><td>7,000 G</td><td>1,000 M</td><td>3,004000 G</td><td>-36.81</td><td>-23.81</td></tr> <tr><td>7,000 G</td><td>13,600 G</td><td>1,000 M</td><td>11,572130 G</td><td>-34.79</td><td>-21.79</td></tr> <tr><td>13,600 G</td><td>19,100 G</td><td>1,000 M</td><td>15,335362 G</td><td>-25.24</td><td>-12.24</td></tr> </tbody> </table> <p>Date: 6.APR.2022 15:11:23</p>	Start [Hz]	Stop [Hz]	RBW [Hz]	Freq [Hz]	PwrAve [dBm]	ΔLimit [dB]	30,000 M	1,000 G	1,000 M	809,547000 M	-41.81	-28.81	1,000 G	1,845 G	1,000 M	1,086824 G	-40.94	-27.94	1,845 G	3,000 G	1,000 M	1,913271 G	-35.76	-22.76	3,000 G	7,000 G	1,000 M	3,004000 G	-36.81	-23.81	7,000 G	13,600 G	1,000 M	11,572130 G	-34.79	-21.79	13,600 G	19,100 G	1,000 M	15,335362 G	-25.24	-12.24
Start [Hz]	Stop [Hz]	RBW [Hz]	Freq [Hz]	PwrAve [dBm]	ΔLimit [dB]																																																																																
30,000 M	1,000 G	1,000 M	171,602000 M	-34.47	-21.47																																																																																
1,000 G	1,845 G	1,000 M	1,276526 G	-40.85	-27.85																																																																																
1,845 G	3,000 G	1,000 M	2,974774 G	-39.71	-26.71																																																																																
3,000 G	7,000 G	1,000 M	3,133000 G	-36.99	-23.99																																																																																
7,000 G	13,600 G	1,000 M	10,215025 G	-34.48	-21.48																																																																																
13,600 G	19,100 G	1,000 M	15,320325 G	-25.53	-12.53																																																																																
Start [Hz]	Stop [Hz]	RBW [Hz]	Freq [Hz]	PwrAve [dBm]	ΔLimit [dB]																																																																																
30,000 M	1,000 G	1,000 M	809,547000 M	-41.81	-28.81																																																																																
1,000 G	1,845 G	1,000 M	1,086824 G	-40.94	-27.94																																																																																
1,845 G	3,000 G	1,000 M	1,913271 G	-35.76	-22.76																																																																																
3,000 G	7,000 G	1,000 M	3,004000 G	-36.81	-23.81																																																																																
7,000 G	13,600 G	1,000 M	11,572130 G	-34.79	-21.79																																																																																
13,600 G	19,100 G	1,000 M	15,335362 G	-25.24	-12.24																																																																																



**Frequency Stability**

Test Conditions	Middle Channel	GSM850 (GPRS class 8)	GSM850 (EDGE class 8)	Limit 2.5ppm
Temperature (°C)	Voltage (Volt)	Deviation (ppm)		Result
50	Normal Voltage	0.0072	0.0072	PASS
40	Normal Voltage	0.0036	0.0060	
30	Normal Voltage	0.0012	0.0024	
20(Ref.)	Normal Voltage	0.0000	0.0000	
10	Normal Voltage	0.0048	0.0060	
0	Normal Voltage	0.0096	0.0108	
-10	Normal Voltage	0.0203	0.0191	
-20	Normal Voltage	0.0239	0.0263	
-30	Normal Voltage	0.0287	0.0347	
20	Maximum Voltage	0.0072	0.0084	
20	Normal Voltage	0.0060	0.0084	
20	Battery End Point	0.0048	0.0060	

Test Conditions	Middle Channel	GSM1900 (GPRS class 8)	GSM1900 (EDGE class 8)	Limit Note 2.
Temperature (°C)	Voltage (Volt)	Deviation (ppm)		Result
50	Normal Voltage	0.0074	0.0000	PASS
40	Normal Voltage	0.0053	0.0005	
30	Normal Voltage	0.0037	0.0011	
20(Ref.)	Normal Voltage	0.0000	0.0000	
10	Normal Voltage	0.0043	0.0021	
0	Normal Voltage	0.0096	0.0043	
-10	Normal Voltage	0.0154	0.0005	
-20	Normal Voltage	0.0197	0.0011	
-30	Normal Voltage	0.0245	0.0032	
20	Maximum Voltage	0.0096	0.0021	
20	Normal Voltage	0.0053	0.0048	
20	Battery End Point	0.0197	0.0314	

**Note:**

1. Normal Voltage = 3.85V. ; Battery End Point (BEP) = 3.4 V. ; Maximum Voltage =4.3 V
2. The frequency fundamental emissions stay within the authorized frequency block.



### A3. WCDMA

#### Peak-to-Average Ratio

Mode	WCDMA Band V	WCDMA Band II	WCDMA Band IV	Limit: 13dB
Mod.	RMC 12.2Kbps	RMC 12.2Kbps	RMC 12.2Kbps	Result
Lowest CH	3.24	3.52	3.32	<b>PASS</b>
Middle CH	3.84	3.36	3.48	
Highest CH	3.16	3.32	3.40	

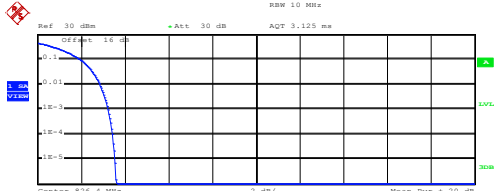
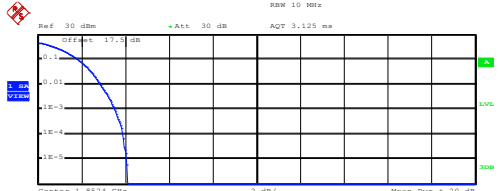
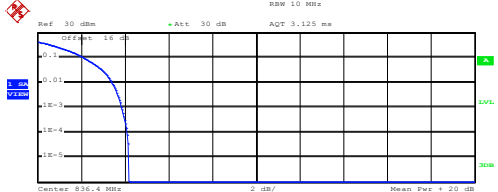
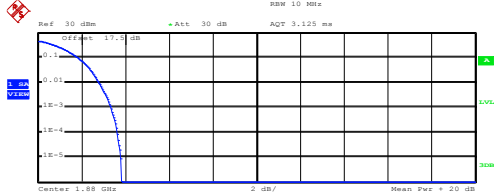
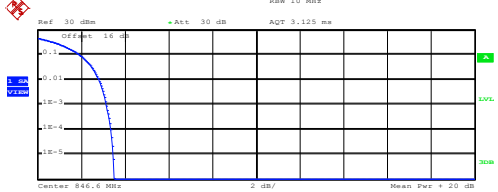
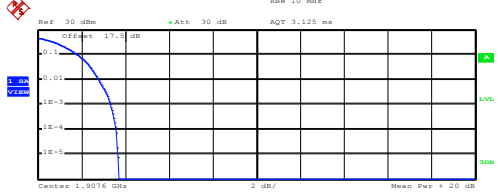

WCDMA Band V (RMC 12.2Kbps)	WCDMA Band II (RMC 12.2Kbps)
<p style="text-align: center;"><b>Lowest Channel</b></p>  <p>Center 826.4 MHz      2 dB/      Mean Pwr + 20 dB</p> <p>Complementary Cumulative Distribution Function (100000 samples)</p> <p>Trace 1</p> <p>Mean 16.70 dBm Peak 20.30 dBm Crest 3.60 dB</p> <p>10 % 1.96 dB 1 % 2.88 dB .1 % 3.24 dB .01 % 3.44 dB</p> <p>Date: 6.APR.2022 16:27:31</p>	<p style="text-align: center;"><b>Lowest Channel</b></p>  <p>Center 1.8524 GHz      2 dB/      Mean Pwr + 20 dB</p> <p>Complementary Cumulative Distribution Function (100000 samples)</p> <p>Trace 1</p> <p>Mean 22.07 dBm Peak 26.16 dBm Crest 4.09 dB</p> <p>10 % 1.84 dB 1 % 2.88 dB .1 % 3.52 dB .01 % 3.88 dB</p> <p>Date: 6.APR.2022 15:39:41</p>
<p style="text-align: center;"><b>Middle Channel</b></p>  <p>Center 836.6 MHz      2 dB/      Mean Pwr + 20 dB</p> <p>Complementary Cumulative Distribution Function (100000 samples)</p> <p>Trace 1</p> <p>Mean 15.91 dBm Peak 20.09 dBm Crest 4.18 dB</p> <p>10 % 2.16 dB 1 % 3.40 dB .1 % 3.84 dB .01 % 4.12 dB</p> <p>Date: 6.APR.2022 16:27:47</p>	<p style="text-align: center;"><b>Middle Channel</b></p>  <p>Center 1.88 GHz      2 dB/      Mean Pwr + 20 dB</p> <p>Complementary Cumulative Distribution Function (100000 samples)</p> <p>Trace 1</p> <p>Mean 22.05 dBm Peak 25.88 dBm Crest 3.82 dB</p> <p>10 % 1.84 dB 1 % 2.80 dB .1 % 3.36 dB .01 % 3.64 dB</p> <p>Date: 6.APR.2022 15:39:56</p>
<p style="text-align: center;"><b>Highest Channel</b></p>  <p>Center 846.8 MHz      2 dB/      Mean Pwr + 20 dB</p> <p>Complementary Cumulative Distribution Function (100000 samples)</p> <p>Trace 1</p> <p>Mean 16.36 dBm Peak 19.88 dBm Crest 3.52 dB</p> <p>10 % 1.96 dB 1 % 2.84 dB .1 % 3.16 dB .01 % 3.36 dB</p> <p>Date: 6.APR.2022 16:28:03</p>	<p style="text-align: center;"><b>Highest Channel</b></p>  <p>Center 1.9076 GHz      2 dB/      Mean Pwr + 20 dB</p> <p>Complementary Cumulative Distribution Function (100000 samples)</p> <p>Trace 1</p> <p>Mean 22.03 dBm Peak 25.74 dBm Crest 3.70 dB</p> <p>10 % 1.84 dB 1 % 2.80 dB .1 % 3.32 dB .01 % 3.60 dB</p> <p>Date: 6.APR.2022 15:40:14</p>

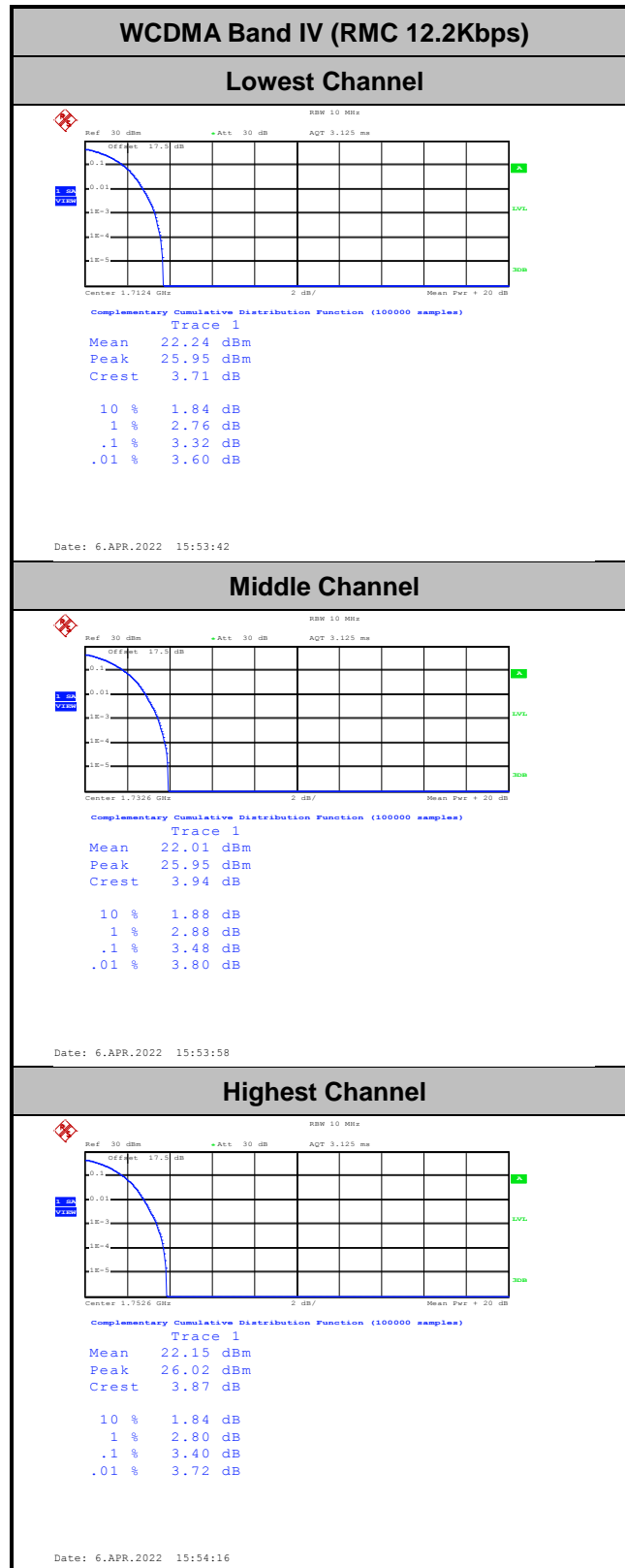



**26dB Bandwidth**

Mode	WCDMA Band V: 26dB BW(MHz)	WCDMA Band II: 26dB BW(MHz)	WCDMA Band IV: 26dB BW(MHz)
Mod.	RMC 12.2Kbps	RMC 12.2Kbps	RMC 12.2Kbps
Lowest CH	4.74	4.74	4.74
Middle CH	4.75	4.76	4.73
Highest CH	4.73	4.75	4.74



WCDMA Band V (RMC 12.2Kbps)

WCDMA Band II (RMC 12.2Kbps)

Lowest Channel

Lowest Channel

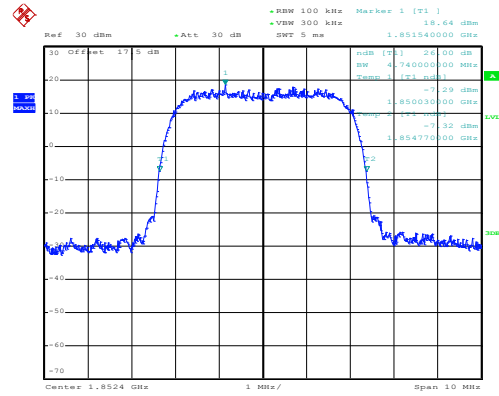
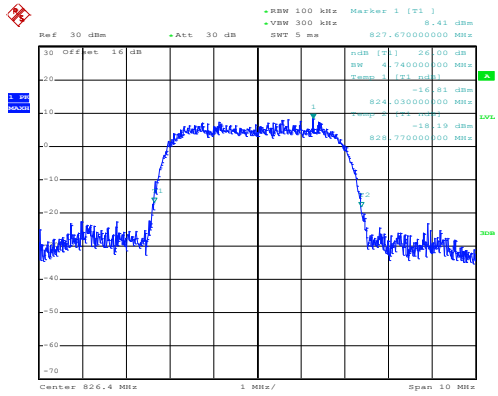

Date: 6.APR.2022 16:13:47

Date: 6.APR.2022 15:27:13

Middle Channel

Middle Channel

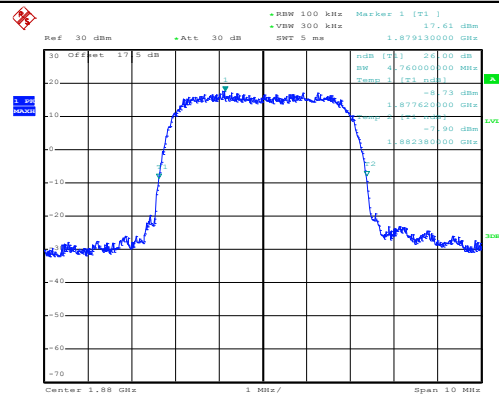
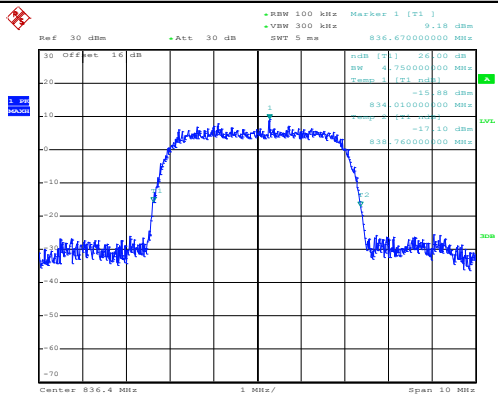

Date: 6.APR.2022 16:14:24

Date: 6.APR.2022 15:27:49

Highest Channel

Highest Channel

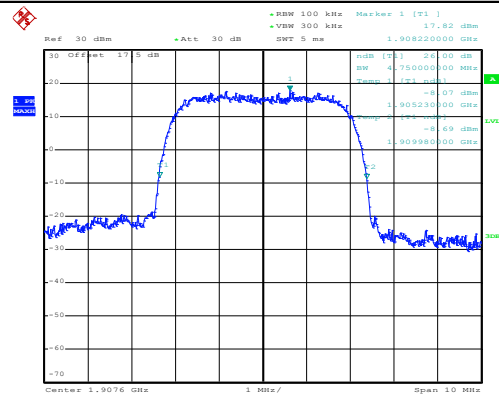
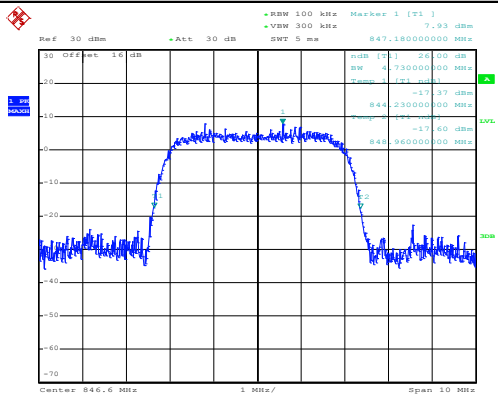

Date: 6.APR.2022 16:14:59

Date: 6.APR.2022 15:28:26



### WCDMA Band IV (RMC 12.2Kbps)

#### Lowest Channel

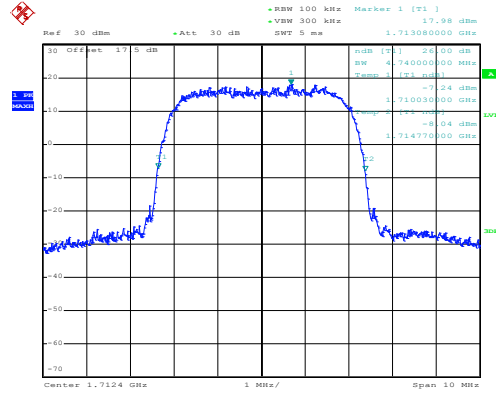

Date: 6.APR.2022 15:41:18

#### Middle Channel

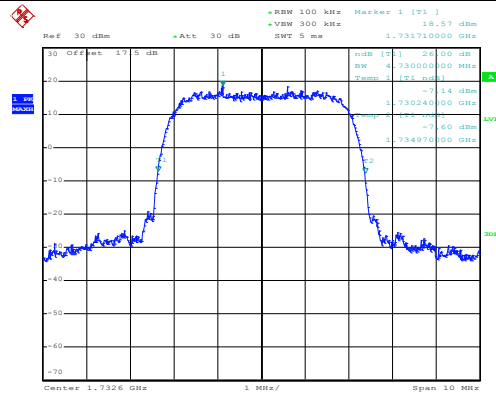

Date: 6.APR.2022 15:41:53

#### Highest Channel

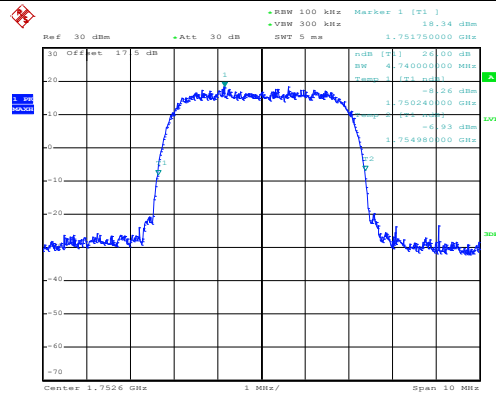

Date: 6.APR.2022 15:42:29





### Occupied Bandwidth

Mode	WCDMA Band V: 99% OBW(MHz)	WCDMA Band II: 99% OBW(MHz)	WCDMA Band IV: 99% OBW(MHz)
Mod.	RMC 12.2Kbps	RMC 12.2Kbps	RMC 12.2Kbps
Lowest CH	4.18	4.18	4.18
Middle CH	4.21	4.18	4.16
Highest CH	4.19	4.17	4.17



WCDMA Band V (RMC 12.2Kbps)	WCDMA Band II (RMC 12.2Kbps)
<p style="text-align: center;"><b>Lowest Channel</b></p> <p style="text-align: right;">Date: 6.APR.2022 16:19:31</p>	<p style="text-align: center;"><b>Lowest Channel</b></p> <p style="text-align: right;">Date: 6.APR.2022 15:31:59</p>
<p style="text-align: center;"><b>Middle Channel</b></p> <p style="text-align: right;">Date: 6.APR.2022 16:20:08</p>	<p style="text-align: center;"><b>Middle Channel</b></p> <p style="text-align: right;">Date: 6.APR.2022 15:32:36</p>
<p style="text-align: center;"><b>Highest Channel</b></p> <p style="text-align: right;">Date: 6.APR.2022 16:20:43</p>	<p style="text-align: center;"><b>Highest Channel</b></p> <p style="text-align: right;">Date: 6.APR.2022 15:33:12</p>



### WCDMA Band IV (RMC 12.2Kbps)

#### Lowest Channel

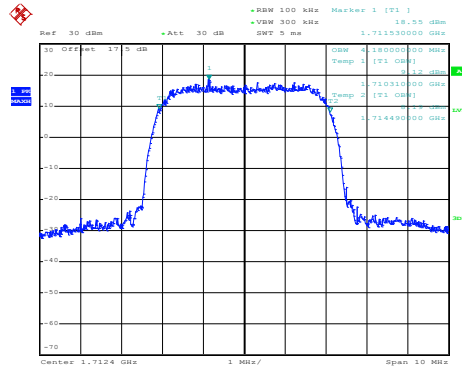

Date: 6.APR.2022 15:46:03

#### Middle Channel

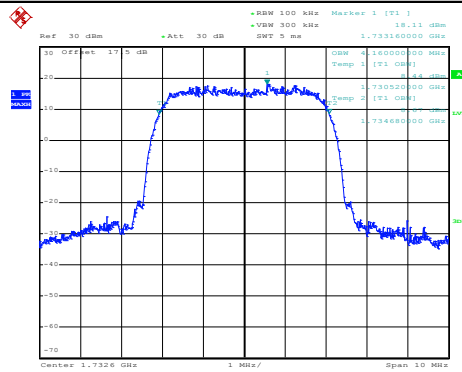

Date: 6.APR.2022 15:46:40

#### Highest Channel

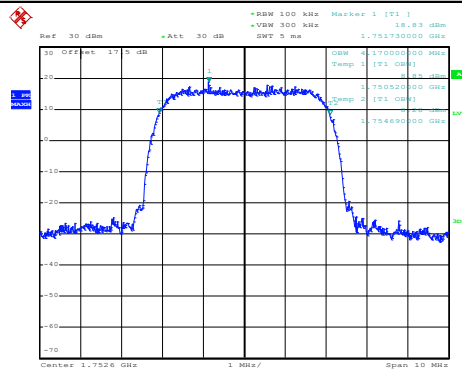

Date: 6.APR.2022 15:47:16



# Conducted Band Edge

## WCDMA Band V (RMC 12.2Kbps)

### Lowest Band Edge

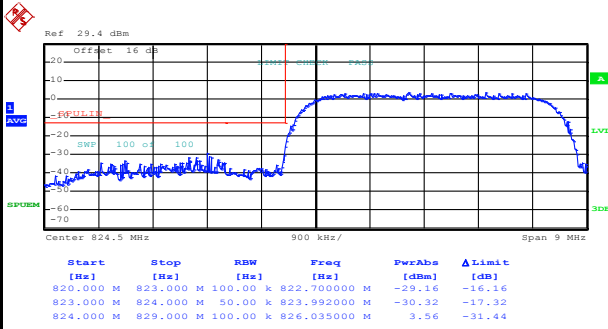

Date: 6.APR.2022 16:23:59

### Highest Band Edge

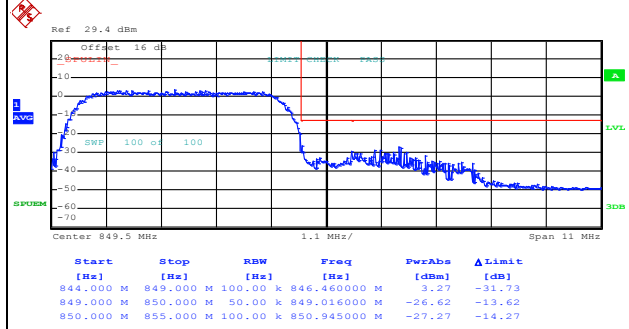

Date: 6.APR.2022 16:26:53

## WCDMA Band II (RMC 12.2Kbps)

### Lowest Band Edge

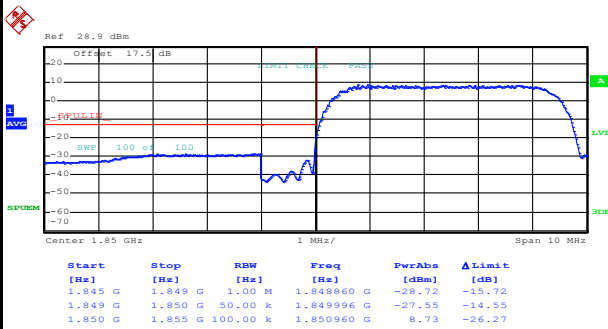

Date: 6.APR.2022 15:36:12

### Highest Band Edge

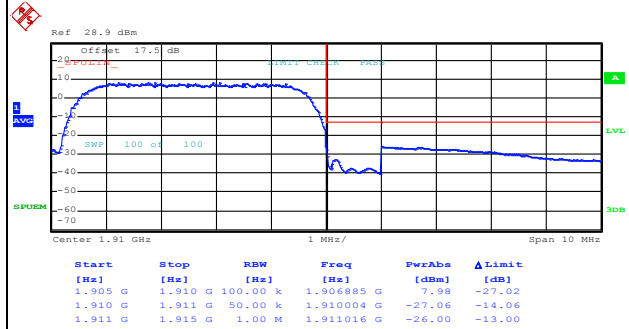

Date: 6.APR.2022 15:39:03



WCDMA Band IV (RMC 12.2Kbps)

Lowest Band Edge

Highest Band Edge

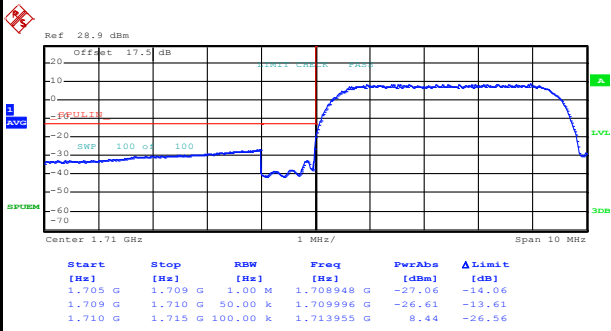

Date: 6.APR.2022 15:50:13

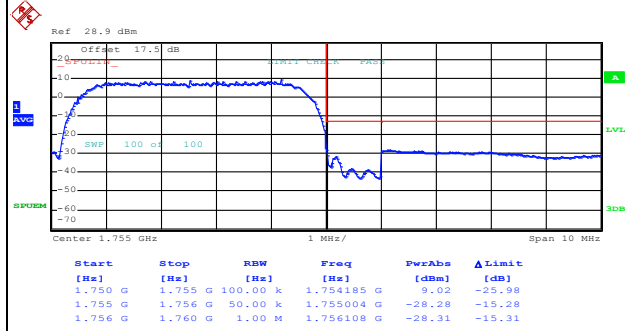

Date: 6.APR.2022 15:53:07

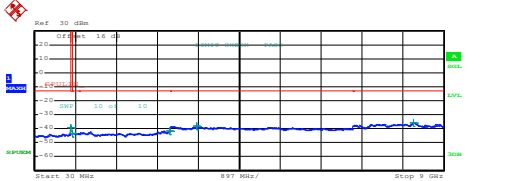
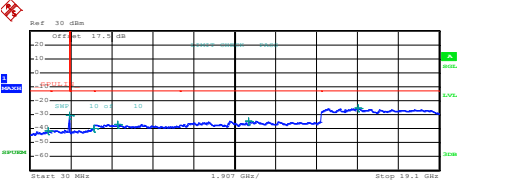
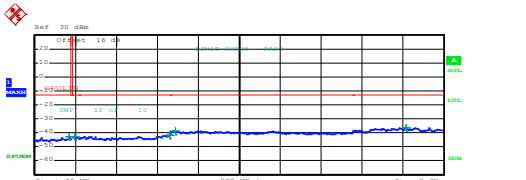
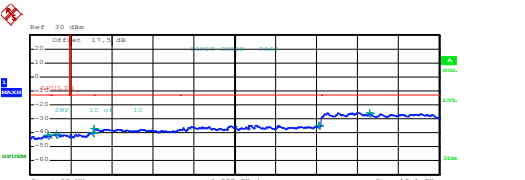
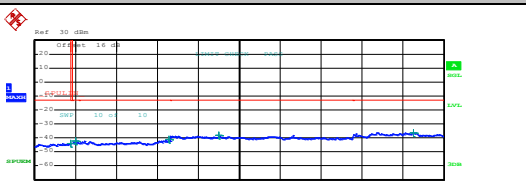
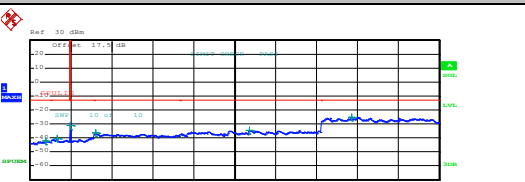

# Conducted Spurious Emission

WCDMA Band V (RMC 12.2Kbps)	WCDMA Band II (RMC 12.2Kbps)																																																																																										
Lowest Channel	Lowest Channel																																																																																										
 <table border="1" data-bbox="239 660 702 739"> <thead> <tr> <th>Start</th> <th>Stop</th> <th>RBW</th> <th>Freq</th> <th>PwrAve</th> <th>ΔLimit</th> </tr> <tr> <th>[Hz]</th> <th>[Hz]</th> <th>[Hz]</th> <th>[Hz]</th> <th>[dBm]</th> <th>[dB]</th> </tr> </thead> <tbody> <tr> <td>30,000 M</td> <td>820,000 M</td> <td>1,000 M</td> <td>816,000000 M</td> <td>-39.34</td> <td>-26.34</td> </tr> <tr> <td>855,000 M</td> <td>1,000 G</td> <td>1,000 M</td> <td>856,993750 M</td> <td>-43.18</td> <td>-30.18</td> </tr> <tr> <td>1,000 G</td> <td>3,000 G</td> <td>1,000 M</td> <td>2,992500 G</td> <td>-42.40</td> <td>-28.40</td> </tr> <tr> <td>3,000 G</td> <td>7,000 G</td> <td>1,000 M</td> <td>3,590000 G</td> <td>-38.33</td> <td>-25.33</td> </tr> <tr> <td>7,000 G</td> <td>9,000 G</td> <td>1,000 M</td> <td>8,344500 G</td> <td>-35.96</td> <td>-22.96</td> </tr> </tbody> </table> <p>Date: 6.APR.2022 16:16:26</p>	Start	Stop	RBW	Freq	PwrAve	ΔLimit	[Hz]	[Hz]	[Hz]	[Hz]	[dBm]	[dB]	30,000 M	820,000 M	1,000 M	816,000000 M	-39.34	-26.34	855,000 M	1,000 G	1,000 M	856,993750 M	-43.18	-30.18	1,000 G	3,000 G	1,000 M	2,992500 G	-42.40	-28.40	3,000 G	7,000 G	1,000 M	3,590000 G	-38.33	-25.33	7,000 G	9,000 G	1,000 M	8,344500 G	-35.96	-22.96	 <table border="1" data-bbox="893 660 1356 739"> <thead> <tr> <th>Start</th> <th>Stop</th> <th>RBW</th> <th>Freq</th> <th>PwrAve</th> <th>ΔLimit</th> </tr> <tr> <th>[Hz]</th> <th>[Hz]</th> <th>[Hz]</th> <th>[Hz]</th> <th>[dBm]</th> <th>[dB]</th> </tr> </thead> <tbody> <tr> <td>30,000 M</td> <td>1,000 G</td> <td>1,000 M</td> <td>854,743500 M</td> <td>-41.82</td> <td>-28.82</td> </tr> <tr> <td>1,000 G</td> <td>3,845 G</td> <td>1,000 M</td> <td>1,844789 G</td> <td>-30.80</td> <td>-17.80</td> </tr> <tr> <td>1,915 G</td> <td>3,000 G</td> <td>1,000 M</td> <td>2,999925 G</td> <td>-39.90</td> <td>-26.90</td> </tr> <tr> <td>3,000 G</td> <td>7,000 G</td> <td>1,000 M</td> <td>4,096000 G</td> <td>-37.24</td> <td>-24.24</td> </tr> <tr> <td>7,000 G</td> <td>13,600 G</td> <td>1,000 M</td> <td>10,223275 G</td> <td>-34.67</td> <td>-21.67</td> </tr> <tr> <td>13,600 G</td> <td>19,100 G</td> <td>1,000 M</td> <td>15,337312 G</td> <td>-25.00</td> <td>-12.00</td> </tr> </tbody> </table> <p>Date: 6.APR.2022 15:29:30</p>	Start	Stop	RBW	Freq	PwrAve	ΔLimit	[Hz]	[Hz]	[Hz]	[Hz]	[dBm]	[dB]	30,000 M	1,000 G	1,000 M	854,743500 M	-41.82	-28.82	1,000 G	3,845 G	1,000 M	1,844789 G	-30.80	-17.80	1,915 G	3,000 G	1,000 M	2,999925 G	-39.90	-26.90	3,000 G	7,000 G	1,000 M	4,096000 G	-37.24	-24.24	7,000 G	13,600 G	1,000 M	10,223275 G	-34.67	-21.67	13,600 G	19,100 G	1,000 M	15,337312 G	-25.00	-12.00
Start	Stop	RBW	Freq	PwrAve	ΔLimit																																																																																						
[Hz]	[Hz]	[Hz]	[Hz]	[dBm]	[dB]																																																																																						
30,000 M	820,000 M	1,000 M	816,000000 M	-39.34	-26.34																																																																																						
855,000 M	1,000 G	1,000 M	856,993750 M	-43.18	-30.18																																																																																						
1,000 G	3,000 G	1,000 M	2,992500 G	-42.40	-28.40																																																																																						
3,000 G	7,000 G	1,000 M	3,590000 G	-38.33	-25.33																																																																																						
7,000 G	9,000 G	1,000 M	8,344500 G	-35.96	-22.96																																																																																						
Start	Stop	RBW	Freq	PwrAve	ΔLimit																																																																																						
[Hz]	[Hz]	[Hz]	[Hz]	[dBm]	[dB]																																																																																						
30,000 M	1,000 G	1,000 M	854,743500 M	-41.82	-28.82																																																																																						
1,000 G	3,845 G	1,000 M	1,844789 G	-30.80	-17.80																																																																																						
1,915 G	3,000 G	1,000 M	2,999925 G	-39.90	-26.90																																																																																						
3,000 G	7,000 G	1,000 M	4,096000 G	-37.24	-24.24																																																																																						
7,000 G	13,600 G	1,000 M	10,223275 G	-34.67	-21.67																																																																																						
13,600 G	19,100 G	1,000 M	15,337312 G	-25.00	-12.00																																																																																						
Middle Channel	Middle Channel																																																																																										
 <table border="1" data-bbox="239 1176 702 1254"> <thead> <tr> <th>Start</th> <th>Stop</th> <th>RBW</th> <th>Freq</th> <th>PwrAve</th> <th>ΔLimit</th> </tr> <tr> <th>[Hz]</th> <th>[Hz]</th> <th>[Hz]</th> <th>[Hz]</th> <th>[dBm]</th> <th>[dB]</th> </tr> </thead> <tbody> <tr> <td>30,000 M</td> <td>820,000 M</td> <td>1,000 M</td> <td>789,285000 M</td> <td>-42.86</td> <td>-29.86</td> </tr> <tr> <td>855,000 M</td> <td>1,000 G</td> <td>1,000 M</td> <td>904,237000 M</td> <td>-43.05</td> <td>-30.05</td> </tr> <tr> <td>1,000 G</td> <td>3,000 G</td> <td>1,000 M</td> <td>2,993500 G</td> <td>-41.62</td> <td>-28.62</td> </tr> <tr> <td>3,000 G</td> <td>7,000 G</td> <td>1,000 M</td> <td>3,115000 G</td> <td>-38.43</td> <td>-25.43</td> </tr> <tr> <td>7,000 G</td> <td>9,000 G</td> <td>1,000 M</td> <td>8,177500 G</td> <td>-36.18</td> <td>-23.18</td> </tr> </tbody> </table> <p>Date: 6.APR.2022 16:17:36</p>	Start	Stop	RBW	Freq	PwrAve	ΔLimit	[Hz]	[Hz]	[Hz]	[Hz]	[dBm]	[dB]	30,000 M	820,000 M	1,000 M	789,285000 M	-42.86	-29.86	855,000 M	1,000 G	1,000 M	904,237000 M	-43.05	-30.05	1,000 G	3,000 G	1,000 M	2,993500 G	-41.62	-28.62	3,000 G	7,000 G	1,000 M	3,115000 G	-38.43	-25.43	7,000 G	9,000 G	1,000 M	8,177500 G	-36.18	-23.18	 <table border="1" data-bbox="893 1176 1356 1254"> <thead> <tr> <th>Start</th> <th>Stop</th> <th>RBW</th> <th>Freq</th> <th>PwrAve</th> <th>ΔLimit</th> </tr> <tr> <th>[Hz]</th> <th>[Hz]</th> <th>[Hz]</th> <th>[Hz]</th> <th>[dBm]</th> <th>[dB]</th> </tr> </thead> <tbody> <tr> <td>30,000 M</td> <td>1,000 G</td> <td>1,000 M</td> <td>850,377500 M</td> <td>-41.68</td> <td>-28.68</td> </tr> <tr> <td>1,000 G</td> <td>3,845 G</td> <td>1,000 M</td> <td>3,228993 G</td> <td>-40.89</td> <td>-27.89</td> </tr> <tr> <td>1,915 G</td> <td>3,000 G</td> <td>1,000 M</td> <td>2,998499 G</td> <td>-39.87</td> <td>-26.87</td> </tr> <tr> <td>3,000 G</td> <td>7,000 G</td> <td>1,000 M</td> <td>3,006000 G</td> <td>-37.19</td> <td>-24.19</td> </tr> <tr> <td>7,000 G</td> <td>13,600 G</td> <td>1,000 M</td> <td>10,231750 G</td> <td>-34.58</td> <td>-21.58</td> </tr> <tr> <td>13,600 G</td> <td>19,100 G</td> <td>1,000 M</td> <td>15,361188 G</td> <td>-25.58</td> <td>-12.58</td> </tr> </tbody> </table> <p>Date: 6.APR.2022 15:30:24</p>	Start	Stop	RBW	Freq	PwrAve	ΔLimit	[Hz]	[Hz]	[Hz]	[Hz]	[dBm]	[dB]	30,000 M	1,000 G	1,000 M	850,377500 M	-41.68	-28.68	1,000 G	3,845 G	1,000 M	3,228993 G	-40.89	-27.89	1,915 G	3,000 G	1,000 M	2,998499 G	-39.87	-26.87	3,000 G	7,000 G	1,000 M	3,006000 G	-37.19	-24.19	7,000 G	13,600 G	1,000 M	10,231750 G	-34.58	-21.58	13,600 G	19,100 G	1,000 M	15,361188 G	-25.58	-12.58
Start	Stop	RBW	Freq	PwrAve	ΔLimit																																																																																						
[Hz]	[Hz]	[Hz]	[Hz]	[dBm]	[dB]																																																																																						
30,000 M	820,000 M	1,000 M	789,285000 M	-42.86	-29.86																																																																																						
855,000 M	1,000 G	1,000 M	904,237000 M	-43.05	-30.05																																																																																						
1,000 G	3,000 G	1,000 M	2,993500 G	-41.62	-28.62																																																																																						
3,000 G	7,000 G	1,000 M	3,115000 G	-38.43	-25.43																																																																																						
7,000 G	9,000 G	1,000 M	8,177500 G	-36.18	-23.18																																																																																						
Start	Stop	RBW	Freq	PwrAve	ΔLimit																																																																																						
[Hz]	[Hz]	[Hz]	[Hz]	[dBm]	[dB]																																																																																						
30,000 M	1,000 G	1,000 M	850,377500 M	-41.68	-28.68																																																																																						
1,000 G	3,845 G	1,000 M	3,228993 G	-40.89	-27.89																																																																																						
1,915 G	3,000 G	1,000 M	2,998499 G	-39.87	-26.87																																																																																						
3,000 G	7,000 G	1,000 M	3,006000 G	-37.19	-24.19																																																																																						
7,000 G	13,600 G	1,000 M	10,231750 G	-34.58	-21.58																																																																																						
13,600 G	19,100 G	1,000 M	15,361188 G	-25.58	-12.58																																																																																						
Highest Channel	Highest Channel																																																																																										
 <table border="1" data-bbox="239 1691 702 1769"> <thead> <tr> <th>Start</th> <th>Stop</th> <th>RBW</th> <th>Freq</th> <th>PwrAve</th> <th>ΔLimit</th> </tr> <tr> <th>[Hz]</th> <th>[Hz]</th> <th>[Hz]</th> <th>[Hz]</th> <th>[dBm]</th> <th>[dB]</th> </tr> </thead> <tbody> <tr> <td>30,000 M</td> <td>820,000 M</td> <td>1,000 M</td> <td>812,435000 M</td> <td>-43.84</td> <td>-30.84</td> </tr> <tr> <td>855,000 M</td> <td>1,000 G</td> <td>1,000 M</td> <td>922,678750 M</td> <td>-42.42</td> <td>-29.42</td> </tr> <tr> <td>1,000 G</td> <td>3,000 G</td> <td>1,000 M</td> <td>2,972000 G</td> <td>-40.97</td> <td>-27.97</td> </tr> <tr> <td>3,000 G</td> <td>7,000 G</td> <td>1,000 M</td> <td>4,068000 G</td> <td>-38.28</td> <td>-25.28</td> </tr> <tr> <td>7,000 G</td> <td>9,000 G</td> <td>1,000 M</td> <td>8,330000 G</td> <td>-36.10</td> <td>-23.10</td> </tr> </tbody> </table> <p>Date: 6.APR.2022 16:18:50</p>	Start	Stop	RBW	Freq	PwrAve	ΔLimit	[Hz]	[Hz]	[Hz]	[Hz]	[dBm]	[dB]	30,000 M	820,000 M	1,000 M	812,435000 M	-43.84	-30.84	855,000 M	1,000 G	1,000 M	922,678750 M	-42.42	-29.42	1,000 G	3,000 G	1,000 M	2,972000 G	-40.97	-27.97	3,000 G	7,000 G	1,000 M	4,068000 G	-38.28	-25.28	7,000 G	9,000 G	1,000 M	8,330000 G	-36.10	-23.10	 <table border="1" data-bbox="893 1691 1356 1769"> <thead> <tr> <th>Start</th> <th>Stop</th> <th>RBW</th> <th>Freq</th> <th>PwrAve</th> <th>ΔLimit</th> </tr> <tr> <th>[Hz]</th> <th>[Hz]</th> <th>[Hz]</th> <th>[Hz]</th> <th>[dBm]</th> <th>[dB]</th> </tr> </thead> <tbody> <tr> <td>30,000 M</td> <td>1,000 G</td> <td>1,000 M</td> <td>767,662500 M</td> <td>-41.96</td> <td>-28.96</td> </tr> <tr> <td>1,000 G</td> <td>3,845 G</td> <td>1,000 M</td> <td>1,276949 G</td> <td>-40.45</td> <td>-27.45</td> </tr> <tr> <td>1,915 G</td> <td>3,000 G</td> <td>1,000 M</td> <td>2,993542 G</td> <td>-31.23</td> <td>-18.23</td> </tr> <tr> <td>3,000 G</td> <td>7,000 G</td> <td>1,000 M</td> <td>3,072000 G</td> <td>-36.38</td> <td>-23.38</td> </tr> <tr> <td>7,000 G</td> <td>13,600 G</td> <td>1,000 M</td> <td>10,243990 G</td> <td>-34.75</td> <td>-21.75</td> </tr> <tr> <td>13,600 G</td> <td>19,100 G</td> <td>1,000 M</td> <td>15,007312 G</td> <td>-25.32</td> <td>-12.32</td> </tr> </tbody> </table> <p>Date: 6.APR.2022 15:31:19</p>	Start	Stop	RBW	Freq	PwrAve	ΔLimit	[Hz]	[Hz]	[Hz]	[Hz]	[dBm]	[dB]	30,000 M	1,000 G	1,000 M	767,662500 M	-41.96	-28.96	1,000 G	3,845 G	1,000 M	1,276949 G	-40.45	-27.45	1,915 G	3,000 G	1,000 M	2,993542 G	-31.23	-18.23	3,000 G	7,000 G	1,000 M	3,072000 G	-36.38	-23.38	7,000 G	13,600 G	1,000 M	10,243990 G	-34.75	-21.75	13,600 G	19,100 G	1,000 M	15,007312 G	-25.32	-12.32
Start	Stop	RBW	Freq	PwrAve	ΔLimit																																																																																						
[Hz]	[Hz]	[Hz]	[Hz]	[dBm]	[dB]																																																																																						
30,000 M	820,000 M	1,000 M	812,435000 M	-43.84	-30.84																																																																																						
855,000 M	1,000 G	1,000 M	922,678750 M	-42.42	-29.42																																																																																						
1,000 G	3,000 G	1,000 M	2,972000 G	-40.97	-27.97																																																																																						
3,000 G	7,000 G	1,000 M	4,068000 G	-38.28	-25.28																																																																																						
7,000 G	9,000 G	1,000 M	8,330000 G	-36.10	-23.10																																																																																						
Start	Stop	RBW	Freq	PwrAve	ΔLimit																																																																																						
[Hz]	[Hz]	[Hz]	[Hz]	[dBm]	[dB]																																																																																						
30,000 M	1,000 G	1,000 M	767,662500 M	-41.96	-28.96																																																																																						
1,000 G	3,845 G	1,000 M	1,276949 G	-40.45	-27.45																																																																																						
1,915 G	3,000 G	1,000 M	2,993542 G	-31.23	-18.23																																																																																						
3,000 G	7,000 G	1,000 M	3,072000 G	-36.38	-23.38																																																																																						
7,000 G	13,600 G	1,000 M	10,243990 G	-34.75	-21.75																																																																																						
13,600 G	19,100 G	1,000 M	15,007312 G	-25.32	-12.32																																																																																						



WCDMA Band IV (RMC 12.2Kbps)

Lowest Channel

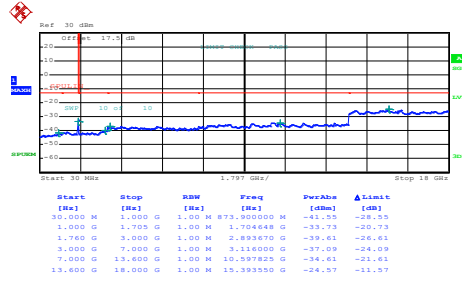

Date: 6.APR.2022 15:43:30

Middle Channel

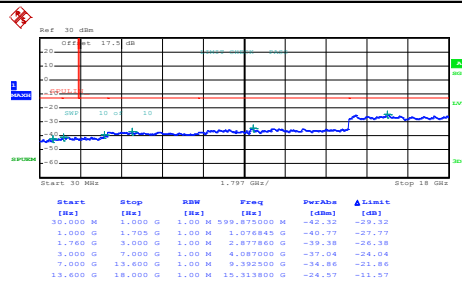

Date: 6.APR.2022 15:44:23

Highest Channel

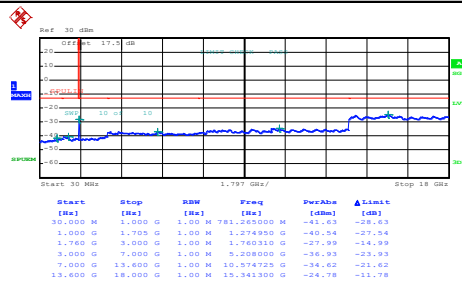

Date: 6.APR.2022 15:45:17



**Frequency Stability**

Test Conditions	Middle Channel	WCDMA Band V (RMC 12.2Kbps)	Limit 2.5ppm
Temperature (°C)	Voltage (Volt)	Deviation (ppm)	Result
50	Normal Voltage	0.0012	PASS
40	Normal Voltage	0.0012	
30	Normal Voltage	0.0000	
20(Ref.)	Normal Voltage	0.0000	
10	Normal Voltage	0.0012	
0	Normal Voltage	0.0024	
-10	Normal Voltage	0.0012	
-20	Normal Voltage	0.0036	
-30	Normal Voltage	0.0048	
20	Maximum Voltage	0.0012	
20	Normal Voltage	0.0000	
20	Battery End Point	0.0024	

**Note:**

- 1. Normal Voltage = 3.85V. ; Battery End Point (BEP) = 3.4 V. ; Maximum Voltage =4.3 V
- 2. The frequency fundamental emissions stay within the authorized frequency block.





Test Conditions	Middle Channel	WCDMA Band II (RMC 12.2Kbps)	Limit Note 2.
Temperature (°C)	Voltage (Volt)	Deviation (ppm)	Result
50	Normal Voltage	0.0027	PASS
40	Normal Voltage	0.0016	
30	Normal Voltage	0.0005	
20(Ref.)	Normal Voltage	0.0000	
10	Normal Voltage	0.0011	
0	Normal Voltage	0.0016	
-10	Normal Voltage	0.0027	
-20	Normal Voltage	0.0037	
-30	Normal Voltage	0.0043	
20	Maximum Voltage	0.0005	
20	Normal Voltage	0.0000	
20	Battery End Point	0.0000	

**Note:**

- 1. Normal Voltage = 3.85V. ; Battery End Point (BEP) = 3.4 V. ; Maximum Voltage =4.3 V
- 2. The frequency fundamental emissions stay within the authorized frequency block.



Test Conditions	Middle Channel	WCDMA Band IV (RMC 12.2Kbps)	Limit Note 2.
Temperature (°C)	Voltage (Volt)	Deviation (ppm)	Result
50	Normal Voltage	0.0006	PASS
40	Normal Voltage	0.0000	
30	Normal Voltage	0.0006	
20(Ref.)	Normal Voltage	0.0000	
10	Normal Voltage	0.0006	
0	Normal Voltage	0.0012	
-10	Normal Voltage	0.0006	
-20	Normal Voltage	0.0000	
-30	Normal Voltage	0.0012	
20	Maximum Voltage	0.0017	
20	Normal Voltage	0.0006	
20	Battery End Point	0.0000	

**Note:**

- 1. Normal Voltage = 3.85V. ; Battery End Point (BEP) = 3.4 V. ; Maximum Voltage =4.3 V
- 2. The frequency fundamental emissions stay within the authorized frequency block.



### Appendix B. Test Results of Radiated Test

<Primary Antenna>

<Ant. 0>

### EDGE 850

EDGE 850									
Channel	Frequency ( MHz )	ERP ( dBm )	Limit ( dBm )	Margin ( dB )	SPA Reading (dBm)	S.G. Power ( dBm )	TX Cable loss ( dB )	TX Antenna Gain (dBi)	Polarization (H/V)
Lowest	1648	-63.91	-13	-50.91	-70.51	-69.21	1.83	9.28	H
	2472	-48.14	-13	-35.14	-58.81	-54.37	2.25	10.63	H
	3296	-60.88	-13	-47.88	-73.49	-68.39	2.62	12.28	H
									H
									H
									H
	1648	-64.18	-13	-51.18	-71.24	-69.48	1.83	9.28	V
	2472	-48.77	-13	-35.77	-59.67	-55.00	2.25	10.63	V
	3296	-60.78	-13	-47.78	-73.8	-68.29	2.62	12.28	V
									V
									V
									V
Middle	1672	-61.39	-13	-48.39	-68.13	-66.82	1.85	9.43	H
	2512	-50.67	-13	-37.67	-61.49	-57.05	2.27	10.80	H
	3345	-61.66	-13	-48.66	-74.12	-69.52	2.65	12.66	H
									H
									H
									H
	1672	-61.78	-13	-48.78	-68.99	-67.21	1.85	9.43	V
	2512	-50.06	-13	-37.06	-61	-56.44	2.27	10.80	V
	3345	-61.11	-13	-48.11	-73.96	-68.97	2.65	12.66	V
									V
									V
									V



Highest	1696	-63.74	-13	-50.74	-70.63	-69.31	1.86	9.58	H
	2544	-42.66	-13	-29.66	-53.35	-49.03	2.28	10.80	H
	3395	-61.95	-13	-48.95	-74.26	-69.74	2.67	12.61	H
									H
									H
									H
	1696	-64.58	-13	-51.58	-71.95	-70.15	1.86	9.58	V
	2544	-44.36	-13	-31.36	-55.37	-50.73	2.28	10.80	V
	3395	-61.39	-13	-48.39	-74.08	-69.18	2.67	12.61	V
									V
									V
									V

Remark: Spurious emissions within 30-1000MHz were found more than 20dB below limit line.



**GPRS 850**

GPRS 850									
Channel	Frequency ( MHz )	ERP ( dBm )	Limit ( dBm )	Margin ( dB )	SPA Reading (dBm)	S.G. Power ( dBm )	TX Cable loss ( dB )	TX Antenna Gain (dBi)	Polarization (H/V)
Lowest	1648	-61.45	-13	-48.45	-68.05	-66.75	1.83	9.28	H
	2472	-47.00	-13	-34.00	-57.67	-53.23	2.25	10.63	H
	3296	-61.00	-13	-48.00	-73.61	-68.51	2.62	12.28	H
									H
									H
									H
									H
	1648	-64.01	-13	-51.01	-71.07	-69.31	1.83	9.28	V
	2472	-49.41	-13	-36.41	-60.31	-55.64	2.25	10.63	V
	3296	-60.89	-13	-47.89	-73.91	-68.40	2.62	12.28	V
									V
									V
									V
									V
Middle	1672	-59.26	-13	-46.26	-66	-64.69	1.85	9.43	H
	2512	-46.76	-13	-33.76	-57.58	-53.14	2.27	10.80	H
	3345	-61.60	-13	-48.60	-74.06	-69.46	2.65	12.66	H
									H
									H
									H
									H
	1672	-59.47	-13	-46.47	-66.68	-64.90	1.85	9.43	V
	2512	-45.44	-13	-32.44	-56.38	-51.82	2.27	10.80	V
	3345	-61.39	-13	-48.39	-74.24	-69.25	2.65	12.66	V
									V
									V
									V
									V



Highest	1696	-60.28	-13	-47.28	-67.17	-65.85	1.86	9.58	H
	2544	-39.13	-13	-26.13	-49.82	-45.50	2.28	10.80	H
	3395	-62.09	-13	-49.09	-74.4	-69.88	2.67	12.61	H
									H
									H
									H
									H
	1696	-59.76	-13	-46.76	-67.13	-65.33	1.86	9.58	V
	2544	-37.68	-13	-24.68	-48.69	-44.05	2.28	10.80	V
	3395	-61.65	-13	-48.65	-74.34	-69.44	2.67	12.61	V
									V
									V
									V
									V

Remark: Spurious emissions within 30-1000MHz were found more than 20dB below limit line.



### WCDMA Band V

WCDMA Band V										
Channel	Frequency ( MHz )	ERP ( dBm )	Limit ( dBm )	Margin ( dB )	SPA Reading (dBm)	S.G. Power ( dBm )	TX Cable loss ( dB )	TX Antenna Gain (dBi)	Polarization (H/V)	
Lowest	1648	-62.40	-13	-49.40	-69	-67.70	1.83	9.28	H	
	2472	-56.45	-13	-43.45	-67.12	-62.68	2.25	10.63	H	
	3305	-61.31	-13	-48.31	-73.89	-68.87	2.63	12.34	H	
										H
										H
										H
										H
	1648	-63.12	-13	-50.12	-70.18	-68.42	1.83	9.28	V	
	2480	-56.59	-13	-43.59	-67.49	-62.87	2.25	10.68	V	
	3305	-60.53	-13	-47.53	-73.51	-68.09	2.63	12.34	V	
										V
										V
										V
										V
Middle	1672	-63.44	-13	-50.44	-70.18	-68.87	1.85	9.43	H	
	2512	-55.73	-13	-42.73	-66.55	-62.11	2.27	10.80	H	
	3345	-61.82	-13	-48.82	-74.28	-69.68	2.65	12.66	H	
										H
										H
										H
										H
	1672	-64.55	-13	-51.55	-71.76	-69.98	1.85	9.43	V	
	2512	-57.87	-13	-44.87	-68.81	-64.25	2.27	10.80	V	
	3345	-61.09	-13	-48.09	-73.94	-68.95	2.65	12.66	V	
										V
										V
										V
										V



Highest	1696	-65.27	-13	-52.27	-72.16	-70.84	1.86	9.58	H
	2536	-59.07	-13	-46.07	-69.8	-65.44	2.28	10.80	H
	3386	-61.74	-13	-48.74	-74.08	-69.55	2.67	12.63	H
									H
									H
									H
									H
	1696	-64.76	-13	-51.76	-72.13	-70.33	1.86	9.58	V
	2539	-61.13	-13	-48.13	-72.13	-67.50	2.28	10.80	V
	3386	-61.17	-13	-48.17	-73.88	-68.98	2.67	12.63	V
									V
									V
									V
									V

Remark: Spurious emissions within 30-1000MHz were found more than 20dB below limit line.





<Ant. 2>

**EDGE 1900**

EDGE 1900									
Channel	Frequency ( MHz )	EIRP ( dBm )	Limit ( dBm )	Margin ( dB )	SPA Reading (dBm)	S.G. Power ( dBm )	TX Cable loss ( dB )	TX Antenna Gain (dBi)	Polarization (H/V)
Lowest	3700	-56.04	-13	-43.04	-70.45	-65.67	2.77	12.40	H
	5548	-43.49	-13	-30.49	-61.86	-53.42	3.46	13.39	H
	7400	-51.97	-13	-38.97	-75.73	-59.19	3.98	11.20	H
									H
									H
									H
									H
	3700	-53.66	-13	-40.66	-68.48	-63.29	2.77	12.40	V
	5548	-35.44	-13	-22.44	-53.86	-45.37	3.46	13.39	V
	7400	-51.52	-13	-38.52	-75.76	-58.74	3.98	11.20	V
									V
									V
									V
									V
Middle	3756	-56.14	-13	-43.14	-70.72	-65.85	2.78	12.49	H
	5639	-45.59	-13	-32.59	-63.98	-55.56	3.48	13.46	H
	7520	-52.25	-13	-39.25	-75.95	-59.44	4.01	11.20	H
									H
									H
									H
									H
	3756	-54.94	-13	-41.94	-69.92	-64.65	2.78	12.49	V
	5639	-37.19	-13	-24.19	-55.8	-47.16	3.48	13.46	V
	7520	-51.95	-13	-38.95	-76.04	-59.14	4.01	11.20	V
									V
									V
									V
									V



Highest	3819	-56.43	-13	-43.43	-71.12	-66.00	2.80	12.36	H
	5730	-43.00	-13	-30.00	-61.9	-52.89	3.51	13.40	H
	7639	-52.38	-13	-39.38	-75.72	-59.81	4.05	11.48	H
									H
									H
									H
									H
	3819	-53.65	-13	-40.65	-68.73	-63.22	2.80	12.36	V
	5730	-38.23	-13	-25.23	-57.36	-48.12	3.51	13.40	V
	7639	-52.01	-13	-39.01	-75.89	-59.44	4.05	11.48	V
									V
									V
									V
									V

**Remark:** Spurious emissions within 30-1000MHz were found more than 20dB below limit line.



**GPRS 1900**

GPRS 1900									
Channel	Frequency ( MHz )	EIRP ( dBm )	Limit ( dBm )	Margin ( dB )	SPA Reading (dBm)	S.G. Power ( dBm )	TX Cable loss ( dB )	TX Antenna Gain (dBi)	Polarization (H/V)
Lowest	3700	-54.06	-13	-41.06	-68.47	-63.69	2.77	12.40	H
	5548	-41.11	-13	-28.11	-59.48	-51.04	3.46	13.39	H
	7400	-52.02	-13	-39.02	-75.78	-59.24	3.98	11.20	H
									H
									H
									H
									H
	3700	-51.72	-13	-38.72	-66.54	-61.35	2.77	12.40	V
	5548	-32.46	-13	-19.46	-50.88	-42.39	3.46	13.39	V
	7400	-51.45	-13	-38.45	-75.69	-58.67	3.98	11.20	V
									V
									V
									V
									V
Middle	3756	-51.24	-13	-38.24	-65.82	-60.95	2.78	12.49	H
	5639	-39.85	-13	-26.85	-58.24	-49.82	3.48	13.46	H
	7520	-52.28	-13	-39.28	-75.98	-59.47	4.01	11.20	H
									H
									H
									H
									H
	3756	-50.67	-13	-37.67	-65.65	-60.38	2.78	12.49	V
	5639	-30.85	-13	-17.85	-49.46	-40.82	3.48	13.46	V
	7520	-52.02	-13	-39.02	-76.11	-59.21	4.01	11.20	V
									V
									V
									V
									V



Highest	3819	-53.48	-13	-40.48	-68.17	-63.05	2.80	12.36	H
	5730	-41.58	-13	-28.58	-60.48	-51.47	3.51	13.40	H
	7639	-52.43	-13	-39.43	-75.77	-59.86	4.05	11.48	H
									H
									H
									H
									H
	3819	-49.20	-13	-36.20	-64.28	-58.77	2.80	12.36	V
	5730	-32.02	-13	-19.02	-51.15	-41.91	3.51	13.40	V
	7639	-51.86	-13	-38.86	-75.74	-59.29	4.05	11.48	V
									V
									V
									V
									V

**Remark:** Spurious emissions within 30-1000MHz were found more than 20dB below limit line.



### WCDMA Band II

WCDMA Band II									
Channel	Frequency ( MHz )	EIRP ( dBm )	Limit ( dBm )	Margin ( dB )	SPA Reading (dBm)	S.G. Power ( dBm )	TX Cable loss ( dB )	TX Antenna Gain (dBi)	Polarization (H/V)
Lowest	3707	-59.98	-13	-46.98	-74.41	-69.62	2.77	12.41	H
	5557	-56.43	-13	-43.43	-74.76	-66.35	3.46	13.39	H
	7409	-52.09	-13	-39.09	-75.86	-59.27	3.98	11.16	H
									H
									H
									H
									H
	3707	-58.93	-13	-45.93	-73.76	-68.57	2.77	12.41	V
	5557	-52.30	-13	-39.30	-70.71	-62.22	3.46	13.39	V
	7409	-51.88	-13	-38.88	-76.11	-59.06	3.98	11.16	V
									V
									V
									V
									V
Middle	3763	-59.58	-13	-46.58	-74.18	-69.27	2.78	12.47	H
	5640	-56.18	-13	-43.18	-74.57	-66.16	3.48	13.46	H
	7520	-52.55	-13	-39.55	-76.25	-59.74	4.01	11.20	H
									H
									H
									H
									H
	3763	-59.00	-13	-46.00	-73.99	-68.69	2.78	12.47	V
	5639	-53.03	-13	-40.03	-71.64	-63.00	3.48	13.46	V
	7520	-52.04	-13	-39.04	-76.13	-59.23	4.01	11.20	V
									V
									V
									V
									V



Highest	3812	-60.15	-13	-47.15	-74.84	-69.73	2.79	12.38	H
	5722	-56.15	-13	-43.15	-75.01	-66.05	3.50	13.40	H
	7630	-52.46	-13	-39.46	-75.8	-59.87	4.05	11.46	H
									H
									H
									H
									H
	3812	-59.40	-13	-46.40	-74.48	-68.98	2.79	12.38	V
	5723	-52.82	-13	-39.82	-71.92	-62.72	3.50	13.40	V
	7630	-51.69	-13	-38.69	-75.57	-59.10	4.05	11.46	V
									V
									V
									V
									V

Remark: Spurious emissions within 30-1000MHz were found more than 20dB below limit line.



### WCDMA Band IV

WCDMA Band IV									
Channel	Frequency ( MHz )	EIRP ( dBm )	Limit ( dBm )	Margin ( dB )	SPA Reading (dBm)	S.G. Power ( dBm )	TX Cable loss ( dB )	TX Antenna Gain (dBi)	Polarization (H/V)
Lowest	3427	-61.56	-13	-48.56	-74.96	-71.48	2.68	12.60	H
	5137	-57.61	-13	-44.61	-75.17	-66.74	3.32	12.45	H
	6849	-54.04	-13	-41.04	-76.2	-62.58	3.86	12.40	H
									H
									H
									H
									H
	3427	-61.31	-13	-48.31	-75.08	-71.23	2.68	12.60	V
	5137	-57.21	-13	-44.21	-75.32	-66.34	3.32	12.45	V
	6849	-54.04	-13	-41.04	-76.55	-62.58	3.86	12.40	V
									V
									V
									V
									V
Middle	3462	-61.35	-13	-48.35	-75.02	-71.20	2.70	12.55	H
	5197	-57.59	-13	-44.59	-75.38	-67.03	3.34	12.78	H
	6930	-53.66	-13	-40.66	-76.11	-61.77	3.89	12.00	H
									H
									H
									H
									H
	3462	-60.90	-13	-47.90	-74.94	-70.75	2.70	12.55	V
	5197	-57.27	-13	-44.27	-75.55	-66.71	3.34	12.78	V
	6930	-53.55	-13	-40.55	-76.09	-61.66	3.89	12.00	V
									V
									V
									V
									V



Highest	3504	-60.86	-13	-47.86	-74.83	-70.52	2.72	12.38	H
	5254	-56.80	-13	-43.80	-74.6	-66.65	3.36	13.22	H
	7010	-52.86	-13	-39.86	-75.57	-60.79	3.91	11.84	H
									H
									H
									H
									H
	3504	-60.61	-13	-47.61	-74.95	-70.27	2.72	12.38	V
	5261	-56.34	-13	-43.34	-74.53	-66.22	3.36	13.24	V
	7010	-53.03	-13	-40.03	-75.63	-60.96	3.91	11.84	V
									V
									V
									V
									V

**Remark:** Spurious emissions within 30-1000MHz were found more than 20dB below limit line.





<ASDIV Antenna>

<Ant. 1>

**EDGE 850**

EDGE 850									
Channel	Frequency ( MHz )	ERP ( dBm )	Limit ( dBm )	Margin ( dB )	SPA Reading (dBm)	S.G. Power ( dBm )	TX Cable loss ( dB )	TX Antenna Gain (dBi)	Polarization (H/V)
Lowest	1648	-64.69	-13	-51.69	-71.29	-69.99	1.83	9.28	H
	2472	-60.23	-13	-47.23	-70.9	-66.46	2.25	10.63	H
	3296	-61.03	-13	-48.03	-73.64	-68.54	2.62	12.28	H
									H
									H
									H
	1648	-63.82	-13	-50.82	-70.88	-69.12	1.83	9.28	V
	2472	-62.39	-13	-49.39	-73.29	-68.62	2.25	10.63	V
	3296	-60.80	-13	-47.80	-73.82	-68.31	2.62	12.28	V
									V
									V
Middle	1672	-65.62	-13	-52.62	-72.36	-71.05	1.85	9.43	H
	2509	-62.49	-13	-49.49	-73.32	-68.88	2.26	10.80	H
	3345	-62.24	-13	-49.24	-74.7	-70.10	2.65	12.66	H
									H
									H
									H
	1672	-60.31	-13	-47.31	-67.52	-65.74	1.85	9.43	V
	2509	-61.20	-13	-48.20	-72.13	-67.59	2.26	10.80	V
	3345	-61.81	-13	-48.81	-74.66	-69.67	2.65	12.66	V
									V
									V



Highest	1696	-65.65	-13	-52.65	-72.54	-71.22	1.86	9.58	H
	2546	-58.32	-13	-45.32	-69.01	-64.69	2.28	10.80	H
	3395	-62.46	-13	-49.46	-74.77	-70.25	2.67	12.61	H
									H
									H
									H
	1696	-64.95	-13	-51.95	-72.32	-70.52	1.86	9.58	V
	2546	-62.53	-13	-49.53	-73.55	-68.90	2.28	10.80	V
	3395	-62.06	-13	-49.06	-74.75	-69.85	2.67	12.61	V
									V
									V
									V

Remark: Spurious emissions within 30-1000MHz were found more than 20dB below limit line.



**GPRS 850**

GPRS 850									
Channel	Frequency ( MHz )	ERP ( dBm )	Limit ( dBm )	Margin ( dB )	SPA Reading (dBm)	S.G. Power ( dBm )	TX Cable loss ( dB )	TX Antenna Gain (dBi)	Polarization (H/V)
Lowest	1648	-64.79	-13	-51.79	-71.39	-70.09	1.83	9.28	H
	2472	-62.17	-13	-49.17	-72.84	-68.40	2.25	10.63	H
	3296	-61.36	-13	-48.36	-73.97	-68.87	2.62	12.28	H
									H
									H
									H
									H
	1648	-63.40	-13	-50.40	-70.46	-68.70	1.83	9.28	V
	2472	-62.57	-13	-49.57	-73.47	-68.80	2.25	10.63	V
	3296	-60.72	-13	-47.72	-73.74	-68.23	2.62	12.28	V
									V
									V
									V
									V
Middle	1672	-59.68	-13	-46.68	-66.42	-65.11	1.85	9.43	H
	2512	-51.19	-13	-38.19	-62.01	-57.57	2.27	10.80	H
	3345	-62.28	-13	-49.28	-74.74	-70.14	2.65	12.66	H
									H
									H
									H
									H
	1672	-62.74	-13	-49.74	-69.95	-68.17	1.85	9.43	V
	2512	-53.29	-13	-40.29	-64.23	-59.67	2.27	10.80	V
	3345	-61.62	-13	-48.62	-74.47	-69.48	2.65	12.66	V
									V
									V
									V
									V
								V	



Highest	1696	-57.25	-13	-44.25	-64.14	-62.82	1.86	9.58	H
	2544	-47.06	-13	-34.06	-57.75	-53.43	2.28	10.80	H
	3395	-62.55	-13	-49.55	-74.86	-70.34	2.67	12.61	H
									H
									H
									H
									H
	1696	-53.26	-13	-40.26	-60.63	-58.83	1.86	9.58	V
	2544	-48.25	-13	-35.25	-59.26	-54.62	2.28	10.80	V
	3395	-62.13	-13	-49.13	-74.82	-69.92	2.67	12.61	V
									V
									V
									V
									V

Remark: Spurious emissions within 30-1000MHz were found more than 20dB below limit line.



### WCDMA Band V

WCDMA Band V										
Channel	Frequency ( MHz )	ERP ( dBm )	Limit ( dBm )	Margin ( dB )	SPA Reading (dBm)	S.G. Power ( dBm )	TX Cable loss ( dB )	TX Antenna Gain (dBi)	Polarization (H/V)	
Lowest	1656	-66.09	-13	-53.09	-72.74	-71.44	1.84	9.34	H	
	2479	-63.45	-13	-50.45	-74.17	-69.72	2.25	10.67	H	
	3305	-62.07	-13	-49.07	-74.65	-69.63	2.63	12.34	H	
										H
										H
										H
										H
	1656	-65.25	-13	-52.25	-72.36	-70.60	1.84	9.34	V	
	2479	-63.22	-13	-50.22	-74.12	-69.49	2.25	10.67	V	
	3305	-61.31	-13	-48.31	-74.29	-68.87	2.63	12.34	V	
										V
										V
										V
										V
Middle	1672	-65.83	-13	-52.83	-72.57	-71.26	1.85	9.43	H	
	2509	-62.76	-13	-49.76	-73.59	-69.15	2.26	10.80	H	
	3345	-62.59	-13	-49.59	-75.05	-70.45	2.65	12.66	H	
										H
										H
										H
										H
	1672	-65.47	-13	-52.47	-72.68	-70.90	1.85	9.43	V	
	2509	-62.64	-13	-49.64	-73.57	-69.03	2.26	10.80	V	
	3345	-62.35	-13	-49.35	-75.2	-70.21	2.65	12.66	V	
										V
										V
										V
										V



Highest	1696	-65.74	-13	-52.74	-72.63	-71.31	1.86	9.58	H
	2539	-62.75	-13	-49.75	-73.46	-69.12	2.28	10.80	H
	3386	-62.75	-13	-49.75	-75.09	-70.56	2.67	12.63	H
									H
									H
									H
									H
	1696	-65.35	-13	-52.35	-72.72	-70.92	1.86	9.58	V
	2539	-62.45	-13	-49.45	-73.45	-68.82	2.28	10.80	V
	3386	-62.10	-13	-49.10	-74.81	-69.91	2.67	12.63	V
									V
									V
									V
									V

Remark: Spurious emissions within 30-1000MHz were found more than 20dB below limit line.



<Ant. 0>

**EDGE 1900**

EDGE 1900									
Channel	Frequency ( MHz )	EIRP ( dBm )	Limit ( dBm )	Margin ( dB )	SPA Reading (dBm)	S.G. Power ( dBm )	TX Cable loss ( dB )	TX Antenna Gain (dBi)	Polarization (H/V)
Lowest	3700	-59.98	-13	-46.98	-74.41	-69.62	2.77	12.41	H
	5557	-56.95	-13	-43.95	-75.28	-66.87	3.46	13.39	H
	7409	-51.85	-13	-38.85	-75.62	-59.03	3.98	11.16	H
									H
									H
									H
									H
	3700	-59.32	-13	-46.32	-74.14	-68.95	2.77	12.40	V
	5550	-57.25	-13	-44.25	-75.66	-67.19	3.46	13.40	V
	7400	-51.71	-13	-38.71	-75.95	-58.93	3.98	11.20	V
									V
									V
									V
									V
Middle	3763	-59.98	-13	-46.98	-74.58	-69.67	2.78	12.47	H
	5640	-57.13	-13	-44.13	-75.52	-67.11	3.48	13.46	H
	7520	-52.31	-13	-39.31	-76.01	-59.50	4.01	11.20	H
									H
									H
									H
									H
	3763	-59.46	-13	-46.46	-74.45	-69.15	2.78	12.47	V
	5640	-56.89	-13	-43.89	-75.51	-66.87	3.48	13.46	V
	7520	-52.23	-13	-39.23	-76.32	-59.42	4.01	11.20	V
									V
									V
									V
									V



Highest	3819	-59.63	-13	-46.63	-74.32	-69.20	2.80	12.36	H
	5729	-57.39	-13	-44.39	-76.29	-67.29	3.50	13.40	H
	7639	-52.82	-13	-39.82	-76.16	-60.25	4.05	11.48	H
									H
									H
									H
									H
	3819	-59.44	-13	-46.44	-74.52	-69.01	2.80	12.36	V
	5729	-57.00	-13	-44.00	-76.14	-66.90	3.50	13.40	V
	7639	-52.10	-13	-39.10	-75.98	-59.53	4.05	11.48	V
									V
									V
									V
									V

**Remark:** Spurious emissions within 30-1000MHz were found more than 20dB below limit line.





**GPRS 1900**

GPRS 1900									
Channel	Frequency ( MHz )	EIRP ( dBm )	Limit ( dBm )	Margin ( dB )	SPA Reading (dBm)	S.G. Power ( dBm )	TX Cable loss ( dB )	TX Antenna Gain (dBi)	Polarization (H/V)
Lowest	3700	-58.14	-13	-45.14	-72.55	-67.77	2.77	12.40	H
	5550	-57.22	-13	-44.22	-75.57	-67.16	3.46	13.40	H
	7400	-52.40	-13	-39.40	-76.16	-59.62	3.98	11.20	H
									H
									H
									H
									H
	3700	-58.81	-13	-45.81	-73.63	-68.44	2.77	12.40	V
	5550	-53.64	-13	-40.64	-72.05	-63.58	3.46	13.40	V
	7400	-51.90	-13	-38.90	-76.14	-59.12	3.98	11.20	V
									V
									V
									V
									V
Middle	3763	-59.91	-13	-46.91	-74.51	-69.60	2.78	12.47	H
	5640	-57.34	-13	-44.34	-75.73	-67.32	3.48	13.46	H
	7520	-52.34	-13	-39.34	-76.04	-59.53	4.01	11.20	H
									H
									H
									H
									H
	3763	-59.62	-13	-46.62	-74.61	-69.31	2.78	12.47	V
	5640	-56.98	-13	-43.98	-75.6	-66.96	3.48	13.46	V
	7520	-52.20	-13	-39.20	-76.29	-59.39	4.01	11.20	V
									V
									V
									V
									V



Highest	3819	-59.66	-13	-46.66	-74.35	-69.23	2.80	12.36	H
	5729	-57.38	-13	-44.38	-76.28	-67.28	3.50	13.40	H
	7639	-52.67	-13	-39.67	-76.01	-60.10	4.05	11.48	H
									H
									H
									H
									H
	3819	-59.14	-13	-46.14	-74.22	-68.71	2.80	12.36	V
	5729	-57.15	-13	-44.15	-76.29	-67.05	3.50	13.40	V
	7639	-52.22	-13	-39.22	-76.1	-59.65	4.05	11.48	V
									V
									V
									V
									V

Remark: Spurious emissions within 30-1000MHz were found more than 20dB below limit line.



### WCDMA Band II

WCDMA Band II										
Channel	Frequency ( MHz )	EIRP ( dBm )	Limit ( dBm )	Margin ( dB )	SPA Reading (dBm)	S.G. Power ( dBm )	TX Cable loss ( dB )	TX Antenna Gain (dBi)	Polarization (H/V)	
Lowest	3707	-59.98	-13	-46.98	-74.41	-69.62	2.77	12.41	H	
	5557	-56.95	-13	-43.95	-75.28	-66.87	3.46	13.39	H	
	7409	-51.85	-13	-38.85	-75.62	-59.03	3.98	11.16	H	
										H
										H
										H
										H
	3707	-59.64	-13	-46.64	-74.47	-69.28	2.77	12.41	V	
	5557	-56.64	-13	-43.64	-75.05	-66.56	3.46	13.39	V	
	7409	-51.33	-13	-38.33	-75.56	-58.51	3.98	11.16	V	
										V
										V
										V
										V
Middle	3812	-60.24	-13	-47.24	-74.93	-69.82	2.79	12.38	H	
	5722	-56.87	-13	-43.87	-75.73	-66.77	3.50	13.40	H	
	7630	-52.10	-13	-39.10	-75.44	-59.51	4.05	11.46	H	
										H
										H
										H
										H
	3812	-59.75	-13	-46.75	-74.83	-69.33	2.79	12.38	V	
	5722	-56.62	-13	-43.62	-75.71	-66.52	3.50	13.40	V	
	7630	-51.37	-13	-38.37	-75.25	-58.78	4.05	11.46	V	
										V
										V
										V
										V



Highest	3763	-59.41	-13	-46.41	-74.01	-69.10	2.78	12.47	H
	5640	-57.08	-13	-44.08	-75.47	-67.06	3.48	13.46	H
	7520	-52.47	-13	-39.47	-76.17	-59.66	4.01	11.20	H
									H
									H
									H
									H
	3763	-59.11	-13	-46.11	-74.1	-68.80	2.78	12.47	V
	5640	-56.56	-13	-43.56	-75.18	-66.54	3.48	13.46	V
	7520	-51.75	-13	-38.75	-75.84	-58.94	4.01	11.20	V
									V
									V
									V
									V

Remark: Spurious emissions within 30-1000MHz were found more than 20dB below limit line.



**WCDMA Band IV**

WCDMA Band IV									
Channel	Frequency ( MHz )	EIRP ( dBm )	Limit ( dBm )	Margin ( dB )	SPA Reading (dBm)	S.G. Power ( dBm )	TX Cable loss ( dB )	TX Antenna Gain (dBi)	Polarization (H/V)
Lowest	3427	-61.93	-13	-48.93	-75.33	-71.85	2.68	12.60	H
	5137	-58.05	-13	-45.05	-75.61	-67.18	3.32	12.45	H
	6849	-54.41	-13	-41.41	-76.57	-62.95	3.86	12.40	H
									H
									H
									H
									H
	3427	-61.35	-13	-48.35	-75.12	-71.27	2.68	12.60	V
	5137	-57.58	-13	-44.58	-75.69	-66.71	3.32	12.45	V
	6849	-54.19	-13	-41.19	-76.7	-62.73	3.86	12.40	V
									V
									V
									V
									V
Middle	3462	-61.35	-13	-48.35	-75.02	-71.20	2.70	12.55	H
	5197	-58.43	-13	-45.43	-76.22	-67.87	3.34	12.78	H
	6930	-53.52	-13	-40.52	-75.97	-61.63	3.89	12.00	H
									H
									H
									H
									H
	3462	-61.12	-13	-48.12	-75.16	-70.97	2.70	12.55	V
	5197	-57.75	-13	-44.75	-76.03	-67.19	3.34	12.78	V
	6930	-53.43	-13	-40.43	-75.97	-61.54	3.89	12.00	V
									V
									V
									V
									V



Highest	3504	-61.21	-13	-48.21	-75.18	-70.87	2.72	12.38	H
	5257	-58.00	-13	-45.00	-75.8	-67.87	3.36	13.23	H
	7010	-53.19	-13	-40.19	-75.9	-61.12	3.91	11.84	H
									H
									H
									H
									H
	3504	-60.95	-13	-47.95	-75.29	-70.61	2.72	12.38	V
	5257	-57.76	-13	-44.76	-75.96	-67.63	3.36	13.23	V
	7010	-52.98	-13	-39.98	-75.58	-60.91	3.91	11.84	V
									V
									V
									V
									V

Remark: Spurious emissions within 30-1000MHz were found more than 20dB below limit line.

————THE END————