



FCC RADIO TEST REPORT

FCC ID : A4RGE2AE
Equipment : Phone
Applicant : Google LLC
1600 Amphitheatre Parkway,
Mountain View, California, 94043 USA
Standard : FCC Part 15 Subpart C §15.247

The product was received on Mar. 17, 2022 and testing was performed from Apr. 11, 2022 to May 19, 2022. We, Sporton International Inc. Wensan Laboratory, would like to declare that the tested sample has been evaluated in accordance with the test procedures and has been in compliance with the applicable technical standards.

The test results in this report apply exclusively to the tested model / sample. Without written approval from Sporton International Inc. Wensan Laboratory, the test report shall not be reproduced except in full.

Louis Wu

Approved by: Louis Wu

Sporton International Inc. Wensan Laboratory

No. 58, Aly. 75, Ln. 564, Wenhua 3rd, Rd., Guishan Dist., Taoyuan City 333010, Taiwan (R.O.C.)



Table of Contents

History of this test report.....	3
Summary of Test Result.....	4
1 General Description.....	5
1.1 Product Feature of Equipment Under Test.....	5
1.2 Product Specification of Equipment Under Test.....	6
1.3 Modification of EUT	6
1.4 Testing Location	7
1.5 Applicable Standards.....	7
2 Test Configuration of Equipment Under Test	8
2.1 Carrier Frequency Channel	8
2.2 Test Mode.....	9
2.3 Connection Diagram of Test System.....	10
2.4 Support Unit used in test configuration and system	11
2.5 EUT Operation Test Setup	11
2.6 Measurement Results Explanation Example.....	11
3 Test Result.....	12
3.1 6dB and 99% Bandwidth Measurement	12
3.2 Output Power Measurement.....	29
3.3 Power Spectral Density Measurement	30
3.4 Conducted Band Edges and Spurious Emission Measurement	47
3.5 Radiated Band Edges and Spurious Emission Measurement	68
3.6 AC Conducted Emission Measurement.....	72
3.7 Antenna Requirements.....	74
4 List of Measuring Equipment	75
5 Uncertainty of Evaluation.....	77
Appendix A. Conducted Test Results	
Appendix B. AC Conducted Emission Test Result	
Appendix C. Radiated Spurious Emission	
Appendix D. Radiated Spurious Emission Plots	
Appendix E. Duty Cycle Plots	
Appendix F. Setup Photographs	



Summary of Test Result

Report Clause	Ref Std. Clause	Test Items	Result (PASS/FAIL)	Remark
3.1	15.247(a)(2)	6dB Bandwidth	Pass	-
3.1	2.1049	99% Occupied Bandwidth	Reporting only	-
3.2	15.247(b)(3)	Output Power	Pass	-
3.3	15.247(e)	Power Spectral Density	Pass	-
3.4	15.247(d)	Conducted Band Edges and Spurious Emission	Pass	-
3.5	15.247(d)	Radiated Band Edges and Spurious Emission	Pass	5.90 dB under the limit at 18000.000 MHz
3.6	15.207	AC Conducted Emission	Pass	19.18 dB under the limit at 0.155 MHz
3.7	15.203 & 15.247(b)	Antenna Requirement	Pass	-

Declaration of Conformity:

1. The test results (PASS/FAIL) with all measurement uncertainty excluded are presented in accordance with the regulation limits or requirements declared by manufacturers. It's means measurement values may risk exceeding the limit of regulation standards, if measurement uncertainty is include in test results.
2. The measurement uncertainty please refer to this report "Uncertainty of Evaluation".

Comments and Explanations:

The product specifications of the EUT presented in the report are declared by the manufacturer who shall take full responsibility for the authenticity.

Reviewed by: William Chen

Report Producer: Rachel Hsieh



1 General Description

1.1 Product Feature of Equipment Under Test

Product Feature	
Equipment	Phone
FCC ID	A4RGE2AE
EUT supports Radios application	GSM/EGPRS/WCDMA/HSPA/LTE/5G NR/ NFC/GNSS/WPC/WPT/UWB WLAN 11b/g/n HT20 WLAN 11a/n HT20/HT40 WLAN 11ac VHT20/VHT40/VHT80/VHT160 WLAN 11ax HE20/HE40/HE80/HE160 Bluetooth BR/EDR/LE

Remark: The above EUT's information was declared by manufacturer.

EUT Information List	
S/N	Performed Test Item
23061FDH300012	RF Conducted Measurement
22271FDH30000A	Radiated Spurious Emission
22271FDH30000P	Conducted Emission



1.2 Product Specification of Equipment Under Test

Product Specification is subject to this standard			
Tx/Rx Frequency Range	2402 MHz ~ 2480 MHz		
Number of Channels	40		
Carrier Frequency of Each Channel	40 Channel (37 hopping + 3 advertising channel)		
Maximum Output Power to Antenna	<p><Ant. 4> Bluetooth – LE (1Mbps): 19.65 dBm / 0.0923 W Bluetooth – LE (2Mbps): 19.75 dBm / 0.0944 W</p> <p><Ant. 3> Bluetooth – LE (1Mbps): 19.75 dBm / 0.0944 W Bluetooth – LE (2Mbps): 19.95 dBm / 0.0989 W</p> <p>MIMO <Ant. 4+3> Bluetooth – LE (1Mbps): 22.41 dBm / 0.1742 W Bluetooth – LE (2Mbps): 22.66 dBm / 0.1845 W</p>		
99% Occupied Bandwidth	<p><Ant. 4> Bluetooth – LE (1Mbps): 1.036 MHz Bluetooth – LE (2Mbps): 2.053 MHz</p> <p><Ant. 3> Bluetooth – LE (1Mbps): 1.039 MHz Bluetooth – LE (2Mbps): 2.050 MHz</p> <p>MIMO <Ant. 4+3> Bluetooth – LE (1Mbps): 1.037 MHz Bluetooth – LE (2Mbps): 2.054 MHz</p>		
Antenna Type / Gain	<p><Ant. 4> : ILA Antenna with gain -1.6 dBi <Ant. 3> : IFA Antenna with gain -0.4 dBi</p>		
Type of Modulation	Bluetooth - LE : GFSK		
Antenna Function Description		Ant. 4	Ant. 3
	Bluetooth - LE	V	V
	Bluetooth- LE MIMO	V	V

Remark:

1. MIMO Ant. 4+3 Directional Gain is a calculated result from MIMO Ant. 4 and MIMO Ant. 3. The formula used in calculation is documented in section 3.7.
2. Power of MIMO Ant. 4 + Ant. 3 is a calculated result from sum of the power MIMO Ant. 4 and MIMO Ant. 3.
3. The above EUT's information was declared by manufacturer. Please refer to Comments and Explanations in report summary.

1.3 Modification of EUT

No modifications made to the EUT during the testing.



1.4 Testing Location

Test Site	Sporton International Inc. EMC & Wireless Communications Laboratory
Test Site Location	No.52, Huaya 1st Rd., Guishan Dist., Taoyuan City 333, Taiwan (R.O.C.) TEL: +886-3-327-3456 FAX: +886-3-328-4978
Test Site No.	Sporton Site No. CO05-HY (TAF Code: 1190)
Remark	The Conducted Emission test item subcontracted to Sporton International Inc. EMC & Wireless Communications Laboratory.

Note: The test site complies with ANSI C63.4 2014 requirement.

Test Site	Sporton International Inc. Wensan Laboratory
Test Site Location	No.58, Aly. 75, Ln. 564, Wenhua 3rd, Rd., Guishan Dist., Taoyuan City 333010, Taiwan (R.O.C.) TEL: +886-3-327-0868 FAX: +886-3-327-0855
Test Site No.	Sporton Site No. TH05-HY, 03CH20-HY

Note: The test site complies with ANSI C63.4 2014 requirement.

FCC designation No.: TW1190 and TW3786

1.5 Applicable Standards

According to the specifications declared by the manufacturer, the EUT must comply with the requirements of the following standards:

- ♦ FCC Part 15 Subpart C §15.247
- ♦ FCC KDB Publication No. 558074 D01 DTS Meas. Guidance v05r02
- ♦ FCC KDB 414788 D01 Radiated Test Site v01r01
- ♦ FCC KDB 662911 D01 Multiple Transmitter Output v02r01.
- ♦ ANSI C63.10-2013

Remark:

1. All the test items were validated and recorded in accordance with the standards without any modification during the testing.
2. The TAF code is not including all the FCC KDB listed without accreditation.



2 Test Configuration of Equipment Under Test

2.1 Carrier Frequency Channel

Frequency Band	Channel	Freq. (MHz)	Channel	Freq. (MHz)
2400-2483.5 MHz	0	2402	21	2444
	1	2404	22	2446
	2	2406	23	2448
	3	2408	24	2450
	4	2410	25	2452
	5	2412	26	2454
	6	2414	27	2456
	7	2416	28	2458
	8	2418	29	2460
	9	2420	30	2462
	10	2422	31	2464
	11	2424	32	2466
	12	2426	33	2468
	13	2428	34	2470
	14	2430	35	2472
	15	2432	36	2474
	16	2434	37	2476
	17	2436	38	2478
	18	2438	39	2480
	19	2440	-	-
20	2442	-	-	



2.2 Test Mode

- a. The EUT has been associated with peripherals and configuration operated in a manner tended to maximize its emission characteristics in a typical application. Frequency range investigated: conduction emission (150 kHz to 30 MHz), radiation emission (9 kHz to the 10th harmonic of the highest fundamental frequency or to 40 GHz, whichever is lower). For radiated measurement, the measured emission level of the EUT was maximized by rotating the EUT on a turntable, adjusting the orientation of the EUT and EUT antenna in three orthogonal axis (X: flat, Y: portrait, Z: landscape) and accessory (Adapter or Earphone), and adjusting the measurement antenna orientation, following C63.10 exploratory test procedures and find X plane with Adapter as worst plane.
- b. AC power line Conducted Emission was tested under maximum output power.

The following summary table is showing all test modes to demonstrate in compliance with the standard.

Summary table of Test Cases	
Test Item	Data Rate / Modulation
Conducted Test Cases	Bluetooth – LE / GFSK
	Mode 1: Bluetooth Tx CH00_2402 MHz_1Mbps
	Mode 2: Bluetooth Tx CH19_2440 MHz_1Mbps
	Mode 3: Bluetooth Tx CH39_2480 MHz_1Mbps
	Mode 4: Bluetooth Tx CH00_2402 MHz_2Mbps
	Mode 5: Bluetooth Tx CH19_2440 MHz_2Mbps
	Mode 6: Bluetooth Tx CH39_2480 MHz_2Mbps
Radiated Test Cases	Mode 1: Bluetooth Tx CH00_2402 MHz_1Mbps Mode 2: Bluetooth Tx CH19_2440 MHz_1Mbps Mode 3: Bluetooth Tx CH39_2480 MHz_1Mbps
AC Conducted Emission	Mode 1: GSM850 Idle + WLAN (2.4GHz) Link + Bluetooth Link + USB Cable 1 (Charging from AC Adapter 2)
Remark:	
1. For Radiated Test Cases, the tests were performed with Adapter 2 and USB Cable 1.	
2. During the preliminary test, both charging modes (Adapter mode and WPT Charging mode) were verified. It is determined that the adaptor mode is the worst case for official test.	

2.3 Connection Diagram of Test System

<AC Conducted Emission Mode>

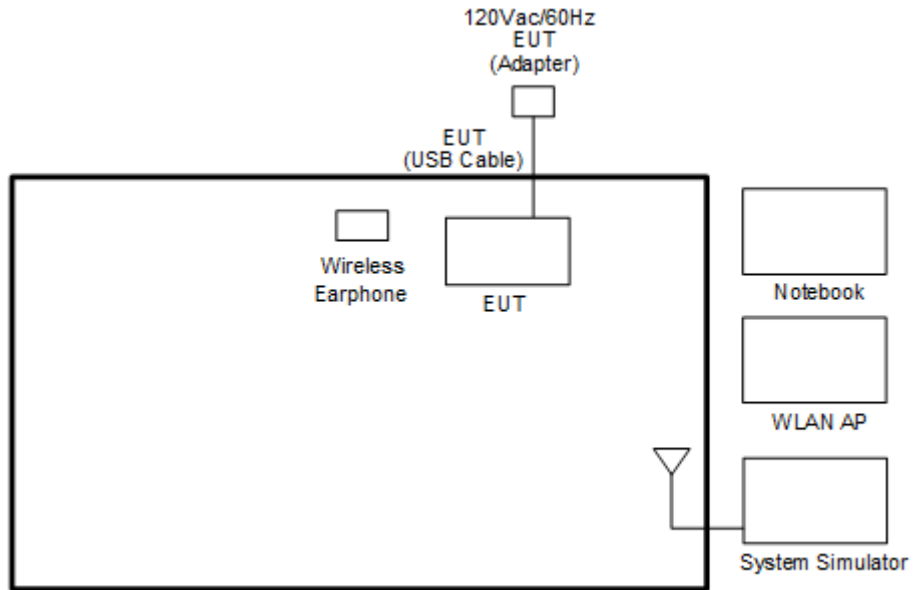

<Bluetooth – LE Tx Mode>

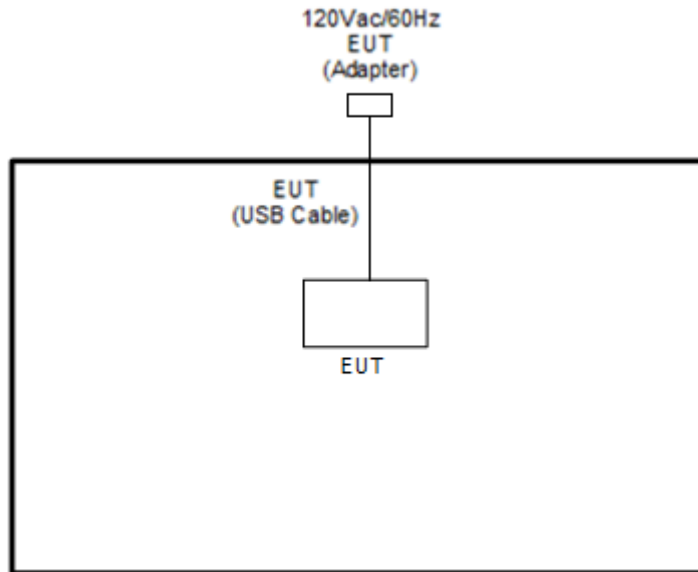

2.4 Support Unit used in test configuration and system

Item	Equipment	Brand Name	Model Name	FCC ID	Data Cable	Power Cord
1.	System Simulator	Anritsu	MT8820C	N/A	N/A	Unshielded, 1.8 m
2.	Wireless Earphone	Google	G1007/G1008	A4RG1007/ A4RG1008	N/A	N/A
3.	WLAN AP	ASUS	RT-AC66U	MSQ-RTAC66U	N/A	Unshielded, 1.8 m
4.	Notebook	DELL	Latitude 3400	FCC DoC	N/A	AC I/P: Unshielded, 1.2 m DC O/P: Shielded, 1.8 m

2.5 EUT Operation Test Setup

The RF test items, utility “adb Command 1.0.36” was installed in Notebook which was programmed in order to make the EUT get into the engineering modes to provide channel selection, power level, data rate and the application type and for continuous transmitting signals.

2.6 Measurement Results Explanation Example

For all conducted test items:

The offset level is set in the spectrum analyzer to compensate the RF cable loss and attenuator factor between EUT conducted output port and spectrum analyzer. With the offset compensation, the spectrum analyzer reading level is exactly the EUT RF output level.

Example :

The spectrum analyzer offset is derived from RF cable loss and attenuator factor.

Offset = RF cable loss + attenuator factor.

Following shows an offset computation example with cable loss 4.2 dB and 10 dB attenuator.

$$\begin{aligned}
 \text{Offset(dB)} &= \text{RF cable loss(dB)} + \text{attenuator factor(dB)}. \\
 &= 4.2 + 10 = 14.2 \text{ (dB)}
 \end{aligned}$$

3 Test Result

3.1 6dB and 99% Bandwidth Measurement

3.1.1 Limit of 6dB and 99% Bandwidth

The minimum 6 dB bandwidth shall be at least 500 kHz.

3.1.2 Measuring Instruments

Please refer to the measuring equipment list in this test report.

3.1.3 Test Procedures

1. The testing follows the ANSI C63.10 Section 6.9.3 (OBW) and 11.8.1 (6dB BW).
2. The RF output of EUT is connected to the spectrum analyzer by RF cable and attenuator. The path loss is compensated to the results for each measurement.
3. Set the maximum power setting and enable the EUT to transmit continuously.
4. Make the measurement with the spectrum analyzer's resolution bandwidth (RBW) = 100 kHz. Set the Video bandwidth (VBW) = 300 kHz. In order to make an accurate measurement. The 6dB bandwidth must be greater than 500 kHz.
5. For 99% Bandwidth Measurement, the spectrum analyzer's resolution bandwidth (RBW) is set 1-5% of the emission bandwidth and set the Video bandwidth (VBW) $\geq 3 * RBW$.
6. Measure and record the results in the test report.

3.1.4 Test Setup

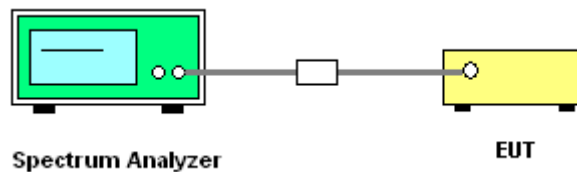



3.1.5 Test Result of 6dB Bandwidth

Please refer to Appendix A.

<Ant. 4>

<1Mbps>

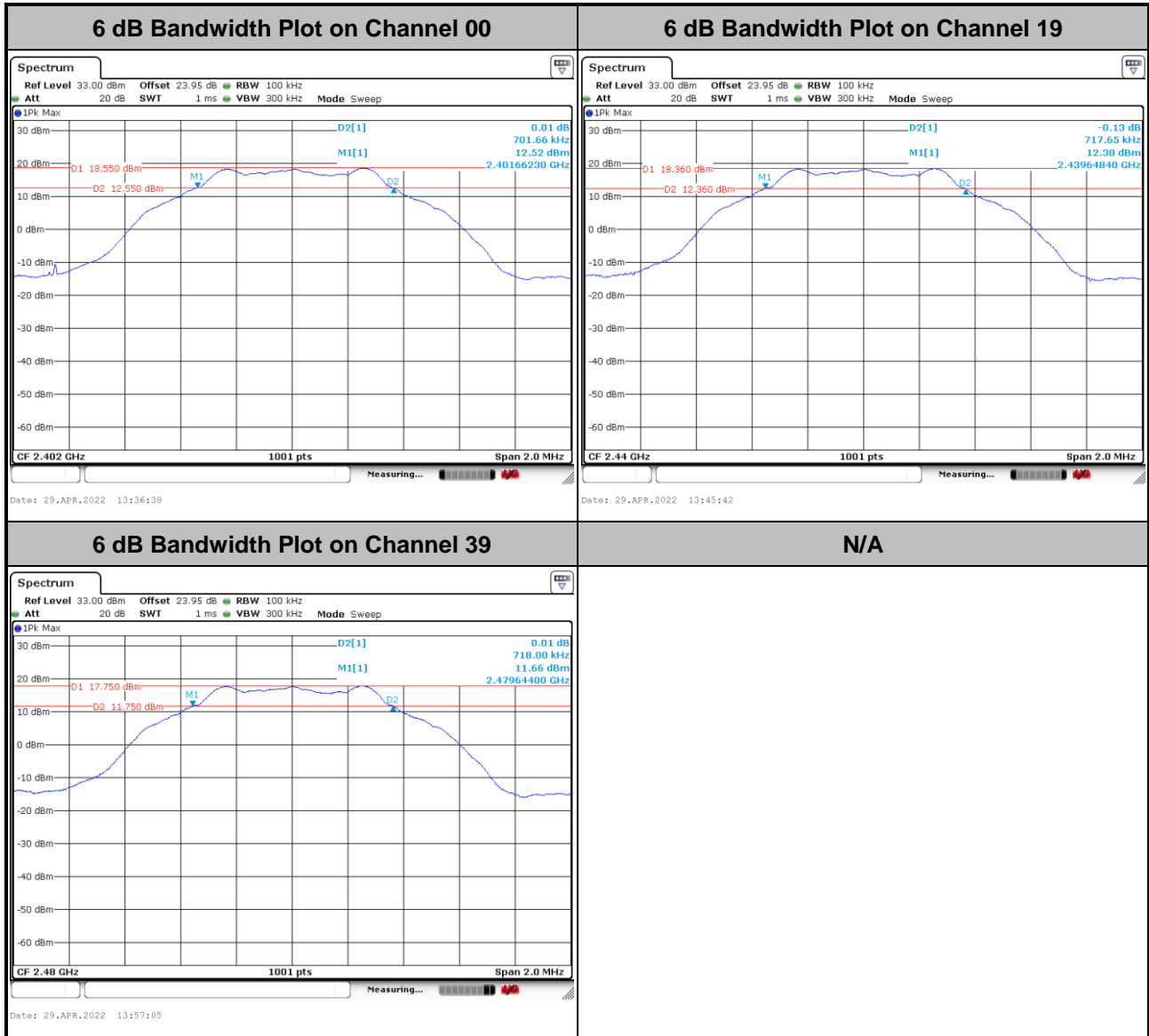



<2Mbps>

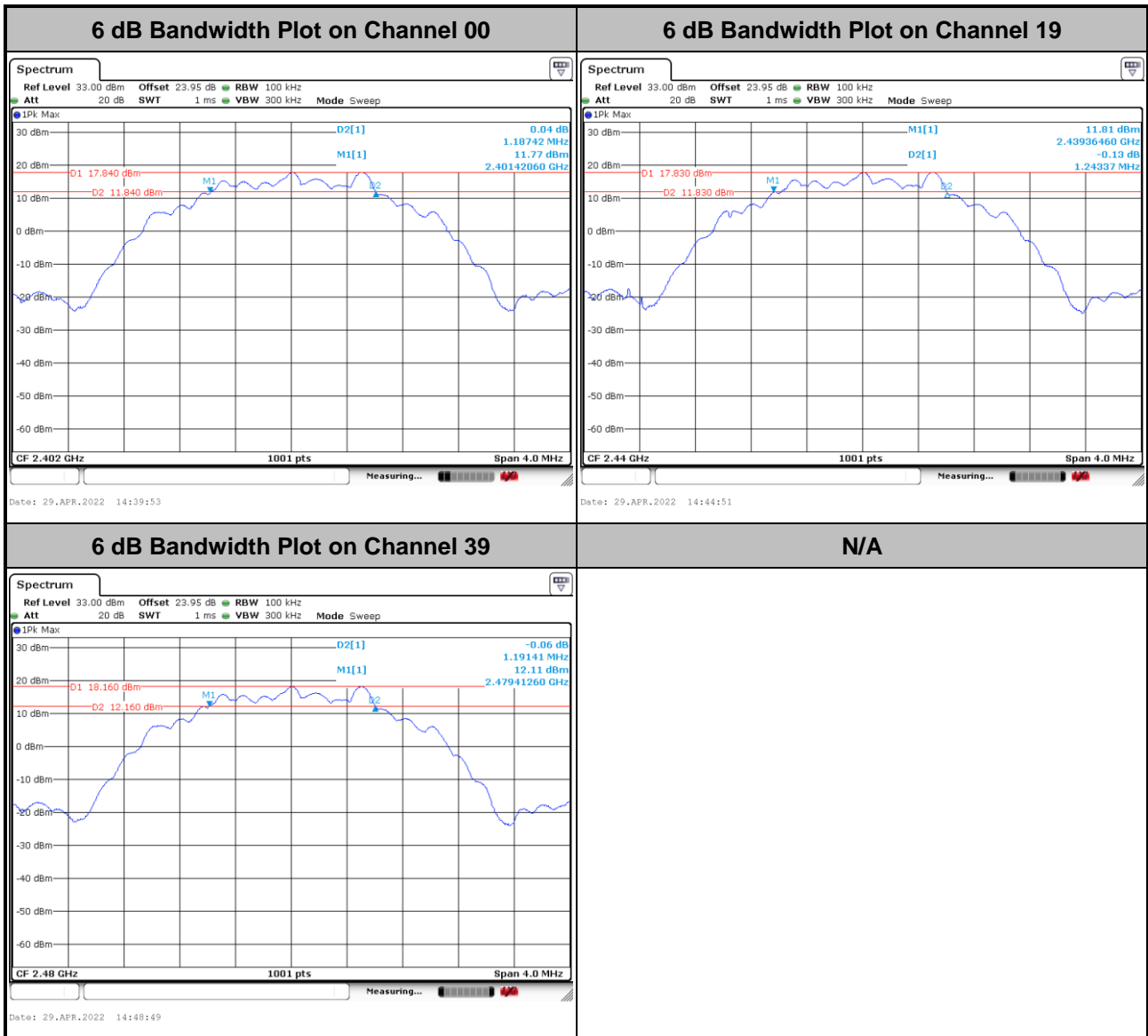



<Ant. 3>

<1Mbps>

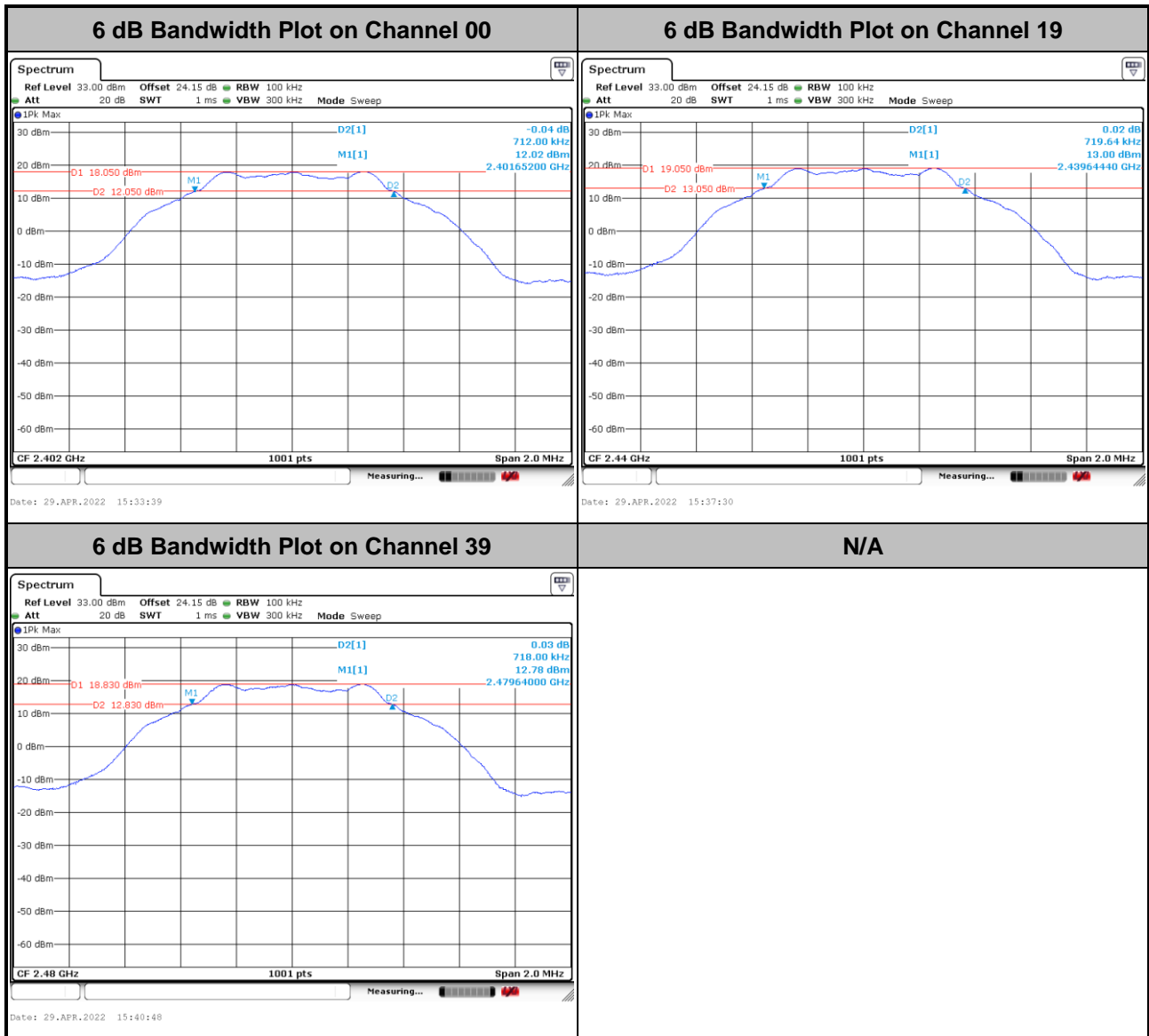



<2Mbps>

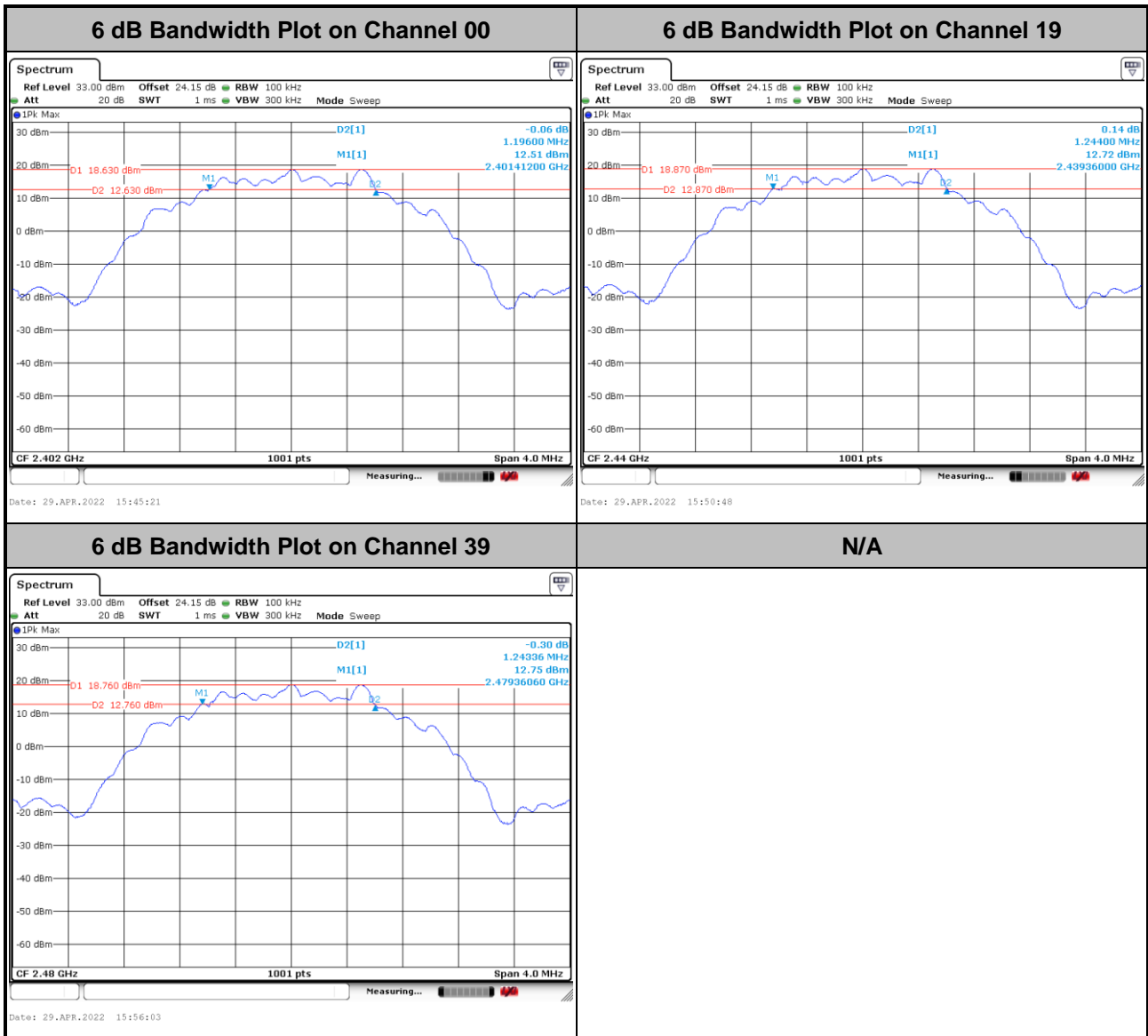



MIMO <Ant. 4>

<1Mbps>

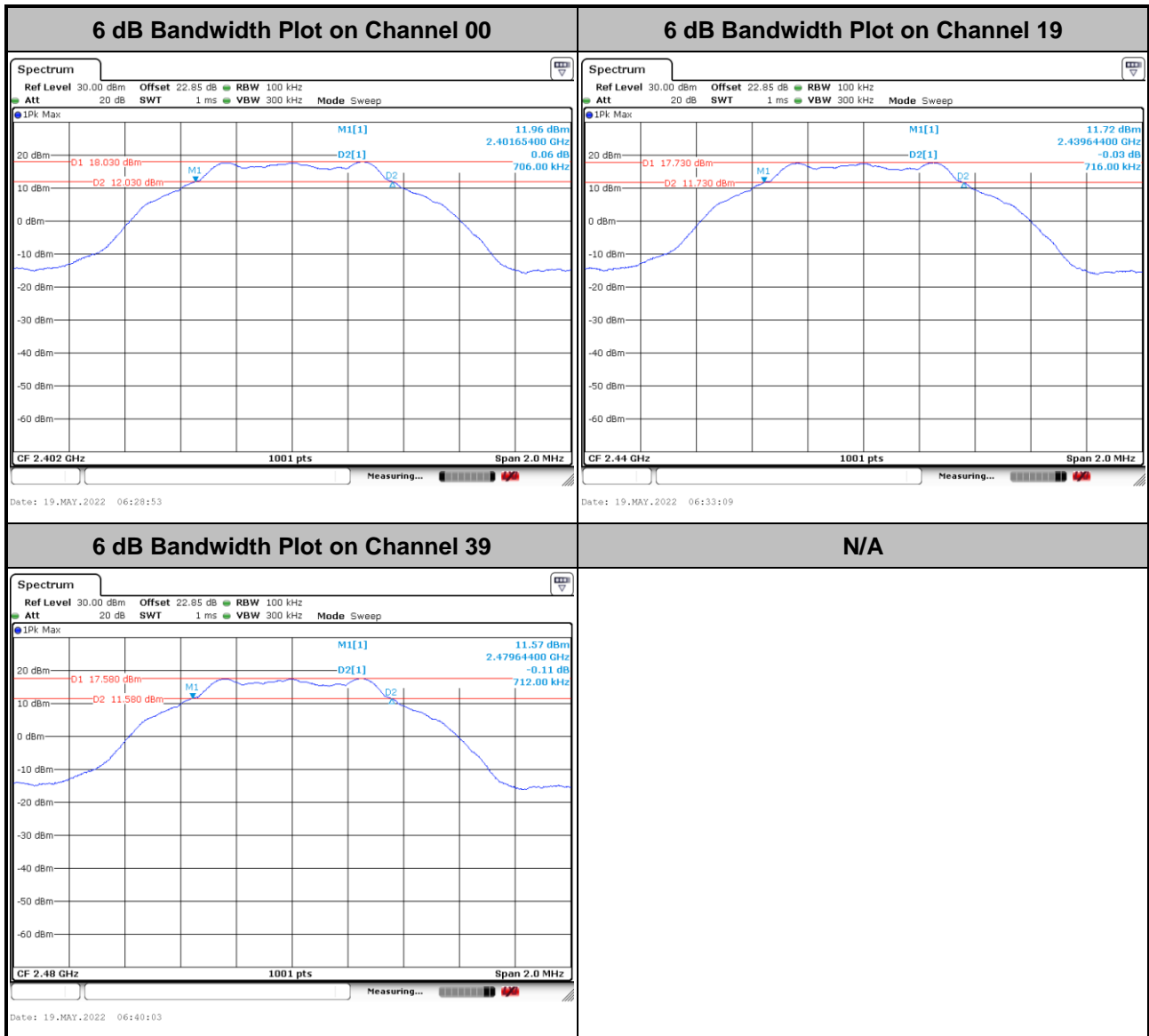



<2Mbps>

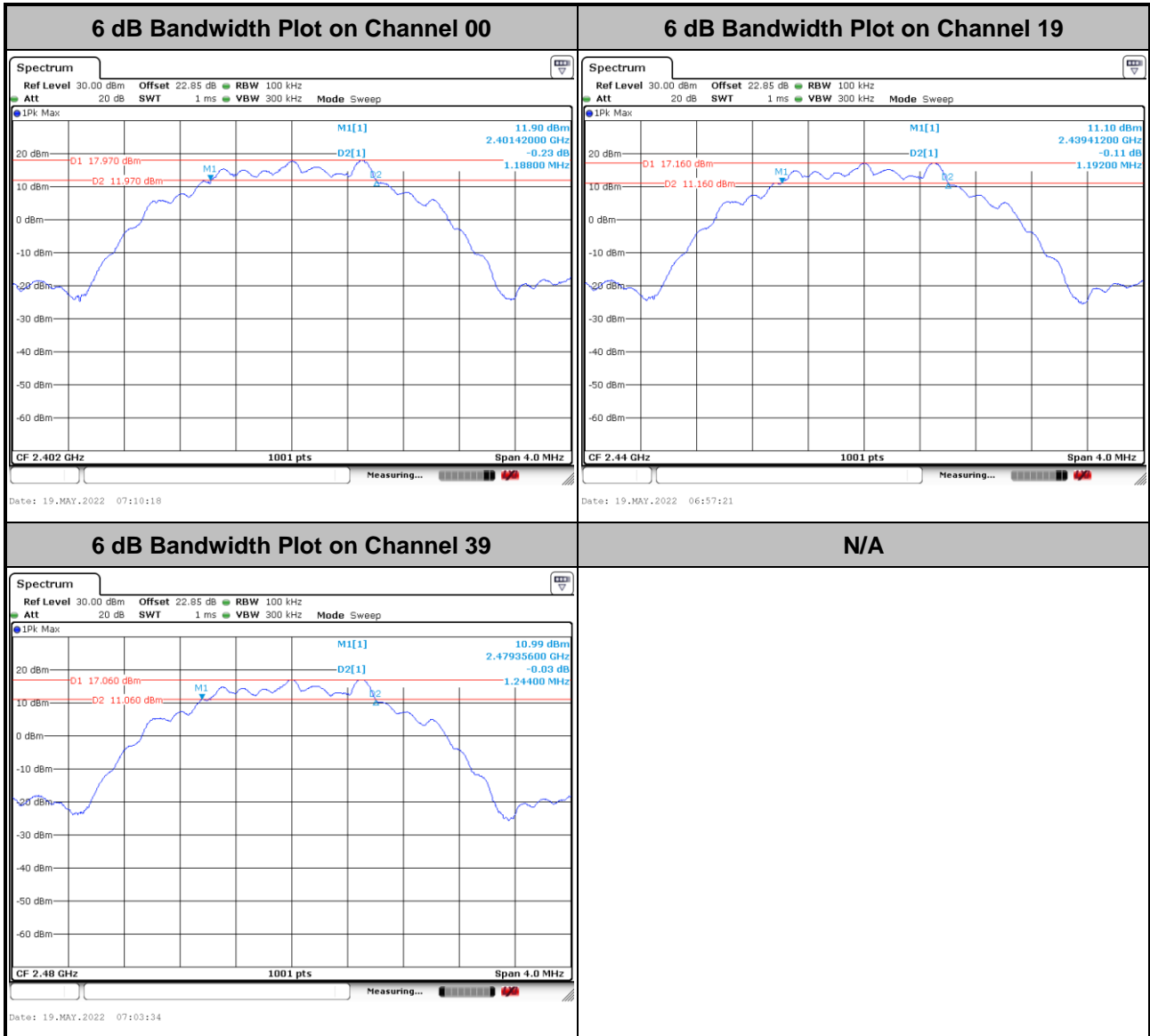



MIMO <Ant. 3>

<1Mbps>

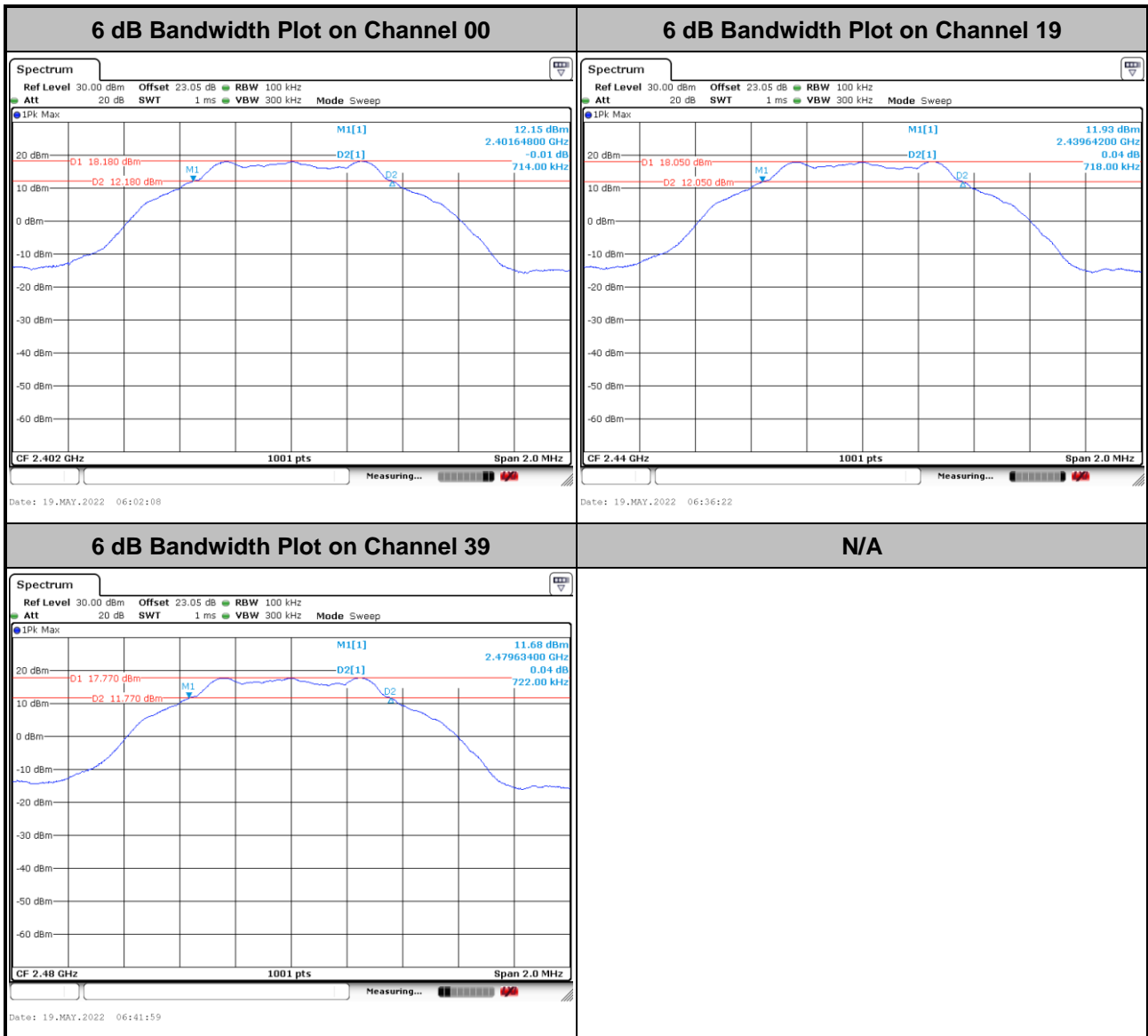



<2Mbps>

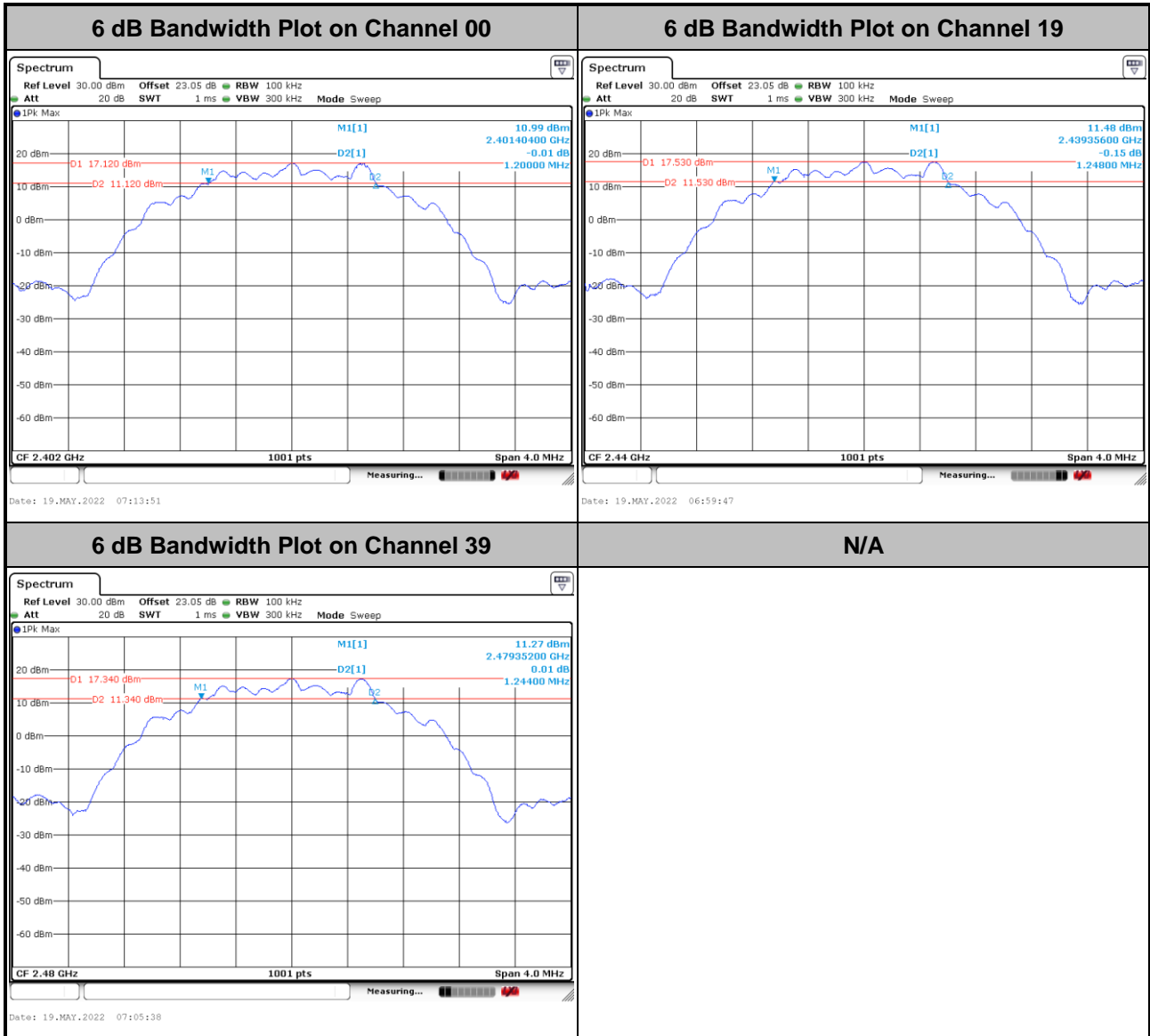



3.1.6 Test Result of 99% Occupied Bandwidth

Please refer to Appendix A.

<Ant. 4>

<1Mbps>

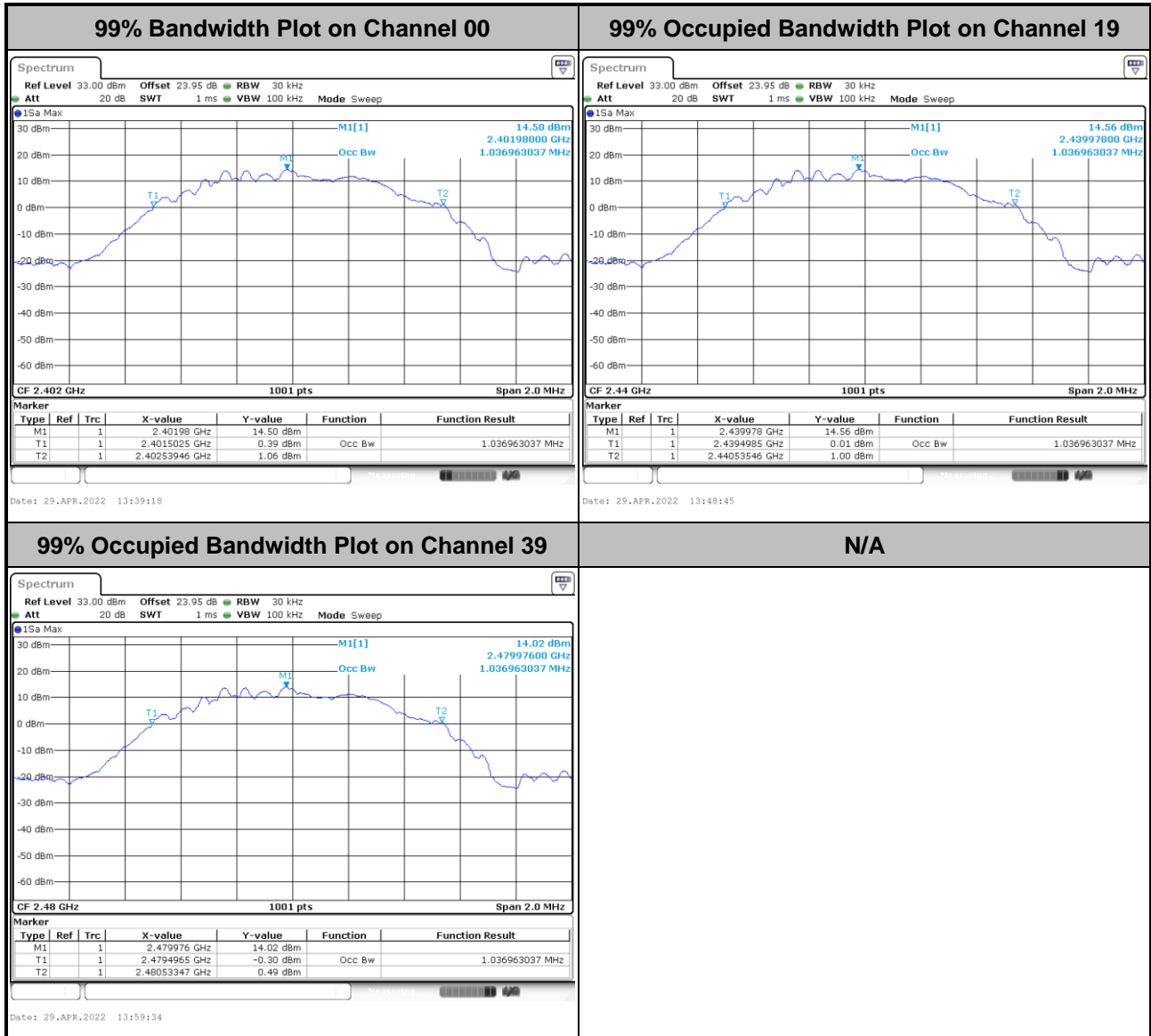

Note: The occupied channel bandwidth is maintained within the band of operation for all of the modulations.



<2Mbps>

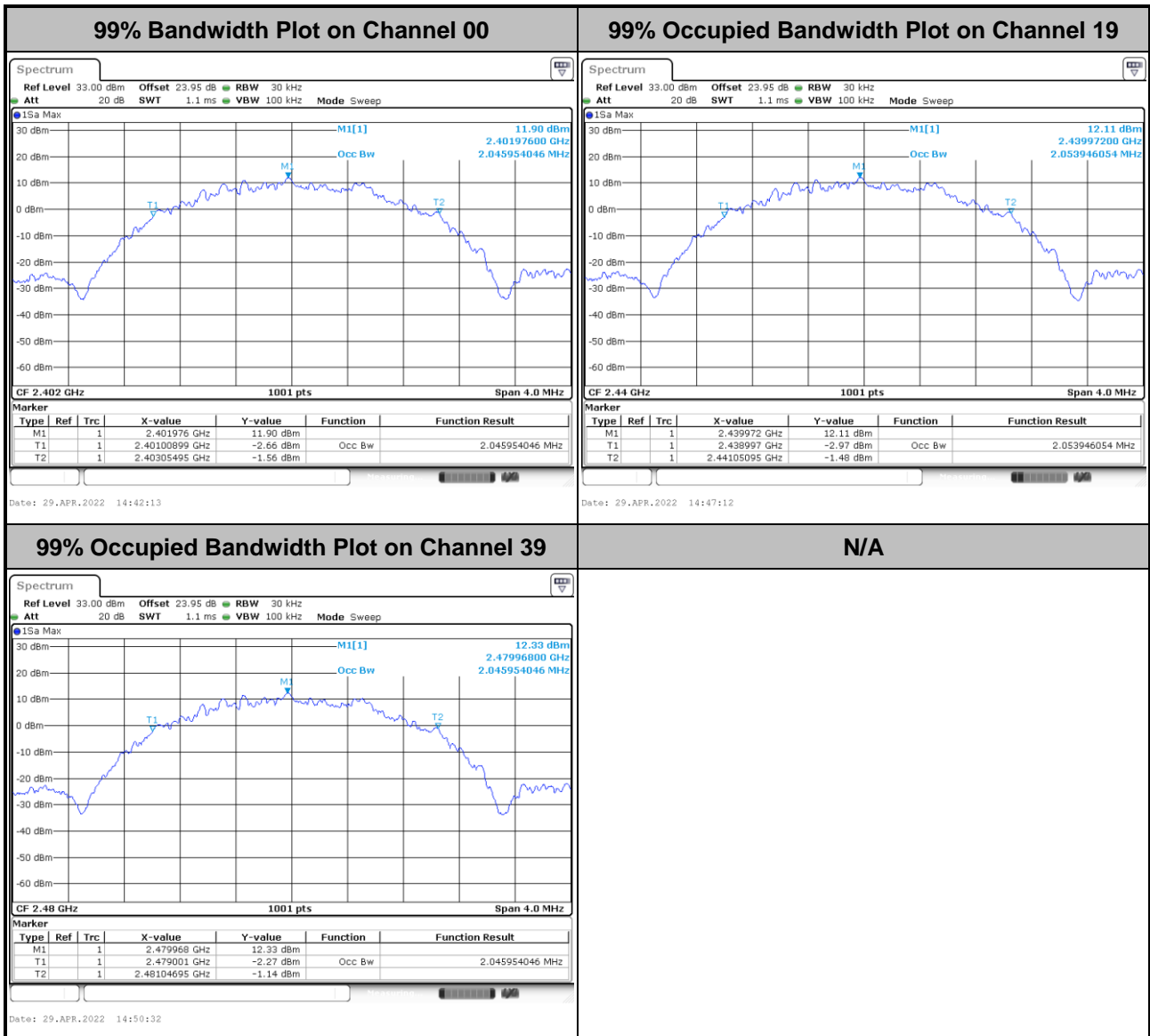

Note: The occupied channel bandwidth is maintained within the band of operation for all of the modulations.



<Ant. 3>

<1Mbps>

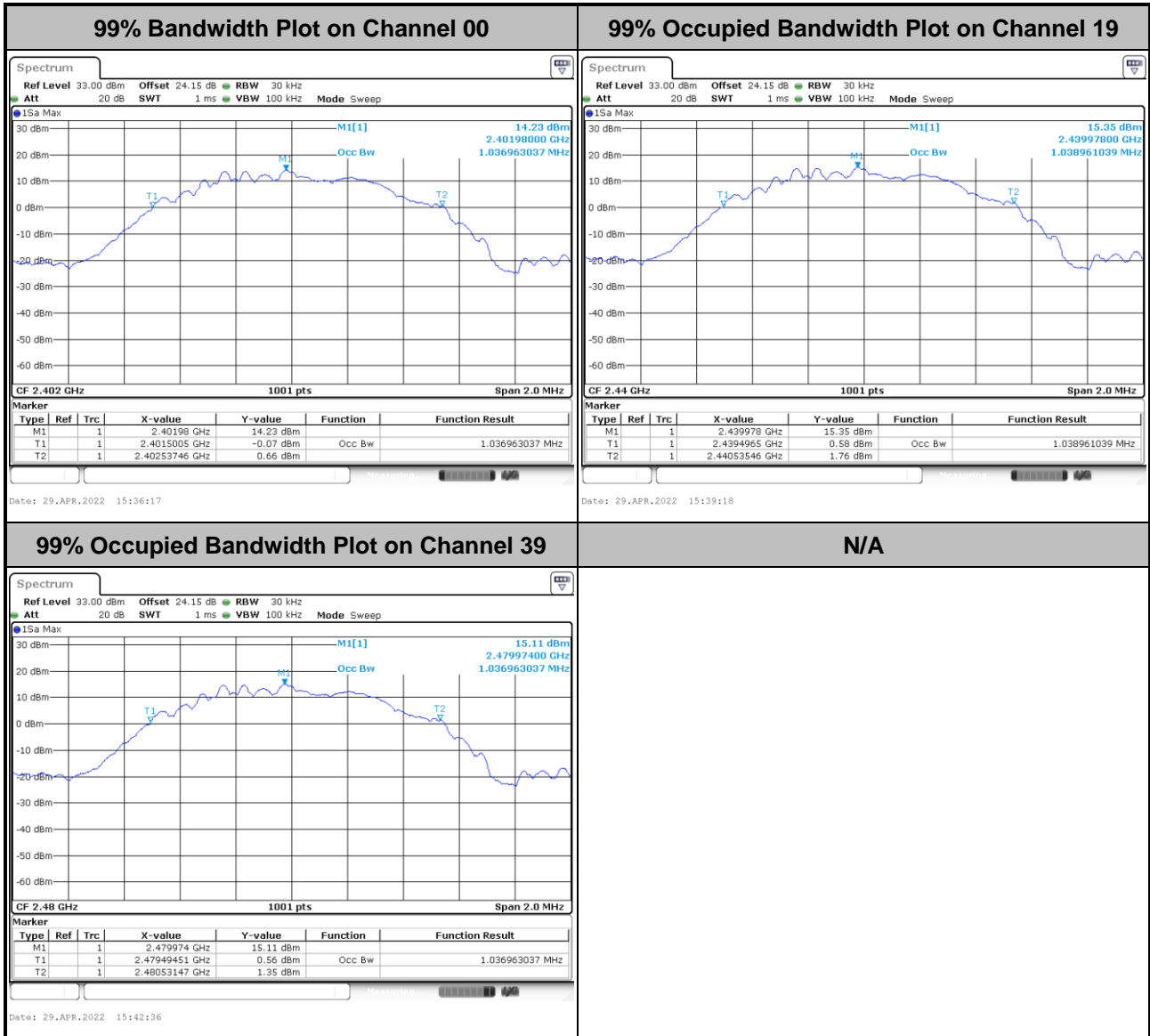

Note: The occupied channel bandwidth is maintained within the band of operation for all of the modulations.



<2Mbps>

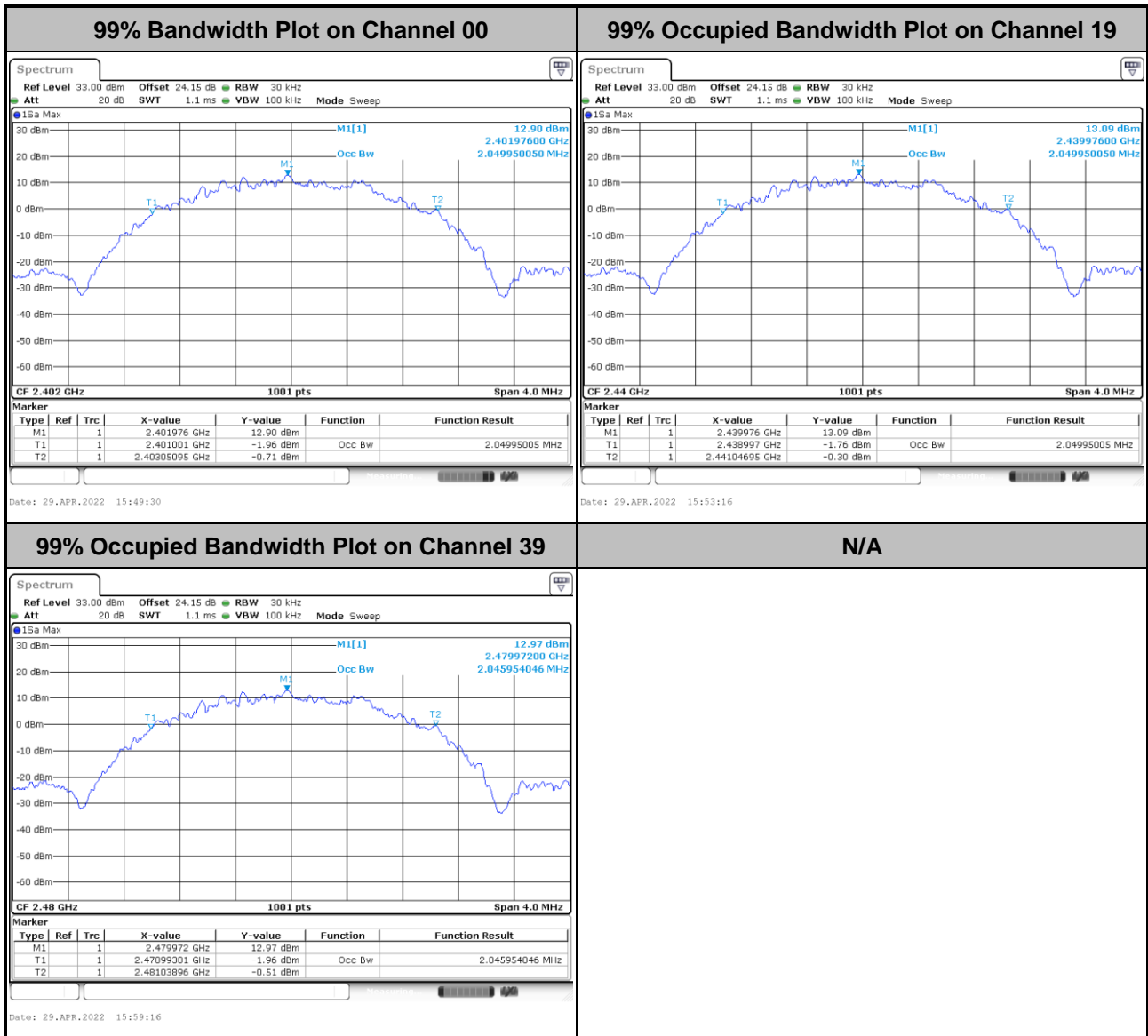

Note: The occupied channel bandwidth is maintained within the band of operation for all of the modulations.



<Ant. 4>

<1Mbps>

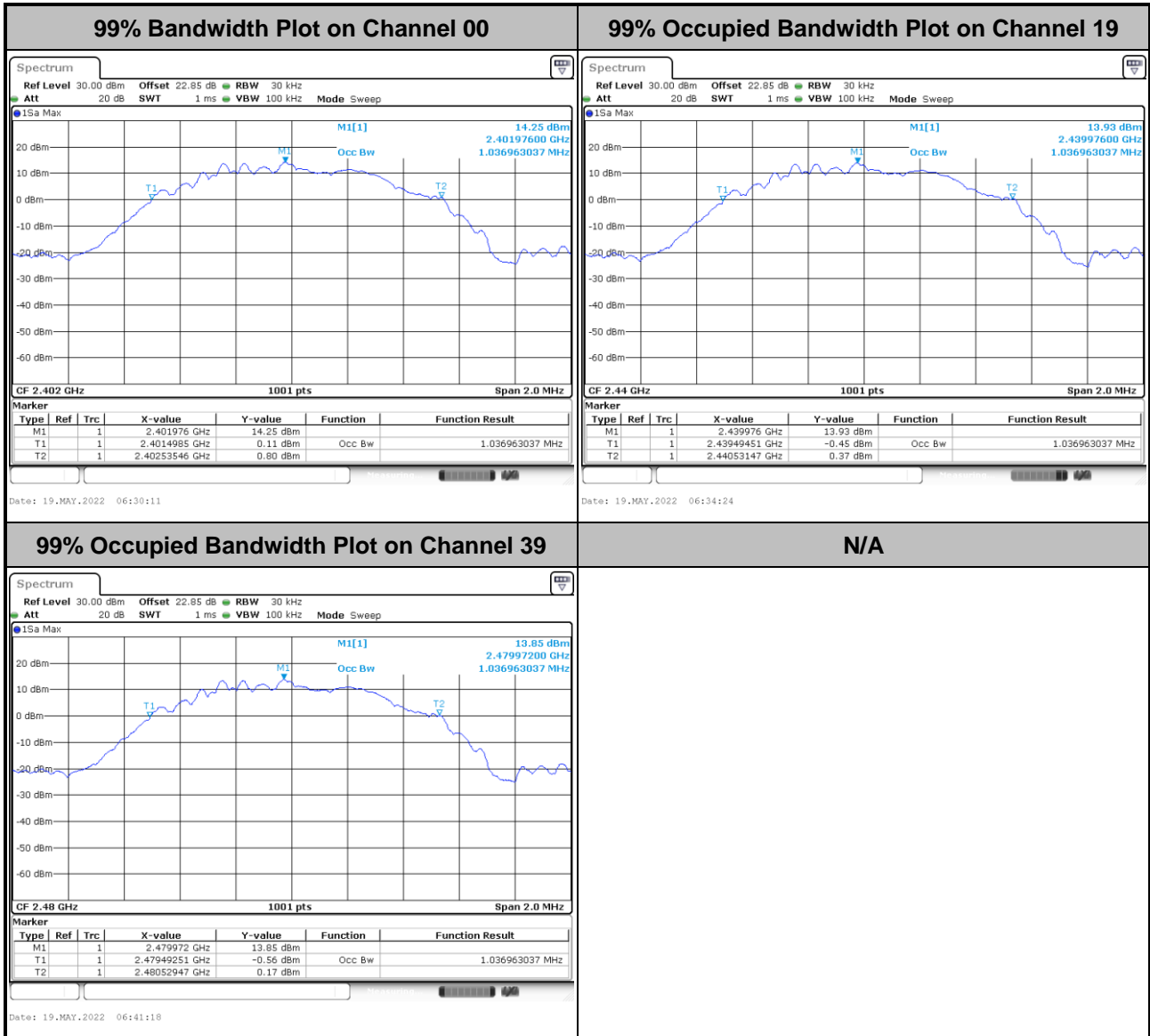

Note: The occupied channel bandwidth is maintained within the band of operation for all of the modulations.



<2Mbps>

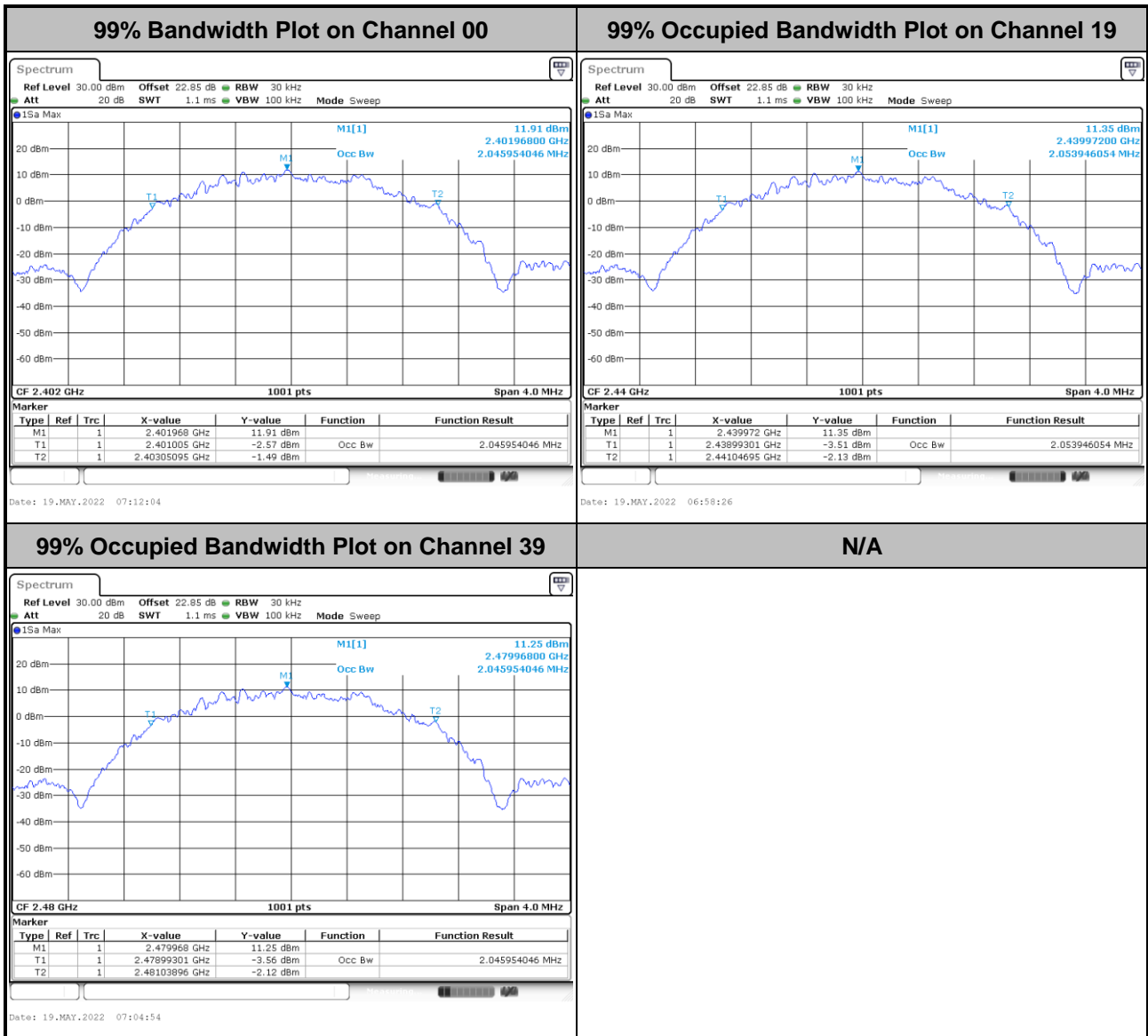

Note: The occupied channel bandwidth is maintained within the band of operation for all of the modulations.



MIMO <Ant. 3>

<1Mbps>

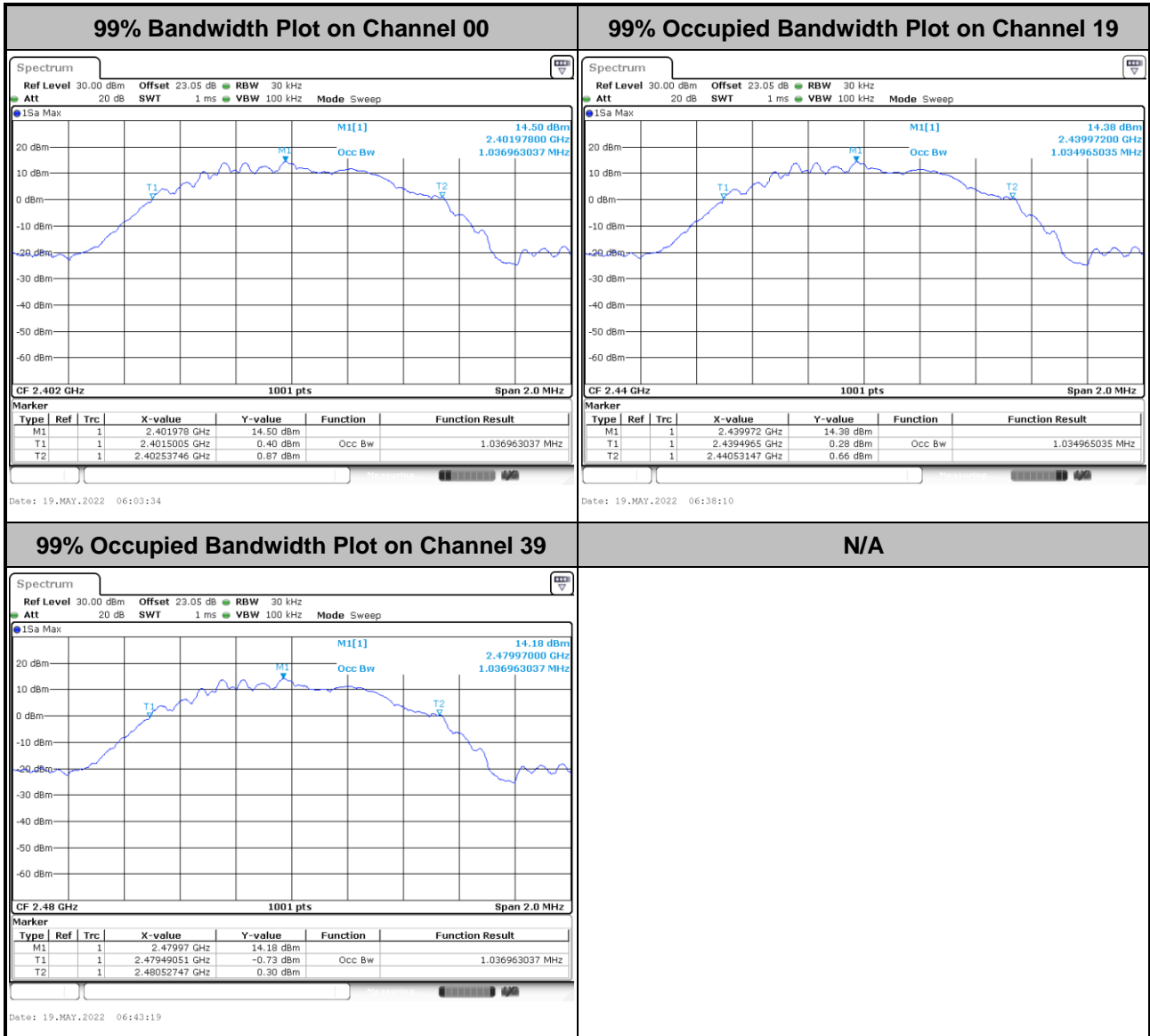

Note: The occupied channel bandwidth is maintained within the band of operation for all of the modulations.



<2Mbps>

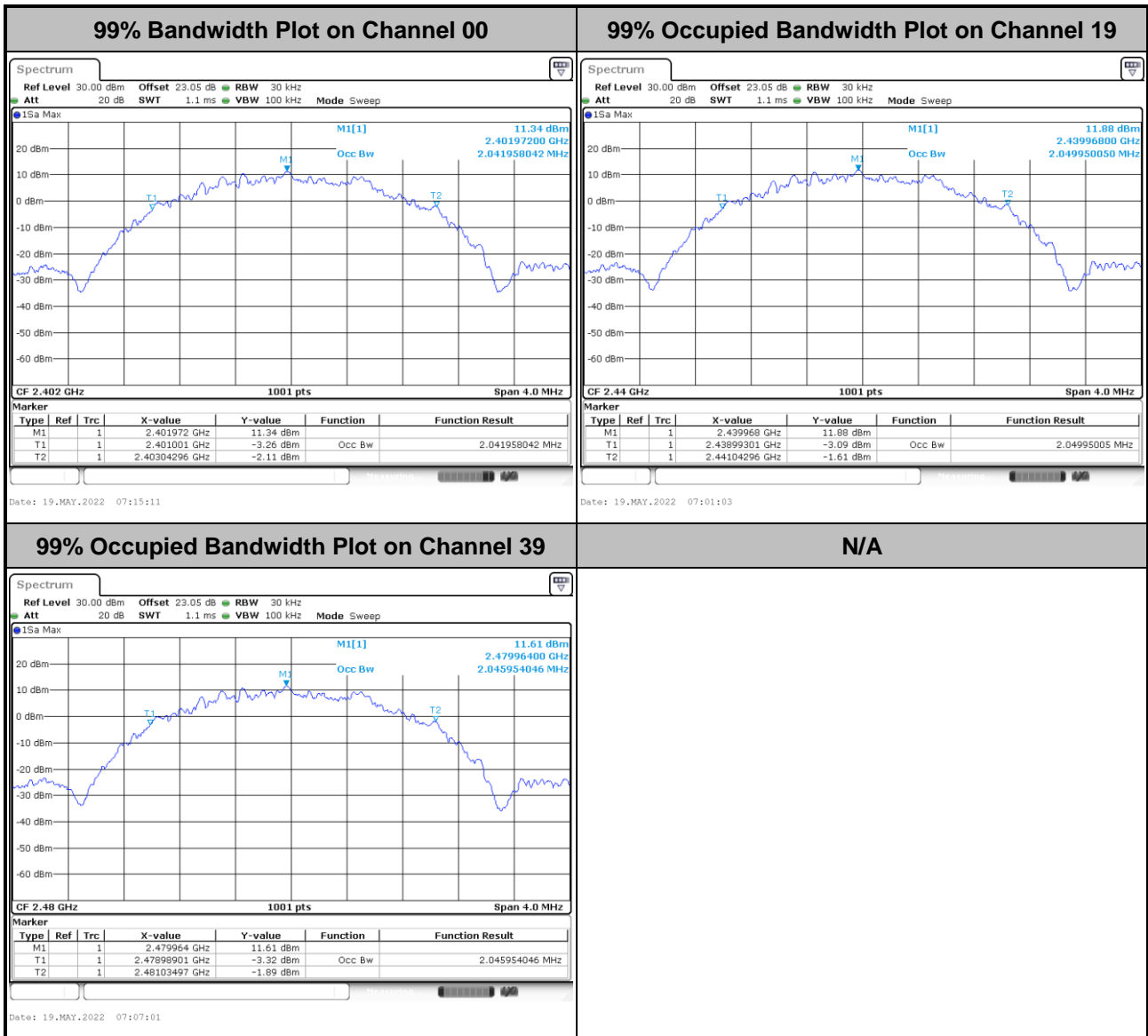

Note: The occupied channel bandwidth is maintained within the band of operation for all of the modulations.

3.2 Output Power Measurement

3.2.1 Limit of Output Power

For systems using digital modulation in the 2400-2483.5 MHz, the limit for output power is 30 dBm. If transmitting antenna of directional gain greater than 6 dBi is used, the peak output power from the intentional radiator shall be reduced below the above stated value by the amount in dB that the directional gain of the antenna exceeds 6 dBi. In case of point-to-point operation, the limit has to be reduced by 1 dB for every 3 dB that the directional gain of the antenna exceeds 6 dBi.

3.2.2 Measuring Instruments

Please refer to the measuring equipment list in this test report.

3.2.3 Test Procedures

1. For Average Power, the testing follows ANSI C63.10 Section 11.9.2.3.2 Method AVGPM-G
2. The RF output of EUT is connected to the power meter by RF cable and attenuator.
3. The path loss is compensated to the results for each measurement.
4. Set the maximum power setting and enable the EUT to transmit continuously.
5. Measure the conducted output power and record the results in the test report.

3.2.4 Test Setup

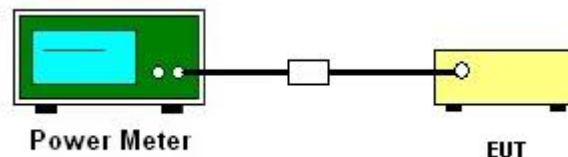

3.2.5 Test Result of Average Output Power

Please refer to Appendix A.

3.3 Power Spectral Density Measurement

3.3.1 Limit of Power Spectral Density

The peak power spectral density shall not be greater than 8 dBm in any 3 kHz band at any time interval of continuous transmission.

3.3.2 Measuring Instruments

Please refer to the measuring equipment list in this test report.

3.3.3 Test Procedures

1. The testing follows the ANSI C63.10 Section 11.10.2 Method PKPSD.
2. The RF output of EUT is connected to the spectrum analyzer by RF cable and attenuator. The path loss is compensated to the results for each measurement.
3. Set the maximum power setting and enable the EUT to transmit continuously.
4. Make the measurement with the spectrum analyzer's resolution bandwidth (RBW) = 3 kHz. Video bandwidth (VBW) = 10 kHz. In order to make an accurate measurement, set the span to 1.5 times DTS Channel Bandwidth. (6 dB BW)
5. Detector = peak, Sweep time = auto couple, Trace mode = max hold, Allow trace to fully stabilize. Use the peak marker function to determine the maximum power level.
6. Measure and record the results in the test report.
7. The Measured power density (dBm)/ 100 kHz is a reference level and is used as 20 dBc down limit line for Conducted Band Edges and Conducted Spurious Emission.

3.3.4 Test Setup



3.3.5 Test Result of Power Spectral Density

Please refer to Appendix A.



3.3.6 Test Result of Power Spectral Density Plots (100kHz)

<Ant. 4>

<1Mbps>

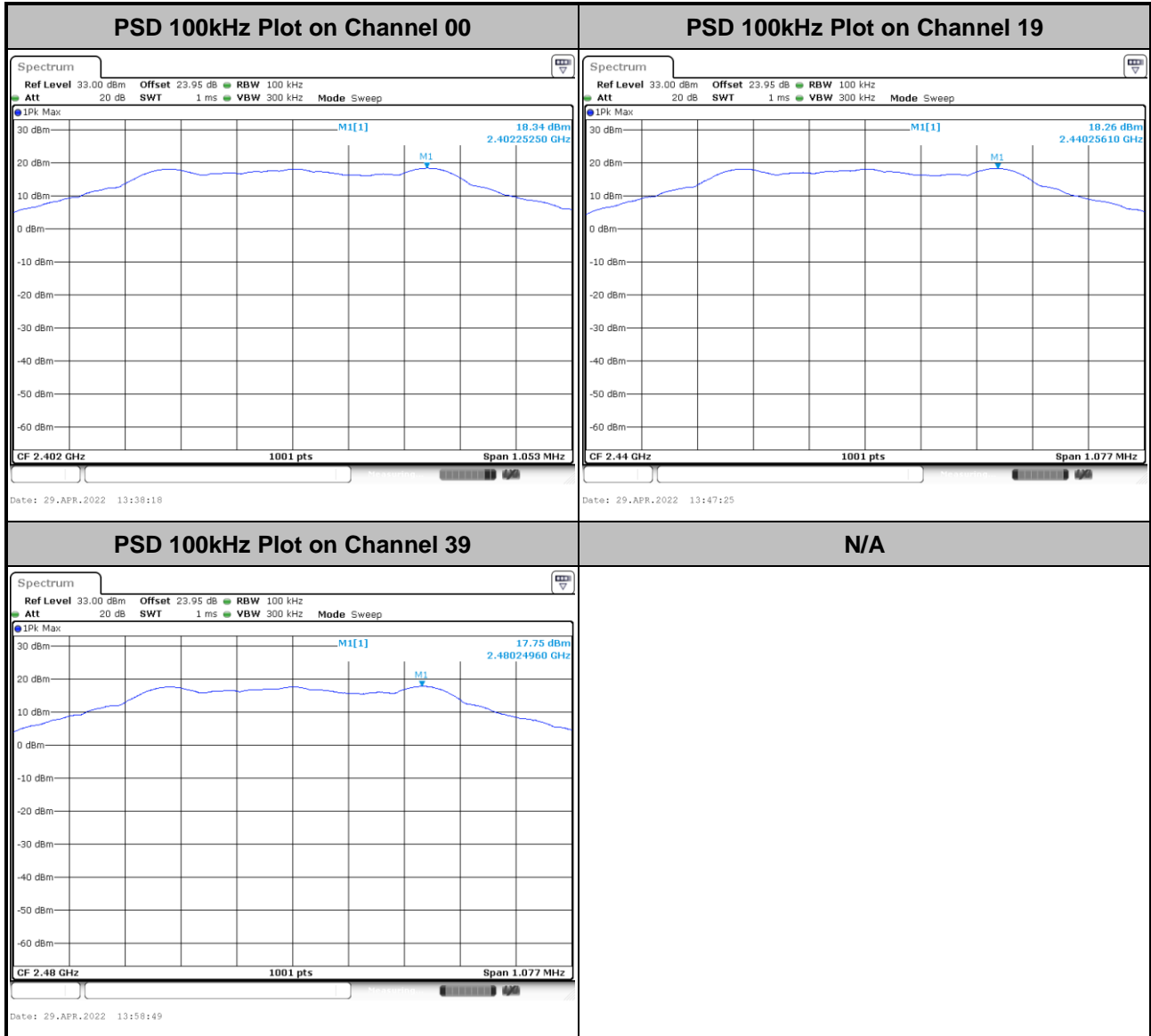



<2Mbps>

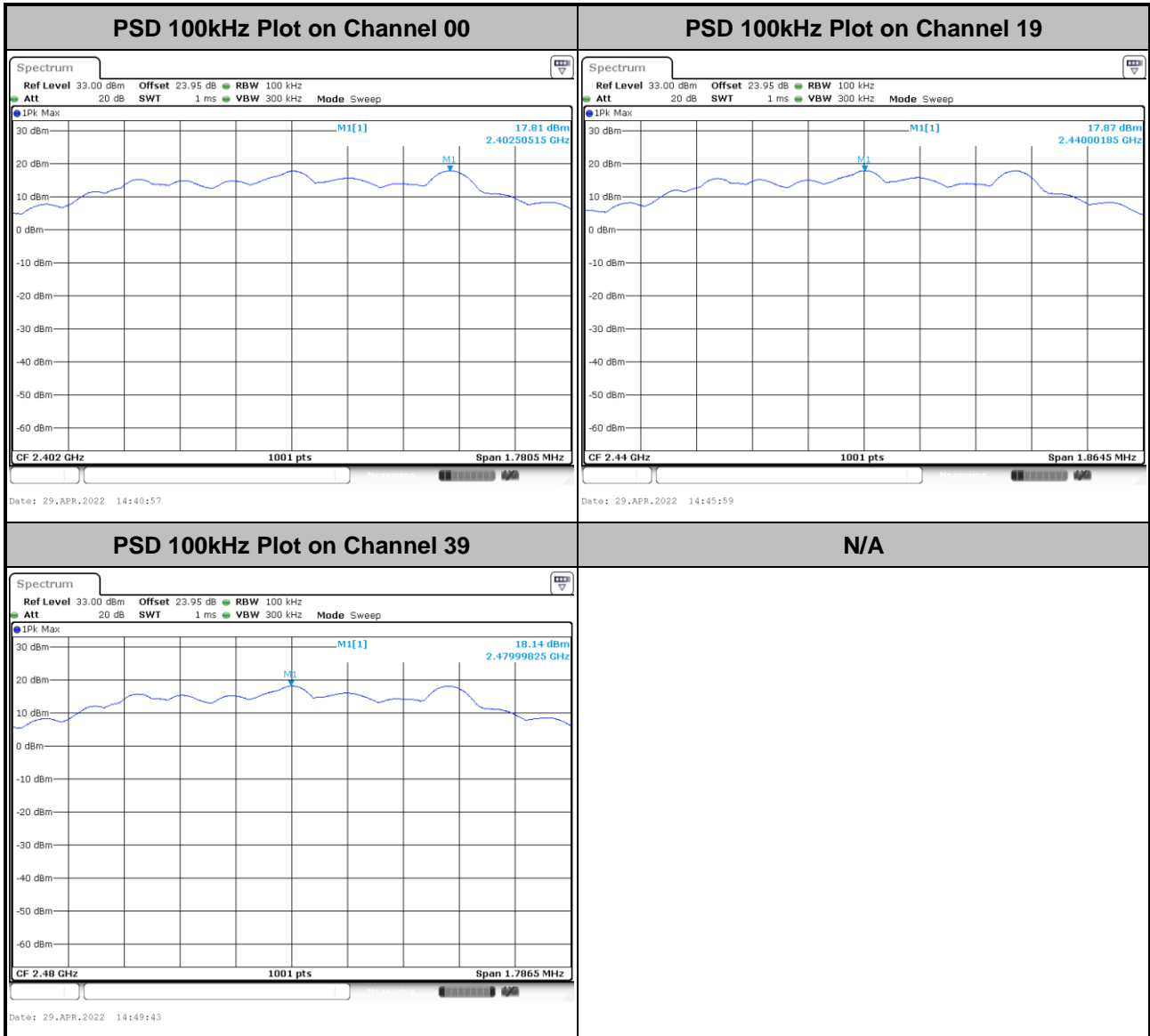



<Ant. 3>

<1Mbps>

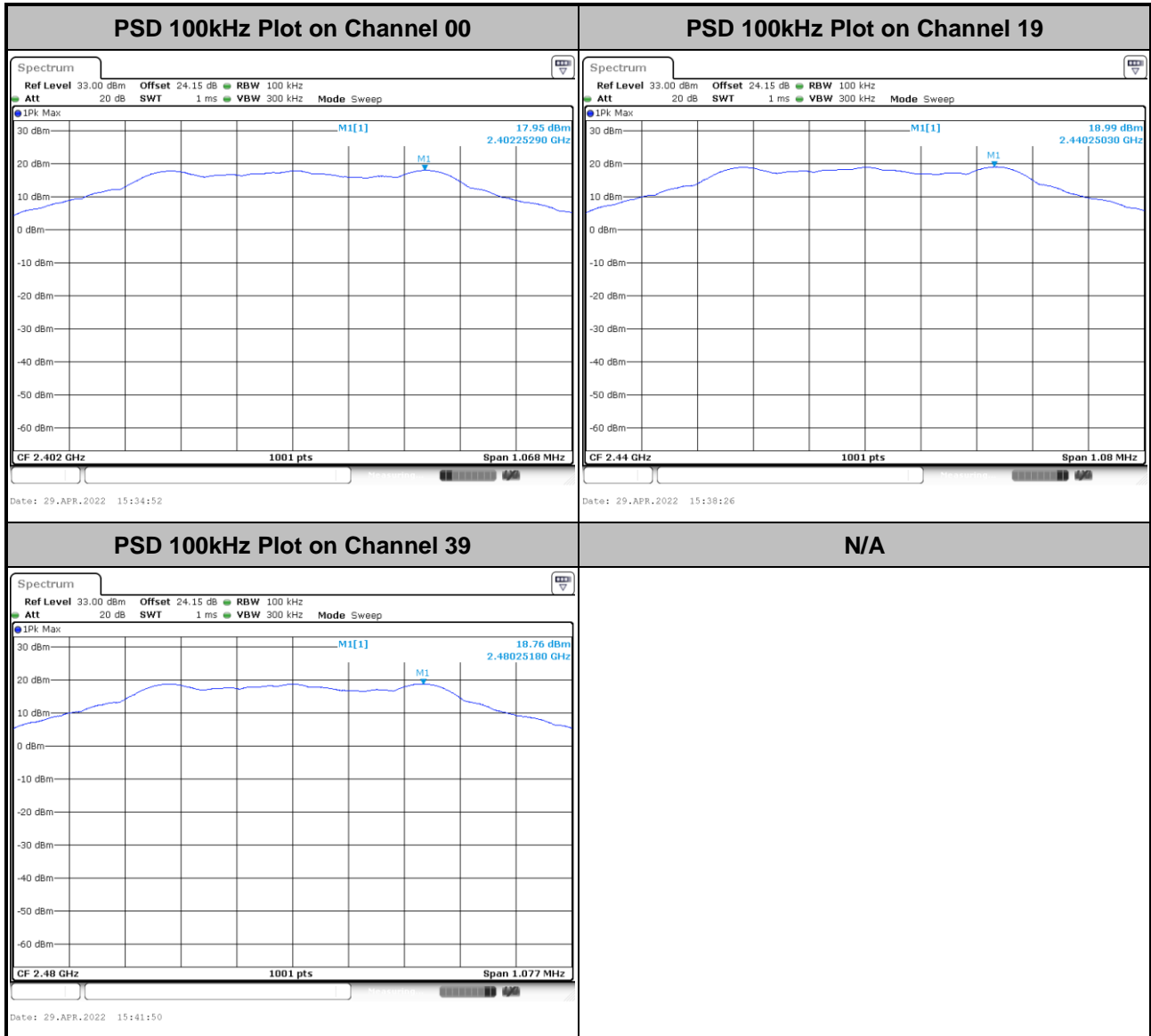



<2Mbps>

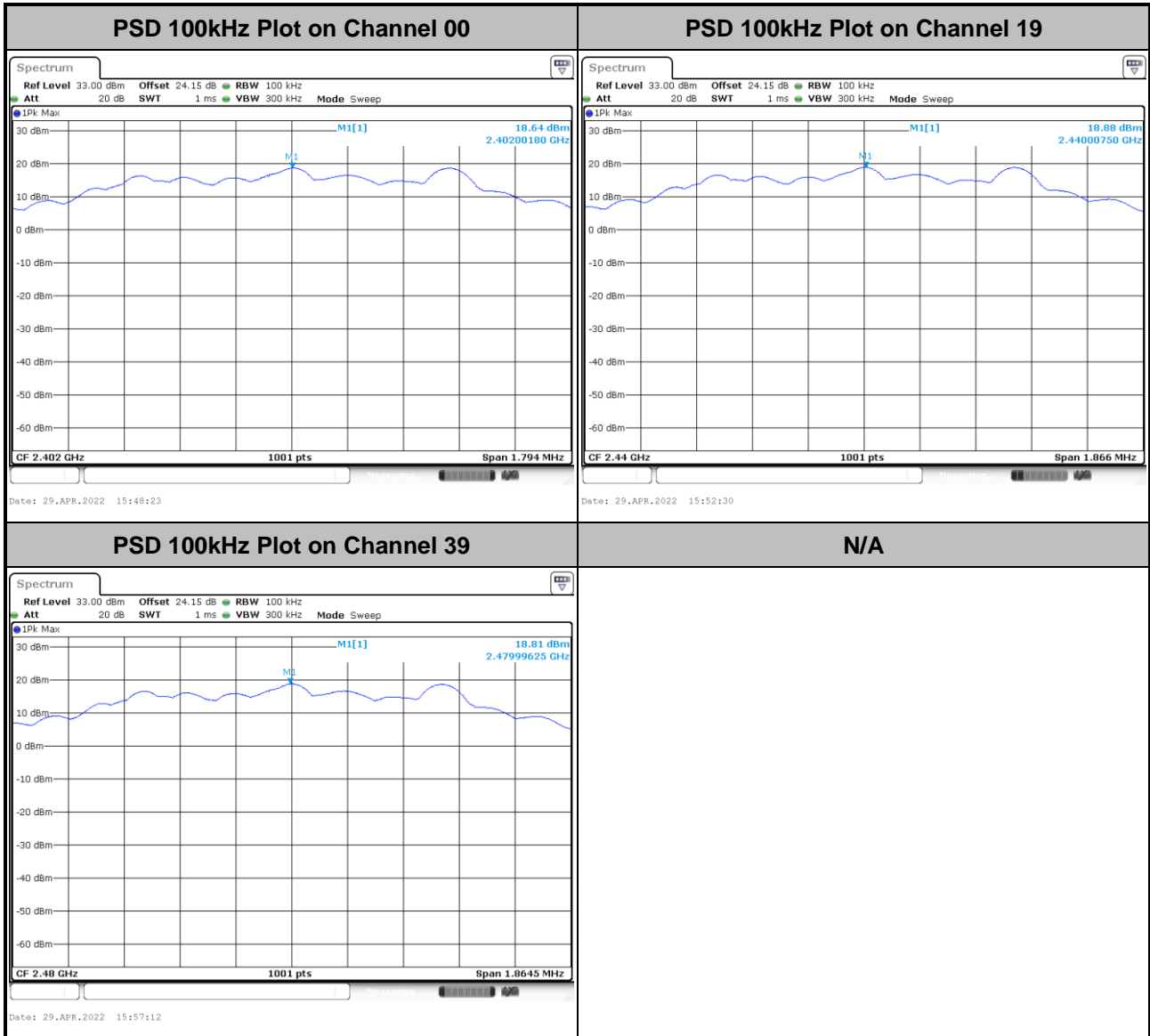



MIMO <Ant. 4>

<1Mbps>

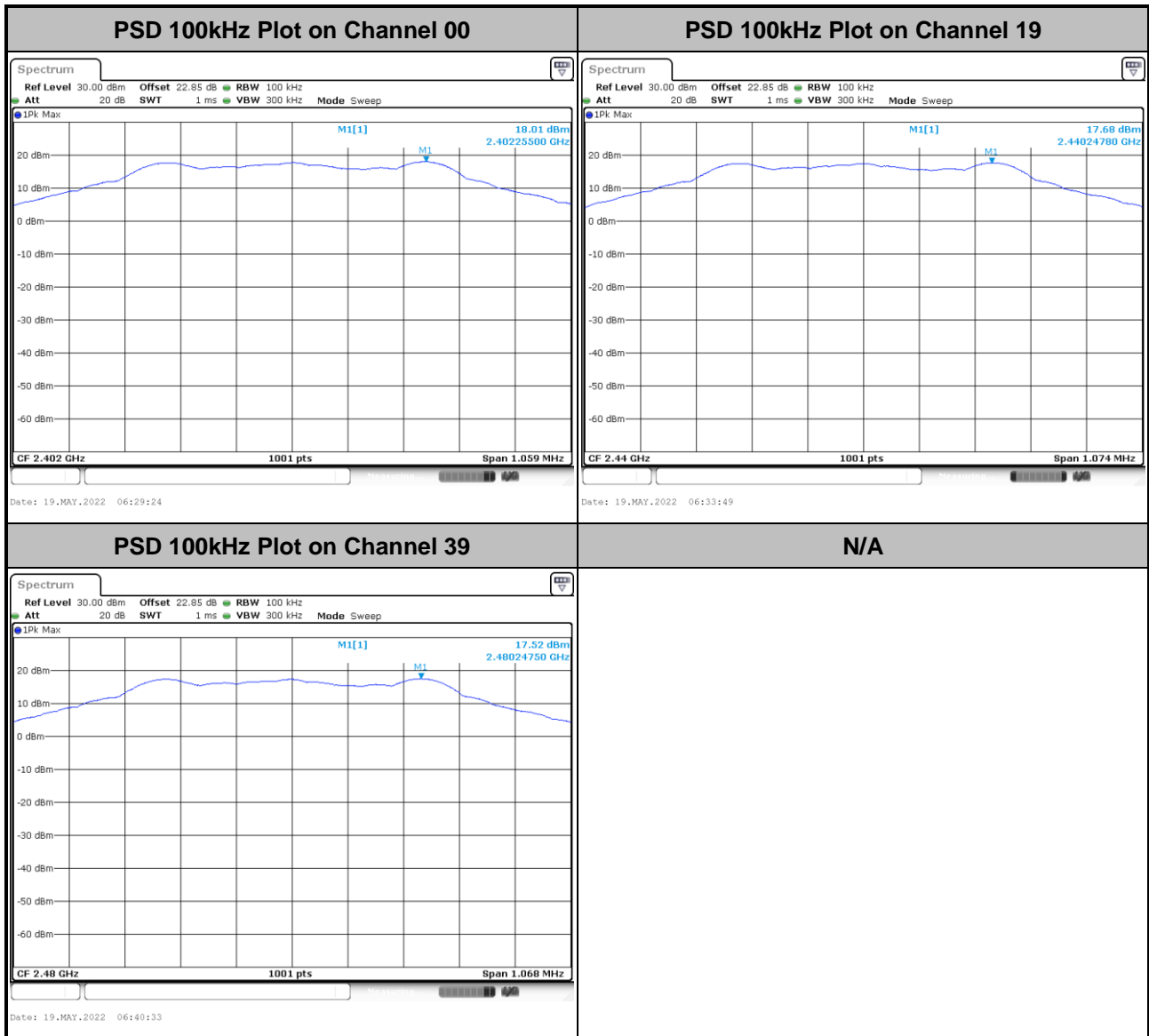



<2Mbps>

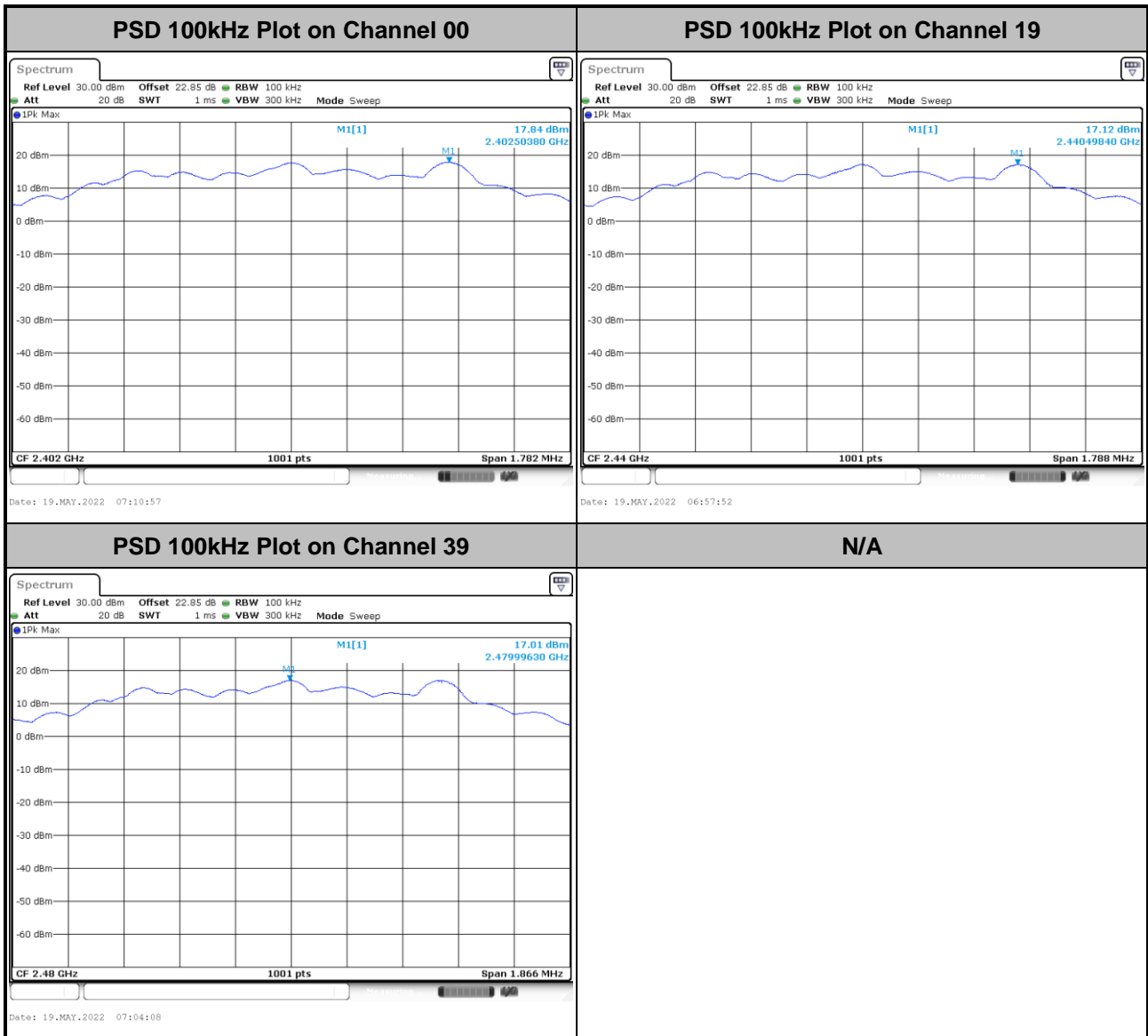



MIMO <Ant. 3>

<1Mbps>

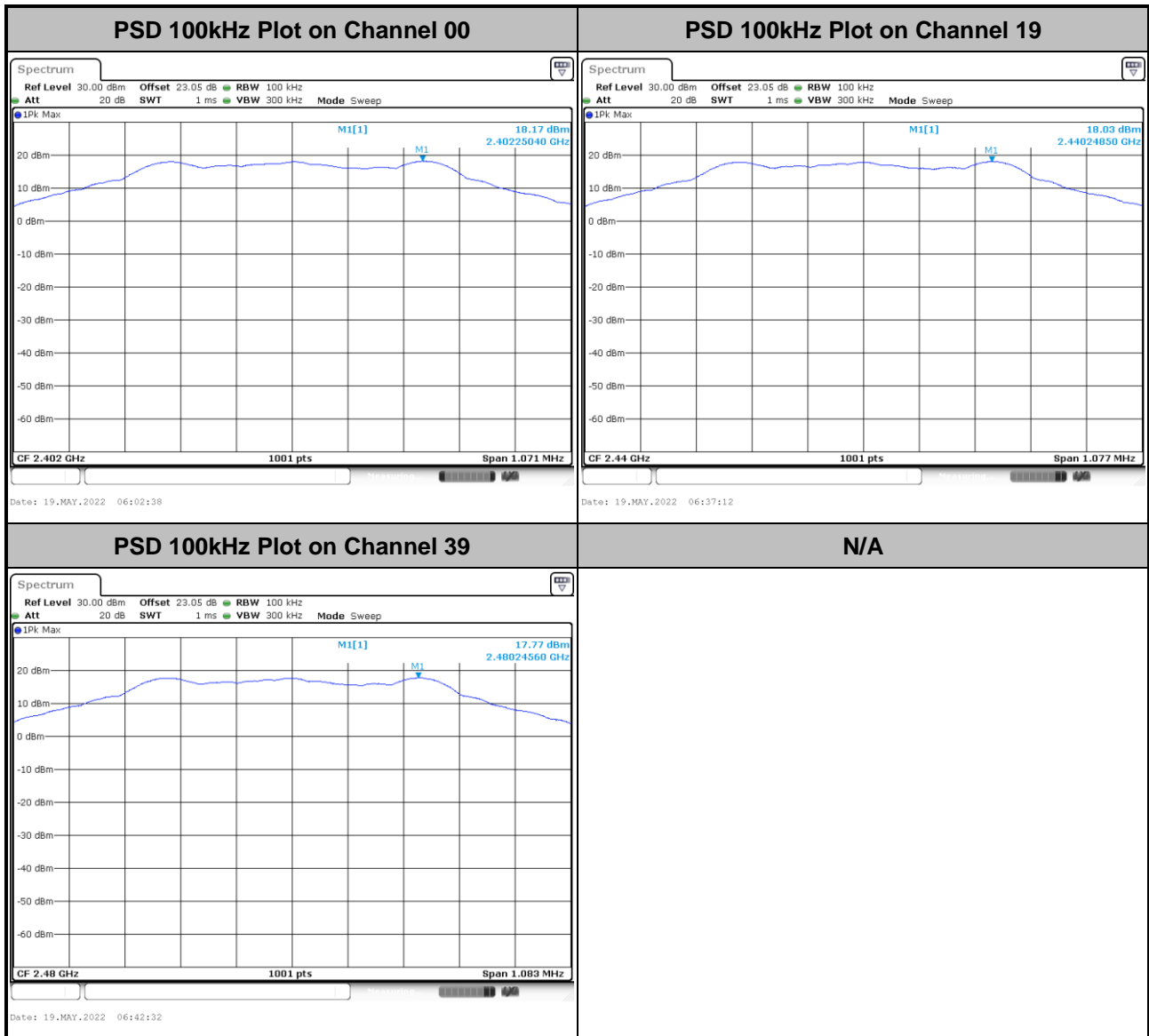



<2Mbps>

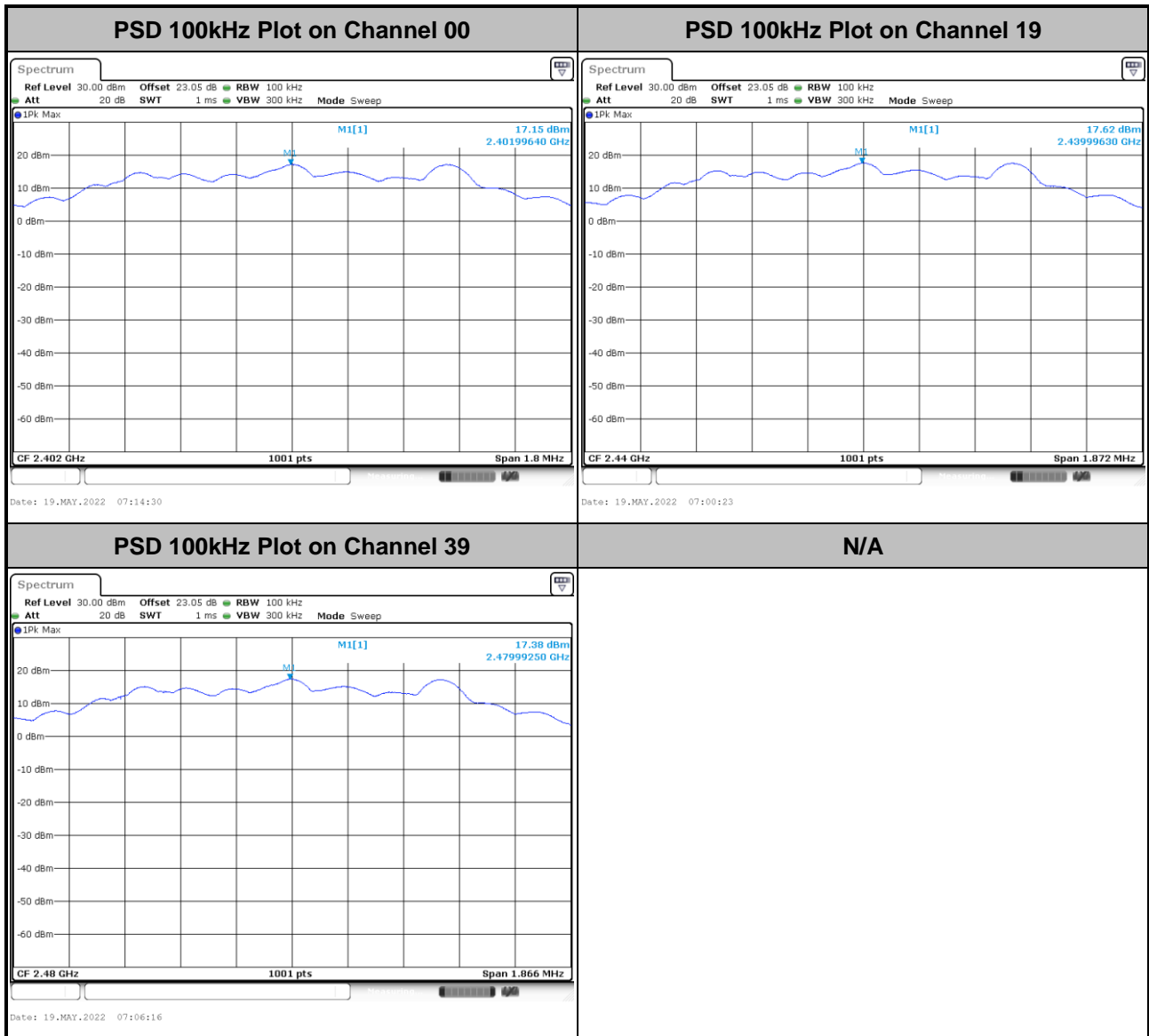



3.3.7 Test Result of Power Spectral Density Plots (3kHz)

<Ant. 4>

<1Mbps>

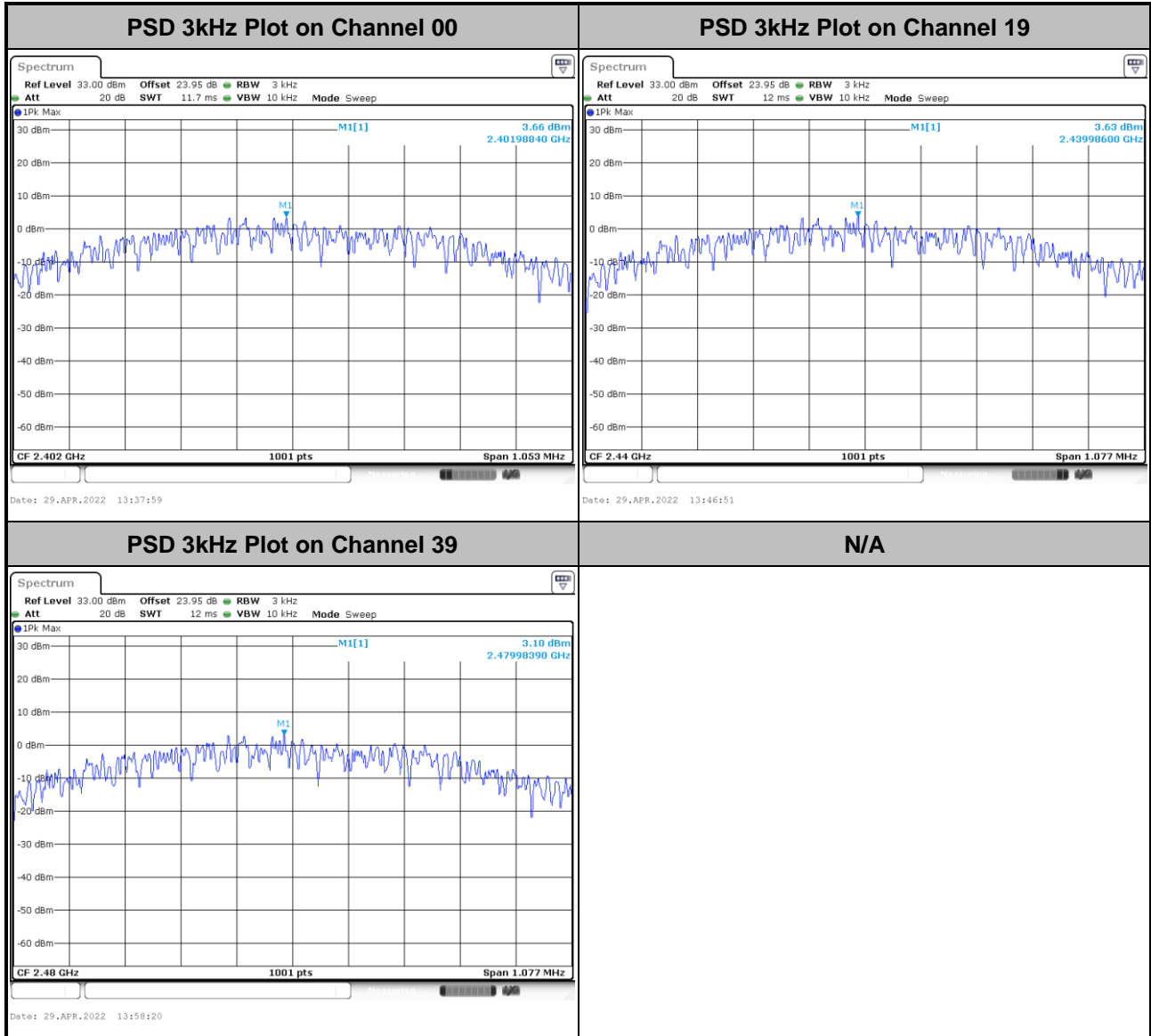



<2Mbps>

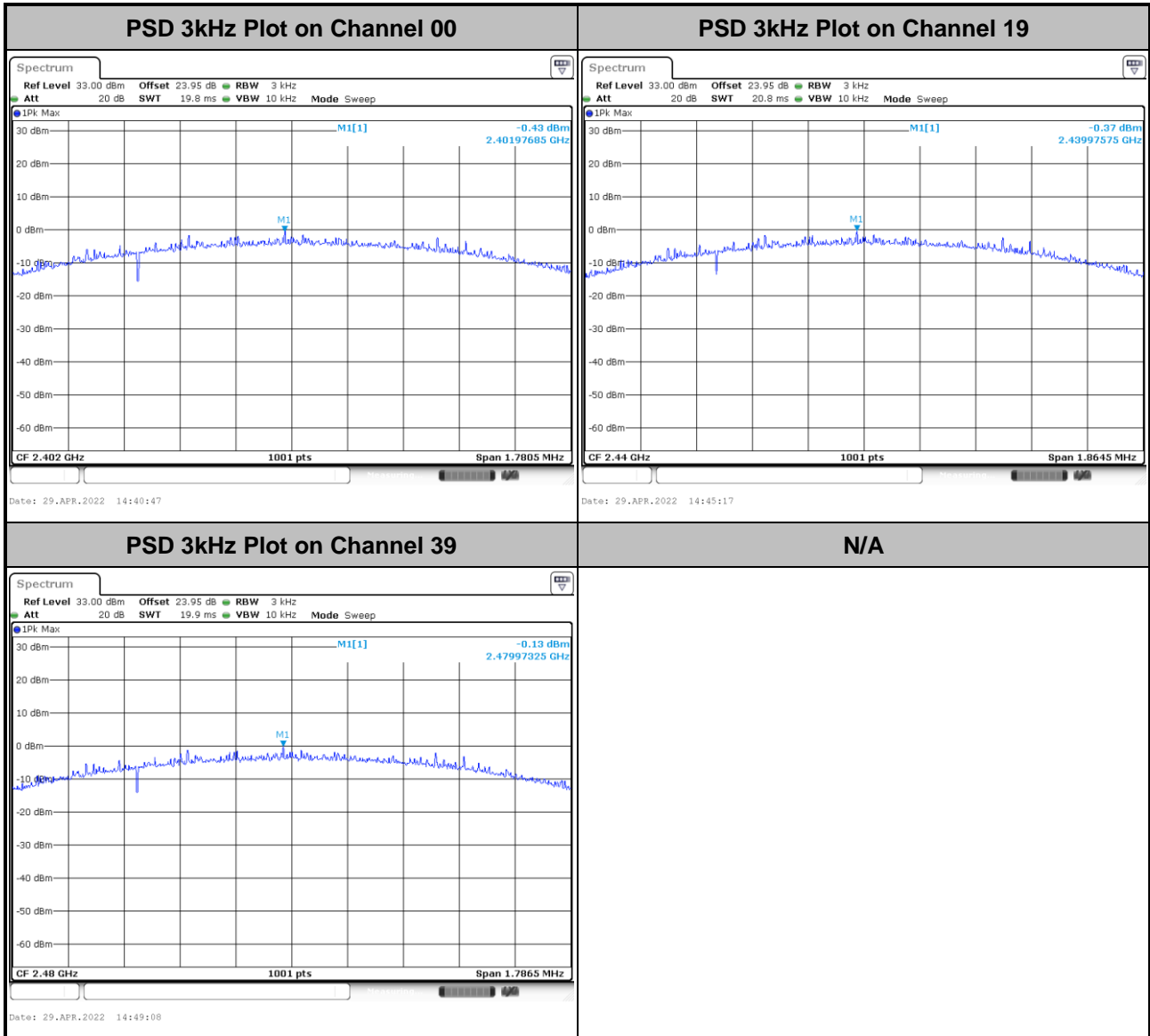



<Ant. 3>

<1Mbps>

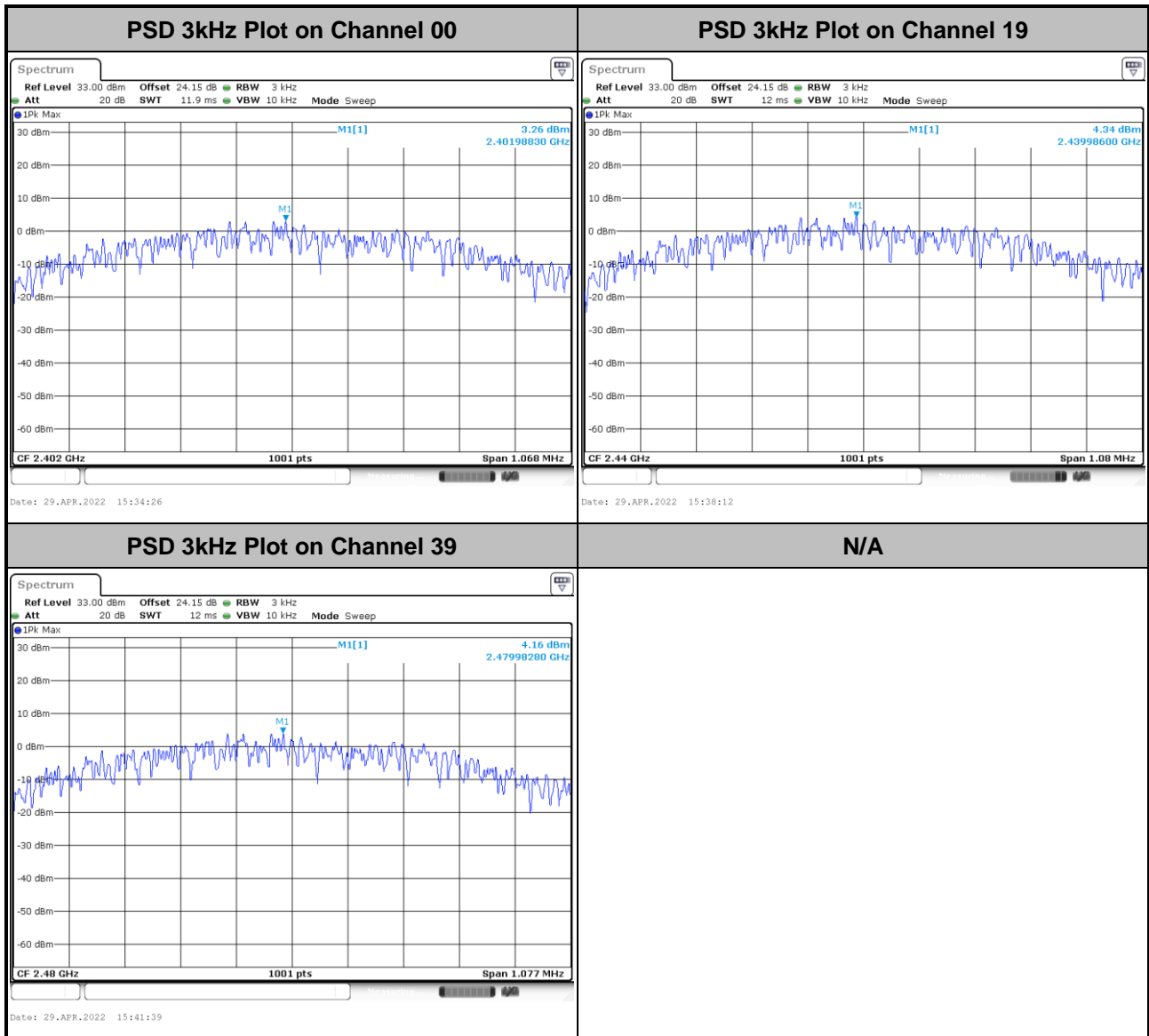



<2Mbps>

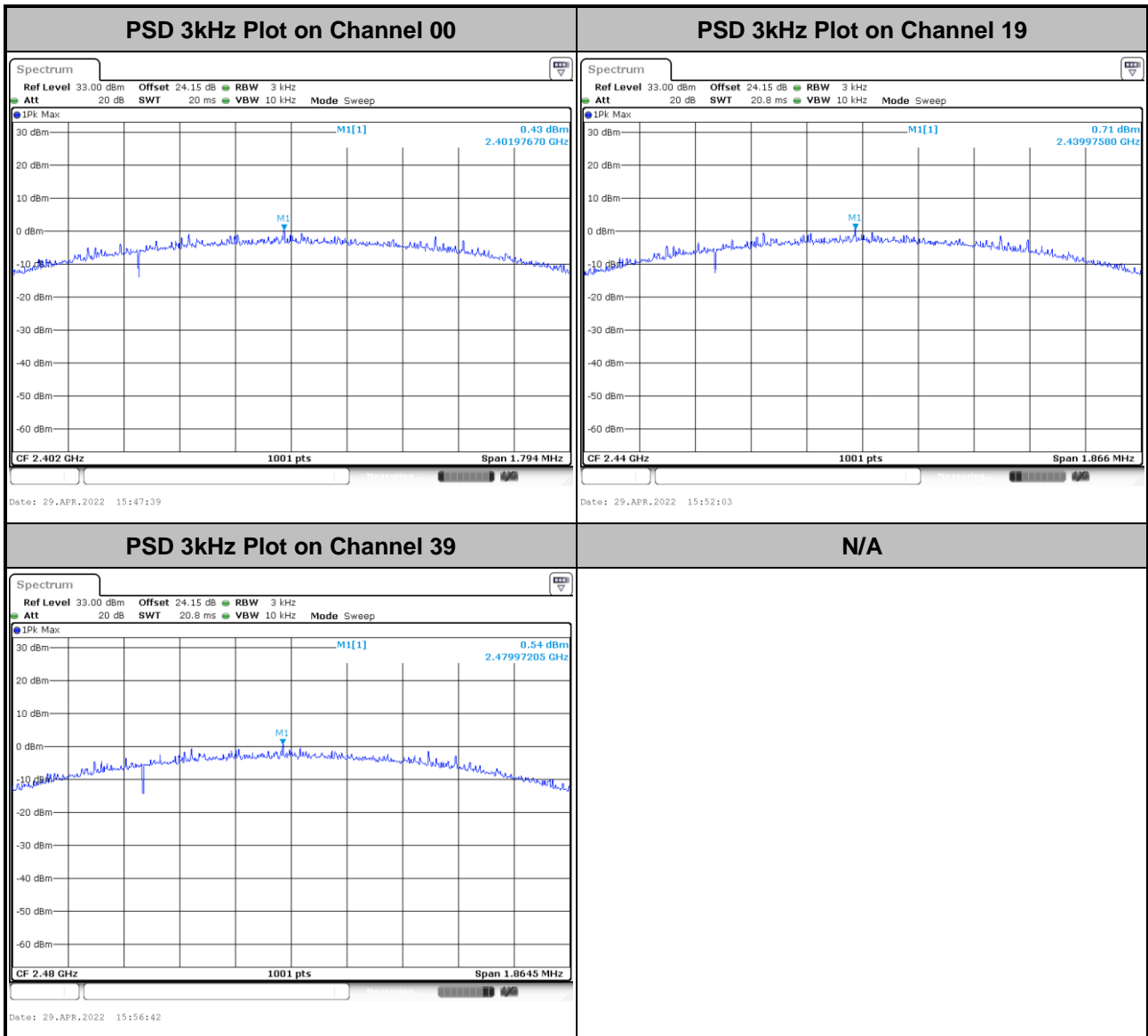



MIMO <Ant. 4>

<1Mbps>

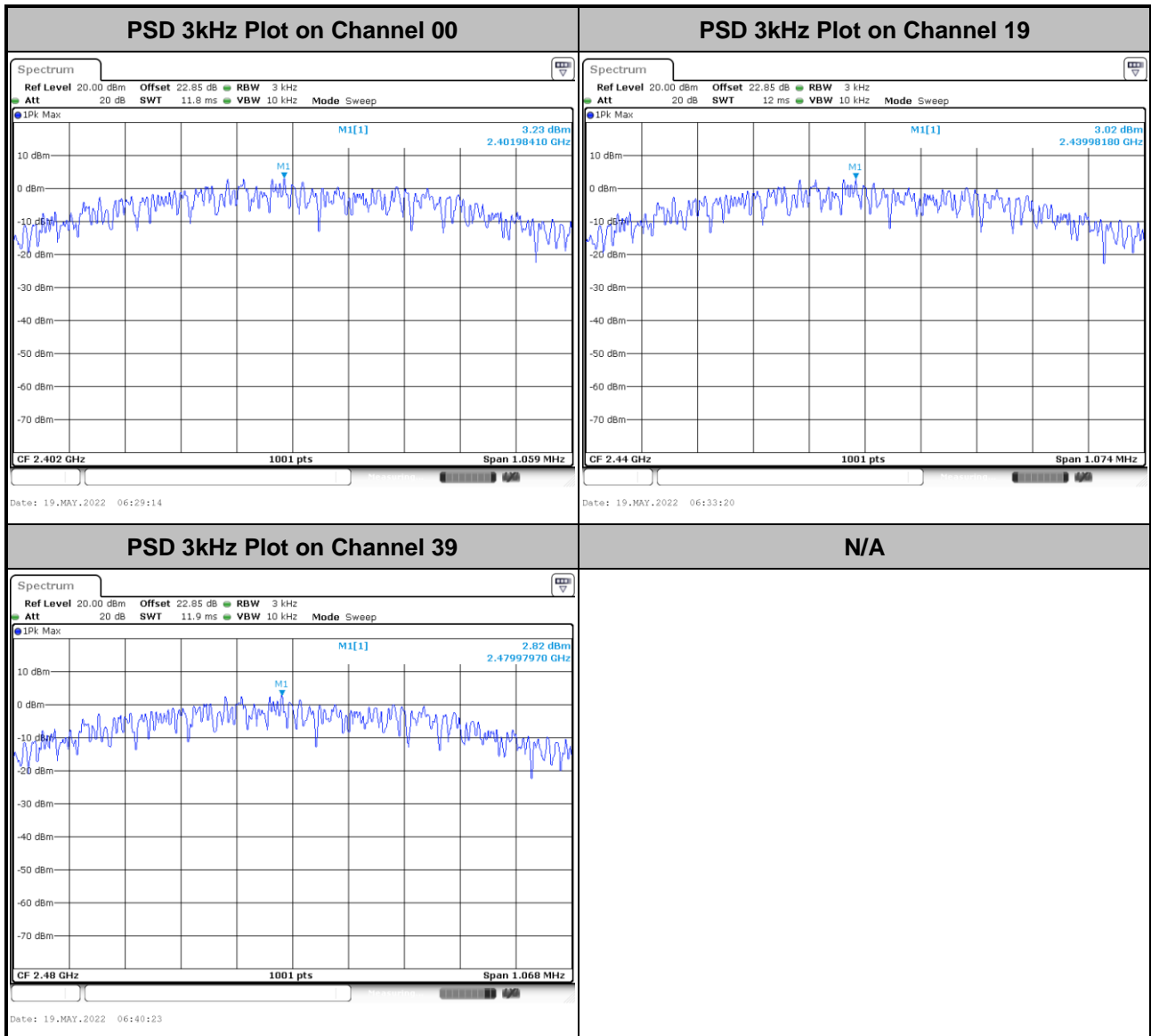



<2Mbps>

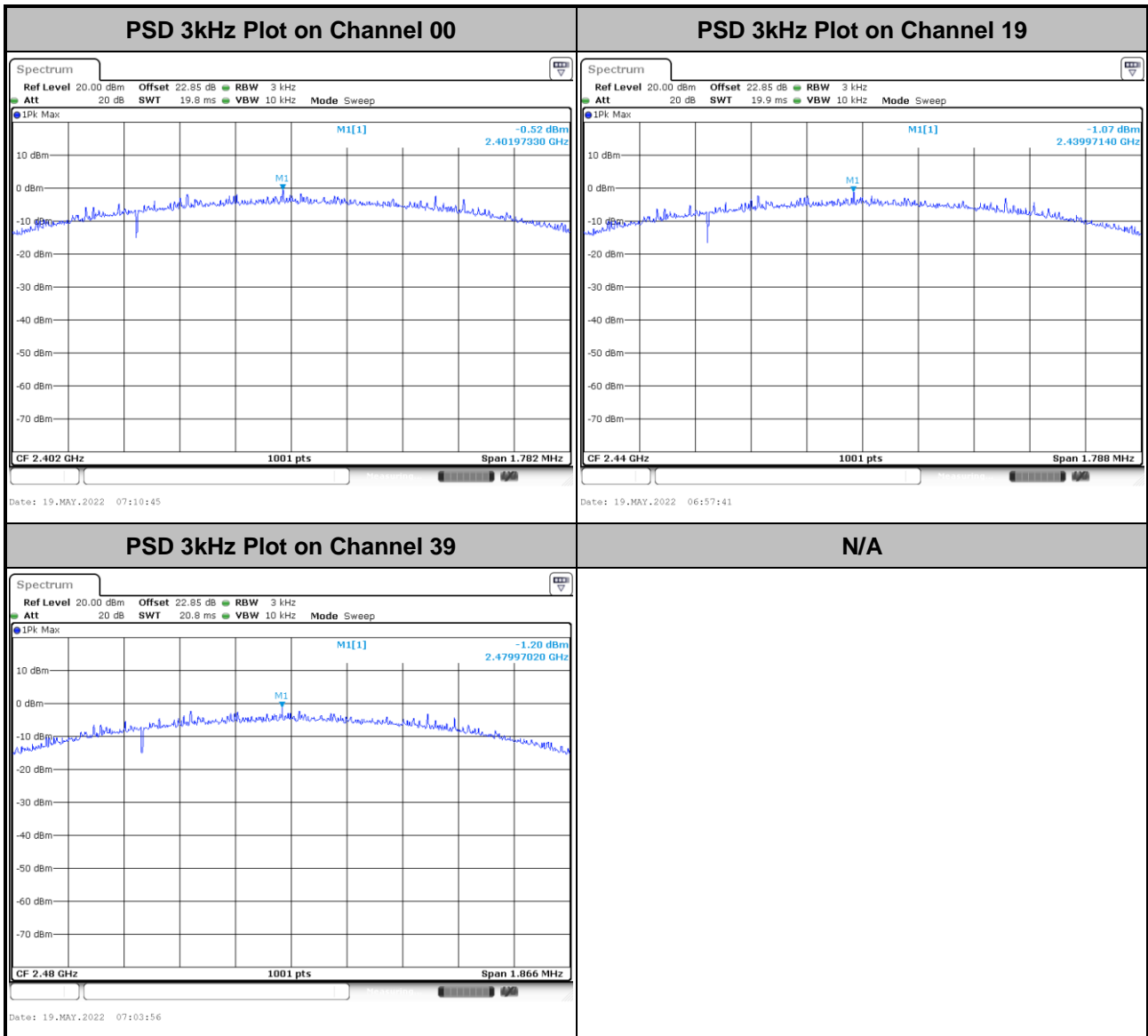



MIMO <Ant. 3>

<1Mbps>

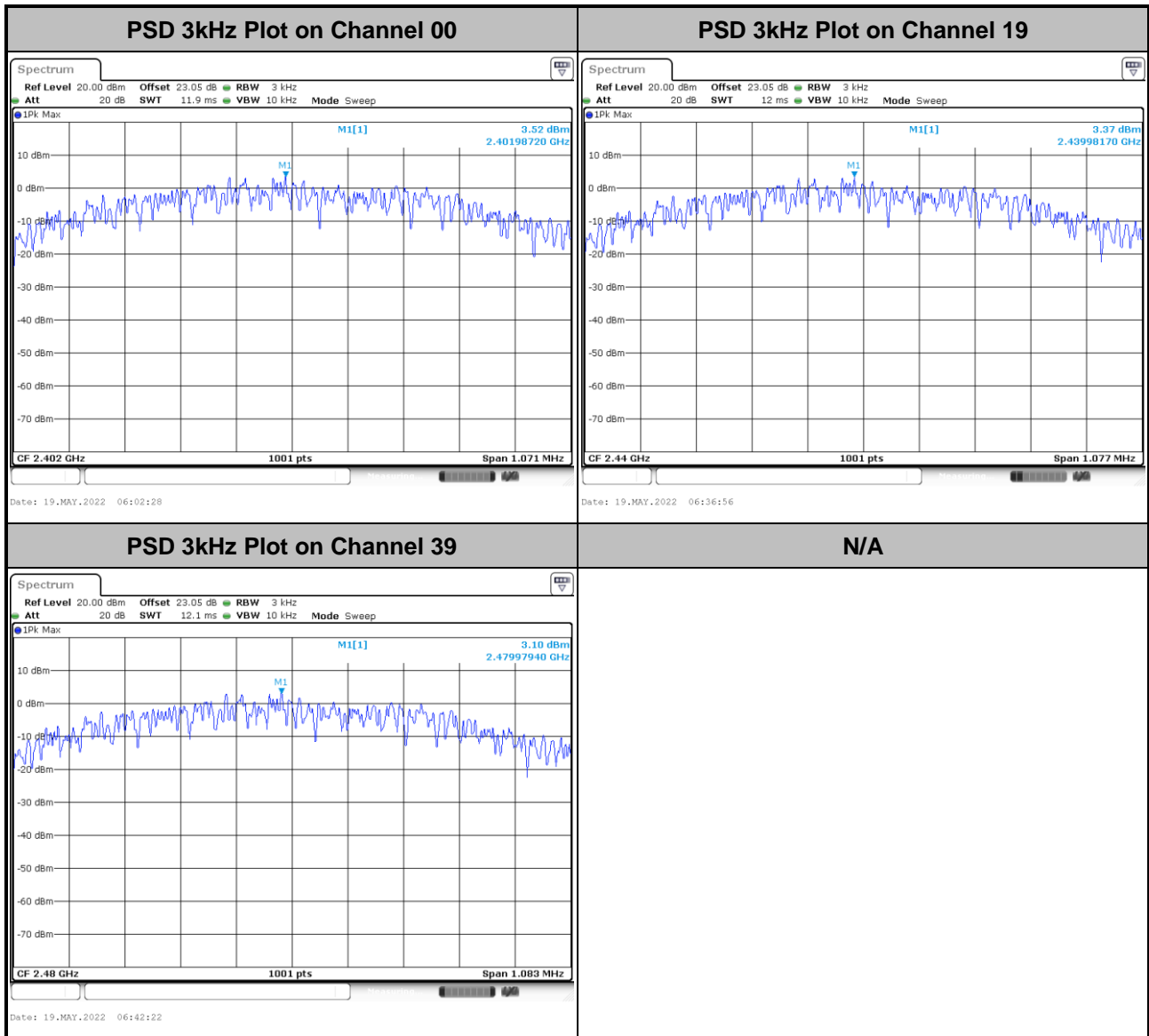



<2Mbps>

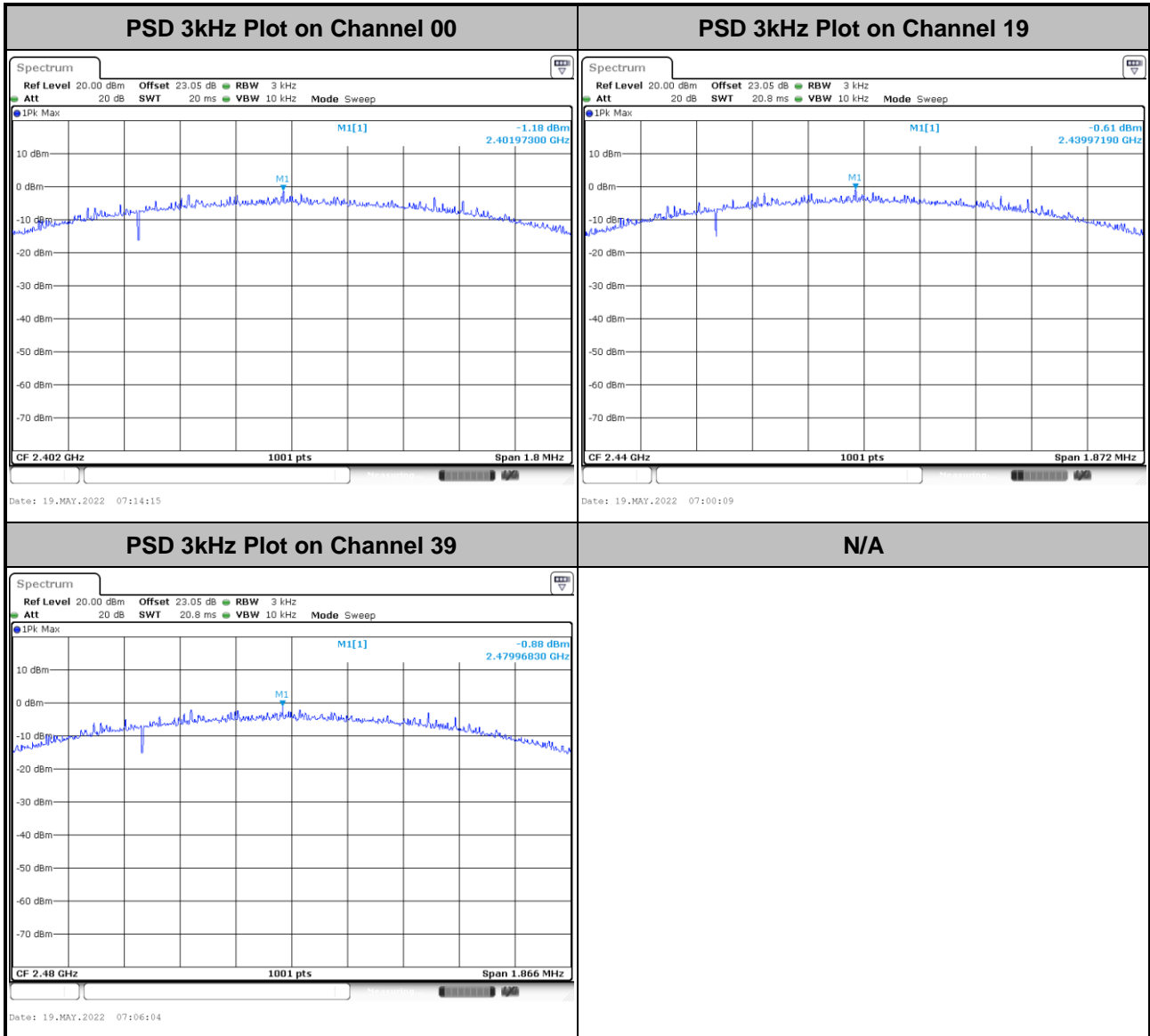

3.4 Conducted Band Edges and Spurious Emission Measurement

3.4.1 Limit of Conducted Band Edges and Spurious Emission

All harmonics/spurious must be at least 20 dB down from the highest emission level within the authorized band.

3.4.2 Measuring Instruments

Please refer to the measuring equipment list in this test report.

3.4.3 Test Procedure

1. The testing follows the ANSI C63.10 Section 11.11.3 Emission level measurement.
2. The RF output of EUT is connected to the spectrum analyzer by RF cable and attenuator. The path loss is compensated to the results for each measurement.
3. Set the maximum power setting and enable the EUT to transmit continuously.
4. Set RBW = 100 kHz, VBW = 300 kHz, Peak Detector. Unwanted Emissions measured in any 100 kHz bandwidth outside of the authorized frequency band shall be attenuated by at least 20 dB relative to the maximum in-band peak PSD level in 100 kHz when maximum peak conducted output power procedure is used. If the transmitter complies with the conducted power limits based on the use of RMS averaging over a time interval, the attenuation required under this paragraph shall be 30 dB instead of 20 dB.
5. Measure and record the results in the test report.
6. The RF fundamental frequency should be excluded against the limit line in the operating frequency band.

3.4.4 Test Setup





3.4.5 Test Result of Conducted Band Edges Plots

<Ant. 4>

<1Mbps>

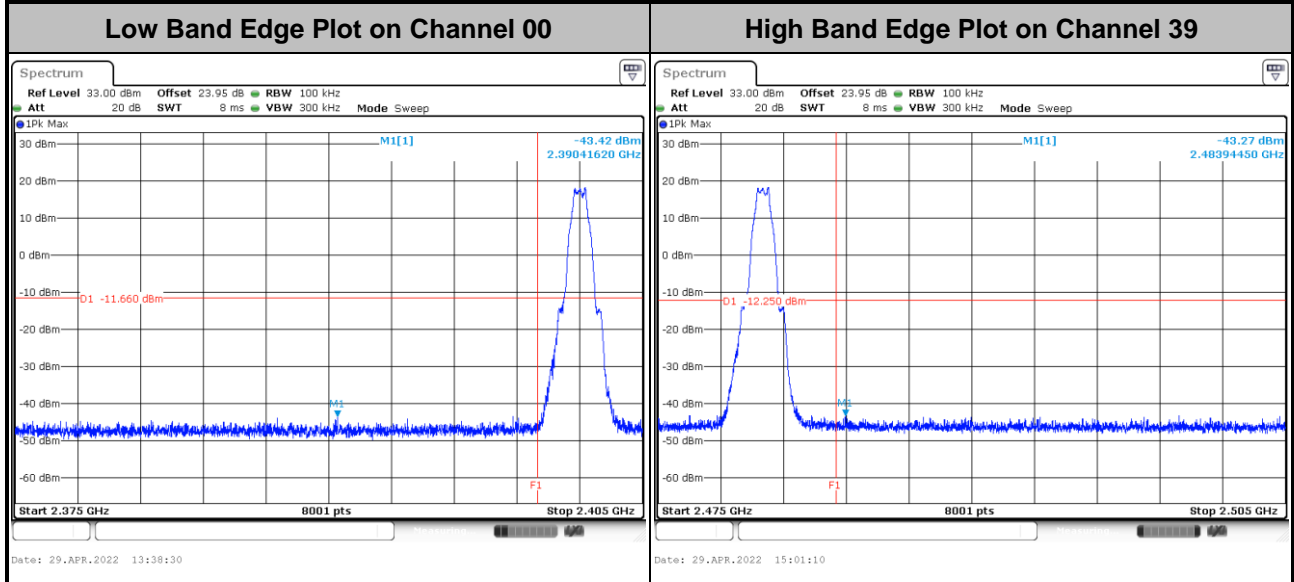

<2Mbps>

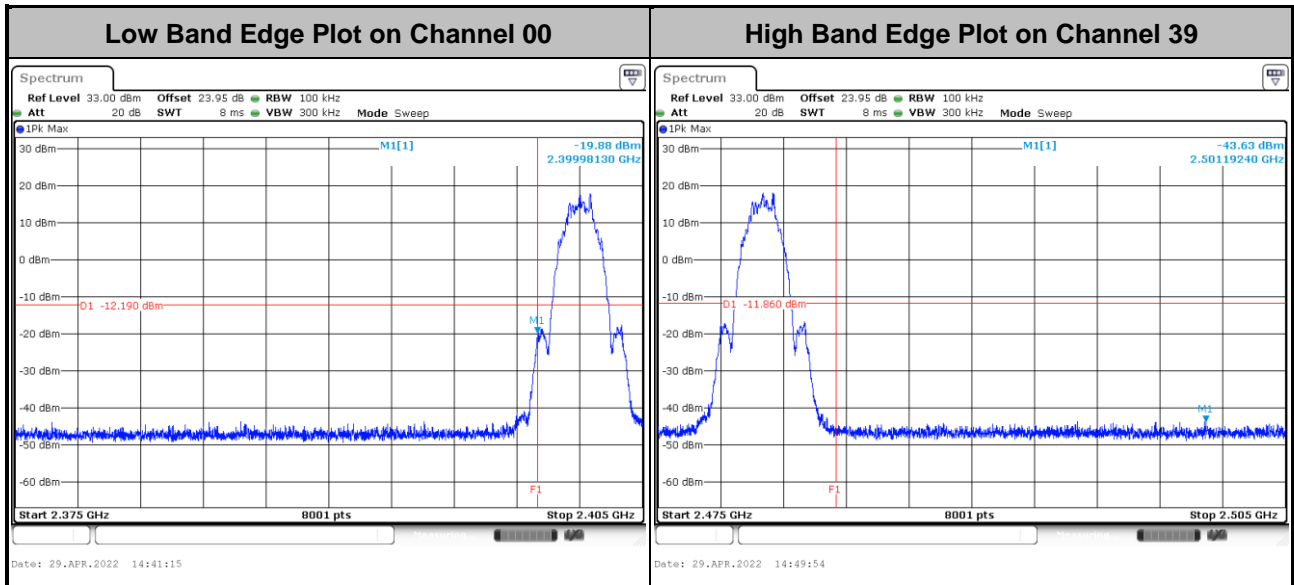



<Ant. 3>

<1Mbps>

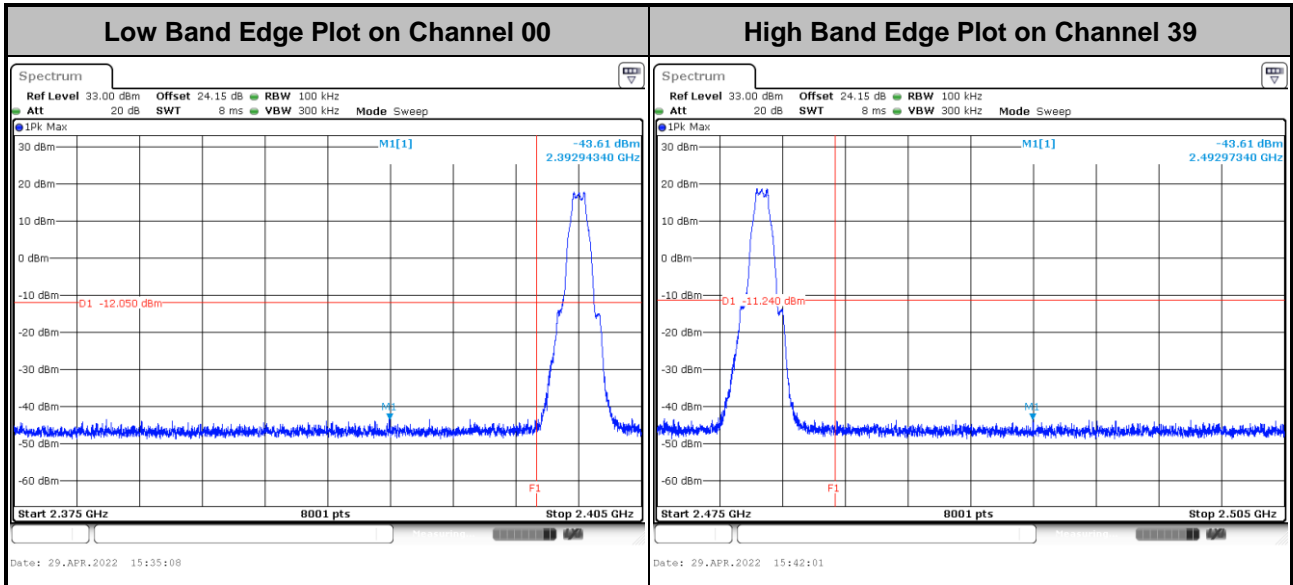

<2Mbps>

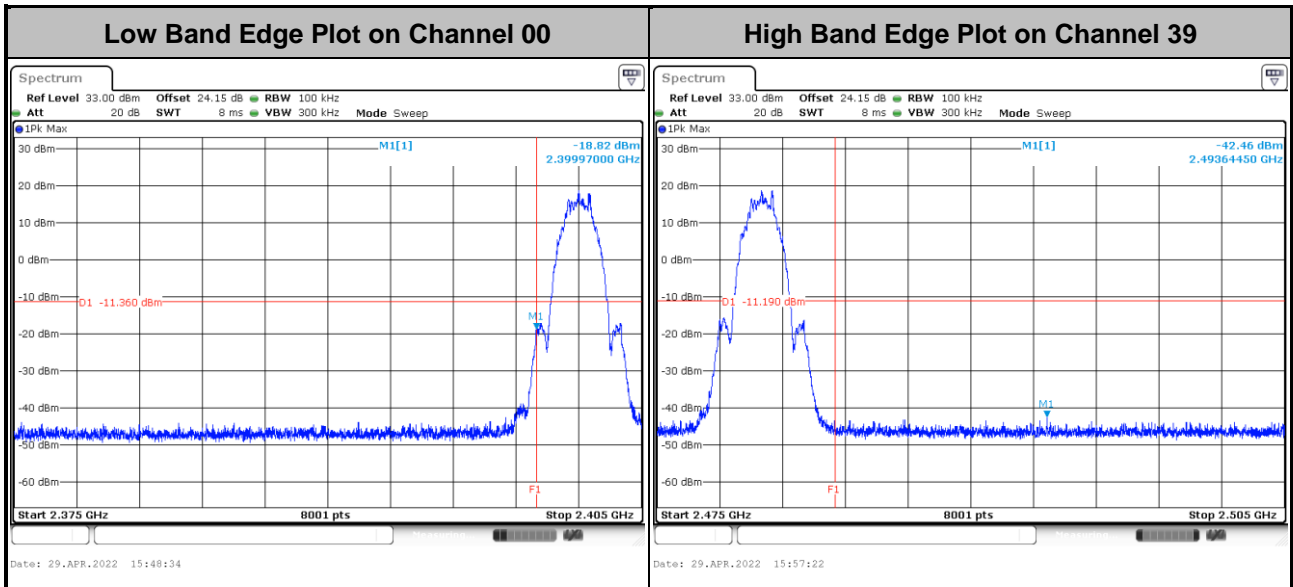



MIMO <Ant. 4>

<1Mbps>

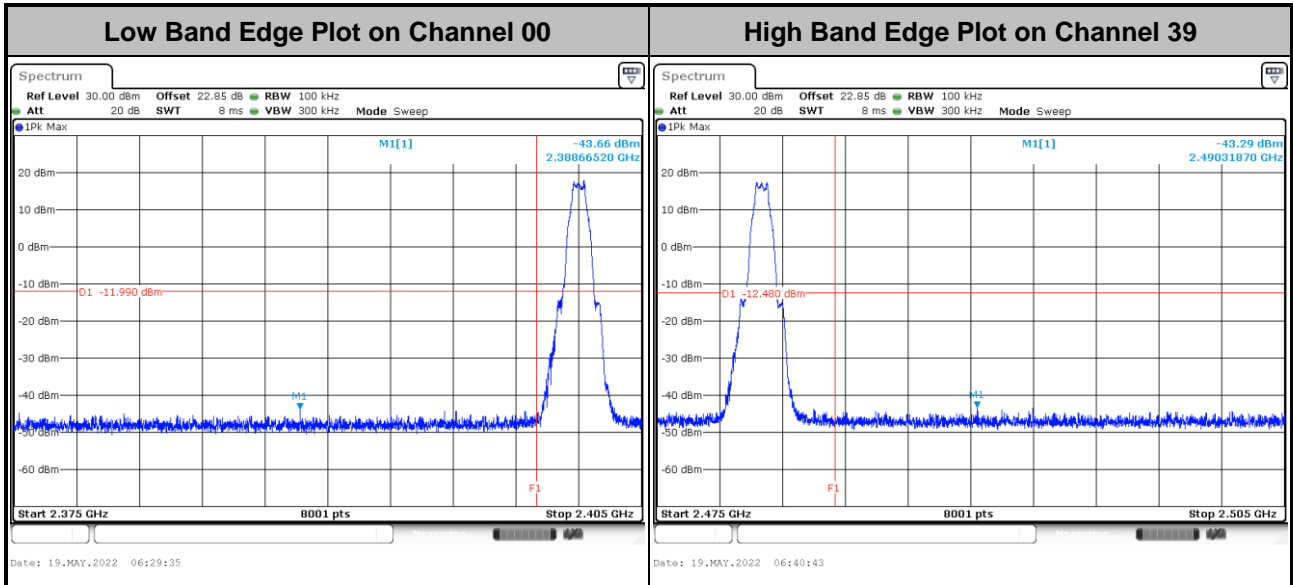

<2Mbps>

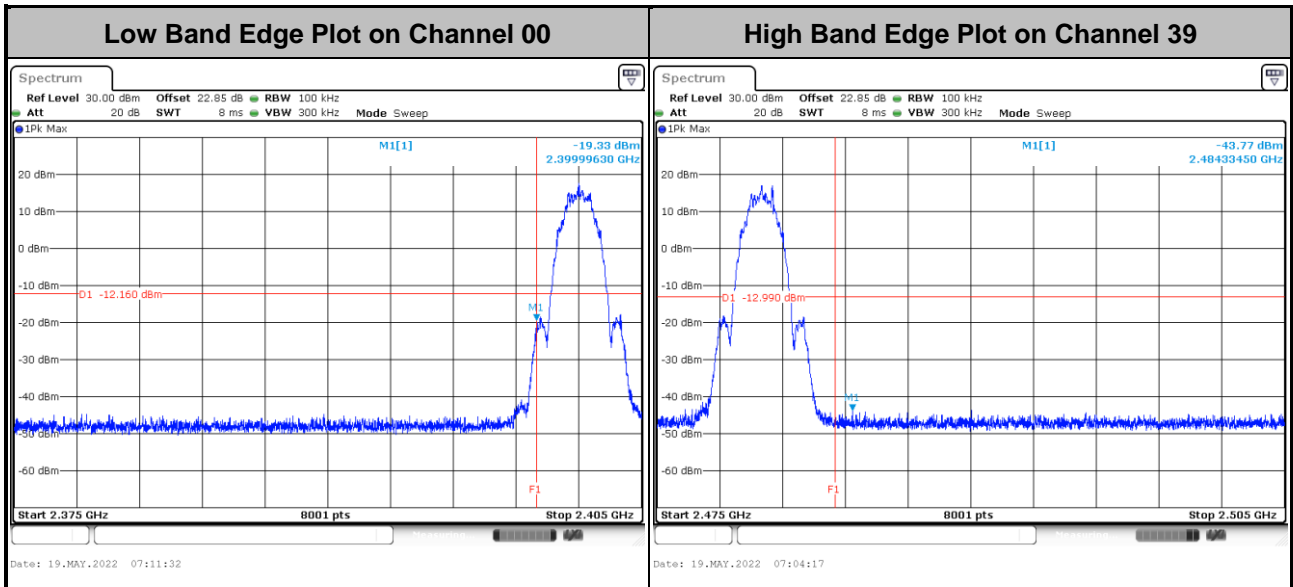



MIMO <Ant. 3>

<1Mbps>

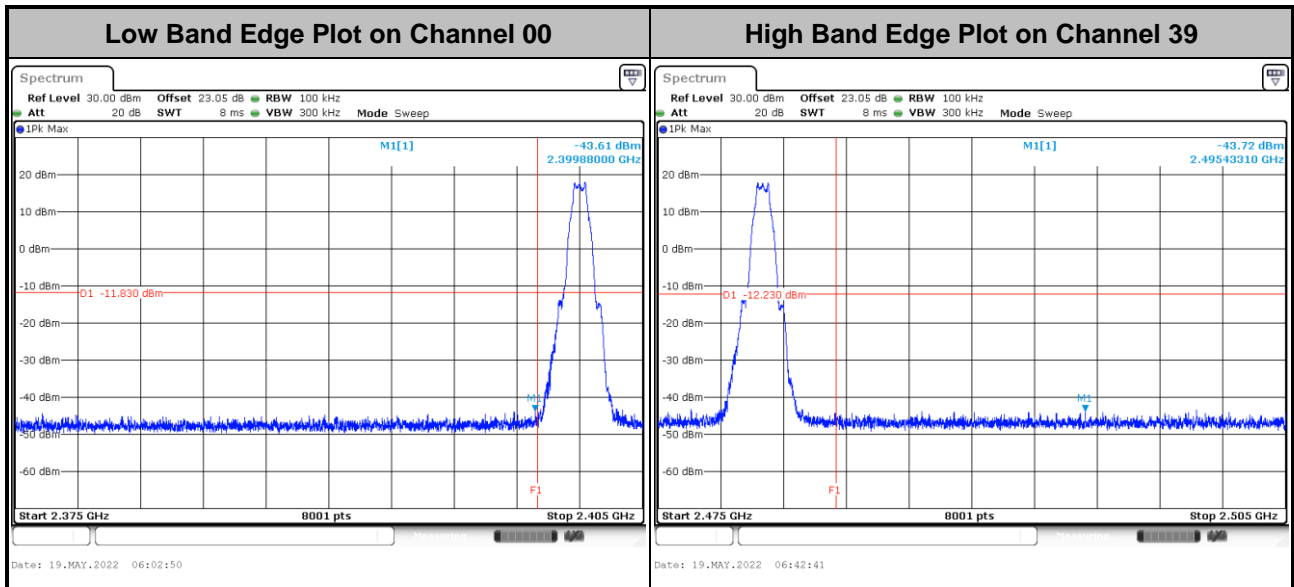

<2Mbps>

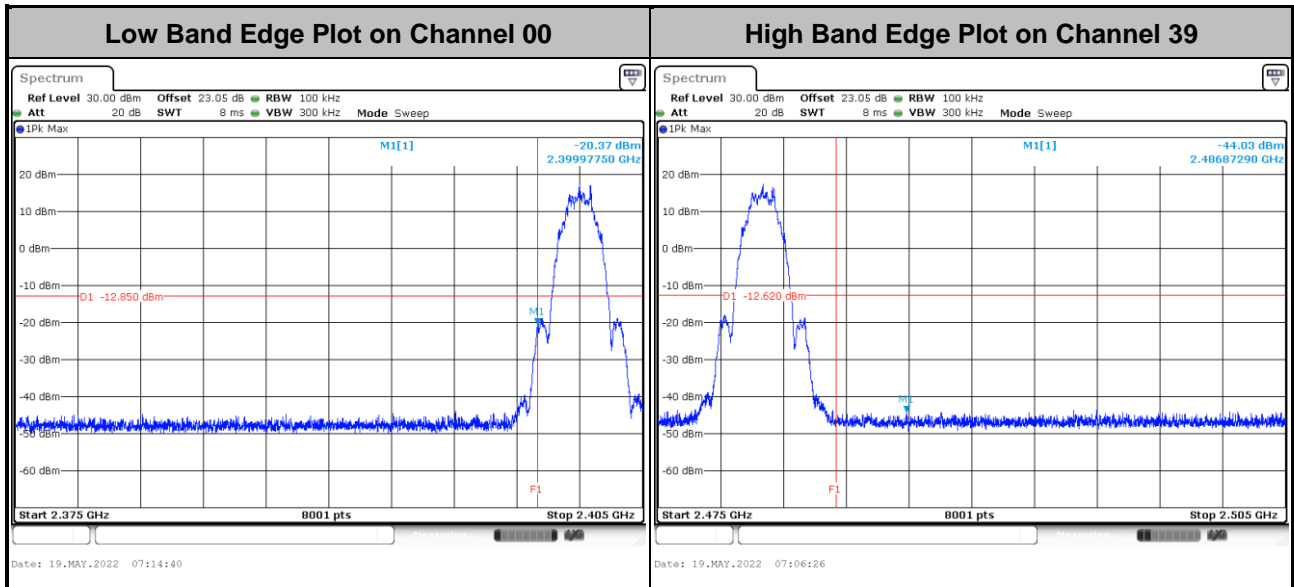



3.4.6 Test Result of Conducted Spurious Emission Plots

<Ant. 4>

<1Mbps>

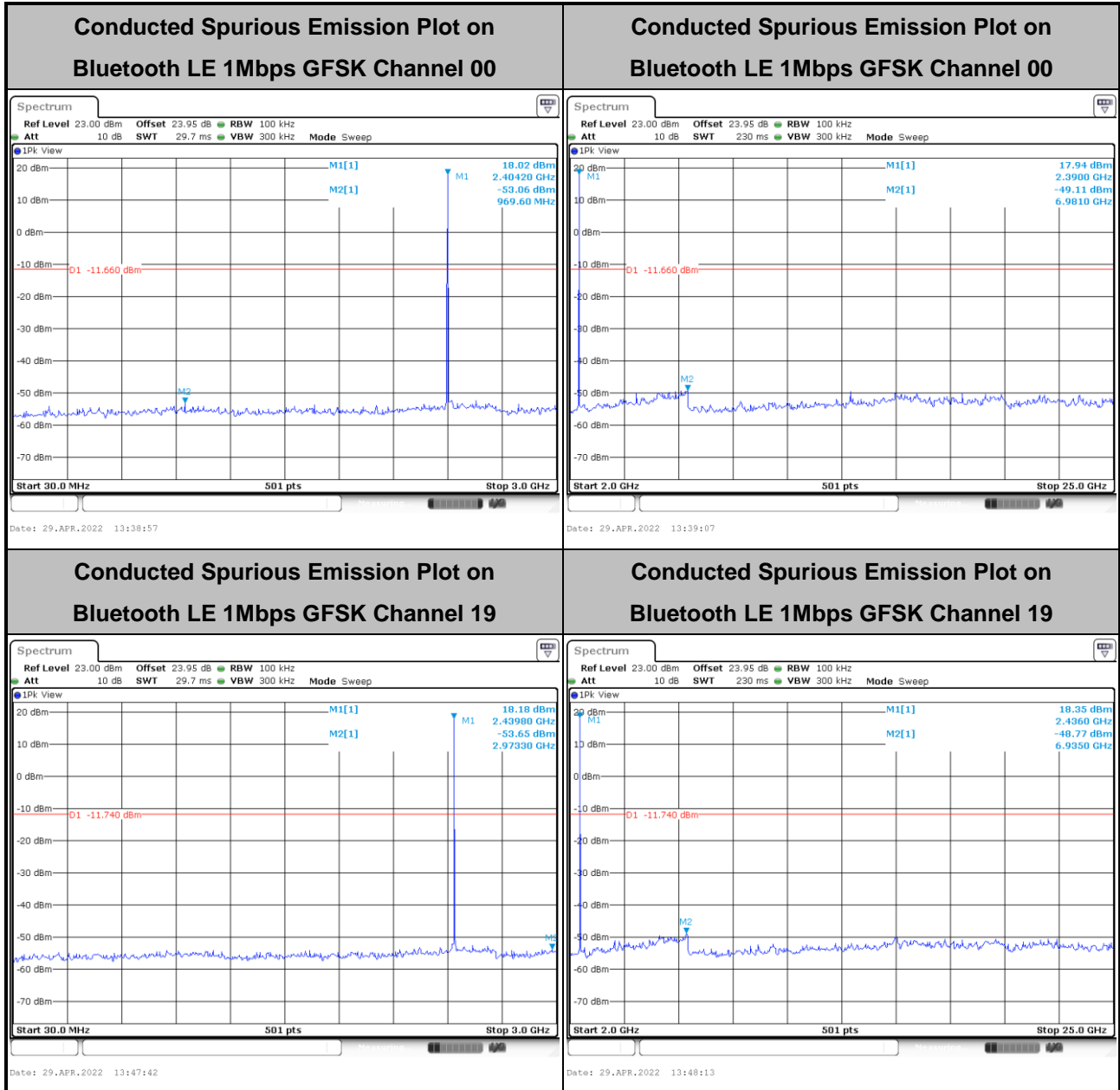

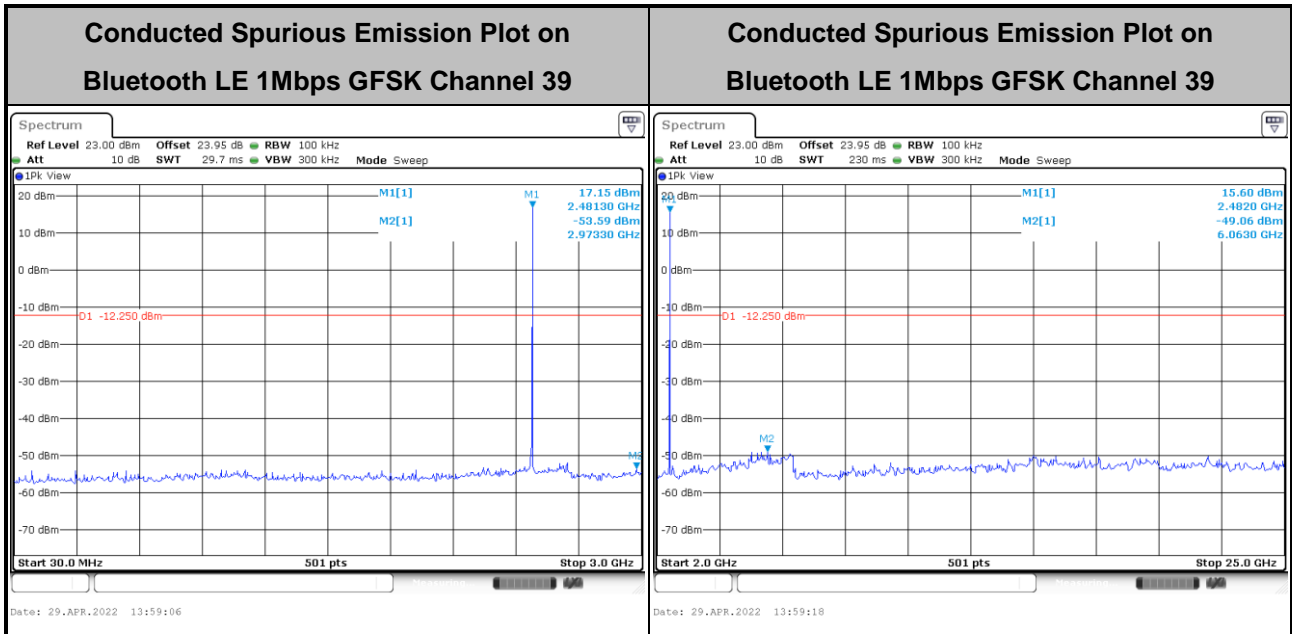



<2Mbps>

