



FCC RADIO TEST REPORT

FCC ID : A4RGE2AE
Equipment : Phone
Applicant : Google LLC
1600 Amphitheatre Parkway,
Mountain View, California, 94043 USA
Standard : FCC Part 15 Subpart C §15.209

The product was received on Mar. 10, 2022 and testing was performed from Mar. 29, 2022 to May 30, 2022. We, Sporton International Inc. EMC & Wireless Communications Laboratory, would like to declare that the tested sample has been evaluated in accordance with the test procedures and has been in compliance with the applicable technical standards.

The test results in this report apply exclusively to the tested model / sample. Without written approval of Sporton International Inc. EMC & Wireless Communications Laboratory, the test report shall not be reproduced except in full.

Louis Wu

Approved by: Louis Wu

Sporton International Inc. EMC & Wireless Communications Laboratory

No. 52, Huaya 1st Rd., Guishan Dist., Taoyuan City 333, Taiwan (R.O.C.)



Table of Contents

1. General Description	5
1.1 Product Feature of Equipment Under Test	5
1.2 Product Specification of Equipment Under Test	5
1.3 Modification of EUT	5
1.4 Testing Location	6
1.5 Applicable Standards.....	6
2. Test Configuration of Equipment Under Test.....	7
2.1 Descriptions of Test Mode	7
2.2 Connection Diagram of Test System	8
2.3 Support Unit used in test configuration and system	9
2.4 EUT Operation Test Setup	9
3. Test Results	10
3.1 AC Power Line Conducted Emissions Measurement	10
3.2 20dB and 99% OBW Spectrum Bandwidth Measurement.....	12
3.3 Radiated Emissions Measurement	13
3.4 Antenna Requirements.....	16
4. List of Measuring Equipment	17
5. Uncertainty of Evaluation	18
Appendix A. Test Results of Conducted Emission Test	
Appendix B. Test Results of RF Near Field Test Items	
Appendix C. Test Results of Radiated Test Items	
C2. Results of Radiated Emissions (9 kHz~30MHz)	
C3. Results of Radiated Emissions (30MHz~1GHz)	
Appendix D. Setup Photographs	



History of this test report

Report No.	Version	Description	Issued Date
FR1O2919-05H	01	Initial issue of report	Jun. 01, 2022
FR1O2919-05H	02	1. Revise Transmitter Frequency Range 2. Revise Table of Contents and appendix C 3. Add remark description in Test Mode	Jun. 02, 2022
FR1O2919-05H	03	1. Revise Transmitter Frequency Range 2. Remove Model Name	Jun. 06, 2022



Summary of Test Result

Report Clause	Ref Std. Clause	Test Items	Result (PASS/FAIL)	Remark
3.1	15.207	AC Power Line Conducted Emissions	Pass	Under limit 19.19 dB at 0.152MHz
3.2	15.215(c)	20dB Spectrum Bandwidth	Reporting only	-
	2.1049	99% OBW Spectrum Bandwidth	Reporting only	-
3.3	15.209	Field Strength of Fundamental Emissions	Pass	Max level -12.63 dB μ V/m at 0.147 MHz
		Radiated Spurious Emissions	Pass	Under limit 6.92 dB at 43.580MHz
3.4	15.203	Antenna Requirements	Pass	-

Declaration of Conformity:

1. The test results (PASS/FAIL) with all measurement uncertainty excluded are presented in accordance with the regulation limits or requirements declared by manufacturers.
It's means measurement values may risk exceeding the limit of regulation standards, if measurement uncertainty is include in test results.
2. The measurement uncertainty please refer to report "Uncertainty of Evaluation".

Comments and Explanations:

The product specifications of the EUT presented in the report are declared by the manufacturer who shall take full responsibility for the authenticity.

Reviewed by: William Chen**Report Producer: Vivian Hsu**



1. General Description

1.1 Product Feature of Equipment Under Test

Product Feature	
Equipment	Phone
FCC ID	A4RGE2AE
EUT supports Radios application	GSM/EGPRS/WCDMA/HSPA/LTE/5G NR/ NFC/GNSS/WPC/WPT/UWB WLAN 11b/g/n HT20 WLAN 11a/n HT20/HT40 WLAN 11ac VHT20/VHT40/VHT80/VHT160 WLAN 11ax HE20/HE40/HE80/HE160 Bluetooth BR/EDR/LE

Remark: The above EUT's information was declared by manufacturer.

EUT Information List	
S/N	Performed Test Item
22271FDH300017	RF Near Field
22271FDH30002B 22271FDH300025	Radiated Spurious Emissions
22271FDH30000P	Conducted Emission

1.2 Product Specification of Equipment Under Test

Product Specification is subject to this standard	
Transmitter Frequency Range	110 kHz ~ 148.5 kHz
99%OBW	0.666 kHz
Antenna Type	Single Coil Antenna
Type of Modulation	ASK

Remark: The EUT's information above is declared by manufacturer. Please refer to Comments and Explanations in report summary.

1.3 Modification of EUT

No modifications made to the EUT during the testing.

1.4 Testing Location

Test Site	Sporton International Inc. EMC & Wireless Communications Laboratory	
Test Site Location	No.52, Huaya 1st Rd., Guishan Dist., Taoyuan City 333, Taiwan (R.O.C.) TEL: +886-3-327-3456 FAX: +886-3-328-4978	
Test Site No.	Sporton Site No.	
	TH03-HY	CO05-HY
Test Engineer	Oscar Chi	Calvin Wang
Temperature (°C)	22~24	23~26
Relative Humidity (%)	53~55	45~55

Note: The test site complies with ANSI C63.4 2014 requirement.

Test Site	Sporton International Inc. Wensan Laboratory	
Test Site Location	No.58, Aly. 75, Ln. 564, Wenhua 3rd, Rd., Guishan Dist., Taoyuan City 333010, Taiwan (R.O.C.) TEL: +886-3-327-0868 FAX: +886-3-327-0855	
Test Site No.	Sporton Site No.	
	03CH11-HY (TAF Code: 3786)	
Test Engineer	Fu Chen and Troye Hsieh	
Temperature (°C)	20.1~21.5	
Relative Humidity (%)	57.1~66.7	
Remark	The Radiated Spurious Emission test item subcontracted to Sporton International Inc. Wensan Laboratory.	

Note: The test site complies with ANSI C63.4 2014 requirement.

FCC designation No.: TW1190 and TW3786

1.5 Applicable Standards

According to the specifications of the manufacturer, the EUT must comply with the requirements of the following standards:

- ♦ FCC Part 15 Subpart C §15.209
- ♦ FCC KDB 414788 D01 Radiated Test Site v01r01
- ♦ ANSI C63.10-2013

Remark:

1. All the test items were validated and recorded in accordance with the standards without any modification during the testing.
2. The TAF code is not including all the FCC KDB listed without accreditation.

2. Test Configuration of Equipment Under Test

2.1 Descriptions of Test Mode

Investigation has been done on all the possible configurations.

The following table is a list of the test modes shown in this test report.

Test Items	
AC Power Line Conducted Emissions	20dB Spectrum Bandwidth
Field Strength of Fundamental Emissions	
Radiated Emissions 9kHz~30MHz	Radiated Emissions 30MHz~1GHz

The measured emission level of the EUT was maximized by rotating the EUT on a turntable, adjusting the orientation of the EUT and EUT antenna in three orthogonal axis (X: flat, Y: portrait, Z: landscape) and accessory (Adapter or Earphone), and adjusting the measurement antenna orientation, following C63.10 exploratory test procedures and find X Plane with Earphone for Mode 1 and Mode 2; X Plane with Adapter for Mode 3 as worst plane.

Test Cases	
Radiated Spurious Emission	Mode 1 : WPT Charging with Another Phone; Battery 0%
	Mode 2 : WPT Charging with Another Phone; Battery 50%
	Mode 3 : WPT Charging with Another Phone; Battery 100%
AC Conducted Emission	Mode 1 WPT Charging with Another Phone + USB Cable 1 (Charging from Adapter 2); Battery 50%
Remark:	
1. For Radiated Test Cases, the tests were performed with Adapter 2 and USB Cable 1.	
2. During the preliminary scan, the battery residual power does not affect the test result significantly. The AC power line conducted emission test is performed with a general setup condition.	

2.2 Connection Diagram of Test System

<AC Conducted Emission Mode>

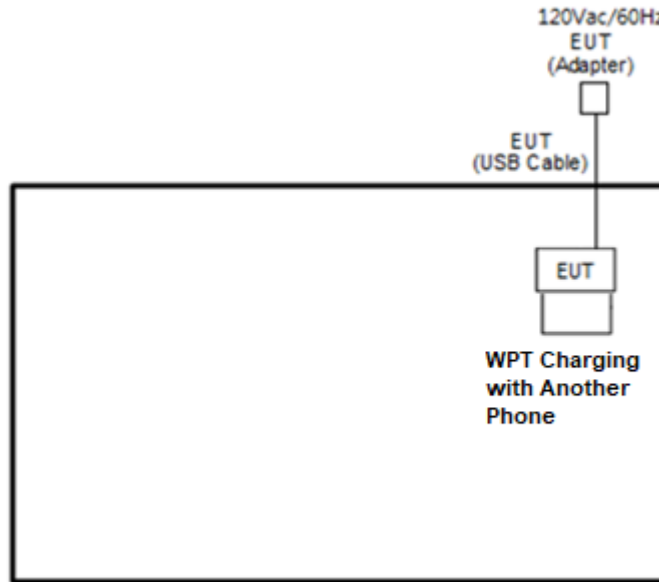

<WPT Mode with Adapter>

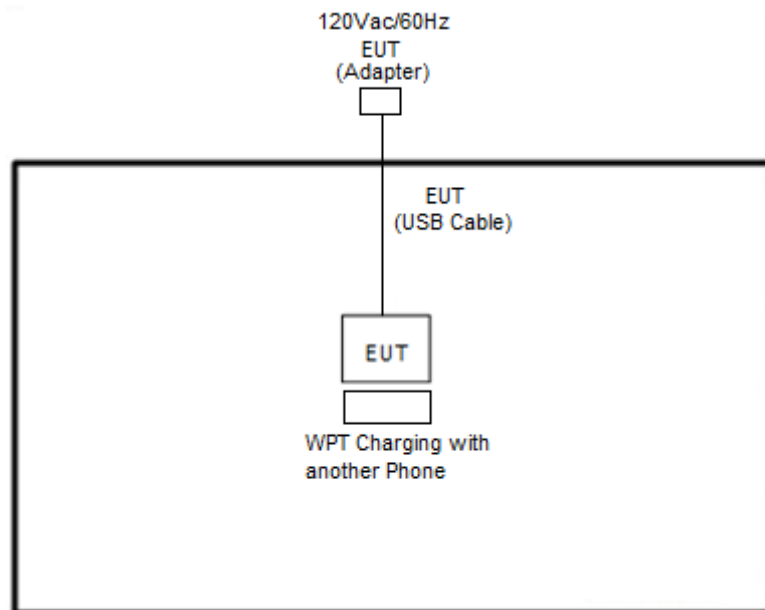

<WPT Mode with Earphone>

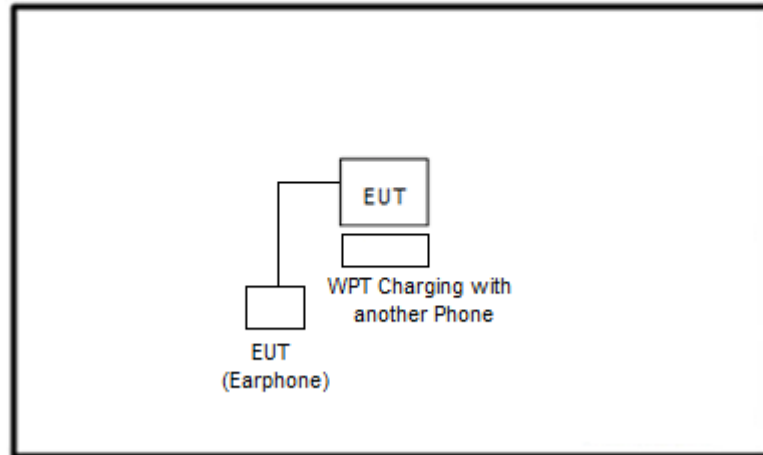

2.3 Support Unit used in test configuration and system

Item	Equipment	Brand Name	Model Name	FCC ID	Data Cable	Power Cord
1.	Phone	Google	N/A	A4RGE2AE	-	-
2.	Notebook	Dell	Latitude 3400	FCC DoC	N/A	AC I/P : Unshielded, 1.2m DC O/P : Shielded, 1.8m

2.4 EUT Operation Test Setup

The Wireless Charging with another phone via wireless power transfer function.

3. Test Results

3.1 AC Power Line Conducted Emissions Measurement

3.1.1 Limit of AC Conducted Emission

For equipment that is designed to be connected to the public utility (AC) power line, the radio frequency voltage that is conducted back onto the AC power line on any frequency or frequencies within the band 150 kHz to 30 MHz shall not exceed the limits in the following table.

Frequency of Emission (MHz)	Conducted Limit (dB μ V)	
	Quasi-Peak	Average
0.15-0.5	66 to 56*	56 to 46*
0.5-5	56	46
5-30	60	50

*Decreases with the logarithm of the frequency.

3.1.2 Measuring Instruments

See list of measuring equipment of this test report.

3.1.3 Test Procedures

1. The EUT was placed 0.4 meter from the conducting wall of the shielding room, and it was kept at least 80 centimeters from any other grounded conducting surface.
2. Connect EUT to the power mains through a line impedance stabilization network (LISN).
3. All the support units are connecting to the other LISN.
4. The LISN provides 50 ohm coupling impedance for the measuring instrument.
5. The FCC states that a 50 ohm, 50 microhenry LISN should be used.
6. Both sides of AC line were checked for maximum conducted interference.
7. The frequency range from 150 kHz to 30 MHz was searched.
8. Set the test-receiver system to Peak Detect Function and specified bandwidth (IF Bandwidth = 9kHz) with Maximum Hold Mode. Then measurement is also conducted by Average Detector and Quasi-Peak Detector Function respectively.

3.1.4 Test setup

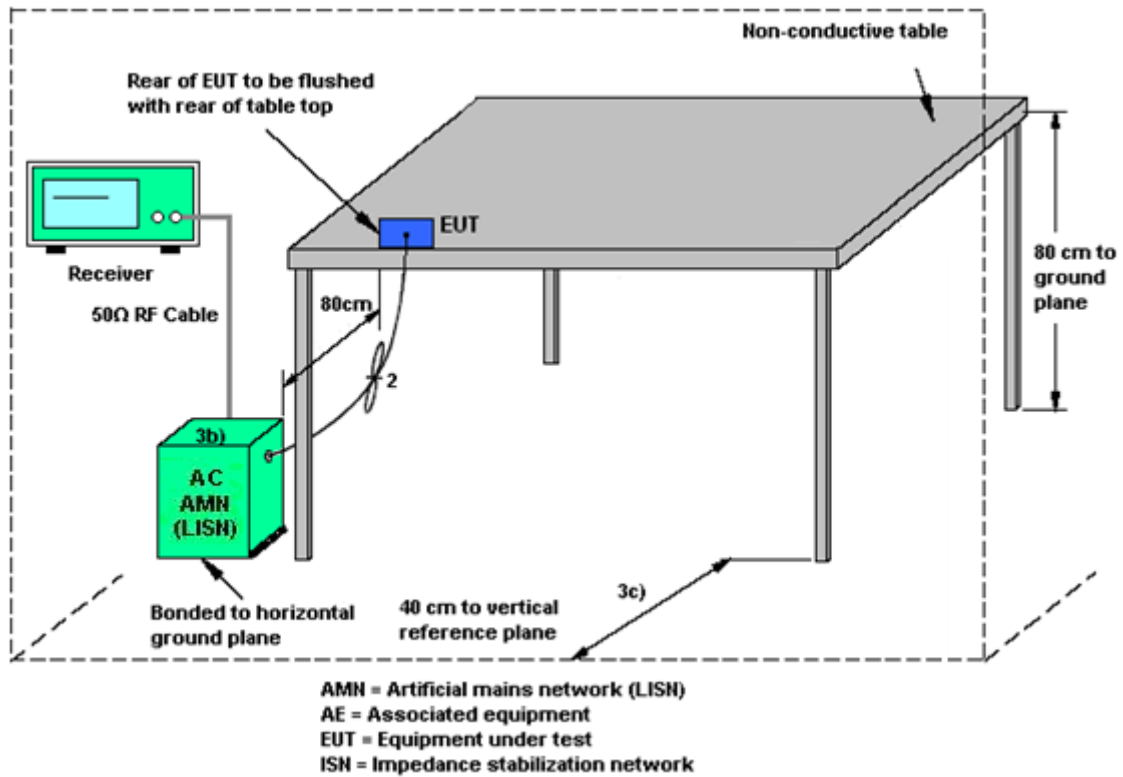

3.1.5 Test Result of AC Conducted Emission

Please refer to Appendix A.

3.2 20dB and 99% OBW Spectrum Bandwidth Measurement

3.2.1 Limit

Reporting only

3.2.2 Measuring Instruments

See list of measuring instruments of this test report.

3.2.3 Test Procedures

1. The spectrum analyzer connected via a receive antenna placed near the EUT in peak Max hold mode.
2. The resolution bandwidth of 300 Hz and the video bandwidth of 300 Hz were used.
3. Measured the spectrum width with power higher than 20dB below carrier.
4. Measured the 99% OBW.

3.2.4 Test Setup

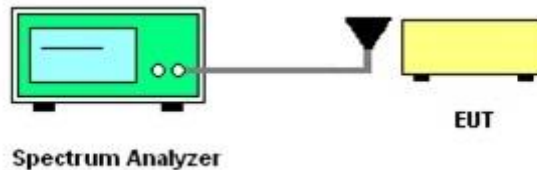

3.2.5 Test Result of RF Near Field Test Items

Please refer to Appendix B.

3.3 Radiated Emissions Measurement

3.3.1 Limit

The field strength of any emissions which appear band shall not exceed the general radiated emissions limits.

Frequencies (MHz)	Field Strength ($\mu\text{V/m}$)	Measurement Distance (meters)
0.009~0.490	2400/F(kHz)	300
0.490~1.705	24000/F(kHz)	30
1.705~30.0	30	30
30~88	100	3
88~216	150	3
216~960	200	3
Above 960	500	3

3.3.2 Measuring Instruments

See list of measuring instruments of this test report.

3.3.3 Measuring Instrument Setting

The following table is the setting of receiver:

Receiver Parameter	Setting
Attenuation	Auto
Frequency Range: 9kHz~150kHz	RBW 200Hz for QP
Frequency Range: 150kHz~30MHz	RBW 9kHz for QP
Frequency Range: 30MHz~1000MHz	RBW 120kHz for Peak

Note: The emission limits shown in the above table are based on measurements employing a CISPR quasi-peak detector except for the frequency bands 9-90 kHz and 110-490 kHz. Radiated emission limits in these two bands are based on measurements employing an average detector.



3.3.4 Test Procedures

1. Configure the EUT according to ANSI C63.10. The EUT was placed on the top of the turntable 0.8 meter above ground. The phase center of the receiving antenna mounted on the top of a height-variable antenna tower was placed 3 meters far away from the turntable.
2. Power on the EUT and all the supporting units. The turntable was rotated by 360 degrees to determine the position of the highest radiation.
3. The height of the broadband receiving antenna was varied between one meter and four meters above ground to find the maximum emissions field strength of both horizontal and vertical polarization.
4. For each suspected emissions, the antenna tower was scan (from 1 M to 4 M) and then the turntable was rotated (from 0 degree to 360 degrees) to find the maximum reading.
5. Set the test-receiver system to Peak or CISPR quasi-peak Detect Function with specified bandwidth under Maximum Hold Mode.
6. When the radiated emissions limits are expressed in terms of the average value of the emissions, and pulsed operation is employed, the measurement field strength shall be determined by averaging over one complete pulse train, including blanking intervals, as long as the pulse train does not exceed 0.1 seconds. As an alternative (provided the transmitter operates for longer than 0.1 seconds) or in cases where the pulse train exceeds 0.1 seconds, the measured field strength shall be determined from the average absolute voltage during a 0.1 second interval during which the field strength is at its maximum value.
7. In case the emission is lower than 30MHz, loop antenna has to be used for measurement and the recorded data should be QP measured by receiver.

3.3.5 Test Setup

For radiated emissions below 30MHz

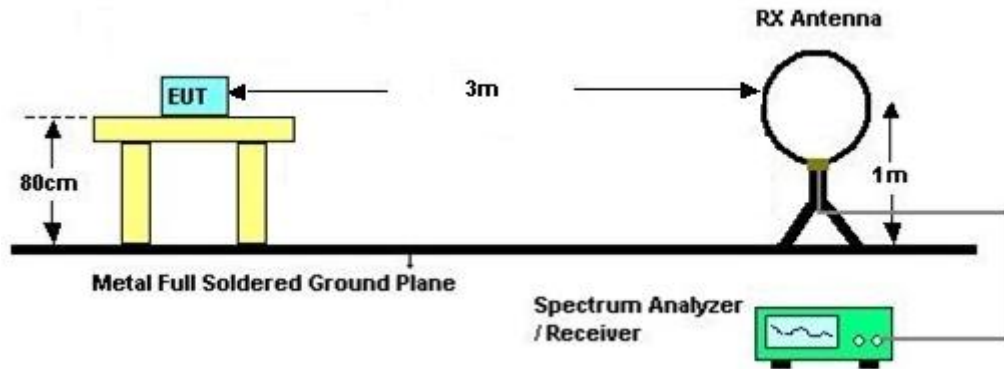

For radiated emissions above 30MHz

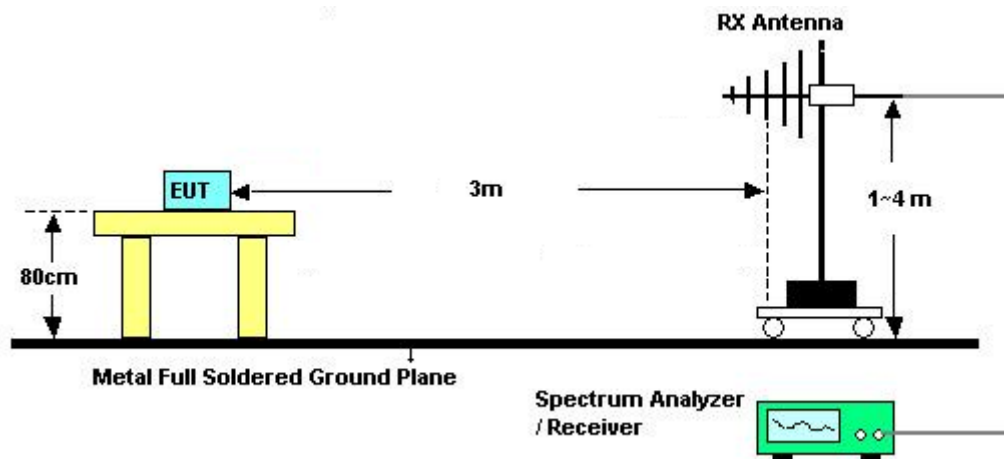

3.3.6 Test Result of Radiated Emissions Measurement

Please refer to Appendix C.

Remark:

1. There is adequate comparison measurement of both open-field test site and alternative test site - semi-Anechoic chamber according to 414788 D01 Radiated Test Site v01r01, and the result came out very similar.
2. According to C63.10 radiated test, the EUT pre-scanned horizontal, vertical, and ground-parallel three polarization's, the worst case is horizontal & vertical polarization, test data of two mode was reported.



3.4 Antenna Requirements

3.4.1 Standard Applicable

Except for special regulations, the Low-power Radio-frequency Devices must not be equipped with any jacket for installing an antenna with extension cable. An intentional radiator shall be designed to ensure that no antenna other than that furnished by the responsible party shall be used with the device. The use of a permanently attached antenna or of an antenna that uses a unique coupling to the intentional radiator shall be considered sufficient to comply with the provisions of this Section. The manufacturer may design the unit so that the user can replace a broken antenna, but the use of a standard antenna jack or electrical connector is prohibited.

The use of a permanently attached antenna or of an antenna that uses a unique coupling to the intentional radiator shall be considered sufficient to comply with the rule.

3.4.2 Antenna Anti-Replacement Construction

An embedded-in antenna design is used.



4. List of Measuring Equipment

Instrument	Brand Name	Model No.	Serial No.	Characteristics	Calibration Date	Test Date	Due Date	Remark
Bilog Antenna	TESEQ	CBL 6111D & N-6-06	35414 & AT-N0602	30MHz~1GHz	Oct. 09, 2021	Apr. 11, 2022~ Apr. 13, 2022	Oct. 08, 2022	Radiation (03CH11-HY)
Loop Antenna	Rohde & Schwarz	HFH2-Z2	100315	9 kHz~30 MHz	Jan. 07, 2022	Apr. 11, 2022~ Apr. 13, 2022	Jan. 06, 2023	Radiation (03CH11-HY)
Amplifier	SONOMA	310N	187312	9kHz~1GHz	Dec. 10, 2021	Apr. 11, 2022~ Apr. 13, 2022	Dec. 09, 2022	Radiation (03CH11-HY)
Spectrum Analyzer	Keysight	N9010A	MY54200486	10Hz~44GHz	Oct. 15, 2021	Apr. 11, 2022~ Apr. 13, 2022	Oct. 14, 2022	Radiation (03CH11-HY)
EMI Test Receiver	Keysight	N9038A(MXE)	MY55420170	20MHz~8.4GHz	Jul. 15, 2021	Apr. 11, 2022~ Apr. 13, 2022	Jul. 14, 2022	Radiation (03CH11-HY)
RF Cable	HUBER + SUHNER	SUCOFLEX 102	MY2859/2	30MHz~40GHz	Mar. 10, 2022	Apr. 11, 2022~ Apr. 13, 2022	Mar. 09, 2023	Radiation (03CH11-HY)
RF Cable	HUBER + SUHNER	SUCOFLEX 104	MY9837/4PE	9kHz~30MHz	Mar. 10, 2022	Apr. 11, 2022~ Apr. 13, 2022	Mar. 09, 2023	Radiation (03CH11-HY)
RF Cable	HUBER + SUHNER	SUCOFLEX 104	MY9837/4PE	30MHz~18GHz	Mar. 10, 2022	Apr. 11, 2022~ Apr. 13, 2022	Mar. 09, 2023	Radiation (03CH11-HY)
Filter	Wainwright	WHK20/1000C 7/40SS	SN2	20M High Pass	Sep. 13, 2021	Apr. 11, 2022~ Apr. 13, 2022	Sep. 12, 2022	Radiation (03CH11-HY)
Controller	EMEC	EM 1000	N/A	Control Turn table & Ant Mast	N/A	Apr. 11, 2022~ Apr. 13, 2022	N/A	Radiation (03CH11-HY)
Antenna Mast	EMEC	AM-BS-4500-B	N/A	1~4m	N/A	Apr. 11, 2022~ Apr. 13, 2022	N/A	Radiation (03CH11-HY)
Turn Table	EMEC	TT 2000	N/A	0~360 Degree	N/A	Apr. 11, 2022~ Apr. 13, 2022	N/A	Radiation (03CH11-HY)
Software	Audix	E3 6.2009-8-24	RK-001053	N/A	N/A	Apr. 11, 2022~ Apr. 13, 2022	N/A	Radiation (03CH11-HY)
Hygrometer	TECPEL	DTM-303B	TP140325	N/A	Nov. 26, 2021	Apr. 11, 2022~ Apr. 13, 2022	Nov. 25, 2022	Radiation (03CH11-HY)
Hygrometer	TECPEL	DTM-303B	TP200880	QA-3-031	Sep. 30, 2021	Apr. 11, 2022~ Apr. 13, 2022	Sep. 29, 2022	Radiation (03CH11-HY)
Hygrometer	TECPEL	DTM-303B	TP210073	N/A	Nov. 16, 2021	Mar. 29, 2022	Nov. 15, 2022	RF Near Field (TH03-HY)
Spectrum Analyzer	Rohde & Schwarz	FSP30	101329	9kHz~30GHz	Sep. 30, 2021	Mar. 29, 2022	Sep. 29, 2022	RF Near Field (TH03-HY)
Coupling loop antenna	EMCI	LF R 400	N/A	100KHz~50MHz	N/A	Mar. 29, 2022	N/A	RF Near Field (TH03-HY)
AC Power Source	ChainTek	APC-1000W	N/A	N/A	N/A	May 30, 2022	N/A	Conduction (CO05-HY)
EMI Test Receiver	Rohde & Schwarz	ESR3	102388	9kHz~3.6GHz	Dec. 01, 2021	May 30, 2022	Nov. 30, 2022	Conduction (CO05-HY)
Hygrometer	Testo	608-H1	34913912	N/A	Nov. 17, 2021	May 30, 2022	Nov. 16, 2022	Conduction (CO05-HY)
LISN	Rohde & Schwarz	ENV216	100080	9kHz~30MHz	Dec. 03, 2021	May 30, 2022	Dec. 02, 2022	Conduction (CO05-HY)
Software	Rohde & Schwarz	EMC32	N/A	N/A	N/A	May 30, 2022	N/A	Conduction (CO05-HY)
Pulse Limiter	SCHWARZBECK	VTSD 9561-F N	00691	N/A	Jul. 28, 2021	May 30, 2022	Jul. 27, 2022	Conduction (CO05-HY)
LISN Cable	MVE	RG-400	260260	N/A	Dec. 30, 2021	May 30, 2022	Dec. 29, 2022	Conduction (CO05-HY)



5. Uncertainty of Evaluation

Uncertainty of Conducted Emission Measurement (150 kHz ~ 30 MHz)

Measuring Uncertainty for a Level of Confidence of 95% ($U = 2Uc(y)$)	3.1 dB
---	--------

Uncertainty of Radiated Emission Measurement (9 kHz ~ 30 MHz)

Measuring Uncertainty for a Level of Confidence of 95% ($U = 2Uc(y)$)	3.7 dB
---	--------

Uncertainty of Radiated Emission Measurement (30 MHz ~ 1000 MHz)

Measuring Uncertainty for a Level of Confidence of 95% ($U = 2Uc(y)$)	5.8 dB
---	--------



Appendix A. Test Results of Conducted Emission Test

EUT Information

Report NO : 1O2919-05
 Test Mode : Mode 1
 Test Voltage : 120Vac/60Hz
 Phase : Line

Full Spectrum

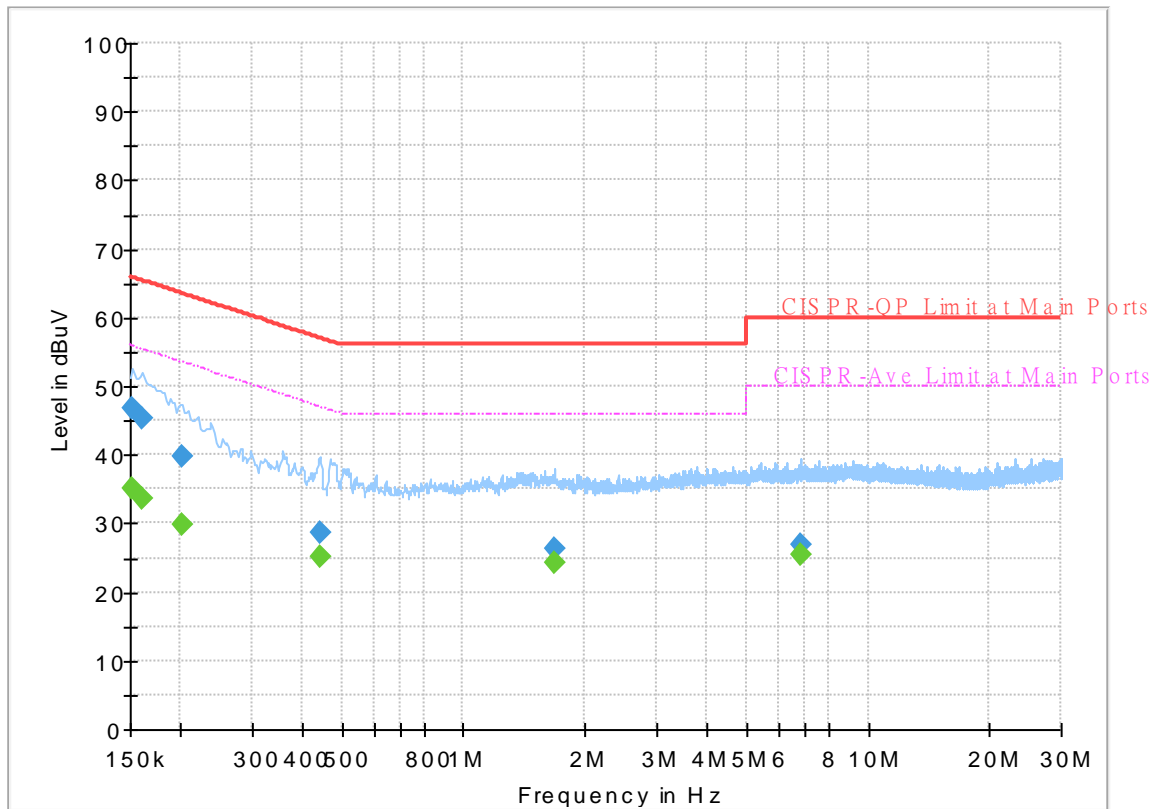

Final_Result

Frequency (MHz)	QuasiPeak (dBuV)	CAverage (dBuV)	Limit (dBuV)	Margin (dB)	Line	Filter	Corr. (dB)
0.152250	---	35.03	55.88	20.85	L1	OFF	19.6
0.152250	46.69	---	65.88	19.19	L1	OFF	19.6
0.161250	---	33.73	55.40	21.67	L1	OFF	19.6
0.161250	45.33	---	65.40	20.07	L1	OFF	19.6
0.201750	---	29.75	53.54	23.79	L1	OFF	19.6
0.201750	39.76	---	63.54	23.78	L1	OFF	19.6
0.442500	---	25.18	47.02	21.84	L1	OFF	19.6
0.442500	28.58	---	57.02	28.44	L1	OFF	19.6
1.680000	---	24.33	46.00	21.67	L1	OFF	19.7
1.680000	26.44	---	56.00	29.56	L1	OFF	19.7
6.801000	---	25.54	50.00	24.46	L1	OFF	19.9
6.801000	26.89	---	60.00	33.11	L1	OFF	19.9

EUT Information

Report NO : 1O2919-05
 Test Mode : Mode 1
 Test Voltage : 120Vac/60Hz
 Phase : Neutral

Full Spectrum

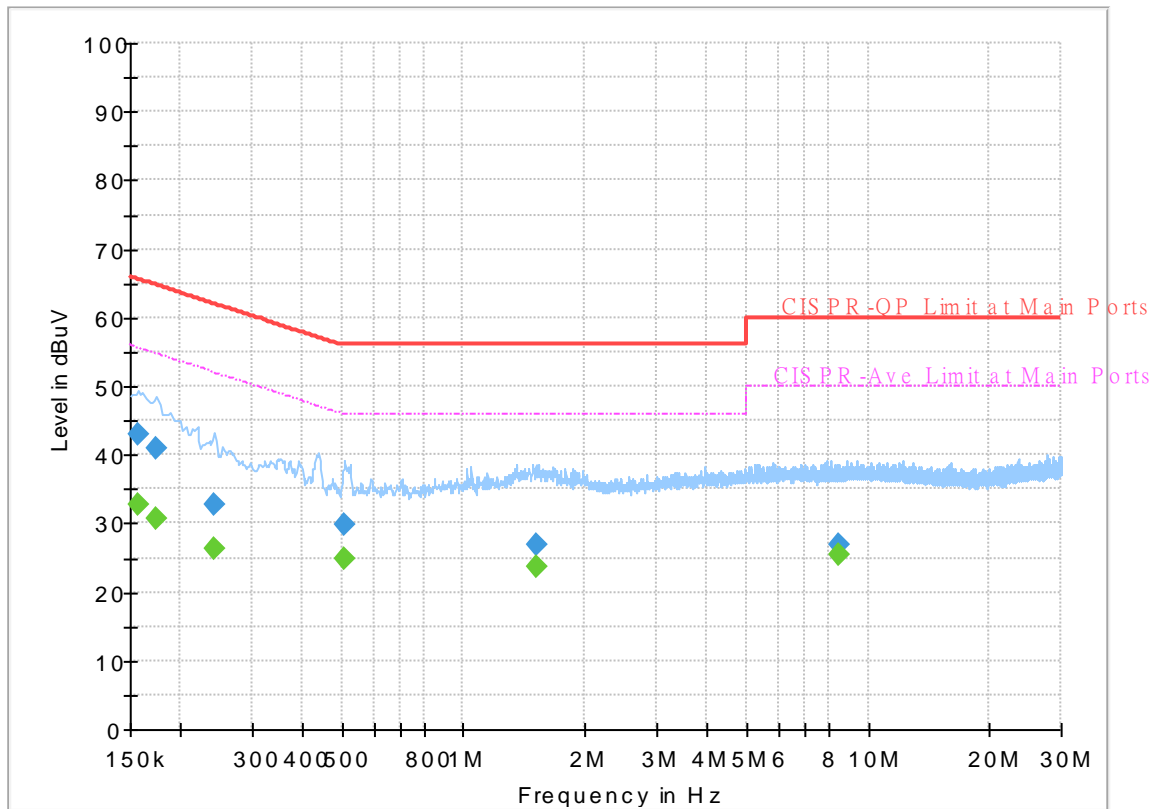

Final_Result

Frequency (MHz)	QuasiPeak (dBuV)	CAverage (dBuV)	Limit (dBuV)	Margin (dB)	Line	Filter	Corr. (dB)
0.156750	---	32.84	55.63	22.79	N	OFF	19.6
0.156750	42.96	---	65.63	22.67	N	OFF	19.6
0.174750	---	30.78	54.73	23.95	N	OFF	19.6
0.174750	40.83	---	64.73	23.90	N	OFF	19.6
0.242250	---	26.39	52.02	25.63	N	OFF	19.6
0.242250	32.64	---	62.02	29.38	N	OFF	19.6
0.507750	---	24.97	46.00	21.03	N	OFF	19.6
0.507750	29.72	---	56.00	26.28	N	OFF	19.6
1.509000	---	23.80	46.00	22.20	N	OFF	19.7
1.509000	26.77	---	56.00	29.23	N	OFF	19.7
8.457000	---	25.57	50.00	24.43	N	OFF	20.0
8.457000	26.91	---	60.00	33.09	N	OFF	20.0



Appendix B. Test Results of RF Near Field Test Items

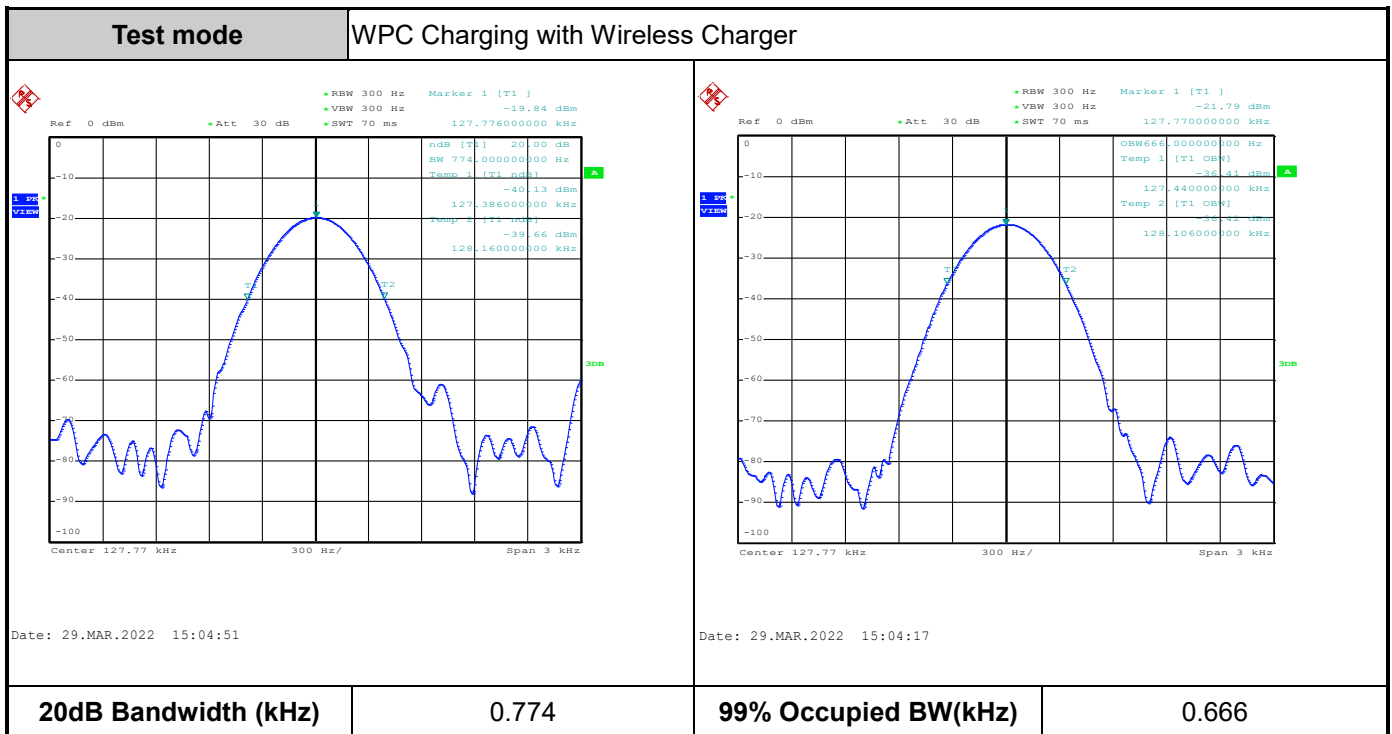
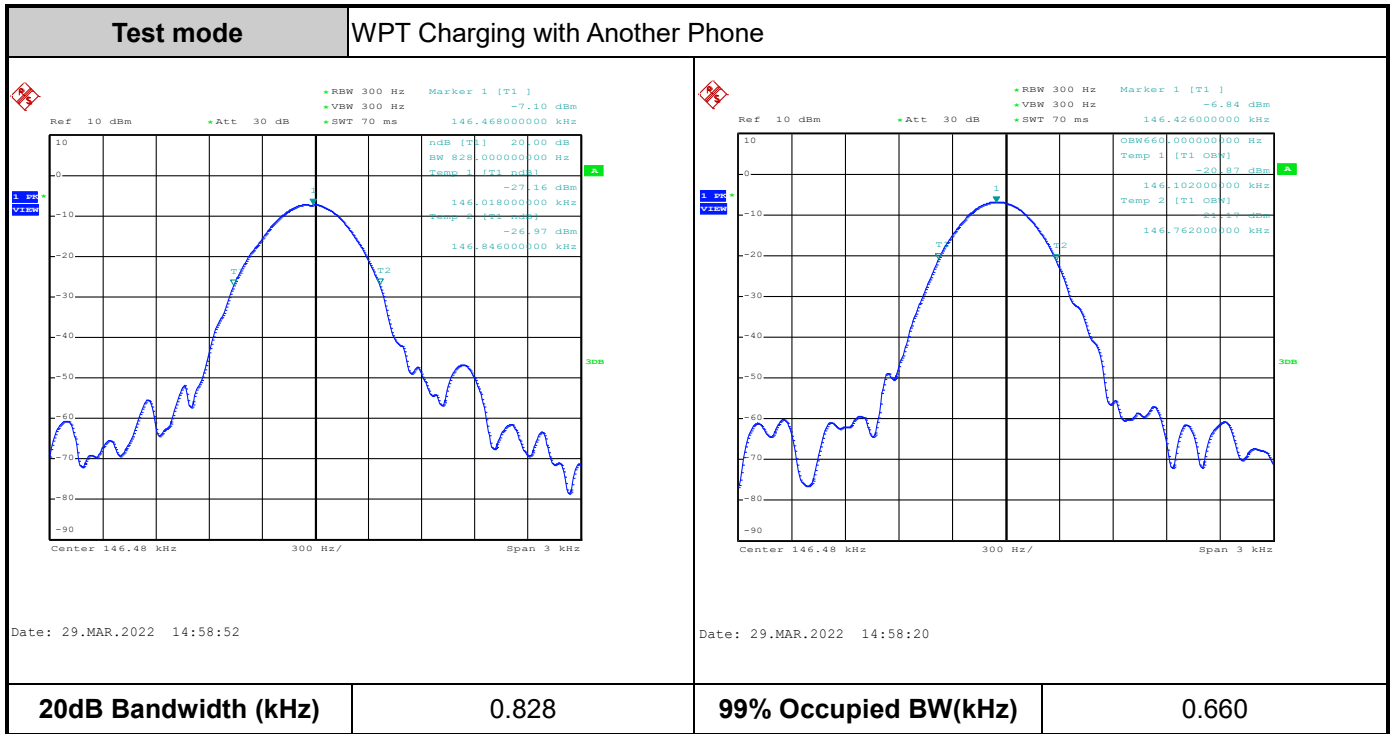

Remark: Because the measured signal is CW adjusting the RBW per C63.10 would not be practical since measured bandwidth will always follow the RBW and the result will be approximately twice the RBW.



Appendix C. Test Results of Radiated Test Items

C1. Test Result of Field Strength of Fundamental Emissions

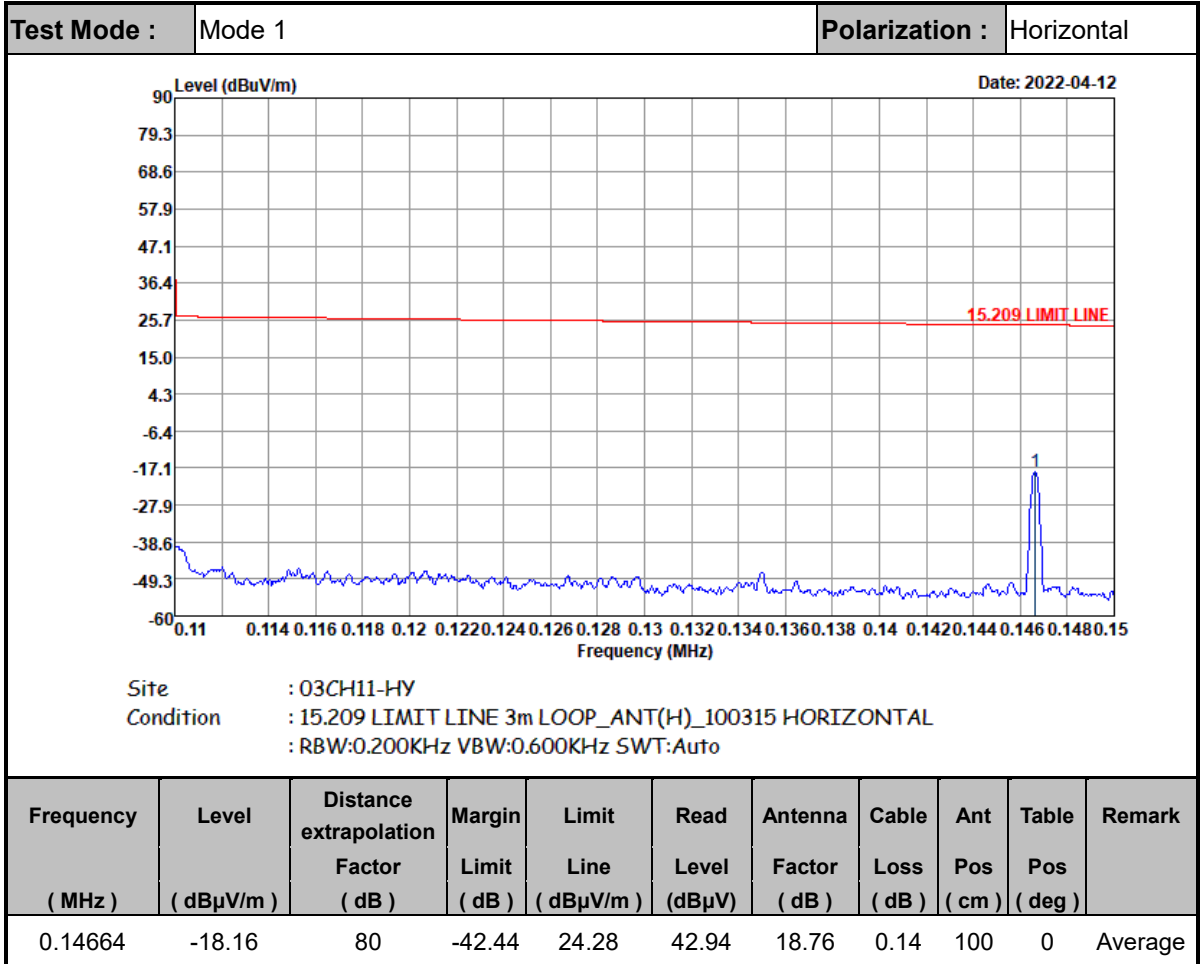

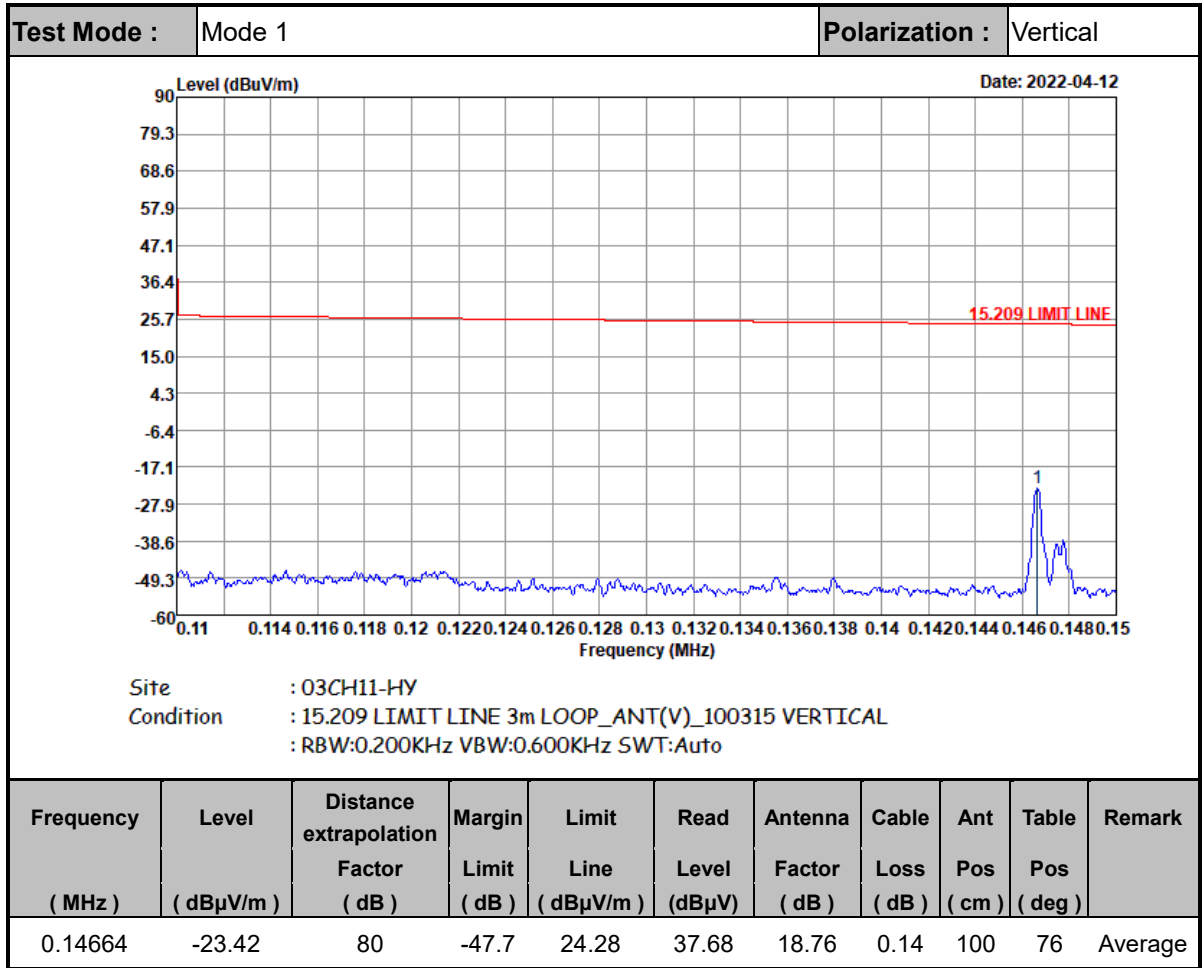

Note:

1. Distance extrapolation factor = 40 log (specific distance / test distance) (dB);
2. Level= Read Level + Antenna Factor + Cable loss + distance extrapolation factor.

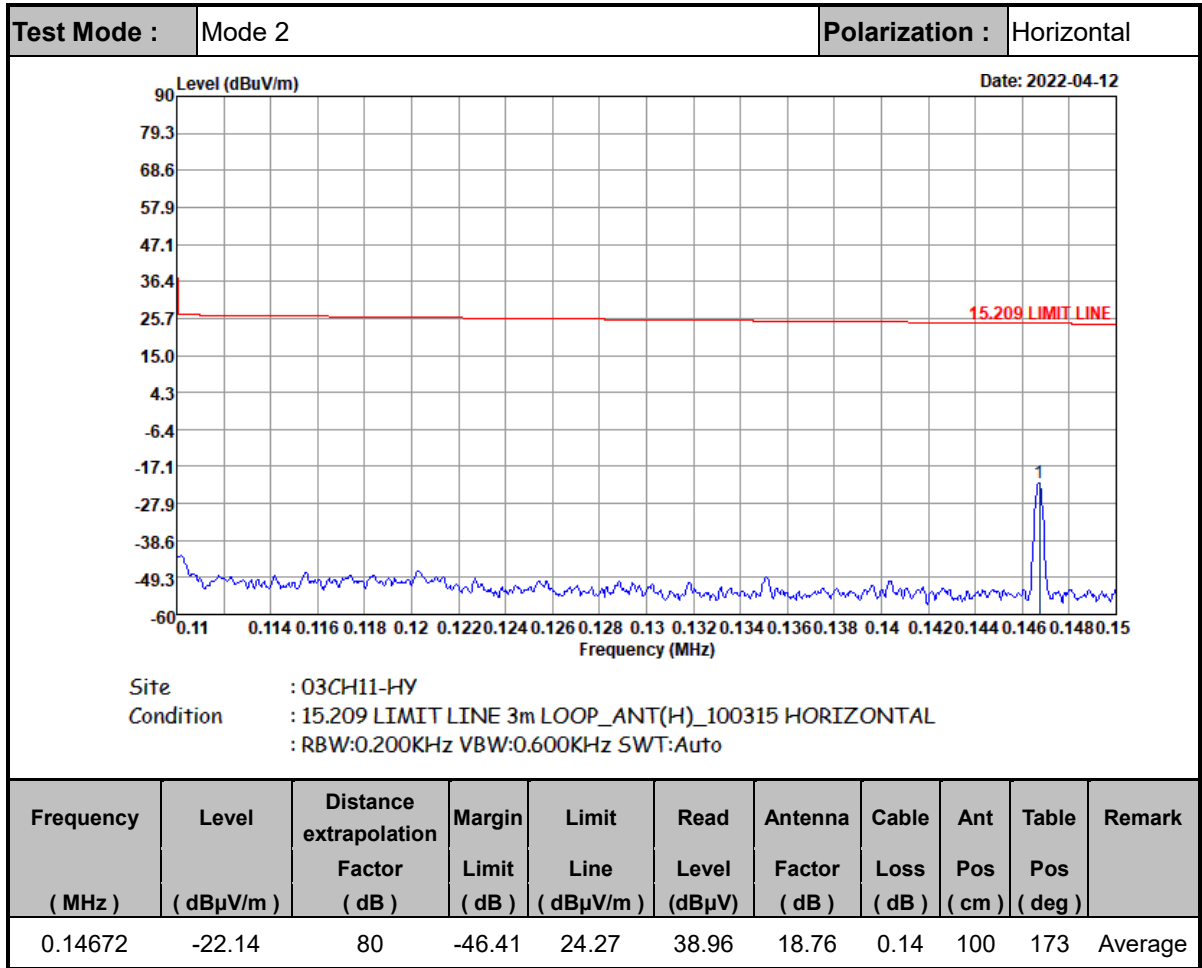

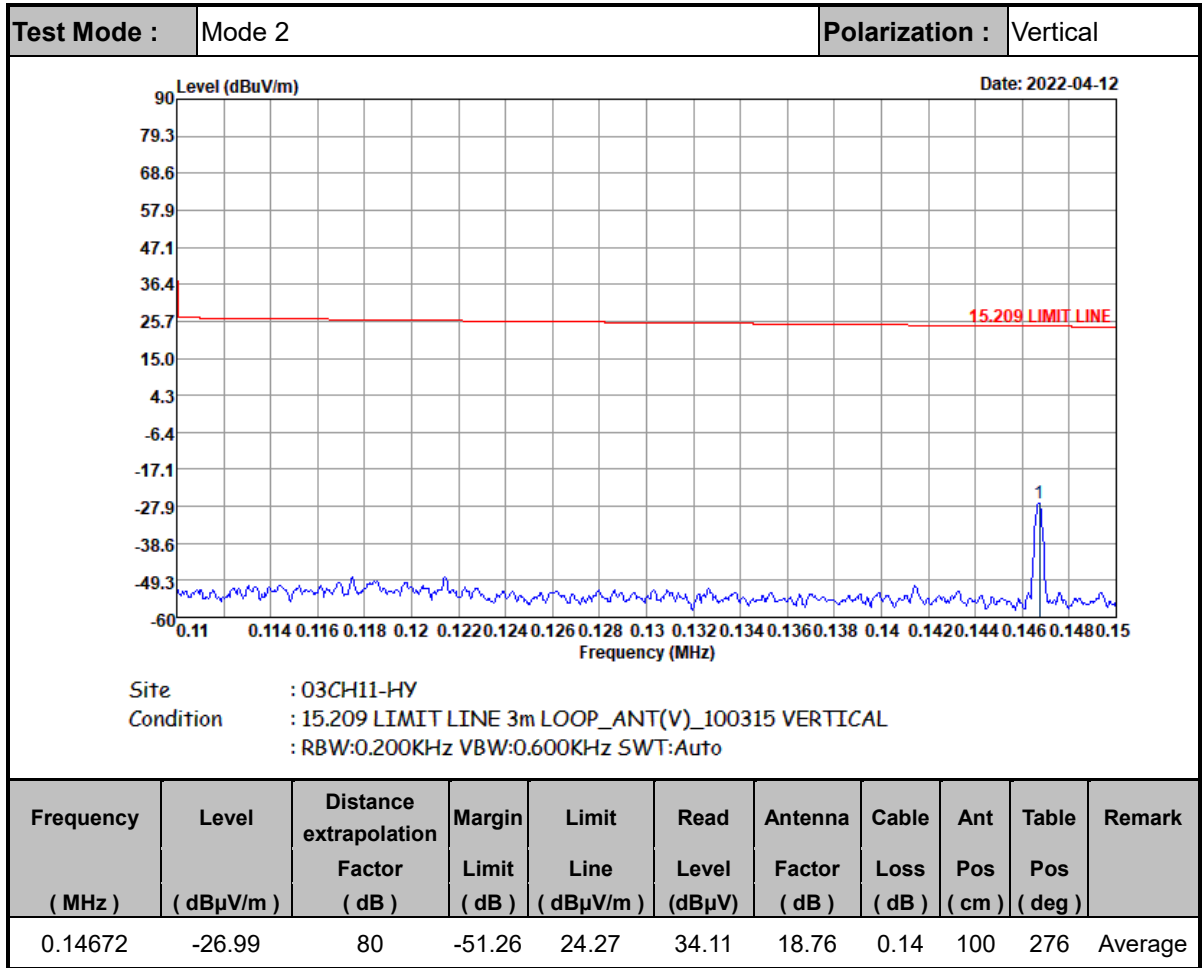

Note:

1. Distance extrapolation factor = 40 log (specific distance / test distance) (dB);
2. Level= Read Level + Antenna Factor + Cable loss + distance extrapolation factor.

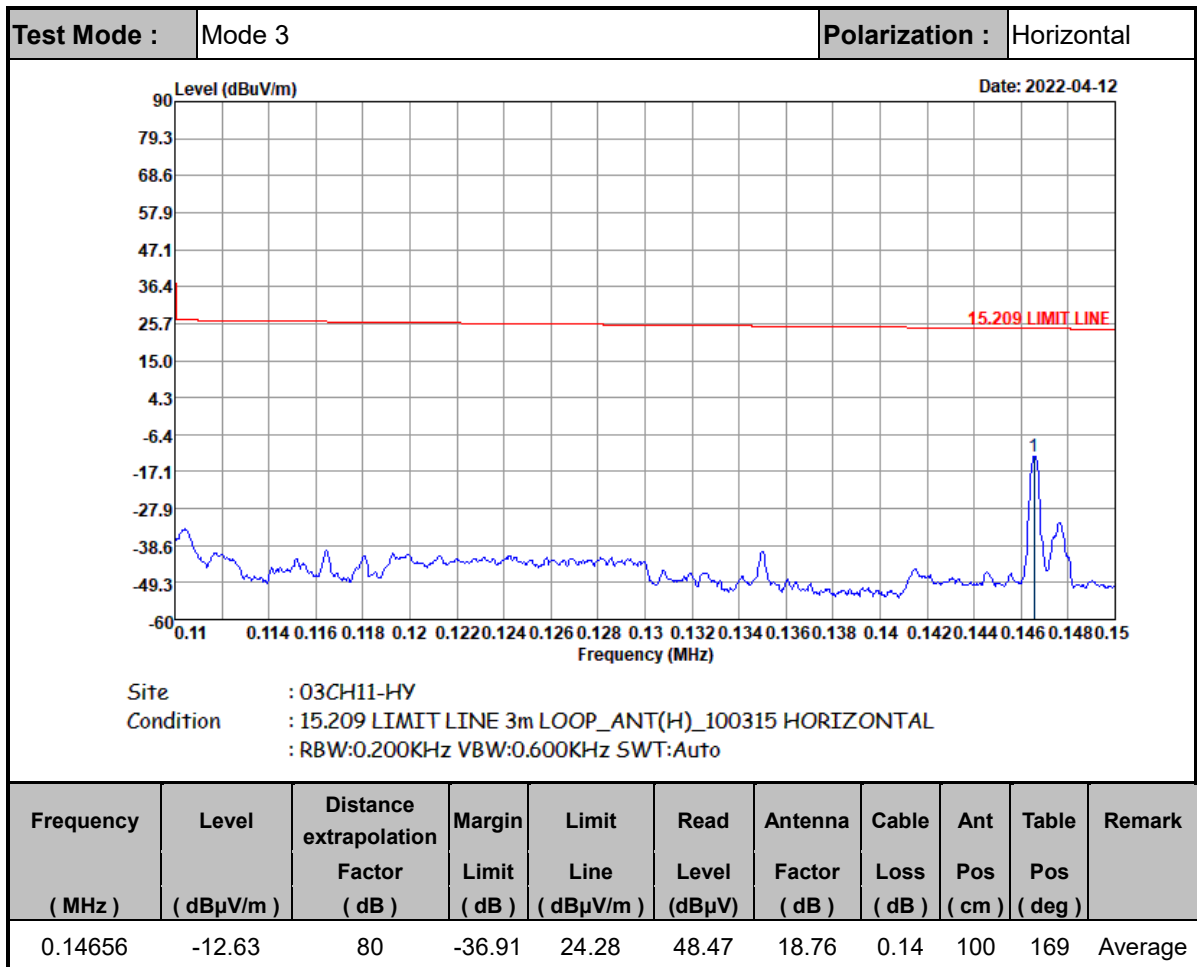

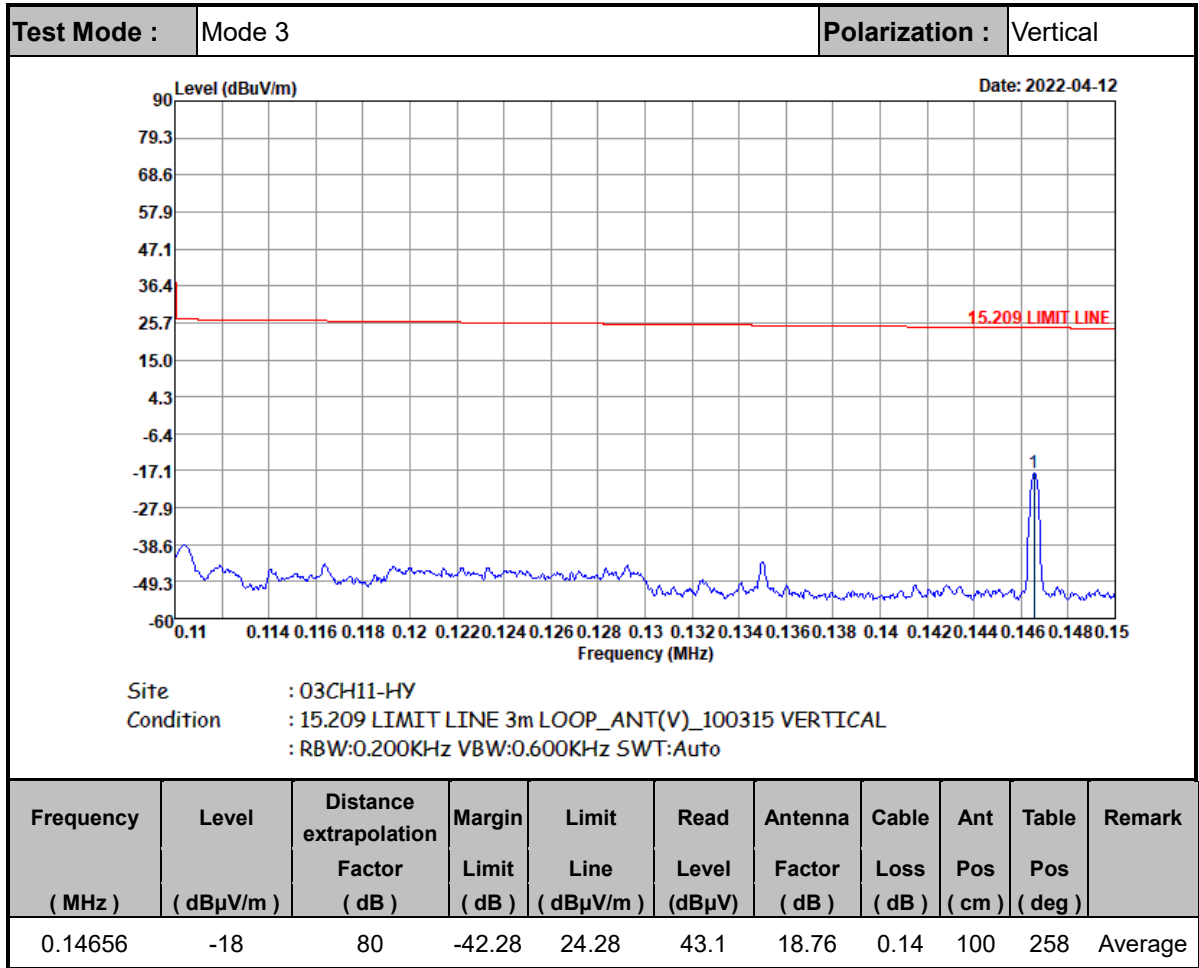

Note:

1. Distance extrapolation factor = 40 log (specific distance / test distance) (dB);
2. Level= Read Level + Antenna Factor + Cable loss + distance extrapolation factor.

C2. Results of Radiated Spurious Emissions (9 kHz~30MHz)

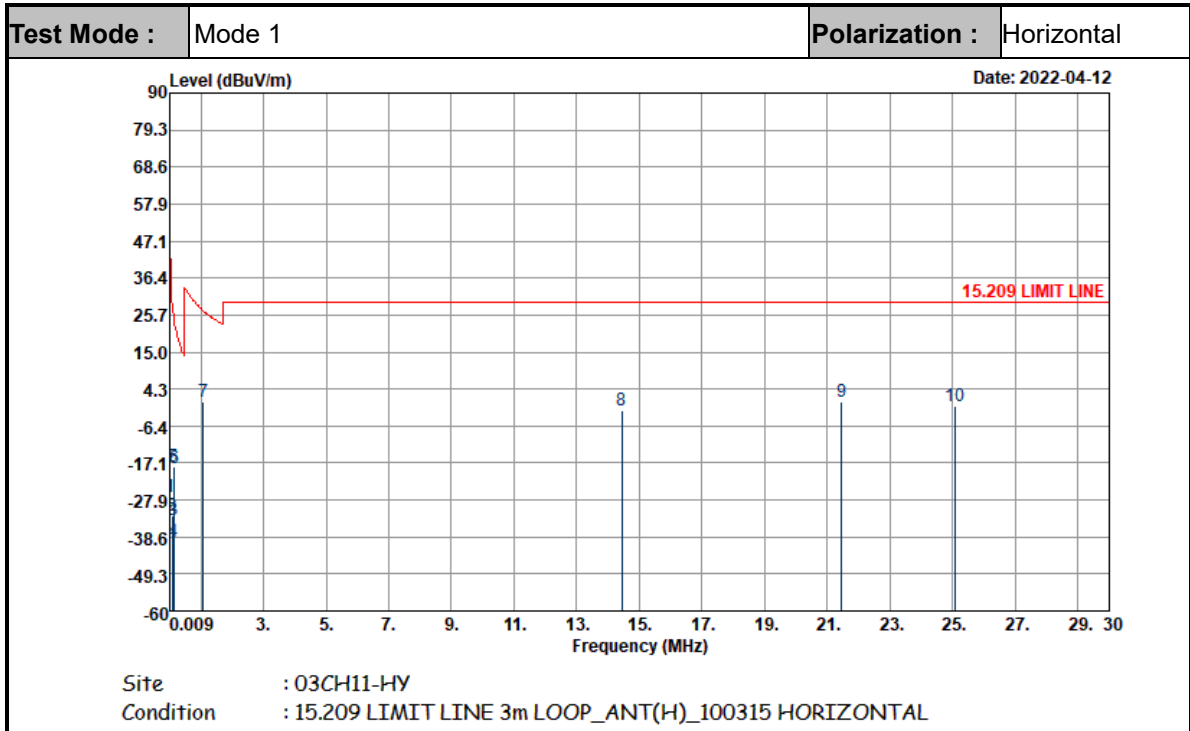

Frequency (MHz)	Level (dBuV/m)	Distance extrapolation Factor (dB)	Margin Limit (dB)	Limit Line (dBuV/m)	Read Level (dBuV)	Antenna Factor (dB)	Cable Loss (dB)	Ant Pos (cm)	Table Pos (deg)	Remark
0.0192	-26.85	80	-68.79	41.94	33.86	19.14	0.15	-	-	Average
0.08631	-32.23	80	-61.11	28.88	28.73	18.9	0.14	-	-	Average
0.1063	-33.6	80	-60.67	27.07	27.64	18.62	0.14	-	-	QP
0.11012	-39.8	80	-66.57	26.77	21.42	18.64	0.14	-	-	Average
0.14664	-18.16	80	-42.44	24.28	42.94	18.76	0.14	-	-	Average
0.15	-18.45	80	-42.53	24.08	42.64	18.77	0.14	-	-	Average
1.076	0.79	40	-26.18	26.97	20.96	19.7	0.13	-	-	QP
14.432	-2.03	40	-31.53	29.5	15.79	22	0.18	-	-	QP
21.463	0.77	40	-28.73	29.5	18.02	22.54	0.21	-	-	QP
25.075	-0.83	40	-30.33	29.5	16.29	22.65	0.23	-	-	QP

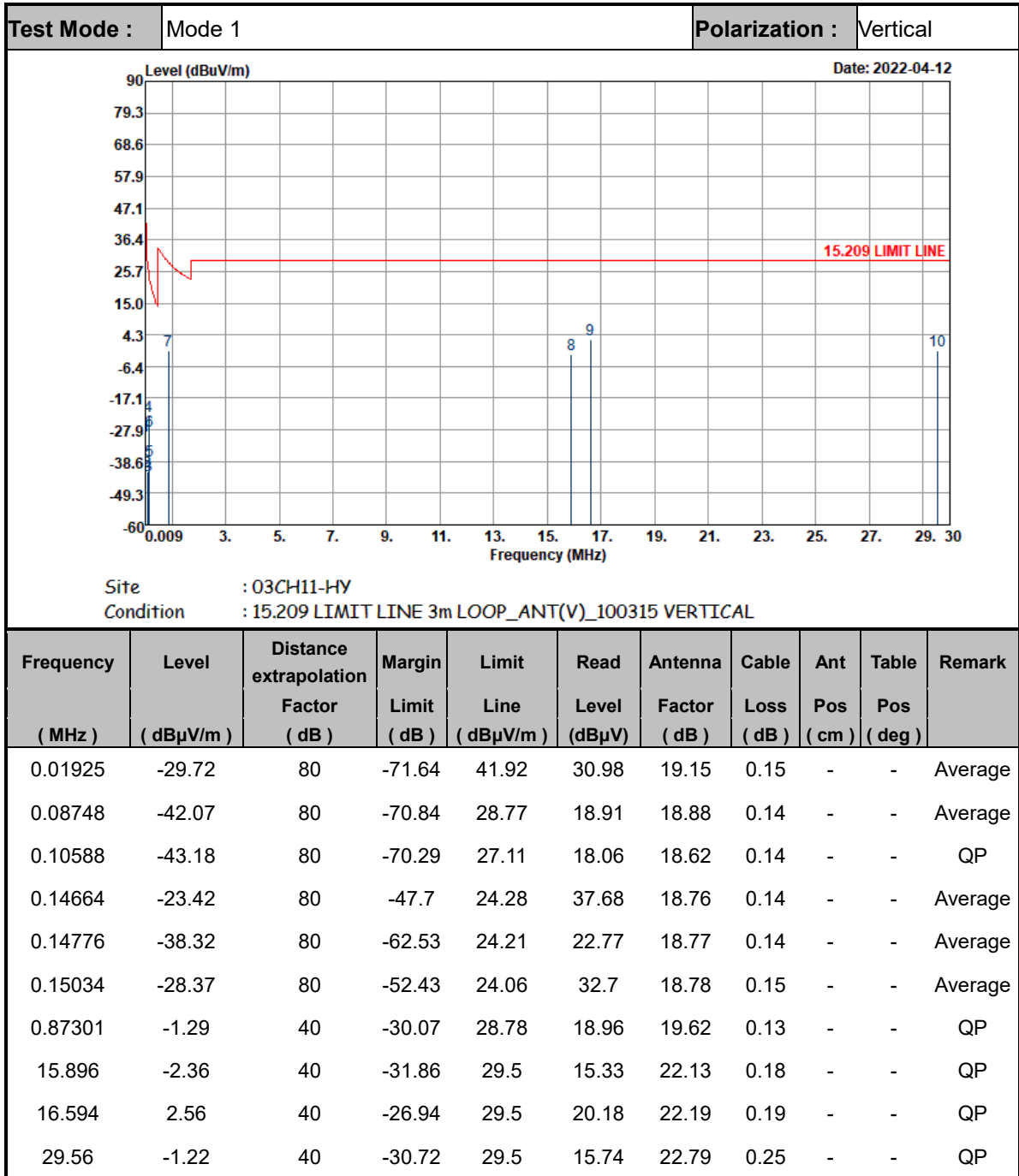

Note:

1. The amplitude of spurious emissions which are attenuated by more than 20dB below the permissible value has no need to be reported.
2. Distance extrapolation factor = 40 log (specific distance / test distance) (dB);
3. Level= Read Level + Antenna Factor + Cable loss + distance extrapolation factor.



Test Mode :	Mode 2	Polarization :	Horizontal
--------------------	--------	-----------------------	------------

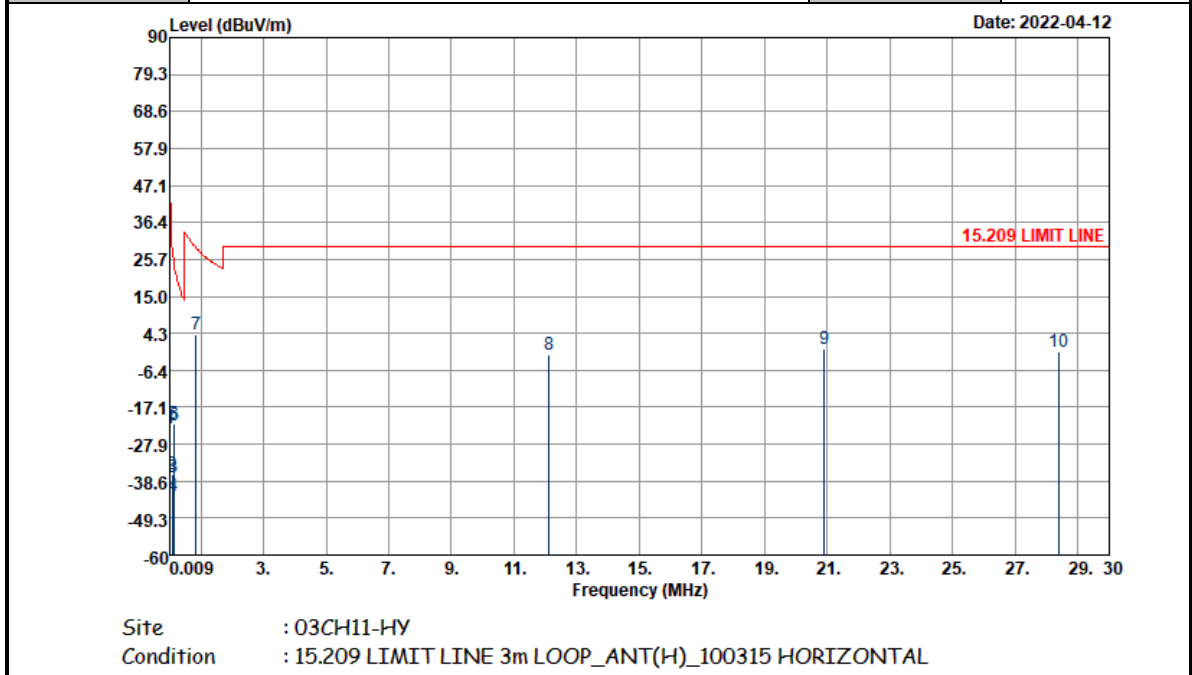

Frequency (MHz)	Level (dBuV/m)	Distance extrapolation Factor (dB)	Margin Limit (dB)	Limit Line (dBuV/m)	Read Level (dBuV)	Antenna Factor (dB)	Cable Loss (dB)	Ant Pos (cm)	Table Pos (deg)	Remark
0.01925	-23.03	80	-64.95	41.92	37.67	19.15	0.15	-	-	Average
0.08784	-36.8	80	-65.53	28.73	24.19	18.87	0.14	-	-	Average
0.10578	-37.23	80	-64.35	27.12	24.01	18.62	0.14	-	-	QP
0.11016	-42.99	80	-69.75	26.76	18.23	18.64	0.14	-	-	Average
0.14672	-22.14	80	-46.41	24.27	38.96	18.76	0.14	-	-	Average
0.15	-22.23	80	-46.31	24.08	38.85	18.77	0.15	-	-	Average
0.85799	3.8	40	-25.13	28.93	24.06	19.61	0.13	-	-	QP
12.128	-1.77	40	-31.27	29.5	16.28	21.79	0.16	-	-	QP
20.914	-0.35	40	-29.85	29.5	16.91	22.53	0.21	-	-	QP
28.41	-1.09	40	-30.59	29.5	15.92	22.75	0.24	-	-	QP

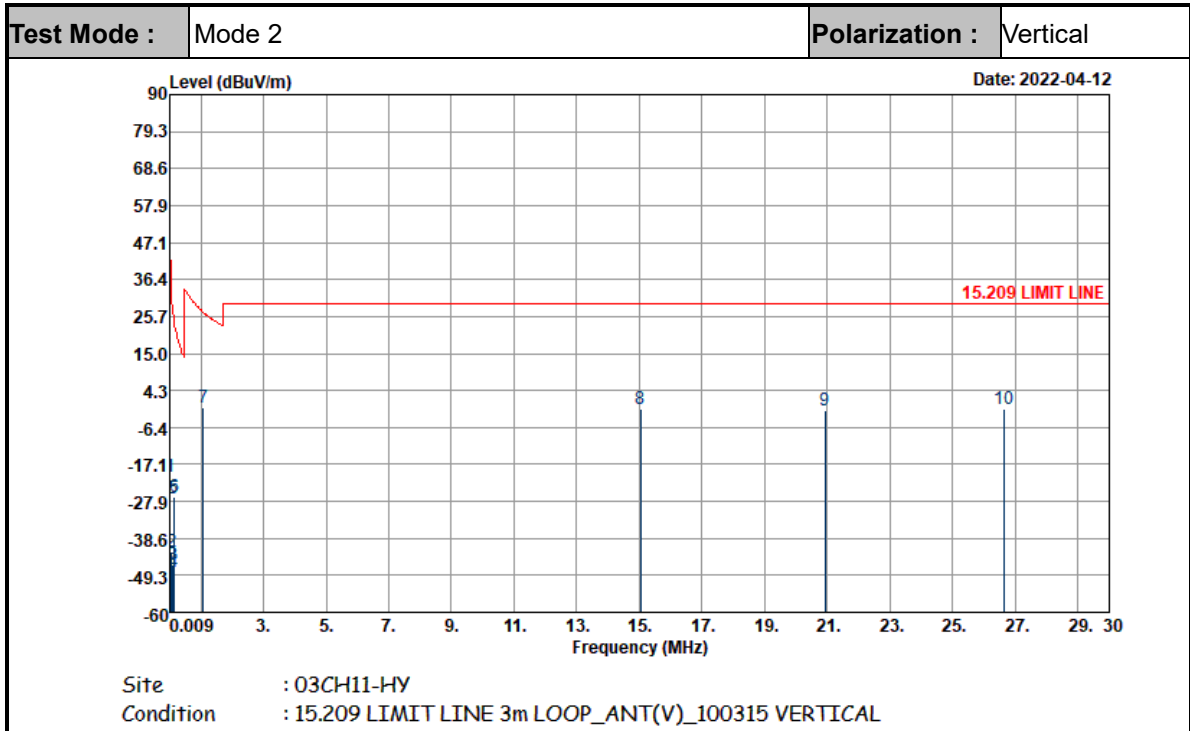

Frequency (MHz)	Level (dBμV/m)	Distance extrapolation Factor (dB)	Margin Limit (dB)	Limit Line (dBμV/m)	Read Level (dBμV)	Antenna Factor (dB)	Cable Loss (dB)	Ant Pos (cm)	Table Pos (deg)	Remark
0.0192	-20.86	80	-62.8	41.94	39.85	19.14	0.15	-	-	Average
0.06018	-42.45	80	-74.47	32.02	17.93	19.48	0.14	-	-	Average
0.101	-46.07	80	-73.59	27.52	15.19	18.6	0.14	-	-	QP
0.12144	-48.1	80	-74.02	25.92	13.08	18.68	0.14	-	-	Average
0.14672	-26.99	80	-51.26	24.27	34.11	18.76	0.14	-	-	Average
0.15	-26.44	80	-50.52	24.08	34.64	18.77	0.15	-	-	Average
1.068	-0.57	40	-27.6	27.03	19.6	19.7	0.13	-	-	QP
15.048	-1.23	40	-30.73	29.5	16.54	22.05	0.18	-	-	QP
20.932	-1.43	40	-30.93	29.5	15.83	22.53	0.21	-	-	QP
26.635	-1.12	40	-30.62	29.5	15.94	22.7	0.24	-	-	QP

Note:

1. The amplitude of spurious emissions which are attenuated by more than 20dB below the permissible value has no need to be reported.
2. Distance extrapolation factor = 40 log (specific distance / test distance) (dB);
3. Level= Read Level + Antenna Factor + Cable loss + distance extrapolation factor.

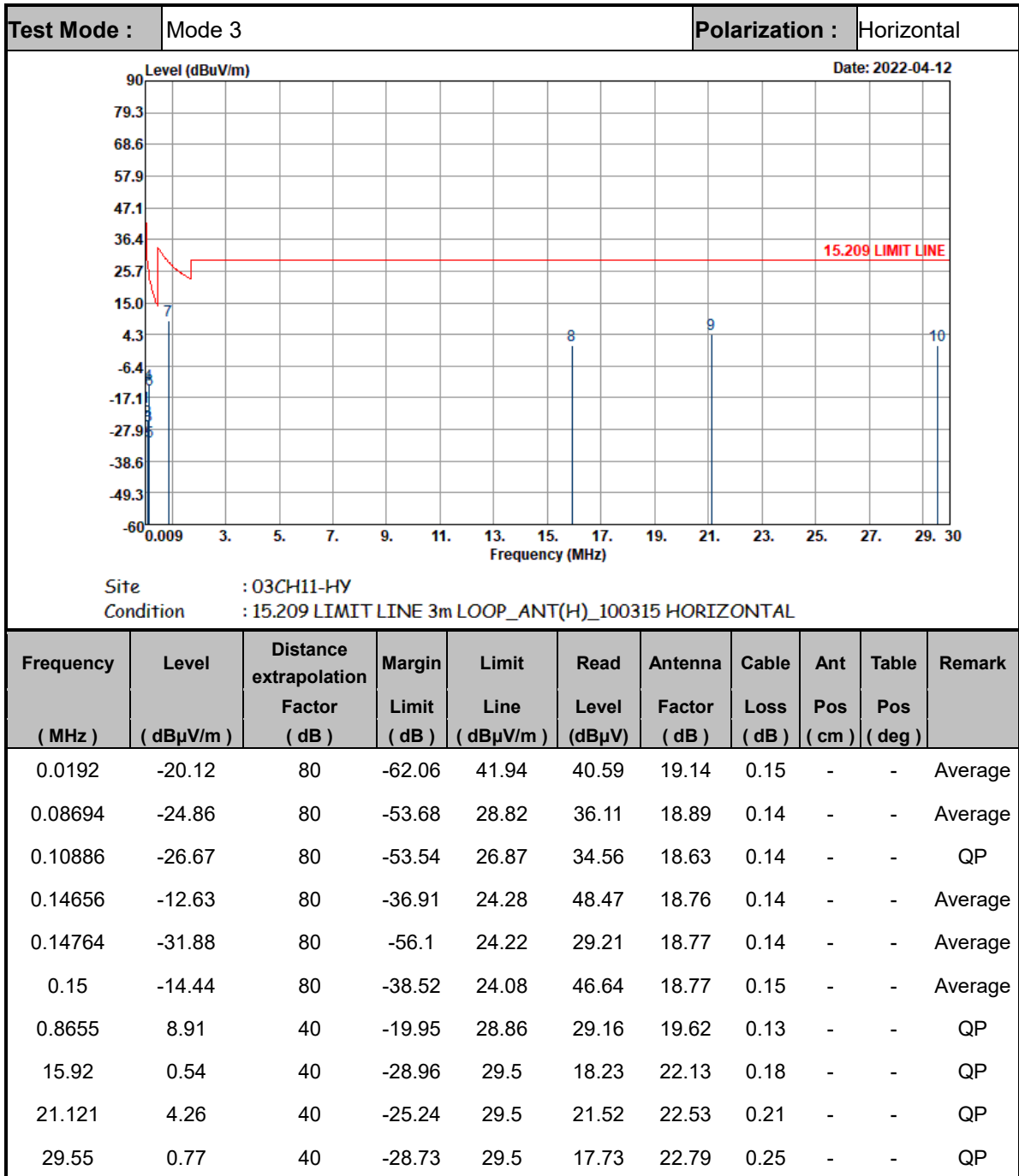

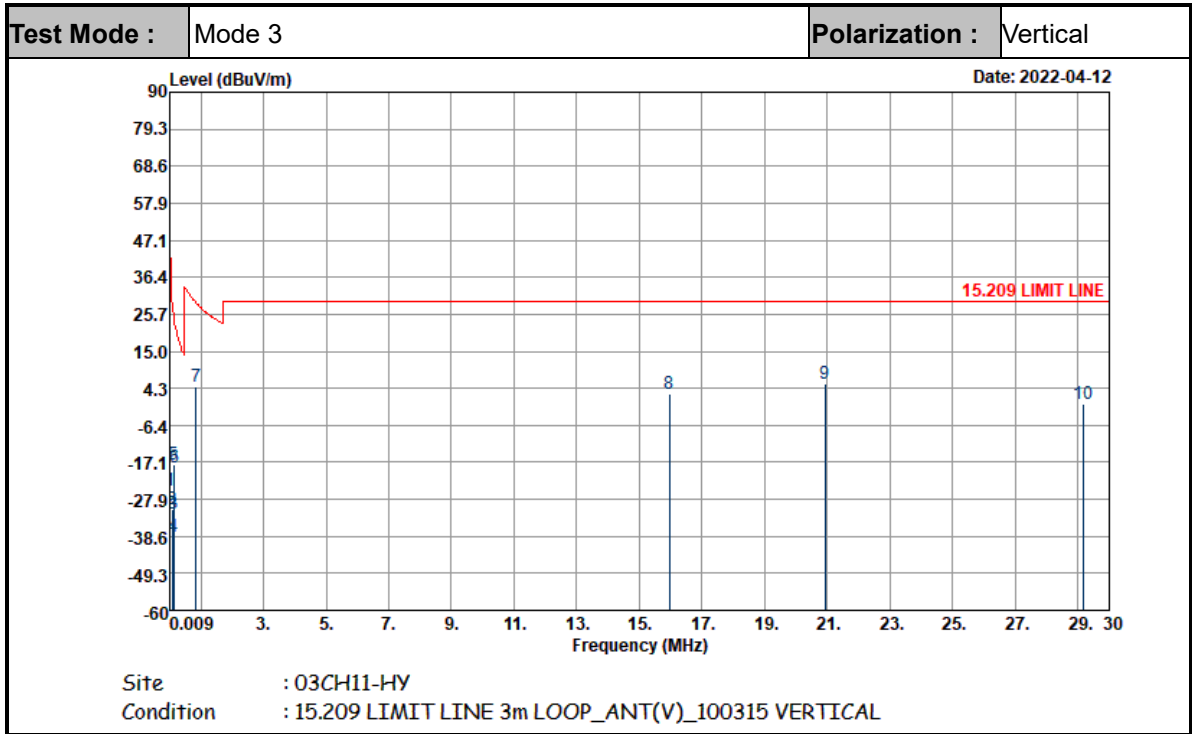

Frequency (MHz)	Level (dBuV/m)	Distance extrapolation Factor (dB)	Margin Limit (dB)	Limit Line (dBuV/m)	Read Level (dBuV)	Antenna Factor (dB)	Cable Loss (dB)	Ant Pos (cm)	Table Pos (deg)	Remark
0.0192	-25.53	80	-67.47	41.94	35.18	19.14	0.15	-	-	Average
0.08673	-30.75	80	-59.59	28.84	30.22	18.89	0.14	-	-	Average
0.10882	-31.83	80	-58.7	26.87	29.4	18.63	0.14	-	-	QP
0.1104	-38.63	80	-65.37	26.74	22.59	18.64	0.14	-	-	Average
0.14656	-18	80	-42.28	24.28	43.1	18.76	0.14	-	-	Average
0.15	-18.62	80	-42.7	24.08	42.46	18.77	0.15	-	-	Average
0.85048	4.82	40	-24.19	29.01	25.08	19.61	0.13	-	-	QP
15.952	2.67	40	-26.83	29.5	20.35	22.14	0.18	-	-	QP
20.932	5.47	40	-24.03	29.5	22.73	22.53	0.21	-	-	QP
29.15	-0.42	40	-29.92	29.5	16.56	22.77	0.25	-	-	QP

Note:

1. The amplitude of spurious emissions which are attenuated by more than 20dB below the permissible value has no need to be reported.
2. Distance extrapolation factor = 40 log (specific distance / test distance) (dB);
3. Level= Read Level + Antenna Factor + Cable loss + distance extrapolation factor.



C3. Results of Radiated Spurious Emissions (30MHz~1GHz)

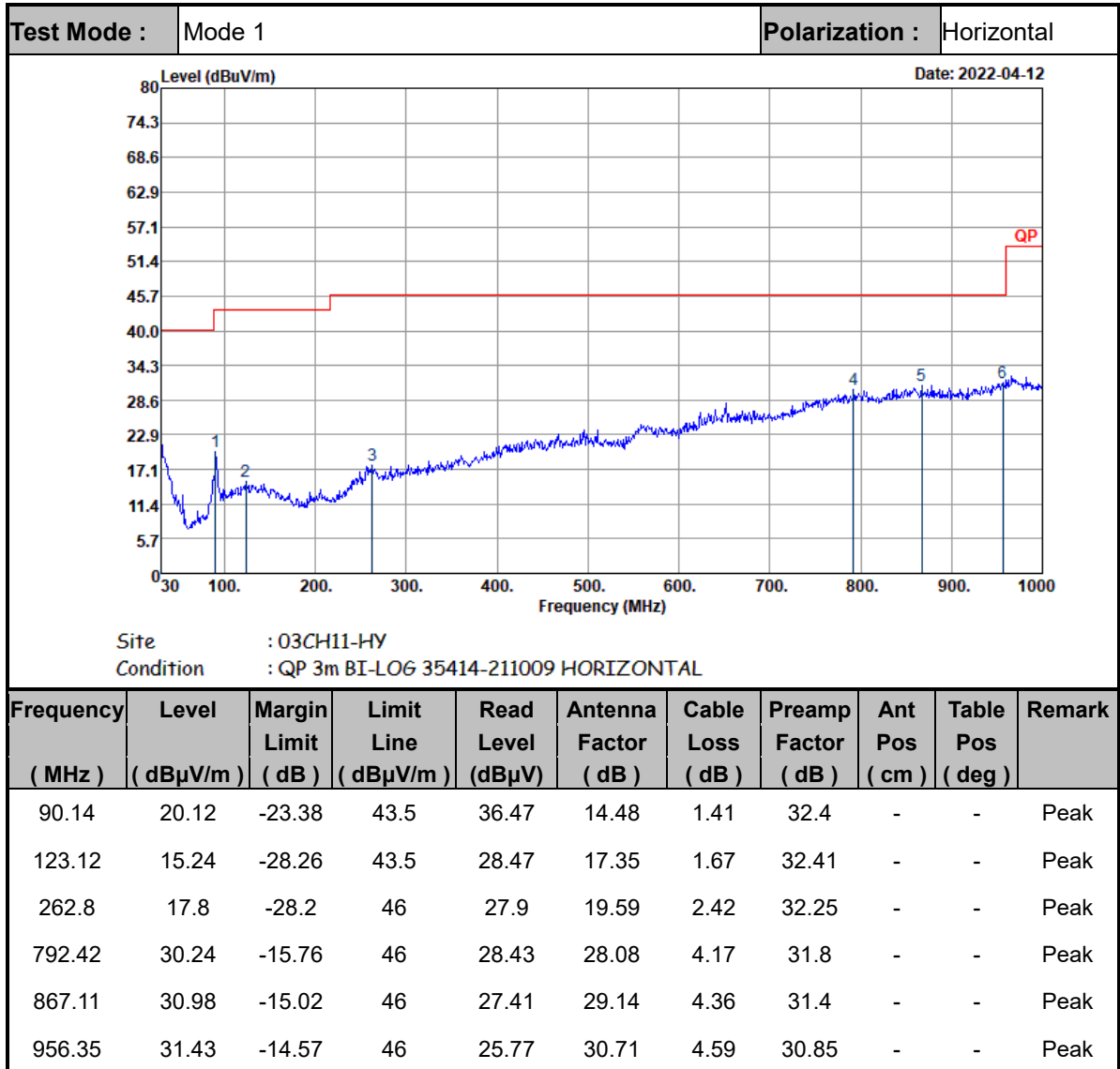

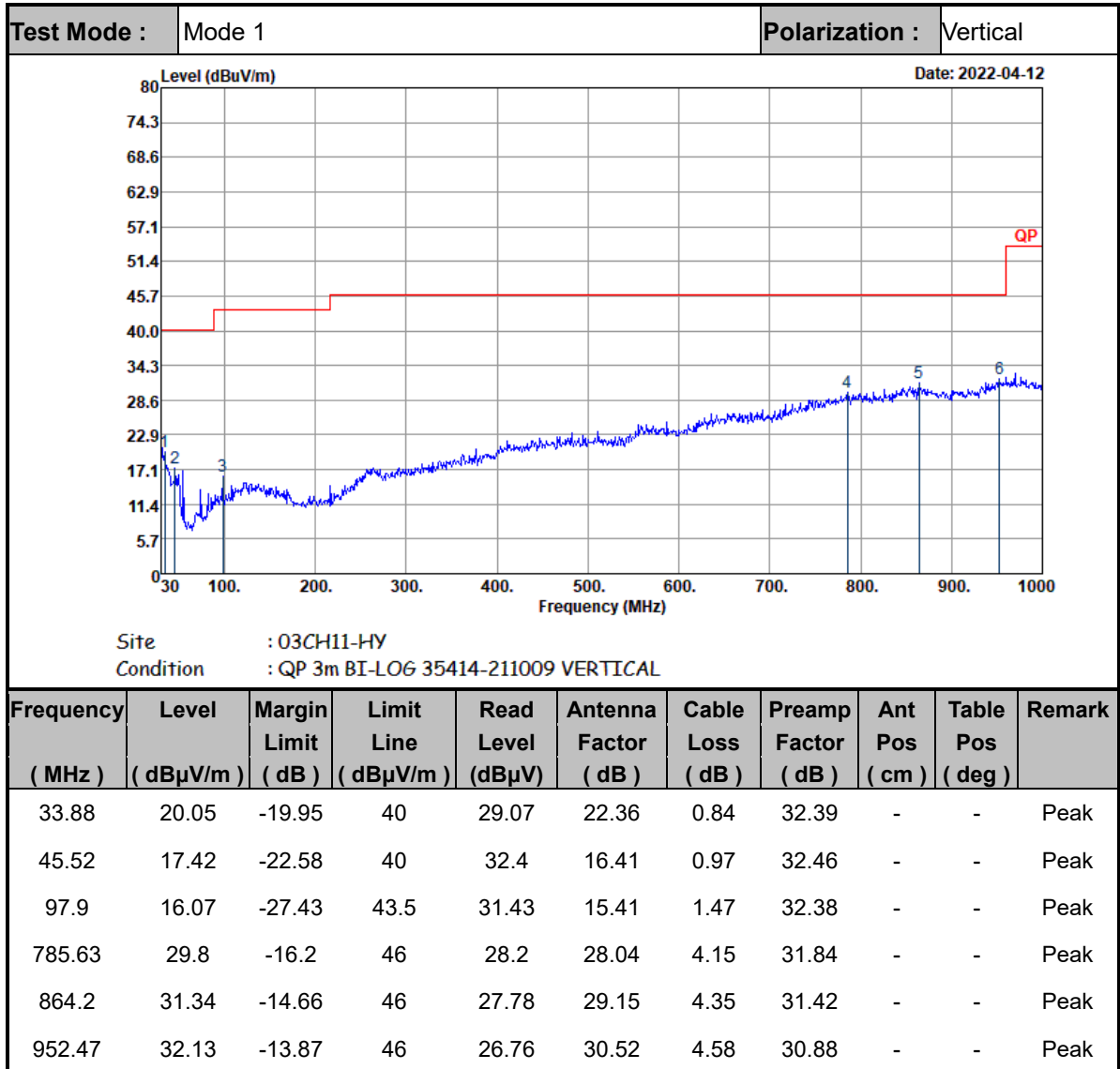

Note:

1. The amplitude of spurious emissions which are attenuated by more than 20dB below the permissible value has no need to be reported.
2. Emission level (dBμV/m) = 20 log Emission level (μV/m).
3. Corrected Reading: Antenna Factor + Cable Loss + Read Level - Preamp Factor= Level.

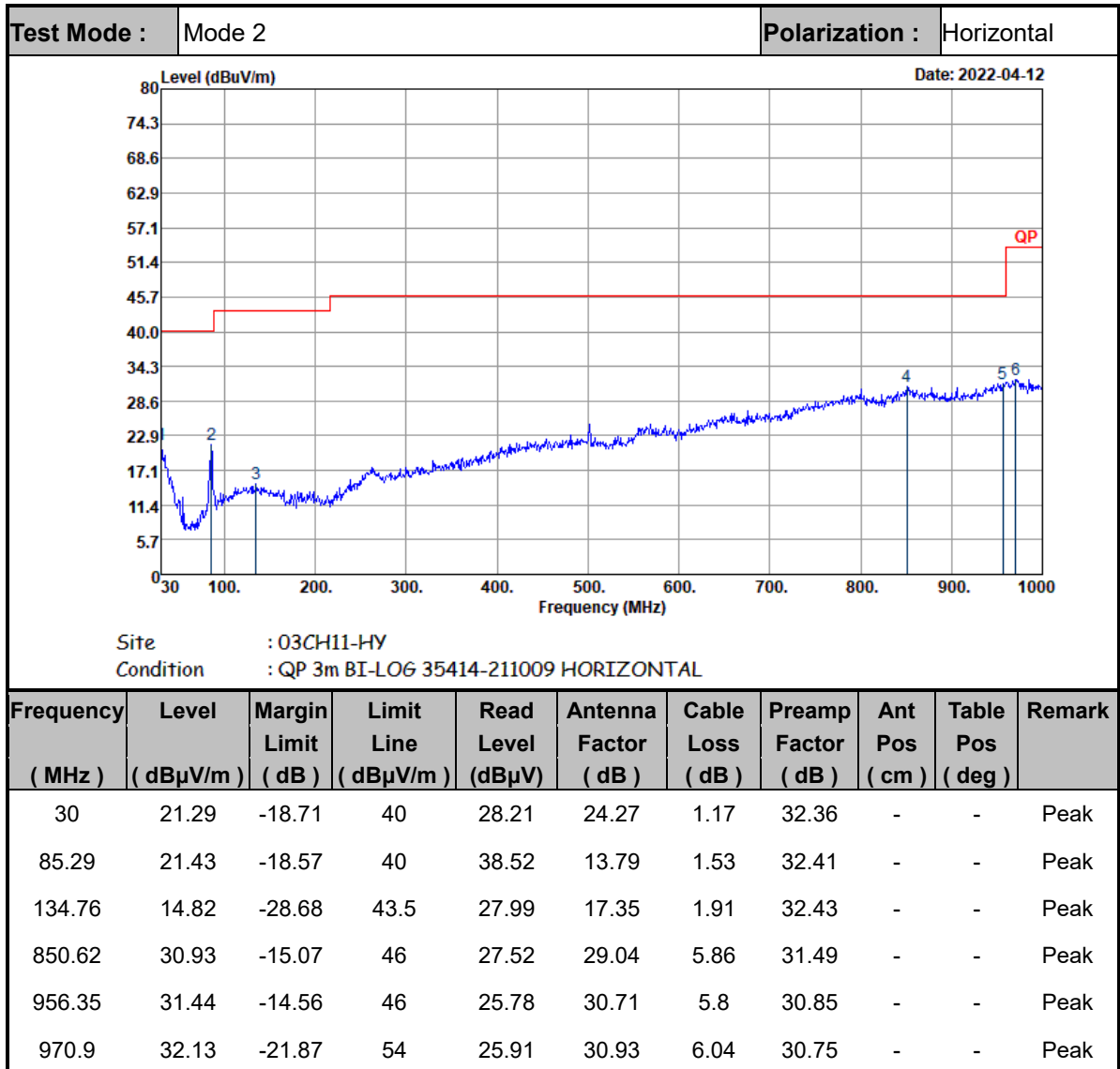

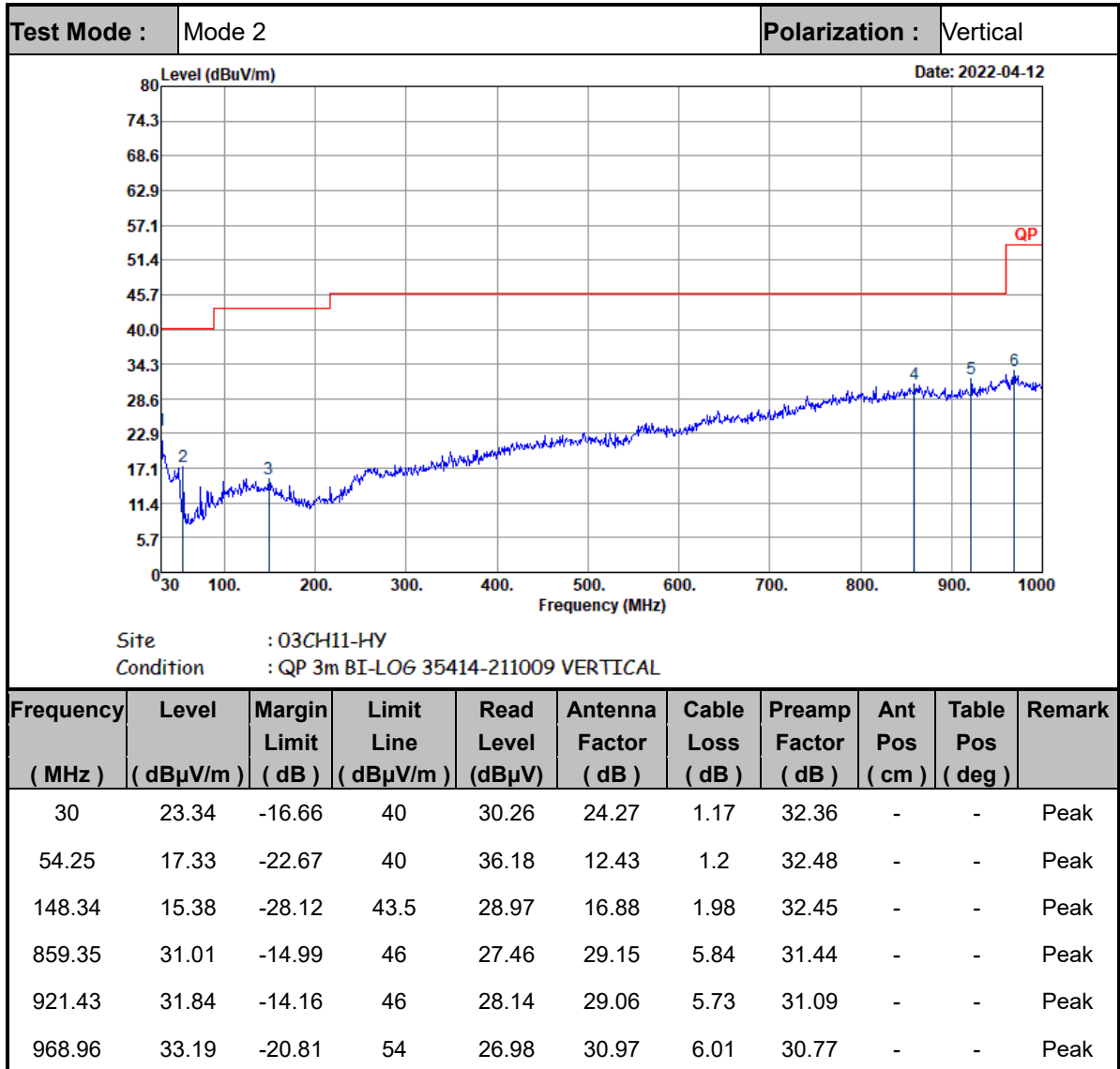

Note:

1. The amplitude of spurious emissions which are attenuated by more than 20dB below the permissible value has no need to be reported.
2. Emission level (dBμV/m) = 20 log Emission level (μV/m).
3. Corrected Reading: Antenna Factor + Cable Loss + Read Level - Preamp Factor= Level.

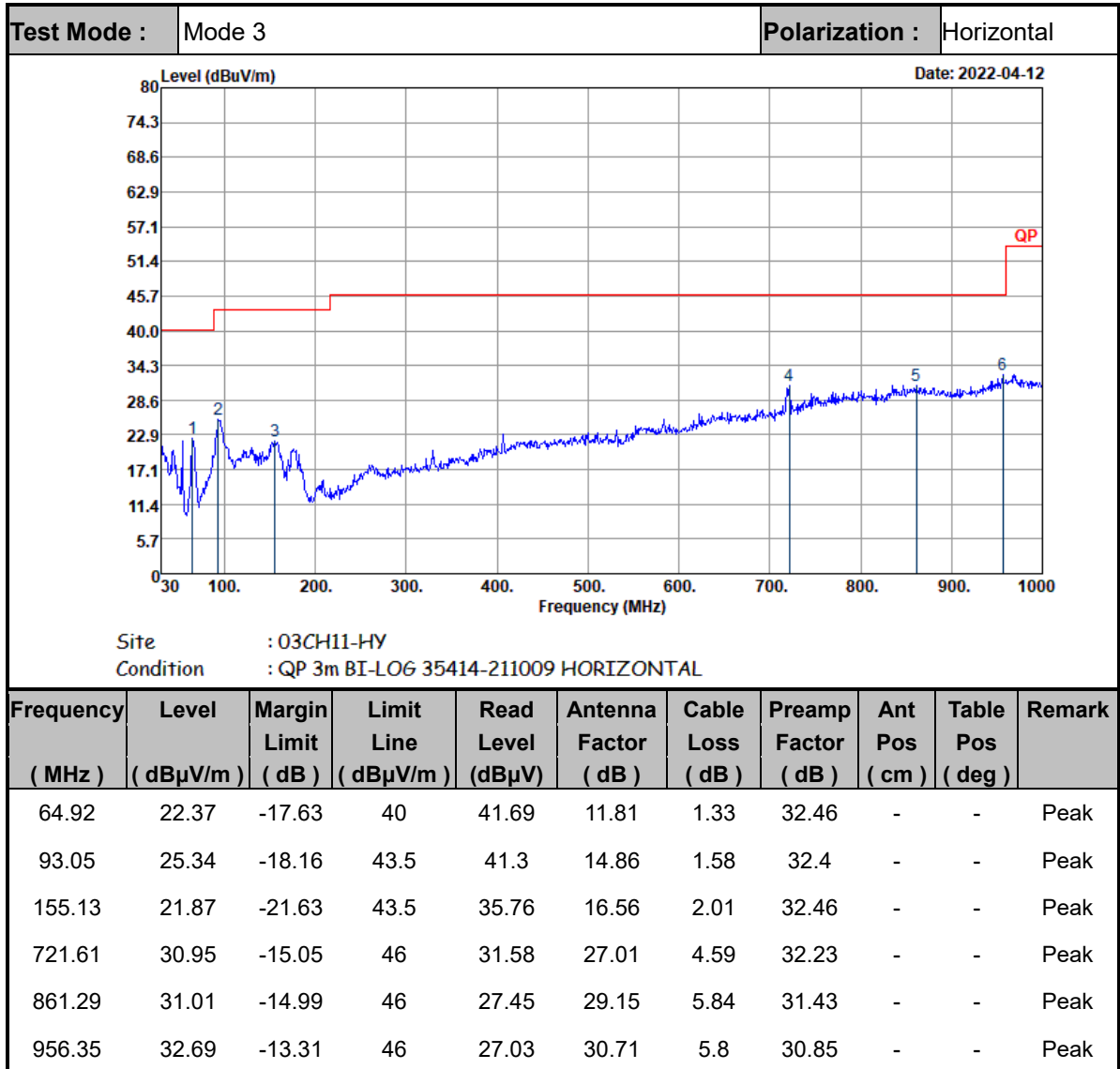

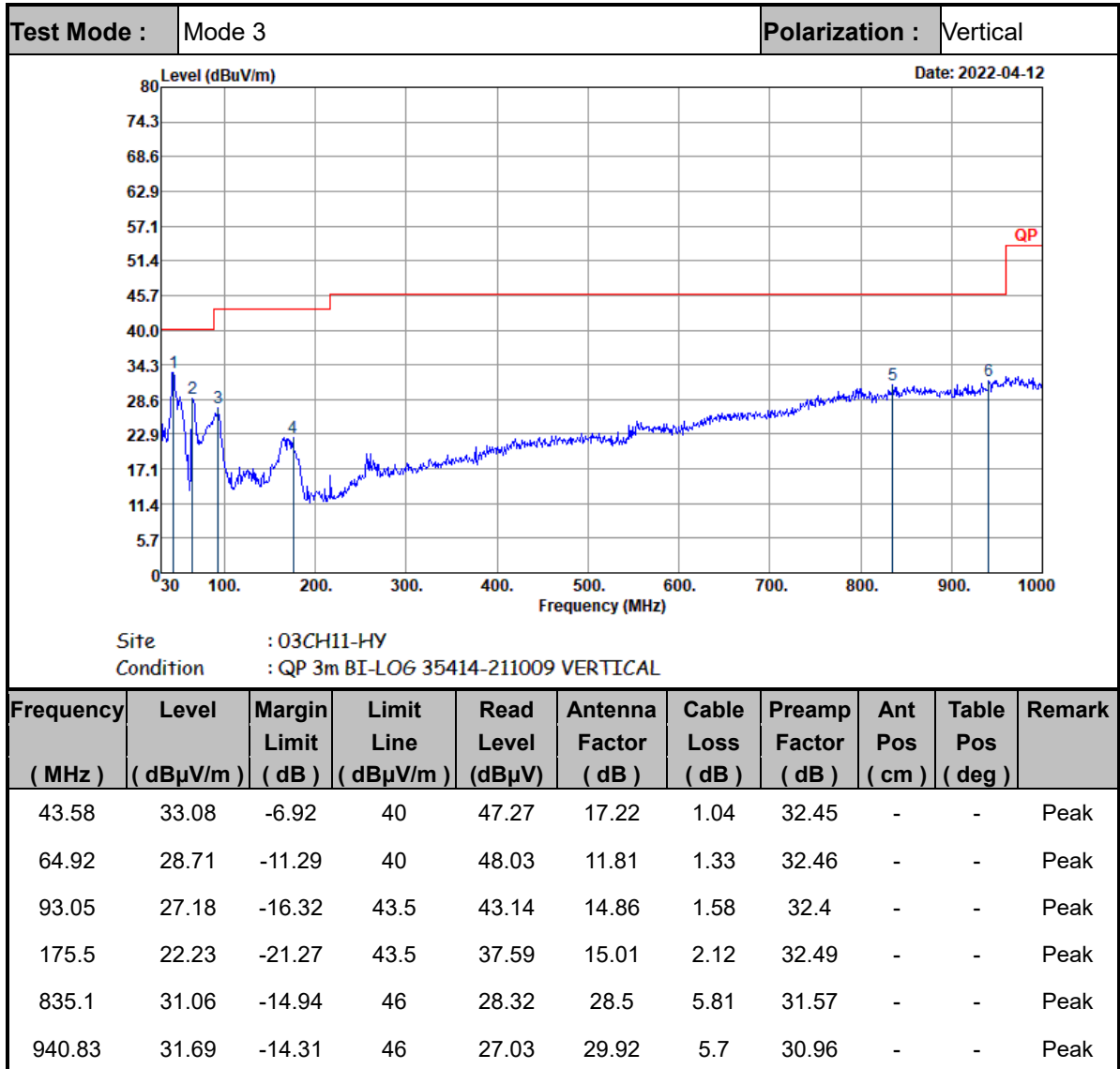

Note:

1. The amplitude of spurious emissions which are attenuated by more than 20dB below the permissible value has no need to be reported.
2. Emission level (dBμV/m) = 20 log Emission level (μV/m).
3. Corrected Reading: Antenna Factor + Cable Loss + Read Level - Preamp Factor= Level.

—————THE END—————