



FCC RADIO TEST REPORT

FCC ID : A4RGE2AE
Equipment : Phone
Applicant : Google LLC
1600 Amphitheatre Parkway,
Mountain View, California, 94043 USA
Standard : FCC 47 CFR Part 2, and 30

The product was received on Mar. 17, 2022 and testing was performed from Mar. 30, 2022 to May 10, 2022. We, Sporton International Inc. Wensan Laboratory, would like to declare that the tested sample has been evaluated in accordance with the test procedures ANSI C63.26-2015 and has been in compliance with the applicable technical standards.

The test results in this report apply exclusively to the tested model / sample. Without written Approval of Sporton International Inc. Wensan Laboratory, the test report shall not be reproduced except in full.

Approved by: Louis Wu

Sporton International Inc. Wensan Laboratory

No.58, Aly. 75, Ln. 564, Wenhua 3rd, Rd., Guishan Dist., Taoyuan City 333010, Taiwan (R.O.C.)



Table of Contents

History of this test report.....	3
Summary of Test Result.....	4
1 General Description	5
1.1 Feature of Equipment Under Test.....	5
1.2 Product Specification of Equipment Under Test	6
1.3 Modification of EUT	6
1.4 Testing Location	7
1.5 Applied Standards	7
2 Test Configuration of Equipment Under Test	8
2.1 Test Mode.....	8
2.2 Connection Diagram of Test System	9
2.3 Support Unit used in test configuration	10
2.4 Measurement Results Explanation Example	10
2.5 Far Field Condition for Frequency above 18GHz.....	11
2.6 Frequency List of Low/Middle/High Channels.....	12
3 Radiated Test Items	13
3.1 Measuring Instruments.....	13
3.2 Test Setup	13
3.3 Test Result of Radiated Test.....	16
3.4 EIRP Measurement	17
3.5 Occupied Bandwidth	18
3.6 Radiated Spurious Emission Measurement.....	19
3.7 Frequency Stability Measurement.....	20
4 List of Measuring Equipment.....	21
5 Uncertainty of Evaluation.....	23
Appendix A. Test Results of Conducted and Radiated Test	
Appendix B. R&S Mixer and Horn Antenna Calibration Reports	
Appendix C. Setup Photographs	



History of this test report

Report No.	Version	Description	Issued Date
FG1O2919-05M	01	Initial issue of report	May 26, 2022
FG1O2919-05M	02	1. Revise Table of Contents and Applied Standards 2. Revise Frequency Stability Voltage 3. Remove model name	Aug. 02, 2022



Summary of Test Result

Report Clause	Ref Std. Clause	Test Items	Limit	Result (PASS/FAIL)	Remark
3.4	§2.1046 §30.202	EIRP Measurement	+43dBm	Pass	-
3.5	§2.1049	Occupied Bandwidth	Not Applicable	Reporting only	-
3.6	§2.1053 §30.203	Radiated Spurious Emission	-5dBm/MHz -13dBm/MHz	Pass	-
3.7	§2.1055	Frequency Stability for Temperature & Voltage	Within the band	Pass	-

Declaration of Conformity:

1. The test results (PASS/FAIL) with all measurement uncertainty excluded are presented in accordance with the regulation limits or requirements declared by manufacturers. It's means measurement values may risk exceeding the limit of regulation standards, if measurement uncertainty is include in test results.
2. The measurement uncertainty please refer to this report "Uncertainty of Evaluation".

Comments and Explanations:

The product specifications of the EUT presented in the report are declared by the manufacturer who shall take full responsibility for the authenticity.

Reviewed by: William Chen

Report Producer: Cindy Liu



1 General Description

1.1 Feature of Equipment Under Test

Product Feature & Specification	
Equipment	Phone
FCC ID	A4RGE2AE
EUT supports Radios application	GSM/EGPRS/WCDMA/HSPA/LTE/5G NR/ NFC/GNSS/WPC/WPT/UWB WLAN 11b/g/n HT20 WLAN 11a/n HT20/HT40 WLAN 11ac VHT20/VHT40/VHT80/VHT160 WLAN 11ax HE20/HE40/HE80/HE160 Bluetooth BR/EDR/LE

Remark: The above EUT's information was declared by manufacturer.

EUT Information List	
S/N	Performed Test Item
22271FDH30002H	Conducted Measurement EIRP Radiated Spurious Emission



1.2 Product Specification of Equipment Under Test

Product Specification is subject to this standard	
Device Category in Part 30	Mobile station
Tx Frequency	NR band n258: 24.25GHz ~ 24.45GHz (258A) 24.75GHz ~ 25.25GHz (258B) NR band n260: 37GHz ~ 40GHz NR band n261: 27.5GHz ~ 28.35GHz
Rx Frequency	NR band n258: 24.25GHz ~ 24.45GHz (258A) 24.75GHz ~ 25.25GHz (258B) NR band n260: 37GHz ~ 40GHz NR band n261: 27.5GHz ~ 28.35GHz
Support Bandwidth	NR band n258: 50/100 MHz (1CC) and 200 MHz (2CC) NR band n260: 50/100 MHz (1CC) and 200 MHz (2CC) NR band n261: 50/100 MHz (1CC) and 200 MHz (2CC)
Maximum Number of contiguous CC	2
Maximum Aggregated Bandwidth	200MHz
Maximum Output Power (EIRP)	NR band n258A: Module A: 25.37 dBm Module B: 26.55 dBm NR band n258B: Module A: 26.96 dBm Module B: 26.63 dBm NR band n260: Module A: 26.20 dBm Module B: 26.53 dBm NR band n261: Module A: 24.64 dBm Module B: 26.32 dBm
Type of Modulation	CP-OFDM: QPSK / 16QAM / 64QAM DFT-s-OFDM: Pi/2 BPSK / QPSK / 16QAM / 64QAM

Note 1: Highest EIRP was measured on Module A, dual beam case for n258B band.

Note 2: Highest EIRP was measured on Module B, dual beam case for n258B band.

Note 3: The above EUT's information was declared by manufacturer. Please refer to Comments and Explanations in report summary.

1.3 Modification of EUT

No modifications are made to the EUT during all test items.



1.4 Testing Location

Test Site	Sporton International Inc. Wensan Laboratory			
Test Site Location	No.58, Aly. 75, Ln. 564, Wenhua 3rd, Rd., Guishan Dist., Taoyuan City 333010, Taiwan (R.O.C.) TEL: +886-3-327-3456 FAX: +886-3-328-4978			
Test Site Information	Site No.	Engineer	Temperature	Humidity
	03CH10-HY	Yu Wang	22.6~23.4°C	58.3~60.5%
	03CH18-HY	Yu Wang	23.1~23.7°C	60.6~62.9%

Note 1: FCC Designation No.: TW3786

Note 2: The highest accredited frequency is 280GHz and the ISO 17025 accreditation letter can be found on TAF (Taiwan Accreditation Foundation) Website ([Website link](#)).

1.5 Applied Standards

According to the specifications of the manufacturer, the EUT must comply with the requirements of the following standards:

- ♦ FCC 47 CFR Part 2, 30
- ♦ ANSI C63.26-2015
- ♦ FCC KDB 971168 D01 Power Meas. License Digital Systems v03r01
- ♦ FCC KDB 842590 D01 Upper Microwave Flexible Use Service v01r02
- ♦ FCC KDB 414788 D01 Radiated Test Site v01r01.

Remark:

1. All test items were verified and recorded according to the standards and without any deviation during the test.
2. The TAF code is not including all the FCC KDB listed without accreditation.



2 Test Configuration of Equipment Under Test

EUT has total 2 millimeter wave antenna modules, Plane A and Plane B, with antenna type patch.

There are up to 2 beams H and V operation for each antenna module.

Any antenna module cannot transmit simultaneously with the other antenna modules.

Preliminary EIRP test was performed for all beam configurations in the anechoic chamber at the manufacturer’s facility so the EIRP worst case beam-pair were identified.

EIRP was investigated that the dual beam rated maximum EIRP is higher than single beam.

The NR radio operation is controlled via FTM mode (Factory mode).

The EUT is forced to operate continuously (100% duty cycle) with maximum output power during the test.

2.1 Test Mode

For radiated measurement, the pre-scan is performed to find the worst cases EUT position.

Test Items	Band	Bandwidth (MHz)			Modulation			RB #			Test Channel		
		50	100	200	QPSK	16QAM	64QAM	1	Inner Full	Outer Full	L	M	H
EIRP	n258 n260 n261	v	v	v	v	v	v	v	v	v	v	v	v
99% Occupied Bandwidth	n258 n260 n261	v	v	v	v	v	v	-	-	v	v	v	v
Out of Band Emission	n258 n260 n261	v	v	v	v	v	v	v	-	v	v	v	v
Spurious Emission	n258 n260 n261	v	v	v	v	-	-	v	-	-	v	v	v
Frequency Stability	n258 n260 n261	CW tone									-	v	-
Remark	<ol style="list-style-type: none"> The mark "v " means that this configuration is chosen for testing. The device is investigated from 9kHz to 200GHz of fundamental signal for radiated spurious emission test under different RB size and modulations in exploratory test. Subsequently, only the worst case emissions are reported. Both modulation type DFT-s OFDM and CP-OFDM are evaluated and reported. All the radiated test cases were performed with Adapter 1 and USB Cable 2. The out of band emission were measured radiated EIRP. 												

Note: EUT antenna gain information is not listed because all the measured results are radiated EIRP.

2.2 Connection Diagram of Test System

<For radiated emissions from 30MHz to 18GHz>

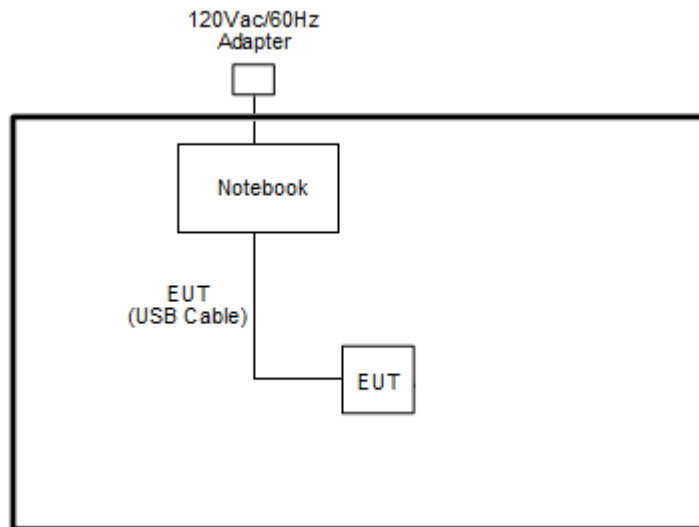

<For radiated emissions from 18GHz ~ 200GHz>

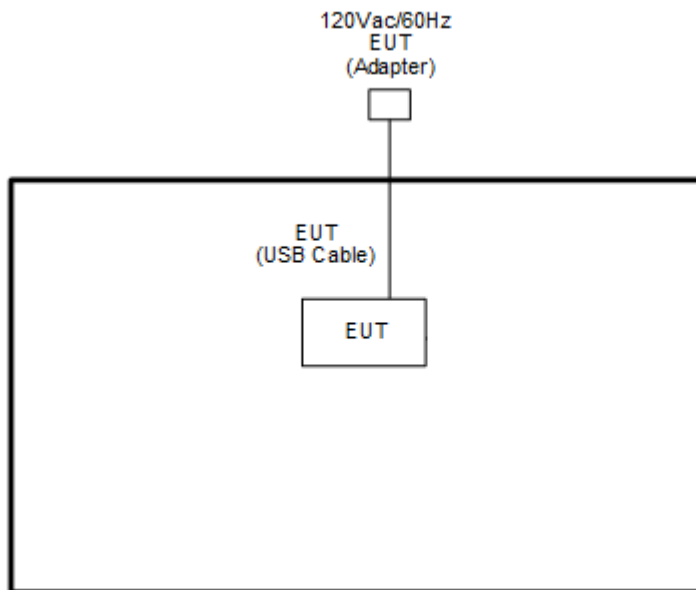



2.3 Support Unit used in test configuration

Item	Equipment	Brand Name	Model No.	FCC ID	Data Cable	Power Cord
1.	Notebook	Lenovo	TP00116E	FCC DoC	N/A	AC I/P: Unshielded, 1.2 m DC O/P: Shielded, 1.8 m

2.4 Measurement Results Explanation Example

According to ANSI C63.26-2015 Section 5.2.7

$$\text{EIRP (dBm)} = E(\text{dBuV/m}) + 20\log(D) - 104.8.$$

- where D is the measurement distance (in the far field region) in m.
- $E(\text{dBuV/m}) = \text{Spectrum Reading Level (dBm)} + \text{Antenna Factor (dB/m)} + \text{Cable Loss (dB)} + 107$

Hence, the spectrum analyzer *Offset* is derived including RF cable loss and antenna factor.

$$\text{Offset} = \text{Antenna Factor (dB/m)} + \text{Cable Loss (dB)} + 107 + 20\log(D) - 104.8$$

The conversion loss of RF mixer is also included by the mixer table of spectrum analyzer when measurement frequency is above 40GHz.

Example :

$$\begin{aligned} \text{Offset} &= \text{Antenna Factor (dB/m)} + \text{Cable Loss (dB)} + 107 + 20\log(D) - 104.8 \\ &= 42.3 + 3.0 + 107 + 20\log(1) - 104.8 \\ &= 47.5 \text{ (dB)} \end{aligned}$$



2.5 Far Field Condition for Frequency above 18GHz

Horn Antenna	Frequency (GHz)	Antenna Dimension A (mm)	Wavelength (λ) (m)	Far field R (m) $\geq 2A^2 / \lambda$	Measurement Distance (D) (m)	Distance Factor $20\log(D)$ (dB)
BBHA 9170	18	60	0.0167	0.43	1	0.00
	40	60	0.0075	0.96		
QWH-UPRR00	40	48	0.0075	0.61	1	0.00
	60	48	0.0050	0.92		
QWH-EPRR00	60	31	0.0050	0.38	1	0.00
	90	31	0.0033	0.58		
QWH-FPRR00	90	21	0.0033	0.26	1	0.00
	140	21	0.0021	0.41		
QWH-GPRR00	140	15	0.0021	0.21	0.5	-6.02
	220	15	0.0014	0.33		



2.6 Frequency List of Low/Middle/High Channels

NR Band n258A (24.25-25.45GHz) Frequency List				
BW [MHz]	Channel/Frequency(MHz)	Lowest	Middle	Highest
50	Frequency	24275	24350	24425
100	Frequency	24300	24350	24400
200	Frequency 1	-	24300	-
	Frequency 2	-	24400	-

NR Band n258B (24.75-25.25GHz) Frequency List				
BW [MHz]	Channel/Frequency(MHz)	Lowest	Middle	Highest
50	Frequency	24775	25000	25225
100	Frequency	24800	25000	25200
200	Frequency 1	24800	24950	25100
	Frequency 2	24900	25050	25200

NR Band n260 Channel and Frequency List				
BW [MHz]	Channel/Frequency(MHz)	Lowest	Middle	Highest
50	Frequency	37025	38500	39975
100	Frequency	37050	38500	39950
200	Frequency 1	37050	38450	39850
	Frequency 2	37150	38550	39950

NR Band n261 Channel and Frequency List				
BW [MHz]	Channel/Frequency(MHz)	Lowest	Middle	Highest
50	Frequency	27525	27925	28325
100	Frequency	27550	27925	28300
200	Frequency 1	27550	27875	28200
	Frequency 2	27650	27975	28300

3 Radiated Test Items

3.1 Measuring Instruments

Please refer to the measuring equipment list in this test report.

3.2 Test Setup

For radiated emissions from 9kHz to 30MHz

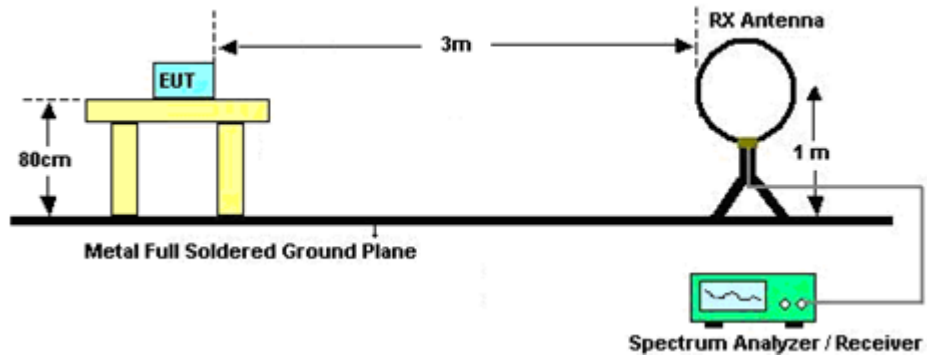

For radiated emissions from 30MHz to 1GHz

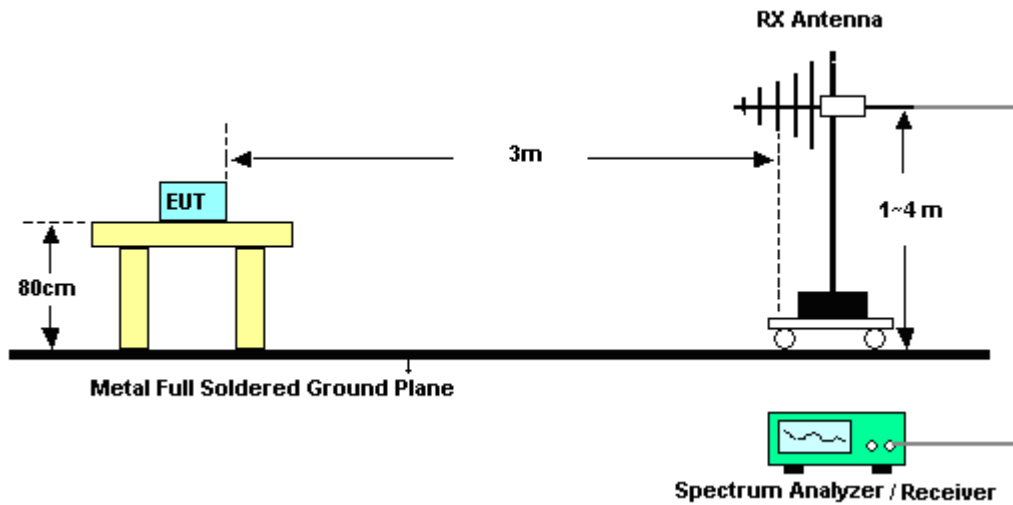

For radiated emissions 1GHz to 18GHz

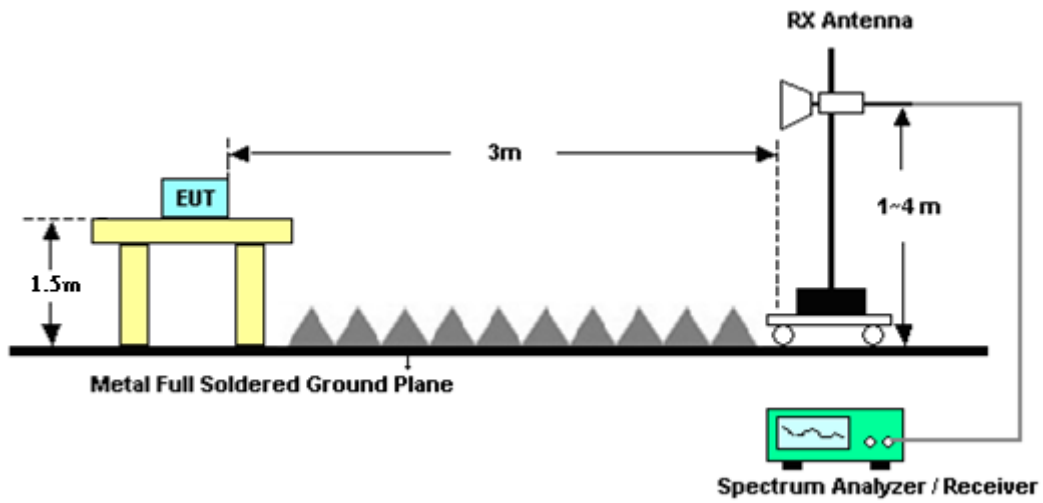

For radiated emissions from 18GHz to 40GHz

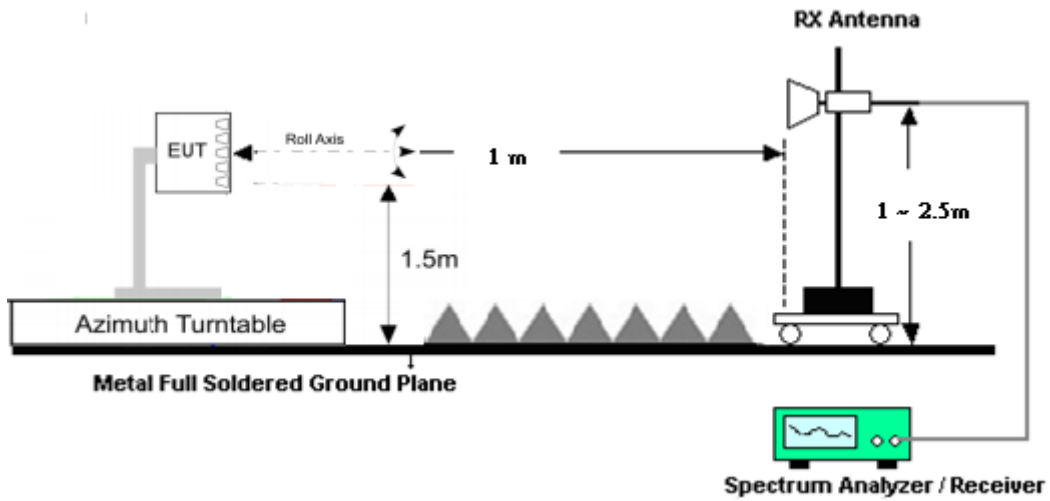

For radiated emissions above 40GHz up to 90GHz

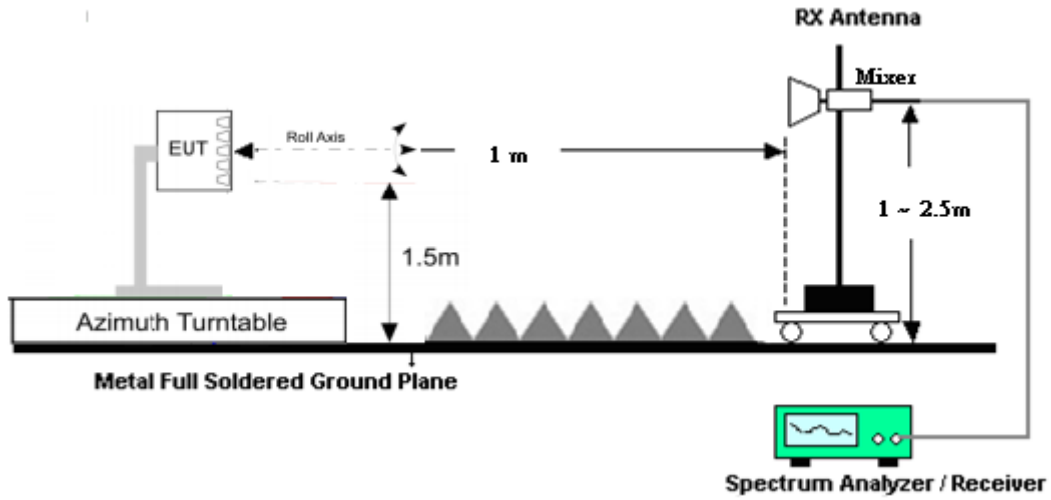

For radiated emissions above 90GHz up to 200GHz

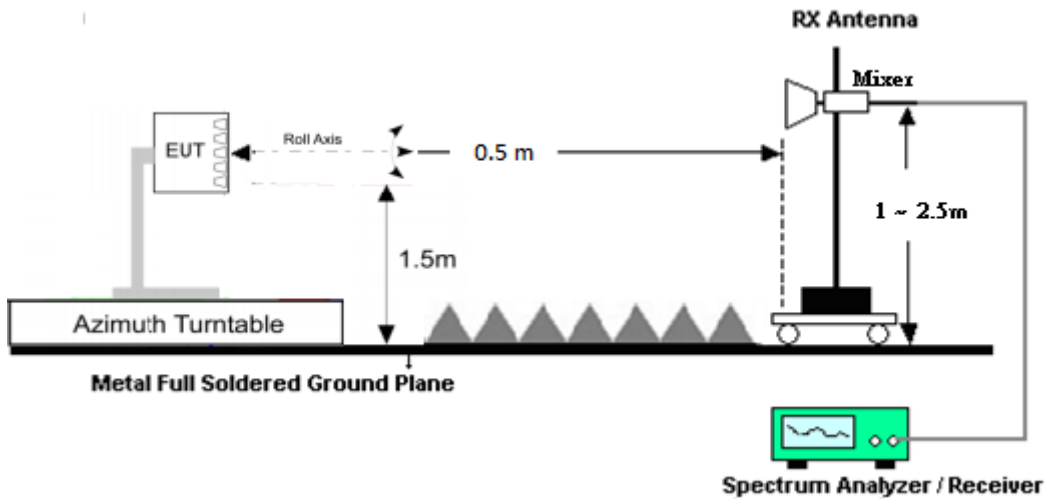

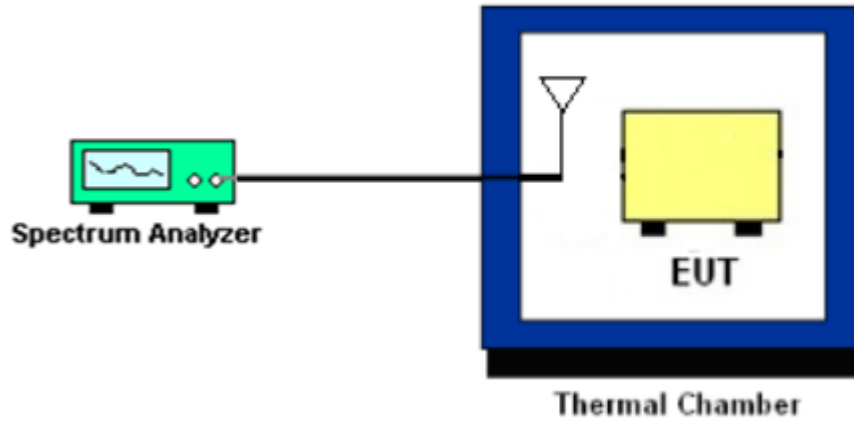
Frequency stability Setup**3.3 Test Result of Radiated Test**

Please refer to Appendix A.

Note:

The low frequency, which started from 9 kHz to 30MHz, was pre-scanned and the result which was 20dB lower than the limit line was not reported.

There is adequate comparison measurement of both open-field test site and alternative test site - semi-Anechoic chamber according to 414788 D01 Radiated Test Site v01r01, and the result came out very similar.



3.4 EIRP Measurement

3.4.1 Description of EIRP Measurement

For mobile stations, the average power of the sum of all antenna elements is limited to a maximum EIRP of +43 dBm.

3.4.2 Test Procedures

1. Set EUT at maximum output power.
2. Select lowest, middle, and highest channels for each band and different modulation.
3. Enable channel power function of spectrum analyzer
4. Set frequency would like to be investigated.
5. Set Detector = RMS
6. Set Trace mode = trace average
7. Set Sweep time = auto couple
8. Set sweep points $\geq 2 \times \text{Span/RBW}$
9. Set sweep count 100 and wait until the trace to be stabilized
10. Make the measurement with the spectrum analyzer's RBW = 1MHz, VBW = 3MHz, taking the record of maximum spurious emission.
11. Measure and record the power level from the spectrum analyzer.
12. The test result is calculated according to

ANSI C63.26-2015 Section 5.2.7

$$\text{EIRP (dBm)} = \text{E(dBuV/m)} + 20\log(D) - 104.8.$$

where D is the measurement distance (in the far field region) in m.

$$\text{E (dBuV/m)} = \text{Spectrum Level (dBm)} + \text{Antenna Factor (dB/m)} + \text{Cable Loss (dB)} + 107$$

That is, set the spectrum offset including sum of

$$\text{Antenna Factor (dB/m)} + \text{Cable Loss (dB)} + 107 + 20\log(D) - 104.8$$



3.5 Occupied Bandwidth

3.5.1 Description of Occupied Bandwidth Measurement

This is for reporting only.

The occupied bandwidth is the width of a frequency band such that, below the lower and above the upper frequency limits, the mean powers emitted are each equal to a specified percentage 0.5% of the total mean transmitted power.

3.5.2 Test Procedures

The testing follows ANSI C63.26-2015 Section 5.4.4

1. The spectrum analyzer center frequency is set to the nominal EUT channel center frequency. The span range for the spectrum analyzer shall be at least 1.5 times the anticipated OBW.
2. The nominal resolution bandwidth (RBW) shall be in the range of 1 to 5 % of the anticipated OBW, and the VBW shall be at least 3 times the RBW.
3. Set the detection mode to peak, and the trace mode to max hold.
4. Use the 99 % power bandwidth function of the spectrum analyzer and report the measured bandwidth.



3.6 Radiated Spurious Emission Measurement

3.6.1 Description of Radiated Spurious Emission Measurement

The spectrum is scanned from 30 MHz up to 200GHz.

The conductive power or the total radiated power of any emission outside a licensee's frequency block shall be -13 dBm/MHz or lower. However, in the bands immediately outside and adjacent to the licensee's frequency block, having a bandwidth equal to 10 percent of the channel bandwidth, the conductive power or the total radiated power of any emission shall be -5 dBm/MHz or lower.

3.6.2 Test Procedures

1. Set EUT at maximum output power..
2. Select lowest, middle, and highest channels for each band and different modulation.
3. Measure and record the power level from the spectrum analyzer.
4. Set frequency would like to be investigated.
5. Set Detector = RMS, Trace mode = trace average, sweep time = auto couple
6. Set sweep points $\geq 2 \times \text{Span}/\text{RBW}$, sweep count 100 and wait until the trace to be stabilized.
7. Make the measurement with the spectrum analyzer's RBW = 1MHz, VBW = 3MHz, taking the record of maximum spurious emission.
8. For measurement frequency from 30MHz to 18GHz,
An antenna was substituted in place of the EUT and was driven by a signal generator.
Tune the output power of signal generator to the same emission level with EUT maximum spurious emission. Take record of output power and repeat for another polarization.
9. For measurement frequency above 18GHz, the test result is calculated according to ANSI C63.26-2015 Section 5.2.7 and 5.7.3 and 5.7.4
$$\text{EIRP (dBm)} = \text{E(dBuV/m)} + 20\log(D) - 104.8.$$
where D is the measurement distance (in the far field region) in m.
$$\text{E (dBuV/m)} = \text{Spectrum Level (dBm)} + \text{Antenna Factor (dB/m)} + \text{Cable Loss (dB)} + 107$$
That is, set the spectrum offset including sum of
$$\text{Antenna Factor (dB/m)} + \text{Cable Loss (dB)} + 107 + 20\log(D) - 104.8$$
10. The conversion loss of RF mixer is also included in conversion loss table of the spectrum analyzer when measurement frequency is above 40GHz.



3.7 Frequency Stability Measurement

3.7.1 Description of Frequency Stability Measurement

The frequency stability shall be measured by variation of ambient temperature and variation of primary supply voltage to ensure that the fundamental emission stays within the authorized frequency block.

3.7.2 Test Procedures for Temperature Variation

The testing follows FCC KDB 971168 D01 v03r01 Section 9.

1. The EUT was set up in the thermal chamber.
2. With power OFF, the temperature was decreased to -30°C and the EUT was stabilized before testing. Power was applied and the maximum change in frequency was recorded within one minute.
3. With power OFF, the temperature was raised in 10°C step up to 50°C. The EUT was stabilized at each step for at least half an hour. Power was applied and the maximum frequency change was recorded within one minute.

3.7.3 Test Procedures for Voltage Variation

The testing follows FCC KDB 971168 D01 v03r01 Section 9.

1. The EUT was placed in a temperature chamber at 20° C.
2. The power supply voltage to the EUT was varied from 85% to 115% of the nominal value measured at the input to the EUT.
3. The variation in frequency was measured for the worst case.



4 List of Measuring Equipment

Instrument	Brand Name	Model No.	Serial No.	Characteristics	Calibration Date	Test Date	Due Date	Remark
Amplifier	SONOMA	310N	187311	9kHz~1GHz	Oct. 20, 2021	May 06, 2022~ May 07, 2022	Oct. 19, 2022	Radiation (03CH10-HY)
Bilog Antenna	TESEQ	CBL 6111D & 00800N1D01N -06	35413 & 02	30MHz~1GHz	Nov. 18, 2021	May 06, 2022~ May 07, 2022	Nov. 17, 2022	Radiation (03CH10-HY)
Horn Antenna	SCHWARZB ECK	BBHA 9120 D	9120D-1325	1GHz~18GHz	Oct. 21, 2021	May 06, 2022~ May 07, 2022	Oct. 20, 2022	Radiation (03CH10-HY)
Preamplifier	Jet-Power	JAP00101800- 30-10P	160118550004	1GHz~18GHz	Feb. 27, 2022	May 06, 2022~ May 07, 2022	Feb. 26, 2023	Radiation (03CH10-HY)
Controller	EMEC	EM 1000	N/A	Control Turn table & Ant Mast	N/A	May 06, 2022~ May 07, 2022	N/A	Radiation (03CH10-HY)
Antenna Mast	EMEC	AM-BS-4500-B	N/A	1~4m	N/A	May 06, 2022~ May 07, 2022	N/A	Radiation (03CH10-HY)
Turn Table	EMEC	TT 2200	N/A	0~360 Degree	N/A	May 06, 2022~ May 07, 2022	N/A	Radiation (03CH10-HY)
Software	Audix	E3 6.2009-8-24	RK-001042	N/A	N/A	May 06, 2022~ May 07, 2022	N/A	Radiation (03CH10-HY)
EMI Test Receiver	Keysight	N9038A	MY59053012	3Hz~26.5GHz	Nov. 18, 2021	May 06, 2022~ May 07, 2022	Nov. 17, 2022	Radiation (03CH10-HY)
RF Cable	HUBER + SUHNER	SUCOFLEX 104 / 102	MY11692/4PE, MY11693/4PE, MY2855/2	30MHz~1GHz	Nov. 04, 2021	May 06, 2022~ May 07, 2022	Nov. 03, 2022	Radiation (03CH10-HY)
RF Cable	HUBER + SUHNER	SUCOFLEX 104 / 102	MY11692/4PE, MY11693/4PE, MY2855/2	1GHz~18GHz	Nov. 04, 2021	May 06, 2022~ May 07, 2022	Nov. 03, 2022	Radiation (03CH10-HY)
SHF-EHF Horn Antenna	SCHWARZB ECK	BBHA 9170	00991	18GHz~40GHz	May 12, 2021	Mar. 30, 2022~ May 10, 2022	May 11, 2022	Radiation (03CH18-HY)
Spectrum Analyzer	Rohde & Schwarz	FSV3044	101010	10Hz~44GHz	Nov. 24, 2021	Mar. 30, 2022~ May 10, 2022	Nov. 23, 2022	Radiation (03CH18-HY)
RF Cable	HUBER + SUHNER	SUCOFLEX 102	801589/2	9kHz~40GHz	Nov. 30, 2021	Mar. 30, 2022~ May 10, 2022	Nov 29, 2022	Radiation (03CH18-HY)
Turn Table	EMEC	N/A	N/A	Phi/Theta 0~360 Degree	N/A	Mar. 30, 2022~ May 10, 2022	N/A	Radiation (03CH18-HY)
Controller	EMEC	EM 1000	N/A	Control Turn table	N/A	Mar. 30, 2022~ May 10, 2022	N/A	Radiation (03CH18-HY)
Spectrum Analyzer	Rohde & Schwarz	FSV30	103738	9kHz to 30GHz	May 19, 2021	May 03, 2022	May 18, 2022	Radiation (03CH18-HY)
RF Cable	HUBER + SUHNER	SUCOFLEX 102	801607/2	9kHz~40GHz	Dec. 30, 2021	May 03, 2022	Dec. 29, 2022	Radiation (03CH18-HY)
RF Cable	HUBER + SUHNER	SUCOFLEX 102	801589/2	9kHz~40GHz	Nov. 30, 2021	May 03, 2022	Nov. 29, 2022	Radiation (03CH18-HY)
*Harmonic Mixer	Rohde & Schwarz	RPG FS-Z60	100986	40GHz to 60GHz	Apr. 09, 2021	May 03, 2022	Apr. 08, 2024	Radiation (03CH18-HY)
*Harmonic Mixer	Rohde & Schwarz	FS-Z90	101811	60GHz to 90GHz	Nov. 16, 2021	May 03, 2022	Nov. 15, 2024	Radiation (03CH18-HY)
*Harmonic Mixer	Rohde & Schwarz	RPG FS-Z140	101128	90GHz to 140GHz	Oct. 26, 2020	May 03, 2022	Oct. 25, 2023	Radiation (03CH18-HY)
*Harmonic Mixer	Rohde & Schwarz	RPG FS-Z220	101014	140GHz to 220GHz	Dec. 06, 2021	May 03, 2022	Dec. 05, 2024	Radiation (03CH18-HY)
Antenna	Quinstar	QWH-UPRR00	QWH-UPRR00 -01	40-60 GHz	Jul. 06, 2021	May 03, 2022	N/A (Note 3)	Radiation (03CH18-HY)
Antenna	Quinstar	QWH-EPRR00	1372000000	60-90 GHz	Jul. 06, 2021	May 03, 2022	N/A (Note 3)	Radiation (03CH18-HY)
Antenna	Quinstar	QWH-FPRR00	1011500008	90-140 GHz	Jul. 06, 2021	May 03, 2022	N/A (Note 3)	Radiation (03CH18-HY)
Antenna	Quinstar	QWH-GPRR00	923900002	140-220 GHz	Jan. 20, 2022	May 03, 2022	N/A (Note 3)	Radiation (03CH18-HY)



Note 1: (*) Equipment manufacturer's Calibration Certificate.

Note 2: The Standard Gain Horn Antennas are calibrated by the ISO 17025 accredited test lab MWM Lab (<http://en.mwmlab.com/about>), a sub unit of Belarussian State University of Informatics and Radio electronics which is accredited by the Belarussian State Centre for Accreditation (BSCA). BSCA is the National accreditation body of the Republic of Belarus and an associated member of the International Laboratory Accreditation Cooperation (ILAC).

Note 3: The standard gain horn's critical dimensions is verified on an annual basis within the equipment specification according to KDB 842590 D01 v01r02 clause 2)a)2)iii).



5 Uncertainty of Evaluation

Uncertainty of Radiated Emission Measurement (30 MHz ~ 1000 MHz)

Measuring Uncertainty for a Level of Confidence of 95% ($U = 2Uc(y)$)	3.23 dB
---	---------

Uncertainty of Radiated Emission Measurement (1 GHz ~ 18 GHz)

Measuring Uncertainty for a Level of Confidence of 95% ($U = 2Uc(y)$)	3.54 dB
---	---------

Uncertainty of Radiated Emission Measurement (18 GHz ~ 40 GHz)

Measuring Uncertainty for a Level of Confidence of 95% ($U = 2Uc(y)$)	4.41 dB
---	---------

Uncertainty of Radiated Emission Measurement (40 GHz ~ 140 GHz)

Measuring Uncertainty for a Level of Confidence of 95% ($U = 2Uc(y)$)	5.64 dB
---	---------

Uncertainty of Radiated Emission Measurement (140 GHz ~ 200 GHz)

Measuring Uncertainty for a Level of Confidence of 95% ($U = 2Uc(y)$)	6.62 dB
---	---------



Appendix A. Test Results of EIRP and Radiated Test

EIRP Power(Average power)

<Module A>

NR Band n258A Module A AG0+1 (Beam ID:5+5)					
Maximum Average EIRP [dBm]					
	BW [MHz]	Waveform	Modulation	Inner 1RB	Inner Full
Lowest	50	DFT-S	QPSK	24.05	24.26
	50	DFT-S	16QAM	22.45	22.24
	50	DFT-S	64QAM	19.59	20.01
	50	CP	QPSK	21.63	22.07
	100	DFT-S	QPSK	23.27	24.68
	100	DFT-S	16QAM	21.83	22.86
	100	DFT-S	64QAM	19.71	20.33
	100	CP	QPSK	21.01	21.28

NR Band n258A Module A AG0+1 (Beam ID:5+5)					
Maximum Average EIRP [dBm]					
	BW [MHz]	Waveform	Modulation	Inner 1RB	Inner Full
Middle	50	DFT-S	QPSK	24.26	24.39
	50	DFT-S	16QAM	22.65	22.75
	50	DFT-S	64QAM	20.05	20.53
	50	CP	QPSK	21.97	22.36
	100	DFT-S	QPSK	23.87	24.15
	100	DFT-S	16QAM	22.79	22.58
	100	DFT-S	64QAM	19.72	20.22
	100	CP	QPSK	21.83	21.88
	200	DFT-S	QPSK	21.58	21.71
	200	DFT-S	16QAM	19.04	18.93
	200	DFT-S	64QAM	15.84	16.62
	200	CP	QPSK	21.03	21.28

Note : The 200MHz Bw is carrier aggregation by 2CC of 100MHz.



NR Band n258A Module A AG0+1 (Beam ID:5+5)					
Maximum Average EIRP [dBm]					
Highest	BW [MHz]	Waveform	Modulation	Inner 1RB	Inner Full
	50	DFT-S	QPSK	25.29	25.04
	50	DFT-S	16QAM	23.22	22.8
	50	DFT-S	64QAM	20.29	20.65
	50	CP	QPSK	22.45	22.39
	100	DFT-S	QPSK	25.26	25.37
	100	DFT-S	16QAM	23.14	23.04
	100	DFT-S	64QAM	20.07	20.51
	100	CP	QPSK	23.4	23.38

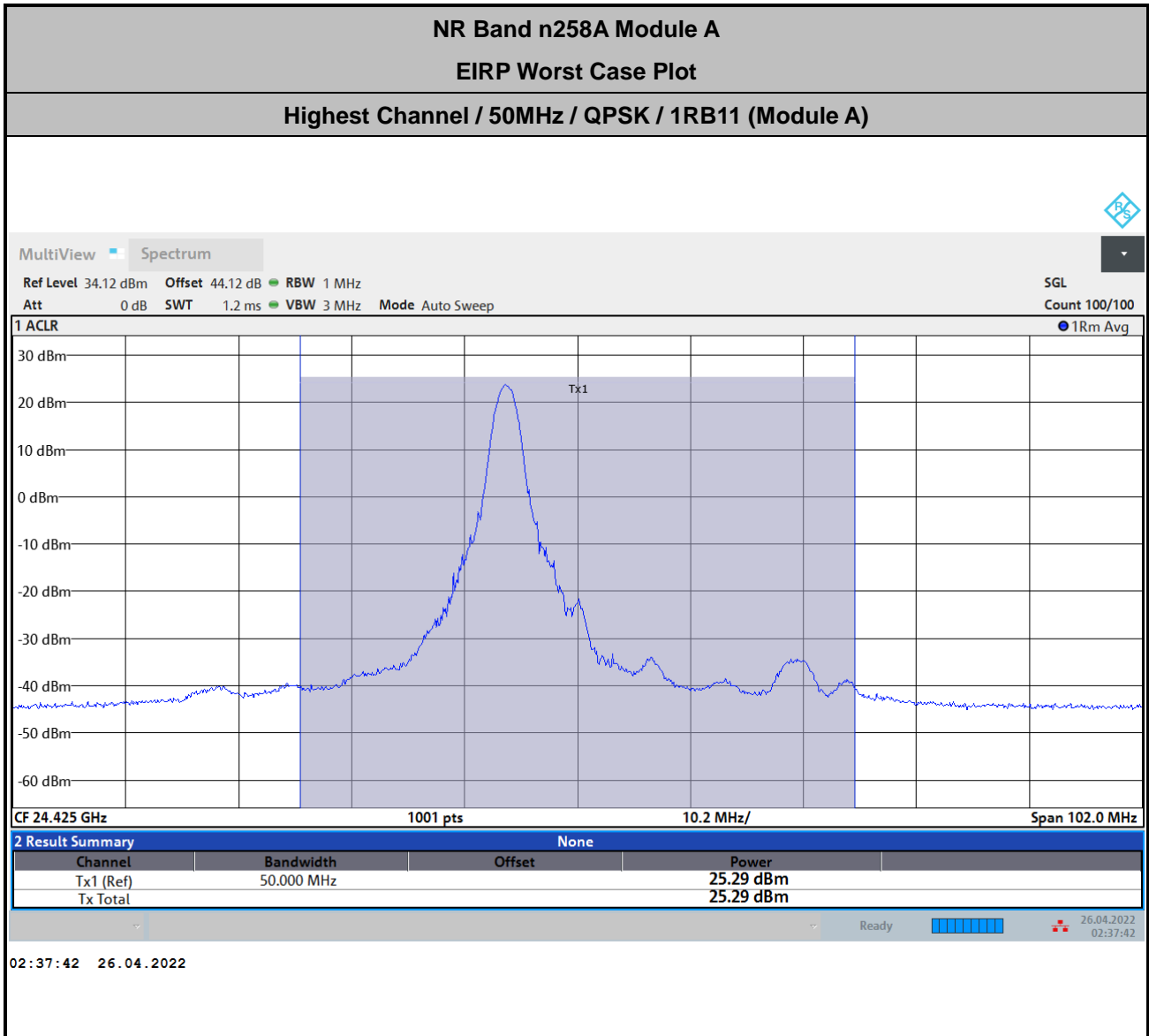

$$\text{Offset} = \text{Antenna Factor (dB/m)} + \text{Cable Loss (dB)} + 107 + 20\log(D) - 104.8$$

$$= 39.3 + 2.62 + 107 + 20\log(1) - 104.8 = 44.12 \text{ (dB)}$$

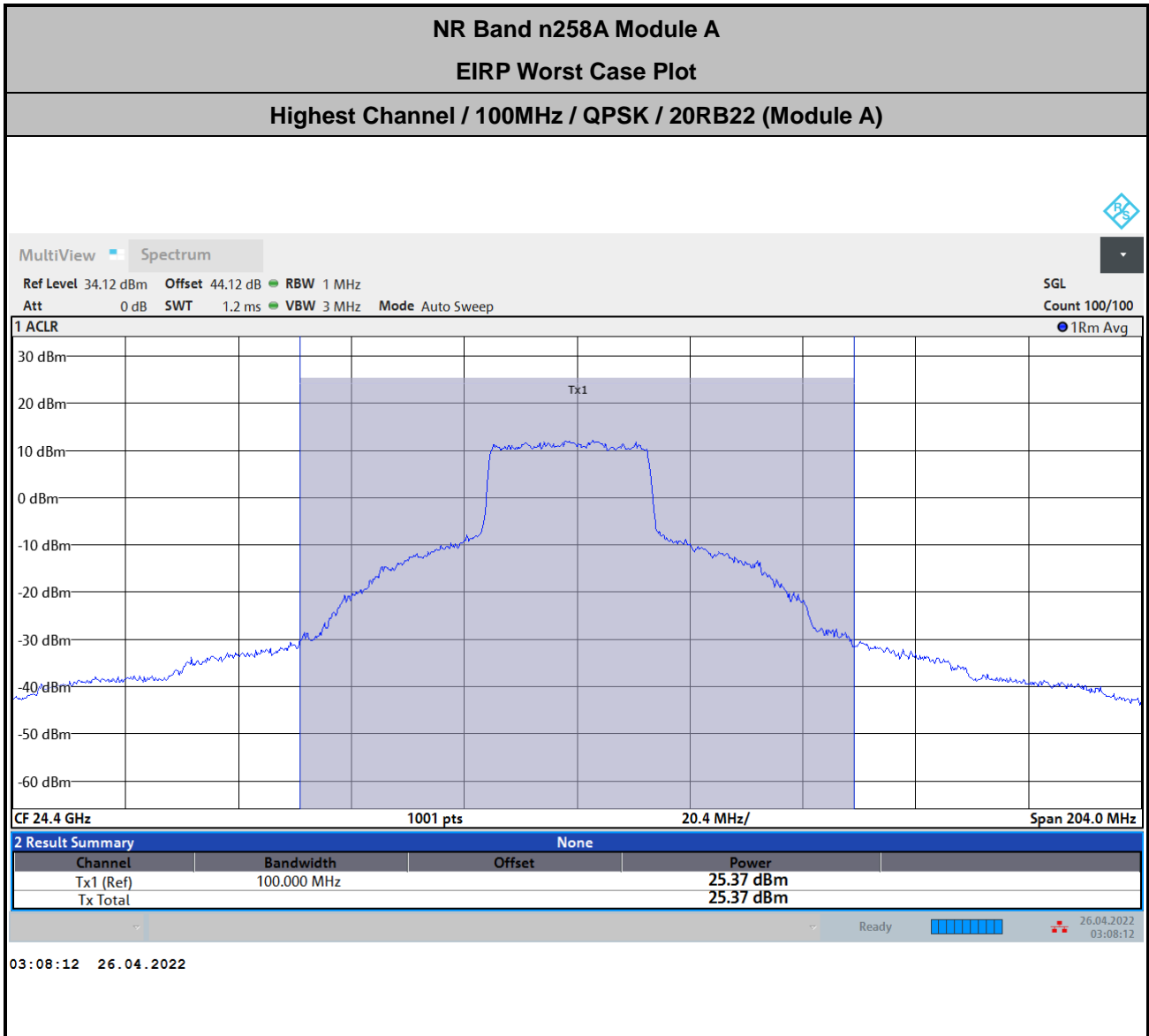

$$\text{Offset} = \text{Antenna Factor (dB/m)} + \text{Cable Loss (dB)} + 107 + 20\log(D) - 104.8$$

$$= 39.3 + 2.62 + 107 + 20\log(1) - 104.8 = 44.12 \text{ (dB)}$$

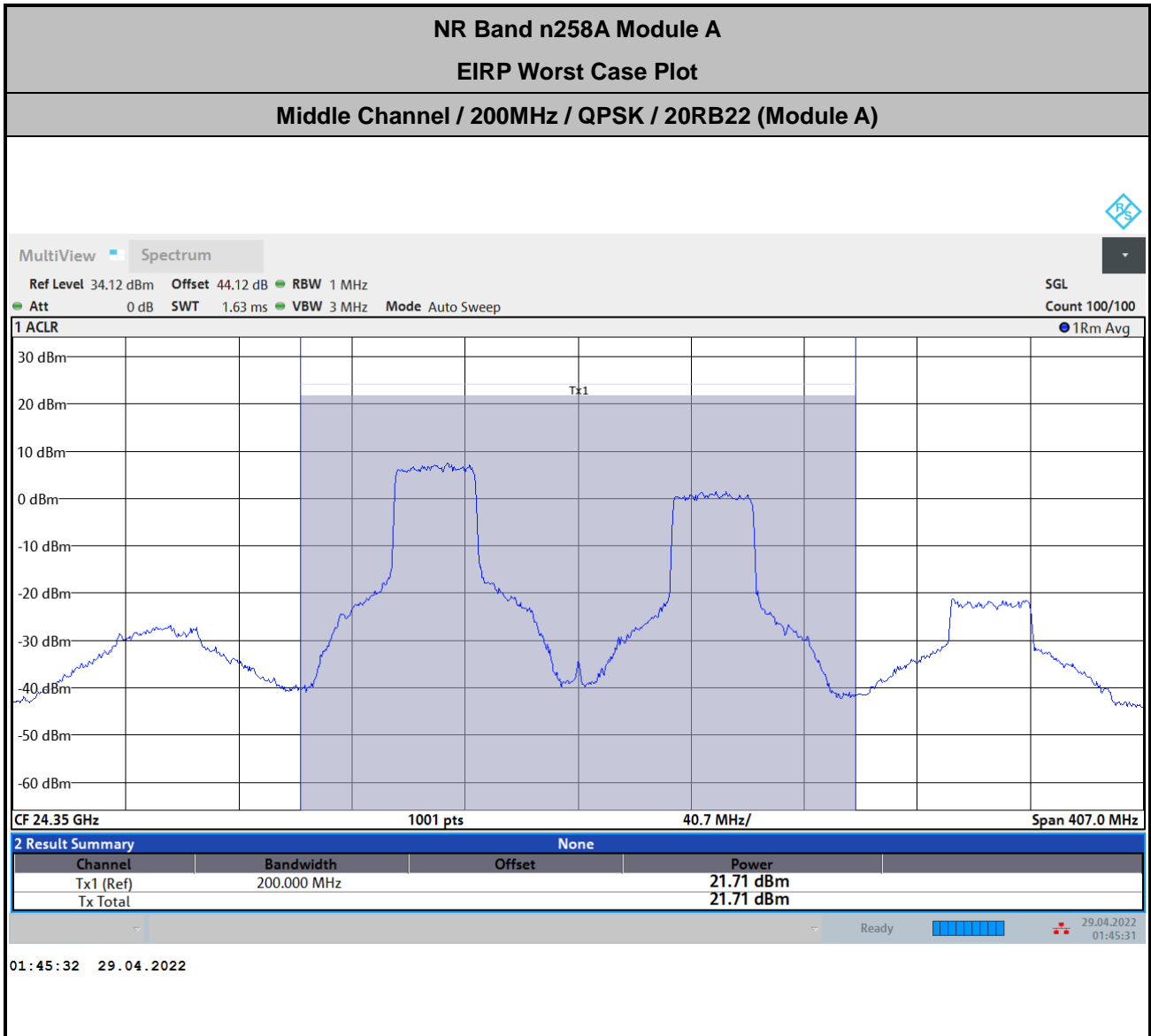

$$\text{Offset} = \text{Antenna Factor (dB/m)} + \text{Cable Loss (dB)} + 107 + 20\log(D) - 104.8$$

$$= 39.3 + 2.62 + 107 + 20\log(1) - 104.8 = 44.12 \text{ (dB)}$$



<Module B>

NR Band n258A Module B AG0+1 (Beam ID:3+3)					
Maximum Average EIRP [dBm]					
	BW [MHz]	Waveform	Modulation	Inner 1RB	Inner Full
Lowest	50	DFT-S	QPSK	25.57	25.71
	50	DFT-S	16QAM	22.42	22.38
	50	DFT-S	64QAM	20.44	20.53
	50	CP	QPSK	22.49	22.31
	100	DFT-S	QPSK	25.78	25.99
	100	DFT-S	16QAM	23.24	22.83
	100	DFT-S	64QAM	20.23	20.69
	100	CP	QPSK	22.23	22.44

NR Band n258A Module B AG0+1 (Beam ID:3+3)					
Maximum Average EIRP [dBm]					
	BW [MHz]	Waveform	Modulation	Inner 1RB	Inner Full
Middle	50	DFT-S	QPSK	25.7	26
	50	DFT-S	16QAM	22.52	22.72
	50	DFT-S	64QAM	20.63	20.81
	50	CP	QPSK	22.51	22.53
	100	DFT-S	QPSK	25.73	25.59
	100	DFT-S	16QAM	23.05	22.66
	100	DFT-S	64QAM	20.08	20.37
	100	CP	QPSK	22.27	22.05
	200	DFT-S	QPSK	23.79	24.02
	200	DFT-S	16QAM	21.29	20.9
	200	DFT-S	64QAM	17.94	18.57
	200	CP	QPSK	20.32	20.39

Note : The 200MHz Bw is carrier aggregation by 2CC of 100MHz.



NR Band n258A Module B AG0+1 (Beam ID:3+3)					
Maximum Average EIRP [dBm]					
Highest	BW [MHz]	Waveform	Modulation	Inner 1RB	Inner Full
	50	DFT-S	QPSK	26.21	26.19
	50	DFT-S	16QAM	23.02	22.95
	50	DFT-S	64QAM	21.1	21.17
	50	CP	QPSK	22.76	22.67
	100	DFT-S	QPSK	26.46	26.53
	100	DFT-S	16QAM	23.69	23.45
	100	DFT-S	64QAM	20.55	21.25
	100	CP	QPSK	22.94	22.68

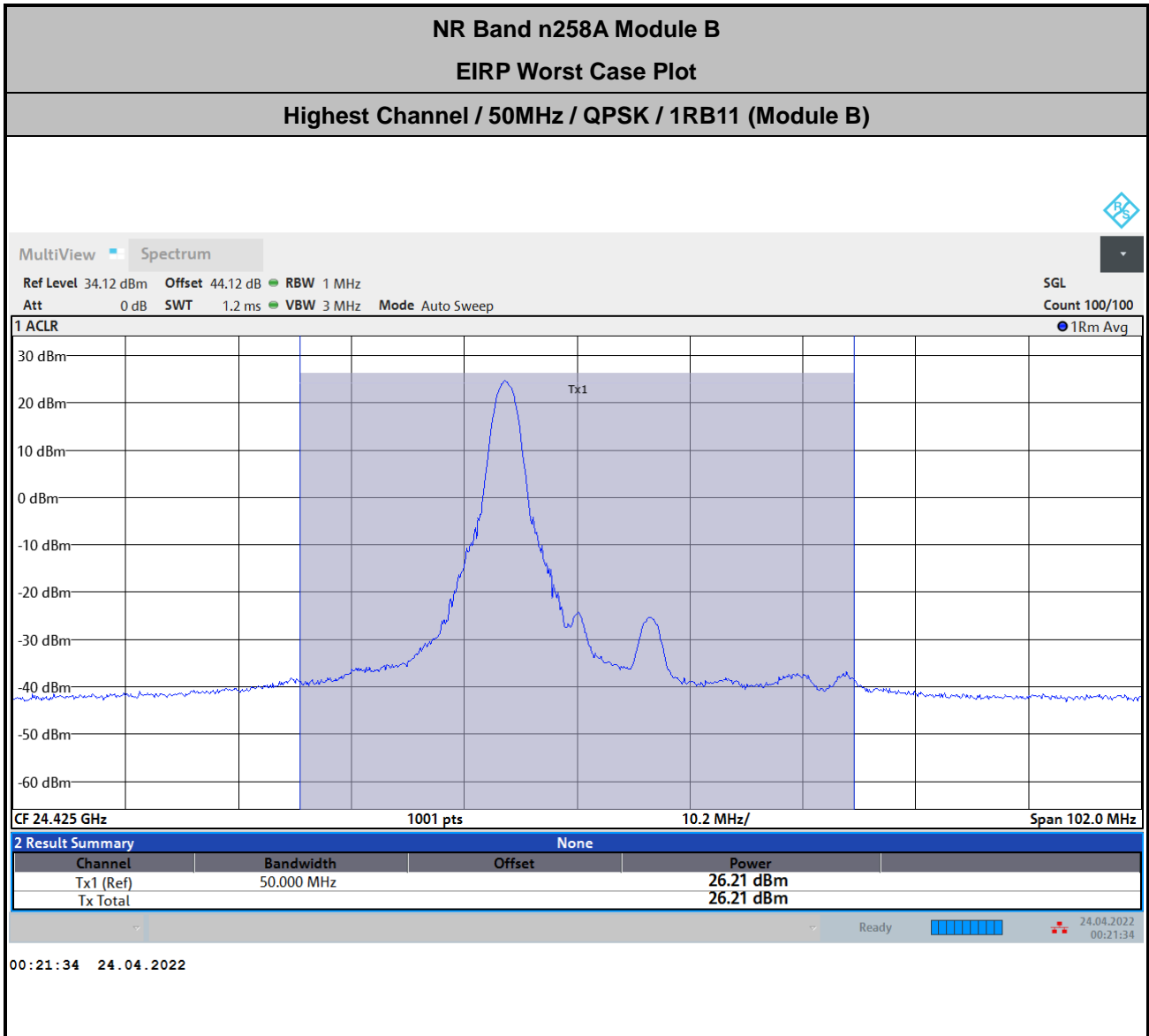

$$\text{Offset} = \text{Antenna Factor (dB/m)} + \text{Cable Loss (dB)} + 107 + 20\log(D) - 104.8$$

$$= 39.3 + 2.62 + 107 + 20\log(1) - 104.8 = 44.12 \text{ (dB)}$$

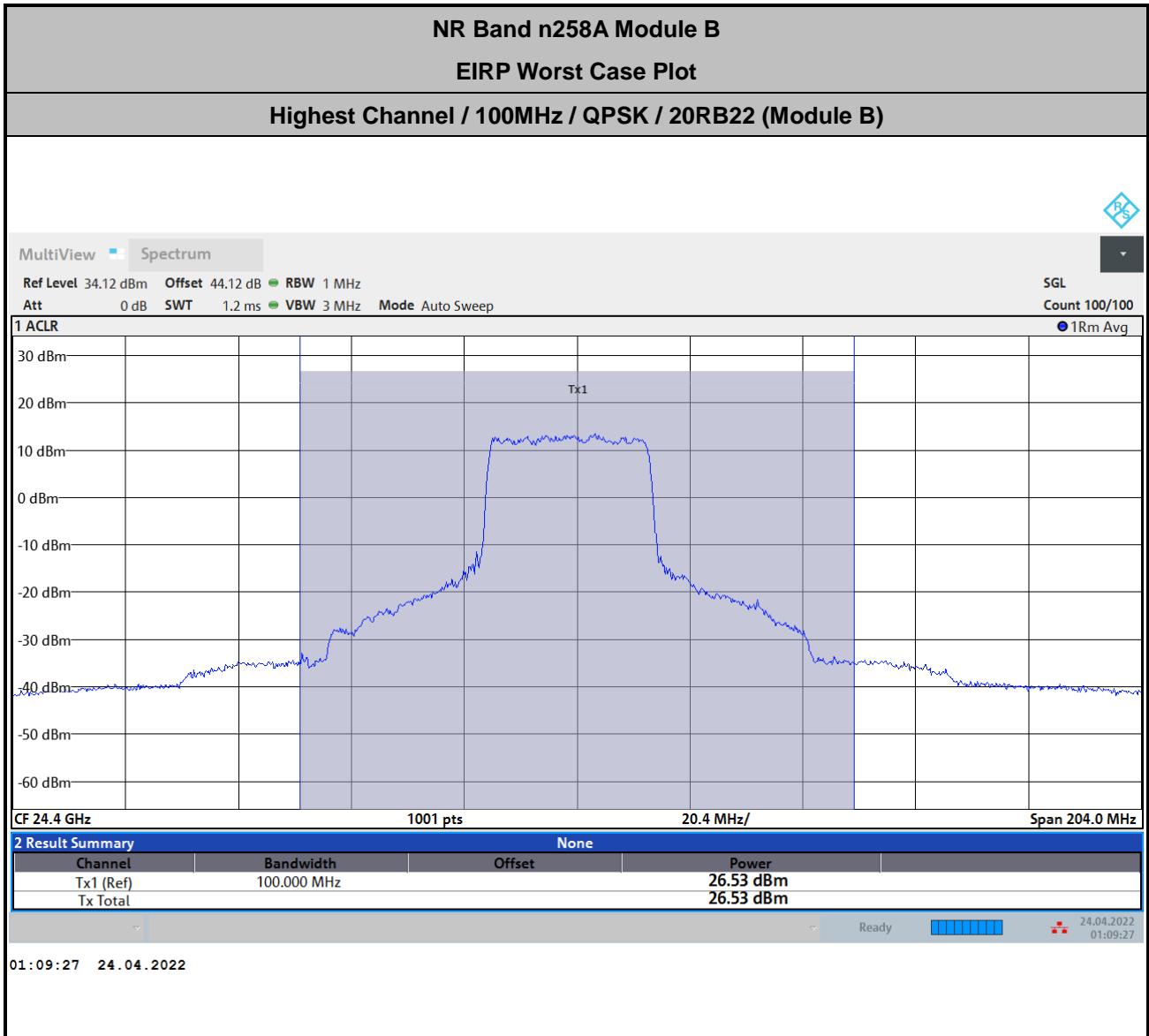

$$\text{Offset} = \text{Antenna Factor (dB/m)} + \text{Cable Loss (dB)} + 107 + 20\log(D) - 104.8$$

$$= 39.3 + 2.62 + 107 + 20\log(1) - 104.8 = 44.12 \text{ (dB)}$$

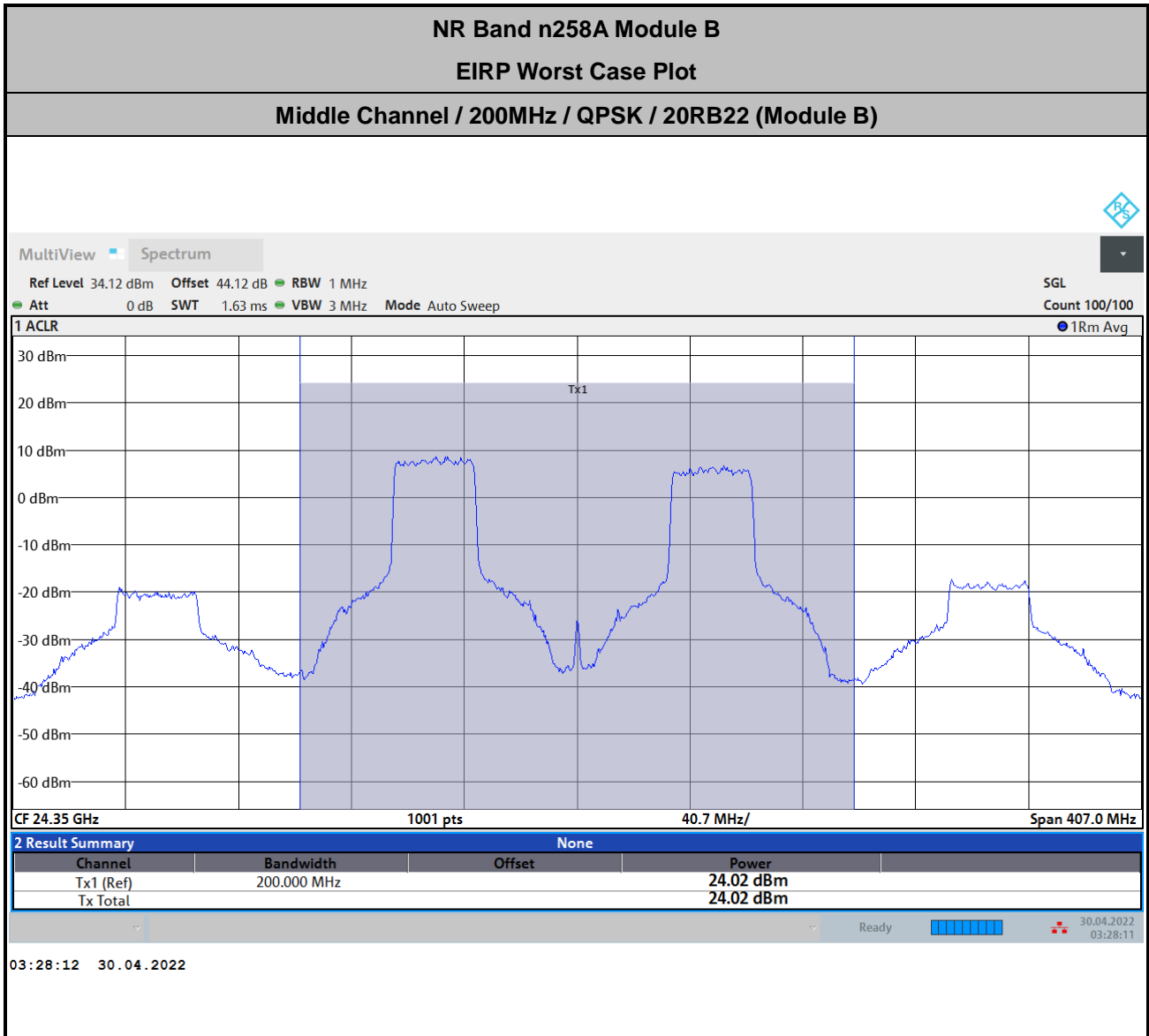

$$\text{Offset} = \text{Antenna Factor (dB/m)} + \text{Cable Loss (dB)} + 107 + 20\log(D) - 104.8$$

$$= 39.3 + 2.62 + 107 + 20\log(1) - 104.8 = 44.12 \text{ (dB)}$$



<Module A>

NR Band n258B Module A AG0+1 (Beam ID:5+5)					
Maximum Average EIRP [dBm]					
	BW [MHz]	Waveform	Modulation	Inner 1RB	Inner Full
Lowest	50	DFT-S	QPSK	26.95	26.49
	50	DFT-S	16QAM	24.22	23.97
	50	DFT-S	64QAM	21.84	22.24
	50	CP	QPSK	23.62	23.77
	100	DFT-S	QPSK	26.68	26.6
	100	DFT-S	16QAM	24.11	23.96
	100	DFT-S	64QAM	21.35	21.85
	100	CP	QPSK	23.42	23.4
	200	DFT-S	QPSK	21.6	22.12
	200	DFT-S	16QAM	19.58	19.7
	200	DFT-S	64QAM	17.79	18.71
	200	CP	QPSK	21.67	21.95

Note : The 200MHz Bw is carrier aggregation by 2CC of 100MHz.

NR Band n258B Module A AG0+1 (Beam ID:5+5)					
Maximum Average EIRP [dBm]					
	BW [MHz]	Waveform	Modulation	Inner 1RB	Inner Full
Middle	50	DFT-S	QPSK	26.73	26.96
	50	DFT-S	16QAM	24.2	24.17
	50	DFT-S	64QAM	22.34	22.26
	50	CP	QPSK	23.77	23.64
	100	DFT-S	QPSK	26.71	26.56
	100	DFT-S	16QAM	24.19	23.91
	100	DFT-S	64QAM	21.45	21.8
	100	CP	QPSK	23.22	23.26
	200	DFT-S	QPSK	22.07	22.4
	200	DFT-S	16QAM	19.18	19.15
	200	DFT-S	64QAM	17.52	17.9
	200	CP	QPSK	22.06	22.29

Note : The 200MHz Bw is carrier aggregation by 2CC of 100MHz.



NR Band n258B Module A AG0+1 (Beam ID:5+5)					
Maximum Average EIRP [dBm]					
Highest	BW [MHz]	Waveform	Modulation	Inner 1RB	Inner Full
	50	DFT-S	QPSK	26.37	26.17
	50	DFT-S	16QAM	23.55	23.61
	50	DFT-S	64QAM	21.99	22.17
	50	CP	QPSK	23.06	23.05
	100	DFT-S	QPSK	26.07	26.51
	100	DFT-S	16QAM	23.63	23.9
	100	DFT-S	64QAM	21.35	22.02
	100	CP	QPSK	22.86	23.11
	200	DFT-S	QPSK	21.51	21.63
	200	DFT-S	16QAM	20.71	20.67
	200	DFT-S	64QAM	19.03	19.68
	200	CP	QPSK	19.68	19.65

Note : The 200MHz Bw is carrier aggregation by 2CC of 100MHz.

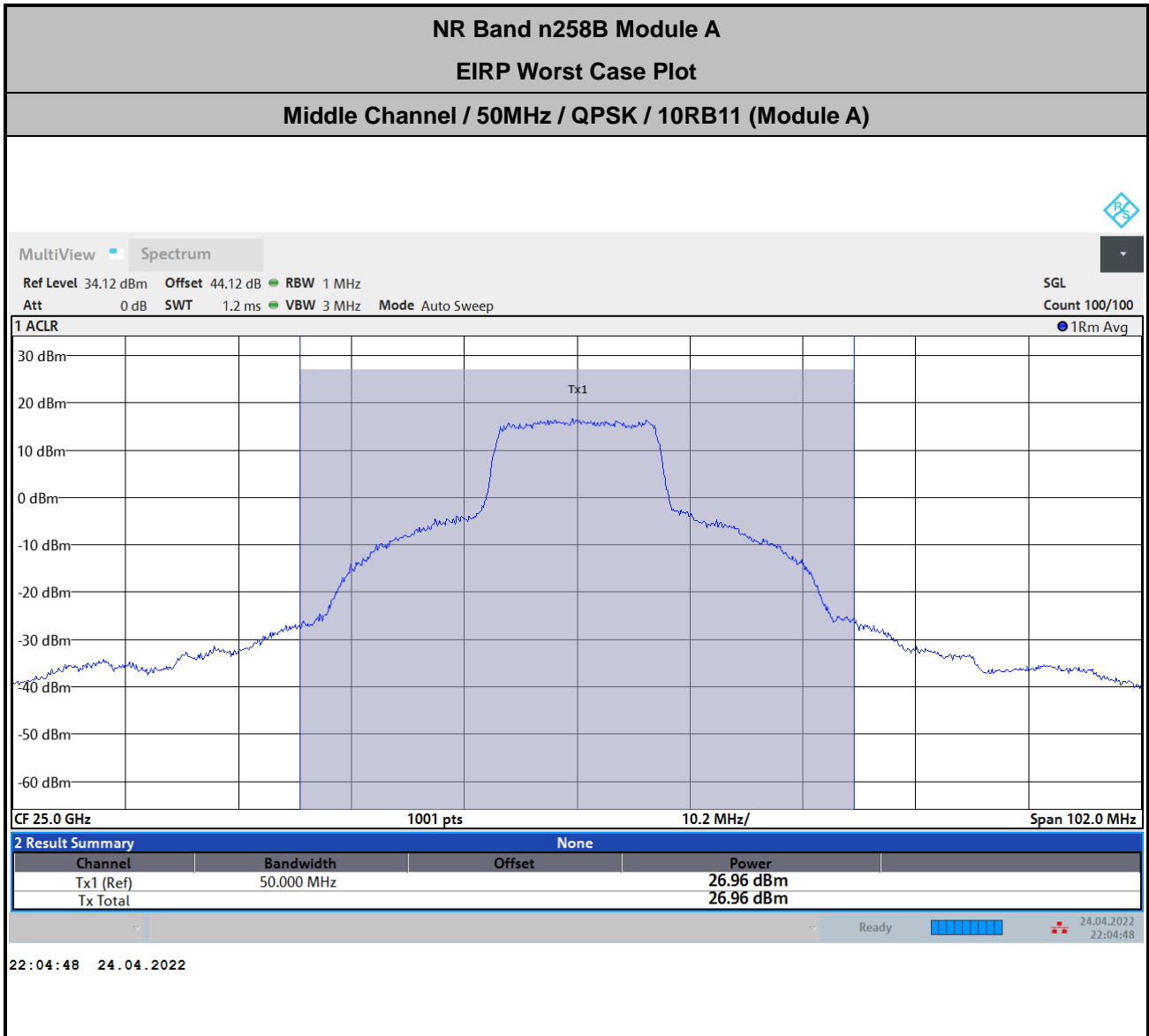

$$\text{Offset} = \text{Antenna Factor (dB/m)} + \text{Cable Loss (dB)} + 107 + 20\log(D) - 104.8$$

$$= 39.3 + 2.62 + 107 + 20\log(1) - 104.8 = 44.12 \text{ (dB)}$$

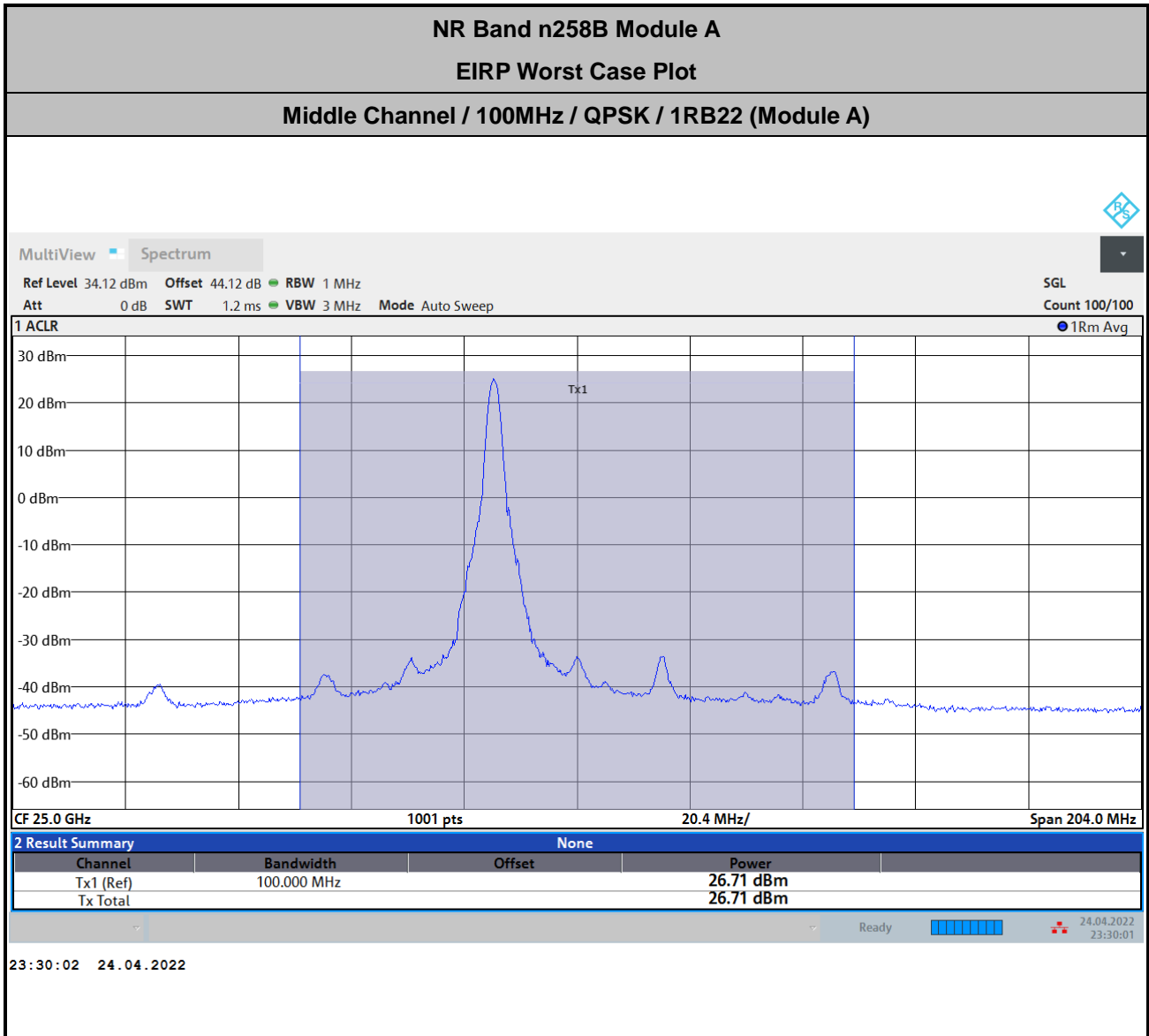

$$\text{Offset} = \text{Antenna Factor (dB/m)} + \text{Cable Loss (dB)} + 107 + 20\log(D) - 104.8$$

$$= 39.3 + 2.62 + 107 + 20\log(1) - 104.8 = 44.12 \text{ (dB)}$$

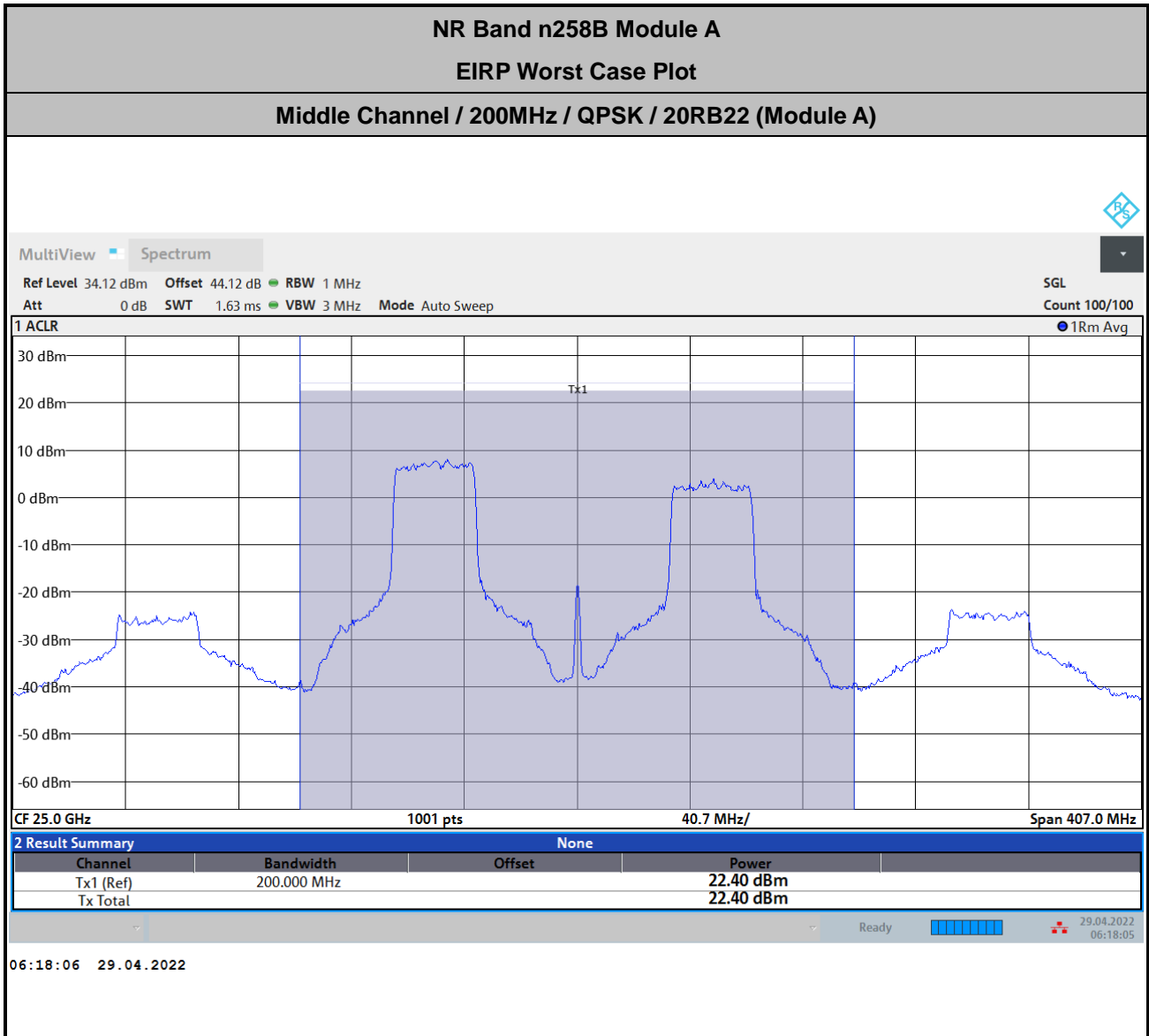

$$\text{Offset} = \text{Antenna Factor (dB/m)} + \text{Cable Loss (dB)} + 107 + 20\log(D) - 104.8$$

$$= 39.3 + 2.62 + 107 + 20\log(1) - 104.8 = 44.12 \text{ (dB)}$$



<Module B>

NR Band n258B Module B AG0+1 (Beam ID:3+3)					
Maximum Average EIRP [dBm]					
	BW [MHz]	Waveform	Modulation	Inner 1RB	Inner Full
Lowest	50	DFT-S	QPSK	26.63	26.43
	50	DFT-S	16QAM	23.23	23.4
	50	DFT-S	64QAM	21.45	21.41
	50	CP	QPSK	23.61	23.56
	100	DFT-S	QPSK	26.56	26.2
	100	DFT-S	16QAM	23.25	23.23
	100	DFT-S	64QAM	20.65	20.9
	100	CP	QPSK	23.04	22.81
	200	DFT-S	QPSK	23.48	23.2
	200	DFT-S	16QAM	22.9	22.26
	200	DFT-S	64QAM	20.97	21.1
	200	CP	QPSK	21.18	21.21

Note : The 200MHz Bw is carrier aggregation by 2CC of 100MHz.

NR Band n258B Module B AG0+1 (Beam ID:3+3)					
Maximum Average EIRP [dBm]					
	BW [MHz]	Waveform	Modulation	Inner 1RB	Inner Full
Middle	50	DFT-S	QPSK	26.44	26.47
	50	DFT-S	16QAM	23.79	23.13
	50	DFT-S	64QAM	20.78	20.69
	50	CP	QPSK	22.36	22.28
	100	DFT-S	QPSK	26.01	26.1
	100	DFT-S	16QAM	23.42	22.96
	100	DFT-S	64QAM	20.39	20.53
	100	CP	QPSK	22.22	22.09
	200	DFT-S	QPSK	23.02	22.82
	200	DFT-S	16QAM	22.17	21.83
	200	DFT-S	64QAM	20.33	20.59
	200	CP	QPSK	20.8	20.77

Note : The 200MHz Bw is carrier aggregation by 2CC of 100MHz.



NR Band n258B Module B AG0+1 (Beam ID:3+3)					
Maximum Average EIRP [dBm]					
Highest	BW [MHz]	Waveform	Modulation	Inner 1RB	Inner Full
	50	DFT-S	QPSK	25.94	26.27
	50	DFT-S	16QAM	22.78	23.17
	50	DFT-S	64QAM	21.41	21.36
	50	CP	QPSK	23.47	22.92
	100	DFT-S	QPSK	25.84	26.04
	100	DFT-S	16QAM	23.41	23.28
	100	DFT-S	64QAM	20.51	20.98
	100	CP	QPSK	22.83	22.92
	200	DFT-S	QPSK	21.32	21.46
	200	DFT-S	16QAM	19.45	20.55
	200	DFT-S	64QAM	18.63	19.38
	200	CP	QPSK	21.23	21.4

Note : The 200MHz Bw is carrier aggregation by 2CC of 100MHz.

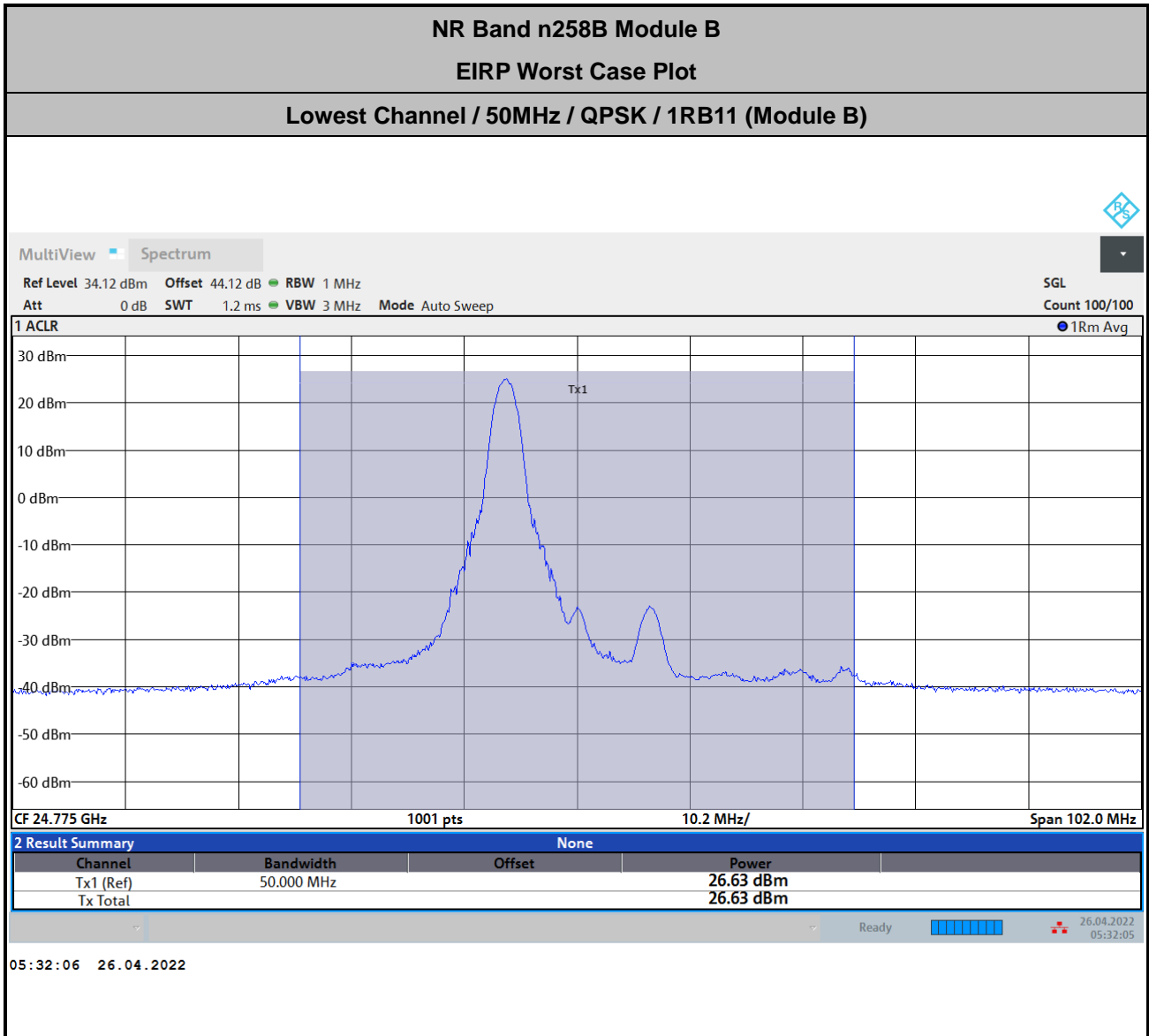

$$\text{Offset} = \text{Antenna Factor (dB/m)} + \text{Cable Loss (dB)} + 107 + 20\log(D) - 104.8$$

$$= 39.3 + 2.62 + 107 + 20\log(1) - 104.8 = 44.12 \text{ (dB)}$$

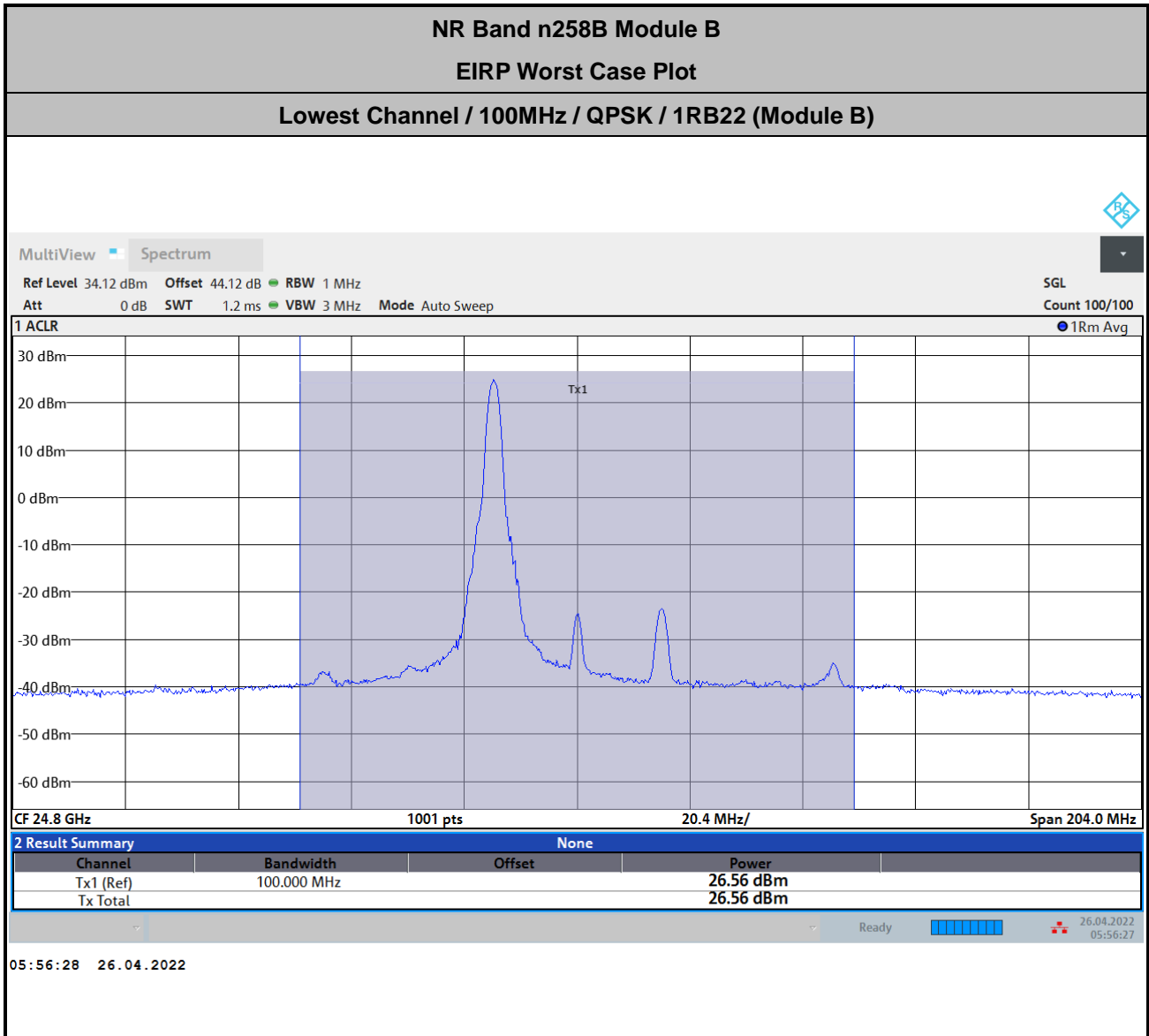

$$\text{Offset} = \text{Antenna Factor (dB/m)} + \text{Cable Loss (dB)} + 107 + 20\log(D) - 104.8$$

$$= 39.3 + 2.62 + 107 + 20\log(1) - 104.8 = 44.12 \text{ (dB)}$$

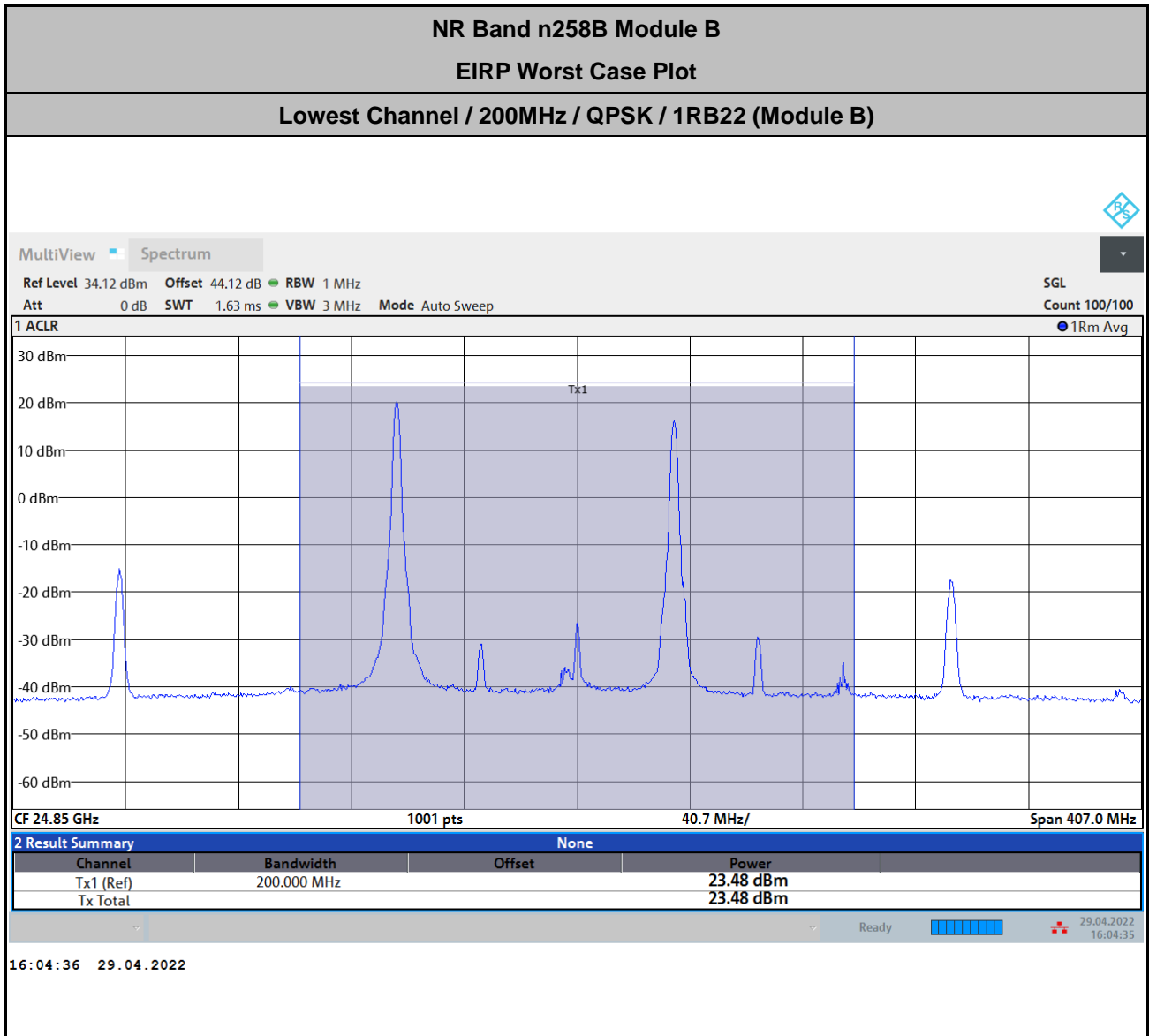

$$\text{Offset} = \text{Antenna Factor (dB/m)} + \text{Cable Loss (dB)} + 107 + 20\log(D) - 104.8$$

$$= 39.3 + 2.62 + 107 + 20\log(1) - 104.8 = 44.12 \text{ (dB)}$$



<Module A>

NR Band n260 Module A AGH+V (Beam ID:3+3)					
Maximum Average EIRP [dBm]					
	BW [MHz]	Waveform	Modulation	Inner 1RB	Inner Full
Lowest	50	DFT-S	QPSK	25.04	24.99
	50	DFT-S	16QAM	21.98	22.08
	50	DFT-S	64QAM	20.05	20.11
	50	CP	QPSK	24.15	23.98
	100	DFT-S	QPSK	24.66	24.67
	100	DFT-S	16QAM	22.01	21.82
	100	DFT-S	64QAM	19.21	19.57
	100	CP	QPSK	23.87	23.84
	200	DFT-S	QPSK	22.56	22.89
	200	DFT-S	16QAM	22.17	22.37
	200	DFT-S	64QAM	20.06	20.19
	200	CP	QPSK	22.64	22.89

Note : The 200MHz Bw is carrier aggregation by 2CC of 100MHz.

NR Band n260 Module A AGH+V (Beam ID:3+3)					
Maximum Average EIRP [dBm]					
	BW [MHz]	Waveform	Modulation	Inner 1RB	Inner Full
Middle	50	DFT-S	QPSK	26.13	26.2
	50	DFT-S	16QAM	23.2	22.52
	50	DFT-S	64QAM	20.61	20.83
	50	CP	QPSK	25.41	25.45
	100	DFT-S	QPSK	25.02	25.89
	100	DFT-S	16QAM	23.2	22.81
	100	DFT-S	64QAM	21.33	21.13
	100	CP	QPSK	25.61	25.1
	200	DFT-S	QPSK	21.93	21.76
	200	DFT-S	16QAM	21.79	21.36
	200	DFT-S	64QAM	19.05	19.31
	200	CP	QPSK	21.93	21.96

Note : The 200MHz Bw is carrier aggregation by 2CC of 100MHz.



NR Band n260 Module A AGH+V (Beam ID:3+3)					
Maximum Average EIRP [dBm]					
	BW [MHz]	Waveform	Modulation	Inner 1RB	Inner Full
Highest	50	DFT-S	QPSK	24.8	25.11
	50	DFT-S	16QAM	22.07	22.03
	50	DFT-S	64QAM	19.44	19.99
	50	CP	QPSK	22.83	23.08
	100	DFT-S	QPSK	24.94	25.09
	100	DFT-S	16QAM	22.07	21.99
	100	DFT-S	64QAM	19.03	19.95
	100	CP	QPSK	22.86	23.08
	200	DFT-S	QPSK	20.68	20.39
	200	DFT-S	16QAM	19.02	18
	200	DFT-S	64QAM	17.16	16.88
	200	CP	QPSK	20.47	20.52

Note : The 200MHz Bw is carrier aggregation by 2CC of 100MHz.

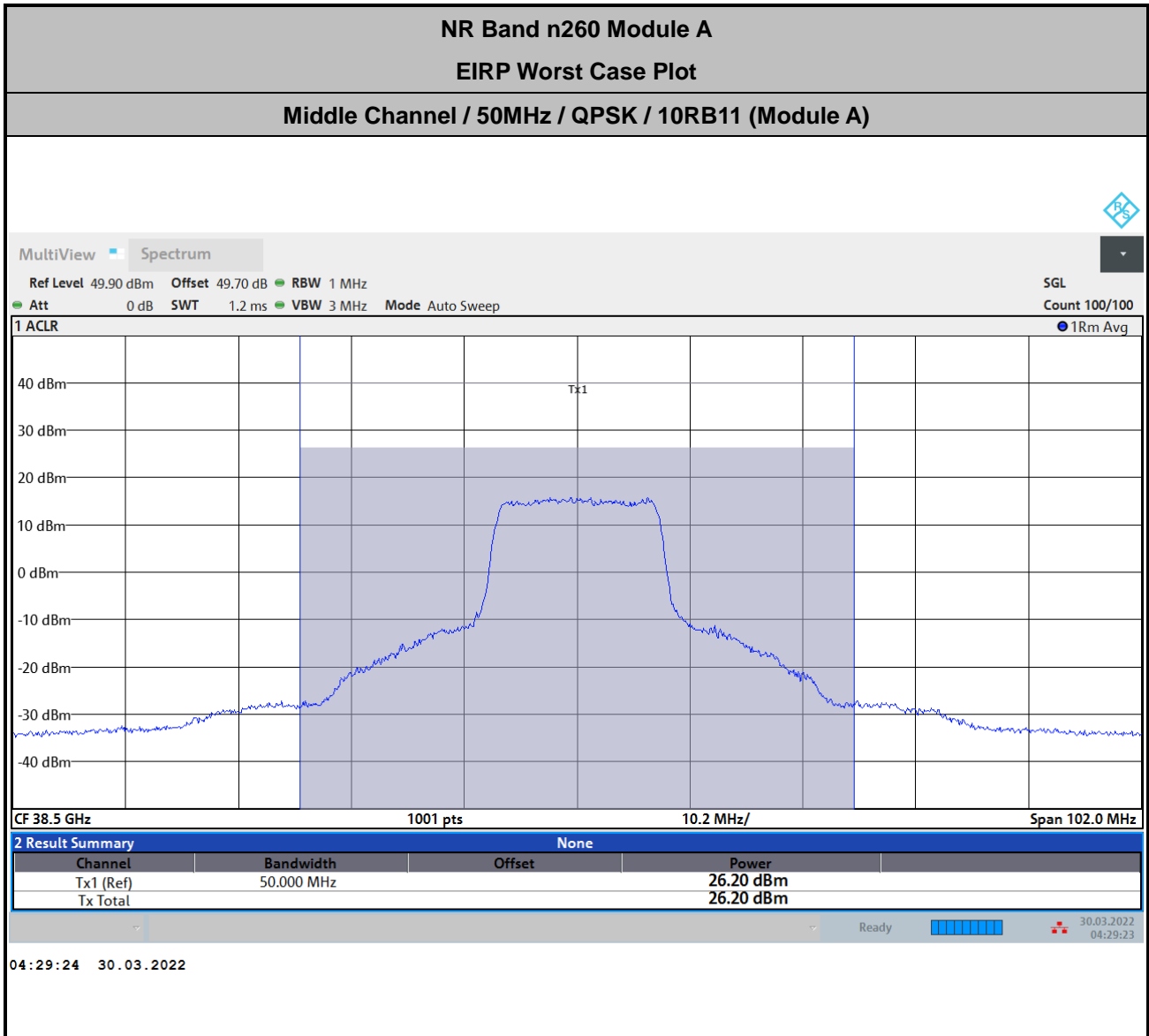

$$\text{Offset} = \text{Antenna Factor (dB/m)} + \text{Cable Loss (dB)} + 107 + 20\log(D) - 104.8$$

$$= 43.8 + 3.7 + 107 + 20\log(1) - 104.8 = 49.7 \text{ (dB)}$$

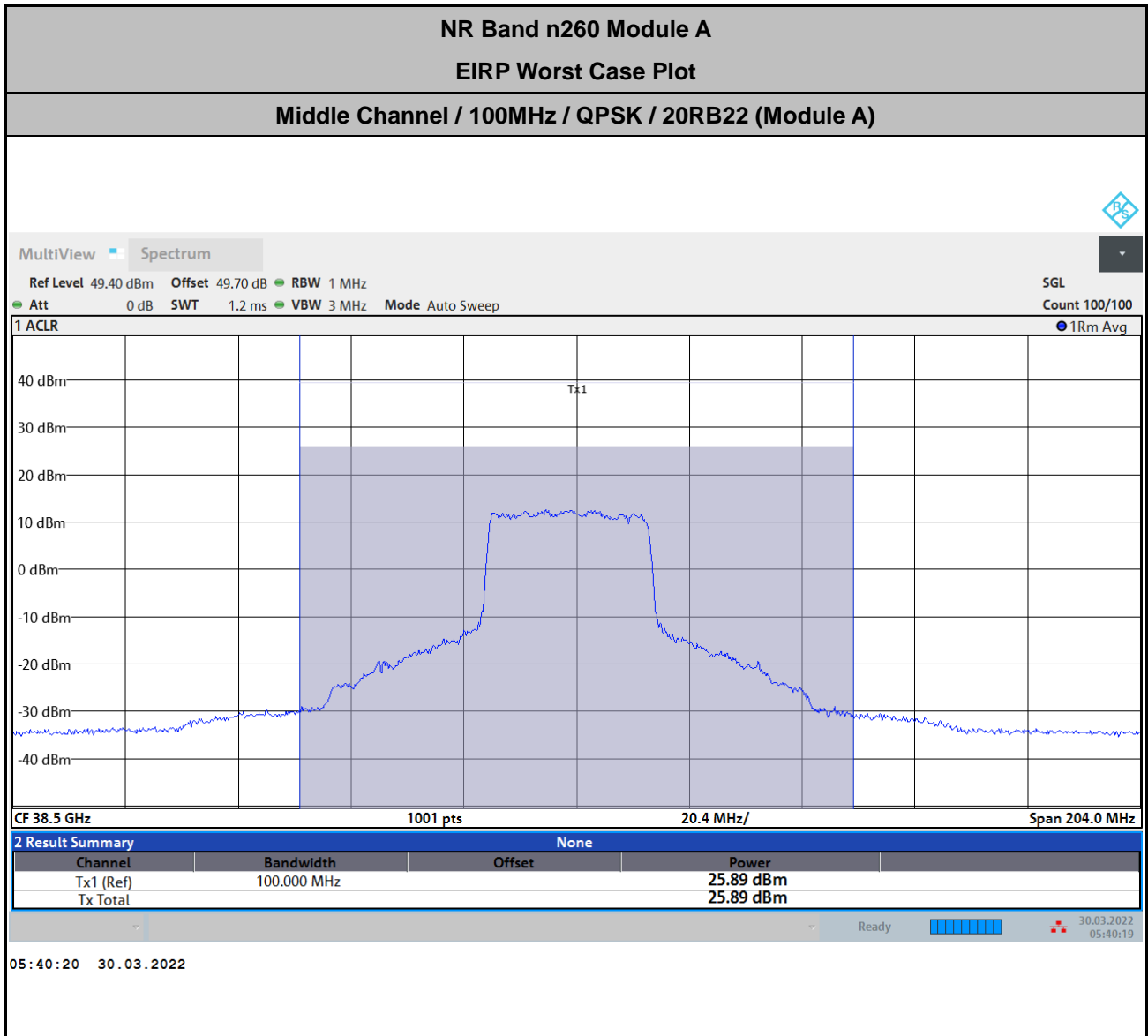

$$\text{Offset} = \text{Antenna Factor (dB/m)} + \text{Cable Loss (dB)} + 107 + 20\log(D) - 104.8$$

$$= 43.8 + 3.7 + 107 + 20\log(1) - 104.8 = 49.7 \text{ (dB)}$$

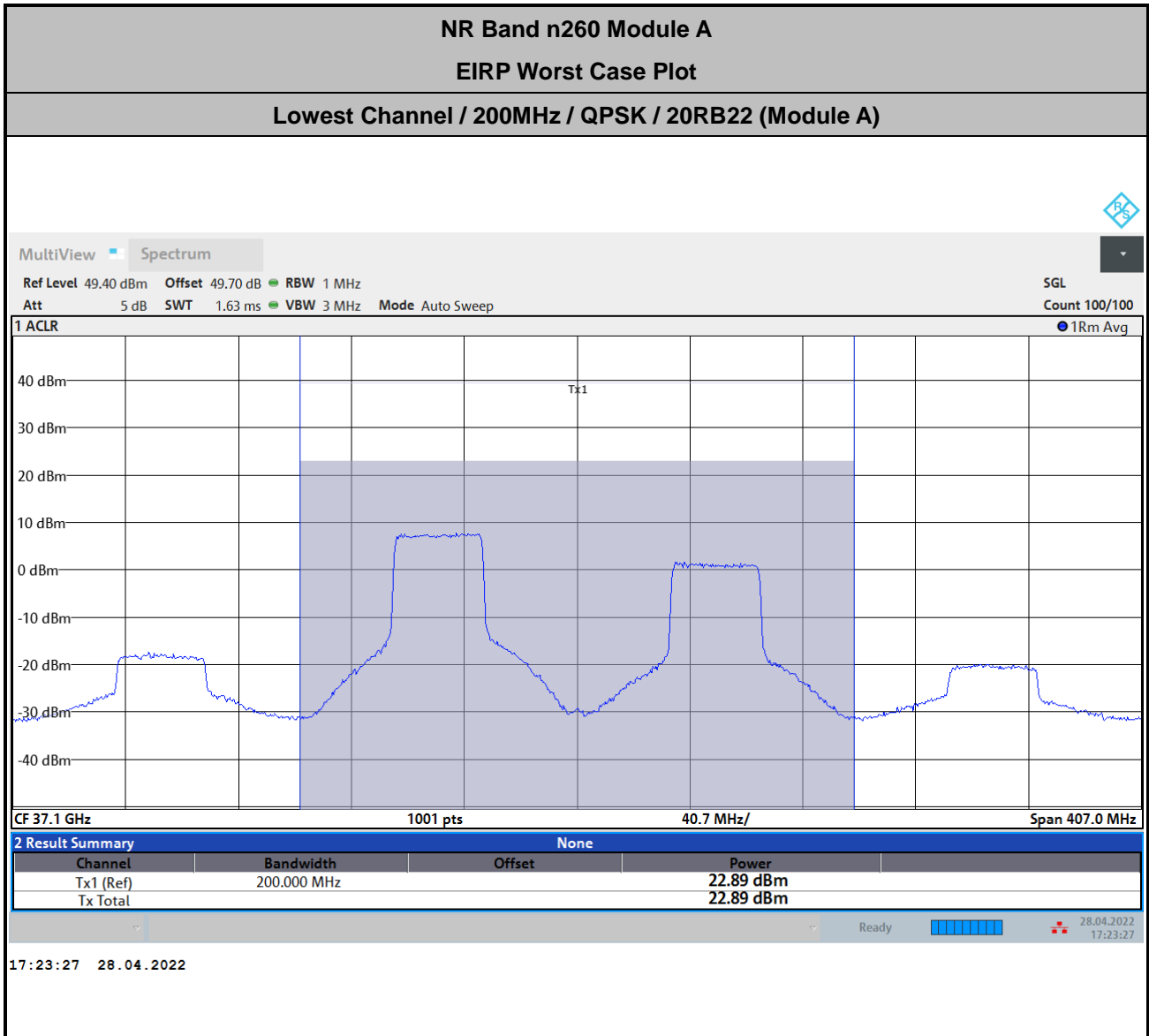

$$\text{Offset} = \text{Antenna Factor (dB/m)} + \text{Cable Loss (dB)} + 107 + 20\log(D) - 104.8$$

$$= 43.8 + 3.7 + 107 + 20\log(1) - 104.8 = 49.7 \text{ (dB)}$$



<Module B>

NR Band n260 Module B AGH+V (Beam ID:3+3)					
Maximum Average EIRP [dBm]					
	BW [MHz]	Waveform	Modulation	Inner 1RB	Inner Full
Lowest	50	DFT-S	QPSK	25.41	25.45
	50	DFT-S	16QAM	22.45	22.44
	50	DFT-S	64QAM	20.5	20.48
	50	CP	QPSK	22.04	22.14
	100	DFT-S	QPSK	25.32	25.54
	100	DFT-S	16QAM	22.5	22.56
	100	DFT-S	64QAM	19.88	20.43
	100	CP	QPSK	22.09	21.98
	200	DFT-S	QPSK	23.38	23.4
	200	DFT-S	16QAM	20.59	20.65
	200	DFT-S	64QAM	17.71	18.43
	200	CP	QPSK	20.21	20.28

Note : The 200MHz Bw is carrier aggregation by 2CC of 100MHz.

NR Band n260 Module B AGH+V (Beam ID:3+3)					
Maximum Average EIRP [dBm]					
	BW [MHz]	Waveform	Modulation	Inner 1RB	Inner Full
Middle	50	DFT-S	QPSK	26.44	26.53
	50	DFT-S	16QAM	23.59	23.63
	50	DFT-S	64QAM	21.34	21.55
	50	CP	QPSK	23.34	23.35
	100	DFT-S	QPSK	26.19	26.26
	100	DFT-S	16QAM	23.76	23.19
	100	DFT-S	64QAM	20.96	21.1
	100	CP	QPSK	22.62	22.7
	200	DFT-S	QPSK	24.72	24.09
	200	DFT-S	16QAM	21.77	21.29
	200	DFT-S	64QAM	18.84	19.22
	200	CP	QPSK	20.76	20.71

Note : The 200MHz Bw is carrier aggregation by 2CC of 100MHz.



NR Band n260 Module B AGH+V (Beam ID:3+3)					
Maximum Average EIRP [dBm]					
	BW [MHz]	Waveform	Modulation	Inner 1RB	Inner Full
Highest	50	DFT-S	QPSK	24.37	24.34
	50	DFT-S	16QAM	21.74	21.4
	50	DFT-S	64QAM	18.93	19.46
	50	CP	QPSK	20.81	21.27
	100	DFT-S	QPSK	24.25	24.16
	100	DFT-S	16QAM	21.72	21.3
	100	DFT-S	64QAM	18.56	19.49
	100	CP	QPSK	20.77	20.96
	200	DFT-S	QPSK	22.33	22.16
	200	DFT-S	16QAM	18.62	18.77
	200	DFT-S	64QAM	17.35	16.39
	200	CP	QPSK	17.64	17.83

Note : The 200MHz Bw is carrier aggregation by 2CC of 100MHz.

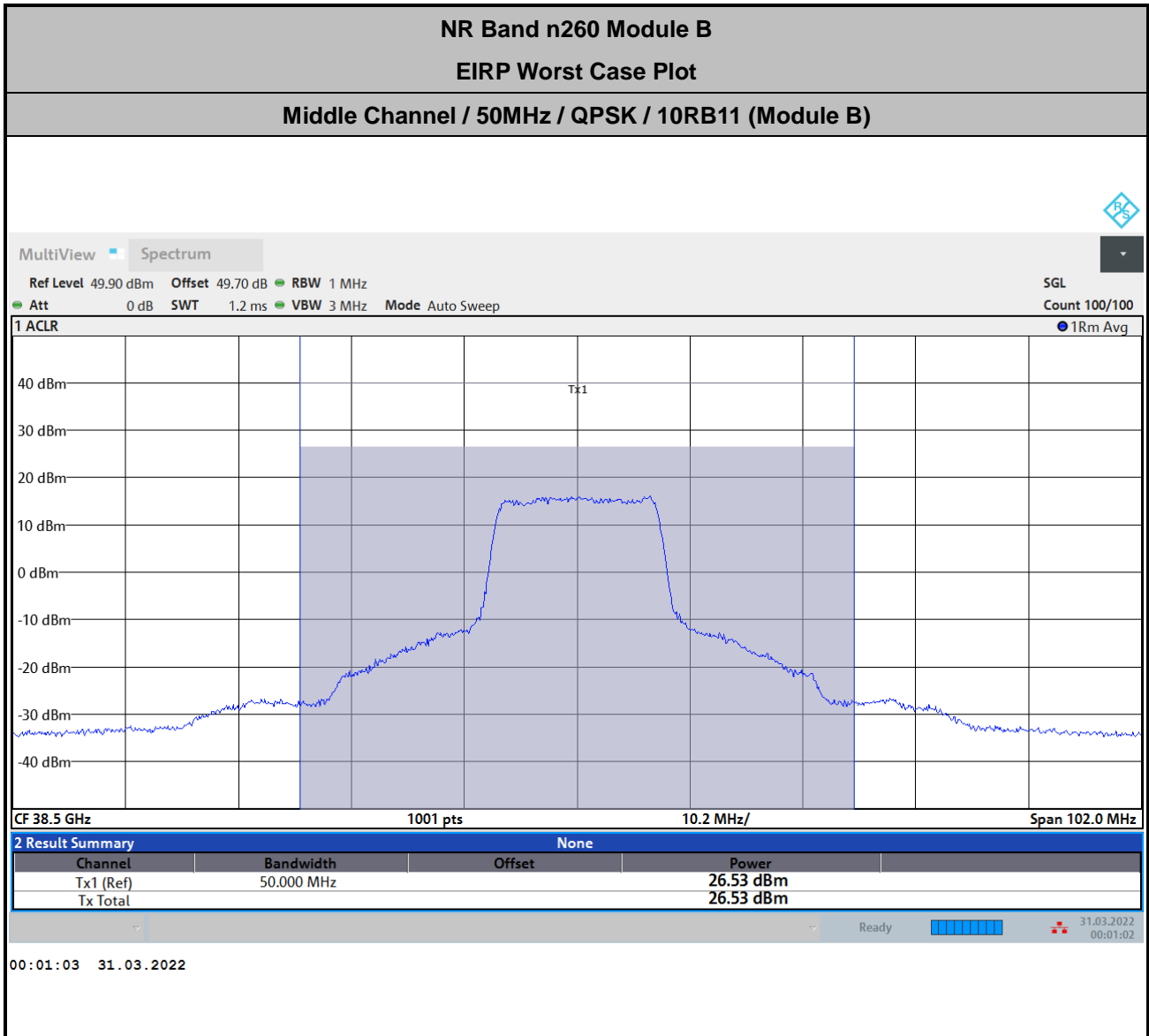

$$\text{Offset} = \text{Antenna Factor (dB/m)} + \text{Cable Loss (dB)} + 107 + 20\log(D) - 104.8$$

$$= 43.8 + 3.7 + 107 + 20\log(1) - 104.8 = 49.7 \text{ (dB)}$$

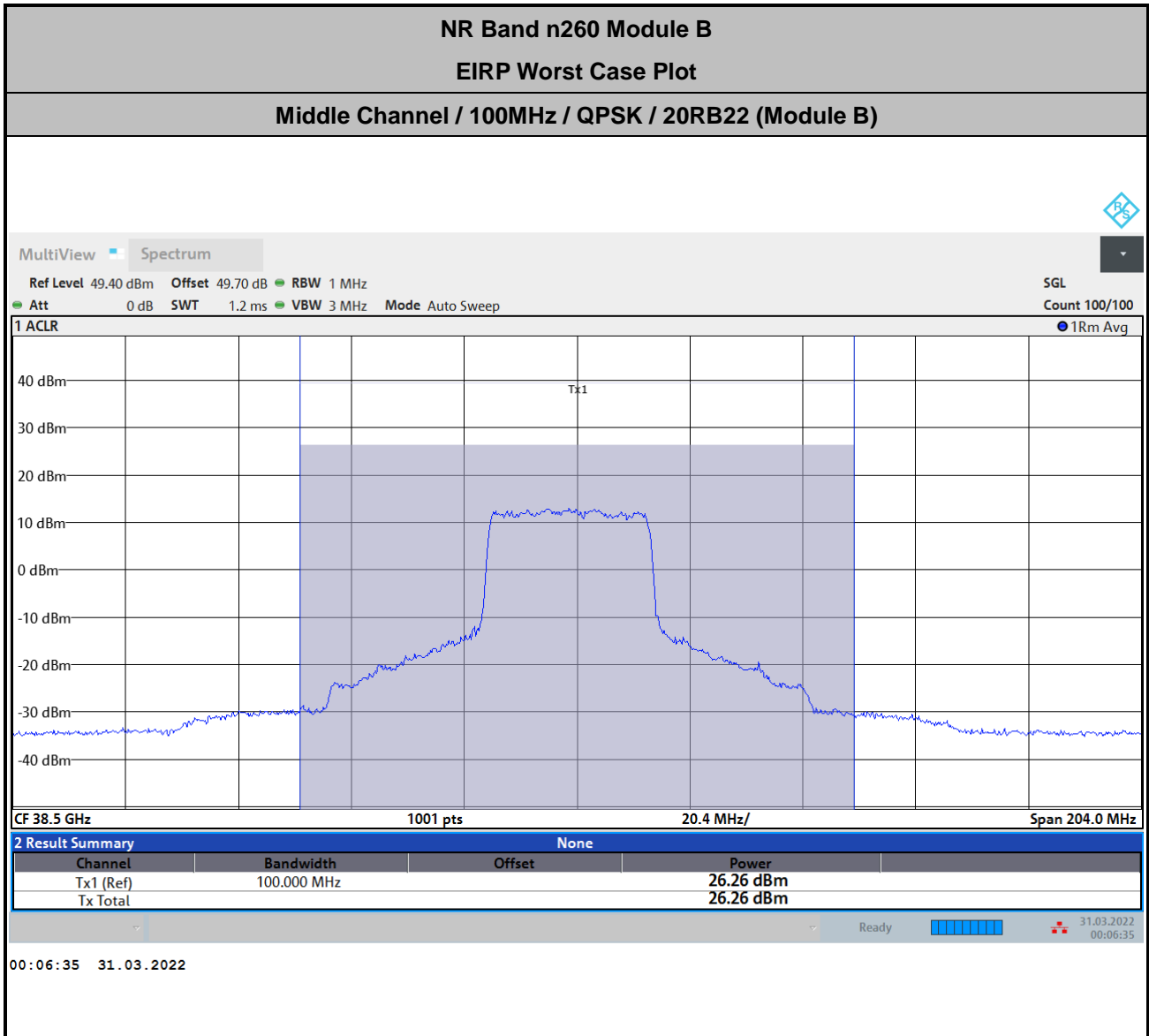

$$\text{Offset} = \text{Antenna Factor (dB/m)} + \text{Cable Loss (dB)} + 107 + 20\log(D) - 104.8$$

$$= 43.8 + 3.7 + 107 + 20\log(1) - 104.8 = 49.7 \text{ (dB)}$$

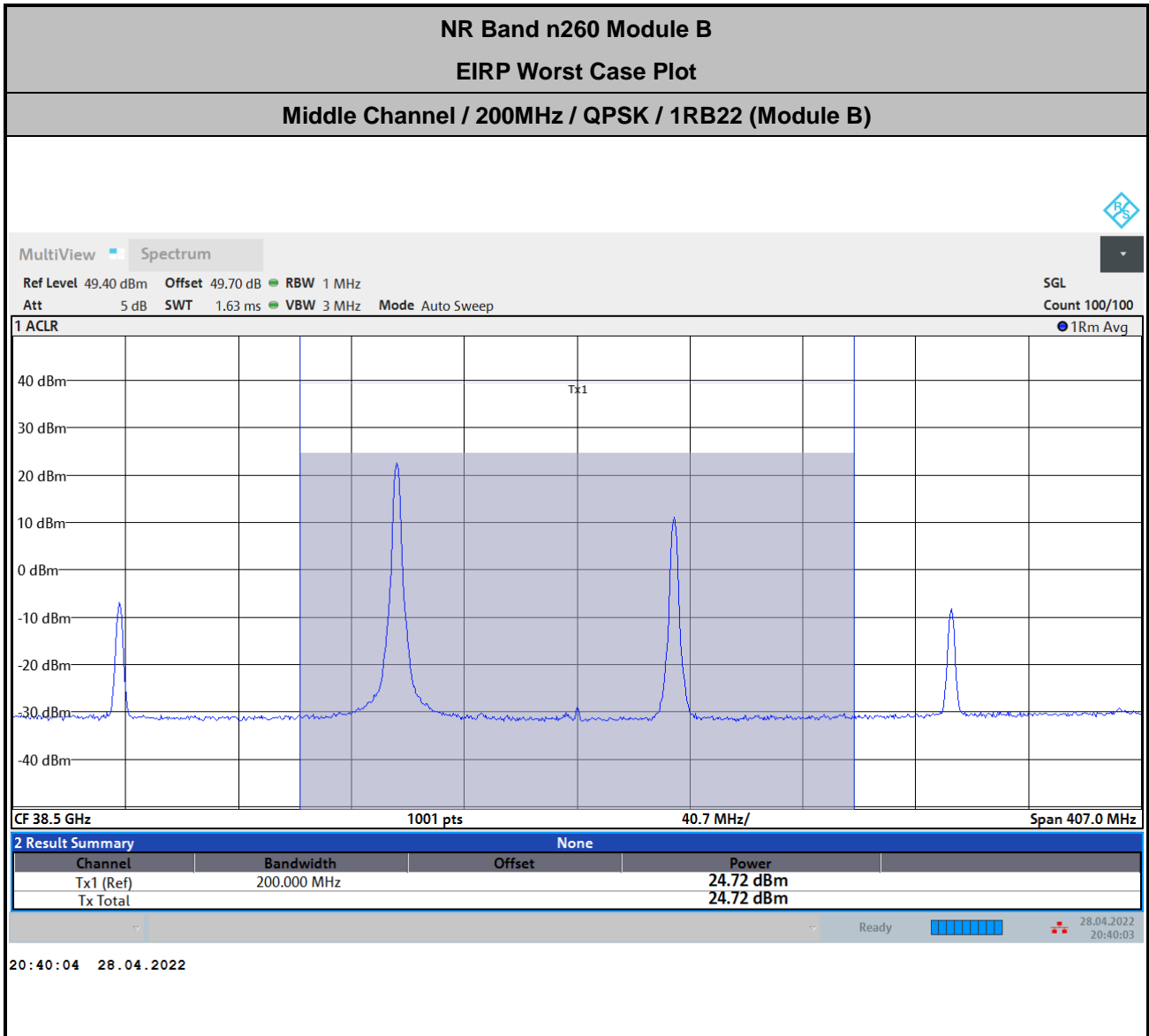

$$\text{Offset} = \text{Antenna Factor (dB/m)} + \text{Cable Loss (dB)} + 107 + 20\log(D) - 104.8$$

$$= 43.8 + 3.7 + 107 + 20\log(1) - 104.8 = 49.7 \text{ (dB)}$$



<Module A>

NR Band n261 Module A AGH+V (Beam ID:3+3)					
Maximum Average EIRP [dBm]					
	BW [MHz]	Waveform	Modulation	Inner 1RB	Inner Full
Lowest	50	DFT-S	QPSK	24.35	24.58
	50	DFT-S	16QAM	21.39	21.61
	50	DFT-S	64QAM	19.38	19.45
	50	CP	QPSK	20.83	20.72
	100	DFT-S	QPSK	24.05	23.95
	100	DFT-S	16QAM	21.46	21.03
	100	DFT-S	64QAM	18.68	19.11
	100	CP	QPSK	21.16	20.69
	200	DFT-S	QPSK	22.47	22.55
	200	DFT-S	16QAM	18.98	19.72
	200	DFT-S	64QAM	17.15	17.61
	200	CP	QPSK	19.06	19

Note : The 200MHz Bw is carrier aggregation by 2CC of 100MHz.

NR Band n261 Module A AGH+V (Beam ID:3+3)					
Maximum Average EIRP [dBm]					
	BW [MHz]	Waveform	Modulation	Inner 1RB	Inner Full
Middle	50	DFT-S	QPSK	23.31	23.38
	50	DFT-S	16QAM	20.29	20.4
	50	DFT-S	64QAM	18.36	18.43
	50	CP	QPSK	20.26	20.18
	100	DFT-S	QPSK	24.12	24.21
	100	DFT-S	16QAM	21.09	21.42
	100	DFT-S	64QAM	18.51	19.42
	100	CP	QPSK	20.26	20.93
	200	DFT-S	QPSK	21.87	21.89
	200	DFT-S	16QAM	19.05	18.95
	200	DFT-S	64QAM	16.54	16.75
	200	CP	QPSK	18.38	18.34

Note : The 200MHz Bw is carrier aggregation by 2CC of 100MHz.



NR Band n261 Module A AGH+V (Beam ID:3+3)					
Maximum Average EIRP [dBm]					
Highest	BW [MHz]	Waveform	Modulation	Inner 1RB	Inner Full
	50	DFT-S	QPSK	24.36	24.31
	50	DFT-S	16QAM	21.62	21.45
	50	DFT-S	64QAM	19.29	19.44
	50	CP	QPSK	21.21	21.13
	100	DFT-S	QPSK	24.22	24.64
	100	DFT-S	16QAM	21.53	21.68
	100	DFT-S	64QAM	18.68	19.41
	100	CP	QPSK	20.69	21.06
	200	DFT-S	QPSK	22.75	23.15
	200	DFT-S	16QAM	20.19	20.08
	200	DFT-S	64QAM	17.15	17.83
	200	CP	QPSK	18.8	18.75

Note : The 200MHz Bw is carrier aggregation by 2CC of 100MHz.

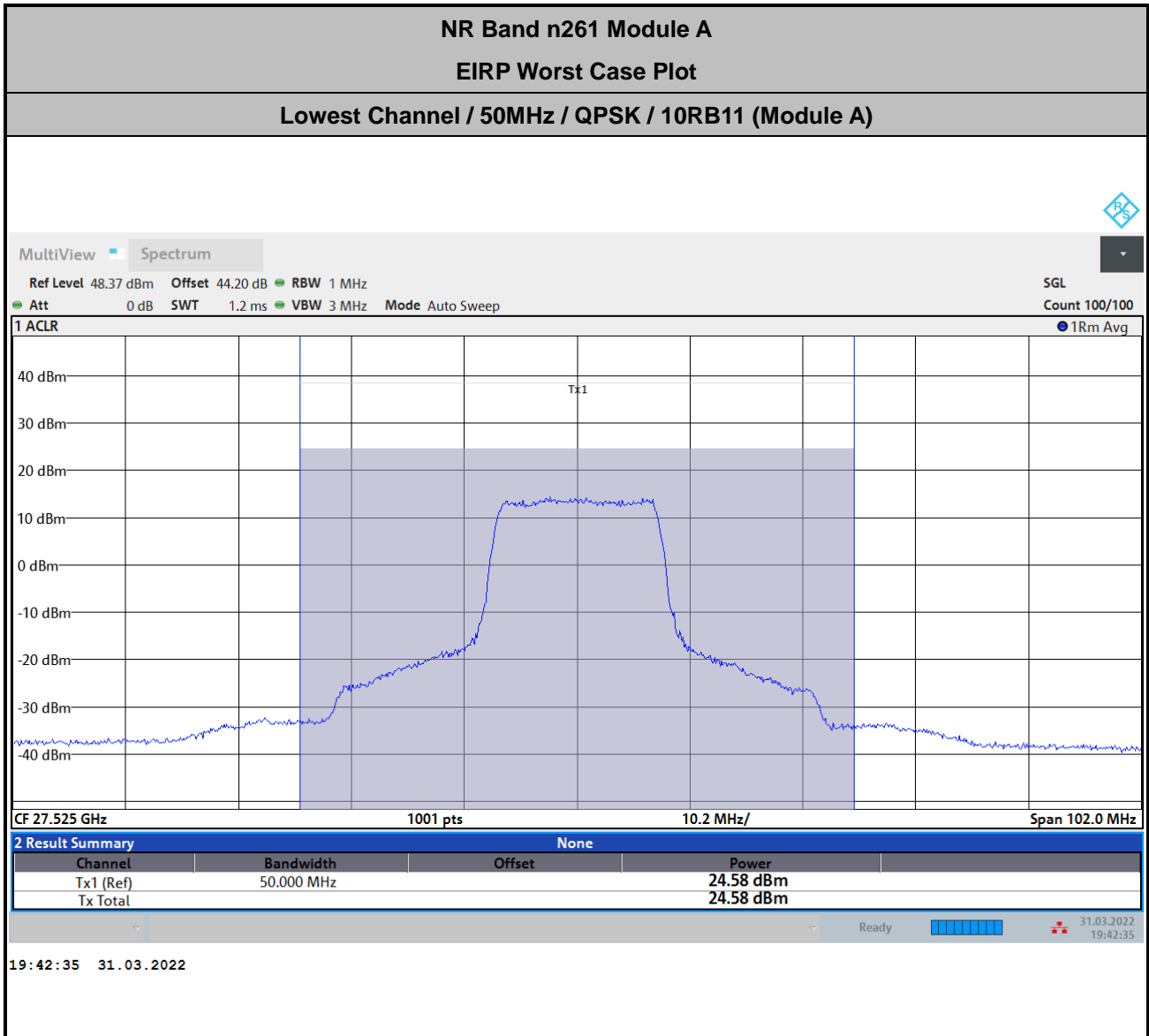

$$\text{Offset} = \text{Antenna Factor (dB/m)} + \text{Cable Loss (dB)} + 107 + 20\log(D) - 104.8$$

$$= 39.3 + 2.7 + 107 + 20\log(1) - 104.8 = 44.2 \text{ (dB)}$$

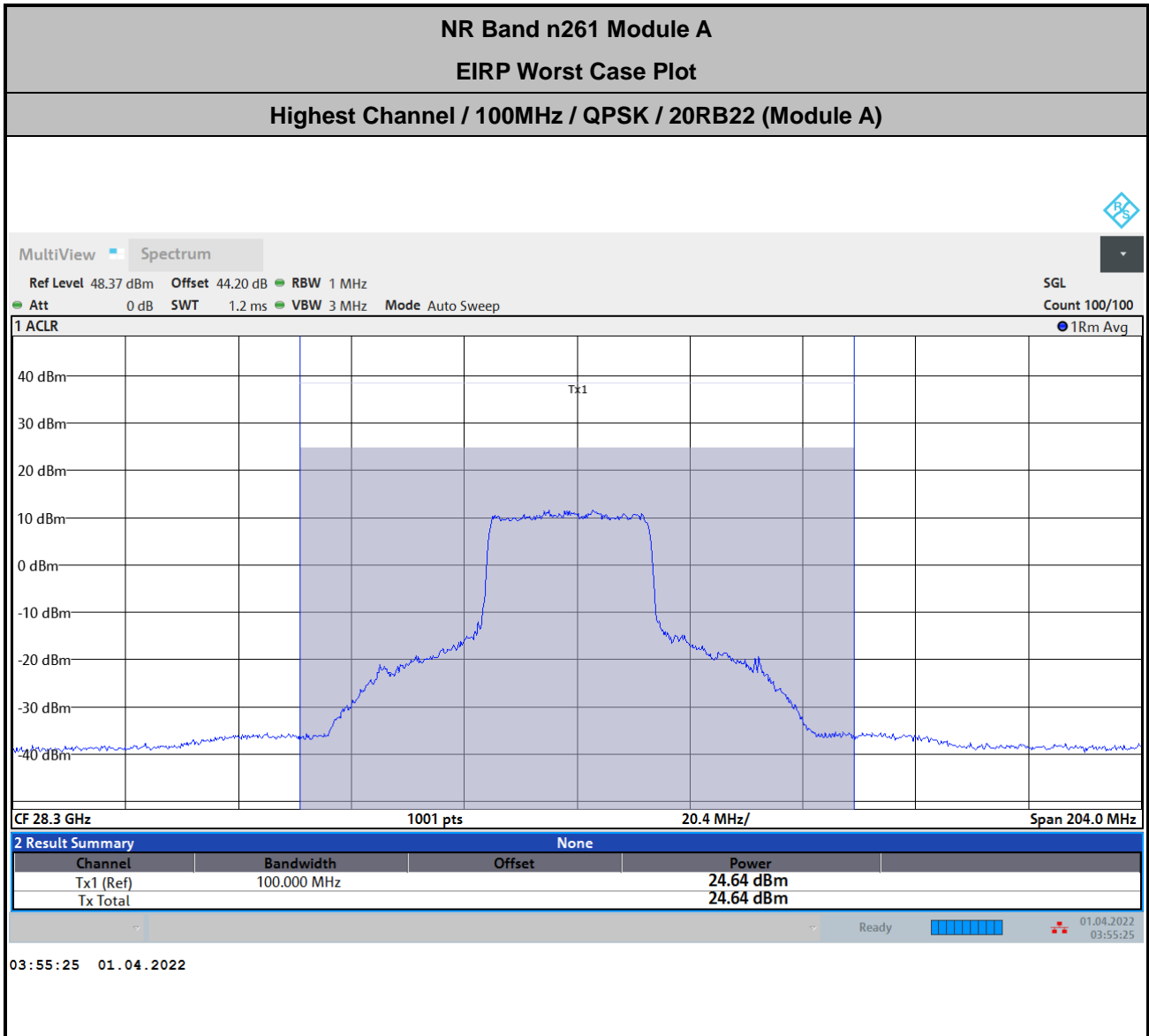

$$\text{Offset} = \text{Antenna Factor (dB/m)} + \text{Cable Loss (dB)} + 107 + 20\log(D) - 104.8$$

$$= 39.3 + 2.7 + 107 + 20\log(1) - 104.8 = 44.2 \text{ (dB)}$$

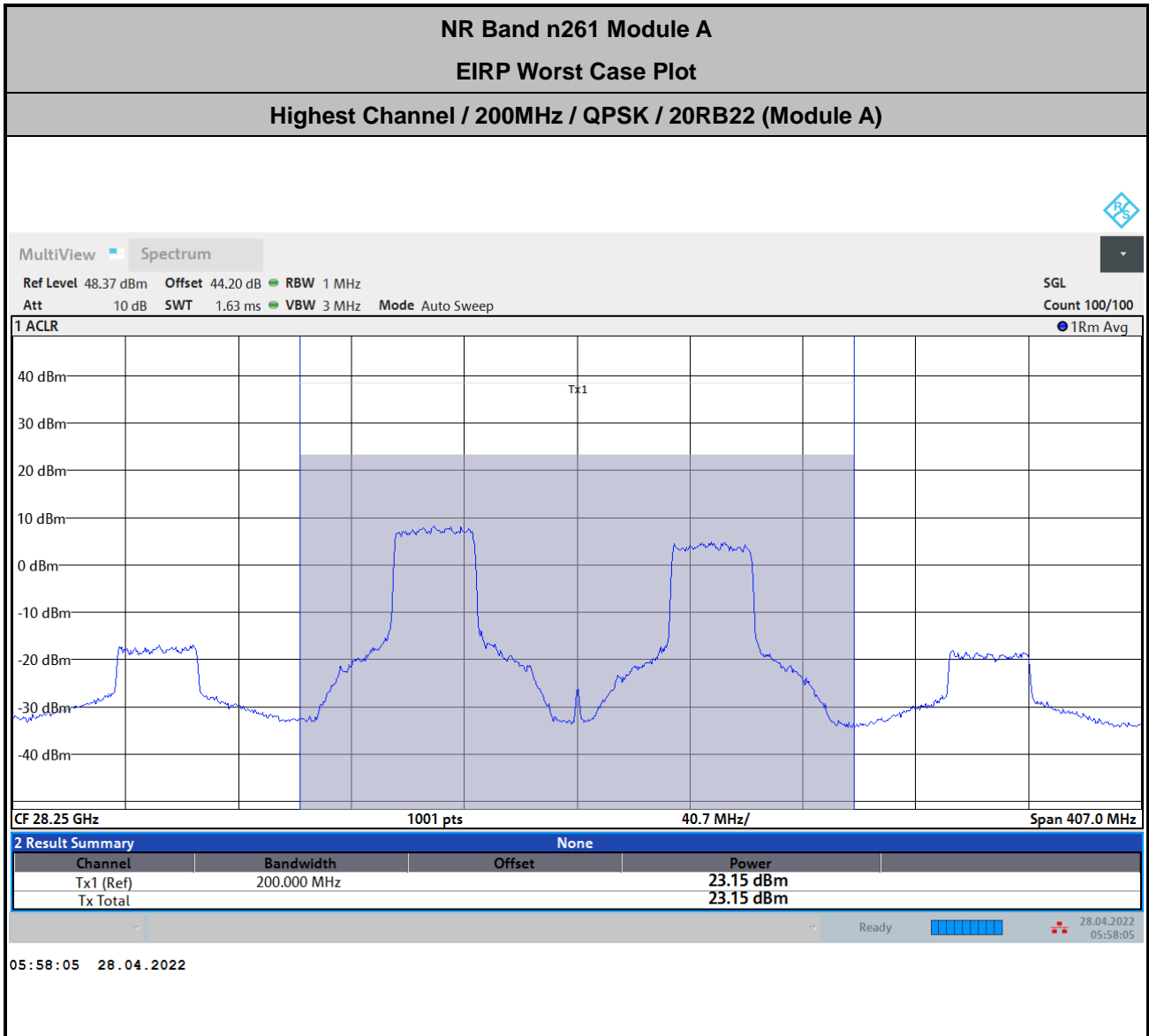

$$\text{Offset} = \text{Antenna Factor (dB/m)} + \text{Cable Loss (dB)} + 107 + 20\log(D) - 104.8$$

$$= 39.3 + 2.7 + 107 + 20\log(1) - 104.8 = 44.2 \text{ (dB)}$$



<Module B>

NR Band n261 Module B AGH+V (Beam ID:3+3)					
Maximum Average EIRP [dBm]					
	BW [MHz]	Waveform	Modulation	Inner 1RB	Inner Full
Lowest	50	DFT-S	QPSK	26.12	26.03
	50	DFT-S	16QAM	23.1	23.08
	50	DFT-S	64QAM	21.13	21.16
	50	CP	QPSK	22.91	22.77
	100	DFT-S	QPSK	26.32	25.96
	100	DFT-S	16QAM	22.98	22.96
	100	DFT-S	64QAM	21.02	20.97
	100	CP	QPSK	22.82	22.41
	200	DFT-S	QPSK	22.73	23.04
	200	DFT-S	16QAM	19.89	20.1
	200	DFT-S	64QAM	17.24	17.82
	200	CP	QPSK	19.35	19.27

Note : The 200MHz Bw is carrier aggregation by 2CC of 100MHz.

NR Band n261 Module B AGH+V (Beam ID:3+3)					
Maximum Average EIRP [dBm]					
	BW [MHz]	Waveform	Modulation	Inner 1RB	Inner Full
Middle	50	DFT-S	QPSK	23.34	23.62
	50	DFT-S	16QAM	20.23	20.52
	50	DFT-S	64QAM	18.04	18.62
	50	CP	QPSK	20.3	20.64
	100	DFT-S	QPSK	24.42	24.68
	100	DFT-S	16QAM	21.7	21.73
	100	DFT-S	64QAM	18.85	19.5
	100	CP	QPSK	20.95	21.11
	200	DFT-S	QPSK	22.4	22.47
	200	DFT-S	16QAM	19.89	19.66
	200	DFT-S	64QAM	17.2	17.4
	200	CP	QPSK	18.26	18.22

Note : The 200MHz Bw is carrier aggregation by 2CC of 100MHz.



NR Band n261 Module B AGH+V (Beam ID:3+3)					
Maximum Average EIRP [dBm]					
	BW [MHz]	Waveform	Modulation	Inner 1RB	Inner Full
Highest	50	DFT-S	QPSK	24.33	24.38
	50	DFT-S	16QAM	21.43	21.4
	50	DFT-S	64QAM	19.04	19.53
	50	CP	QPSK	20.97	21.17
	100	DFT-S	QPSK	25	24.85
	100	DFT-S	16QAM	22.27	21.92
	100	DFT-S	64QAM	19.35	19.9
	100	CP	QPSK	21.51	21.38
	200	DFT-S	QPSK	23.68	23.93
	200	DFT-S	16QAM	21.1	20.9
	200	DFT-S	64QAM	18.52	18.8
	200	CP	QPSK	20.74	20.32

Note : The 200MHz Bw is carrier aggregation by 2CC of 100MHz.

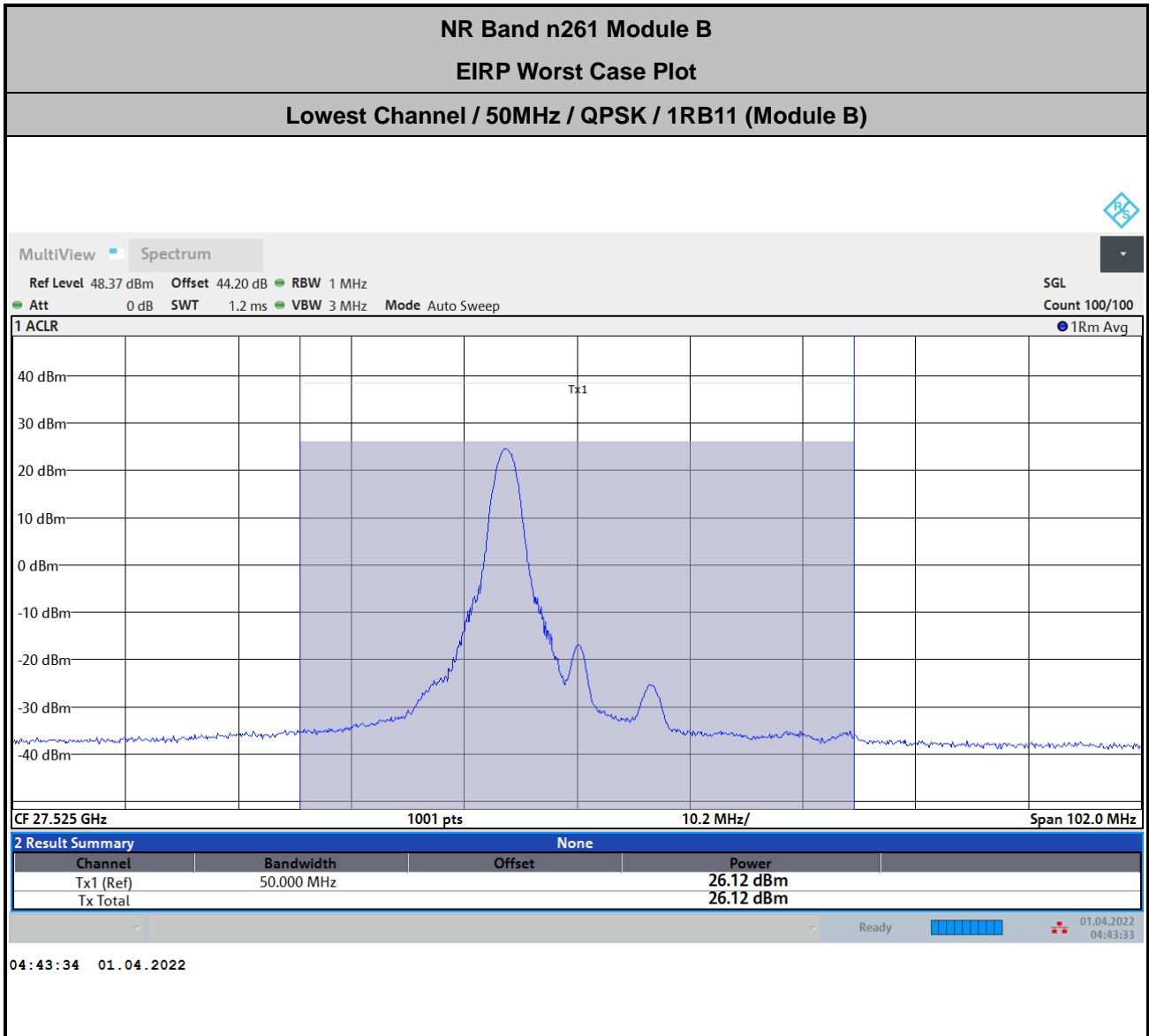

$$\text{Offset} = \text{Antenna Factor (dB/m)} + \text{Cable Loss (dB)} + 107 + 20\log(D) - 104.8$$

$$= 39.3 + 2.7 + 107 + 20\log(1) - 104.8 = 44.2 \text{ (dB)}$$

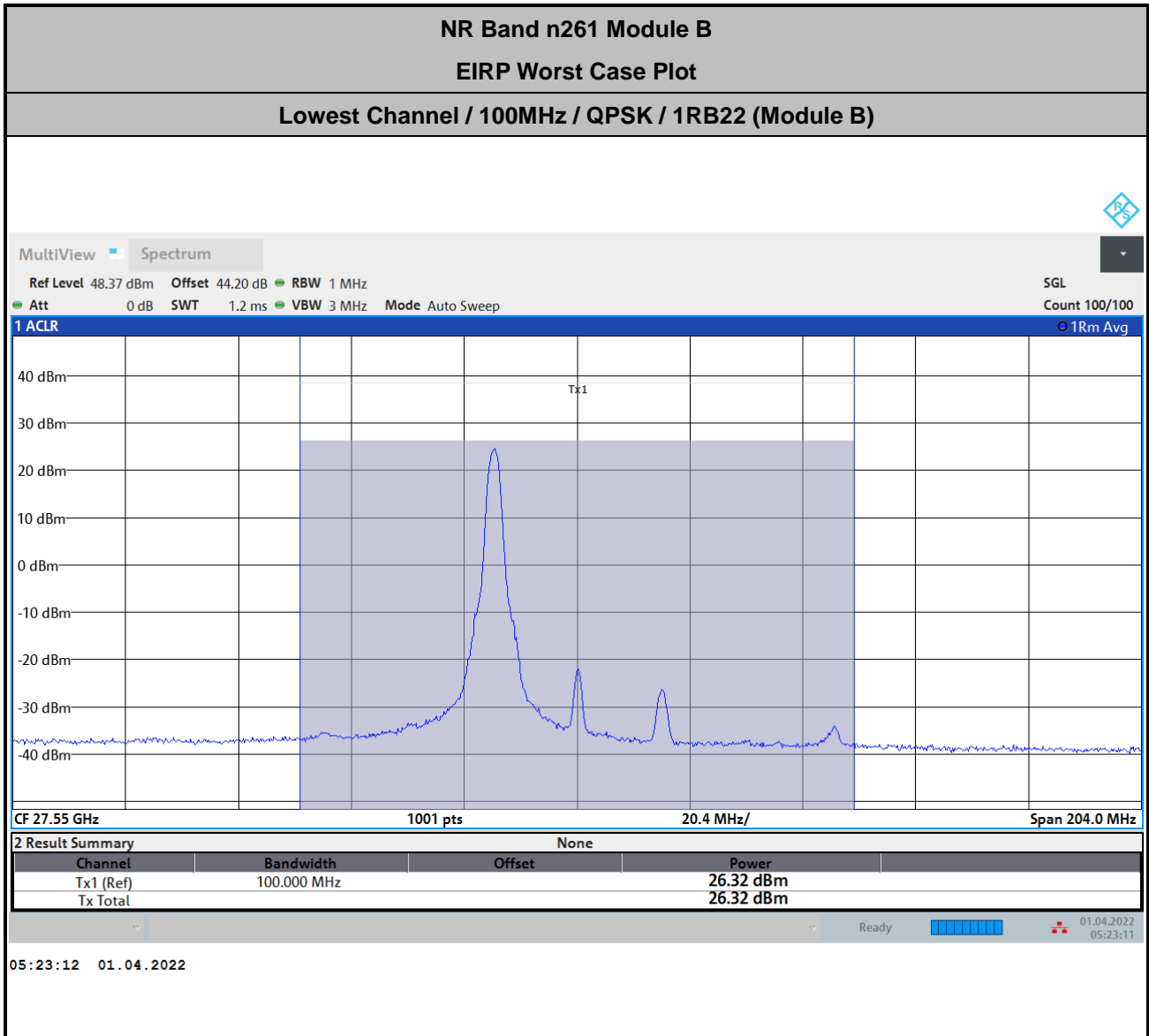

$$\text{Offset} = \text{Antenna Factor (dB/m)} + \text{Cable Loss (dB)} + 107 + 20\log(D) - 104.8$$

$$= 39.3 + 2.7 + 107 + 20\log(1) - 104.8 = 44.2 \text{ (dB)}$$

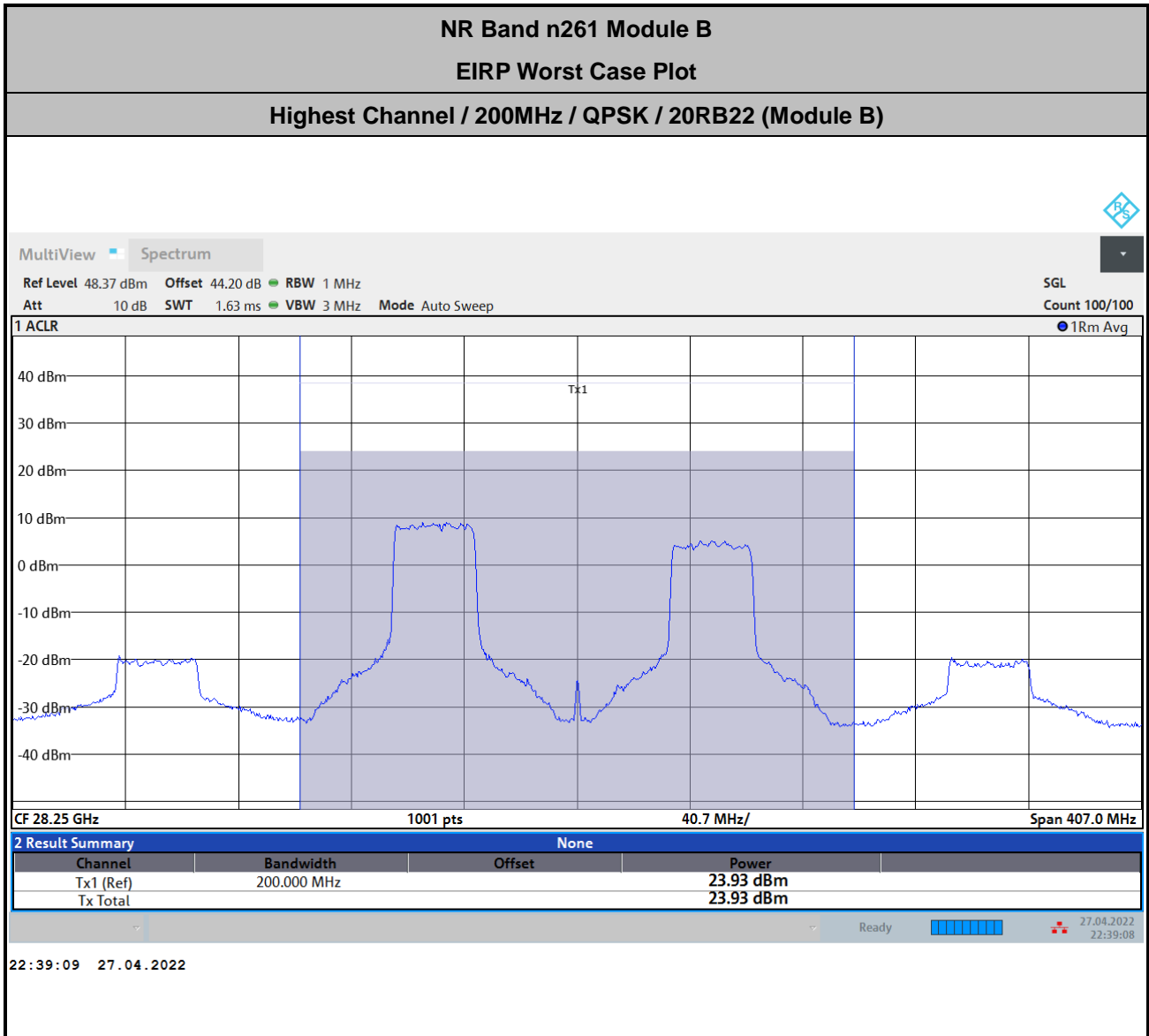

$$\text{Offset} = \text{Antenna Factor (dB/m)} + \text{Cable Loss (dB)} + 107 + 20\log(D) - 104.8$$

$$= 39.3 + 2.7 + 107 + 20\log(1) - 104.8 = 44.2 \text{ (dB)}$$



NR Band n258A Module A A AGH+V

Occupied Bandwidth

Mode	DFT-s-OFDM Module A NR Band n258A : 99%OBW(MHz)								
BW	50MHz			100MHz			200MHz		
Mod.	QPSK	16QAM	64QAM	QPSK	16QAM	64QAM	QPSK	16QAM	64QAM
Lowest CH	46.50	46.31	46.30	91.41	91.59	91.23	-	-	-
Middle CH	46.41	46.34	45.90	91.92	91.67	91.32	189.67	189.55	188.91
Highest CH	46.36	46.36	46.39	91.88	91.71	91.32	-	-	-

Mode	CP-OFDM Module A NR Band n258A : 99%OBW(MHz)		
BW	50MHz	100MHz	200MHz
Mod.	QPSK	QPSK	QPSK
Lowest CH	46.58	94.50	-
Middle CH	46.78	94.81	193.70
Highest CH	47.31	96.66	-



DFT-s-OFDM Module A

NR Band n258A

Lowest Channel / 50MHz / QPSK

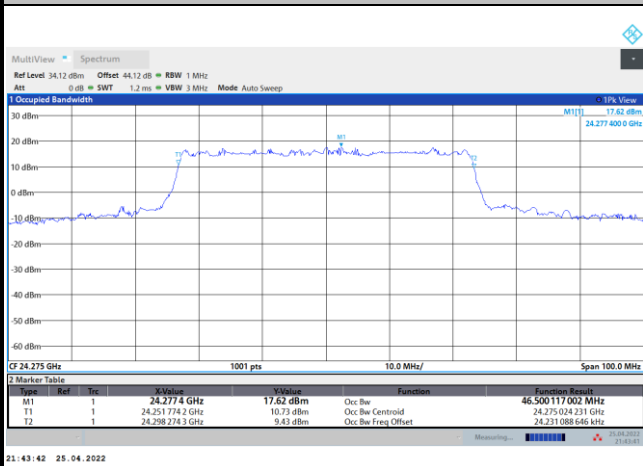

Lowest Channel / 50MHz / 16QAM

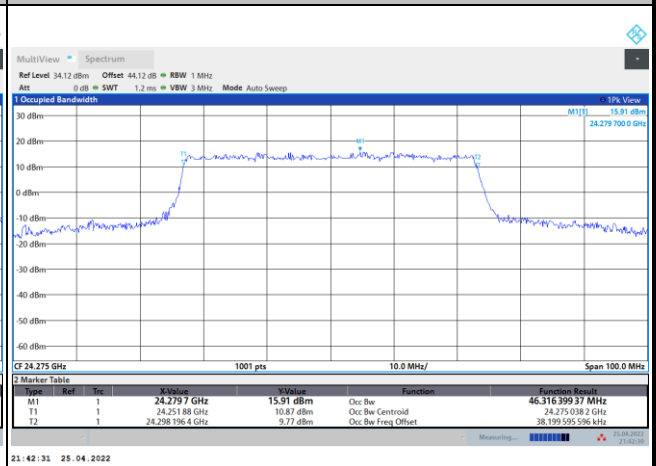

Middle Channel / 50MHz / QPSK

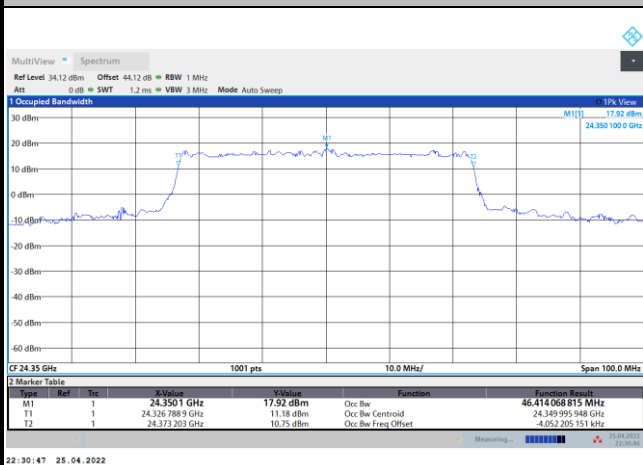

Middle Channel / 50MHz / 16QAM

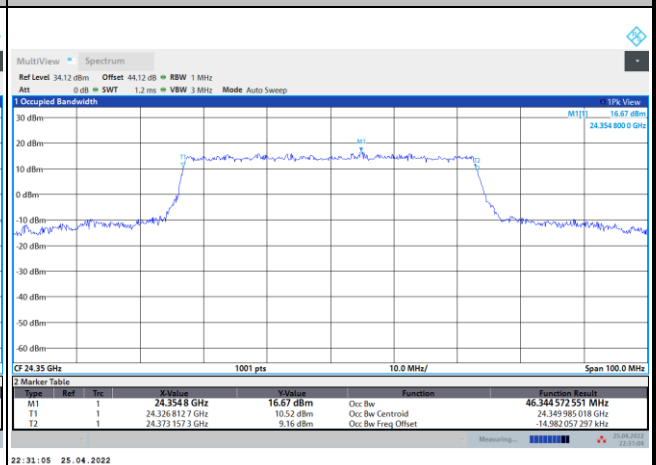

Highest Channel / 50MHz / QPSK

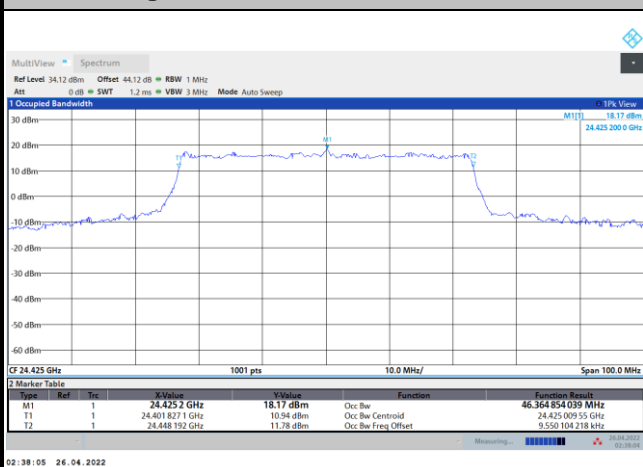

Highest Channel / 50MHz / 16QAM

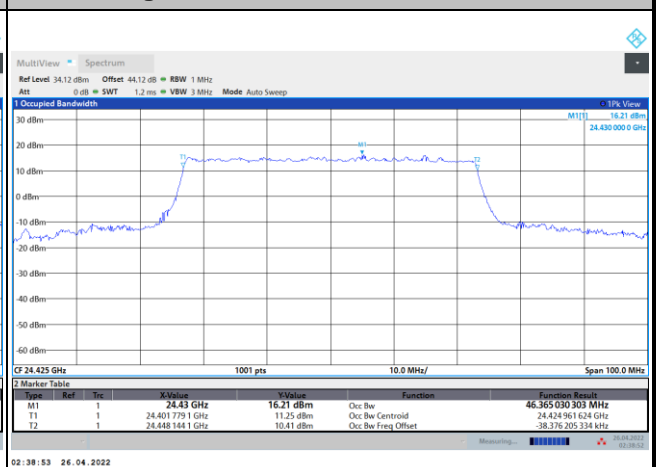



DFT-s-OFDM Module A

NR Band n258A

Lowest Channel / 50MHz / 64QAM

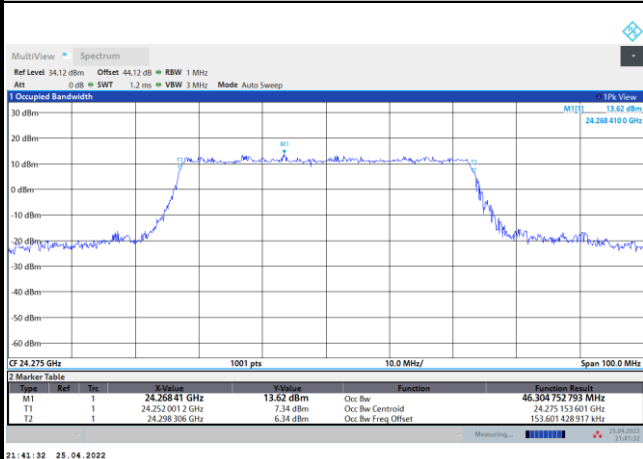

Lowest Channel / 100MHz / QPSK

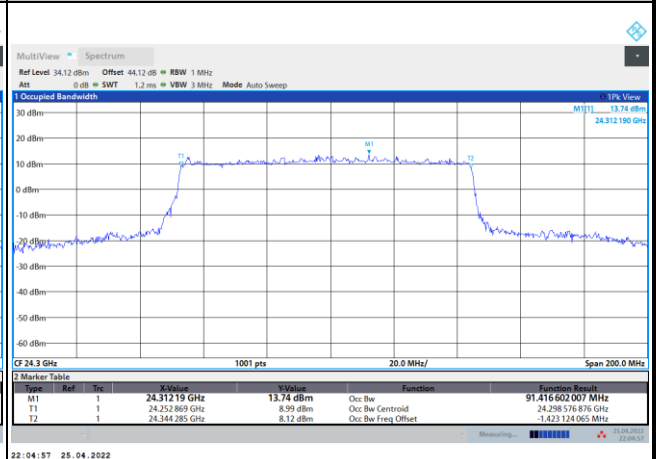

Middle Channel / 50MHz / 64QAM

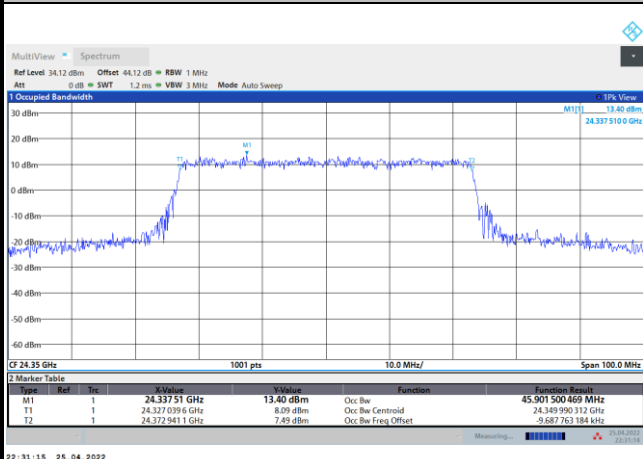

Middle Channel / 100MHz / QPSK

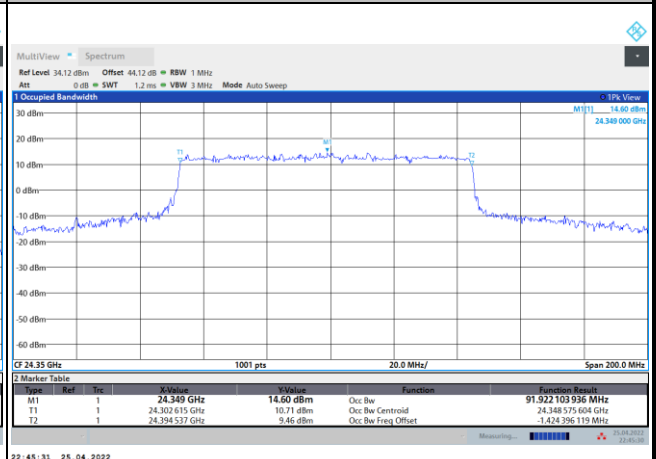

Highest Channel / 50MHz / 64QAM

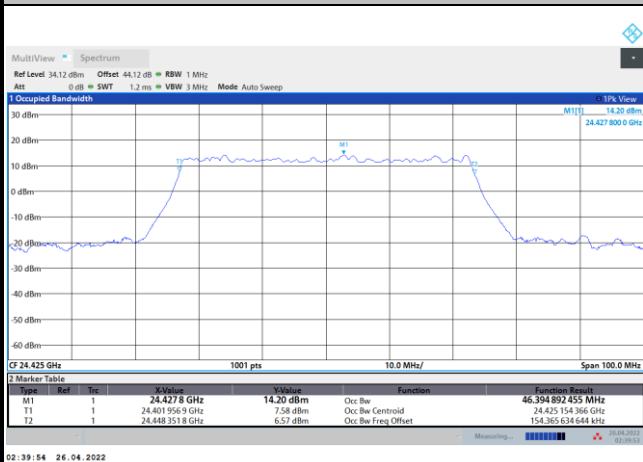

Highest Channel / 100MHz / QPSK

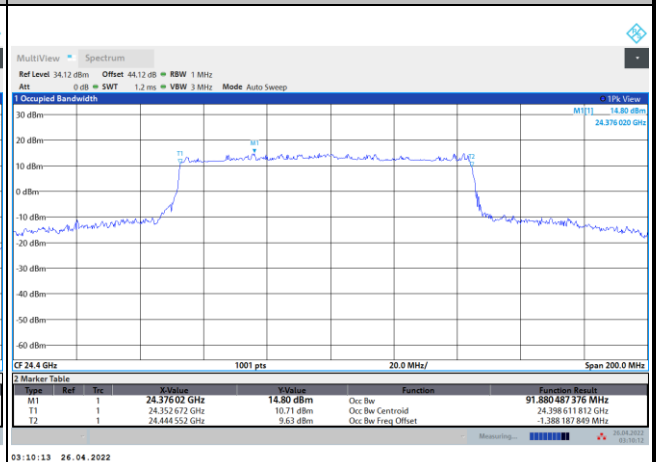



DFT-s-OFDM Module A

NR Band n258A

Lowest Channel / 100MHz / 16QAM

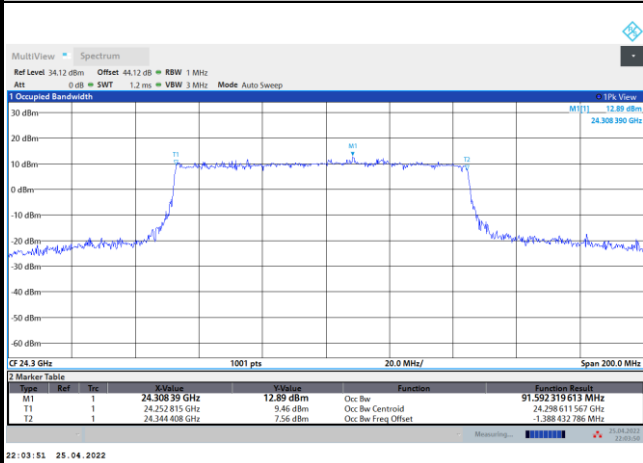

Lowest Channel / 100MHz / 64QAM

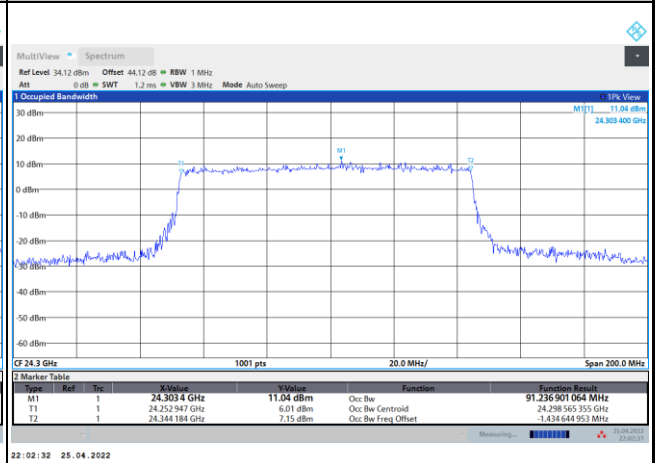

Middle Channel / 100MHz / 16QAM

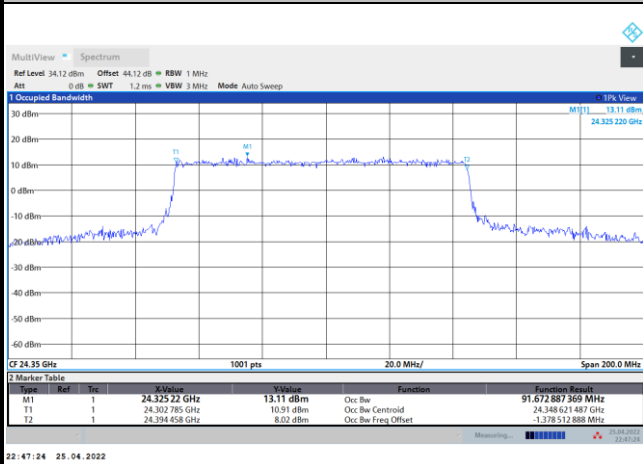

Middle Channel / 100MHz / 64QAM

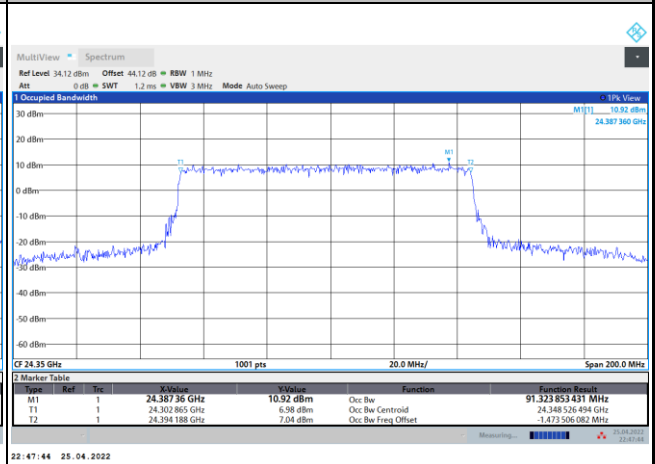

Highest Channel / 100MHz / 16QAM

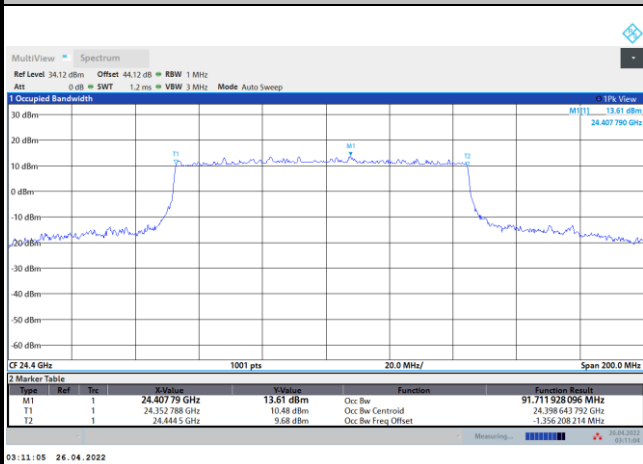

Highest Channel / 100MHz / 64QAM

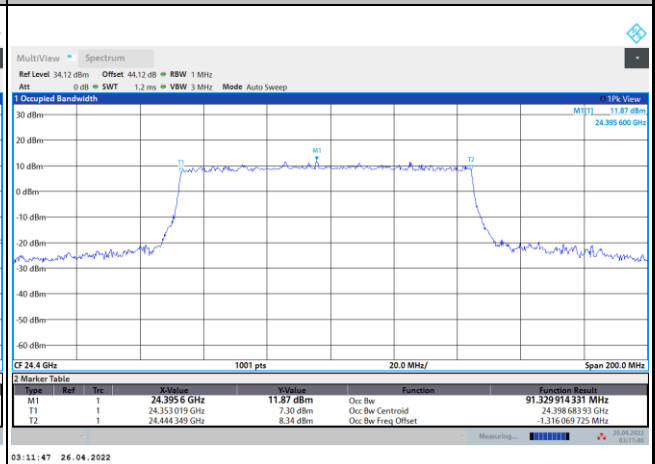



DFT-s-OFDM Module A

NR Band n258A

Middle Channel / 200MHz / QPSK

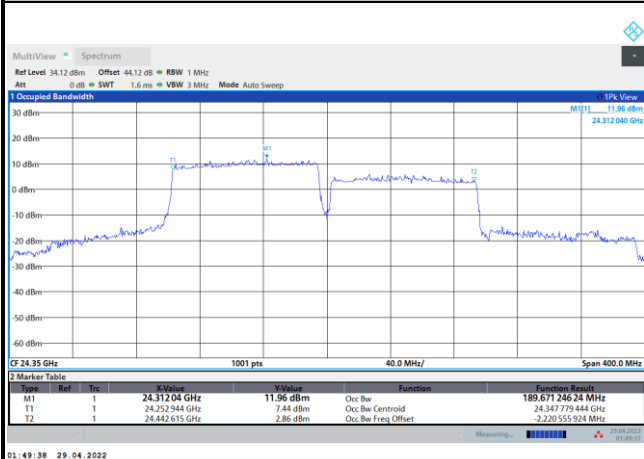

Middle Channel / 200MHz / 16QAM

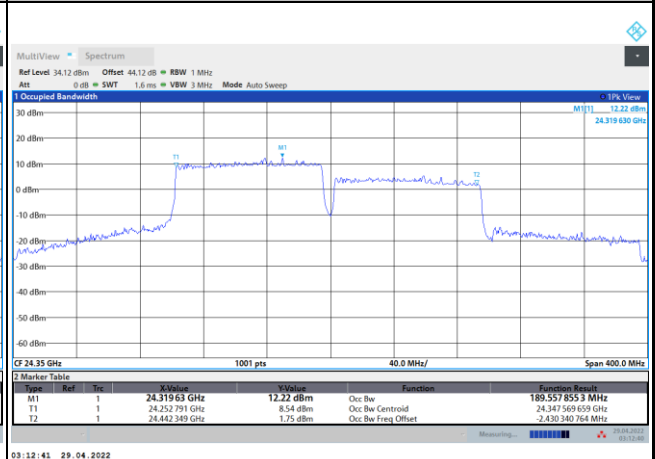

Middle Channel / 200MHz / 64QAM

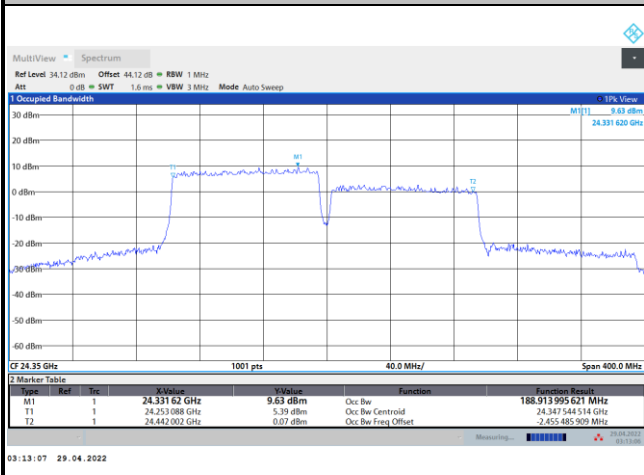

intentionally blank



CP-OFDM Module A

NR Band n258A

Lowest Channel / 50MHz / QPSK

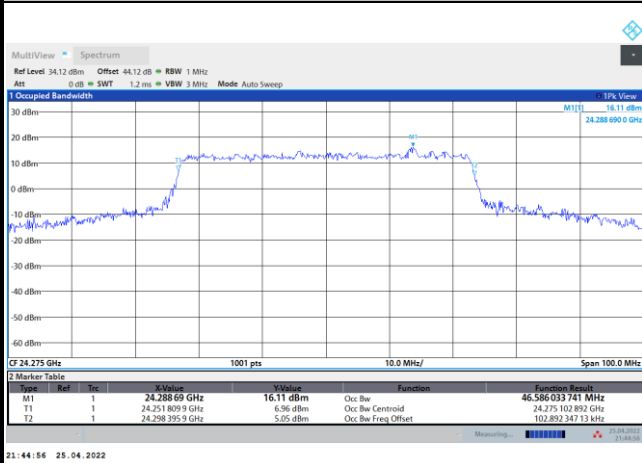

Lowest Channel / 100MHz / QPSK

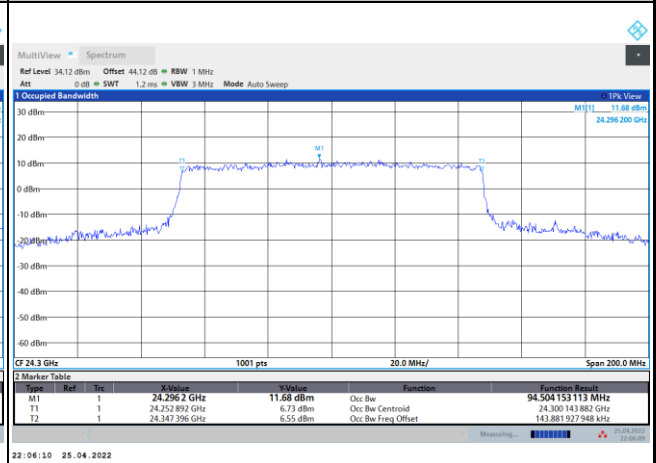

Middle Channel / 50MHz / QPSK

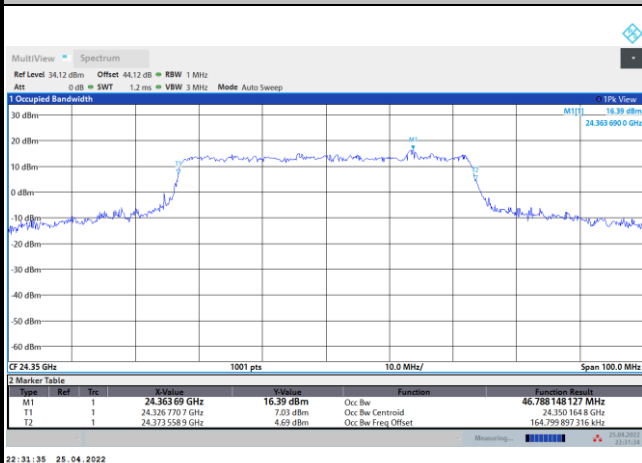

Middle Channel / 100MHz / QPSK

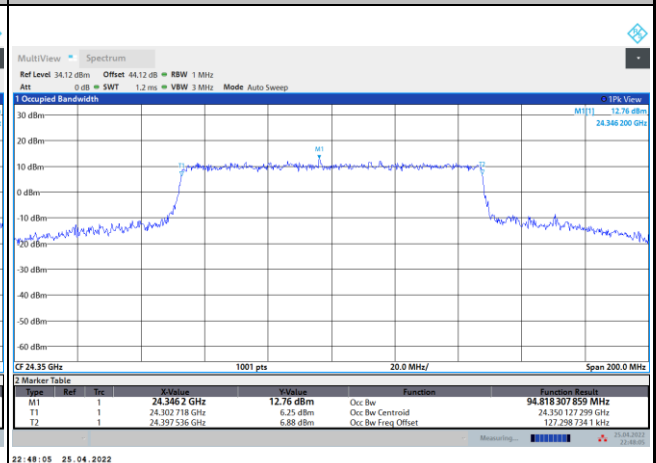

Highest Channel / 50MHz / QPSK

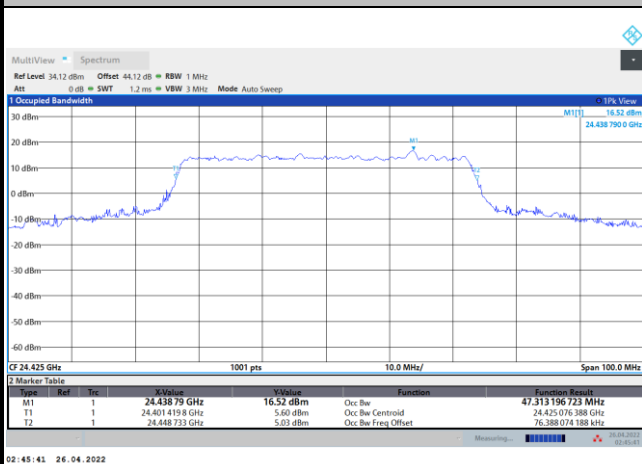

Highest Channel / 100MHz / QPSK

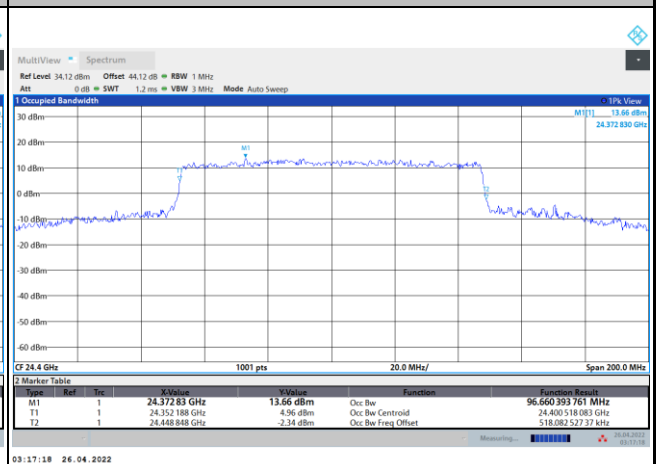



CP-OFDM Module A

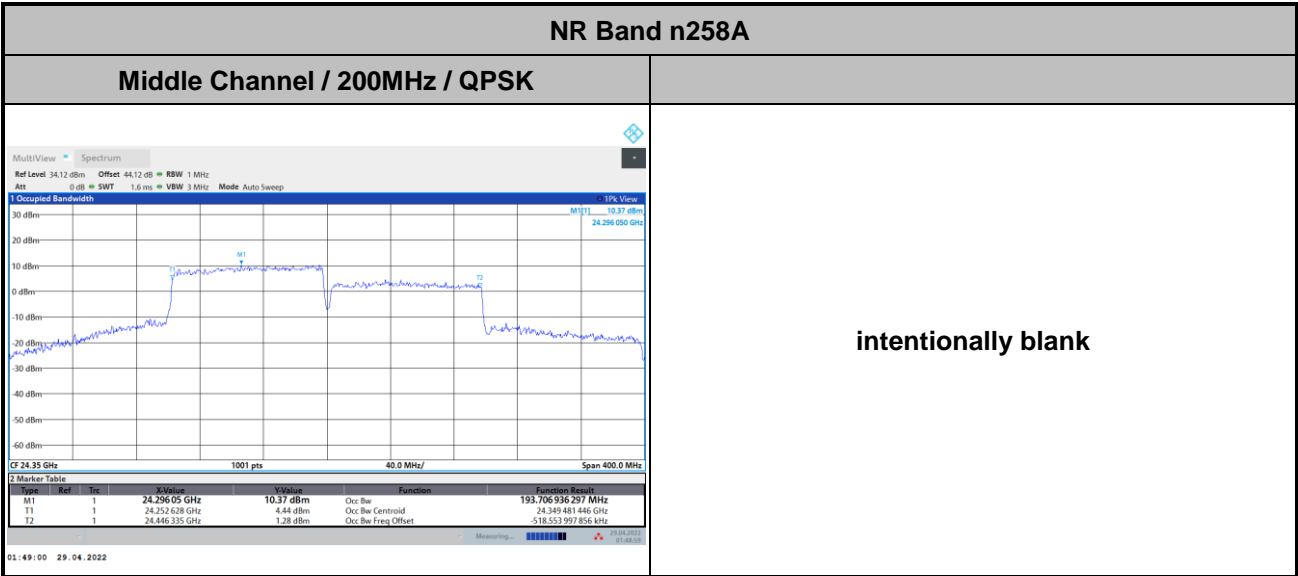

Radiated Out of Band Emissions

Mode			DFT-s-OFDM Module A NR Band n258A : BE (dBm) 1 RB								
BW			50MHz			100MHz			200MHz		
Limit (dBm)			QPSK	16QAM	64QAM	QPSK	16QAM	64QAM	QPSK	16QAM	64QAM
Low CH	0~10%OB	≤-5	-6.91	-8.07	-11.79	-14.78	-11.67	-16.58	-	-	-
	>10%OB	≤-13	-33.63	-34.89	-39.41	-41.59	-42.02	-43.01	-	-	-
Mid CH	0~10%OB	≤-5	-	-	-	-	-	-	-16.01	-13.69	-18.37
	>10%OB	≤-13	-	-	-	-	-	-	-15.01	-15.31	-22.02
High CH	0~10%OB	≤-5	-7.31	-8.18	-11.60	-9.26	-12.18	-16.57	-	-	-
	>10%OB	≤-13	-34.33	-36.95	-38.96	-40.52	-41.28	-42.92	-	-	-
Result			Compliance								

Mode			CP-OFDM Module A NR Band n258A : BE (dBm) 1 RB		
BW			50MHz	100MHz	200MHz
Limit (dBm)			QPSK	QPSK	QPSK
Low CH	0~10%OB	≤-5	-9.06	-15.06	-
	>10%OB	≤-13	-35.10	-42.02	-
Mid CH	0~10%OB	≤-5	-	-	-15.85
	>10%OB	≤-13	-	-	-15.47
High CH	0~10%OB	≤-5	-8.82	-12.71	-
	>10%OB	≤-13	-37.15	-41.05	-
Result			Compliance		



Mode			DFT-s-OFDM Module A NR Band n258A : BE (dBm) Full RB								
BW			50MHz			100MHz			200MHz		
Limit (dBm)			QPSK	16QAM	64QAM	QPSK	16QAM	64QAM	QPSK	16QAM	64QAM
Low CH	0~10%OB	≤-5	-13.22	-17.26	-21.60	-20.59	-23.09	-26.14	-	-	-
	>10%OB	≤-13	-16.15	-19.85	-28.74	-25.13	-27.31	-33.89	-	-	-
Mid CH	0~10%OB	≤-5	-	-	-	-	-	-	-21.14	-23.10	-27.91
	>10%OB	≤-13	-	-	-	-	-	-	-25.11	-25.29	-32.39
High CH	0~10%OB	≤-5	-14.04	-17.08	-20.47	-17.76	-21.36	-29.34	-	-	-
	>10%OB	≤-13	-15.25	-20.04	-28.85	-18.87	-22.95	-31.45	-	-	-
Result			Compliance								

Mode			CP-OFDM Module A NR Band n258A : BE (dBm) Full RB		
BW			50MHz	100MHz	200MHz
Limit (dBm)			QPSK	QPSK	QPSK
Low CH	0~10%OB	≤-5	-15.91	-21.91	-
	>10%OB	≤-13	-17.67	-25.23	-
Mid CH	0~10%OB	≤-5	-	-	-20.77
	>10%OB	≤-13	-	-	-23.53
High CH	0~10%OB	≤-5	-14.94	-14.69	-
	>10%OB	≤-13	-17.50	-16.38	-
Result			Compliance		



DFT-s-OFDM Module A

NR Band n258A/ 50MHz / QPSK

Lowest Band Edge / 1 RB

Highest Band Edge / 1 RB

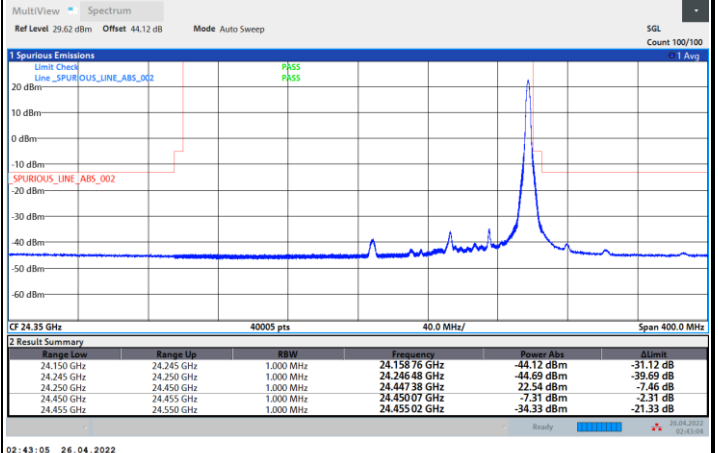
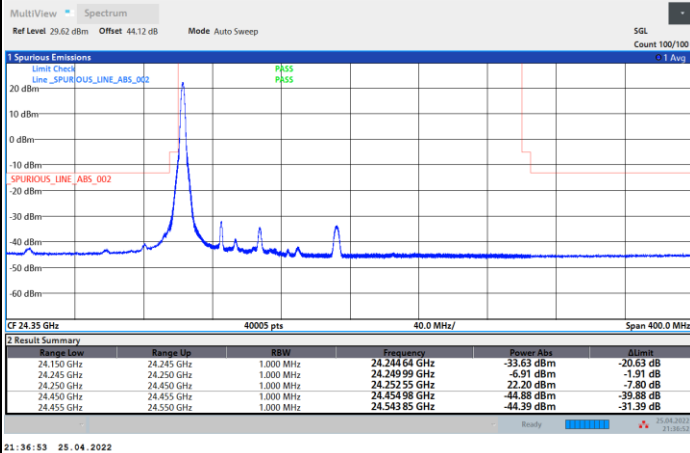

NR Band n258A/ 50MHz / 16QAM

Lowest Band Edge / 1 RB

Highest Band Edge / 1 RB

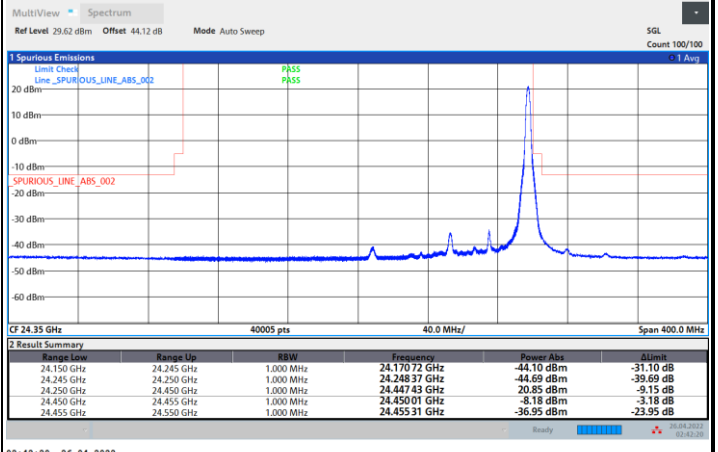
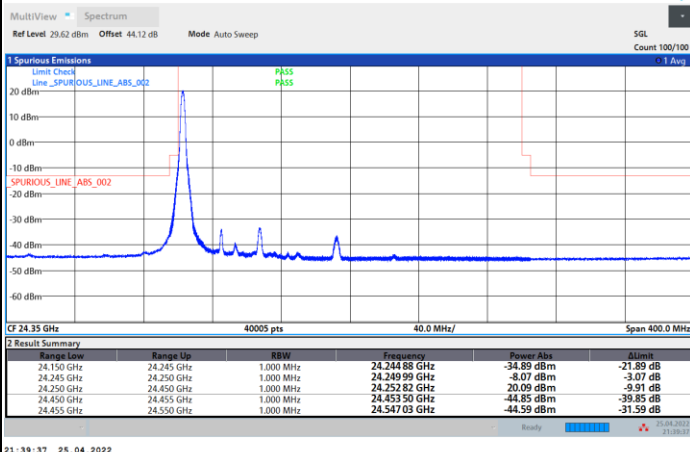



DFT-s-OFDM Module A

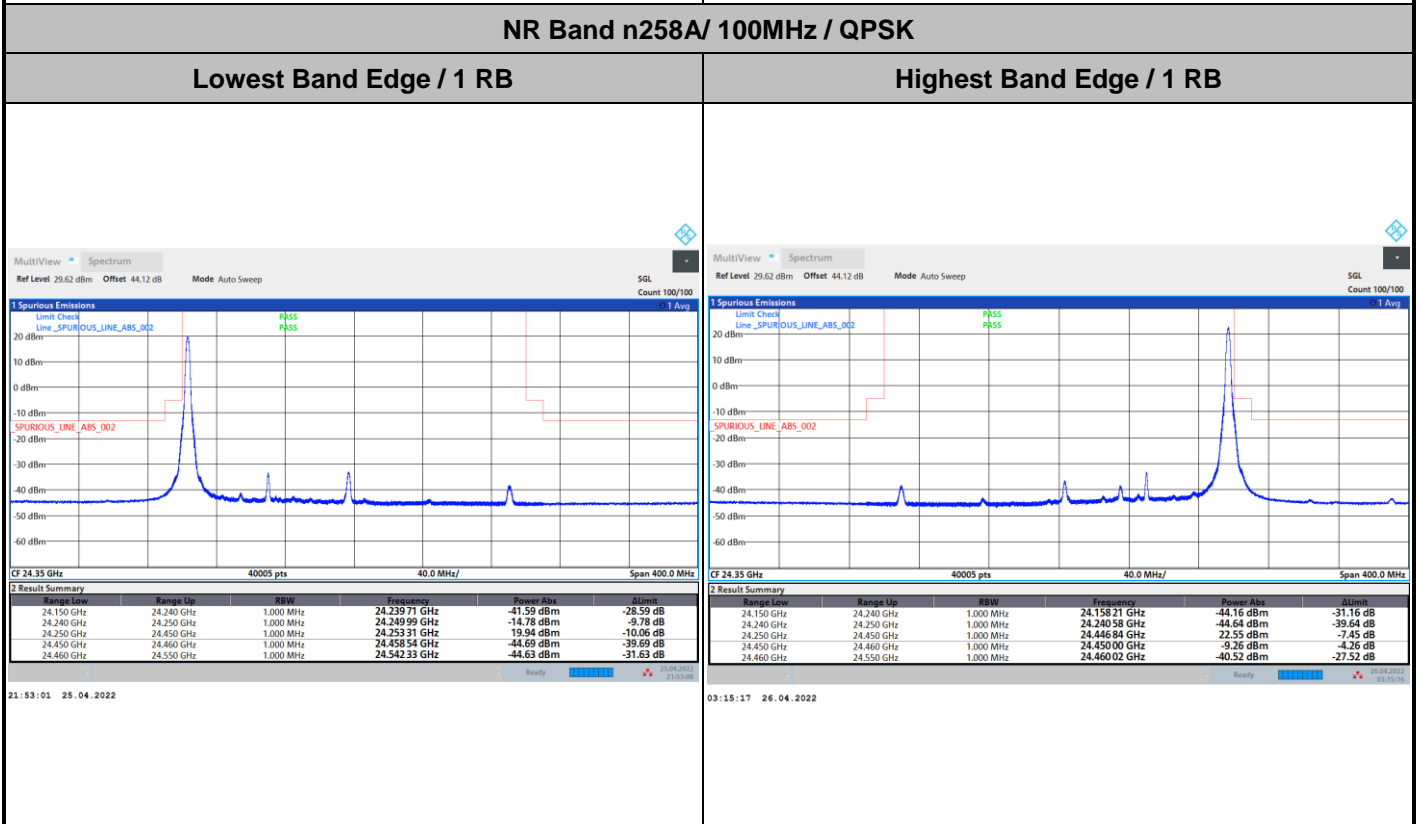
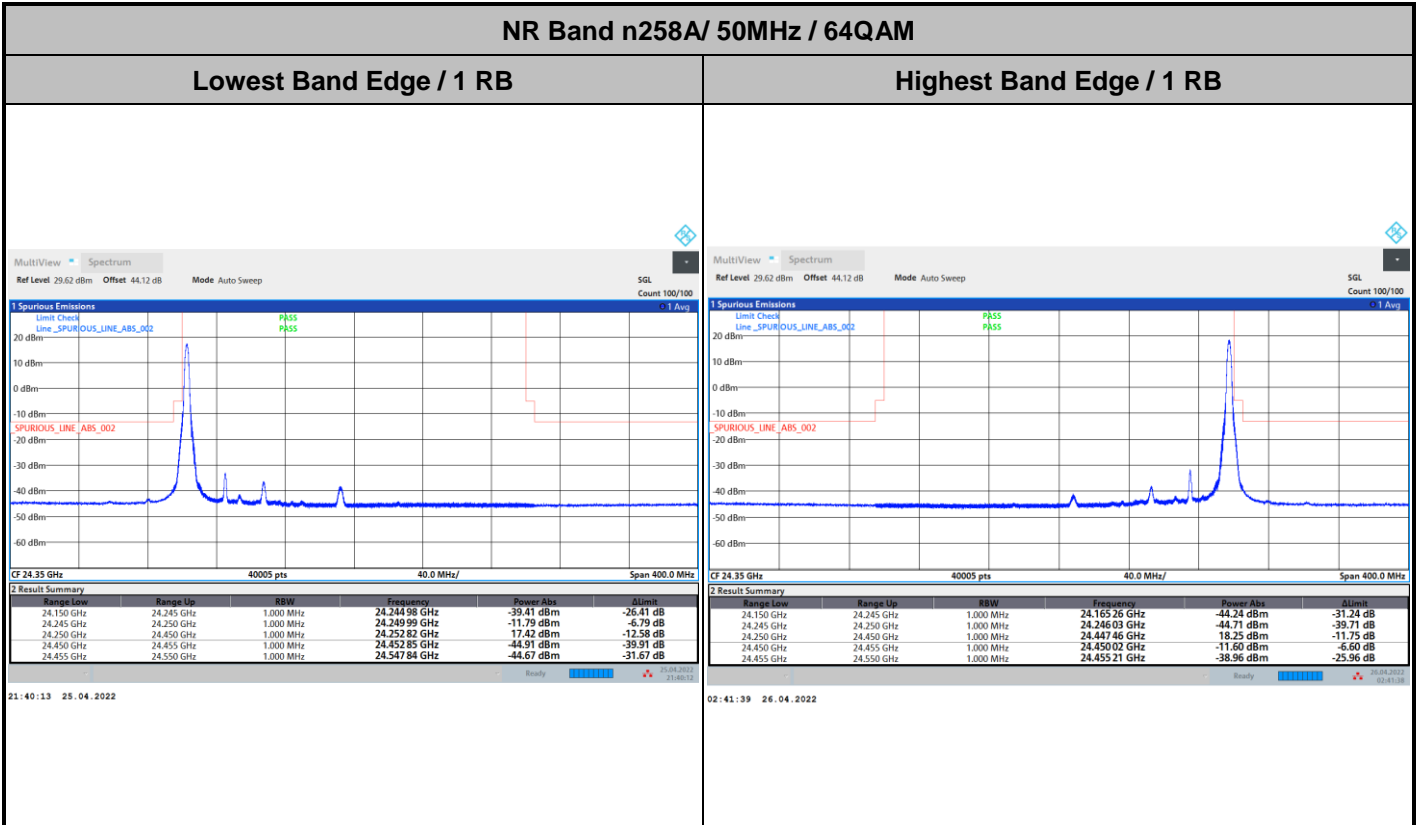



DFT-s-OFDM Module A

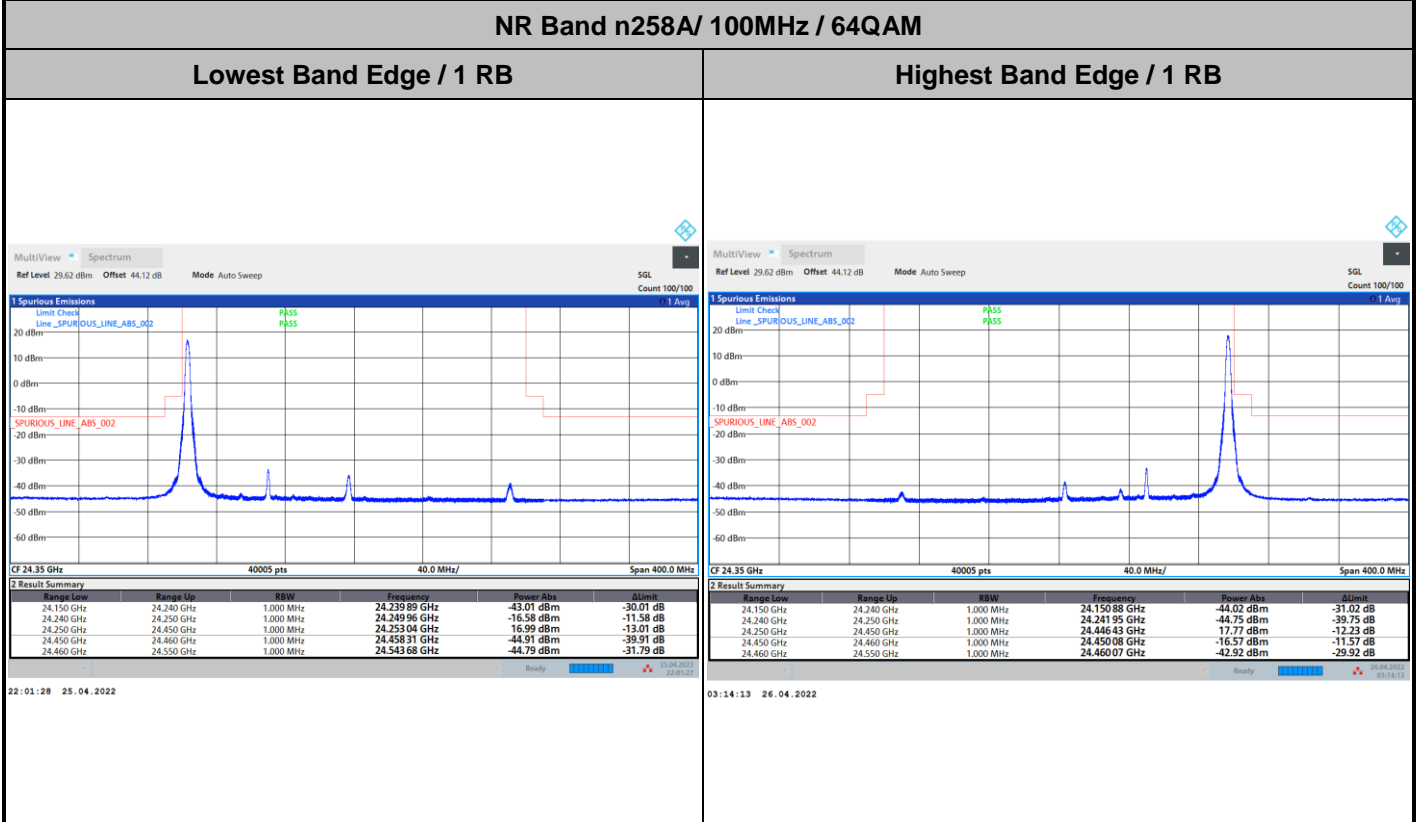
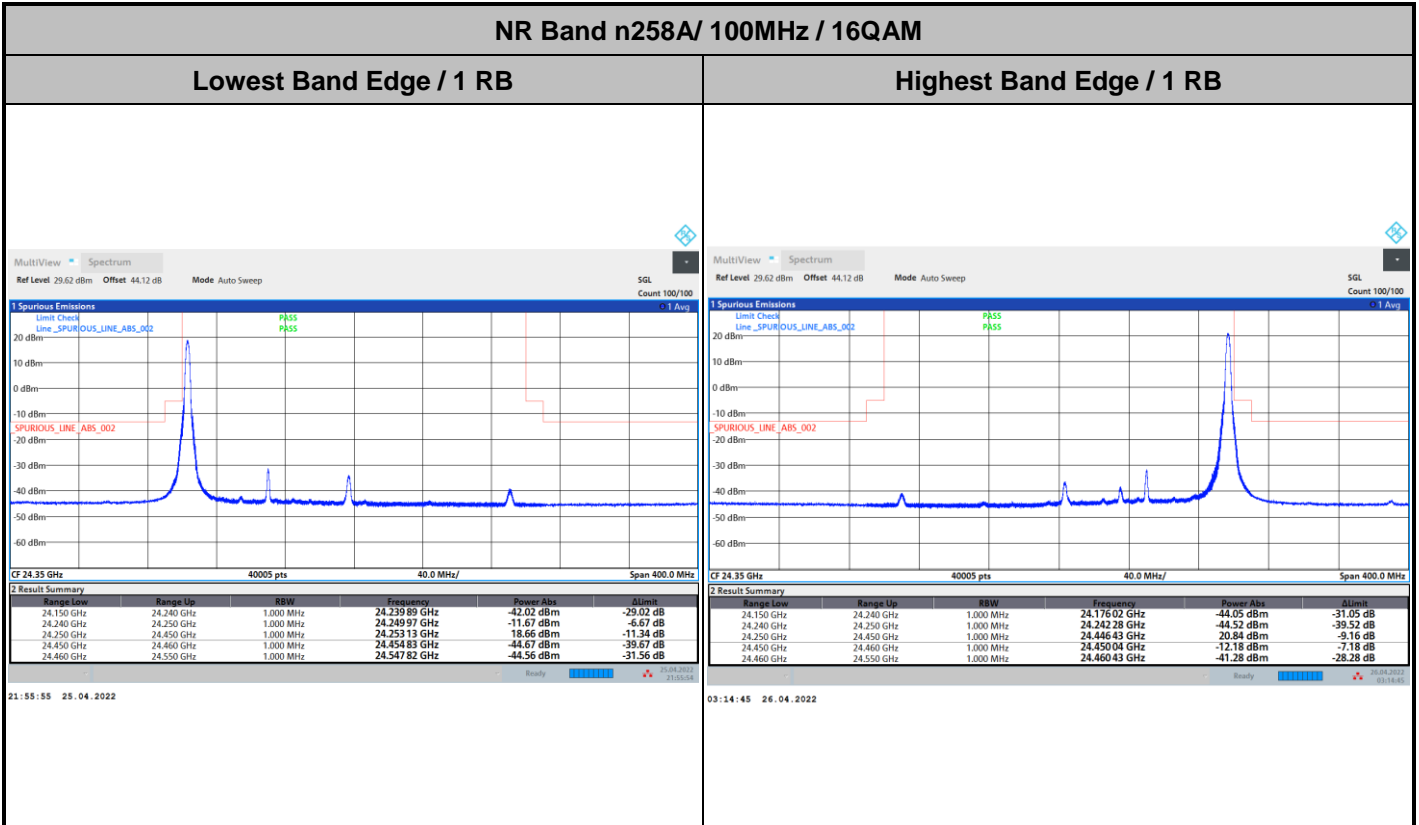



DFT-s-OFDM Module A

NR Band n258A/ 200MHz / QPSK

Middle Band Edge / 1 RB

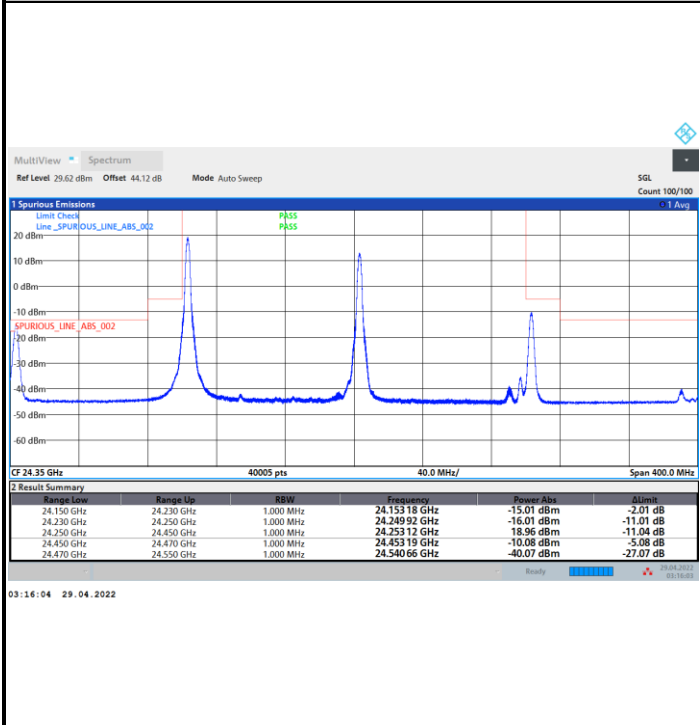

intentionally blank

NR Band n258A/ 200MHz / 16QAM

Middle Band Edge / 1 RB

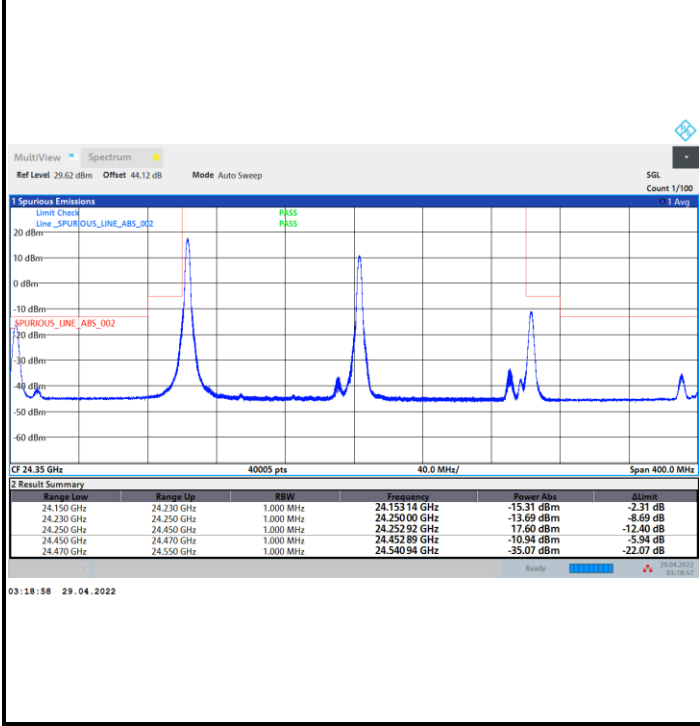

intentionally blank



DFT-s-OFDM Module A

NR Band n258A/ 200MHz / 64QAM

Middle Band Edge / 1 RB

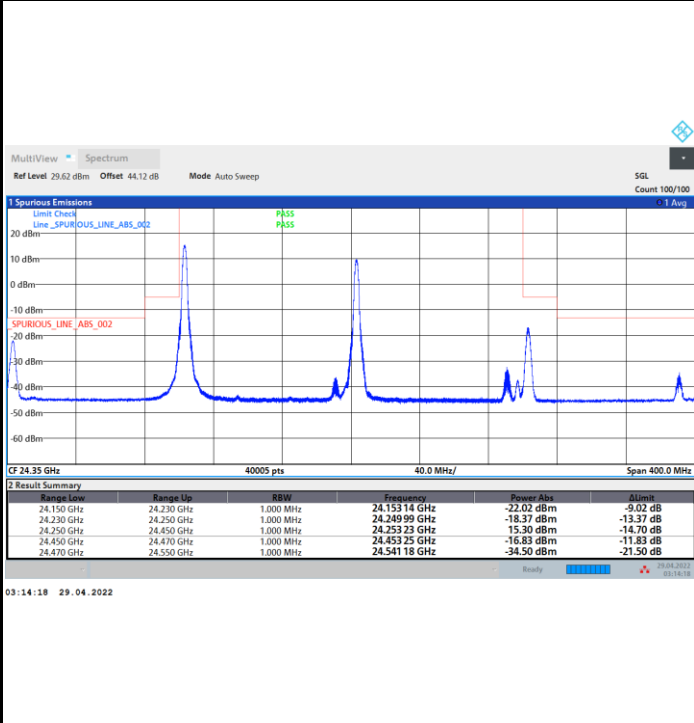

intentionally blank