



# FCC RADIO TEST REPORT

FCC ID : A4RGD2WG  
Equipment : Wireless Device  
Model Name : GD2WG  
Applicant : Google LLC  
1600 Amphitheatre Parkway,  
Mountain View, California, 94043 USA  
Standard : FCC 47 CFR Part 2, 22(H), 24(E), 27(L)

The product was received on Mar. 07, 2023 and testing was performed from Mar. 27, 2023 to Apr. 11, 2023. We, Sporton International Inc. EMC & Wireless Communications Laboratory, would like to declare that the tested sample has been evaluated in accordance with the test procedures given in ANSI / TIA-603-E and has been in compliance with the applicable technical standards.

The test results in this report apply exclusively to the tested model / sample. Without written approval from Sporton International Inc. EMC & Wireless Communications Laboratory, the test report shall not be reproduced except in full.

*Louis Wu*

Approved by: Louis Wu

**Sporton International Inc. EMC & Wireless Communications Laboratory**

No. 52, Huaya 1st Rd., Guishan Dist., Taoyuan City 333, Taiwan (R.O.C.)



# Table of Contents

**History of this test report.....3**

**Summary of Test Result.....4**

**1 General Description .....5**

    1.1 Product Feature of Equipment Under Test .....5

    1.2 Product Specification of Equipment Under Test .....5

    1.3 Modification of EUT .....6

    1.4 Testing Location .....6

    1.5 Applicable Standards .....7

**2 Test Configuration of Equipment Under Test .....8**

    2.1 Test Mode.....8

    2.2 Connection Diagram of Test System .....9

    2.3 Support Unit used in test configuration .....9

    2.4 Measurement Results Explanation Example .....9

    2.5 Frequency List of Low/Middle/High Channels .....10

**3 Conducted Test Result .....11**

    3.1 Measuring Instruments.....11

    3.2 Conducted Output Power and ERP/EIRP .....12

    3.3 Peak-to-Average Ratio .....13

    3.4 99% Occupied Bandwidth and 26dB Bandwidth Measurement.....14

    3.5 Conducted Band Edge .....15

    3.6 Conducted Spurious Emission .....16

    3.7 Frequency Stability.....17

**4 Radiated Test Items .....18**

    4.1 Measuring Instruments.....18

    4.2 Test Setup .....18

    4.3 Test Result of Radiated Test.....19

    4.4 Field Strength of Spurious Radiation Measurement .....20

**5 List of Measuring Equipment.....21**

**6 Measurement Uncertainty .....23**

**Appendix A. Test Results of Conducted Test**

**Appendix B. Test Results of Radiated Test**

**Appendix C. Test Setup Photographs**



### History of this test report

Report No.	Version	Description	Issue Date
FG330714A	01	Initial issue of report	Jun. 26, 2023
FG330714A	02	Revise Test Mode and Support Unit used in test configuration This report is an updated version, replacing the report issued on Jun. 26, 2023.	Jul. 06, 2023
FG330714A	03	Revise Test Mode This report is an updated version, replacing the report issued on Jul. 06, 2023.	Jul. 14, 2023



## Summary of Test Result

Report Clause	Ref Std. Clause	Test Items	Result (PASS/FAIL)	Remark
3.2	§2.1046	Conducted Output Power	Pass	-
	§22.913 (a)(5)	Effective Radiated Power (WCDMA Band V)		
	§24.232 (c)	Equivalent Isotropic Radiated Power (WCDMA Band II)		
	§27.50 (d)(4)	Equivalent Isotropic Radiated Power (WCDMA Band IV)		
3.3	§24.232 (d)	Peak-to-Average Ratio	Pass	-
3.4	§2.1049 §22.917 (b) §24.238 (b) §27.53 (g)	Occupied Bandwidth (WCDMA Band V) (WCDMA Band II) (WCDMA Band IV)	Pass	-
3.5	§2.1051 §22.917 (a) §24.238 (a) §27.53 (g)	Band Edge Measurement (WCDMA Band V) (WCDMA Band II) (WCDMA Band IV)	Pass	-
3.6	§2.1051 §22.917 (a) §24.238 (a) §27.53 (g)	Conducted Emission (WCDMA Band V) (WCDMA Band II) (WCDMA Band IV)	Pass	-
3.7	§2.1055 §22.355 §24.235 §27.54	Frequency Stability Temperature & Voltage	Pass	-
4.4	§2.1053 §22.917 (a) §24.238 (a) §27.53 (h)	Field Strength of Spurious Radiation (WCDMA Band V) (WCDMA Band II) (WCDMA Band IV)	Pass	29.01 dB under the limit at 7409.00 MHz

**Conformity Assessment Condition:**

1. The test results (PASS/FAIL) with all measurement uncertainty excluded are presented against the regulation limits or in accordance with the requirements stipulated by the applicant/manufacturer who shall bear all the risks of non-compliance that may potentially occur if measurement uncertainty is taken into account.
2. The measurement uncertainty please refer to each test result in the section "Measurement Uncertainty".

**Disclaimer:**

The product specifications of the EUT presented in the test report that may affect the test assessments are declared by the manufacturer who shall take full responsibility for the authenticity.

Reviewed by: Yun Huang

Report Producer: Rachel Hsieh



# 1 General Description

## 1.1 Product Feature of Equipment Under Test

Product Feature	
Equipment	Wireless Device
Model Name	GD2WG
FCC ID	A4RGD2WG
EUT supports Radios application	WCDMA/HSPA/LTE WLAN 11b/g/n HT20 Bluetooth BR/EDR/LE

Remark: The above EUT's information was declared by manufacturer.

EUT Information List	
S/N	Performed Test Item
232640500000004	Conducted Measurement ERP/EIRP
32251RUJWN06C7	Radiated Spurious Emission

## 1.2 Product Specification of Equipment Under Test

Product Specification is subject to this standard	
Tx Frequency	<b>WCDMA:</b> Band V: 826.4 MHz ~ 846.6 MHz Band II: 1852.4 MHz ~ 1907.6 MHz Band IV: 1712.4 MHz ~ 1752.6 MHz
Rx Frequency	<b>WCDMA:</b> Band V: 871.4 MHz ~ 891.6 MHz Band II: 1932.4 MHz ~ 1987.6 MHz Band IV: 2112.4 MHz ~ 2152.6 MHz
Maximum Output Power to Antenna	<b>WCDMA:</b> Band V: 23.33 dBm Band II: 22.81 dBm Band IV: 22.60 dBm
Antenna Type	<Ant. 0>: PIFA Antenna type <Ant. 1>: Monopole Antenna type
Type of Modulation	WCDMA: QPSK (Uplink) HSDPA: 64QAM (Downlink) HSUPA: QPSK (Uplink)

Radio Tech	Band Number	Antenna name	Gain
WCDMA	B2	Ant 0	-7.0
WCDMA	B4	Ant 0	-6.1
WCDMA	B5	Ant 1	-10.7

Remark: The EUT's information above is declared by manufacturer. Please refer to Disclaimer in report summary.



### 1.3 Modification of EUT

No modifications made to the EUT during the testing.

### 1.4 Testing Location

<b>Test Site</b>	Sporton International Inc. EMC & Wireless Communications Laboratory
<b>Test Site Location</b>	No.52, Huaya 1st Rd., Guishan Dist., Taoyuan City 333, Taiwan (R.O.C.) TEL: +886-3-327-3456 FAX: +886-3-328-4978
<b>Test Site No.</b>	<b>Sporton Site No.</b>
	TH03-HY
<b>Test Engineer</b>	Eric Wu
<b>Temperature (°C)</b>	21.2~23.2
<b>Relative Humidity (%)</b>	45.7~47.7

<b>Test Site</b>	Sporton International Inc. Wensan Laboratory
<b>Test Site Location</b>	No.58, Aly. 75, Ln. 564, Wenhua 3rd, Rd., Guishan Dist., Taoyuan City 333010, Taiwan (R.O.C.) TEL: +886-3-327-0868 FAX: +886-3-327-0855
<b>Test Site No.</b>	<b>Sporton Site No.</b>
	03CH12-HY (TAF Code: 3786)
<b>Test Engineer</b>	Jesse Fan, Tim Lee and Wilson Wu
<b>Temperature (°C)</b>	20~25
<b>Relative Humidity (%)</b>	50~60
<b>Remark</b>	The Radiated Emission test item subcontracted to Sporton International Inc. Wensan Laboratory.

**Note:** The test site complies with ANSI C63.4 2014 requirement.

FCC Designation No.: TW1190 and TW3786



## **1.5 Applicable Standards**

According to the specifications declared by the manufacturer, the EUT must comply with the requirements of the following standards:

- ♦ ANSI C63.26-2015
- ♦ ANSI / TIA-603-E
- ♦ FCC 47 CFR Part 2, 22(H), 24(E), 27(L)
- ♦ FCC KDB 971168 D01 Power Meas. License Digital Systems v03r01
- ♦ FCC KDB 412172 D01 Determining ERP and EIRP v01r01
- ♦ FCC KDB 414788 D01 Radiated Test Site v01r01

**Remark:**

1. All the test items were validated and recorded in accordance with the standards without any modification during the testing.
2. This EUT has also been tested and complied with the requirements of FCC Part 15, Subpart B, recorded in a separate test report.
3. The TAF code is not including all the FCC KDB listed without accreditation.



## 2 Test Configuration of Equipment Under Test

### 2.1 Test Mode

Antenna port conducted and radiated test items were performed according to KDB 971168 D01 Power Meas. License Digital Systems v03r01 with maximum output power.

For radiated measurement, the measured emission level of the EUT was maximized by rotating the EUT on a turntable, adjusting the orientation of the EUT and EUT antenna in three orthogonal axis (X: flat, Y: portrait, Z: landscape), and adjusting the measurement antenna orientation, following C63.26 exploratory test procedures and find Y Plane with Adapter for PCS Band and AWS Band, Z Plane with Adapter for Cellular Band as worst plane.

Radiated emissions were investigated as following frequency range:

1. 30 MHz to 9000 MHz for WCDMA Band V
2. 30 MHz to 18000 MHz for WCDMA Band IV
3. 30 MHz to 19100 MHz for WCDMA Band II

All modes, data rates and positions were investigated.

Test modes are chosen to be reported as the worst case configuration below:

Test Modes		
Band	Radiated TCs	Conducted TCs
WCDMA Band V	■ RMC 12.2Kbps Link	■ RMC 12.2Kbps Link
WCDMA Band II	■ RMC 12.2Kbps Link	■ RMC 12.2Kbps Link
WCDMA Band IV	■ RMC 12.2Kbps Link	■ RMC 12.2Kbps Link

**Remark:** Simultaneous transmission between WWAN and WIFI or Bluetooth have been investigated and no significant emission was observed.



## 2.2 Connection Diagram of Test System

<EUT with Adapter>

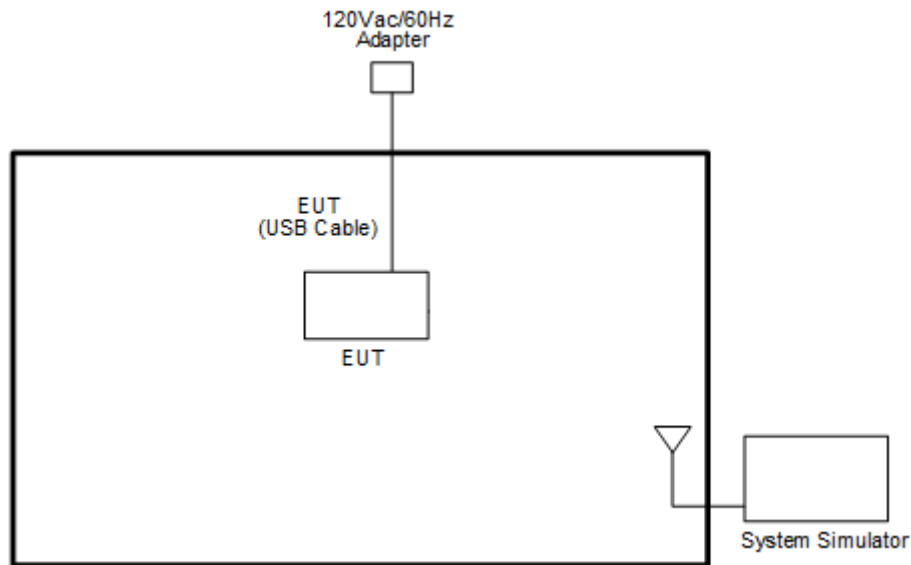

## 2.3 Support Unit used in test configuration

Item	Equipment	Brand Name	Model No.	FCC ID	Data Cable	Power Cord
1.	System Simulator	Anritsu	MT8821C	N/A	N/A	Unshielded, 1.8 m
2.	Adapter	Google	G1000	N/A	N/A	N/A
3.	USB Cable	Google	GQ6H2	N/A	Unshielded, 0.98 m	N/A

## 2.4 Measurement Results Explanation Example

**For all conducted test items:**

The offset level is set in the spectrum analyzer to compensate the RF cable loss and attenuator factor between RF conducted output port and spectrum analyzer. With the offset compensation, the spectrum analyzer reading level will be exactly the RF output level.

The spectrum analyzer offset is derived from RF cable loss and attenuator factor.

Offset = RF cable loss + attenuator factor.

The following shows an offset computation example with RF cable loss 4.2 dB and a 10 dB attenuator.

Example:

$$\begin{aligned} \text{Offset(dB)} &= \text{RF cable loss(dB)} + \text{attenuator factor(dB)} \\ &= 4.2 + 10 = 14.2 \text{ (dB)} \end{aligned}$$



## 2.5 Frequency List of Low/Middle/High Channels

Frequency List				
Band	Channel/Frequency(MHz)	Lowest	Middle	Highest
WCDMA Band V	Channel	4132	4182	4233
	Frequency	826.4	836.4	846.6
WCDMA Band II	Channel	9262	9400	9538
	Frequency	1852.4	1880.0	1907.6
WCDMA Band IV	Channel	1312	1413	1513
	Frequency	1712.4	1732.6	1752.6

### 3 Conducted Test Result

#### 3.1 Measuring Instruments

Please refer to the measuring equipment list in this test report.

##### 3.1.1 Test Setup

##### 3.1.2 Conducted Output Power

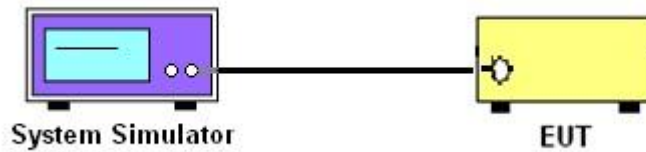

##### 3.1.3 Peak-to-Average Ratio, Occupied Bandwidth, Conducted Band-Edge and Conducted Spurious Emission

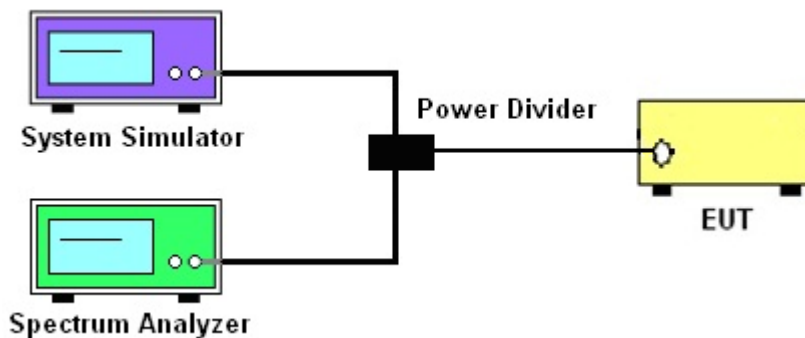

##### 3.1.4 Frequency Stability

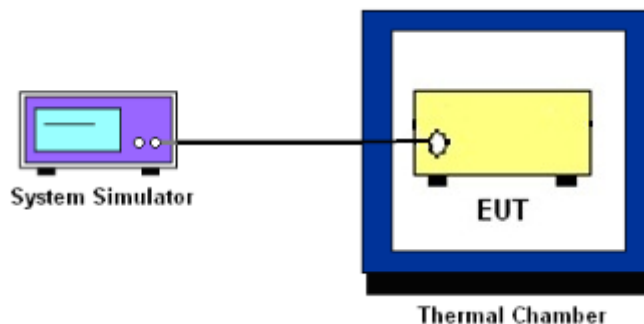

##### 3.1.5 Test Result of Conducted Test

Please refer to Appendix A.



## 3.2 Conducted Output Power and ERP/EIRP

### 3.2.1 Description of the Conducted Output Power and ERP/EIRP

A system simulator was used to establish communication with the EUT. Its parameters were set to enforce EUT transmitting at the maximum power. The measured power in the radio frequency on the transmitter output terminals shall be reported.

The ERP of mobile transmitters must not exceed 7 Watts for WCDMA Band V

The EIRP of mobile transmitters must not exceed 2 Watts for WCDMA Band II

The EIRP of mobile transmitters must not exceed 1 Watts for WCDMA Band IV

According to KDB 412172 D01 Power Approach,

$EIRP = P_T + G_T - L_C$ ,  $ERP = EIRP - 2.15$ , where

$P_T$  = transmitter output power in dBm

$G_T$  = gain of the transmitting antenna in dBi

$L_C$  = signal attenuation in the connecting cable between the transmitter and antenna in dB

### 3.2.2 Test Procedures

1. The transmitter output port is connected to the system simulator.
2. Set EUT at maximum power through system simulator.
3. Select the lowest, middle, and the highest channels for each band and different modulation.
4. Measure the maximum burst average power for GSM and maximum average power for other modulation signal.



### **3.3 Peak-to-Average Ratio**

#### **3.3.1 Description of the PAR Measurement**

The peak-to-average ratio (PAR) of the transmission may not exceed 13 dB.

#### **3.3.2 Test Procedures**

The testing follows ANSI C63.26-2015 Section 5.2.6

1. The EUT is connected to spectrum analyzer and system simulator via a power divider.
2. Set EUT to transmit at maximum output power.
3. When the duty cycle is less than 98%, then signal gating will be implemented on the spectrum analyzer by triggering from the system simulator.
4. Set the CCDF (Complementary Cumulative Distribution Function) option of the spectrum analyzer.
5. Record the maximum PAPR level associated with a probability of 0.1%.



### 3.4 99% Occupied Bandwidth and 26dB Bandwidth Measurement

#### 3.4.1 Description of 99% Occupied Bandwidth and 26dB Bandwidth Measurement

The occupied bandwidth is the width of a frequency band such that, below the lower and above the upper frequency limits, the mean powers emitted are each equal to a specified percentage 0.5% of the total mean transmitted power.

The 26 dB emission bandwidth is defined as the frequency range between two points, one above and one below the carrier frequency, at which the spectral density of the emission is attenuated 26 dB below the maximum in-band spectral density of the modulated signal. Spectral density (power per unit bandwidth) is to be measured with a detector of resolution bandwidth equal to approximately 1.0% of the emission bandwidth.

#### 3.4.2 Test Procedures

The testing follows ANSI C63.26-2015 Section 5.4.3 (26dB) and Section 5.4.4 (99OB)

1. The EUT is connected to spectrum analyzer and system simulator via a power divider.
2. The spectrum analyzer center frequency is set to the nominal EUT channel center frequency. The span range for the spectrum analyzer shall be between two and five times the anticipated OBW.
3. The nominal resolution bandwidth (RBW) shall be in the range of 1 to 5 % of the anticipated OBW, and the VBW shall be at least 3 times the RBW.
4. Set the detection mode to peak, and the trace mode to max hold.
5. Determine the reference value: Set the EUT to transmit a modulated signal. Allow the trace to stabilize. Set the spectrum analyzer marker to the highest level of the displayed trace.  
(This is the reference value)
6. Determine the “-26 dB down amplitude” as equal to (Reference Value – X).
7. Place two markers, one at the lowest and the other at the highest frequency of the envelope of the spectral display such that each marker is at or slightly below the “-X dB down amplitude” determined in step 6. If a marker is below this “-X dB down amplitude” value it shall be placed as close as possible to this value. The OBW is the positive frequency difference between the two markers.
8. Use the 99 % power bandwidth function of the spectrum analyzer and report the measured bandwidth.



## **3.5 Conducted Band Edge**

### **3.5.1 Description of Conducted Band Edge Measurement**

The power of any emission outside of the authorized operating frequency ranges must be lower than the transmitter power (P) by a factor of at least  $43 + 10 \log (P)$  dB.

### **3.5.2 Test Procedures**

The testing follows FCC KDB 971168 D01 v03r01 Section 6.1.

1. The EUT is connected to the spectrum analyzer and system simulator via a power divider.
2. The RF output of EUT is connected to the spectrum analyzer by an RF cable and attenuator. The path loss is compensated to the results for each measurement.
3. The band edges of low and high channels for the highest RF powers are measured.
4. The RF fundamental frequency shall be excluded against the limit line in the operating frequency band.
5. The limit line is derived from  $43 + 10\log(P)$  dB below the transmitter power P(Watts)



## **3.6 Conducted Spurious Emission**

### **3.6.1 Description of Conducted Spurious Emission Measurement**

The power of any emission outside of the authorized operating frequency ranges must be lower than the transmitter power (P) by a factor of at least  $43 + 10 \log (P)$  dB.

It is measured by means of a calibrated spectrum analyzer and scanned from 30 MHz up to a frequency including its 10<sup>th</sup> harmonic.

### **3.6.2 Test Procedures**

The testing follows FCC KDB 971168 D01 v03r01 Section 6.1.

1. The EUT is connected to the spectrum analyzer and system simulator via a power divider.
2. The RF output of EUT is connected to the spectrum analyzer by an RF cable and attenuator. The path loss is compensated to the results for each measurement.
3. The middle channel for the highest RF power within the transmitting frequency is measured.
4. The conducted spurious emission for the whole frequency range is taken.
5. The RF fundamental frequency shall be excluded against the limit line in the operating frequency band.
6. The limit line is derived from  $43 + 10\log(P)$  dB below the transmitter power P(Watts)





### 3.7 Frequency Stability

#### 3.7.1 Description of Frequency Stability Measurement

22.355

The frequency stability shall be measured by variation of ambient temperature and variation of primary supply voltage to ensure that the fundamental emission stays within the authorized frequency block. The frequency stability of the transmitter shall be maintained within  $\pm 0.00025\%$  ( $\pm 2.5\text{ppm}$ ) of the center frequency.

24.235 & 27.54

The frequency stability shall be sufficient to ensure that the fundamental emission stays within the authorized frequency block.

#### 3.7.2 Test Procedures for Temperature Variation

The testing follows FCC KDB 971168 D01 v03r01 Section 9.0.

1. The EUT is set up in the thermal chamber and connected with the system simulator.
2. With power OFF, the temperature is decreased to  $-30^{\circ}\text{C}$  and the EUT is stabilized before testing. Power is applied and the maximum change in frequency is recorded within one minute.
3. With power OFF, the temperature is raised in  $10^{\circ}\text{C}$  steps up to  $50^{\circ}\text{C}$ . The EUT is stabilized at each step for at least half an hour. Power is applied and the maximum frequency change is recorded within one minute.

#### 3.7.3 Test Procedures for Voltage Variation

The testing follows FCC KDB 971168 D01 v03r01 Section 9.0.

1. The EUT is placed in a temperature chamber at  $20\pm 5^{\circ}\text{C}$  and connected with the system simulator.
2. The power supply voltage to the EUT is varied from 85% to 115% of the nominal value measured at the input to the EUT.
3. The variation in frequency is measured for the worst case.

## 4 Radiated Test Items

### 4.1 Measuring Instruments

Please refer to the measuring equipment list in this test report.

### 4.2 Test Setup

For radiated test below 30MHz

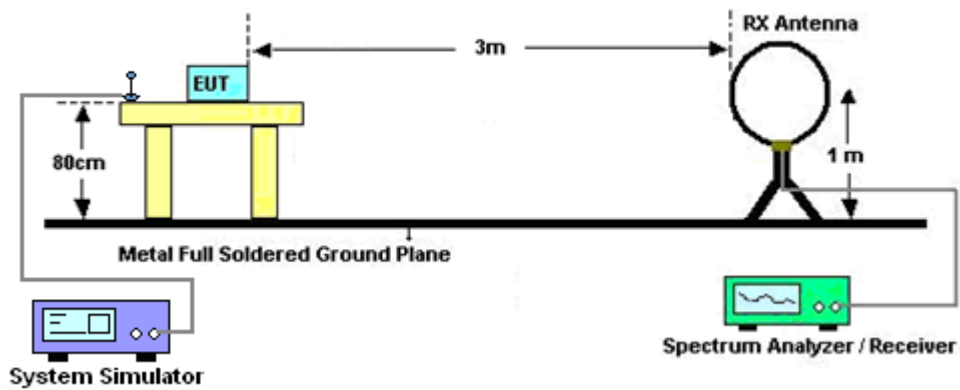

For radiated test from 30MHz to 1GHz

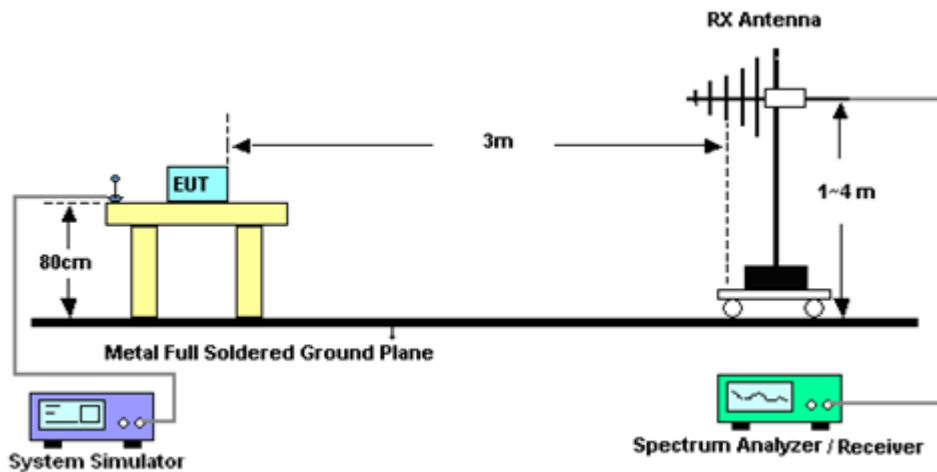

For radiated test above 1GHz

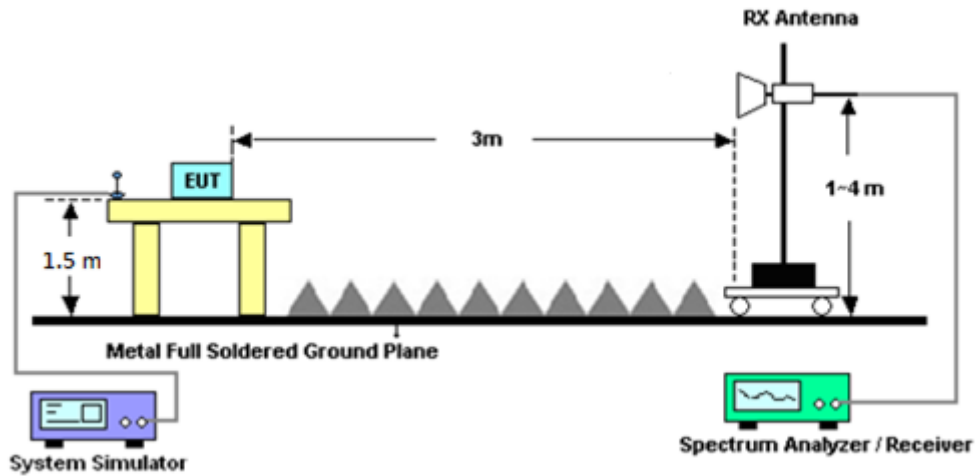

### 4.3 Test Result of Radiated Test

Please refer to Appendix B.

**Note:**

The low frequency, which starts from 9 kHz to 30 MHz, is pre-scanned and the result which is 20 dB lower than the limit line is not reported.

There is adequate comparison measurement of both open-field test site and alternative test site - semi-Anechoic chamber according to 414788 D01 Radiated Test Site v01r01, and the result came out very similar.



## 4.4 Field Strength of Spurious Radiation Measurement

### 4.4.1 Description of Field Strength of Spurious Radiated Measurement

The power of any emission outside of the authorized operating frequency ranges must be attenuated below the transmitter power (P) by a factor of at least  $43 + 10 \log (P)$  dB. The spectrum is scanned from 30 MHz up to a frequency including its 10th harmonic.

### 4.4.2 Test Procedures

The testing follows FCC KDB 971168 D01 v03r01 Section 7 and ANSI / TIA-603-E Section 2.2.12.

1. The EUT is placed on a rotatable wooden table 0.8 meters for frequency below 1 GHz and 1.5 meter for frequency above 1 GHz above the ground.
2. The EUT is set 3 meters away from the receiving antenna, which is mounted on the antenna tower.
3. The table is rotated 360 degrees to determine the position of the highest spurious emission.
4. The height of the receiving antenna is varied between one meter and four meters to search for the maximum spurious emission for both horizontal and vertical polarizations.
5. Make the measurement with the spectrum analyzer's RBW = 1 MHz, VBW = 3 MHz, taking record of maximum spurious emission.
6. A horn antenna is substituted in place of the EUT and is driven by a signal generator.
7. Tune the output power of signal generator to the same emission level with EUT maximum spurious emission.
8. Take the record of output power at antenna port.
9. Repeat step 7 to step 8 for another polarization.
10.  $EIRP (dBm) = S.G. Power - Tx Cable Loss + Tx Antenna Gain$
11.  $ERP (dBm) = EIRP - 2.15$
12. The RF fundamental frequency shall be excluded against the limit line in the operating frequency band.
13. The limit line is derived from  $43 + 10\log(P)$  dB below the transmitter power P(Watts)



## 5 List of Measuring Equipment

Instrument	Brand Name	Model No.	Serial No.	Characteristics	Calibration Date	Test Date	Due Date	Remark
Spectrum Analyzer	Rohde & Schwarz	FSP30	101329	9kHz~30GHz	Sep. 27, 2022	Mar. 27, 2023	Sep. 26, 2023	Conducted (TH03-HY)
Programmable Power Supply	GW Instek	PSS-2005	EL890001	1V~20V 0.5A~4A	Sep. 29, 2022	Mar. 27, 2023	Sep. 28, 2023	Conducted (TH03-HY)
Base Station (Measure)	Rohde & Schwarz	CMU200	117995	GSM / GPRS / WCDMA / CDMA	Aug. 02, 2022	Mar. 27, 2023	Aug. 01, 2023	Conducted (TH03-HY)
Thermal Chamber	ESPEC	SH-641	92013720	-40°C ~90°C	Sep. 07, 2022	Mar. 27, 2023	Sep. 06, 2023	Conducted (TH03-HY)
Hygrometer	TECEPEL	DTM-303A	TP201996	N/A	Nov. 17, 2022	Mar. 27, 2023	Nov. 16, 2023	Conducted (TH03-HY)
RF Cable	Woken	SS402_1M	#1	N/A	Oct. 27, 2022	Mar. 27, 2023	Oct. 26, 2023	Conducted (TH03-HY)
RF Cable	Woken	SS402_1M	#2	N/A	Oct. 27, 2022	Mar. 27, 2023	Oct. 26, 2023	Conducted (TH03-HY)
RF Cable	Woken	SS402_1M	#3	N/A	Oct. 27, 2022	Mar. 27, 2023	Oct. 26, 2023	Conducted (TH03-HY)
Power Divider	Warison	WCOU-0.4-26.5S-20	#A	N/A	Oct. 27, 2022	Mar. 27, 2023	Oct. 26, 2023	Conducted (TH03-HY)
Attenuator	Woken	10dB 18GHz_5W	#15	0.5~18GHz	Oct. 27, 2022	Mar. 27, 2023	Oct. 26, 2023	Conducted (TH03-HY)
Loop Antenna	Rohde & Schwarz	HFH2-Z2	100488	9 kHz~30 MHz	Sep. 20, 2022	Apr. 08, 2023~ Apr. 11, 2023	Sep. 19, 2023	Radiation (03CH12-HY)
Bilog Antenna	TESEQ	CBL 6111D & 00800N1D01N -06	37059 & 01	30MHz~1GHz	Nov. 10, 2022	Apr. 08, 2023~ Apr. 11, 2023	Nov. 09, 2023	Radiation (03CH12-HY)
Horn Antenna	SCHWARZBECK	BBHA 9120 D	9120D-02114	1GHz~18GHz	Aug. 09, 2022	Apr. 08, 2023~ Apr. 11, 2023	Aug. 08, 2023	Radiation (03CH12-HY)
SHF-EHF Horn Antenna	SCHWARZBECK	BBHA9170	00993	18GHz~40GHz	Nov. 24, 2022	Apr. 08, 2023~ Apr. 11, 2023	Nov. 23, 2023	Radiation (03CH12-HY)
Preamplifier	COM-POWER	PA-103A	161241	10MHz~1GHz	Oct. 03, 2022	Apr. 08, 2023~ Apr. 11, 2023	Oct. 02, 2023	Radiation (03CH12-HY)
Preamplifier	Agilent	8449B	3008A02375	1GHz~26.5GHz	May 24, 2022	Apr. 08, 2023~ Apr. 11, 2023	May 23, 2023	Radiation (03CH12-HY)
Preamplifier	E-INSTRUMENT TECH LTD.	ERA-100M-18 G-56-01-A70	EC1900249	1GHz~18GHz	Dec. 21, 2022	Apr. 08, 2023~ Apr. 11, 2023	Dec. 20, 2023	Radiation (03CH12-HY)
Preamplifier	EMEC	EM18G40G	060715	18GHz~40GHz	Dec. 07, 2022	Apr. 08, 2023~ Apr. 11, 2023	Dec. 06, 2023	Radiation (03CH12-HY)
Spectrum Analyzer	Agilent	N9010A	MY53470118	10Hz~44GHz	Jan. 10, 2023	Apr. 08, 2023~ Apr. 11, 2023	Jan. 09, 2024	Radiation (03CH12-HY)



Instrument	Brand Name	Model No.	Serial No.	Characteristics	Calibration Date	Test Date	Due Date	Remark
Filter	Wainwright	WHKX12-1080 -1200-15000-6 0SS	SN1	1.2GHz High Pass Filter	Mar. 14, 2023	Apr. 08, 2023~ Apr. 11, 2023	Mar. 13, 2024	Radiation (03CH12-HY)
Filter	Wainwright	WHKX12-2700 -3000-18000-6 0ST	SN2	3GHz High Pass Filter	Mar. 14, 2023	Apr. 08, 2023~ Apr. 11, 2023	Mar. 13, 2024	Radiation (03CH12-HY)
RF Cable	HUBER + SUHNER	SUCOFLEX 102	803951/2	9kHz~30MHz	Mar. 07, 2023	Apr. 08, 2023~ Apr. 11, 2023	Mar. 06, 2024	Radiation (03CH12-HY)
RF Cable	HUBER + SUHNER	SUCOFLEX 126E	0058/126E	30MHz~18GHz	Dec. 20, 2022	Apr. 08, 2023~ Apr. 11, 2023	Dec. 19, 2023	Radiation (03CH12-HY)
RF Cable	HUBER + SUHNER	SUCOFLEX 102	505134/2	30MHz~40GHz	Dec. 20, 2022	Apr. 08, 2023~ Apr. 11, 2023	Dec. 19, 2023	Radiation (03CH12-HY)
RF Cable	HUBER + SUHNER	SUCOFLEX 102	803953/2	30MHz~40GHz	Dec. 20, 2022	Apr. 08, 2023~ Apr. 11, 2023	Dec. 19, 2023	Radiation (03CH12-HY)
Hygrometer	TECPEL	DTM-303B	TP210090	N/A	Oct. 03, 2022	Apr. 08, 2023~ Apr. 11, 2023	Oct. 02, 2023	Radiation (03CH12-HY)
Controller	EMEC	EM1000	N/A	Control Turn table & Ant Mast	N/A	Apr. 08, 2023~ Apr. 11, 2023	N/A	Radiation (03CH12-HY)
Antenna Mast	EMEC	AM-BS-4500-B	N/A	1m~4m	N/A	Apr. 08, 2023~ Apr. 11, 2023	N/A	Radiation (03CH12-HY)
Turn Table	EMEC	TT2000	N/A	0~360 Degree	N/A	Apr. 08, 2023~ Apr. 11, 2023	N/A	Radiation (03CH12-HY)
Software	Audix	E3 6.2009-8-24	RK-000989	N/A	N/A	Apr. 08, 2023~ Apr. 11, 2023	N/A	Radiation (03CH12-HY)



## 6 Measurement Uncertainty

### Uncertainty of Radiated Emission Measurement (30 MHz ~ 1000 MHz)

Measuring Uncertainty for a Level of Confidence of 95% ( $U = 2Uc(y)$ )	3.31 dB
---	---------

### Uncertainty of Radiated Emission Measurement (1 GHz ~ 18 GHz)

Measuring Uncertainty for a Level of Confidence of 95% ( $U = 2Uc(y)$ )	3.25 dB
---	---------

### Uncertainty of Radiated Emission Measurement (18 GHz ~ 40 GHz)

Measuring Uncertainty for a Level of Confidence of 95% ( $U = 2Uc(y)$ )	3.81 dB
---	---------



## Appendix A. Test Results of Conducted Test

### Conducted Output Power(Average power) & ERP / EIRP

WCDMA Band V Maximum Average Power [dBm] (GT - LC = -10.7 dB)							
Channel	4132	4182	4233	ERP (dBm)	ERP (W)		
Frequency	826.4	836.4	846.6				
RMC 12.2K	23.33	23.21	22.91	10.48	0.0112		
HSDPA Subtest-1	23.00	22.96	22.94				
HSDPA Subtest-2	23.00	22.95	22.98				
HSDPA Subtest-3	22.52	22.44	22.52				
HSDPA Subtest-4	22.50	22.44	22.48				
HSUPA Subtest-1	22.51	22.55	22.57				
HSUPA Subtest-2	20.91	20.87	20.94				
HSUPA Subtest-3	21.93	22.01	21.89				
HSUPA Subtest-4	20.92	21.00	20.98				
HSUPA Subtest-5	23.00	22.93	22.97				
Limit	ERP < 7W					Result	Pass

WCDMA Band II Maximum Average Power [dBm] (GT - LC = -7 dB)							
Channel	9262	9400	9538	EIRP (dBm)	EIRP (W)		
Frequency	1852.4	1880	1907.6				
RMC 12.2K	22.81	22.70	22.57	15.81	0.0381		
HSDPA Subtest-1	22.74	22.75	22.76				
HSDPA Subtest-2	22.71	22.72	22.76				
HSDPA Subtest-3	22.67	22.76	22.31				
HSDPA Subtest-4	22.64	22.73	22.31				
HSUPA Subtest-1	22.54	22.51	22.56				
HSUPA Subtest-2	20.94	20.92	20.92				
HSUPA Subtest-3	21.94	21.93	21.97				
HSUPA Subtest-4	20.94	20.88	20.94				
HSUPA Subtest-5	22.80	22.78	22.74				
Limit	EIRP < 2W					Result	Pass

WCDMA Band IV Maximum Average Power [dBm] (GT - LC = -6.1 dB)							
Channel	1312	1413	1513	EIRP (dBm)	EIRP (W)		
Frequency	1712.4	1732.6	1752.6				
RMC 12.2K	22.60	22.55	22.58	16.50	0.0447		
HSDPA Subtest-1	22.58	22.54	22.53				
HSDPA Subtest-2	22.53	22.53	22.52				
HSDPA Subtest-3	22.52	22.05	22.21				
HSDPA Subtest-4	22.53	22.03	22.30				
HSUPA Subtest-1	22.52	22.58	22.54				
HSUPA Subtest-2	20.86	20.80	20.82				
HSUPA Subtest-3	21.80	21.71	21.79				
HSUPA Subtest-4	20.91	20.84	20.81				
HSUPA Subtest-5	22.50	22.53	22.52				
Limit	EIRP < 1W					Result	Pass





## A2. WCDMA

### Peak-to-Average Ratio

Mode	WCDMA Band V	WCDMA Band II	WCDMA Band IV	Limit: 13dB
Mod.	RMC 12.2Kbps	RMC 12.2Kbps	RMC 12.2Kbps	Result
Lowest CH	3.52	3.20	8.48	PASS
Middle CH	3.32	3.20	8.52	
Highest CH	3.48	3.08	8.44	

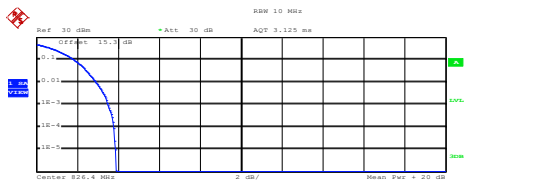
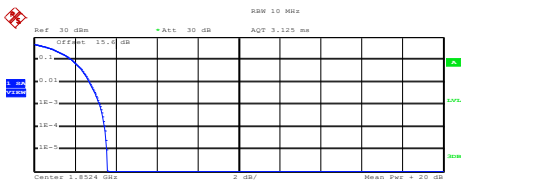
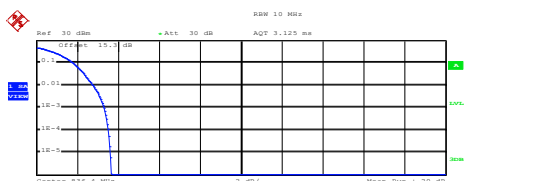
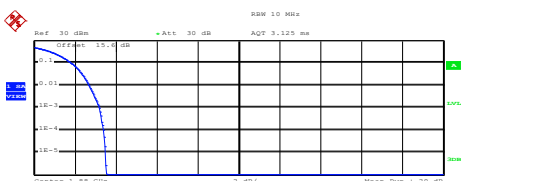
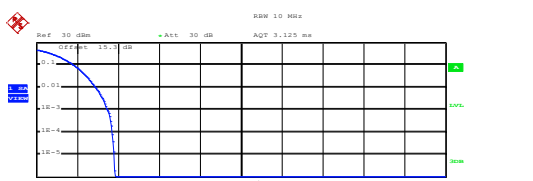
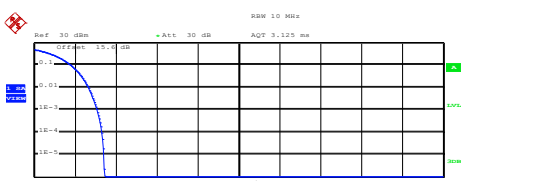

WCDMA Band V (RMC 12.2Kbps)	WCDMA Band II (RMC 12.2Kbps)																
<p align="center"><b>Lowest Channel</b></p>  <p>Center: 824.4 MHz      2 dB/      Mean Pow: + 20 dB</p> <p>Complementary Cumulative Distribution Function (100000 samples)</p> <p>Trace 1</p> <p>Mean 21.48 dBm Peak 25.39 dBm Crest 3.91 dB</p> <table border="0"> <tr><td>10 %</td><td>1.84 dB</td></tr> <tr><td>1 %</td><td>2.92 dB</td></tr> <tr><td>.1 %</td><td>3.52 dB</td></tr> <tr><td>.01 %</td><td>3.80 dB</td></tr> </table> <p>Date: 27.MAR.2023 15:37:00</p>	10 %	1.84 dB	1 %	2.92 dB	.1 %	3.52 dB	.01 %	3.80 dB	<p align="center"><b>Lowest Channel</b></p>  <p>Center: 1.824 GHz      2 dB/      Mean Pow: + 20 dB</p> <p>Complementary Cumulative Distribution Function (100000 samples)</p> <p>Trace 1</p> <p>Mean 20.75 dBm Peak 24.33 dBm Crest 3.58 dB</p> <table border="0"> <tr><td>10 %</td><td>1.84 dB</td></tr> <tr><td>1 %</td><td>2.72 dB</td></tr> <tr><td>.1 %</td><td>3.20 dB</td></tr> <tr><td>.01 %</td><td>3.44 dB</td></tr> </table> <p>Date: 27.MAR.2023 14:40:28</p>	10 %	1.84 dB	1 %	2.72 dB	.1 %	3.20 dB	.01 %	3.44 dB
10 %	1.84 dB																
1 %	2.92 dB																
.1 %	3.52 dB																
.01 %	3.80 dB																
10 %	1.84 dB																
1 %	2.72 dB																
.1 %	3.20 dB																
.01 %	3.44 dB																
<p align="center"><b>Middle Channel</b></p>  <p>Center: 831.4 MHz      2 dB/      Mean Pow: + 20 dB</p> <p>Complementary Cumulative Distribution Function (100000 samples)</p> <p>Trace 1</p> <p>Mean 21.71 dBm Peak 25.39 dBm Crest 3.67 dB</p> <table border="0"> <tr><td>10 %</td><td>1.80 dB</td></tr> <tr><td>1 %</td><td>2.76 dB</td></tr> <tr><td>.1 %</td><td>3.32 dB</td></tr> <tr><td>.01 %</td><td>3.52 dB</td></tr> </table> <p>Date: 27.MAR.2023 15:37:20</p>	10 %	1.80 dB	1 %	2.76 dB	.1 %	3.32 dB	.01 %	3.52 dB	<p align="center"><b>Middle Channel</b></p>  <p>Center: 1.88 GHz      2 dB/      Mean Pow: + 20 dB</p> <p>Complementary Cumulative Distribution Function (100000 samples)</p> <p>Trace 1</p> <p>Mean 20.53 dBm Peak 24.04 dBm Crest 3.52 dB</p> <table border="0"> <tr><td>10 %</td><td>1.80 dB</td></tr> <tr><td>1 %</td><td>2.68 dB</td></tr> <tr><td>.1 %</td><td>3.20 dB</td></tr> <tr><td>.01 %</td><td>3.40 dB</td></tr> </table> <p>Date: 27.MAR.2023 14:40:53</p>	10 %	1.80 dB	1 %	2.68 dB	.1 %	3.20 dB	.01 %	3.40 dB
10 %	1.80 dB																
1 %	2.76 dB																
.1 %	3.32 dB																
.01 %	3.52 dB																
10 %	1.80 dB																
1 %	2.68 dB																
.1 %	3.20 dB																
.01 %	3.40 dB																
<p align="center"><b>Highest Channel</b></p>  <p>Center: 841.6 MHz      2 dB/      Mean Pow: + 20 dB</p> <p>Complementary Cumulative Distribution Function (100000 samples)</p> <p>Trace 1</p> <p>Mean 21.55 dBm Peak 25.39 dBm Crest 3.84 dB</p> <table border="0"> <tr><td>10 %</td><td>1.84 dB</td></tr> <tr><td>1 %</td><td>2.88 dB</td></tr> <tr><td>.1 %</td><td>3.48 dB</td></tr> <tr><td>.01 %</td><td>3.72 dB</td></tr> </table> <p>Date: 27.MAR.2023 15:37:41</p>	10 %	1.84 dB	1 %	2.88 dB	.1 %	3.48 dB	.01 %	3.72 dB	<p align="center"><b>Highest Channel</b></p>  <p>Center: 1.9076 GHz      2 dB/      Mean Pow: + 20 dB</p> <p>Complementary Cumulative Distribution Function (100000 samples)</p> <p>Trace 1</p> <p>Mean 20.46 dBm Peak 23.90 dBm Crest 3.44 dB</p> <table border="0"> <tr><td>10 %</td><td>1.80 dB</td></tr> <tr><td>1 %</td><td>2.68 dB</td></tr> <tr><td>.1 %</td><td>3.08 dB</td></tr> <tr><td>.01 %</td><td>3.32 dB</td></tr> </table> <p>Date: 27.MAR.2023 14:41:27</p>	10 %	1.80 dB	1 %	2.68 dB	.1 %	3.08 dB	.01 %	3.32 dB
10 %	1.84 dB																
1 %	2.88 dB																
.1 %	3.48 dB																
.01 %	3.72 dB																
10 %	1.80 dB																
1 %	2.68 dB																
.1 %	3.08 dB																
.01 %	3.32 dB																



### WCDMA Band IV (RMC 12.2Kbps)

#### Lowest Channel

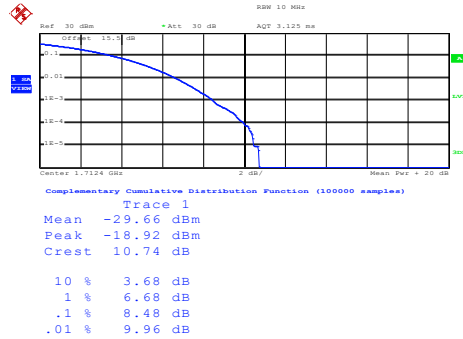

Date: 27.MAR.2023 15:06:18

#### Middle Channel

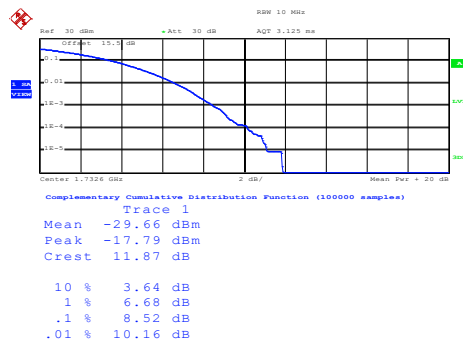

Date: 27.MAR.2023 15:06:43

#### Highest Channel

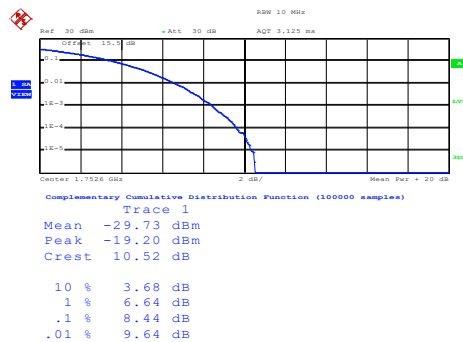

Date: 27.MAR.2023 15:07:02



**26dB Bandwidth**

Mode	WCDMA Band V 26dB BW(MHz)	WCDMA Band II 26dB BW(MHz)	WCDMA Band IV 26dB BW(MHz)
Mod.	RMC 12.2Kbps	RMC 12.2Kbps	RMC 12.2Kbps
Lowest CH	4.71	4.76	4.74
Middle CH	4.70	4.74	4.71
Highest CH	4.72	4.72	4.72



WCDMA Band V (RMC 12.2Kbps)	WCDMA Band II (RMC 12.2Kbps)
<p style="text-align: center;"><b>Lowest Channel</b></p> <p>Date: 27.MAR.2023 15:21:35</p>	<p style="text-align: center;"><b>Lowest Channel</b></p> <p>Date: 27.MAR.2023 13:54:58</p>
<p style="text-align: center;"><b>Middle Channel</b></p> <p>Date: 27.MAR.2023 15:22:24</p>	<p style="text-align: center;"><b>Middle Channel</b></p> <p>Date: 27.MAR.2023 13:55:48</p>
<p style="text-align: center;"><b>Highest Channel</b></p> <p>Date: 27.MAR.2023 15:23:07</p>	<p style="text-align: center;"><b>Highest Channel</b></p> <p>Date: 27.MAR.2023 13:56:40</p>



### WCDMA Band IV (RMC 12.2Kbps)

#### Lowest Channel

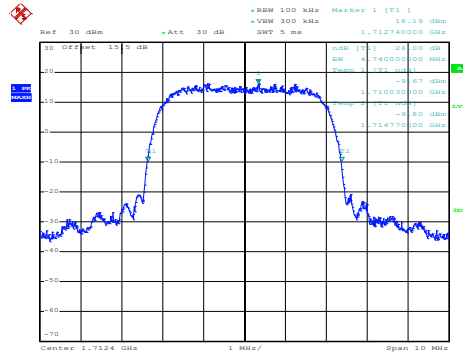

Date: 27.MAR.2023 14:47:47

#### Middle Channel

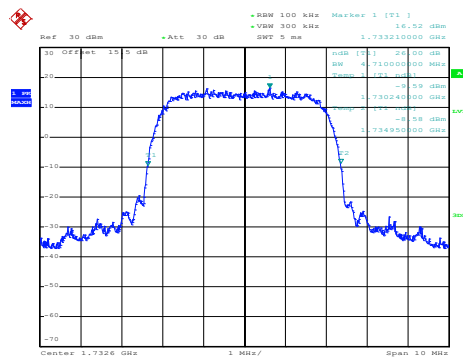

Date: 27.MAR.2023 14:48:36

#### Highest Channel

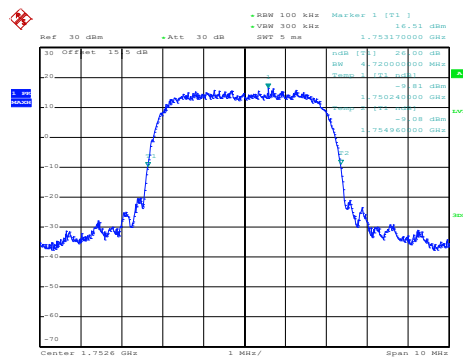

Date: 27.MAR.2023 14:49:16



### Occupied Bandwidth

Mode	WCDMA Band V 99%OBW(MHz)	WCDMA Band II 99%OBW(MHz)	WCDMA Band IV 99%OBW(MHz)
Mod.	RMC 12.2Kbps	RMC 12.2Kbps	RMC 12.2Kbps
Lowest CH	4.14	4.16	4.14
Middle CH	4.13	4.15	4.15
Highest CH	4.14	4.15	4.15



WCDMA Band V (RMC 12.2Kbps)	WCDMA Band II (RMC 12.2Kbps)
<p style="text-align: center;"><b>Lowest Channel</b></p> <p style="text-align: center;">Date: 27.MAR.2023 15:24:15</p>	<p style="text-align: center;"><b>Lowest Channel</b></p> <p style="text-align: center;">Date: 27.MAR.2023 13:58:56</p>
<p style="text-align: center;"><b>Middle Channel</b></p> <p style="text-align: center;">Date: 27.MAR.2023 15:24:58</p>	<p style="text-align: center;"><b>Middle Channel</b></p> <p style="text-align: center;">Date: 27.MAR.2023 13:59:38</p>
<p style="text-align: center;"><b>Highest Channel</b></p> <p style="text-align: center;">Date: 27.MAR.2023 15:25:50</p>	<p style="text-align: center;"><b>Highest Channel</b></p> <p style="text-align: center;">Date: 27.MAR.2023 14:00:19</p>





### WCDMA Band IV (RMC 12.2Kbps)

#### Lowest Channel

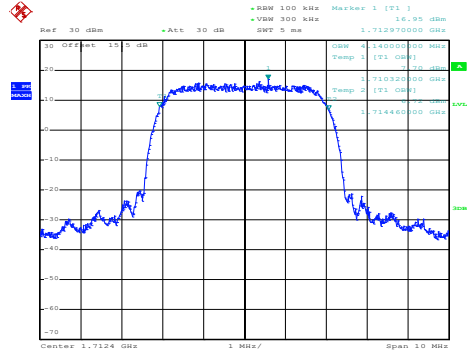

Date: 27.MAR.2023 14:51:17

#### Middle Channel

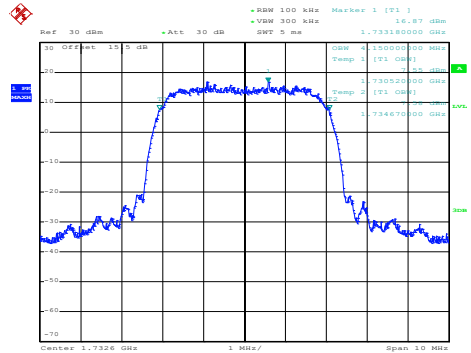

Date: 27.MAR.2023 14:51:55

#### Highest Channel

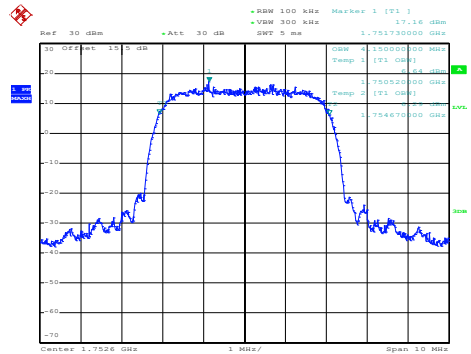

Date: 27.MAR.2023 14:52:45



# Conducted Band Edge

## WCDMA Band V (RMC 12.2Kbps)

### Lowest Band Edge

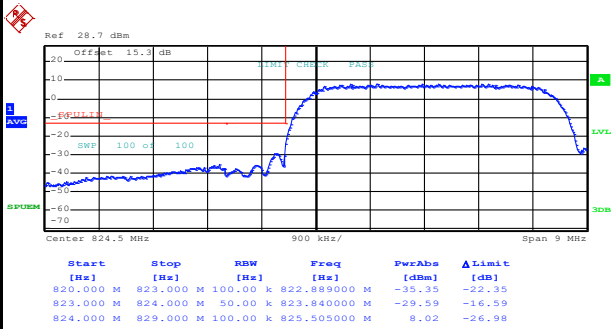

Date: 27.MAR.2023 15:29:21

### Highest Band Edge

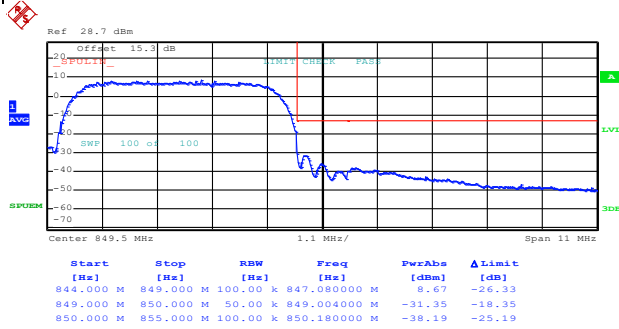

Date: 27.MAR.2023 15:32:26

## WCDMA Band II (RMC 12.2Kbps)

### Lowest Band Edge

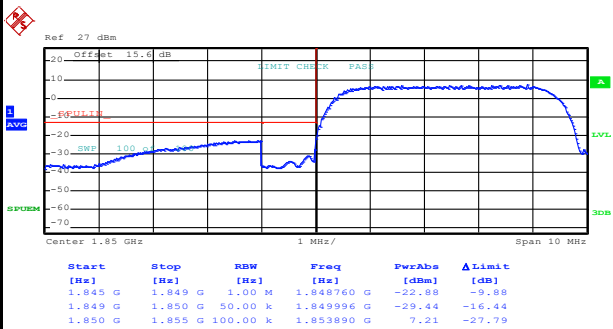

Date: 27.MAR.2023 14:05:08

### Highest Band Edge

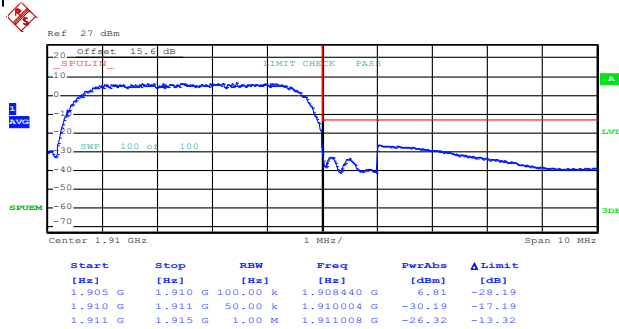

Date: 27.MAR.2023 14:08:32



WCDMA Band IV (RMC 12.2Kbps)

Lowest Band Edge

Highest Band Edge

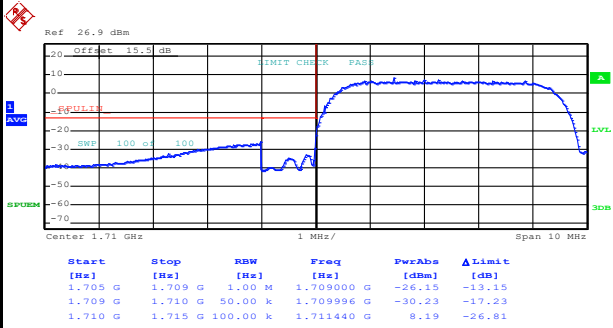

Date: 27.MAR.2023 14:56:47

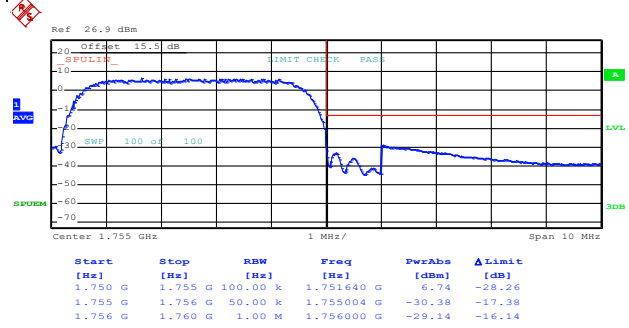

Date: 27.MAR.2023 15:00:11

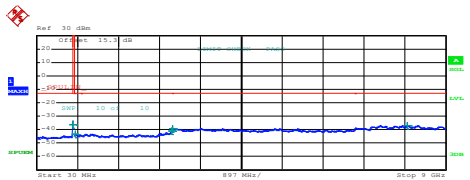
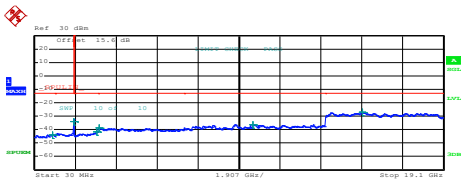
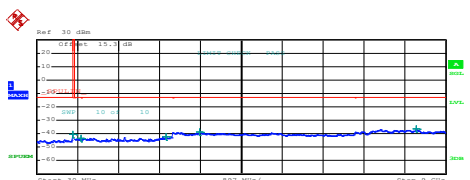
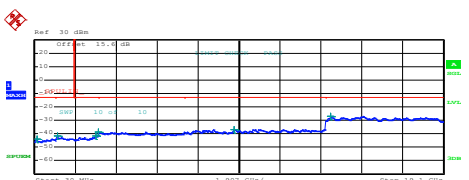
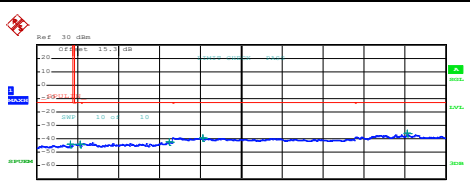
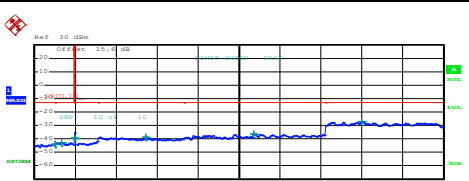

# Conducted Spurious Emission

WCDMA Band V (RMC 12.2Kbps)	WCDMA Band II (RMC 12.2Kbps)																																																																														
Lowest Channel	Lowest Channel																																																																														
 <table border="1"> <thead> <tr> <th>Start [Hz]</th> <th>Stop [Hz]</th> <th>RBW [Hz]</th> <th>Freq [Hz]</th> <th>PwrAbs [dBm]</th> <th>ΔLimit [dB]</th> </tr> </thead> <tbody> <tr> <td>30.000 M</td> <td>30.000 M</td> <td>1.000 M</td> <td>818.815000 M</td> <td>-36.158</td> <td>-23.15</td> </tr> <tr> <td>85.000 M</td> <td>1.000 G</td> <td>1.000 M</td> <td>864.715001 M</td> <td>-43.559</td> <td>-30.59</td> </tr> <tr> <td>1.000 G</td> <td>3.000 G</td> <td>1.000 M</td> <td>2.939000 G</td> <td>-40.888</td> <td>-29.888</td> </tr> <tr> <td>3.000 G</td> <td>7.000 G</td> <td>1.000 M</td> <td>3.007000 G</td> <td>-38.138</td> <td>-26.138</td> </tr> <tr> <td>7.000 G</td> <td>9.000 G</td> <td>1.000 M</td> <td>8.149000 G</td> <td>-36.968</td> <td>-23.968</td> </tr> </tbody> </table> <p>Date: 27.MAR.2023 15:33:55</p>	Start [Hz]	Stop [Hz]	RBW [Hz]	Freq [Hz]	PwrAbs [dBm]	ΔLimit [dB]	30.000 M	30.000 M	1.000 M	818.815000 M	-36.158	-23.15	85.000 M	1.000 G	1.000 M	864.715001 M	-43.559	-30.59	1.000 G	3.000 G	1.000 M	2.939000 G	-40.888	-29.888	3.000 G	7.000 G	1.000 M	3.007000 G	-38.138	-26.138	7.000 G	9.000 G	1.000 M	8.149000 G	-36.968	-23.968	 <table border="1"> <thead> <tr> <th>Start [Hz]</th> <th>Stop [Hz]</th> <th>RBW [Hz]</th> <th>Freq [Hz]</th> <th>PwrAbs [dBm]</th> <th>ΔLimit [dB]</th> </tr> </thead> <tbody> <tr> <td>30.000 M</td> <td>1.000 G</td> <td>1.000 M</td> <td>877.780000 M</td> <td>-43.716</td> <td>-30.716</td> </tr> <tr> <td>1.000 G</td> <td>1.845 G</td> <td>1.000 M</td> <td>1.844789 G</td> <td>-34.23</td> <td>-21.23</td> </tr> <tr> <td>1.915 G</td> <td>3.000 G</td> <td>1.000 M</td> <td>2.936256 G</td> <td>-41.138</td> <td>-28.138</td> </tr> <tr> <td>3.000 G</td> <td>7.000 G</td> <td>1.000 M</td> <td>3.007000 G</td> <td>-38.988</td> <td>-25.988</td> </tr> <tr> <td>7.000 G</td> <td>13.600 G</td> <td>1.000 M</td> <td>10.219100 G</td> <td>-36.24</td> <td>-23.24</td> </tr> <tr> <td>13.600 G</td> <td>19.100 G</td> <td>1.000 M</td> <td>15.336625 G</td> <td>-27.002</td> <td>-14.002</td> </tr> </tbody> </table> <p>Date: 27.MAR.2023 14:35:20</p>	Start [Hz]	Stop [Hz]	RBW [Hz]	Freq [Hz]	PwrAbs [dBm]	ΔLimit [dB]	30.000 M	1.000 G	1.000 M	877.780000 M	-43.716	-30.716	1.000 G	1.845 G	1.000 M	1.844789 G	-34.23	-21.23	1.915 G	3.000 G	1.000 M	2.936256 G	-41.138	-28.138	3.000 G	7.000 G	1.000 M	3.007000 G	-38.988	-25.988	7.000 G	13.600 G	1.000 M	10.219100 G	-36.24	-23.24	13.600 G	19.100 G	1.000 M	15.336625 G	-27.002	-14.002
Start [Hz]	Stop [Hz]	RBW [Hz]	Freq [Hz]	PwrAbs [dBm]	ΔLimit [dB]																																																																										
30.000 M	30.000 M	1.000 M	818.815000 M	-36.158	-23.15																																																																										
85.000 M	1.000 G	1.000 M	864.715001 M	-43.559	-30.59																																																																										
1.000 G	3.000 G	1.000 M	2.939000 G	-40.888	-29.888																																																																										
3.000 G	7.000 G	1.000 M	3.007000 G	-38.138	-26.138																																																																										
7.000 G	9.000 G	1.000 M	8.149000 G	-36.968	-23.968																																																																										
Start [Hz]	Stop [Hz]	RBW [Hz]	Freq [Hz]	PwrAbs [dBm]	ΔLimit [dB]																																																																										
30.000 M	1.000 G	1.000 M	877.780000 M	-43.716	-30.716																																																																										
1.000 G	1.845 G	1.000 M	1.844789 G	-34.23	-21.23																																																																										
1.915 G	3.000 G	1.000 M	2.936256 G	-41.138	-28.138																																																																										
3.000 G	7.000 G	1.000 M	3.007000 G	-38.988	-25.988																																																																										
7.000 G	13.600 G	1.000 M	10.219100 G	-36.24	-23.24																																																																										
13.600 G	19.100 G	1.000 M	15.336625 G	-27.002	-14.002																																																																										
Middle Channel	Middle Channel																																																																														
 <table border="1"> <thead> <tr> <th>Start [Hz]</th> <th>Stop [Hz]</th> <th>RBW [Hz]</th> <th>Freq [Hz]</th> <th>PwrAbs [dBm]</th> <th>ΔLimit [dB]</th> </tr> </thead> <tbody> <tr> <td>30.000 M</td> <td>30.000 M</td> <td>1.000 M</td> <td>816.050000 M</td> <td>-40.63</td> <td>-27.63</td> </tr> <tr> <td>85.000 M</td> <td>1.000 G</td> <td>1.000 M</td> <td>931.300000 M</td> <td>-42.44</td> <td>-29.44</td> </tr> <tr> <td>1.000 G</td> <td>3.000 G</td> <td>1.000 M</td> <td>2.857000 G</td> <td>-41.93</td> <td>-28.93</td> </tr> <tr> <td>3.000 G</td> <td>7.000 G</td> <td>1.000 M</td> <td>3.959000 G</td> <td>-39.90</td> <td>-25.90</td> </tr> <tr> <td>7.000 G</td> <td>9.000 G</td> <td>1.000 M</td> <td>8.149000 G</td> <td>-36.41</td> <td>-23.41</td> </tr> </tbody> </table> <p>Date: 27.MAR.2023 15:34:53</p>	Start [Hz]	Stop [Hz]	RBW [Hz]	Freq [Hz]	PwrAbs [dBm]	ΔLimit [dB]	30.000 M	30.000 M	1.000 M	816.050000 M	-40.63	-27.63	85.000 M	1.000 G	1.000 M	931.300000 M	-42.44	-29.44	1.000 G	3.000 G	1.000 M	2.857000 G	-41.93	-28.93	3.000 G	7.000 G	1.000 M	3.959000 G	-39.90	-25.90	7.000 G	9.000 G	1.000 M	8.149000 G	-36.41	-23.41	 <table border="1"> <thead> <tr> <th>Start [Hz]</th> <th>Stop [Hz]</th> <th>RBW [Hz]</th> <th>Freq [Hz]</th> <th>PwrAbs [dBm]</th> <th>ΔLimit [dB]</th> </tr> </thead> <tbody> <tr> <td>30.000 M</td> <td>1.000 G</td> <td>1.000 M</td> <td>143.000000 M</td> <td>-41.92</td> <td>-30.92</td> </tr> <tr> <td>1.000 G</td> <td>1.845 G</td> <td>1.000 M</td> <td>1.8090410 G</td> <td>-41.80</td> <td>-28.80</td> </tr> <tr> <td>1.915 G</td> <td>3.000 G</td> <td>1.000 M</td> <td>2.893127 G</td> <td>-41.55</td> <td>-28.55</td> </tr> <tr> <td>3.000 G</td> <td>7.000 G</td> <td>1.000 M</td> <td>3.003000 G</td> <td>-39.69</td> <td>-25.69</td> </tr> <tr> <td>7.000 G</td> <td>13.600 G</td> <td>1.000 M</td> <td>9.332000 G</td> <td>-35.83</td> <td>-22.83</td> </tr> <tr> <td>13.600 G</td> <td>19.100 G</td> <td>1.000 M</td> <td>13.846813 G</td> <td>-27.08</td> <td>-14.08</td> </tr> </tbody> </table> <p>Date: 27.MAR.2023 14:37:03</p>	Start [Hz]	Stop [Hz]	RBW [Hz]	Freq [Hz]	PwrAbs [dBm]	ΔLimit [dB]	30.000 M	1.000 G	1.000 M	143.000000 M	-41.92	-30.92	1.000 G	1.845 G	1.000 M	1.8090410 G	-41.80	-28.80	1.915 G	3.000 G	1.000 M	2.893127 G	-41.55	-28.55	3.000 G	7.000 G	1.000 M	3.003000 G	-39.69	-25.69	7.000 G	13.600 G	1.000 M	9.332000 G	-35.83	-22.83	13.600 G	19.100 G	1.000 M	13.846813 G	-27.08	-14.08
Start [Hz]	Stop [Hz]	RBW [Hz]	Freq [Hz]	PwrAbs [dBm]	ΔLimit [dB]																																																																										
30.000 M	30.000 M	1.000 M	816.050000 M	-40.63	-27.63																																																																										
85.000 M	1.000 G	1.000 M	931.300000 M	-42.44	-29.44																																																																										
1.000 G	3.000 G	1.000 M	2.857000 G	-41.93	-28.93																																																																										
3.000 G	7.000 G	1.000 M	3.959000 G	-39.90	-25.90																																																																										
7.000 G	9.000 G	1.000 M	8.149000 G	-36.41	-23.41																																																																										
Start [Hz]	Stop [Hz]	RBW [Hz]	Freq [Hz]	PwrAbs [dBm]	ΔLimit [dB]																																																																										
30.000 M	1.000 G	1.000 M	143.000000 M	-41.92	-30.92																																																																										
1.000 G	1.845 G	1.000 M	1.8090410 G	-41.80	-28.80																																																																										
1.915 G	3.000 G	1.000 M	2.893127 G	-41.55	-28.55																																																																										
3.000 G	7.000 G	1.000 M	3.003000 G	-39.69	-25.69																																																																										
7.000 G	13.600 G	1.000 M	9.332000 G	-35.83	-22.83																																																																										
13.600 G	19.100 G	1.000 M	13.846813 G	-27.08	-14.08																																																																										
Highest Channel	Highest Channel																																																																														
 <table border="1"> <thead> <tr> <th>Start [Hz]</th> <th>Stop [Hz]</th> <th>RBW [Hz]</th> <th>Freq [Hz]</th> <th>PwrAbs [dBm]</th> <th>ΔLimit [dB]</th> </tr> </thead> <tbody> <tr> <td>30.000 M</td> <td>30.000 M</td> <td>1.000 M</td> <td>769.045000 M</td> <td>-44.07</td> <td>-31.07</td> </tr> <tr> <td>85.000 M</td> <td>1.000 G</td> <td>1.000 M</td> <td>972.087008 M</td> <td>-43.75</td> <td>-30.75</td> </tr> <tr> <td>1.000 G</td> <td>3.000 G</td> <td>1.000 M</td> <td>2.948000 G</td> <td>-42.39</td> <td>-29.39</td> </tr> <tr> <td>3.000 G</td> <td>7.000 G</td> <td>1.000 M</td> <td>3.567000 G</td> <td>-39.12</td> <td>-26.12</td> </tr> <tr> <td>7.000 G</td> <td>9.000 G</td> <td>1.000 M</td> <td>8.149000 G</td> <td>-36.02</td> <td>-23.02</td> </tr> </tbody> </table> <p>Date: 27.MAR.2023 15:35:51</p>	Start [Hz]	Stop [Hz]	RBW [Hz]	Freq [Hz]	PwrAbs [dBm]	ΔLimit [dB]	30.000 M	30.000 M	1.000 M	769.045000 M	-44.07	-31.07	85.000 M	1.000 G	1.000 M	972.087008 M	-43.75	-30.75	1.000 G	3.000 G	1.000 M	2.948000 G	-42.39	-29.39	3.000 G	7.000 G	1.000 M	3.567000 G	-39.12	-26.12	7.000 G	9.000 G	1.000 M	8.149000 G	-36.02	-23.02	 <table border="1"> <thead> <tr> <th>Start [Hz]</th> <th>Stop [Hz]</th> <th>RBW [Hz]</th> <th>Freq [Hz]</th> <th>PwrAbs [dBm]</th> <th>ΔLimit [dB]</th> </tr> </thead> <tbody> <tr> <td>30.000 M</td> <td>1.000 G</td> <td>1.000 M</td> <td>959.302000 M</td> <td>-41.60</td> <td>-30.60</td> </tr> <tr> <td>1.000 G</td> <td>1.845 G</td> <td>1.000 M</td> <td>1.280751 G</td> <td>-42.56</td> <td>-29.56</td> </tr> <tr> <td>1.915 G</td> <td>3.000 G</td> <td>1.000 M</td> <td>1.981271 G</td> <td>-39.30</td> <td>-26.30</td> </tr> <tr> <td>3.000 G</td> <td>7.000 G</td> <td>1.000 M</td> <td>3.120400 G</td> <td>-38.45</td> <td>-25.45</td> </tr> <tr> <td>7.000 G</td> <td>13.600 G</td> <td>1.000 M</td> <td>10.236475 G</td> <td>-36.50</td> <td>-23.50</td> </tr> <tr> <td>13.600 G</td> <td>19.100 G</td> <td>1.000 M</td> <td>15.266925 G</td> <td>-27.18</td> <td>-14.18</td> </tr> </tbody> </table> <p>Date: 27.MAR.2023 14:38:17</p>	Start [Hz]	Stop [Hz]	RBW [Hz]	Freq [Hz]	PwrAbs [dBm]	ΔLimit [dB]	30.000 M	1.000 G	1.000 M	959.302000 M	-41.60	-30.60	1.000 G	1.845 G	1.000 M	1.280751 G	-42.56	-29.56	1.915 G	3.000 G	1.000 M	1.981271 G	-39.30	-26.30	3.000 G	7.000 G	1.000 M	3.120400 G	-38.45	-25.45	7.000 G	13.600 G	1.000 M	10.236475 G	-36.50	-23.50	13.600 G	19.100 G	1.000 M	15.266925 G	-27.18	-14.18
Start [Hz]	Stop [Hz]	RBW [Hz]	Freq [Hz]	PwrAbs [dBm]	ΔLimit [dB]																																																																										
30.000 M	30.000 M	1.000 M	769.045000 M	-44.07	-31.07																																																																										
85.000 M	1.000 G	1.000 M	972.087008 M	-43.75	-30.75																																																																										
1.000 G	3.000 G	1.000 M	2.948000 G	-42.39	-29.39																																																																										
3.000 G	7.000 G	1.000 M	3.567000 G	-39.12	-26.12																																																																										
7.000 G	9.000 G	1.000 M	8.149000 G	-36.02	-23.02																																																																										
Start [Hz]	Stop [Hz]	RBW [Hz]	Freq [Hz]	PwrAbs [dBm]	ΔLimit [dB]																																																																										
30.000 M	1.000 G	1.000 M	959.302000 M	-41.60	-30.60																																																																										
1.000 G	1.845 G	1.000 M	1.280751 G	-42.56	-29.56																																																																										
1.915 G	3.000 G	1.000 M	1.981271 G	-39.30	-26.30																																																																										
3.000 G	7.000 G	1.000 M	3.120400 G	-38.45	-25.45																																																																										
7.000 G	13.600 G	1.000 M	10.236475 G	-36.50	-23.50																																																																										
13.600 G	19.100 G	1.000 M	15.266925 G	-27.18	-14.18																																																																										



WCDMA Band IV (RMC 12.2Kbps)

Lowest Channel

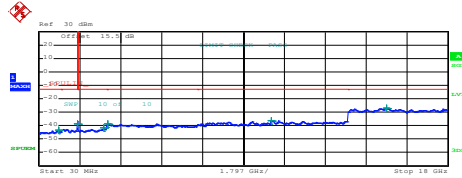

Start [MHz]	Stop [MHz]	BSW [Hz]	Freq [MHz]	PwrAbs [dBm]	ΔLimit [dB]
30.000 M	1.000 G	1.00 M	902.072000 M	-43.63	-30.43
1.000 G	1.705 G	1.00 M	1.704824 G	-38.92	-25.92
1.760 G	3.000 G	1.00 M	2.862980 G	-41.05	-28.55
3.000 G	7.000 G	1.00 M	3.032000 G	-38.69	-25.69
7.000 G	13.600 G	1.00 M	10.224925 G	-36.33	-23.33
13.600 G	18.000 G	1.00 M	15.312250 G	-26.93	-13.93

Date: 27.MAR.2023 15:02:58

Middle Channel

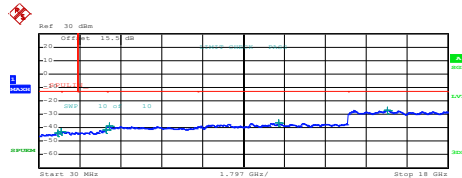

Start [MHz]	Stop [MHz]	BSW [Hz]	Freq [MHz]	PwrAbs [dBm]	ΔLimit [dB]
30.000 M	1.000 G	1.00 M	871.232500 M	-43.88	-30.88
1.000 G	1.705 G	1.00 M	1.028524 G	-42.89	-29.89
1.760 G	3.000 G	1.00 M	2.965590 G	-41.70	-28.70
3.000 G	7.000 G	1.00 M	3.109000 G	-38.82	-25.82
7.000 G	13.600 G	1.00 M	10.360700 G	-36.64	-23.64
13.600 G	18.000 G	1.00 M	15.351200 G	-26.92	-13.92

Date: 27.MAR.2023 15:03:56

Highest Channel

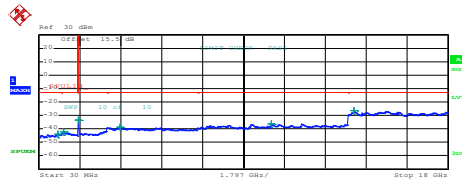

Start [MHz]	Stop [MHz]	BSW [Hz]	Freq [MHz]	PwrAbs [dBm]	ΔLimit [dB]
30.000 M	1.000 G	1.00 M	870.020000 M	-43.95	-30.95
1.000 G	1.705 G	1.00 M	1.121789 G	-42.49	-29.49
1.760 G	3.000 G	1.00 M	1.761860 G	-39.47	-26.47
3.000 G	7.000 G	1.00 M	3.038000 G	-38.84	-25.84
7.000 G	13.600 G	1.00 M	10.239775 G	-36.47	-23.47
13.600 G	18.000 G	1.00 M	15.879200 G	-26.51	-13.51

Date: 27.MAR.2023 15:05:20



### Frequency Stability

Test Conditions	Middle Channel	WCDMA Band V (RMC 12.2Kbps)	Limit 2.5ppm
Temperature (°C)	Voltage (Volt)	Deviation (ppm)	Result
35	Normal Voltage	0.0012	PASS
30	Normal Voltage	0.0036	
20(Ref.)	Normal Voltage	0.0000	
10	Normal Voltage	0.0060	
0	Normal Voltage	0.0084	
20	Maximum Voltage	0.0048	
20	Normal Voltage	0.0024	
20	Battery End Point	0.0060	

Test Conditions	Middle Channel	WCDMA Band II (RMC 12.2Kbps)	Limit Note 2.
Temperature (°C)	Voltage (Volt)	Deviation (ppm)	Result
35	Normal Voltage	0.0027	PASS
30	Normal Voltage	0.0005	
20(Ref.)	Normal Voltage	0.0000	
10	Normal Voltage	0.0080	
0	Normal Voltage	0.0096	
20	Maximum Voltage	0.0005	
20	Normal Voltage	0.0000	
20	Battery End Point	0.0005	

**Note:**

1. Normal Voltage = 3.87 V. ; Battery End Point (BEP) = 3.6 V. ; Maximum Voltage =4.4 V
2. The frequency fundamental emissions stay within the authorized frequency block.



Test Conditions	Middle Channel	WCDMA Band IV (RMC 12.2Kbps)	Limit Note 2.
Temperature (°C)	Voltage (Volt)	Deviation (ppm)	Result
40	Normal Voltage	0.0162	PASS
30	Normal Voltage	0.0231	
20(Ref.)	Normal Voltage	0.0000	
10	Normal Voltage	0.0196	
0	Normal Voltage	0.0092	
20	Maximum Voltage	0.0242	
20	Normal Voltage	0.0000	
20	Battery End Point	0.0202	

**Note:**

1. Normal Voltage = 3.87 V. ; Battery End Point (BEP) = 3.6 V. ; Maximum Voltage =4.4 V
2. The frequency fundamental emissions stay within the authorized frequency block.



## Appendix B. Test Results of Radiated Test

<Ant. 1>

### WCDMA 850

WCDMA 850									
Channel	Frequency ( MHz )	ERP ( dBm )	Limit ( dBm )	Margin ( dB )	SPA Reading (dBm)	S.G. Power ( dBm )	TX Cable loss ( dB )	TX Antenna Gain (dBi)	Polarization (H/V)
Lowest	1656	-60.56	-13	-47.56	-71.06	-67.00	0.81	9.40	H
	2479	-52.00	-13	-39.00	-65.73	-59.16	1.09	10.40	H
	3305	-54.79	-13	-41.79	-71.6	-63.61	1.10	12.08	H
									H
									H
	1656	-60.33	-13	-47.33	-70.78	-66.77	0.81	9.40	V
	2479	-50.03	-13	-37.03	-63.81	-57.19	1.09	10.40	V
	3305	-54.19	-13	-41.19	-71.3	-63.01	1.10	12.08	V
									V
									V
									V
	Middle	1672	-59.67	-13	-46.67	-70.22	-66.16	0.81	9.45
2509		-50.24	-13	-37.24	-64.01	-57.53	1.11	10.55	H
3345		-54.75	-13	-41.75	-71.6	-63.79	1.10	12.30	H
									H
									H
1672		-59.39	-13	-46.39	-69.91	-65.88	0.81	9.45	V
2509		-46.56	-13	-33.56	-60.44	-53.85	1.11	10.55	V
3345		-53.77	-13	-40.77	-70.93	-62.81	1.10	12.30	V
									V
									V
									V





Highest	1696	-58.90	-13	-45.90	-69.49	-65.47	0.81	9.54	H
	2539	-52.19	-13	-39.19	-66.21	-59.64	1.09	10.70	H
	3386	-54.67	-13	-41.67	-71.55	-63.94	1.10	12.52	H
									H
									H
									H
									H
	1696	-58.70	-13	-45.70	-69.28	-65.27	0.81	9.54	V
	2539	-45.64	-13	-32.64	-59.74	-53.09	1.09	10.70	V
	3386	-53.98	-13	-40.98	-71.2	-63.25	1.10	12.52	V
									V
									V
									V
									V

Remark: Spurious emissions within 30-1000MHz were found more than 20dB below limit line.



<Ant. 0>

**WCDMA 1700**

WCDMA 1700									
Channel	Frequency ( MHz )	EIRP ( dBm )	Limit ( dBm )	Margin ( dB )	SPA Reading (dBm)	S.G. Power ( dBm )	TX Cable loss ( dB )	TX Antenna Gain (dBi)	Polarization (H/V)
Lowest	3424	-53.57	-13	-40.57	-71.75	-64.98	1.14	12.55	H
	5137	-49.33	-13	-36.33	-71.4	-60.70	1.30	12.67	H
	6849	-45.11	-13	-32.11	-72.7	-55.67	1.85	12.40	H
									H
									H
									H
									H
	3424	-53.36	-13	-40.36	-71.67	-64.77	1.14	12.55	V
	5137	-49.17	-13	-36.17	-72.07	-60.54	1.30	12.67	V
	6849	-43.92	-13	-30.92	-72.24	-54.48	1.85	12.40	V
									V
									V
									V
									V
Middle	3465	-53.06	-13	-40.06	-71.88	-64.32	1.21	12.47	H
	5197	-46.91	-13	-33.91	-69.14	-58.33	1.28	12.70	H
	6930	-44.16	-13	-31.16	-71.88	-54.40	1.84	12.08	H
									H
									H
									H
									H
	3465	-53.19	-13	-40.19	-71.8	-64.45	1.21	12.47	V
	5197	-45.94	-13	-32.94	-69.16	-57.36	1.28	12.70	V
	6930	-44.05	-13	-31.05	-72.16	-54.29	1.84	12.08	V
									V
									V
									V
									V



Highest	3505	-52.42	-13	-39.42	-71.76	-63.53	1.27	12.38	H
	5257	-49.50	-13	-36.50	-72.18	-60.97	1.40	12.87	H
	7010	-44.37	-13	-31.37	-72.25	-54.30	1.84	11.78	H
									H
									H
									H
									H
	3505	-52.96	-13	-39.96	-71.83	-64.07	1.27	12.38	V
	5257	-48.22	-13	-35.22	-72.1	-59.69	1.40	12.87	V
	7010	-44.01	-13	-31.01	-71.99	-53.94	1.84	11.78	V
									V
									V
									V
									V

**Remark:** Spurious emissions within 30-1000MHz were found more than 20dB below limit line.



**WCDMA 1900**

WCDMA 1900									
Channel	Frequency ( MHz )	EIRP ( dBm )	Limit ( dBm )	Margin ( dB )	SPA Reading (dBm)	S.G. Power ( dBm )	TX Cable loss ( dB )	TX Antenna Gain (dBi)	Polarization (H/V)
Lowest	3704	-51.89	-13	-38.89	-70.79	-60.62	1.23	12.10	H
	5557	-48.03	-13	-35.03	-71.35	-57.47	1.57	13.16	H
	7409	-42.34	-13	-29.34	-71.82	-49.63	1.94	11.38	H
									H
									H
	3704	-51.79	-13	-38.79	-70.95	-60.52	1.23	12.10	V
	5557	-45.80	-13	-32.80	-71.83	-55.24	1.57	13.16	V
	7409	-42.01	-13	-29.01	-71.58	-49.30	1.94	11.38	V
									V
									V
									V
									V
Middle	3760	-52.06	-13	-39.06	-70.91	-60.91	1.16	12.16	H
	5640	-48.70	-13	-35.70	-72	-58.31	1.48	13.24	H
	7520	-42.79	-13	-29.79	-72.04	-50.01	1.91	11.28	H
									H
									H
									H
									H
	3760	-51.98	-13	-38.98	-71.13	-60.83	1.16	12.16	V
	5640	-45.68	-13	-32.68	-71.72	-55.29	1.48	13.24	V
	7520	-42.54	-13	-29.54	-71.92	-49.76	1.91	11.28	V
									V
									V
								V	
								V	



Highest	3815	-52.32	-13	-39.32	-71.22	-61.25	1.15	12.23	H
	5722	-48.97	-13	-35.97	-72.36	-58.75	1.39	13.32	H
	7630	-42.77	-13	-29.77	-72.05	-50.35	1.89	11.62	H
									H
									H
									H
									H
	3815	-52.04	-13	-39.04	-71.25	-60.97	1.15	12.23	V
	5722	-46.22	-13	-33.22	-72.07	-56.00	1.39	13.32	V
	7630	-42.68	-13	-29.68	-72.15	-50.26	1.89	11.62	V
									V
									V
									V
									V

Remark: Spurious emissions within 30-1000MHz were found more than 20dB below limit line.

————THE END————