



FCC RADIO TEST REPORT

FCC ID : A4RGD2WG
Equipment : Wireless Device
Model Name : GD2WG
Applicant : Google LLC
1600 Amphitheatre Parkway,
Mountain View, California, 94043 USA
Standard : FCC Part 15 Subpart C §15.247

The product was received on Mar. 17, 2023 and testing was performed from Mar. 28, 2023 to May 04, 2023. We, Sporton International Inc. Wensan Laboratory, would like to declare that the tested sample has been evaluated in accordance with the test procedures and has been in compliance with the applicable technical standards.

The test results in this report apply exclusively to the tested model / sample. Without written approval from Sporton International Inc. Wensan Laboratory, the test report shall not be reproduced except in full.

Approved by: Louis Wu

Sporton International Inc. Wensan Laboratory

No.58, Aly. 75, Ln. 564, Wenhua 3rd, Rd., Guishan Dist., Taoyuan City 333010, Taiwan (R.O.C.)



Table of Contents

History of this test report.....	3
Summary of Test Result.....	4
1 General Description.....	5
1.1 Product Feature of Equipment Under Test.....	5
1.2 Product Specification of Equipment Under Test.....	5
1.3 Modification of EUT	6
1.4 Testing Location	6
1.5 Applicable Standards.....	6
2 Test Configuration of Equipment Under Test	7
2.1 Carrier Frequency Channel	7
2.2 Test Mode.....	8
2.3 Connection Diagram of Test System.....	9
2.4 Support Unit used in test configuration and system	10
2.5 EUT Operation Test Setup	10
2.6 Measurement Results Explanation Example.....	10
3 Test Result.....	11
3.1 6dB and 99% Bandwidth Measurement	11
3.2 Output Power Measurement.....	12
3.3 Power Spectral Density Measurement	13
3.4 Conducted Band Edges and Spurious Emission Measurement	14
3.5 Radiated Band Edges and Spurious Emission Measurement	15
3.6 AC Conducted Emission Measurement.....	19
3.7 Antenna Requirements.....	21
4 List of Measuring Equipment	22
5 Measurement Uncertainty	23
Appendix A. Conducted Test Results	
Appendix B. AC Conducted Emission Test Result	
Appendix C. Radiated Spurious Emission	
Appendix D. Radiated Spurious Emission Plots	
Appendix E. Duty Cycle Plots	
Appendix F. Setup Photographs	



Summary of Test Result

Report Clause	Ref Std. Clause	Test Items	Result (PASS/FAIL)	Remark
3.1	15.247(a)(2)	6dB Bandwidth	Pass	-
3.1	2.1049	99% Occupied Bandwidth	Reporting only	-
3.2	15.247(b)(3) 15.247(b)(4)	Output Power	Pass	-
3.3	15.247(e)	Power Spectral Density	Pass	-
3.4	15.247(d)	Conducted Band Edges and Spurious Emission	Pass	-
3.5	15.247(d)	Radiated Band Edges and Spurious Emission	Pass	9.01 dB under the limit at 902.030 MHz
3.6	15.207	AC Conducted Emission	Pass	14.14 dB under the limit at 0.161 MHz
3.7	15.203	Antenna Requirement	Pass	-

Conformity Assessment Condition:

1. The test results (PASS/FAIL) with all measurement uncertainty excluded are presented against the regulation limits or in accordance with the requirements stipulated by the applicant/manufacturer who shall bear all the risks of non-compliance that may potentially occur if measurement uncertainty is taken into account.
2. The measurement uncertainty please refer to each test result in the section "Measurement Uncertainty".

Disclaimer:

The product specifications of the EUT presented in the test report that may affect the test assessments are declared by the manufacturer who shall take full responsibility for the authenticity.

Reviewed by: Yun Huang**Report Producer: Lucy Wu**



1 General Description

1.1 Product Feature of Equipment Under Test

Product Feature	
Equipment	Wireless Device
Model Name	GD2WG
FCC ID	A4RGD2WG
EUT supports Radios application	WCDMA/HSPA/LTE WLAN 11b/g/n HT20 Bluetooth BR/EDR/LE

Remark: The above EUT's information was declared by manufacturer.

EUT Information List	
S/N	Performed Test Item
232640500000026	RF Conducted Measurement
32251RUJWN0655	Radiated Spurious Emission
32251RUJWN068A	Conducted Emission

1.2 Product Specification of Equipment Under Test

Product Specification subjective to this standard	
Tx/Rx Channel Frequency Range	2402 MHz ~ 2480 MHz
Number of Channels	40
Carrier Frequency of Each Channel	40 Channel (37 hopping + 3 advertising channel)
Maximum Output Power to Antenna	Bluetooth – LE (1Mbps): 18.90 dBm / 0.0776 W Bluetooth – LE (2Mbps): 19.10 dBm / 0.0813 W
99% Occupied Bandwidth	Bluetooth – LE (1Mbps): 1.021 MHz Bluetooth – LE (2Mbps): 2.030 MHz
Antenna Type / Gain	PIFA Antenna with gain -5.9 dBi
Type of Modulation	Bluetooth – LE : GFSK

Remark: The EUT's information above is declared by manufacturer. Please refer to Disclaimer in report summary.



1.3 Modification of EUT

No modifications made to the EUT during the testing.

1.4 Testing Location

Test Site	Sporton International Inc. Wensan Laboratory
Test Site Location	No.58, Aly. 75, Ln. 564, Wenhua 3rd, Rd., Guishan Dist., Taoyuan City 333010, Taiwan (R.O.C.) TEL: +886-3-327-0868 FAX: +886-3-327-0855
Test Site No.	Sporton Site No. TH05-HY, CO07-HY, 03CH20-HY

Note: The test site complies with ANSI C63.4 2014 requirement.

FCC designation No.: TW3786

1.5 Applicable Standards

According to the specifications declared by the manufacturer, the EUT must comply with the requirements of the following standards:

- ♦ FCC Part 15 Subpart C §15.247
- ♦ FCC KDB Publication No. 558074 D01 15.247 Meas Guidance v05r02
- ♦ FCC KDB 414788 D01 Radiated Test Site v01r01
- ♦ ANSI C63.10-2013

Remark:

1. All the test items were validated and recorded in accordance with the standards without any modification during the testing.
2. The TAF code is not including all the FCC KDB listed without accreditation.



2 Test Configuration of Equipment Under Test

2.1 Carrier Frequency Channel

Frequency Band	Channel	Freq. (MHz)	Channel	Freq. (MHz)
2400-2483.5 MHz	0	2402	21	2444
	1	2404	22	2446
	2	2406	23	2448
	3	2408	24	2450
	4	2410	25	2452
	5	2412	26	2454
	6	2414	27	2456
	7	2416	28	2458
	8	2418	29	2460
	9	2420	30	2462
	10	2422	31	2464
	11	2424	32	2466
	12	2426	33	2468
	13	2428	34	2470
	14	2430	35	2472
	15	2432	36	2474
	16	2434	37	2476
	17	2436	38	2478
	18	2438	39	2480
	19	2440	-	-
20	2442	-	-	



2.2 Test Mode

- a. The EUT has been associated with peripherals and configuration operated in a manner tended to maximize its emission characteristics in a typical application. Frequency range investigated: conduction emission (150 kHz to 30 MHz), radiation emission (9 kHz to the 10th harmonic of the highest fundamental frequency or to 40 GHz, whichever is lower). For radiated measurement, the measured emission level of the EUT was maximized by rotating the EUT on a turntable, adjusting the orientation of the EUT and EUT antenna in three orthogonal axis (X: flat, Y: portrait, Z: landscape), and adjusting the measurement antenna orientation, following C63.10 exploratory test procedures and find X plane with Adapter as worst plane.
- b. AC power line Conducted Emission was tested under maximum output power.

The following summary table is showing all test modes to demonstrate in compliance with the standard.

Summary table of Test Cases	
Test Item	Data Rate / Modulation
Conducted Test Cases	Bluetooth – LE / GFSK
	Mode 1: Bluetooth Tx CH00_2402 MHz_1Mbps
	Mode 2: Bluetooth Tx CH19_2440 MHz_1Mbps
	Mode 3: Bluetooth Tx CH39_2480 MHz_1Mbps
	Mode 4: Bluetooth Tx CH00_2402 MHz_2Mbps
	Mode 5: Bluetooth Tx CH19_2440 MHz_2Mbps
	Mode 6: Bluetooth Tx CH39_2480 MHz_2Mbps
Radiated Test Cases	Mode 1: Bluetooth Tx CH00_2402 MHz_1Mbps
	Mode 2: Bluetooth Tx CH19_2440 MHz_1Mbps
	Mode 3: Bluetooth Tx CH39_2480 MHz_1Mbps
	Mode 4: Bluetooth Tx CH00_2402 MHz_2Mbps
	Mode 5: Bluetooth Tx CH19_2440 MHz_2Mbps
	Mode 6: Bluetooth Tx CH39_2480 MHz_2Mbps
AC Conducted Emission	Mode 1: Bluetooth Link + WLAN (2.4GHz) Link + Battery + USB Cable (Charging from Adapter)
Remark: For radiation spurious emission, the modulation and the data rate picked for testing are determined by the Max. RF conducted power.	

2.3 Connection Diagram of Test System

<AC Conducted Emission Mode>

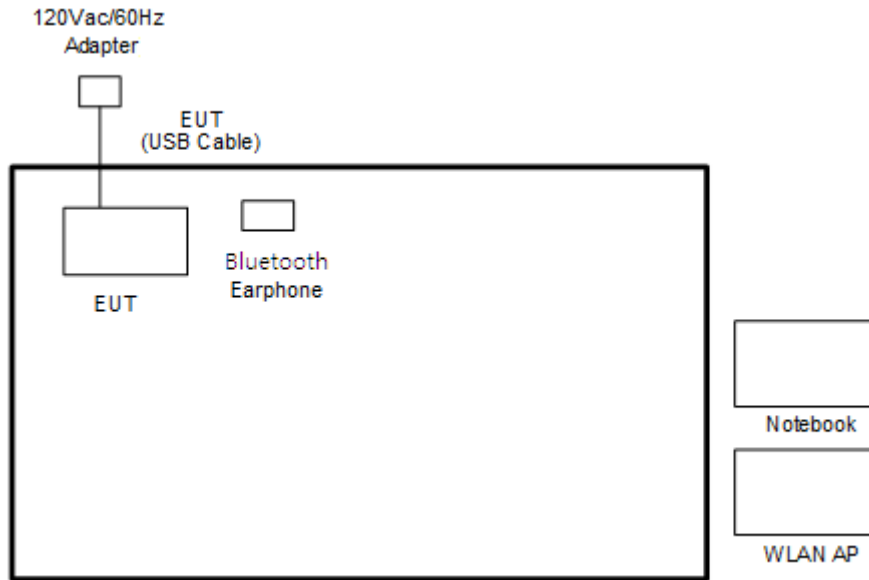

<Bluetooth-LE Tx Mode>

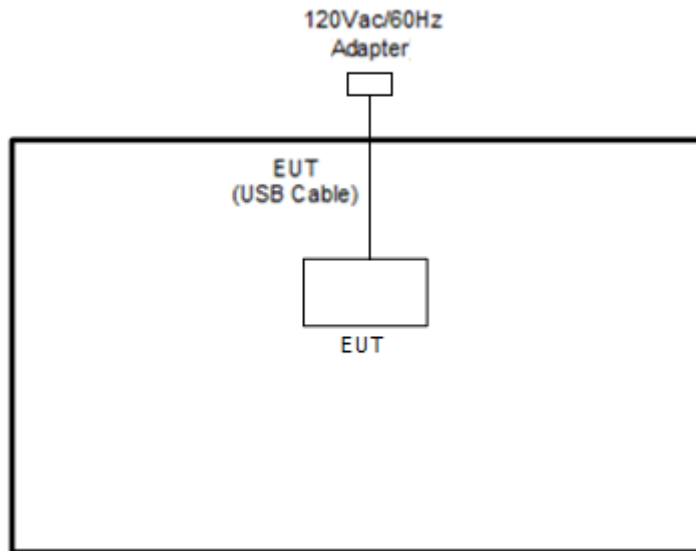

2.4 Support Unit used in test configuration and system

Item	Equipment	Brand Name	Model Name	FCC ID	Data Cable	Power Cord
1.	Adapter	Google	G1000	N/A	N/A	N/A
2.	Bluetooth Earphone	Kinyo	BTE-3622	N/A	N/A	N/A
3.	WLAN AP	ASUS	RT-AC52	N/A	N/A	Unshielded, 1.8 m
4.	Notebook	Dell	P79G	FCC DoC	N/A	AC I/P: Unshielded, 1.2 m DC O/P: Shielded, 1.8 m
5.	USB Cable	Google	GQ6H2	N/A	Unshielded, 0.98 m	N/A

2.5 EUT Operation Test Setup

The RF test items, utility “QRCT Version 4.0.00158.0” was installed in Notebook which was programmed in order to make the EUT get into the engineering modes to provide channel selection, power level, data rate and the application type and for continuous transmitting signals.

2.6 Measurement Results Explanation Example

For all conducted test items:

The offset level is set in the spectrum analyzer to compensate the RF cable loss and attenuator factor between EUT conducted output port and spectrum analyzer. With the offset compensation, the spectrum analyzer reading level is exactly the EUT RF output level.

Example :

The spectrum analyzer offset is derived from RF cable loss and attenuator factor.

Offset = RF cable loss + attenuator factor.

Following shows an offset computation example with cable loss 4.2 dB and 10 dB attenuator.

$$\begin{aligned}
 \text{Offset(dB)} &= \text{RF cable loss(dB)} + \text{attenuator factor(dB)}. \\
 &= 4.2 + 10 = 14.2 \text{ (dB)}
 \end{aligned}$$

3 Test Result

3.1 6dB and 99% Bandwidth Measurement

3.1.1 Limit of 6dB and 99% Bandwidth

The minimum 6 dB bandwidth shall be at least 500 kHz.

3.1.2 Measuring Instruments

Please refer to the measuring equipment list in this test report.

3.1.3 Test Procedures

1. The testing follows the ANSI C63.10 Section 6.9.3 (OBW) and 11.8.1 (6dB BW).
2. The RF output of EUT is connected to the spectrum analyzer by RF cable and attenuator. The path loss is compensated to the results for each measurement.
3. Set the maximum power setting and enable the EUT to transmit continuously.
4. Make the measurement with the spectrum analyzer's resolution bandwidth (RBW) = 100 kHz. Set the Video bandwidth (VBW) = 300 kHz. In order to make an accurate measurement. The 6dB bandwidth must be greater than 500 kHz.
5. For 99% Bandwidth Measurement, the spectrum analyzer's resolution bandwidth (RBW) is set 1-5% of the emission bandwidth and set the Video bandwidth (VBW) $\geq 3 * RBW$.
6. Measure and record the results in the test report.

3.1.4 Test Setup



3.1.5 Test Result of 6dB Bandwidth

Please refer to Appendix A.

3.1.6 Test Result of 99% Occupied Bandwidth

Please refer to Appendix A.

3.2 Output Power Measurement

3.2.1 Limit of Output Power

For systems using digital modulation in the 2400-2483.5 MHz, the limit for output power is 30 dBm. If transmitting antenna of directional gain greater than 6 dBi is used, the peak output power from the intentional radiator shall be reduced below the above stated value by the amount in dB that the directional gain of the antenna exceeds 6 dBi. In case of point-to-point operation, the limit has to be reduced by 1 dB for every 3 dB that the directional gain of the antenna exceeds 6 dBi.

3.2.2 Measuring Instruments

Please refer to the measuring equipment list in this test report.

3.2.3 Test Procedures

1. For Average Power, the testing follows ANSI C63.10 Section 11.9.2.3.2 Method AVGPM-G
2. The RF output of EUT is connected to the power meter by RF cable and attenuator.
3. The path loss is compensated to the results for each measurement.
4. Set the maximum power setting and enable the EUT to transmit continuously.
5. Measure the conducted output power and record the results in the test report.

3.2.4 Test Setup

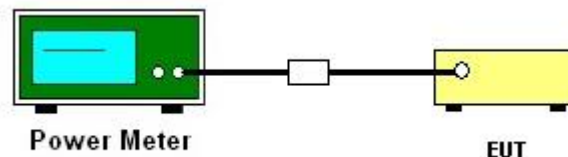

3.2.5 Test Result of Average Output Power

Please refer to Appendix A.

3.3 Power Spectral Density Measurement

3.3.1 Limit of Power Spectral Density

The peak power spectral density shall not be greater than 8 dBm in any 3 kHz band at any time interval of continuous transmission.

3.3.2 Measuring Instruments

Please refer to the measuring equipment list in this test report.

3.3.3 Test Procedures

1. The testing follows the ANSI C63.10 Section 11.10.2 Method PKPSD.
2. The RF output of EUT is connected to the spectrum analyzer by RF cable and attenuator. The path loss is compensated to the results for each measurement.
3. Set the maximum power setting and enable the EUT to transmit continuously.
4. Make the measurement with the spectrum analyzer's resolution bandwidth (RBW) = 3 kHz. Video bandwidth (VBW) = 10 kHz. In order to make an accurate measurement, set the span to 1.5 times DTS Channel Bandwidth. (6 dB BW)
5. Detector = peak, Sweep time = auto couple, Trace mode = max hold, Allow trace to fully stabilize. Use the peak marker function to determine the maximum power level.
6. Measure and record the results in the test report.
7. The Measured power density (dBm)/ 100 kHz is a reference level and is used as 20 dBc down limit line for Conducted Band Edges and Conducted Spurious Emission.

3.3.4 Test Setup



3.3.5 Test Result of Power Spectral Density

Please refer to Appendix A.

3.4 Conducted Band Edges and Spurious Emission Measurement

3.4.1 Limit of Conducted Band Edges and Spurious Emission

All harmonics/spurious must be at least 30 dB down from the highest emission level within the authorized band.

3.4.2 Measuring Instruments

Please refer to the measuring equipment list in this test report.

3.4.3 Test Procedure

1. The testing follows the ANSI C63.10 Section 11.11.3 Emission level measurement.
2. The RF output of EUT is connected to the spectrum analyzer by RF cable and attenuator. The path loss is compensated to the results for each measurement.
3. Set the maximum power setting and enable the EUT to transmit continuously.
4. Set RBW = 100 kHz, VBW = 300 kHz, Peak Detector. Unwanted Emissions measured in any 100 kHz bandwidth outside of the authorized frequency band shall be attenuated by at least 20 dB relative to the maximum in-band peak PSD level in 100 kHz when maximum peak conducted output power procedure is used. If the transmitter complies with the conducted power limits based on the use of RMS averaging over a time interval, the attenuation required under this paragraph shall be 30 dB instead of 20 dB.
5. Measure and record the results in the test report.
6. The RF fundamental frequency should be excluded against the limit line in the operating frequency band.

3.4.4 Test Setup



3.4.5 Test Result of Conducted Band Edges Plots

Please refer to Appendix A.

3.4.6 Test Result of Conducted Spurious Emission Plots

Please refer to Appendix A.



3.5 Radiated Band Edges and Spurious Emission Measurement

3.5.1 Limit of Radiated Band Edges and Spurious Emission

In any 100 kHz bandwidth outside the intentional radiator frequency band, all harmonics/spurious must be at least 20 dB below the highest emission level within the authorized band. If the output power of this device is measured by spectrum analyzer, the attenuation under this paragraph shall be 30 dB instead of 20 dB. In addition, radiated emissions which fall in the restricted bands must also comply with the limits as below.

Frequency (MHz)	Field Strength (microvolts/meter)	Measurement Distance (meters)
0.009 – 0.490	2400/F(kHz)	300
0.490 – 1.705	24000/F(kHz)	30
1.705 – 30.0	30	30
30 – 88	100	3
88 – 216	150	3
216 - 960	200	3
Above 960	500	3

3.5.2 Measuring Instruments

Please refer to the measuring equipment list in this test report.

**3.5.3 Test Procedures**

1. The testing follows the ANSI C63.10 Section 11.12.1 Radiated emission measurements.
2. The EUT is arranged to its worst case and then tune the antenna tower (from 1 m to 4 m) and turntable (from 0 degree to 360 degrees) to find the maximum reading. A pre-amp and a high pass filter are used for the test in order to get better signal level.
3. The EUT is placed on a turntable with 0.8 meter for frequency below 1 GHz and 1.5 meter for frequency above 1 GHz respectively above ground.
4. The EUT is set 3 meters away from the receiving antenna, which is mounted on the top of a variable height antenna tower.
5. Corrected Reading: Antenna Factor + Cable Loss + Read Level - Preamp Factor = Level
6. Radiated testing below 1 GHz is performed by adjusting the antenna tower from 1 m to 4 m and by rotating the turn table from 0 degree to 360 degrees to find the peak maximum hold reading. When there is no suspected emission found and the emission level is with at least 6 dB margin against QP limit line, the position is marked as “-“.
7. Radiated testing above 1 GHz is performed by adjusting the antenna tower from 1 m to 4 m and by rotating the turn table from 0 degree to 360 degrees to find the peak maximum hold reading for scanning all frequencies. When there is no suspected emission found and the harmonic emission level is with at least 6 dB margin against average limit line, the position is marked as “-“.
8. Use the following spectrum analyzer settings:
 - (1) Span shall wide enough to fully capture the emission being measured;
 - (2) Set RBW = 100 kHz for $f < 1$ GHz; $VBW \geq RBW$; Sweep = auto; Detector function = peak; Trace = max hold;
 - (3) Set RBW = 1 MHz, $VBW = 3$ MHz for $f \geq 1$ GHz for peak measurement.
For average measurement:
 - $VBW = 10$ Hz, when duty cycle is no less than 98 percent.
 - $VBW \geq 1/T$, when duty cycle is less than 98 percent where T is the minimum transmission duration over which the transmitter is on and is transmitting at its maximum power control level for the tested mode of operation.

3.5.4 Test Setup

For radiated test below 30MHz

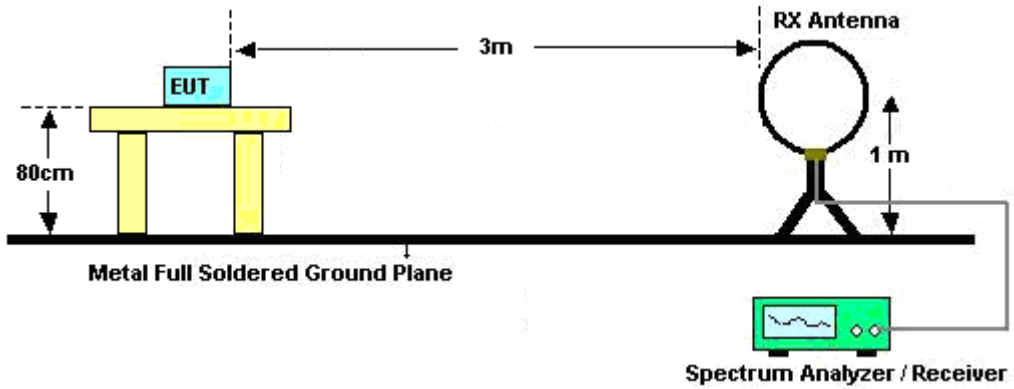

For radiated test from 30MHz to 1GHz

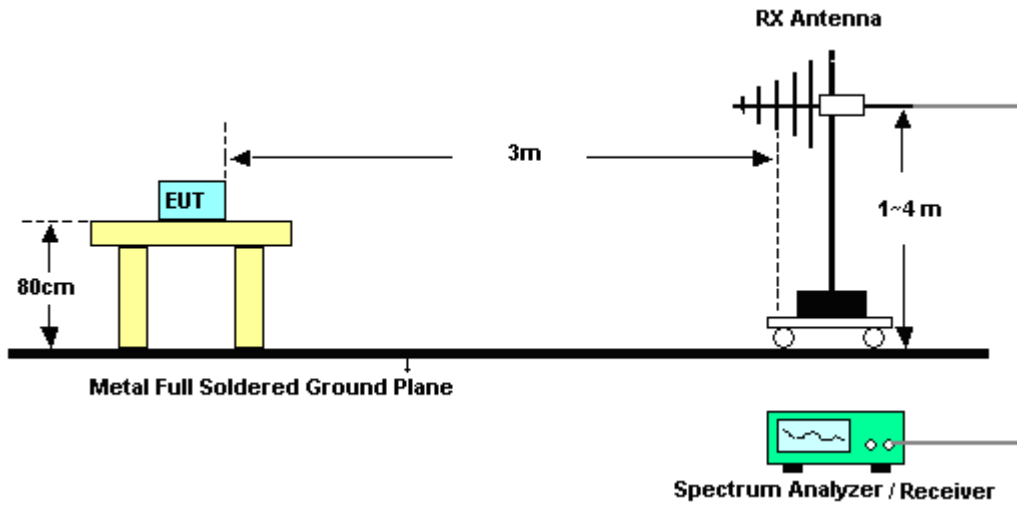

For radiated test from 1GHz to 18GHz

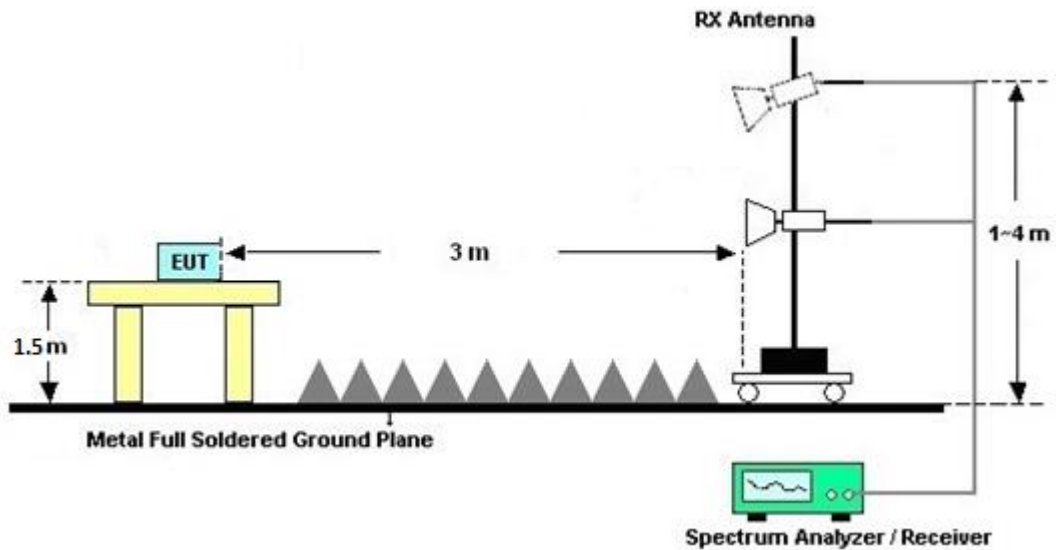

For radiated test above 18GHz

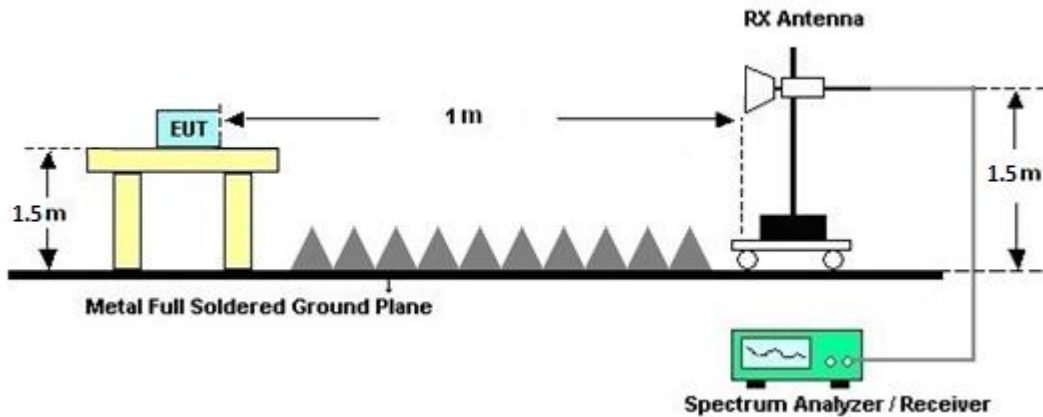

3.5.5 Test Results of Radiated Spurious Emissions (9 kHz ~ 30 MHz)

The low frequency, which starts from 9 kHz to 30 MHz, is pre-scanned and the result which is 20 dB lower than the limit line is not reported.

There is adequate comparison measurement of both open-field test site and alternative test site - semi-Anechoic chamber according to 414788 D01 Radiated Test Site v01r01, and the result comes out very similar.

3.5.6 Test Result of Radiated Spurious at Band Edges

Please refer to Appendix C and D.

3.5.7 Duty Cycle

Please refer to Appendix E.

3.5.8 Test Result of Radiated Spurious Emission (30 MHz ~ 10th Harmonic)

Please refer to Appendix C and D.



3.6 AC Conducted Emission Measurement

3.6.1 Limit of AC Conducted Emission

For equipment that is designed to be connected to the public utility (AC) power line, the radio frequency voltage that is conducted back onto the AC power line on any frequency or frequencies within the band 150 kHz to 30 MHz shall not exceed the limits in the following table.

Frequency of emission (MHz)	Conducted limit (dB μ V)	
	Quasi-peak	Average
0.15-0.5	66 to 56*	56 to 46*
0.5-5	56	46
5-30	60	50

*Decreases with the logarithm of the frequency.

3.6.2 Measuring Instruments

Please refer to the measuring equipment list in this test report.

3.6.3 Test Procedures

1. The EUT is placed 0.4 meter away from the conducting wall of the shielding room, and is kept at least 80 centimeters from any other grounded conducting surface.
2. Connect EUT to the power mains through a line impedance stabilization network (LISN).
3. All the support units are connecting to the other LISN.
4. The LISN provides 50 ohm coupling impedance for the measuring instrument.
5. The FCC states that a 50 ohm, 50 microhenry LISN shall be used.
6. Both Line and Neutral shall be tested in order to find out the maximum conducted emission.
7. The frequency range from 150 kHz to 30 MHz is scanned.
8. Set the test-receiver system to Peak Detect Function and specified bandwidth (IF Bandwidth = 9 kHz) with Maximum Hold Mode. Then measurement is also conducted by Average Detector and Quasi-Peak Detector Function respectively.

3.6.4 Test Setup



3.6.5 Test Result of AC Conducted Emission

Please refer to Appendix B.



3.7 Antenna Requirements

3.7.1 Standard Applicable

The use of a permanently attached antenna or of an antenna that uses a unique coupling to the intentional radiator shall be considered sufficient to comply with the rule.

3.7.2 Antenna Anti-Replacement Construction

An embedded-in antenna design is used.



4 List of Measuring Equipment

Instrument	Brand Name	Model No.	Serial No.	Characteristics	Calibration Date	Test Date	Due Date	Remark
EMI Test Receiver	Keysight	N9038A	MY59053012	N/A	Nov. 18, 2022	Apr. 21, 2023~ May 04, 2023	Nov. 17, 2023	Radiation (03CH20-HY)
Signal Analyzer	Keysight	N9010B	MY60241058	N/A	Jul. 07, 2022	Apr. 21, 2023~ May 04, 2023	Jul. 06, 2023	Radiation (03CH20-HY)
Preamplifier	COM-POWER	PAM-103	18020201	1MHz-1000MHz	Jan. 02, 2023	Apr. 21, 2023~ May 04, 2023	Jan. 01, 2024	Radiation (03CH20-HY)
Amplifier	EMCI	EMC118A45SE	980792	N/A	Nov. 14, 2022	Apr. 21, 2023~ May 04, 2023	Nov. 13, 2023	Radiation (03CH20-HY)
Preamplifier	EMEC	EM18G40G	060801	18GHz~40GHz	Jun. 28, 2022	Apr. 21, 2023~ May 04, 2023	Jun. 27, 2023	Radiation (03CH20-HY)
Loop Antenna	Rohde & Schwarz	HFH2-Z2	100488	9 kHz~30 MHz	Sep. 20, 2022	Apr. 21, 2023~ May 04, 2023	Sep. 19, 2023	Radiation (03CH20-HY)
Bilog Antenna	TESEQ	CBL 6111D&00802N 1D01N-06	55606 & 08	30MHz~1GHz	Oct. 22, 2022	Apr. 21, 2023~ May 04, 2023	Oct. 21, 2023	Radiation (03CH20-HY)
Horn Antenna	SCHWARZBECK	BBHA 9120 D	02360	1GHz~18GHz	Nov. 04, 2022	Apr. 21, 2023~ May 04, 2023	Nov. 03, 2023	Radiation (03CH20-HY)
SHF-EHF Horn Antenna	SCHWARZBECK	BBHA9170	00994	18GHz-40GHz	Nov. 04, 2022	Apr. 21, 2023~ May 04, 2023	Nov. 03, 2023	Radiation (03CH20-HY)
Hygrometer	TECPEL	DTM-302	SN3	N/A	Sep. 28, 2022	Apr. 21, 2023~ May 04, 2023	Sep. 27, 2023	Radiation (03CH20-HY)
RF Cable	HUBER + SUHNER	SUCOFLEX 102	519229/2,804 015/2,804027 /2	N/A	Jan. 18, 2023	Apr. 21, 2023~ May 04, 2023	Jan. 17, 2024	Radiation (03CH20-HY)
Software	Audix	E3 6.2009-8-24	RK-002156	N/A	N/A	Apr. 21, 2023~ May 04, 2023	N/A	Radiation (03CH20-HY)
Antenna Mast	EMEC	AM-BS-4500-B	N/A	1m~4m	N/A	Apr. 21, 2023~ May 04, 2023	N/A	Radiation (03CH20-HY)
Turn Table	EMEC	TT2000	N/A	0~360 Degree	N/A	Apr. 21, 2023~ May 04, 2023	N/A	Radiation (03CH20-HY)
Controller	EMEC	EM1000	N/A	Control Turn table & Ant Mast	N/A	Apr. 21, 2023~ May 04, 2023	N/A	Radiation (03CH20-HY)
Hygrometer	TECPEL	DTM-303A	TP201996	N/A	Nov. 17, 2022	Mar. 29, 2023~ Apr. 13, 2023	Nov. 16, 2023	Conducted (TH05-HY)
Power Sensor	DARE	RPR3006W	16100054SNO 12 (NO:113)	10MHz~6GHz	Dec. 13, 2022	Mar. 29, 2023~ Apr. 13, 2023	Dec. 12, 2023	Conducted (TH05-HY)
Signal Analyzer	Rohde & Schwarz	FSV40	101905	10Hz - 40GHz(amp)	Aug. 03, 2022	Mar. 29, 2023~ Apr. 13, 2023	Aug. 02, 2023	Conducted (TH05-HY)
Power Divider	Woken	2Way SMA Divider	DCMB1KW7A 1	0.5~18GHz	Jan. 26, 2023	Mar. 29, 2023~ Apr. 13, 2023	Jan. 25, 2024	Conducted (TH05-HY)
RF Cable	EM Electronics	SS402_1M	#29	0.5~18GHz	Jan. 26, 2023	Mar. 29, 2023~ Apr. 13, 2023	Jan. 25, 2024	Conducted (TH05-HY)
RF Cable	EM Electronics	SS402_1M	#30	0.5~18GHz	Jan. 26, 2023	Mar. 29, 2023~ Apr. 13, 2023	Jan. 25, 2024	Conducted (TH05-HY)
Attenuator	Woken	20dB 18GHz_5W	#1	0.5~18GHz	Jan. 26, 2023	Mar. 29, 2023~ Apr. 13, 2023	Jan. 25, 2024	Conducted (TH05-HY)
AC Power Source	ACPOWER	AFC-11003G	F317040033	N/A	N/A	Mar. 28, 2023	N/A	Conduction (CO07-HY)
Software	Rohde & Schwarz	EMC32 V10.30	N/A	N/A	N/A	Mar. 28, 2023	N/A	Conduction (CO07-HY)
Pulse Limiter	SCHWARZBECK	VTSD 9561-F N	9561-F N00373	9kHz-200MHz	Nov. 01, 2022	Mar. 28, 2023	Oct. 31, 2023	Conduction (CO07-HY)
RF Cable	HUBER + SUHNER	RG 214/U	1358175	9kHz~30MHz	Mar. 15, 2023	Mar. 28, 2023	Mar. 14, 2024	Conduction (CO07-HY)
Two-Line V-Network	TESEQ	NNB 51	45051	N/A	Mar. 05, 2023	Mar. 28, 2023	Mar. 04, 2024	Conduction (CO07-HY)
Four-Line V-Network	TESEQ	NNB 52	36122	N/A	Mar. 13, 2023	Mar. 28, 2023	Mar. 12, 2024	Conduction (CO07-HY)
EMI Test Receiver	Rohde & Schwarz	ESR3	102317	9kHz~3.6GHz	Oct. 06, 2022	Mar. 28, 2023	Oct. 05, 2023	Conduction (CO07-HY)



5 Measurement Uncertainty

Uncertainty of Conducted Emission Measurement (150 kHz ~ 30 MHz)

Measuring Uncertainty for a Level of Confidence of 95% ($U = 2Uc(y)$)	3.46 dB
---	---------

Uncertainty of Radiated Emission Measurement (30 MHz ~ 1000 MHz)

Measuring Uncertainty for a Level of Confidence of 95% ($U = 2Uc(y)$)	6.5 dB
---	--------

Uncertainty of Radiated Emission Measurement (1000 MHz ~ 6000 MHz)

Measuring Uncertainty for a Level of Confidence of 95% ($U = 2Uc(y)$)	4.3 dB
---	--------

Uncertainty of Radiated Emission Measurement (6000 MHz ~ 18000 MHz)

Measuring Uncertainty for a Level of Confidence of 95% ($U = 2Uc(y)$)	4.8 dB
---	--------

Uncertainty of Radiated Emission Measurement (18000 MHz ~ 40000 MHz)

Measuring Uncertainty for a Level of Confidence of 95% ($U = 2Uc(y)$)	5.4 dB
---	--------

Appendix A. Test Result of Conducted Test Items

Test Engineer:	Willy Chang / Hank Hsu	Temperature:	21~25	°C
Test Date:	2023/3/29~2023/4/13	Relative Humidity:	51~54	%

TEST RESULTS DATA
6dB and 99% Occupied Bandwidth

Mod.	Data Rate	NTX	CH.	Freq. (MHz)	99% Occupied BW (MHz)	6dB BW (MHz)	6dB BW Limit (MHz)	Pass/Fail
BLE	1Mbps	1	0	2402	1.017	0.672	0.50	Pass
BLE	1Mbps	1	19	2440	1.019	0.668	0.50	Pass
BLE	1Mbps	1	39	2480	1.021	0.666	0.50	Pass

TEST RESULTS DATA
Average Power Table

Mod.	Data Rate	NTX	CH.	Freq. (MHz)	Average Conducted Power (dBm)	Conducted Power Limit (dBm)	DG (dBi)	EIRP Power (dBm)	EIRP Power Limit (dBm)	Pass /Fail
BLE	1Mbps	1	0	2402	17.90	30.00	-5.90	12.00	36.00	Pass
BLE	1Mbps	1	19	2440	18.90	30.00	-5.90	13.00	36.00	Pass
BLE	1Mbps	1	39	2480	16.40	30.00	-5.90	10.50	36.00	Pass

TEST RESULTS DATA
Peak Power Density

Mod.	Data Rate	NTX	CH.	Freq. (MHz)	Peak PSD (dBm /100kHz)	Peak PSD (dBm /3kHz)	DG (dBi)	Peak PSD Limit (dBm /3kHz)	Pass/Fail
BLE	1Mbps	1	0	2402	17.62	1.52	-5.90	8.00	Pass
BLE	1Mbps	1	19	2440	18.42	2.31	-5.90	8.00	Pass
BLE	1Mbps	1	39	2480	16.85	0.66	-5.90	8.00	Pass

Note: PSD (dBm/ 100kHz) is a reference level used for Conducted Band Edges and Conducted Spurious Emission 30dBc limit.

TEST RESULTS DATA
6dB and 99% Occupied Bandwidth

Mod.	Data Rate	NTX	CH.	Freq. (MHz)	99% Occupied BW (MHz)	6dB BW (MHz)	6dB BW Limit (MHz)	Pass/Fail
BLE	2Mbps	1	0	2402	2.022	1.156	0.50	Pass
BLE	2Mbps	1	19	2440	2.026	1.156	0.50	Pass
BLE	2Mbps	1	39	2480	2.030	1.156	0.50	Pass

TEST RESULTS DATA
Average Power Table

Mod.	Data Rate	NTX	CH.	Freq. (MHz)	Average Conducted Power (dBm)	Conducted Power Limit (dBm)	DG (dBi)	EIRP Power (dBm)	EIRP Power Limit (dBm)	Pass /Fail
BLE	2Mbps	1	0	2402	18.10	30.00	-5.90	12.20	36.00	Pass
BLE	2Mbps	1	19	2440	19.10	30.00	-5.90	13.20	36.00	Pass
BLE	2Mbps	1	39	2480	16.60	30.00	-5.90	10.70	36.00	Pass

TEST RESULTS DATA
Peak Power Density

Mod.	Data Rate	NTX	CH.	Freq. (MHz)	Peak PSD (dBm /100kHz)	Peak PSD (dBm /3kHz)	DG (dBi)	Peak PSD Limit (dBm /3kHz)	Pass/Fail
BLE	2Mbps	1	0	2402	17.86	-0.68	-5.90	8.00	Pass
BLE	2Mbps	1	19	2440	18.85	0.32	-5.90	8.00	Pass
BLE	2Mbps	1	39	2480	17.35	-1.29	-5.90	8.00	Pass

Note: PSD (dBm/ 100kHz) is a reference level used for Conducted Band Edges and Conducted Spurious Emission 30dBc limit.



<2Mbps>

6 dB Bandwidth Plot on Channel 00

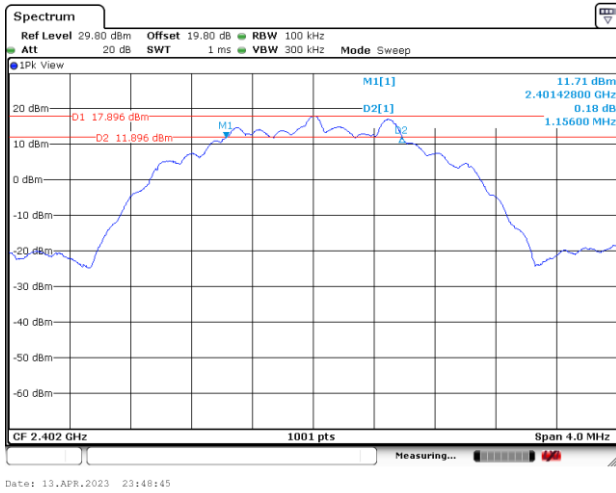

6 dB Bandwidth Plot on Channel 19

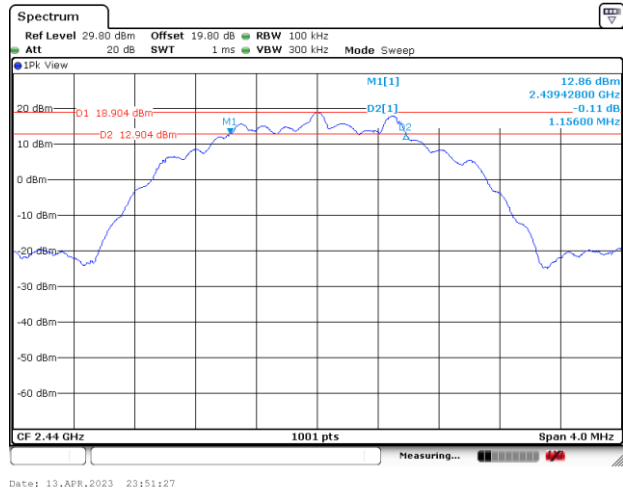

6 dB Bandwidth Plot on Channel 39

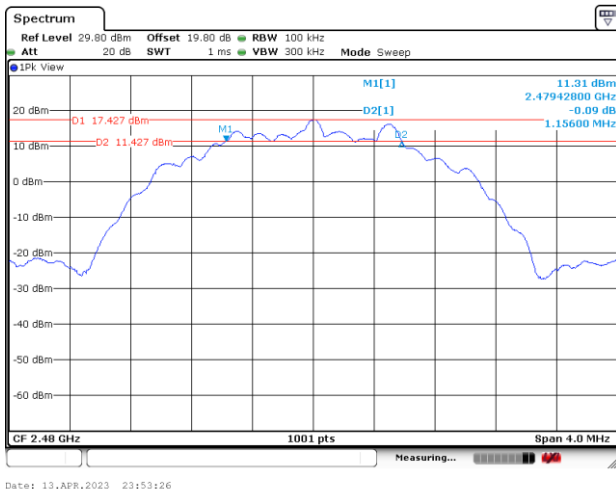



99% Occupied Bandwidth

<1Mbps>

99% Occupied Bandwidth Plot on Channel 00

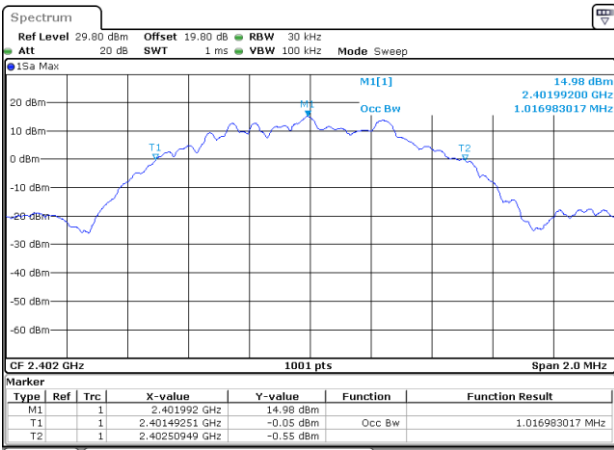

Date: 13.APR.2023 23:34:24

99% Occupied Plot Bandwidth on Channel 19

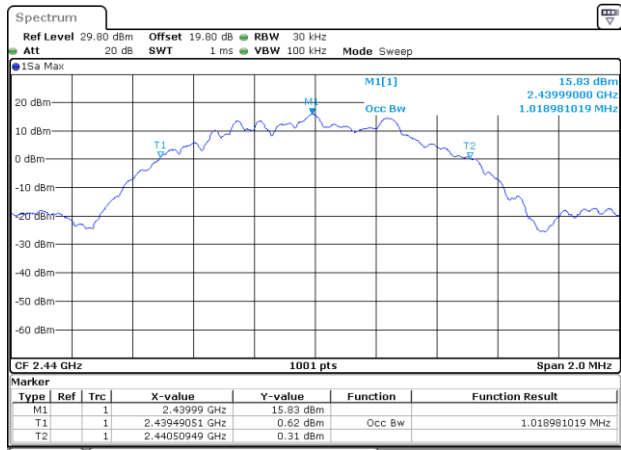

Date: 13.APR.2023 23:37:44

99% Occupied Bandwidth Plot on Channel 39

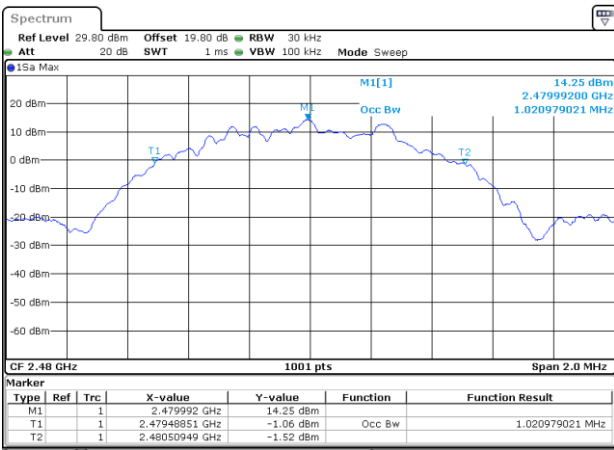

Date: 13.APR.2023 23:40:08

Note: The occupied channel bandwidth is maintained within the band of operation for all of the modulations.



<2Mbps>

99% Occupied Bandwidth Plot on Channel 00

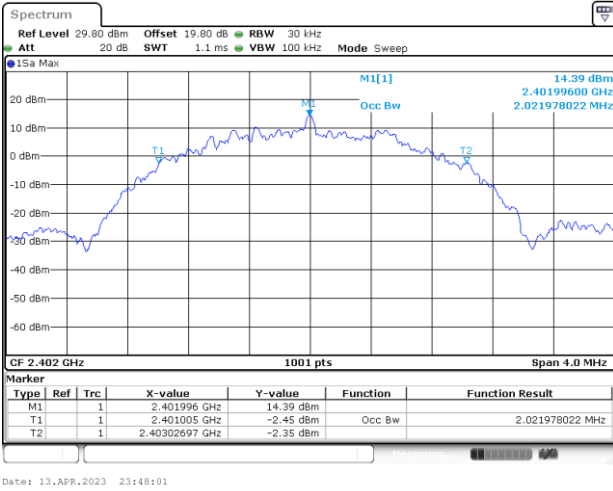

99% Occupied Plot Bandwidth on Channel 19

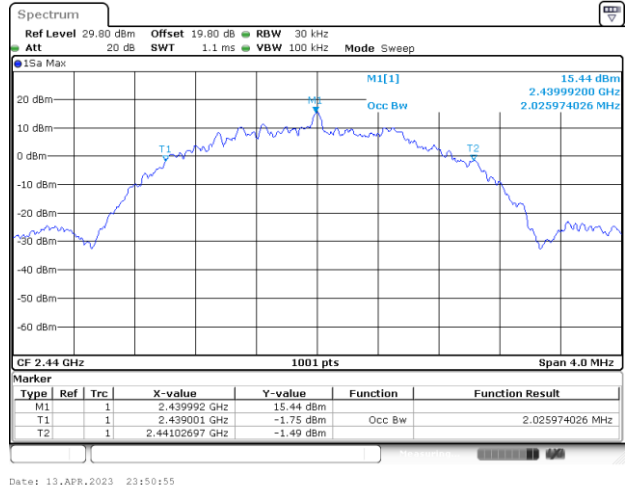

99% Occupied Bandwidth Plot on Channel 39

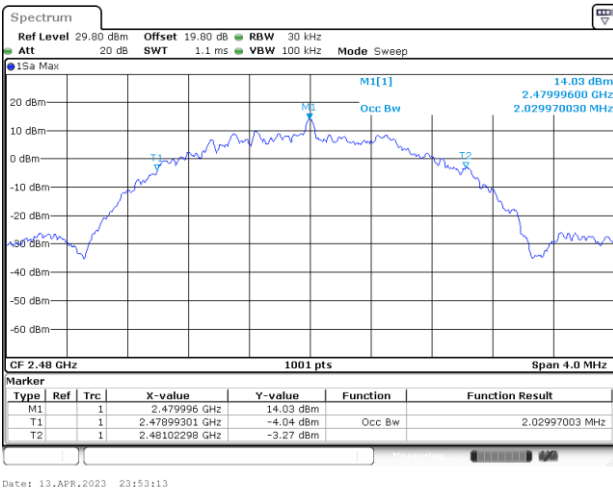

Note: The occupied channel bandwidth is maintained within the band of operation for all of the modulations.



Power Spectral Density (dBm/3kHz)

<1Mbps>

Power Density (dBm/3kHz) Plot Channel 00

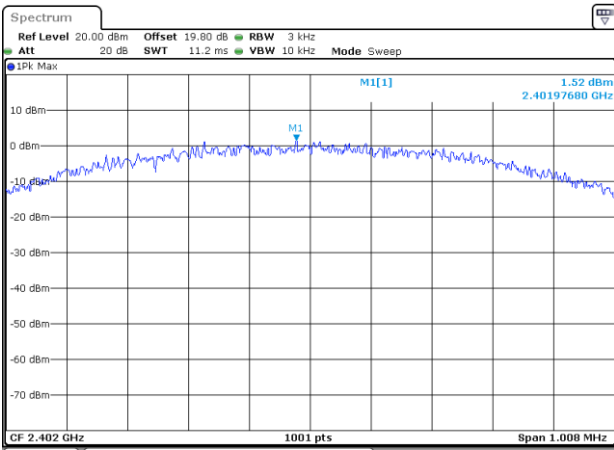

Date: 13.APR.2023 23:35:08

Power Density (dBm/3kHz) Plot Channel 19

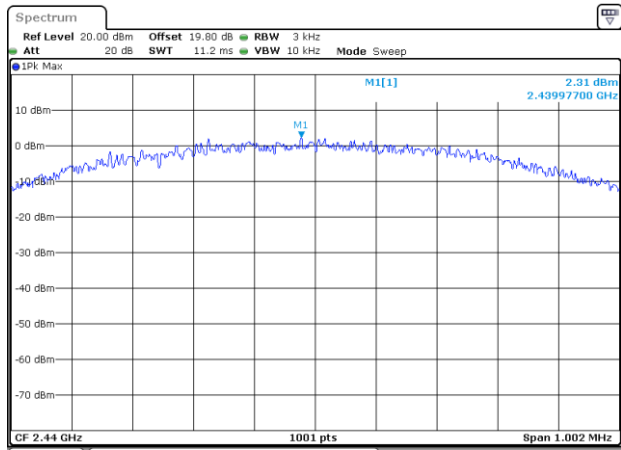

Date: 13.APR.2023 23:38:20

Power Density (dBm/3kHz) Plot Channel 39

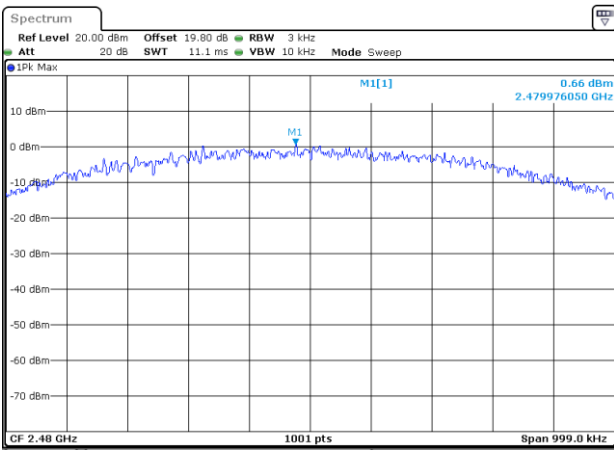

Date: 13.APR.2023 23:40:35



<2Mbps>

Power Density (dBm/3kHz) Plot Channel 00

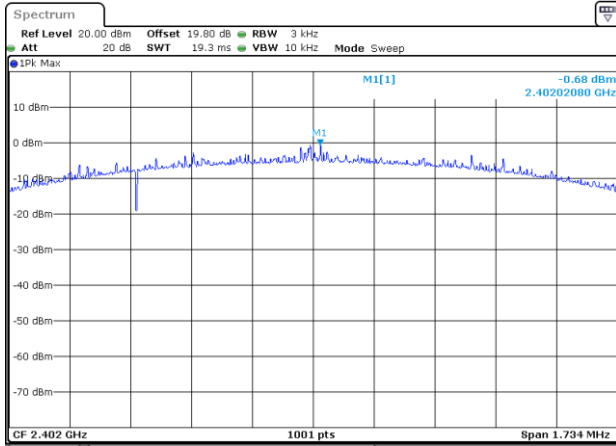

Date: 13.APR.2023 23:48:59

Power Density (dBm/3kHz) Plot Channel 19

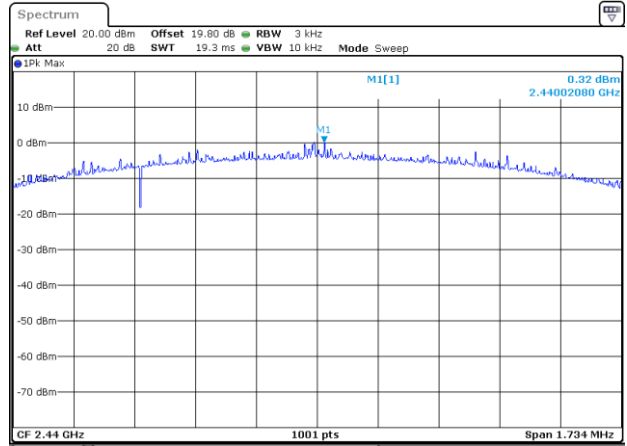

Date: 13.APR.2023 23:51:44

Power Density (dBm/3kHz) Plot Channel 39

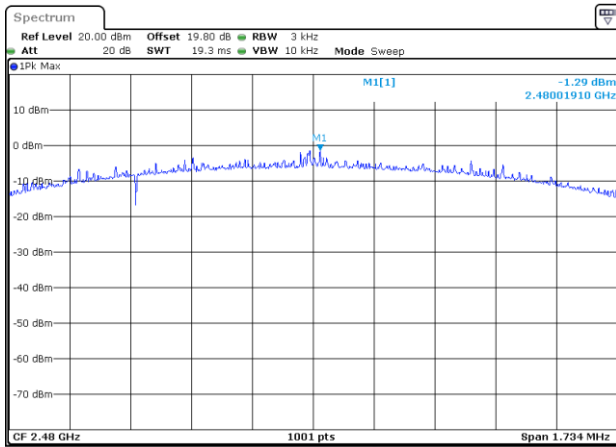

Date: 13.APR.2023 23:53:45



Band Edge and Spurious Emission

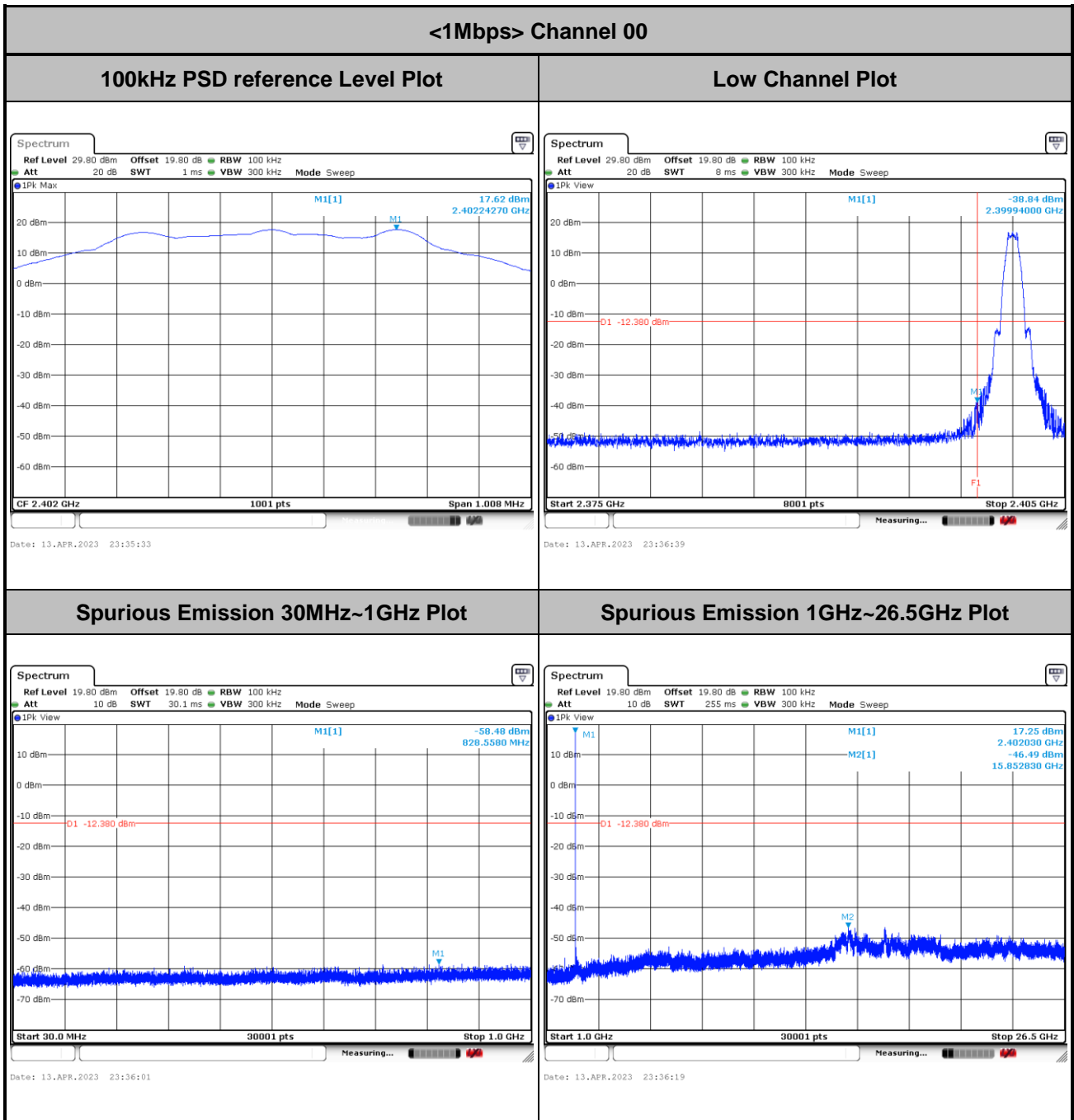



<1Mbps> Channel 19

100kHz PSD reference Level Plot

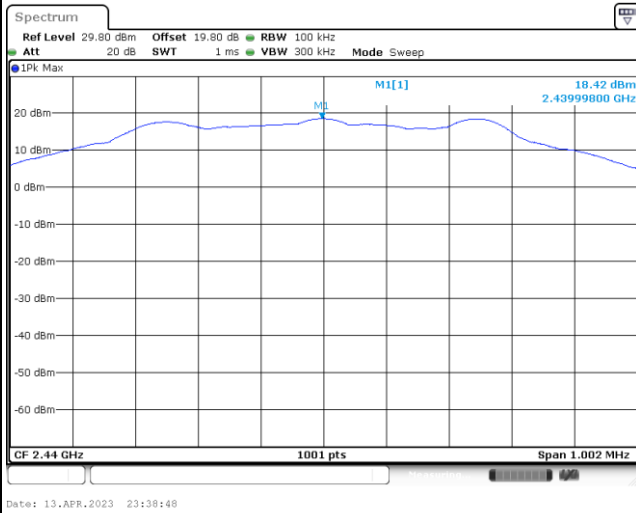

Low Channel Plot

Spurious Emission 30MHz~1GHz Plot

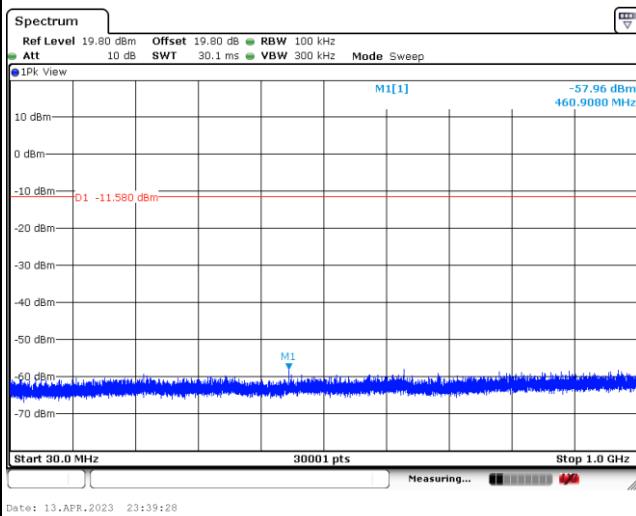

Spurious Emission 1GHz~26.5GHz Plot

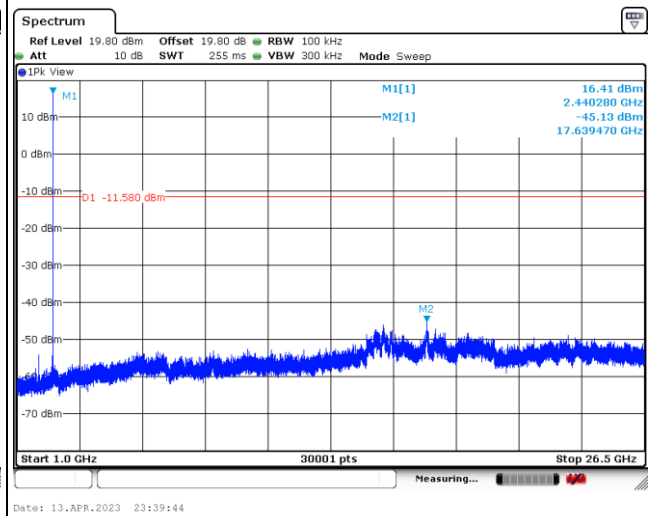



<1Mbps> Channel 39

100kHz PSD reference Level Plot

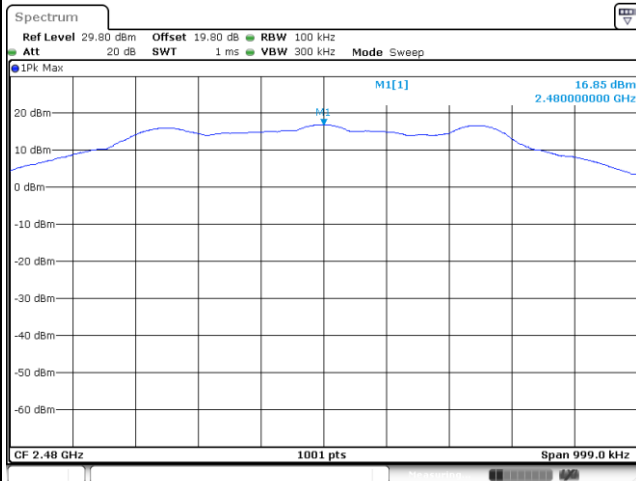

Date: 13.APR.2023 23:41:04

Low Channel Plot

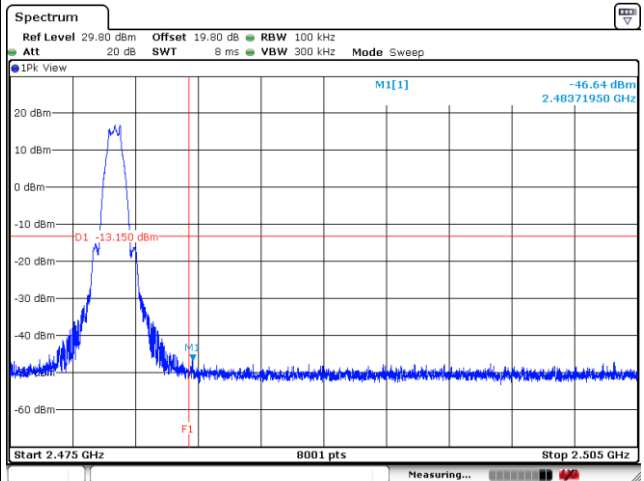

Date: 13.APR.2023 23:42:10

Spurious Emission 30MHz~1GHz Plot

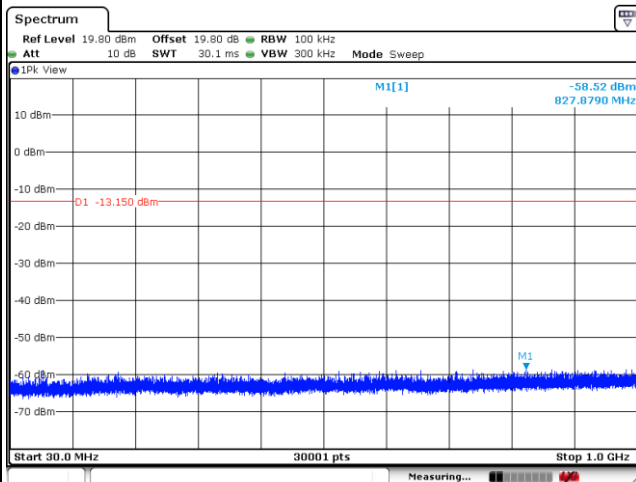

Date: 13.APR.2023 23:41:27

Spurious Emission 1GHz~26.5GHz Plot

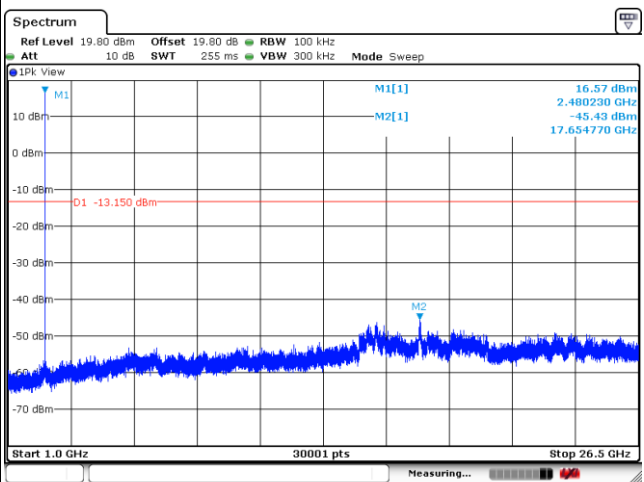

Date: 13.APR.2023 23:41:46



<2Mbps> Channel 00

100kHz PSD reference Level Plot

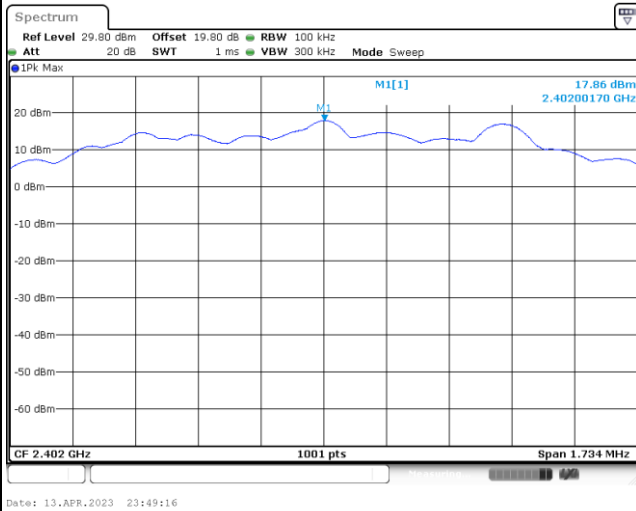

Low Channel Plot

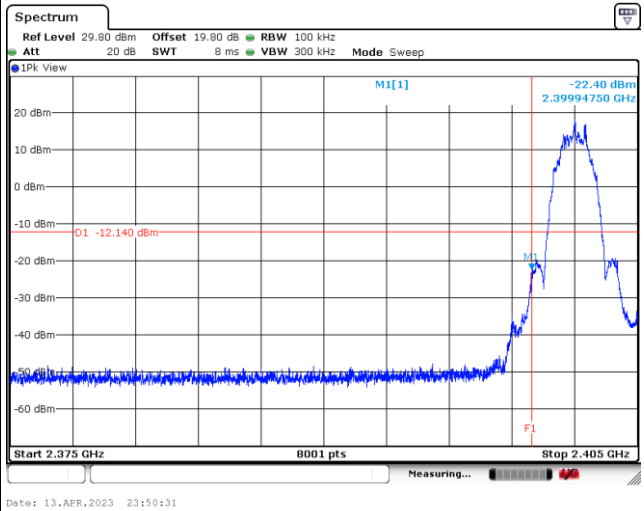

Spurious Emission 30MHz~1GHz Plot

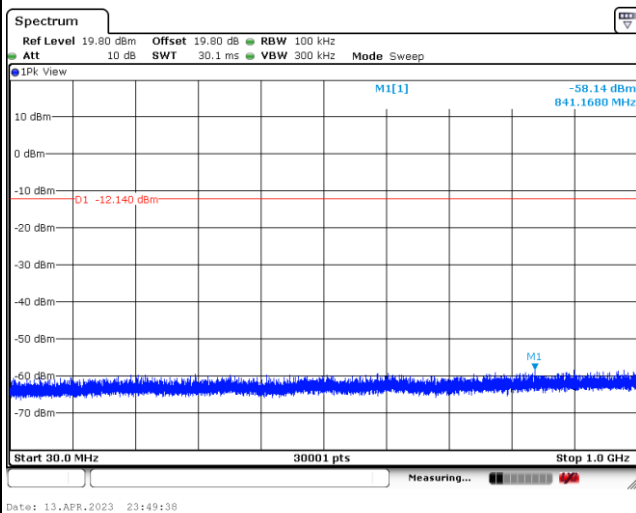

Spurious Emission 1GHz~26.5GHz Plot

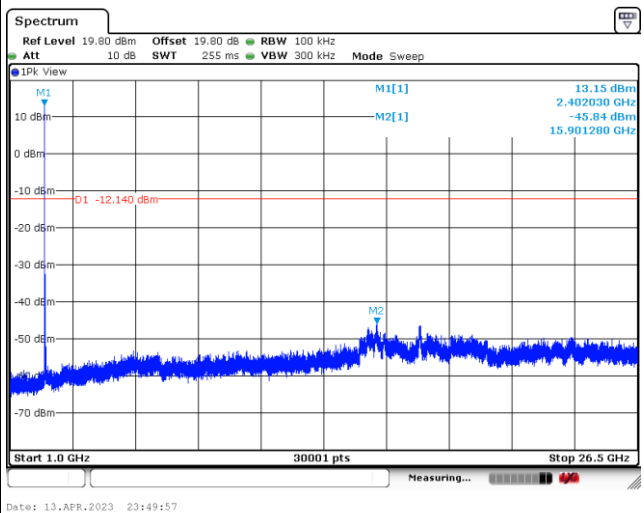



<2Mbps> Channel 19

100kHz PSD reference Level Plot

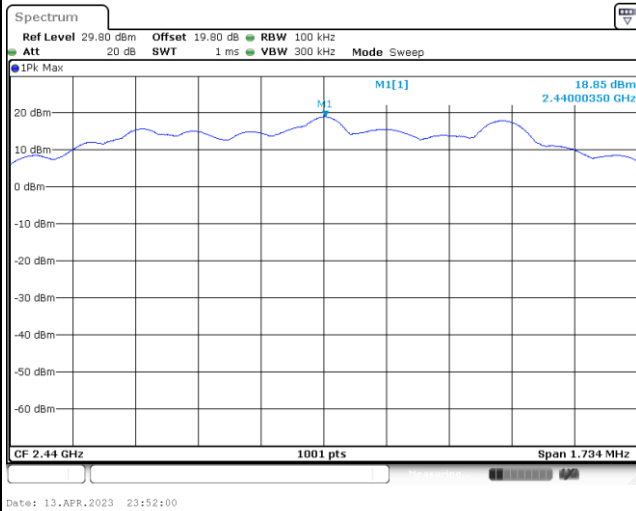

Low Channel Plot

Spurious Emission 30MHz~1GHz Plot

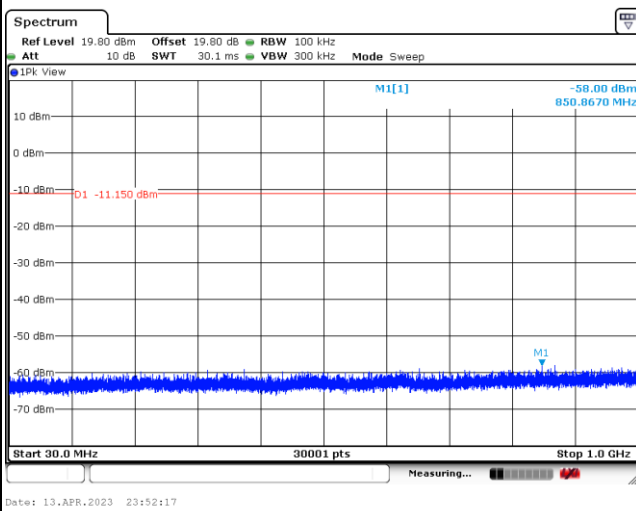

Spurious Emission 1GHz~26.5GHz Plot

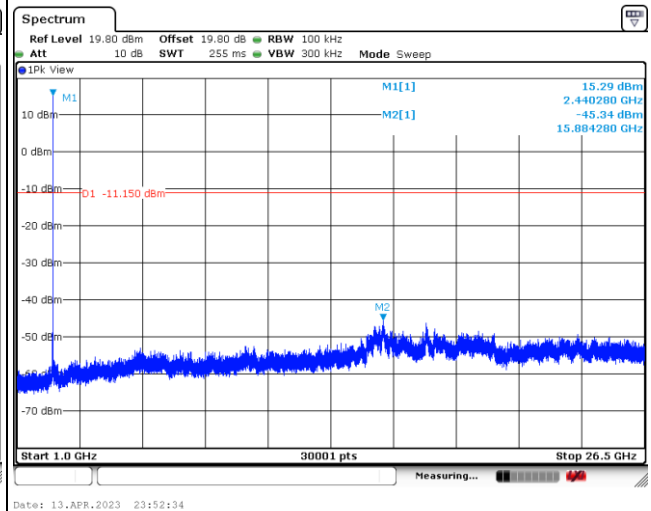



<2Mbps> Channel 39

100kHz PSD reference Level Plot

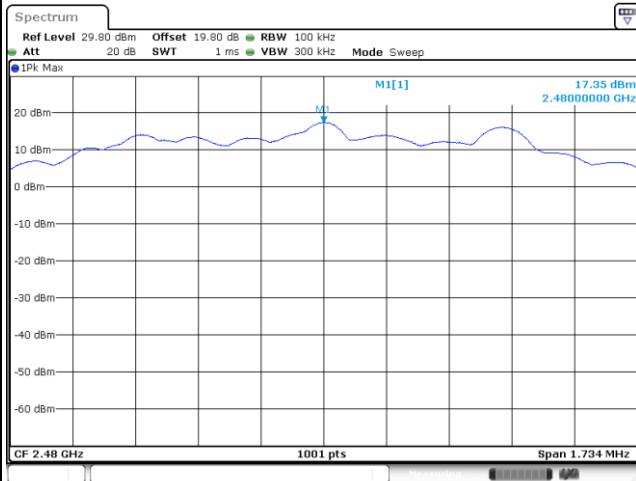

Date: 13.APR.2023 23:54:05

Low Channel Plot

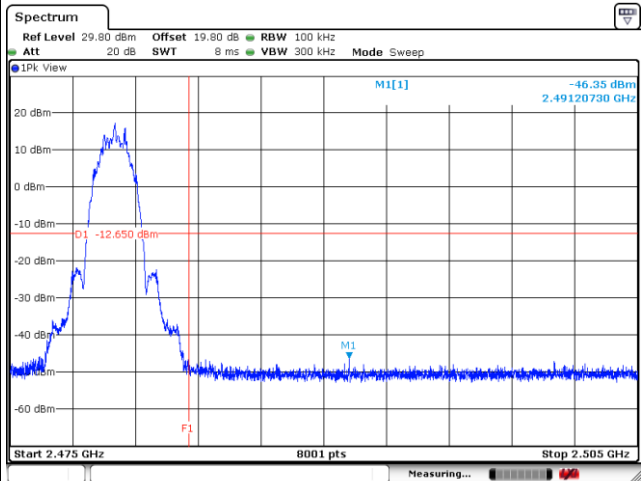

Date: 13.APR.2023 23:55:04

Spurious Emission 30MHz~1GHz Plot

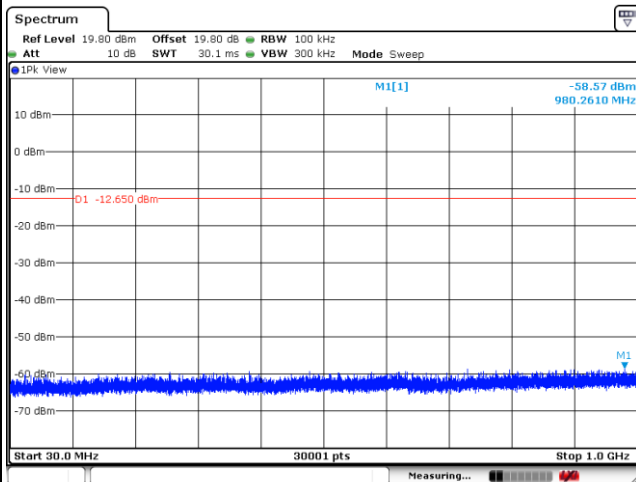

Date: 13.APR.2023 23:54:25

Spurious Emission 1GHz~26.5GHz Plot

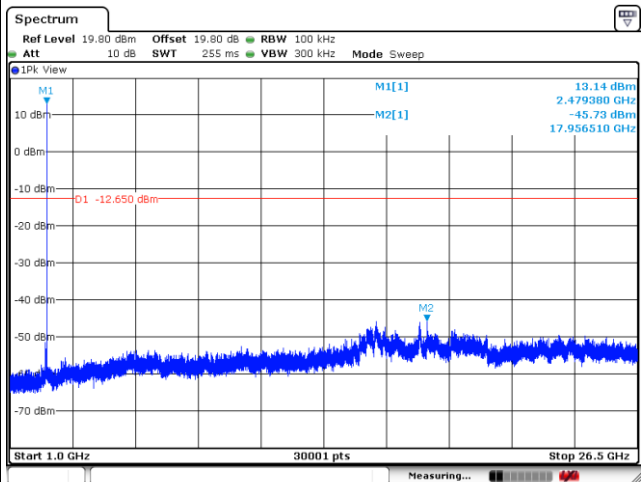

Date: 13.APR.2023 23:54:42



Appendix B. AC Conducted Emission Test Results

Test Engineer :	Louis Chung	Temperature :	21.5~25.5°C
		Relative Humidity :	59.7~63.4%

EUT Information

Report NO : 330714
 Test Mode : Mode 1
 Test Voltage : 120Vac/60Hz
 Phase : Line

Full Spectrum

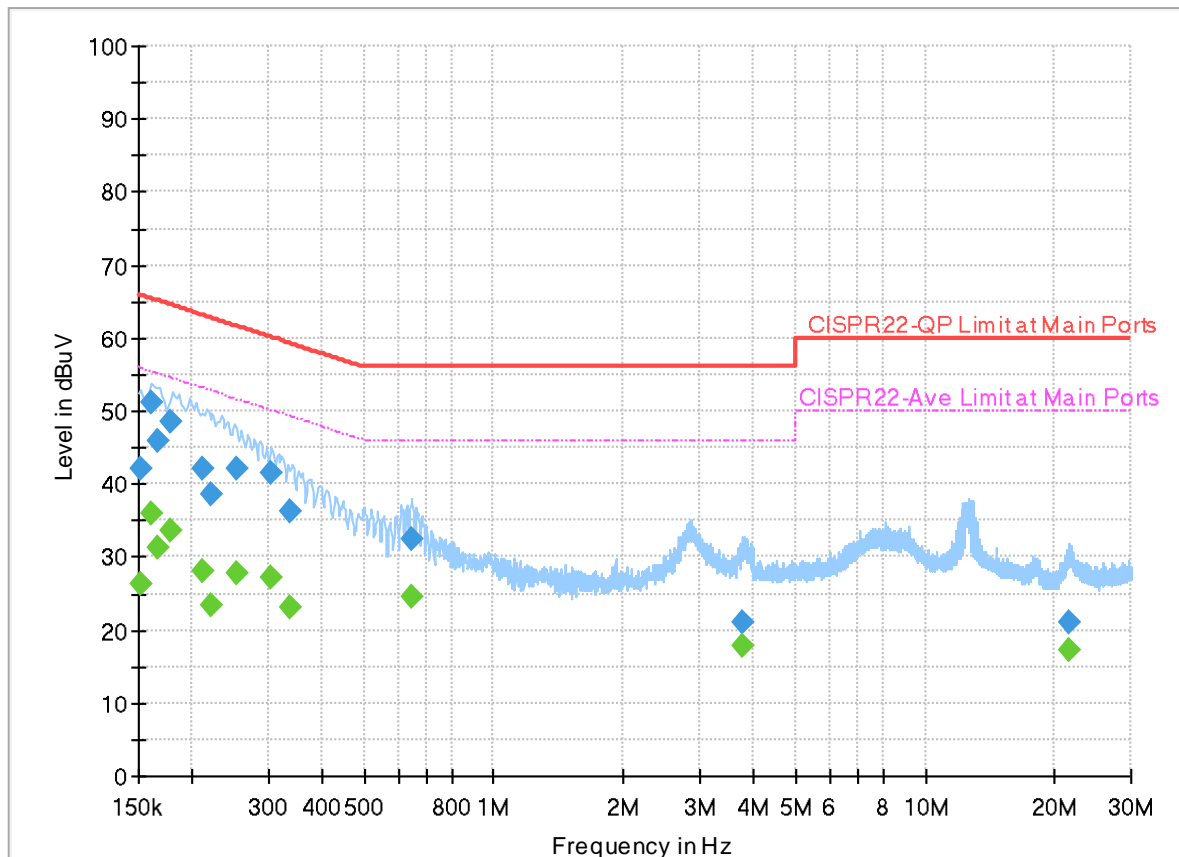

Final_Result

Frequency (MHz)	QuasiPeak (dBuV)	CAverage (dBuV)	Limit (dBuV)	Margin (dB)	Line	Filter	Corr. (dB)
0.151148	---	26.32	55.94	29.62	L1	OFF	19.9
0.151148	42.12	---	65.94	23.82	L1	OFF	19.9
0.161160	---	35.91	55.40	19.49	L1	OFF	19.9
0.161160	51.26	---	65.40	14.14	L1	OFF	19.9
0.165750	---	31.23	55.17	23.94	L1	OFF	19.9
0.165750	45.83	---	65.17	19.34	L1	OFF	19.9
0.177000	---	33.52	54.63	21.11	L1	OFF	19.9
0.177000	48.59	---	64.63	16.04	L1	OFF	19.9
0.210660	---	28.03	53.18	25.15	L1	OFF	20.0
0.210660	42.23	---	63.18	20.95	L1	OFF	20.0
0.221640	---	23.52	52.76	29.24	L1	OFF	20.0
0.221640	38.62	---	62.76	24.14	L1	OFF	20.0
0.254400	---	27.89	51.61	23.72	L1	OFF	20.0
0.254400	42.06	---	61.61	19.55	L1	OFF	20.0
0.303000	---	27.30	50.16	22.86	L1	OFF	20.0
0.303000	41.53	---	60.16	18.63	L1	OFF	20.0
0.336750	---	23.05	49.28	26.23	L1	OFF	20.0
0.336750	36.25	---	59.28	23.03	L1	OFF	20.0
0.646080	---	24.54	46.00	21.46	L1	OFF	20.0

0.646080	32.37	---	56.00	23.63	L1	OFF	20.0
3.764940	---	17.89	46.00	28.11	L1	OFF	20.0
3.764940	21.18	---	56.00	34.82	L1	OFF	20.0
21.441300	---	17.28	50.00	32.72	L1	OFF	20.2
21.441300	21.16	---	60.00	38.84	L1	OFF	20.2

EUT Information

Report NO : 330714
 Test Mode : Mode 1
 Test Voltage : 120Vac/60Hz
 Phase : Neutral

Full Spectrum

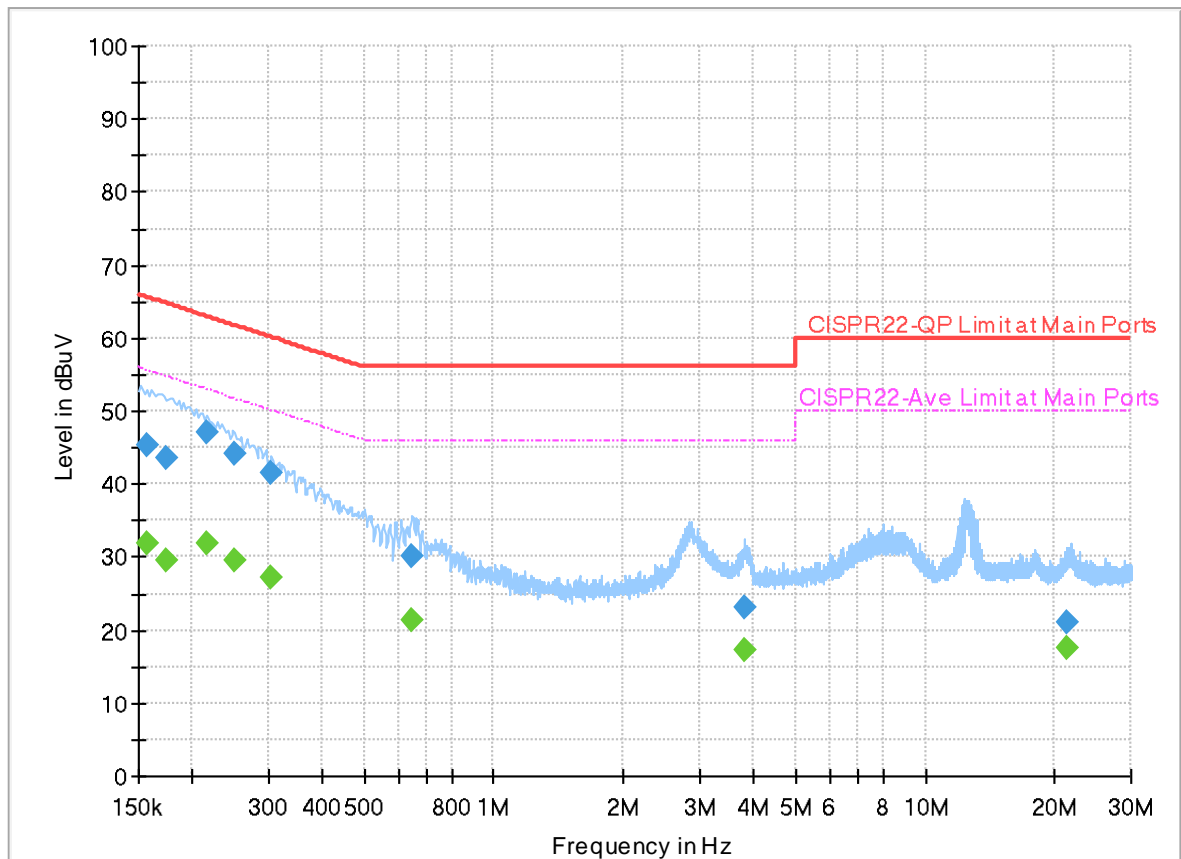

Final_Result

Frequency (MHz)	QuasiPeak (dBuV)	CAverage (dBuV)	Limit (dBuV)	Margin (dB)	Line	Filter	Corr. (dB)
0.156750	---	31.99	55.63	23.64	N	OFF	20.0
0.156750	45.30	---	65.63	20.33	N	OFF	20.0
0.174750	---	29.61	54.73	25.12	N	OFF	20.0
0.174750	43.57	---	64.73	21.16	N	OFF	20.0
0.215160	---	31.99	53.00	21.01	N	OFF	20.0
0.215160	46.98	---	63.00	16.02	N	OFF	20.0
0.249720	---	29.51	51.77	22.26	N	OFF	20.0
0.249720	44.16	---	61.77	17.61	N	OFF	20.0
0.304890	---	27.21	50.11	22.90	N	OFF	20.0
0.304890	41.50	---	60.11	18.61	N	OFF	20.0
0.647880	---	21.39	46.00	24.61	N	OFF	20.0
0.647880	30.21	---	56.00	25.79	N	OFF	20.0
3.815970	---	17.39	46.00	28.61	N	OFF	20.0
3.815970	23.09	---	56.00	32.91	N	OFF	20.0
21.326820	---	17.66	50.00	32.34	N	OFF	20.2
21.326820	20.96	---	60.00	39.04	N	OFF	20.2



Appendix C. Radiated Spurious Emission

Test Engineer :	John Chuang, JC Liang and Howard Huang	Temperature :	18.2~22.3°C
		Relative Humidity :	66.5~69.4%

<1Mbps>

2.4GHz 2400~2483.5MHz

BLE (Band Edge @ 3m)

BLE	Note	Frequency (MHz)	Level (dBμV/m)	Margin (dB)	Limit Line (dBμV/m)	Read Level (dBμV)	Antenna Factor (dB/m)	Path Loss (dB)	Preamp Factor (dB)	Ant Pos (cm)	Table Pos (deg)	Peak Avg. (P/A)	Pol. (H/V)	
BLE CH 00 2402MHz		2372.37	50.02	-23.98	74	40.13	27.34	18.6	36.05	150	55	P	H	
		2377.305	40.45	-13.55	54	30.54	27.35	18.61	36.05	150	55	A	H	
	*	2402	103.69	-	-	93.69	27.41	18.65	36.06	150	55	P	H	
	*	2402	103.02	-	-	93.02	27.41	18.65	36.06	150	55	A	H	
													H	
														H
			2366.385	49.97	-24.03	74	40.11	27.33	18.58	36.05	300	183	P	V
			2339.715	40.52	-13.48	54	30.73	27.3	18.53	36.04	300	183	A	V
	*		2402	105.47	-	-	95.47	27.41	18.65	36.06	300	183	P	V
	*		2402	104.86	-	-	94.86	27.41	18.65	36.06	300	183	A	V
													V	
													V	
BLE CH 19 2440MHz		2365.2	51.1	-22.9	74	41.24	27.33	18.58	36.05	100	56	P	H	
		2364.72	40.46	-13.54	54	30.6	27.33	18.58	36.05	100	56	A	H	
	*	2440	104.42	-	-	94.2	27.56	18.73	36.07	100	56	P	H	
	*	2440	103.68	-	-	93.46	27.56	18.73	36.07	100	56	A	H	
			2493.2	50.67	-23.33	74	40.15	27.77	18.84	36.09	100	56	P	H
			2492.32	40.75	-13.25	54	30.24	27.77	18.83	36.09	100	56	A	H
			2345.68	50.3	-23.7	74	40.5	27.3	18.54	36.04	300	359	P	V
			2381.36	40.57	-13.43	54	30.65	27.36	18.61	36.05	300	359	A	V
	*		2440	106.96	-	-	96.74	27.56	18.73	36.07	300	359	P	V
	*		2440	106.24	-	-	96.02	27.56	18.73	36.07	300	359	A	V
			2488.64	49.53	-24.47	74	39.04	27.75	18.83	36.09	300	359	P	V
			2487.2	40.83	-13.17	54	30.35	27.75	18.82	36.09	300	359	A	V



BLE CH 39 2480MHz	*	2480	102.33	-	-	91.88	27.72	18.81	36.08	200	52	P	H
	*	2480	101.69	-	-	91.24	27.72	18.81	36.08	200	52	A	H
		2483.56	52.39	-21.61	74	41.93	27.73	18.82	36.09	200	52	P	H
		2483.92	41.1	-12.9	54	30.63	27.74	18.82	36.09	200	52	A	H
													H
													H
	*	2480	104.56	-	-	94.11	27.72	18.81	36.08	100	203	P	V
	*	2480	103.85	-	-	93.4	27.72	18.81	36.08	100	203	A	V
		2483.52	52.47	-21.53	74	42.01	27.73	18.82	36.09	100	203	P	V
		2483.56	41.41	-12.59	54	30.95	27.73	18.82	36.09	100	203	A	V
													V
													V
Remark	1. No other spurious found. 2. All results are PASS against Peak and Average limit line.												



**2.4GHz 2400~2483.5MHz
BLE (Harmonic @ 3m)**

BLE	Note	Frequency (MHz)	Level (dBµV/m)	Margin (dB)	Limit Line (dBµV/m)	Read Level (dBµV)	Antenna Factor (dB/m)	Path Loss (dB)	Preamp Factor (dB)	Ant Pos (cm)	Table Pos (deg)	Peak Avg. (P/A)	Pol. (H/V)
BLE CH 00 2402MHz		4804	43.44	-30.56	74	35.43	32.32	12.89	37.2	-	-	P	H
													H
													H
													H
													H
													H
													H
													H
													H
													H
													H
													H
													H
													H
													H
													H
													H
													H
													H
			4804	44.33	-29.67	74	36.32	32.32	12.89	37.2	-	-	P
													V
													V
													V
													V
													V
													V
													V
													V
													V
													V
													V
													V
													V
													V



BLE	Note	Frequency (MHz)	Level (dBµV/m)	Margin (dB)	Limit Line (dBµV/m)	Read Level (dBµV)	Antenna Factor (dB/m)	Path Loss (dB)	Preamp Factor (dB)	Ant Pos (cm)	Table Pos (deg)	Peak Avg. (P/A)	Pol. (H/V)	
BLE CH 19 2440MHz		4880	44.17	-29.83	74	35.66	32.66	13.11	37.26	-	-	P	H	
		7320	47.96	-26.04	74	33.42	36.82	15.89	38.17	-	-	P	H	
													H	
													H	
													H	
													H	
													H	
													H	
													H	
													H	
													H	
													H	
			4880	43.81	-30.19	74	35.3	32.66	13.11	37.26	-	-	P	V
			7320	47.78	-26.22	74	33.24	36.82	15.89	38.17	-	-	P	V
														V
														V
														V
														V
														V
														V
													V	
													V	



BLE	Note	Frequency (MHz)	Level (dBµV/m)	Margin (dB)	Limit Line (dBµV/m)	Read Level (dBµV)	Antenna Factor (dB/m)	Path Loss (dB)	Preamp Factor (dB)	Ant Pos (cm)	Table Pos (deg)	Peak Avg. (P/A)	Pol. (H/V)
BLE CH 39 2480MHz		4960	44.35	-29.65	74	35.4	32.94	13.34	37.33	-	-	P	H
		7440	47.81	-26.19	74	33.63	36.42	16.01	38.25	-	-	P	H
													H
													H
													H
													H
													H
													H
													H
													H
													H
													H
													H
													H
													H
													H
													H
													H
													H
			4960	43.83	-30.17	74	34.88	32.94	13.34	37.33	-	-	P
		7440	47.5	-26.5	74	33.32	36.42	16.01	38.25	-	-	P	V
													V
													V
													V
													V
													V
													V
													V
													V
													V
													V
													V
													V
													V
Remark	<ol style="list-style-type: none"> No other spurious found. All results are PASS against Peak and Average limit line. The emission position marked as "-" means no suspected emission found with sufficient margin against limit line or noise floor only. 												



<2Mbps>

2.4GHz 2400~2483.5MHz

BLE (Band Edge @ 3m)

BLE	Note	Frequency	Level	Margin	Limit Line	Read Level	Antenna Factor	Path Loss	Preamp Factor	Ant Pos	Table Pos	Peak Avg.	Pol.	
		(MHz)	(dBμV/m)	(dB)	(dBμV/m)	(dBμV)	(dB/m)	(dB)	(dB)	(cm)	(deg)	(P/A)	(H/V)	
BLE CH 00 2402MHz		2359.035	49.94	-24.06	74	40.1	27.32	18.57	36.05	100	57	P	H	
		2360.61	41.8	-12.2	54	31.96	27.32	18.57	36.05	100	57	A	H	
	*	2402	104.48	-	-	94.48	27.41	18.65	36.06	100	57	P	H	
	*	2402	103.15	-	-	93.15	27.41	18.65	36.06	100	57	A	H	
													H	
														H
			2320.71	49.75	-24.25	74	39.99	27.3	18.5	36.04	300	3	P	V
			2324.91	42.04	-11.96	54	32.28	27.3	18.5	36.04	300	3	A	V
	*		2402	105.92	-	-	95.92	27.41	18.65	36.06	300	3	P	V
	*		2402	104.67	-	-	94.67	27.41	18.65	36.06	300	3	A	V
														V
														V
BLE CH 19 2440MHz		2368.1	49.91	-24.09	74	40.03	27.34	18.59	36.05	100	50	P	H	
		2379.3	42.21	-11.79	54	32.29	27.36	18.61	36.05	100	50	A	H	
	*	2440	105.64	-	-	95.42	27.56	18.73	36.07	100	50	P	H	
	*	2440	104.28	-	-	94.06	27.56	18.73	36.07	100	50	A	H	
			2493.42	50.24	-23.76	74	39.72	27.77	18.84	36.09	100	50	P	H
			2496.43	42.24	-11.76	54	31.7	27.79	18.84	36.09	100	50	A	H
			2312.38	50.08	-23.92	74	40.33	27.3	18.48	36.03	300	360	P	V
			2388.68	41.97	-12.03	54	32.02	27.38	18.63	36.06	300	360	A	V
	*		2440	108.01	-	-	97.79	27.56	18.73	36.07	300	360	P	V
	*		2440	106.59	-	-	96.37	27.56	18.73	36.07	300	360	A	V
			2495.03	50.34	-23.66	74	39.81	27.78	18.84	36.09	300	360	P	V
			2493.14	42.27	-11.73	54	31.75	27.77	18.84	36.09	300	360	A	V



BLE CH 39 2480MHz	*	2480	103.68	-	-	93.23	27.72	18.81	36.08	300	237	P	H
	*	2480	102.4	-	-	91.95	27.72	18.81	36.08	300	237	A	H
		2483.56	54.11	-19.89	74	43.65	27.73	18.82	36.09	300	237	P	H
		2483.52	43.51	-10.49	54	33.05	27.73	18.82	36.09	300	237	A	H
													H
													H
	*	2480	105.22	-	-	94.77	27.72	18.81	36.08	300	27	P	V
	*	2480	103.85	-	-	93.4	27.72	18.81	36.08	300	27	A	V
		2483.52	56.13	-17.87	74	45.67	27.73	18.82	36.09	300	27	P	V
		2483.52	44.78	-9.22	54	34.32	27.73	18.82	36.09	300	27	A	V
													V
													V
Remark	<ol style="list-style-type: none"> 1. No other spurious found. 2. All results are PASS against Peak and Average limit line. 												



2.4GHz 2400~2483.5MHz
BLE (Harmonic @ 3m)

BLE	Note	Frequency (MHz)	Level (dBµV/m)	Margin (dB)	Limit Line (dBµV/m)	Read Level (dBµV)	Antenna Factor (dB/m)	Path Loss (dB)	Preamp Factor (dB)	Ant Pos (cm)	Table Pos (deg)	Peak Avg. (P/A)	Pol. (H/V)
BLE CH 00 2402MHz		4804	43.85	-30.15	74	35.84	32.32	12.89	37.2	-	-	P	H
													H
													H
													H
													H
													H
													H
													H
													H
													H
													H
													H
													H
													H
													H
													H
													H
													H
													H
			4804	43.88	-30.12	74	35.87	32.32	12.89	37.2	-	-	P
													V
													V
													V
													V
													V
													V
													V
													V
													V
													V
													V
													V
													V
													V



BLE	Note	Frequency (MHz)	Level (dBµV/m)	Margin (dB)	Limit Line (dBµV/m)	Read Level (dBµV)	Antenna Factor (dB/m)	Path Loss (dB)	Preamp Factor (dB)	Ant Pos (cm)	Table Pos (deg)	Peak Avg. (P/A)	Pol. (H/V)	
BLE CH 19 2440MHz		4880	44.25	-29.75	74	35.74	32.66	13.11	37.26	-	-	P	H	
		7320	47.89	-26.11	74	33.35	36.82	15.89	38.17	-	-	P	H	
													H	
													H	
													H	
													H	
													H	
													H	
													H	
													H	
													H	
													H	
			4880	43.88	-30.12	74	35.37	32.66	13.11	37.26	-	-	P	V
			7320	47.98	-26.02	74	33.44	36.82	15.89	38.17	-	-	P	V
														V
														V
														V
														V
														V
														V
													V	
													V	



BLE	Note	Frequency (MHz)	Level (dBμV/m)	Margin (dB)	Limit Line (dBμV/m)	Read Level (dBμV)	Antenna Factor (dB/m)	Path Loss (dB)	Preamp Factor (dB)	Ant Pos (cm)	Table Pos (deg)	Peak Avg. (P/A)	Pol. (H/V)
BLE CH 39 2480MHz		4960	43.97	-30.03	74	35.02	32.94	13.34	37.33	-	-	P	H
		7440	47.76	-26.24	74	33.58	36.42	16.01	38.25	-	-	P	H
													H
													H
													H
													H
													H
													H
													H
													H
													H
													H
													H
													H
													H
													H
													H
													H
													H
			4960	44.51	-29.49	74	35.56	32.94	13.34	37.33	-	-	P
		7440	47.78	-26.22	74	33.6	36.42	16.01	38.25	-	-	P	V
													V
													V
													V
													V
													V
													V
													V
													V
													V
													V
													V
													V
													V
Remark	<ol style="list-style-type: none"> No other spurious found. All results are PASS against Peak and Average limit line. The emission position marked as "-" means no suspected emission found with sufficient margin against limit line or noise floor only. 												



Emission above 18GHz

2.4GHz BLE (SHF)

BLE	Note	Frequency	Level	Margin	Limit	Read	Antenna	Path	Preamp	Ant	Table	Peak	Pol.
		(MHz)	(dBμV/m)	(dB)	(dBμV/m)	(dBμV)	(dB/m)	(dB)	(dB)	(cm)	(deg)	(P/A)	(H/V)
2.4GHz BLE SHF		24944	42.44	-31.56	74	36.11	39.68	19.78	53.13	-	-	P	H
													H
													H
													H
													H
													H
													H
													H
													H
													H
													H
													H
													H
													H
													H
													H
													H
													H
													H
			24699	43.43	-30.57	74	37.45	39.62	19.64	53.28	-	-	P
													V
													V
													V
													V
													V
													V
													V
													V
													V
													V
													V
													V
													V
													V

Remark

- No other spurious found.
- All results are PASS against limit line.
- The emission position marked as "-" means no suspected emission found with sufficient margin against limit line or noise floor only.



Emission below 1GHz

2.4GHz BLE (LF)

BLE	Note	Frequency	Level	Margin	Limit	Read	Antenna	Path	Preamp	Ant	Table	Peak	Pol.	
		(MHz)	(dBμV/m)	(dB)	(dBμV/m)	(dBμV)	(dB/m)	(dB)	(dB)	(cm)	(deg)	(P/A)	(H/V)	
2.4GHz BLE LF		30	23.84	-16.16	40	33.9	24.56	1.14	35.76	-	-	P	H	
		164.83	27.85	-15.65	43.5	44.99	15.99	2.44	35.57	-	-	P	H	
		213.33	30.23	-13.27	43.5	47.75	15.21	2.73	35.46	-	-	P	H	
		294.81	25.64	-20.36	46	38.43	19.28	3.22	35.29	-	-	P	H	
		854.5	33.66	-12.34	46	32.41	29.21	5.47	33.43	-	-	P	H	
		937.92	35.55	-10.45	46	32.92	30.19	5.61	33.17	-	-	P	H	
														H
														H
														H
														H
														H
														H
			34.85	26.46	-13.54	40	38.63	22.38	1.21	35.76	-	-	P	V
			169.68	26.78	-16.72	43.5	44.24	15.64	2.46	35.56	-	-	P	V
			214.3	26.6	-16.9	43.5	44.15	15.17	2.74	35.46	-	-	P	V
			725.49	31.78	-14.22	46	33.49	27.35	4.93	33.99	-	-	P	V
			838.98	34.25	-11.75	46	33.56	28.78	5.42	33.51	-	-	P	V
			902.03	36.99	-9.01	46	35.74	29.08	5.45	33.28	-	-	P	V
														V
														V
													V	
													V	
													V	

Remark

- No other spurious found.
- All results are PASS against limit line.
- The emission position marked as "-" means no suspected emission found and emission level has at least 6dB margin against limit or emission is noise floor only.



Note symbol

*	Fundamental Frequency which can be ignored. However, the level of any unwanted emissions shall not exceed the level of the fundamental frequency.
!	Test result is Margin line.
P/A	Peak or Average
H/V	Horizontal or Vertical



A calculation example for radiated spurious emission is shown as below:

BLE	Note	Frequency	Level	Margin	Limit	Read	Antenna	Path	Preamp	Ant	Table	Peak	Pol.
		(MHz)	(dBμV/m)	(dB)	(dBμV/m)	(dBμV)	(dB/m)	(dB)	(dB)	(cm)	(deg)	(P/A)	(H/V)
BLE CH 00 2402MHz		2390	55.45	-18.55	74	54.51	32.22	4.58	35.86	103	308	P	H
		2390	43.54	-10.46	54	42.6	32.22	4.58	35.86	103	308	A	H

1. Path Loss(dB) = Cable loss(dB) + Filter loss(dB) + Attenuator loss(dB)
2. Level(dBμV/m) =
Antenna Factor(dB/m) + Path Loss(dB) + Read Level(dBμV) - Preamp Factor(dB)
3. Margin(dB) = Level(dBμV/m) – Limit Line(dBμV/m)

For Peak Limit @ 2390MHz:

1. Level(dBμV/m)
= Antenna Factor(dB/m) + Path Loss(dB) + Read Level(dBμV) - Preamp Factor(dB)
= 32.22(dB/m) + 4.58(dB) + 54.51(dBμV) – 35.86 (dB)
= 55.45 (dBμV/m)
2. Margin(dB)
= Level(dBμV/m) – Limit Line(dBμV/m)
= 55.45(dBμV/m) – 74(dBμV/m)
= -18.55(dB)

For Average Limit @ 2390MHz:

1. Level(dBμV/m)
= Antenna Factor(dB/m) + Path Loss(dB) + Read Level(dBμV) - Preamp Factor(dB)
= 32.22(dB/m) + 4.58(dB) + 42.6(dBμV) – 35.86 (dB)
= 43.54 (dBμV/m)
2. Margin(dB)
= Level(dBμV/m) – Limit Line(dBμV/m)
= 43.54(dBμV/m) – 54(dBμV/m)
= -10.46(dB)

Both peak and average measured complies with the limit line, so test result is “PASS”.



Appendix D. Radiated Spurious Emission Plots

Test Engineer :	John Chuang, JC Liang and Howard Huang	Temperature :	18.2~22.3°C
		Relative Humidity :	66.5~69.4%

Note symbol

-L	Low channel location
-R	High channel location



<1Mbps>

2.4GHz 2400~2483.5MHz

BLE (Band Edge @ 3m)

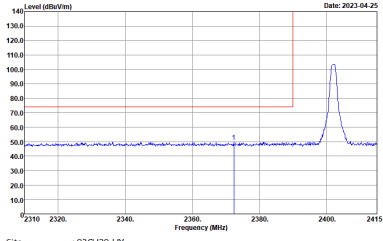
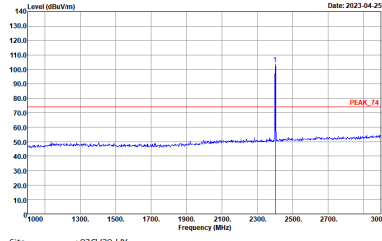
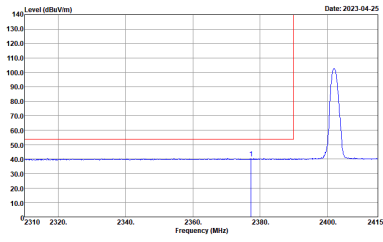
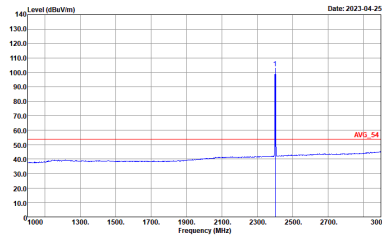
BLE	2.4GHz 2400~2483.5MHz Band Edge @ 3m	
	BLE CH00 2402MHz	
	Horizontal	Fundamental
Peak	 <p>Site : 03CH20-HY Condition : PEAK_BE_74 3m 91200_02360_221104 HORIZONTAL : RBW:1000.000KHz VBW:3000.000KHz SWT:Auto</p>	 <p>Site : 03CH20-HY Condition : PEAK_74 3m 91200_02360_221104 HORIZONTAL : RBW:1000.000KHz VBW:3000.000KHz SWT:Auto</p>
Avg.	 <p>Site : 03CH20-HY Condition : AVG_BE_54 3m 91200_02360_221104 HORIZONTAL : RBW:1000.000KHz VBW:3.000KHz SWT:Auto</p>	 <p>Site : 03CH20-HY Condition : AVG_54 3m 91200_02360_221104 HORIZONTAL : RBW:1000.000KHz VBW:3.000KHz SWT:Auto</p>

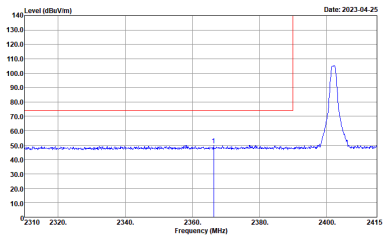
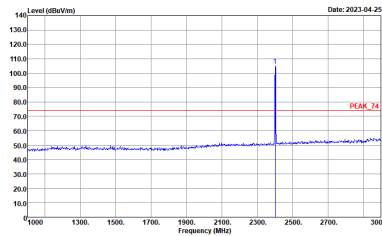
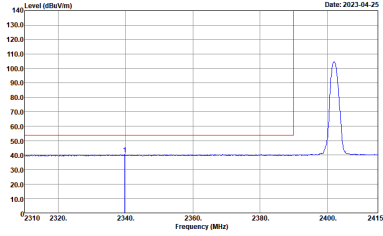
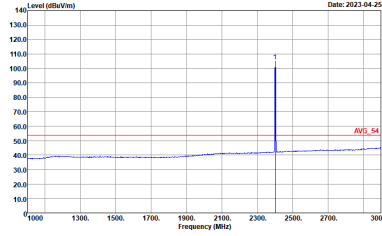

BLE	2.4GHz 2400~2483.5MHz Band Edge @ 3m	
	BLE CH00 2402MHz	
	Vertical	Fundamental
Peak	 <p>Level (dBm/100kHz) vs Frequency (MHz) plot showing a peak at 2402 MHz. The y-axis ranges from 10.0 to 140.0 dBm/100kHz, and the x-axis ranges from 2310 to 2415 MHz. A red horizontal line is at approximately 75 dBm/100kHz. The peak reaches about 105 dBm/100kHz.</p> <p>Site : 03CH20-HY Condition : PEAK_BE_74 3m 91200_02360_221104 VERTICAL : RBW:1000.000kHz VBW:3000.000kHz SWT:Auto</p>	 <p>Level (dBm/100kHz) vs Frequency (MHz) plot showing a peak at 2402 MHz. The y-axis ranges from 10.0 to 140.0 dBm/100kHz, and the x-axis ranges from 1000 to 3000 MHz. A red horizontal line is at approximately 75 dBm/100kHz. The peak reaches about 105 dBm/100kHz. Labeled 'PEAK_74'.</p> <p>Site : 03CH20-HY Condition : PEAK_74 3m 91200_02360_221104 VERTICAL : RBW:1000.000kHz VBW:3000.000kHz SWT:Auto</p>
Avg	 <p>Level (dBm/100kHz) vs Frequency (MHz) plot showing an average peak at 2402 MHz. The y-axis ranges from 10.0 to 140.0 dBm/100kHz, and the x-axis ranges from 2310 to 2415 MHz. A red horizontal line is at approximately 55 dBm/100kHz. The peak reaches about 105 dBm/100kHz.</p> <p>Site : 03CH20-HY Condition : AV6_BE_54 3m 91200_02360_221104 VERTICAL : RBW:1000.000kHz VBW:3.000kHz SWT:Auto</p>	 <p>Level (dBm/100kHz) vs Frequency (MHz) plot showing an average peak at 2402 MHz. The y-axis ranges from 10.0 to 140.0 dBm/100kHz, and the x-axis ranges from 1000 to 3000 MHz. A red horizontal line is at approximately 55 dBm/100kHz. The peak reaches about 105 dBm/100kHz. Labeled 'AVG_54'.</p> <p>Site : 03CH20-HY Condition : AV6_54 3m 91200_02360_221104 VERTICAL : RBW:1000.000kHz VBW:3.000kHz SWT:Auto</p>

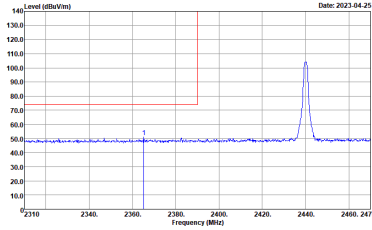
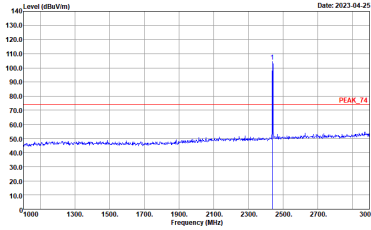
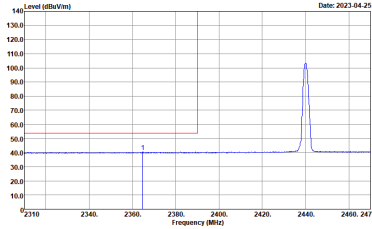
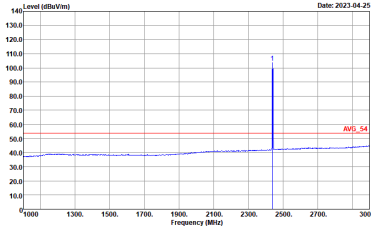

BLE	2.4GHz 2400~2483.5MHz Band Edge @ 3m	
BLE CH19 2440MHz - L		
Horizontal		Fundamental
Peak	 <p>Date: 2023-04-25</p> <p>Site : 03CH20-HY Condition : PEAK_BE_74 3m 91200_02360_221104 HORIZONTAL : RBW:1000.000KHz VBW:3000.000KHz SWT:Auto</p>	 <p>Date: 2023-04-25</p> <p>Site : 03CH20-HY Condition : PEAK_74 3m 91200_02360_221104 HORIZONTAL : RBW:1000.000KHz VBW:3000.000KHz SWT:Auto</p>
Avg.	 <p>Date: 2023-04-25</p> <p>Site : 03CH20-HY Condition : AVG_BE_54 3m 91200_02360_221104 HORIZONTAL : RBW:1000.000KHz VBW:3000.000KHz SWT:Auto</p>	 <p>Date: 2023-04-25</p> <p>Site : 03CH20-HY Condition : AVG_54 3m 91200_02360_221104 HORIZONTAL : RBW:1000.000KHz VBW:3000.000KHz SWT:Auto</p>

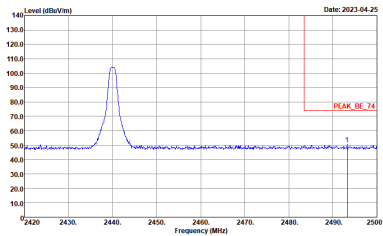
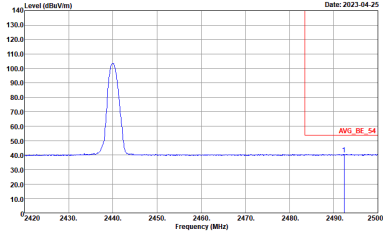

BLE	2.4GHz 2400~2483.5MHz Band Edge @ 3m	
BLE CH19 2440MHz - R		
Horizontal		Fundamental
Peak	 <p>Site : 03CH20-HY Condition : PEAK_BE_74 3m 9120D_02360_221104 HORIZONTAL : RBW:1000.000kHz VBW:3000.000kHz SWT:Auto</p>	Left blank
Avg.	 <p>Site : 03CH20-HY Condition : AVG_BE_54 3m 9120D_02360_221104 HORIZONTAL : RBW:1000.000kHz VBW:3000.000kHz SWT:Auto</p>	Left blank

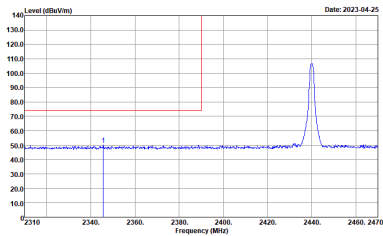
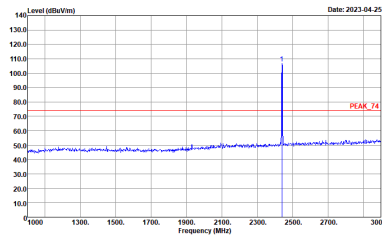
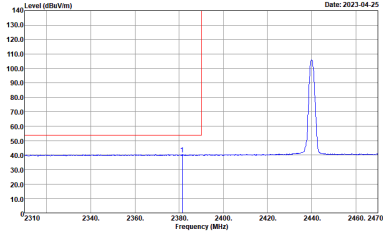
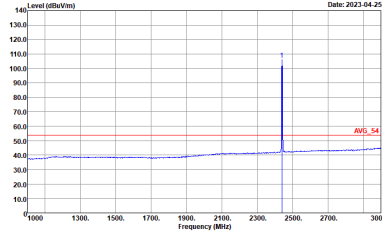

BLE	2.4GHz 2400~2483.5MHz Band Edge @ 3m	
	BLE CH19 2440MHz - L	
	Vertical	Fundamental
Peak	 <p>Level (dBm/100kHz) vs Frequency (MHz) plot showing a peak at 2440 MHz. The y-axis ranges from 10.0 to 140.0 dBm/100kHz, and the x-axis ranges from 2310 to 2470 MHz. A red vertical line marks the peak at 2440 MHz.</p> <p>Site : 03CH20-HY Condition : PEAK_BE_74 3m 91200_02360_221104 VERTICAL : RBW:1000.000kHz VBW:3000.000kHz SWT:Auto</p>	 <p>Level (dBm/100kHz) vs Frequency (MHz) plot showing a peak at 2440 MHz. The y-axis ranges from 0 to 140 dBm/100kHz, and the x-axis ranges from 1000 to 3000 MHz. A red horizontal line indicates the peak level, labeled 'PEAK_74'.</p> <p>Site : 03CH20-HY Condition : PEAK_74 3m 91200_02360_221104 VERTICAL : RBW:1000.000kHz VBW:3000.000kHz SWT:Auto</p>
Avg.	 <p>Level (dBm/100kHz) vs Frequency (MHz) plot showing an average spectrum with a peak at 2440 MHz. The y-axis ranges from 0 to 140 dBm/100kHz, and the x-axis ranges from 2310 to 2470 MHz. A red vertical line marks the peak at 2440 MHz.</p> <p>Site : 03CH20-HY Condition : AVG_BE_54 3m 91200_02360_221104 VERTICAL : RBW:1000.000kHz VBW:3.000kHz SWT:Auto</p>	 <p>Level (dBm/100kHz) vs Frequency (MHz) plot showing an average spectrum with a peak at 2440 MHz. The y-axis ranges from 0 to 140 dBm/100kHz, and the x-axis ranges from 1000 to 3000 MHz. A red horizontal line indicates the average peak level, labeled 'AVG_54'.</p> <p>Site : 03CH20-HY Condition : AVG_54 3m 91200_02360_221104 VERTICAL : RBW:1000.000kHz VBW:3.000kHz SWT:Auto</p>

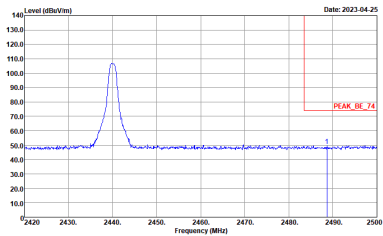
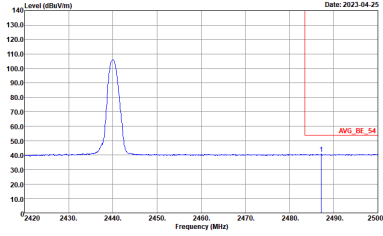

BLE	2.4GHz 2400~2483.5MHz Band Edge @ 3m	
BLE CH19 2440MHz - R		
	Vertical	Fundamental
<p>Peak</p>	 <p>Site : 03CH20-HY Condition : PEAK_BE_74 3m 9120D_02360_221104 VERTICAL : RBW:1000.000kHz VBW:3000.000kHz SWT:Auto</p>	<p>Left blank</p>
<p>Avg.</p>	 <p>Site : 03CH20-HY Condition : AVG_BE_54 3m 9120D_02360_221104 VERTICAL : RBW:1000.000kHz VBW:3000.000kHz SWT:Auto</p>	<p>Left blank</p>

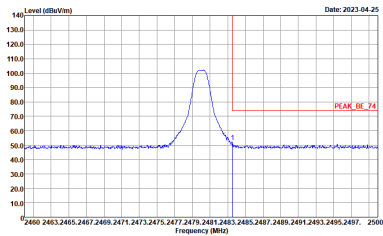
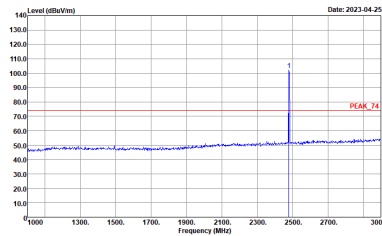
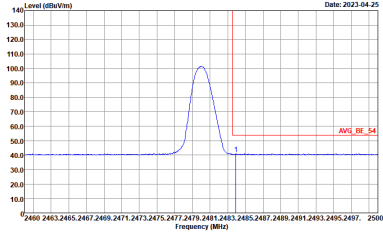
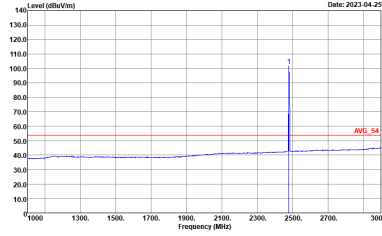

BLE	2.4GHz 2400~2483.5MHz Band Edge @ 3m	
BLE CH39 2480MHz		
Horizontal		Fundamental
Peak	 <p>Site : 03CH20-HY Condition : PEAK_BE_74 3m 91200_02360_221104 HORIZONTAL : RBW:1000.000kHz VBW:3000.000kHz SWT:Auto</p>	 <p>Site : 03CH20-HY Condition : PEAK_74 3m 91200_02360_221104 HORIZONTAL : RBW:1000.000kHz VBW:3000.000kHz SWT:Auto</p>
Avg.	 <p>Site : 03CH20-HY Condition : AV6_BE_54 3m 91200_02360_221104 HORIZONTAL : RBW:1000.000kHz VBW:3.000kHz SWT:Auto</p>	 <p>Site : 03CH20-HY Condition : AV6_54 3m 91200_02360_221104 HORIZONTAL : RBW:1000.000kHz VBW:3.000kHz SWT:Auto</p>

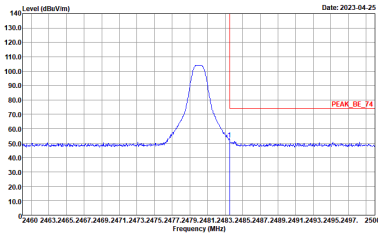
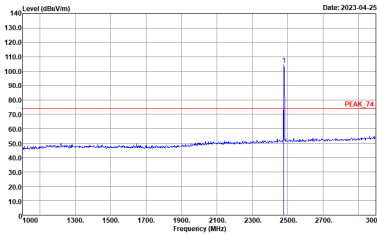
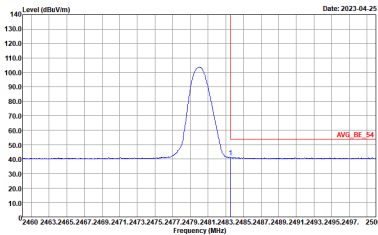
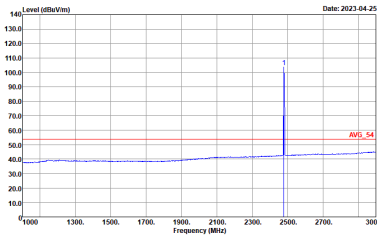

BLE	2.4GHz 2400~2483.5MHz Band Edge @ 3m	
BLE CH39 2480MHz		
Vertical		Fundamental
Peak	 <p>Level (dBm/100kHz) vs Frequency (MHz) plot showing a peak at 2480 MHz. The peak level is approximately 105 dBm/100kHz. The plot includes a red vertical line at the peak and a red horizontal line indicating the peak level. The x-axis ranges from 2460 to 2500 MHz, and the y-axis ranges from 10.0 to 140.0 dBm/100kHz.</p> <p>Site : 03CH20-HY Condition : PEAK_BE_74 3m 91200_02360_221104 VERTICAL : RBW:1000.000kHz VBW:3000.000kHz SWT:Auto</p>	 <p>Level (dBm/100kHz) vs Frequency (MHz) plot showing a sharp peak at 2480 MHz. The peak level is approximately 105 dBm/100kHz. The plot includes a red vertical line at the peak and a red horizontal line indicating the peak level. The x-axis ranges from 2460 to 3000 MHz, and the y-axis ranges from 10.0 to 140.0 dBm/100kHz.</p> <p>Site : 03CH20-HY Condition : PEAK_74 3m 91200_02360_221104 VERTICAL : RBW:1000.000kHz VBW:3000.000kHz SWT:Auto</p>
Avg.	 <p>Level (dBm/100kHz) vs Frequency (MHz) plot showing an average spectrum with a peak at 2480 MHz. The peak level is approximately 105 dBm/100kHz. The plot includes a red vertical line at the peak and a red horizontal line indicating the average level. The x-axis ranges from 2460 to 2500 MHz, and the y-axis ranges from 10.0 to 140.0 dBm/100kHz.</p> <p>Site : 03CH20-HY Condition : AV6_BE_54 3m 91200_02360_221104 VERTICAL : RBW:1000.000kHz VBW:3.000kHz SWT:Auto</p>	 <p>Level (dBm/100kHz) vs Frequency (MHz) plot showing an average spectrum with a sharp peak at 2480 MHz. The peak level is approximately 105 dBm/100kHz. The plot includes a red vertical line at the peak and a red horizontal line indicating the average level. The x-axis ranges from 2460 to 3000 MHz, and the y-axis ranges from 10.0 to 140.0 dBm/100kHz.</p> <p>Site : 03CH20-HY Condition : AV6_54 3m 91200_02360_221104 VERTICAL : RBW:1000.000kHz VBW:3.000kHz SWT:Auto</p>



2.4GHz 2400~2483.5MHz

BLE (Harmonic @ 3m)

BLE	2.4GHz 2400~2483.5MHz Harmonic @ 3m	
	BLE CH00 2402MHz	
	Horizontal	Vertical
Peak Avg.	<p>Site : 03CH20-1HY Condition : PEAK_74 3m 9120D_02360_221104 HORIZONTAL</p>	<p>Site : 03CH20-1HY Condition : PEAK_74 3m 9120D_02360_221104 VERTICAL</p>

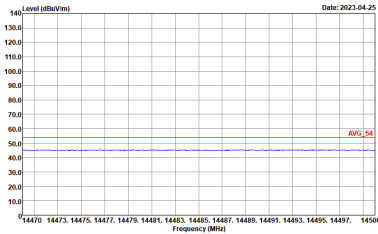
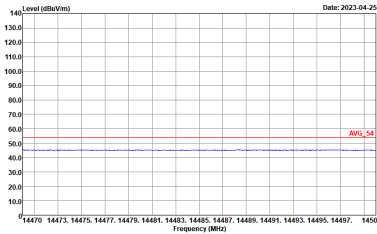
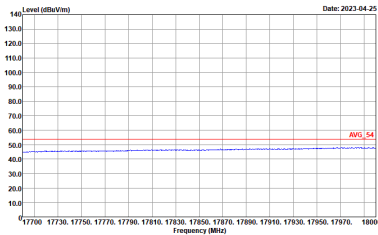
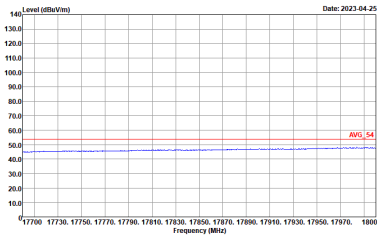

BLE	2.4GHz 2400~2483.5MHz Harmonic @ 3m	
BLE CH00 2402MHz		
Horizontal		Vertical
<p>14.47G ~14.5G Avg.</p>	 <p>Site : 03CH20-HY Condition : AV6_54 3m 91200_02360_221104 HORIZONTAL</p>	 <p>Site : 03CH20-HY Condition : AV6_54 3m 91200_02360_221104 VERTICAL</p>
<p>17.7G ~18G Avg</p>	 <p>Site : 03CH20-HY Condition : AV6_54 3m 91200_02360_221104 HORIZONTAL</p>	 <p>Site : 03CH20-HY Condition : AV6_54 3m 91200_02360_221104 VERTICAL</p>



BLE	2.4GHz 2400~2483.5MHz Harmonic @ 3m	
	BLE CH19 2440MHz	
	Horizontal	Vertical
Peak Avg.	<p>Site : 03CH20-HY Condition : PEAK_74 3m 9120D_02360_221104 HORIZONTAL</p>	<p>Site : 03CH20-HY Condition : PEAK_74 3m 9120D_02360_221104 VERTICAL</p>

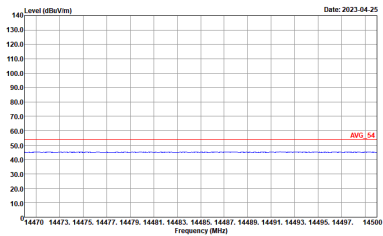
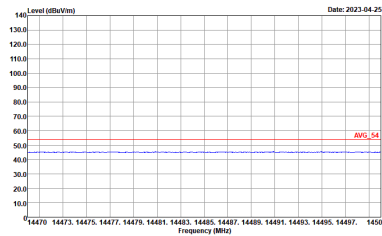
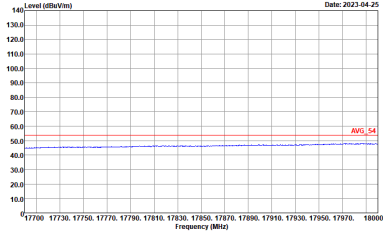
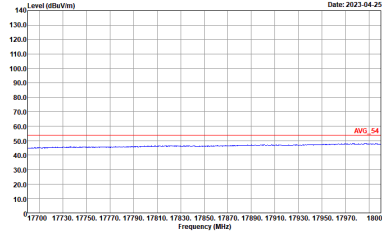

BLE	2.4GHz 2400~2483.5MHz Harmonic @ 3m	
BLE CH19 2440MHz		
Horizontal		Vertical
<p>14.47G ~14.5G Avg.</p>	 <p>Site : 03CH20-HY Condition : AV6_54 3m 91200_02360_221104 HORIZONTAL</p>	 <p>Site : 03CH20-HY Condition : AV6_54 3m 91200_02360_221104 VERTICAL</p>
<p>17.7G ~18G Avg</p>	 <p>Site : 03CH20-HY Condition : AV6_54 3m 91200_02360_221104 HORIZONTAL</p>	 <p>Site : 03CH20-HY Condition : AV6_54 3m 91200_02360_221104 VERTICAL</p>

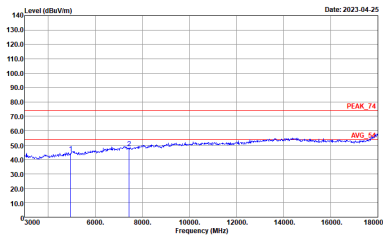
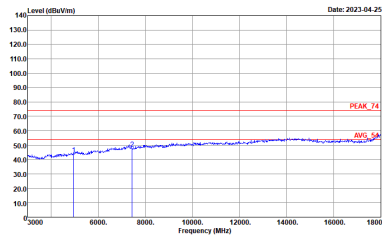

BLE	2.4GHz 2400~2483.5MHz Harmonic @ 3m	
	BLE CH39 2480MHz	
	Horizontal	Vertical
Peak	 <p>Site : 03CH20-HY Condition : PEAK_74 3m 9120D_02360_221104 HORIZONTAL :</p>	 <p>Site : 03CH20-HY Condition : PEAK_74 3m 9120D_02360_221104 VERTICAL :</p>

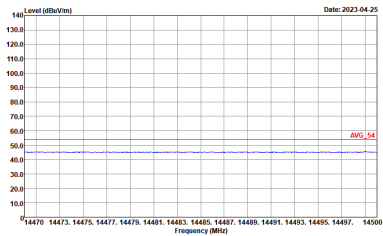
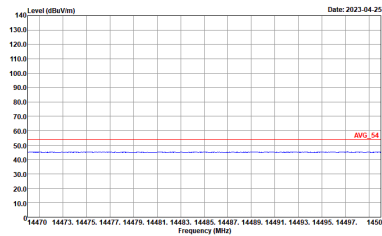
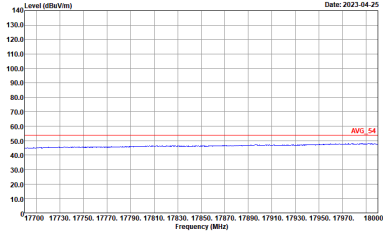
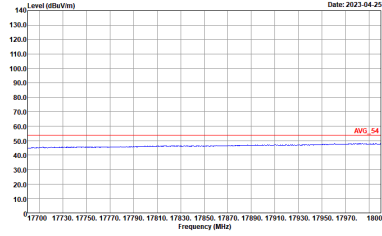

BLE	2.4GHz 2400~2483.5MHz Harmonic @ 3m	
BLE CH39 2480MHz		
Horizontal		Vertical
<p>14.47G ~14.5G Avg.</p>	 <p>Site : 03CH20-HY Condition : AV6_54 3m 91200_02360_221104 HORIZONTAL</p>	 <p>Site : 03CH20-HY Condition : AV6_54 3m 91200_02360_221104 VERTICAL</p>
<p>17.7G ~18G Avg</p>	 <p>Site : 03CH20-HY Condition : AV6_54 3m 91200_02360_221104 HORIZONTAL</p>	 <p>Site : 03CH20-HY Condition : AV6_54 3m 91200_02360_221104 VERTICAL</p>



<2Mbps>

2.4GHz 2400~2483.5MHz

BLE (Band Edge @ 3m)

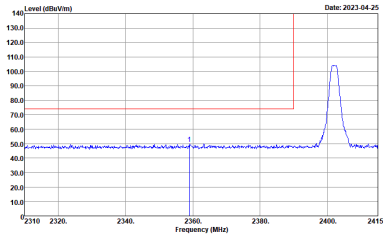
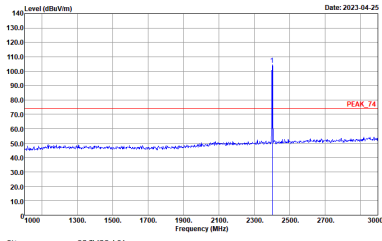
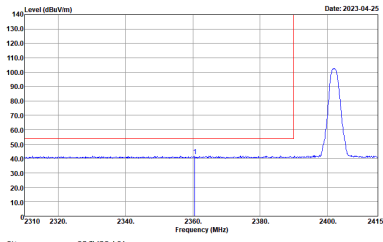
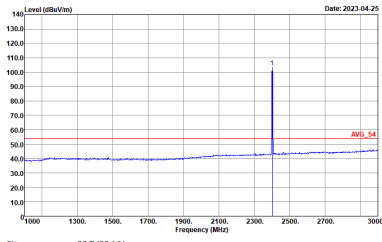
BLE	2.4GHz 2400~2483.5MHz Band Edge @ 3m	
	BLE CH00 2402MHz	
	Horizontal	Fundamental
Peak	 <p>Site : 03CH20-HY Condition : PEAK_BE_74 3m 91200_02360_221104 HORIZONTAL : RBW:1000.000kHz VBW:3000.000kHz SWT:Auto</p>	 <p>Site : 03CH20-HY Condition : PEAK_74 3m 91200_02360_221104 HORIZONTAL : RBW:1000.000kHz VBW:3000.000kHz SWT:Auto</p>
Avg.	 <p>Site : 03CH20-HY Condition : AVG_BE_54 3m 91200_02360_221104 HORIZONTAL : RBW:1000.000kHz VBW:30.000kHz SWT:Auto</p>	 <p>Site : 03CH20-HY Condition : AVG_54 3m 91200_02360_221104 HORIZONTAL : RBW:1000.000kHz VBW:30.000kHz SWT:Auto</p>

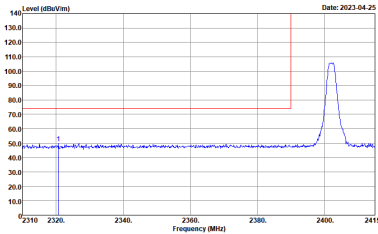
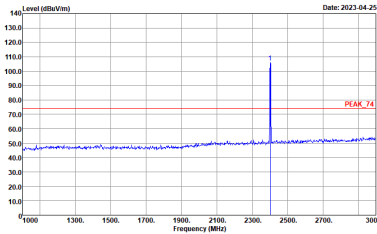
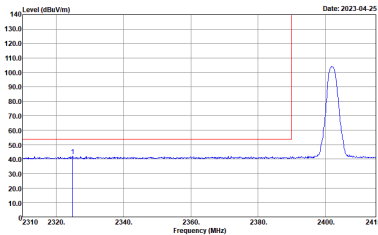
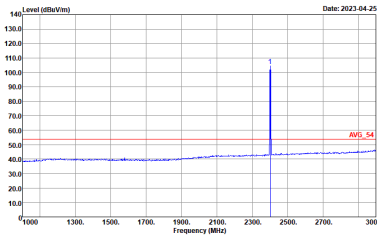

BLE	2.4GHz 2400~2483.5MHz Band Edge @ 3m	
BLE CH00 2402MHz		
Vertical		Fundamental
Peak	 <p>Level (dBm/100kHz) vs Frequency (MHz) plot showing a peak at 2402 MHz. The y-axis ranges from 10.0 to 140.0 dBm/100kHz, and the x-axis ranges from 2310 to 2415 MHz. A red vertical line marks the peak at 2402 MHz.</p> <p>Site : 03CH20-HY Condition : PEAK_BE_74 3m 91200_02360_221104 VERTICAL : RBW:1000.000kHz VBW:3000.000kHz SWT:Auto</p>	 <p>Level (dBm/100kHz) vs Frequency (MHz) plot showing a peak at 2402 MHz. The y-axis ranges from 10.0 to 140.0 dBm/100kHz, and the x-axis ranges from 1000 to 3000 MHz. A red vertical line marks the peak at 2402 MHz.</p> <p>Site : 03CH20-HY Condition : PEAK_74 3m 91200_02360_221104 VERTICAL : RBW:1000.000kHz VBW:3000.000kHz SWT:Auto</p>
Avg	 <p>Level (dBm/100kHz) vs Frequency (MHz) plot showing an average level at 2402 MHz. The y-axis ranges from 10.0 to 140.0 dBm/100kHz, and the x-axis ranges from 2310 to 2415 MHz. A red vertical line marks the average level at 2402 MHz.</p> <p>Site : 03CH20-HY Condition : AV6_BE_54 3m 91200_02360_221104 VERTICAL : RBW:1000.000kHz VBW:10.000kHz SWT:Auto</p>	 <p>Level (dBm/100kHz) vs Frequency (MHz) plot showing an average level at 2402 MHz. The y-axis ranges from 10.0 to 140.0 dBm/100kHz, and the x-axis ranges from 1000 to 3000 MHz. A red vertical line marks the average level at 2402 MHz.</p> <p>Site : 03CH20-HY Condition : AV6_54 3m 91200_02360_221104 VERTICAL : RBW:1000.000kHz VBW:10.000kHz SWT:Auto</p>

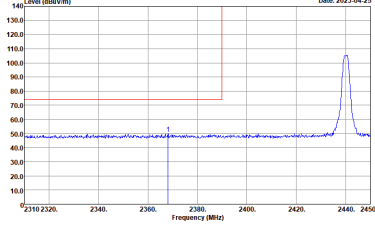
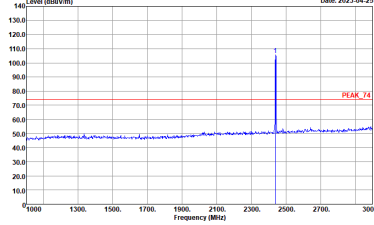
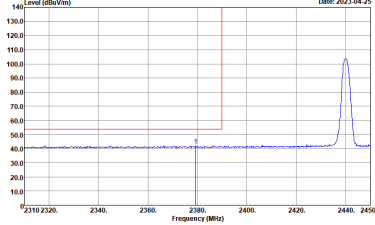
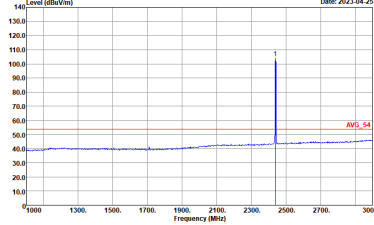

BLE	2.4GHz 2400~2483.5MHz Band Edge @ 3m	
BLE CH19 2440MHz - L		
Horizontal		Fundamental
Peak	 <p>Date: 2023-04-25</p> <p>Site : 03CH20-HY Condition : PEAK_BE_74 3m 91200_02360_221104 HORIZONTAL : RBW:1000.000KHz VBW:3000.000KHz SWT:Auto</p>	 <p>Date: 2023-04-25</p> <p>Site : 03CH20-HY Condition : PEAK_74 3m 91200_02360_221104 HORIZONTAL : RBW:1000.000KHz VBW:3000.000KHz SWT:Auto</p>
Avg.	 <p>Date: 2023-04-25</p> <p>Site : 03CH20-HY Condition : AVG_BE_54 3m 91200_02360_221104 HORIZONTAL : RBW:1000.000KHz VBW:10.000KHz SWT:Auto</p>	 <p>Date: 2023-04-25</p> <p>Site : 03CH20-HY Condition : AVG_54 3m 91200_02360_221104 HORIZONTAL : RBW:1000.000KHz VBW:10.000KHz SWT:Auto</p>

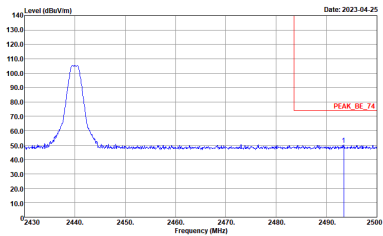
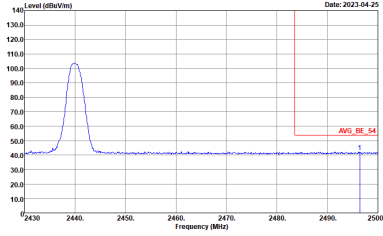

BLE	2.4GHz 2400~2483.5MHz Band Edge @ 3m	
	BLE CH19 2440MHz - R	
	Horizontal	Fundamental
Peak	 <p>Site : 03CH20-HY Condition : PEAK_BE_74 3m 91200_02360_221104 HORIZONTAL : RBW:1000.000kHz VBW:3000.000kHz SWT:Auto</p>	Left blank
Avg.	 <p>Site : 03CH20-HY Condition : AVG_BE_54 3m 91200_02360_221104 HORIZONTAL : RBW:1000.000kHz VBW:10.000kHz SWT:Auto</p>	Left blank

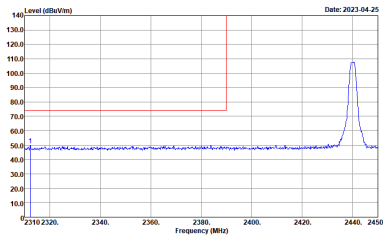
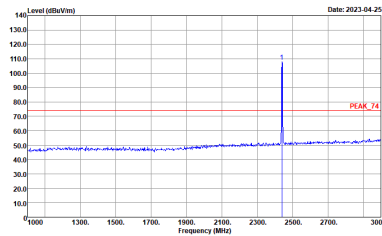
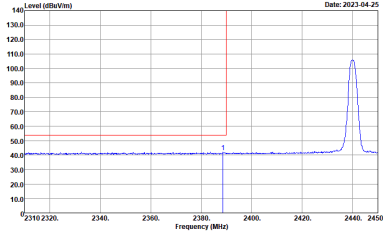
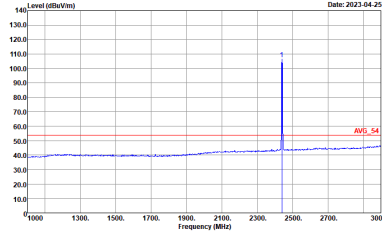

BLE	2.4GHz 2400~2483.5MHz Band Edge @ 3m	
BLE CH19 2440MHz - L		
Vertical		Fundamental
Peak	 <p>Level (dBm/100kHz) vs Frequency (MHz) plot showing a peak at 2440 MHz. The y-axis ranges from 10.0 to 140.0 dBm/100kHz, and the x-axis ranges from 2310 to 2450 MHz. A red line indicates the peak level at approximately 110 dBm/100kHz.</p> <p>Date: 2023-04-25</p> <p>Site : 03CH20-HY Condition : PEAK_BE_74 3m 91200_02360_221104 VERTICAL : RBW:1000.000kHz VBW:3000.000kHz SWT:Auto</p>	 <p>Level (dBm/100kHz) vs Frequency (MHz) plot showing a peak at 2440 MHz. The y-axis ranges from 10.0 to 140.0 dBm/100kHz, and the x-axis ranges from 1000 to 3000 MHz. A red line indicates the peak level at approximately 75 dBm/100kHz.</p> <p>Date: 2023-04-25</p> <p>Site : 03CH20-HY Condition : PEAK_74 3m 91200_02360_221104 VERTICAL : RBW:1000.000kHz VBW:3000.000kHz SWT:Auto</p>
Avg.	 <p>Level (dBm/100kHz) vs Frequency (MHz) plot showing a peak at 2440 MHz. The y-axis ranges from 10.0 to 140.0 dBm/100kHz, and the x-axis ranges from 2310 to 2450 MHz. A red line indicates the average level at approximately 50 dBm/100kHz.</p> <p>Date: 2023-04-25</p> <p>Site : 03CH20-HY Condition : AV6_BE_54 3m 91200_02360_221104 VERTICAL : RBW:1000.000kHz VBW:10.000kHz SWT:Auto</p>	 <p>Level (dBm/100kHz) vs Frequency (MHz) plot showing a peak at 2440 MHz. The y-axis ranges from 10.0 to 140.0 dBm/100kHz, and the x-axis ranges from 1000 to 3000 MHz. A red line indicates the average level at approximately 55 dBm/100kHz.</p> <p>Date: 2023-04-25</p> <p>Site : 03CH20-HY Condition : AV6_54 3m 91200_02360_221104 VERTICAL : RBW:1000.000kHz VBW:10.000kHz SWT:Auto</p>

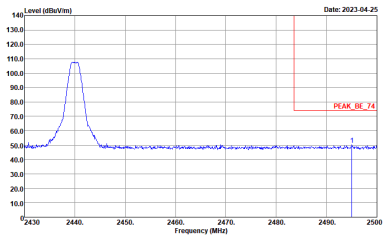
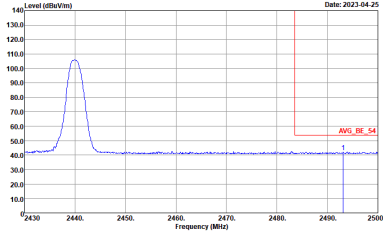

BLE	2.4GHz 2400~2483.5MHz Band Edge @ 3m	
	BLE CH19 2440MHz - R	
	Vertical	Fundamental
<p>Peak</p>	 <p>Site : 03CH20-HY Condition : PEAK_BE_74 3m 91200_02360_221104 VERTICAL : RBW:1000.000kHz VBW:3000.000kHz SWT:Auto</p>	<p>Left blank</p>
<p>Avg.</p>	 <p>Site : 03CH20-HY Condition : AVG_BE_54 3m 91200_02360_221104 VERTICAL : RBW:1000.000kHz VBW:10.000kHz SWT:Auto</p>	<p>Left blank</p>

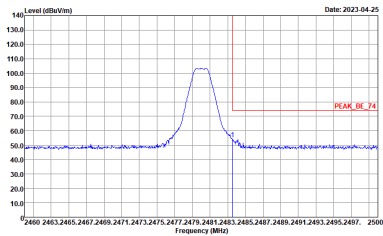
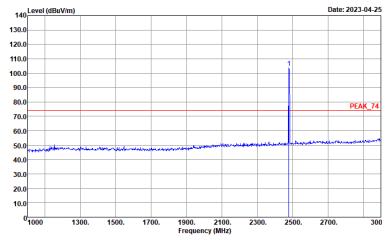
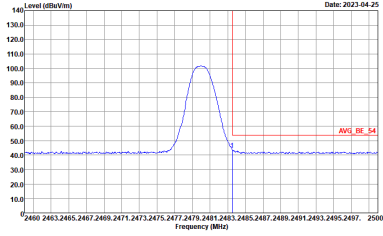
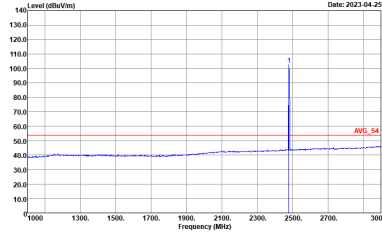

BLE	2.4GHz 2400~2483.5MHz Band Edge @ 3m	
	BLE CH39 2480MHz	
	Horizontal	Fundamental
Peak	 <p>Site : 03CH20-HY Condition : PEAK_BE_74 3m 91200_02360_221104 HORIZONTAL : RBW:1000.000KHz VBW:3000.000KHz SWT:Auto</p>	 <p>Site : 03CH20-HY Condition : PEAK_74 3m 91200_02360_221104 HORIZONTAL : RBW:1000.000KHz VBW:3000.000KHz SWT:Auto</p>
Avg.	 <p>Site : 03CH20-HY Condition : AV6_BE_54 3m 91200_02360_221104 HORIZONTAL : RBW:1000.000KHz VBW:10.000KHz SWT:Auto</p>	 <p>Site : 03CH20-HY Condition : AV6_54 3m 91200_02360_221104 HORIZONTAL : RBW:1000.000KHz VBW:10.000KHz SWT:Auto</p>

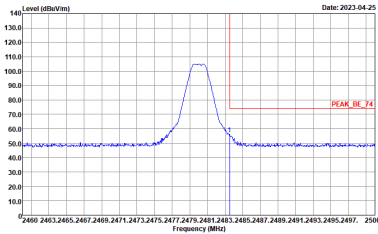
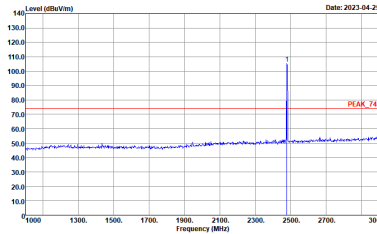
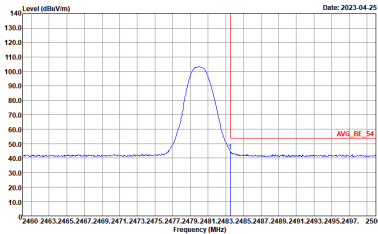
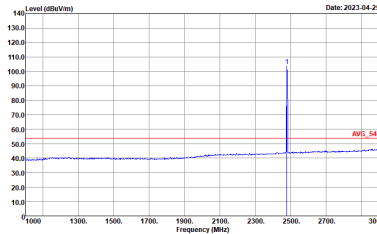

BLE	2.4GHz 2400~2483.5MHz Band Edge @ 3m	
	BLE CH39 2480MHz	
	Vertical	Fundamental
Peak	 <p>Level (dBm/100kHz) vs Frequency (MHz) plot showing a peak at 2480 MHz. The peak level is approximately 105 dBm/100kHz. A red vertical line marks the peak, and a red horizontal line indicates the level at 2480 MHz, labeled 'PEAK_BE_74'.</p> <p>Site : 03CH20-HY Condition : PEAK_BE_74 3m 91200_02360_221104 VERTICAL : RBW:1000.000kHz VBW:3000.000kHz SWT:Auto</p>	 <p>Level (dBm/100kHz) vs Frequency (MHz) plot showing a sharp peak at 2480 MHz. The peak level is approximately 105 dBm/100kHz. A red vertical line marks the peak, and a red horizontal line indicates the level at 2480 MHz, labeled 'PEAK_74'.</p> <p>Site : 03CH20-HY Condition : PEAK_74 3m 91200_02360_221104 VERTICAL : RBW:1000.000kHz VBW:3000.000kHz SWT:Auto</p>
Avg.	 <p>Level (dBm/100kHz) vs Frequency (MHz) plot showing an averaged peak at 2480 MHz. The peak level is approximately 105 dBm/100kHz. A red vertical line marks the peak, and a red horizontal line indicates the level at 2480 MHz, labeled 'AVG_BE_54'.</p> <p>Site : 03CH20-HY Condition : AVG_BE_54 3m 91200_02360_221104 VERTICAL : RBW:1000.000kHz VBW:10.000kHz SWT:Auto</p>	 <p>Level (dBm/100kHz) vs Frequency (MHz) plot showing an averaged sharp peak at 2480 MHz. The peak level is approximately 105 dBm/100kHz. A red vertical line marks the peak, and a red horizontal line indicates the level at 2480 MHz, labeled 'AVG_54'.</p> <p>Site : 03CH20-HY Condition : AVG_54 3m 91200_02360_221104 VERTICAL : RBW:1000.000kHz VBW:10.000kHz SWT:Auto</p>



2.4GHz 2400~2483.5MHz

BLE (Harmonic @ 3m)

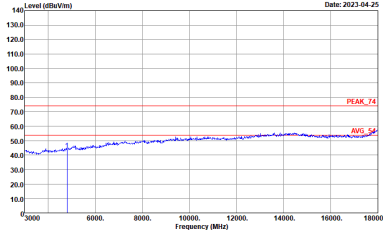
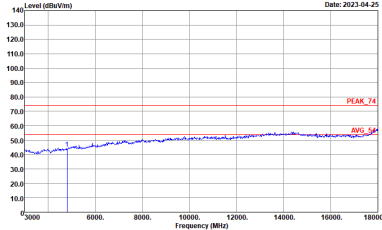
BLE	2.4GHz 2400~2483.5MHz Harmonic @ 3m	
	BLE CH00 2402MHz	
	Horizontal	Vertical
Peak Avg.	 <p>Site : 03CH20-HY Condition : PEAK_74 3m 91200_02360_221104 HORIZONTAL</p>	 <p>Site : 03CH20-HY Condition : PEAK_74 3m 91200_02360_221104 VERTICAL</p>

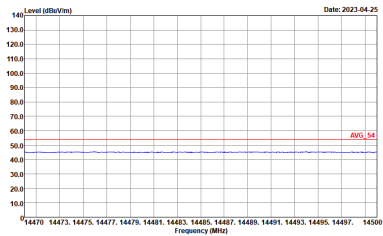
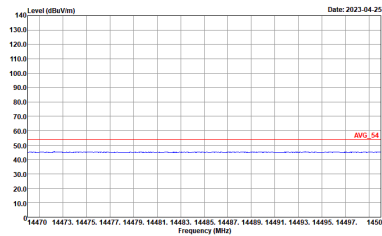
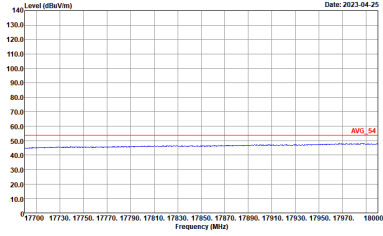
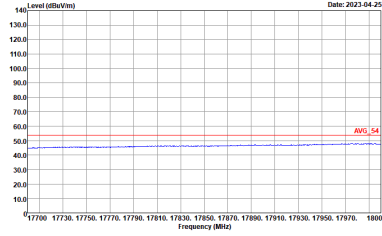

BLE	2.4GHz 2400~2483.5MHz Harmonic @ 3m	
BLE CH00 2402MHz		
Horizontal		Vertical
<p>14.47G ~14.5G Avg.</p>	 <p>Site : 03CH20-HY Condition : AV6_54 3m 91200_02360_221104 HORIZONTAL</p>	 <p>Site : 03CH20-HY Condition : AV6_54 3m 91200_02360_221104 VERTICAL</p>
<p>17.7G ~18G Avg</p>	 <p>Site : 03CH20-HY Condition : AV6_54 3m 91200_02360_221104 HORIZONTAL</p>	 <p>Site : 03CH20-HY Condition : AV6_54 3m 91200_02360_221104 VERTICAL</p>

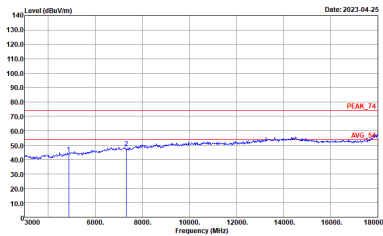
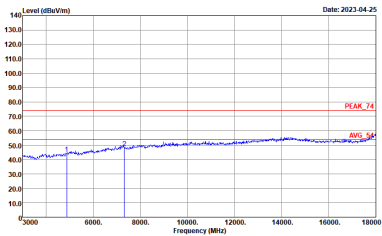

BLE	2.4GHz 2400~2483.5MHz Harmonic @ 3m	
	BLE CH19 2440MHz	
	Horizontal	Vertical
Peak Avg.	 <p>Site : 03CH20-HY Condition : PEAK_74 3m 9120D_02360_221104 HORIZONTAL :</p>	 <p>Site : 03CH20-HY Condition : PEAK_74 3m 9120D_02360_221104 VERTICAL :</p>

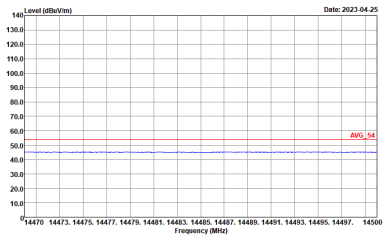
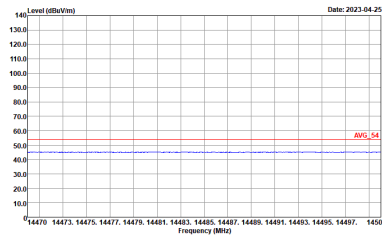
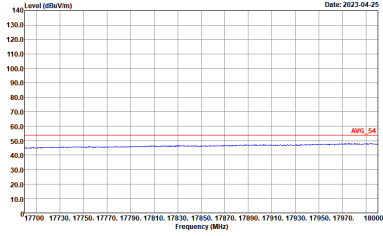
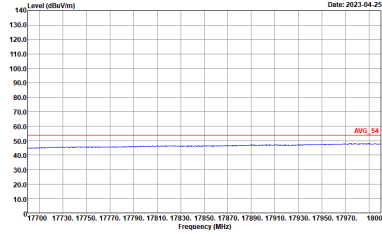

BLE	2.4GHz 2400~2483.5MHz Harmonic @ 3m	
BLE CH19 2440MHz		
Horizontal		Vertical
<p>14.47G ~14.5G Avg.</p>	 <p>Site : 03CH20-HY Condition : AV6_54 3m 91200_02360_221104 HORIZONTAL</p>	 <p>Site : 03CH20-HY Condition : AV6_54 3m 91200_02360_221104 VERTICAL</p>
<p>17.7G ~18G Avg</p>	 <p>Site : 03CH20-HY Condition : AV6_54 3m 91200_02360_221104 HORIZONTAL</p>	 <p>Site : 03CH20-HY Condition : AV6_54 3m 91200_02360_221104 VERTICAL</p>

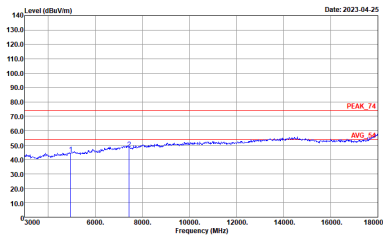
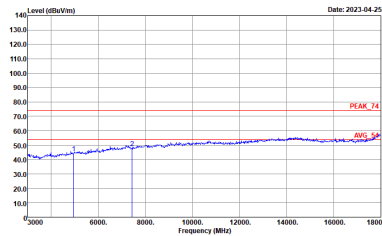

BLE	2.4GHz 2400~2483.5MHz Harmonic @ 3m	
	BLE CH39 2480MHz	
	Horizontal	Vertical
Peak	 <p>Site : 03CH20-HY Condition : PEAK_74 3m 9120D_02360_221104 HORIZONTAL</p>	 <p>Site : 03CH20-HY Condition : PEAK_74 3m 9120D_02360_221104 VERTICAL</p>

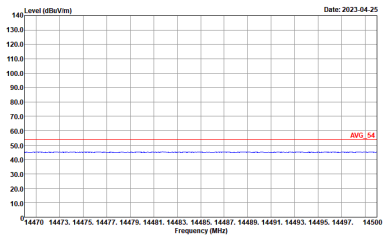
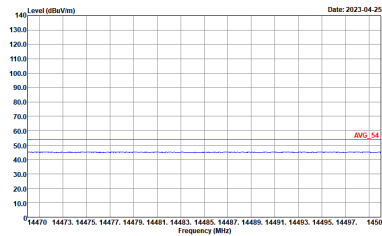
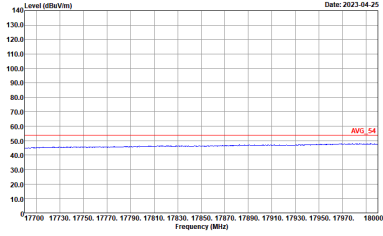
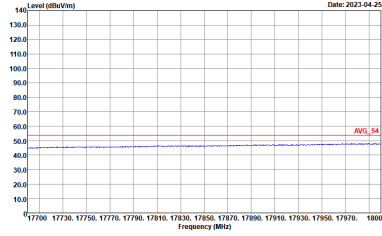

BLE	2.4GHz 2400~2483.5MHz Harmonic @ 3m	
BLE CH39 2480MHz		
Horizontal		Vertical
<p>14.47G ~14.5G Avg.</p>	 <p>Site : 03CH20-HY Condition : AV6_54 3m 91200_02360_221104 HORIZONTAL</p>	 <p>Site : 03CH20-HY Condition : AV6_54 3m 91200_02360_221104 VERTICAL</p>
<p>17.7G ~18G Avg</p>	 <p>Site : 03CH20-HY Condition : AV6_54 3m 91200_02360_221104 HORIZONTAL</p>	 <p>Site : 03CH20-HY Condition : AV6_54 3m 91200_02360_221104 VERTICAL</p>



Emission above 18GHz

2.4GHz BLE (SHF @ 1m)

BLE	2.4GHz 2400~2483.5MHz	
	BLE SHF	
	Horizontal	Vertical
Peak Avg.	<p>Site : 03CH20-HY Condition : PEAK_74 1m SHF_00994_221104 HORIZONTAL</p>	<p>Site : 03CH20-HY Condition : PEAK_74 1m SHF_00994_221104 VERTICAL</p>



Emission below 1GHz

2.4GHz BLE (LF)

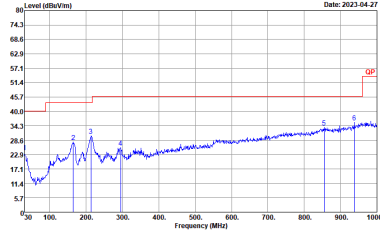
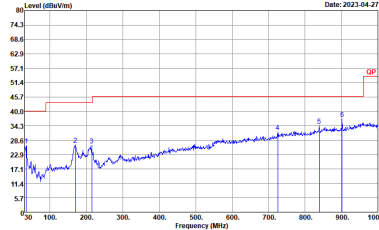
BLE	2.4GHz 2400~2483.5MHz	
	BLE LF	
	Horizontal	Vertical
QP / Peak	 <p>Site : :03CH20-4Y Condition : :QP 3m LF_55606608_221022 HORIZONTAL</p>	 <p>Site : :03CH20-4Y Condition : :QP 3m LF_55606608_221022 VERTICAL</p>



Appendix E. Duty Cycle Plots

Band	Duty Cycle(%)	T(us)	1/T(kHz)	VBW Setting
Bluetooth –LE for 1Mbps	62.68	393	2.54	3kHz
Bluetooth –LE for 2Mbps	33.01	207	4.83	10kHz

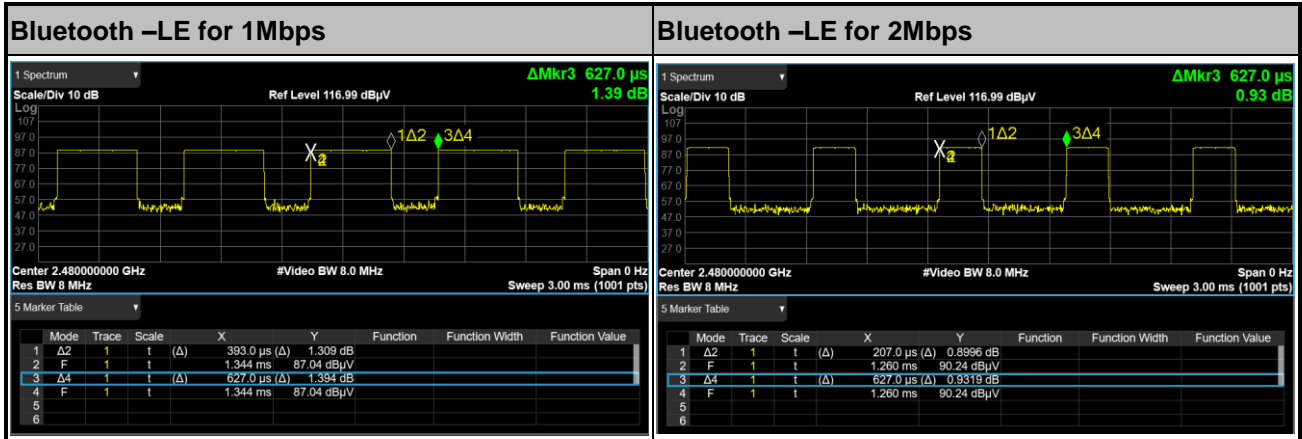

————THE END————