



FCC RADIO TEST REPORT

FCC ID : A4RGC3VE
Equipment : Phone
Model Name : GC3VE
Applicant : Google LLC
1600 Amphitheatre Parkway,
Mountain View, California, 94043 USA
Standard : FCC Part 15 Subpart E §15.407

The product was received on Mar. 29, 2023 and testing was performed from Apr. 13, 2023 to Jun. 07, 2023. We, Sporton International Inc. Wensan Laboratory, would like to declare that the tested sample has been evaluated in accordance with the test procedures and has been in compliance with the applicable technical standards.

The test results in this report apply exclusively to the tested model / sample. Without written approval from Sporton International Inc. Wensan Laboratory, the test report shall not be reproduced except in full.

Approved by: Louis Wu

Sporton International Inc. Wensan Laboratory

No.58, Aly. 75, Ln. 564, Wenhua 3rd, Rd., Guishan Dist., Taoyuan City 333010, Taiwan (R.O.C.)



Table of Contents

History of this test report.....	3
Summary of Test Result.....	4
1 General Description	5
1.1 Product Feature of Equipment Under Test.....	5
1.2 Product Specification of Equipment Under Test.....	6
1.3 Modification of EUT	8
1.4 Testing Location	8
1.5 Applicable Standards.....	8
2 Test Configuration of Equipment Under Test	9
2.1 Carrier Frequency and Channel	9
2.2 Test Mode.....	10
2.3 Connection Diagram of Test System.....	11
2.4 Support Unit used in test configuration and system	12
2.5 EUT Operation Test Setup	12
2.6 Measurement Results Explanation Example.....	13
3 Test Result	14
3.1 6dB and 26dB and 99% Occupied Bandwidth Measurement	14
3.2 Maximum E.I.R.P Output Power Measurement	20
3.3 Power Spectral Density Measurement	21
3.4 Unwanted Emissions Measurement.....	28
3.5 AC Conducted Emission Measurement.....	33
3.6 Antenna Requirements	35
4 List of Measuring Equipment.....	36
5 Measurement Uncertainty	38
Appendix A. Conducted Test Results	
Appendix B. AC Conducted Emission Test Result	
Appendix C. Radiated Spurious Emission	
Appendix D. Radiated Spurious Emission Plots	
Appendix E. Duty Cycle Plots	
Appendix F. Setup Photographs	



Summary of Test Result

Report Clause	Ref Std. Clause	Test Items	Result (PASS/FAIL)	Remark
3.1	15.407(e)	6dB & 26dB Bandwidth	Pass	-
3.1	2.1049	99% Occupied Bandwidth	Reporting only	-
3.2	15.407(a)	Maximum E.I.R.P Output Power	Pass	-
3.3	15.407(a)	Power Spectral Density	Pass	-
3.4	15.407(b)	Unwanted Emissions	Pass	1.60 dB under the limit at 17655.00 MHz
3.5	15.207	AC Conducted Emission	Pass	13.24 dB under the limit at 1.58 MHz
3.6	15.203	Antenna Requirement	Pass	-

Conformity Assessment Condition:

1. The test results (PASS/FAIL) with all measurement uncertainty excluded are presented against the regulation limits or in accordance with the requirements stipulated by the applicant/manufacturer who shall bear all the risks of non-compliance that may potentially occur if measurement uncertainty is taken into account.
2. The measurement uncertainty please refer to each test result in the section "Measurement Uncertainty".

Disclaimer:

The product specifications of the EUT presented in the test report that may affect the test assessments are declared by the manufacturer who shall take full responsibility for the authenticity.

Reviewed by: William Chen**Report Producer: Ming Chen**



1 General Description

1.1 Product Feature of Equipment Under Test

Product Feature	
Equipment	Phone
Model Name	GC3VE
FCC ID	A4RGC3VE
EUT supports Radios application	GSM/EGPRS/WCDMA/HSPA/LTE/5G NR/NFC/GNSS/ UWB/WPT WLAN 11b/g/n HT20 WLAN 11a/n HT20/HT40 WLAN 11ac VHT20/VHT40/VHT80/VHT160 WLAN 11ax HE20/HE40/HE80/HE160 WLAN 11be EHT20/EHT40/EHT80/EHT160 Bluetooth BR/EDR/LE/HR

Remark: The above EUT's information was declared by manufacturer.

EUT Information List	
S/N	Performed Test Item
33141FDJG000WZ	RF Conducted Measurement
33141FDJG0009M 34281FDJG0009K	Radiated Spurious Emission
33141FDJG000BQ	Conducted Emission

1.2 Product Specification of Equipment Under Test

Product Specification is subject to this standard								
Tx/Rx Frequency Range	5850 MHz ~ 5895 MHz							
Maximum Output Power	MIMO <Ant. 3+4> 802.11a: 21.17 dBm / 0.1309 W 802.11n HT20: 21.31 dBm / 0.1352 W 802.11n HT40: 21.57 dBm / 0.1435 W 802.11ac VHT20: 21.25 dBm / 0.1334 W 802.11ac VHT40: 21.57 dBm / 0.1435 W 802.11ac VHT80: 22.11 dBm / 0.1626 W 802.11ac VHT160: 22.11 dBm / 0.1626 W 802.11ax HE20: 21.31 dBm / 0.1352 W 802.11ax HE40: 21.57dBm / 0.1435 W 802.11ax HE80: 22.11 dBm / 0.1626 W 802.11ax HE160: 22.11 dBm / 0.1626 W 802.11be EHT20: 21.47 dBm / 0.1403 W 802.11be EHT40: 21.72 dBm / 0.1786W 802.11be EHT80: 22.31 dBm / 0.1702 W 802.11be EHT160: 22.26 dBm / 0.1683 W							
99% Occupied Bandwidth	MIMO <Ant. 3> 802.11a: 17.53 MHz 802.11be EHT20: 19.43 MHz 802.11be EHT40: 38.16 MHz 802.11be EHT80: 77.44 MHz 802.11be EHT160: 157.76 MHz MIMO <Ant. 4> 802.11a: 17.13 MHz 802.11be EHT20: 19.28 MHz 802.11be EHT40: 38.16 MHz 802.11be EHT80: 77.56 MHz 802.11be EHT160: 157.76 MHz							
Antenna Type / Gain	<Ant. 3>: PIFA Antenna with gain -1.2 dBi <Ant. 4>: IFA Antenna with gain -1.5 dBi							
Type of Modulation	802.11a/n : OFDM (BPSK / QPSK / 16QAM / 64QAM) 802.11ac : OFDM (BPSK / QPSK / 16QAM / 64QAM / 256QAM) 802.11ax : OFDMA (BPSK / QPSK / 16QAM / 64QAM / 256QAM / 1024QAM) 802.11be : OFDMA (BPSK / QPSK / 16QAM / 64QAM / 256QAM / 1024QAM/4096QAM)							
Antenna Function Description	<table border="1"> <thead> <tr> <th></th> <th>Ant. 3</th> <th>Ant. 4</th> </tr> </thead> <tbody> <tr> <td>802.11a/n/ac/ax/be MIMO</td> <td>V</td> <td>V</td> </tr> </tbody> </table>			Ant. 3	Ant. 4	802.11a/n/ac/ax/be MIMO	V	V
	Ant. 3	Ant. 4						
802.11a/n/ac/ax/be MIMO	V	V						

Remark:

- MIMO Ant. 3+4 Directional Gain is a calculated result from MIMO Ant. 3 and MIMO Ant. 4. The formula used in calculation is documented in section 1.2.1.
- Power of MIMO Ant. 3 + Ant. 4 is a calculated result from sum of the power MIMO Ant. 3 and MIMO Ant. 4.
- The EUT's information above is declared by manufacturer. Please refer to Disclaimer in report summary.



1.2.1 Antenna Directional Gain

Follows FCC KDB 662911 D01 Multiple Transmitter Output v02r01 F)2)f)ii)

Directional gain = G_{ANT} + Array Gain, where Array Gain is as follows:

For power measurements on IEEE 802.11 devices,

Array Gain = 0 dB (i.e., no array gain) for N_{ANT} ≤ 4.

G_{ANT} is set equal to the gain of the antenna having the highest gain.

For PSD measurements, the directional gain calculation.

$$DirectionalGain = 10 \cdot \log \left[\frac{\sum_{j=1}^{N_{SS}} \left\{ \sum_{k=1}^{N_{ANT}} g_{j,k} \right\}^2}{N_{ANT}} \right]$$

where

Each antenna is driven by no more than one spatial stream;

N_{SS} = the number of independent spatial streams of data;

N_{ANT} = the total number of antennas

$g_{j,k} = 10^{G_k / 20}$ if the kth antenna is being fed by spatial stream j, or zero if it is not; G_k is the gain in dBi of the kth antenna.

As minimum N_{SS}=1 is supported by EUT, the formula can be simplified as:

Directional gain = 10*log[(10^{G1/20} + 10^{G2/20} + ... + 10^{GN/20})² /N_{ANT}] dBi

Where G1, G2...GN denote single antenna gain.

The directional gain "DG" is calculated as following table.

UNII-4			DG	DG
			for	for
	Ant 3	Ant 4	Power	PSD
	(dBi)	(dBi)	(dBi)	(dBi)
	-1.20	-1.50	-1.20	1.66

Calculation example:

If a device has two antenna, G_{ANT1}= -1.20 dBi; G_{ANT2}=-1.50 dBi

Directional gain of power measurement = max(-1.20, -1.50) + 0 = -1.20 dBi

Directional gain of PSD derived from formula which is

$$10 \times \log \left\{ \left[10^{(-1.20 \text{ dBi} / 20)} + 10^{(-1.50 \text{ dBi} / 20)} \right]^2 / 2 \right\} = 1.66 \text{ dBi}$$



1.3 Modification of EUT

No modifications are made to the EUT during all test items.

1.4 Testing Location

Test Site	Sporton International Inc. EMC & Wireless Communications Laboratory
Test Site Location	No.52, Huaya 1st Rd., Guishan Dist., Taoyuan City 333, Taiwan (R.O.C.) TEL: +886-3-327-3456 FAX: +886-3-328-4978
Test Site No.	Sporton Site No. CO05-HY (TAF Code: 1190)
Remark	The Conducted Emission test item subcontracted to Sporton International Inc. EMC & Wireless Communications Laboratory.

Note: The test site complies with ANSI C63.4 2014 requirement.

Test Site	Sporton International Inc. Wensan Laboratory
Test Site Location	No.58, Aly. 75, Ln. 564, Wenhua 3rd, Rd., Guishan Dist., Taoyuan City 333010, Taiwan (R.O.C.) TEL: +886-3-327-0868 FAX: +886-3-327-0855
Test Site No.	Sporton Site No. TH05-HY, 03CH13-HY

Note: The test site complies with ANSI C63.4 2014 requirement.

FCC designation No.: TW1190 and TW3786

1.5 Applicable Standards

According to the specifications of the manufacturer, the EUT must comply with the requirements of the following standards:

- ♦ FCC Part 15 Subpart E
- ♦ FCC KDB 789033 D02 General UNII Test Procedures New Rules v02r01.
- ♦ FCC KDB 414788 D01 Radiated Test Site v01r01.
- ♦ FCC KDB 662911 D01 Multiple Transmitter Output v02r01.
- ♦ FCC KDB 291074 D02 EMC Measurement v01(Draft)
- ♦ ANSI C63.10-2013

Remark:

1. All the test items were validated and recorded in accordance with the standards without any modification during the testing.
2. The TAF code is not including all the FCC KDB listed without accreditation.



2 Test Configuration of Equipment Under Test

- a. The EUT has been associated with peripherals and configuration operated in a manner tended to maximize its emission characteristics in a typical application. Frequency range investigated: conduction emission (150 kHz to 30 MHz), radiation emission (9 kHz to the 10th harmonic of the highest fundamental frequency or to 40 GHz, whichever is lower). For radiated measurement, the measured emission level of the EUT was maximized by rotating the EUT on a turntable, adjusting the orientation of the EUT antenna in three orthogonal axis (X: flat, Y: portrait, Z: landscape) and accessory (Adapter or Earphone), and adjusting the measurement antenna orientation, following C63.10 exploratory test procedures and only the worst case emissions were reported in this report.
- b. AC power line Conducted Emission was tested under maximum output power.

2.1 Carrier Frequency and Channel

Frequency Band	Bandwidth	Channel	Frequency (MHz)	Note
5850-5895 MHz (U-NII-4)	20 MHz	169	5845	Straddle
		173	5865	
		177	5885	
	40 MHz	167	5835	Straddle
		175	5875	
	80 MHz	171	5855	Straddle
160 MHz	163	5815	Straddle	

Note: The channel noted with "straddle" spans 5.725-5.850 GHz and 5.850-5.895 GHz.



2.2 Test Mode

This device supports WiFi 802.11be 20MHz bandwidth for 2.4GHz and 160MHz bandwidth for both 5GHz and 6GHz.

This device supports 26/52/106/242/484/996 single tone RU modes for 802.11ax/be modes and the 242/484/996-tone RU modes are covered by 20/40/80MHz channels.

This device supports MRU 52T+26T/106T+26T (small RU) and punctured modes (large RU) for 802.11be mode.

The PSD of partial RU/MRU modes are reduced to be smaller than full RU according to TCB workshop interim guidance Oct. 2018 and Oct. 2022 for WiFi 7 device.

The 802.11ax/be modes are investigated among full RU, single RU and MRU modes for emission spot check and the 11ax modes are covered by 11be modes.

The PSD and power of partial RU and MRU are less than full RU configurations so the full RU is chosen as main test configuration.

The SISO mode conducted power is covered by MIMO mode per chain, so only the MIMO mode is chosen as main test configuration..

The power for 802.11n, 802.11ac and 802.11ax mode is smaller than 802.11be mode, so all other conducted and radiated test is covered by 802.11be mode.

The final test modes include the worst data rates for each modulation shown in the table below.

Specification	MCS index /Data Rate
802.11a	6 Mbps
802.11n HT20 (Covered by EHT20)	MCS0
802.11n HT40 (Covered by EHT40)	MCS0
802.11ac VHT20 (Covered by EHT20)	MCS0
802.11ac VHT40 (Covered by EHT40)	MCS0
802.11ac VHT80 (Covered by EHT80)	MCS0
802.11ac VHT160 (Covered by EHT160)	MCS0
802.11ax HE20 (Covered by EHT20)	MCS0
802.11ax HE40 (Covered by EHT40)	MCS0
802.11ax HE80 (Covered by EHT80)	MCS0
802.11ax HE160 (Covered by EHT160)	MCS0
802.11be EHT20	MCS0
802.11be EHT40	MCS0
802.11be EHT80	MCS0
802.11be EHT160	MCS0

Remark: The conducted power level of each chain in MIMO mode is equal or higher than SISO mode.

Test Cases	
AC Conducted Emission	Mode 1 : GSM850 Idle + WLAN (5GHz) Link + Bluetooth Link + USB cable 1 (Charging from AC Adapter 2)
Remark:	
1. For Radiated Test Cases, the tests were performed with Adapter 1 and USB Cable 1. 2. During the preliminary test, both charging modes (Adapter mode and WPT mode) were verified. It is determined that the adaptor mode is the worst case for official test.	

Ch. #		RF test channel of UNII-4 and UNII-3 & -4 span channels				
		802.11a	802.11be EHT20	802.11be EHT40	802.11be EHT80	802.11be EHT160
L	Low	169	169	167	-	-
M	Middle	173	173	-	171	163
H	High	177	177	175	-	-

Remark: For radiation spurious emission, the modulation and the data rate picked for testing are determined by the Max. RF conducted power.

2.3 Connection Diagram of Test System

<AC Conducted Emission Mode>

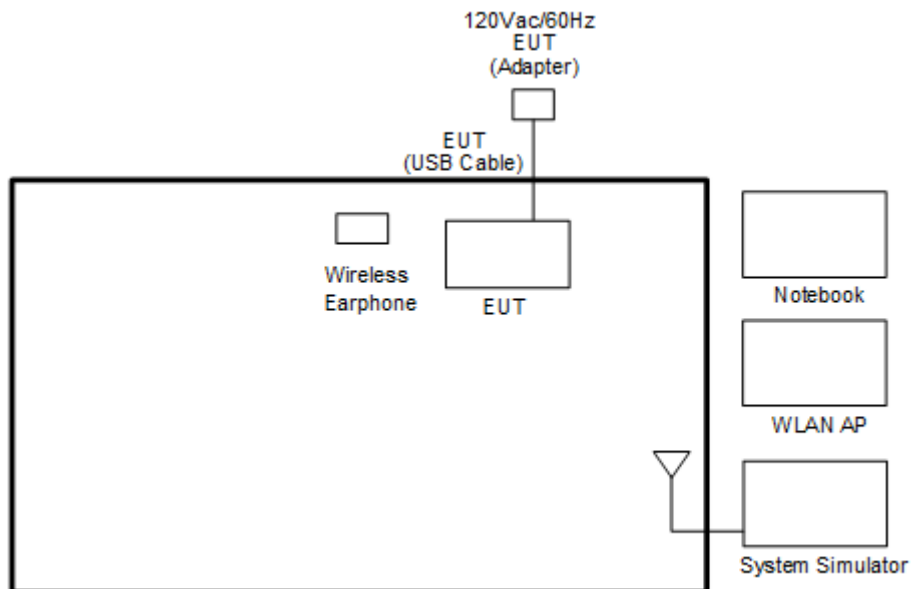

<WLAN Tx Mode>

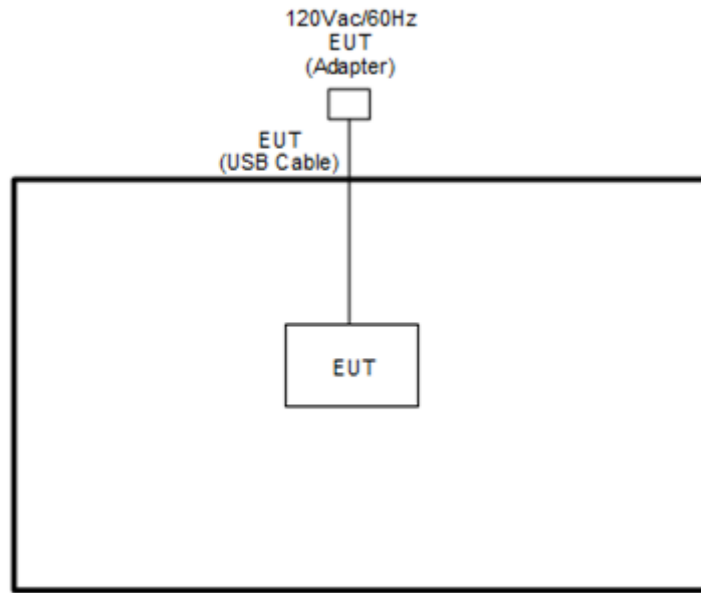

2.4 Support Unit used in test configuration and system

Item	Equipment	Brand Name	Model Name	FCC ID	Data Cable	Power Cord
1.	System Simulator	Anritsu	MT8820C	N/A	N/A	Unshielded, 1.8 m
2.	Wireless Earphone	Google	G1007/G1008	A4RG1007/ A4RG1008	N/A	N/A
3.	WLAN AP	D-Link	RT-AC66U	MSQ-RTAC66U	N/A	Unshielded, 1.8 m
4.	Notebook	DELL	Latitude 3420	FCC DoC	N/A	AC I/P: Unshielded, 1.2 m DC O/P: Shielded, 1.8 m
5.	Notebook	Acer	N18Q13	PD9AX201NG	N/A	AC I/P: Unshielded, 1.2 m DC O/P: Shielded, 1.8 m

2.5 EUT Operation Test Setup

The RF test items, utility “CMD v.10.0.19045.2965” was installed in Notebook which was programmed in order to make the EUT get into the engineering modes to provide channel selection, power level, data rate and the application type and for continuous transmitting signals.



2.6 Measurement Results Explanation Example

For all conducted test items:

The offset level is set in the spectrum analyzer to compensate the RF cable loss and attenuator factor between EUT conducted output port and spectrum analyzer. With the offset compensation, the spectrum analyzer reading level is exactly the EUT RF output level.

Example :

The spectrum analyzer offset is derived from RF cable loss and attenuator factor.

Offset = RF cable loss + attenuator factor.

Following shows an offset computation example with cable loss 4.2 dB and 10 dB attenuator.

$$\begin{aligned} \text{Offset(dB)} &= \text{RF cable loss(dB)} + \text{attenuator factor(dB)}. \\ &= 4.2 + 10 = 14.2 \text{ (dB)} \end{aligned}$$

3 Test Result

3.1 6dB and 26dB and 99% Occupied Bandwidth Measurement

3.1.1 Description of 6dB and 26dB and 99% Occupied Bandwidth

The minimum 6 dB bandwidth shall be at least 500 kHz.

26dB and 99% Occupied bandwidth are reporting only.

3.1.2 Measuring Instruments

See list of measuring equipment of this test report.

3.1.3 Test Procedures

The testing follows FCC KDB 291074 D02 EMC Measurement v01 (Draft) Section 2.11 Minimum Emission bandwidth

1. Set RBW = 100 kHz.
2. Set the VBW $\geq 3 \times$ RBW.
3. Detector = Peak.
4. Trace mode = max hold
5. Measure the maximum width of the emission that is 6 dB down from the peak of the emission.
6. Measure and record the results in the test report.

3.1.4 Test Setup

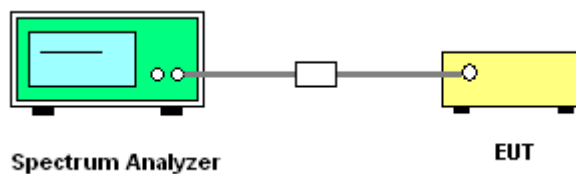

3.1.5 Test Result of 6dB and 26dB and 99% Occupied Bandwidth

Please refer to Appendix A.



MIMO <Ant. 3+4>

<802.11a>

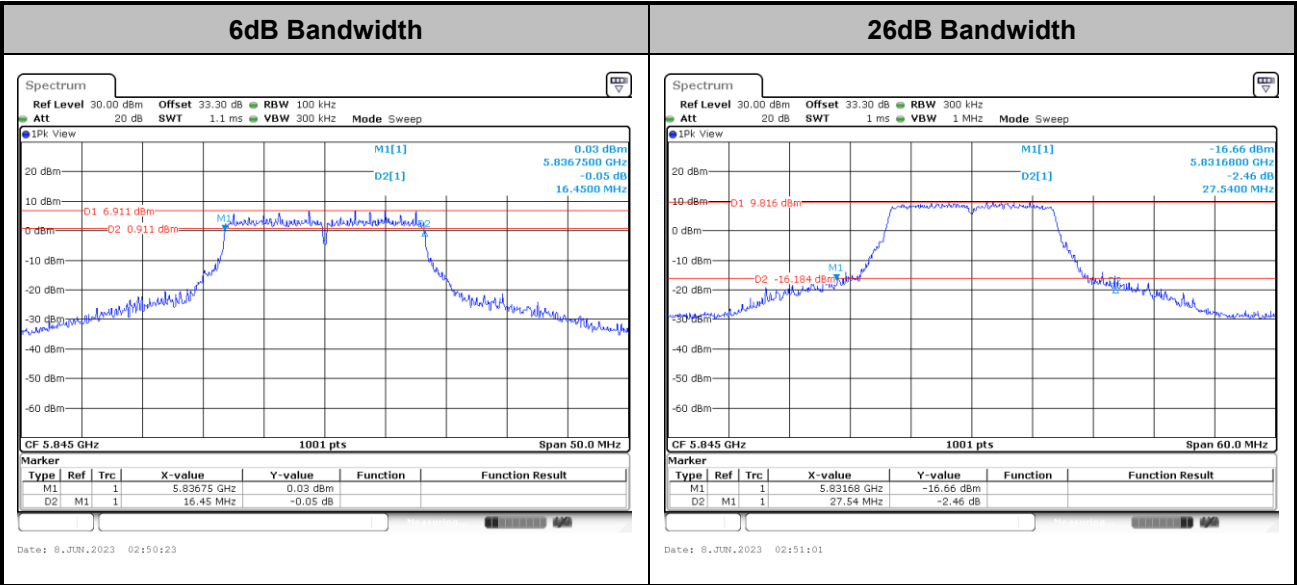

Occupied Bandwidth

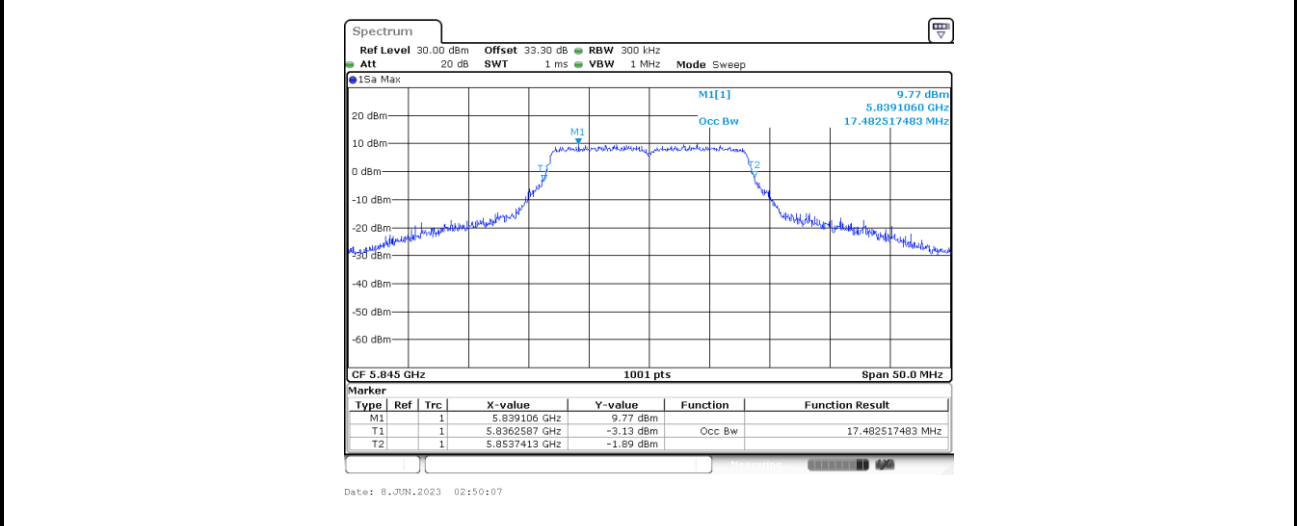

Note: The occupied channel bandwidth is maintained within the band of operation.



<802.11be EHT20>

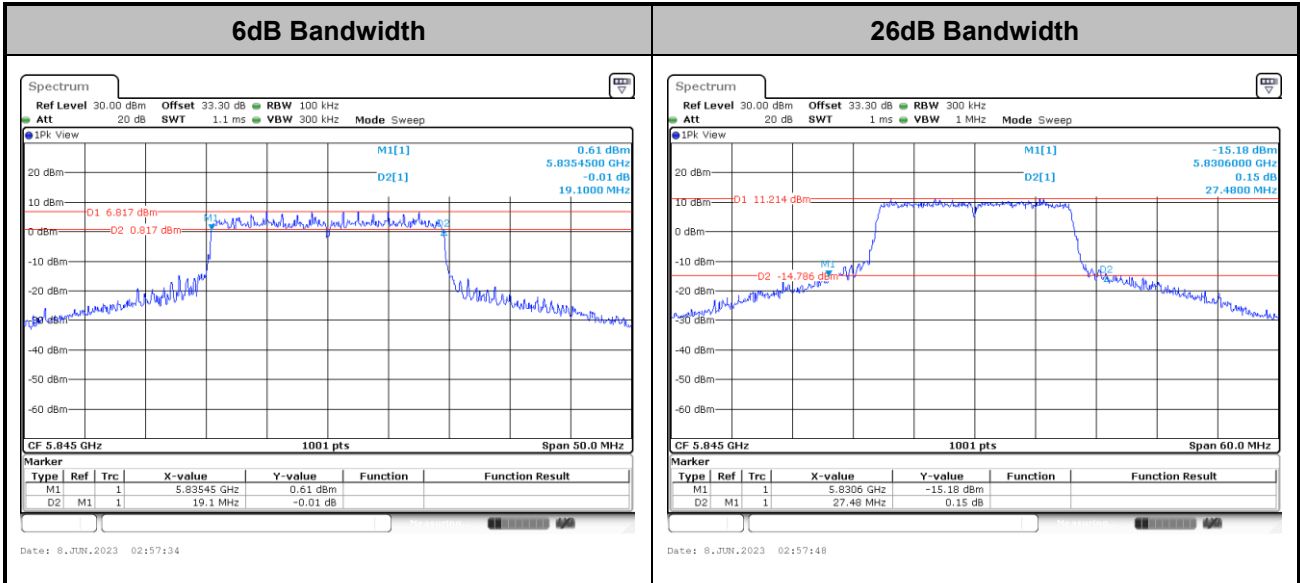

Occupied Bandwidth

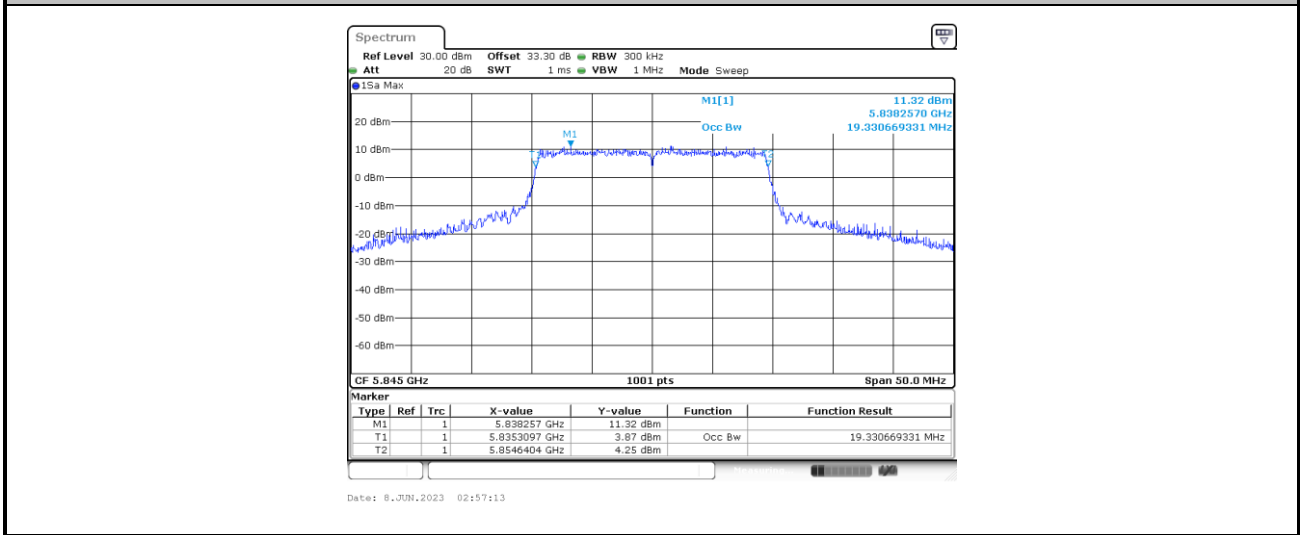

Note: The occupied channel bandwidth is maintained within the band of operation.



<802.11be EHT40>

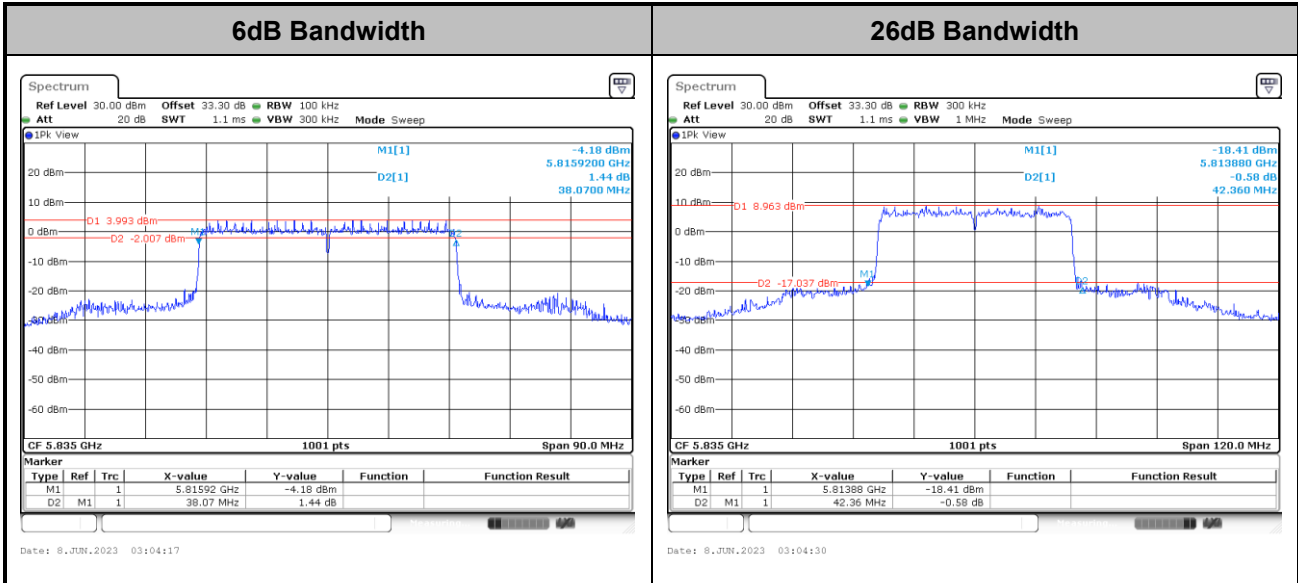

Occupied Bandwidth

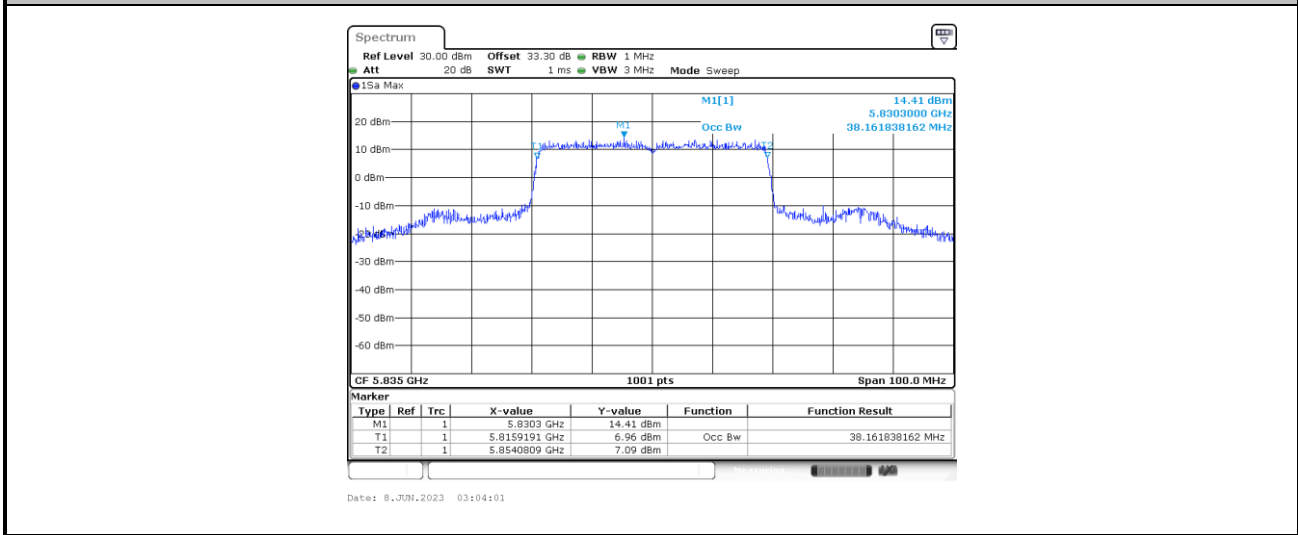

Note: The occupied channel bandwidth is maintained within the band of operation.



<802.11be EHT80>

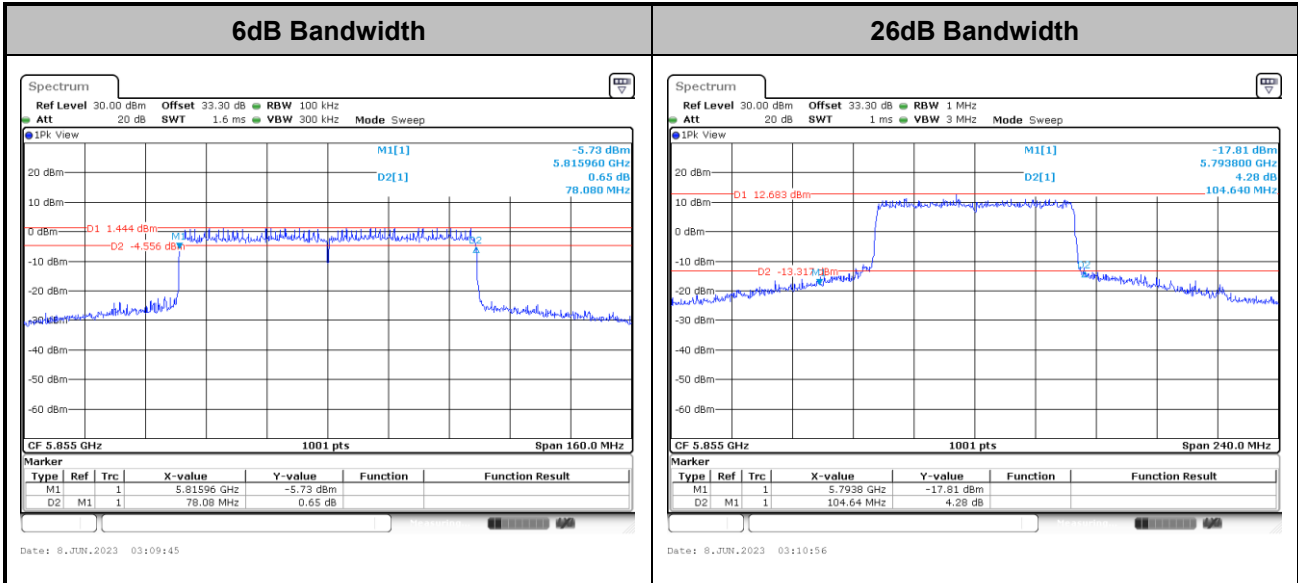

Occupied Bandwidth

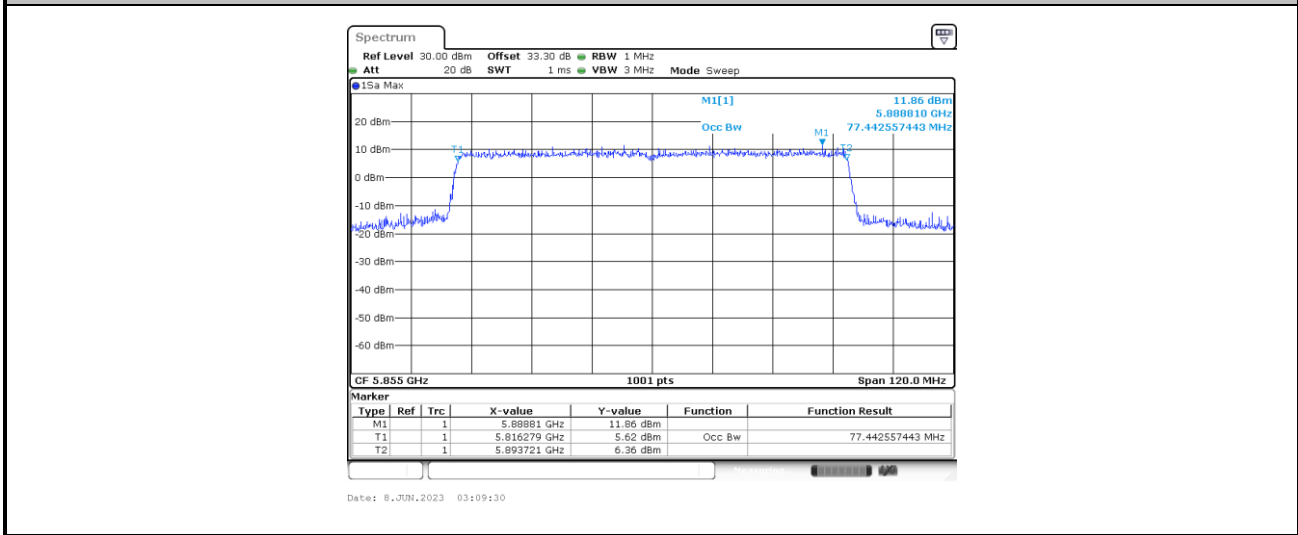

Note: The occupied channel bandwidth is maintained within the band of operation.



<802.11be EHT160>

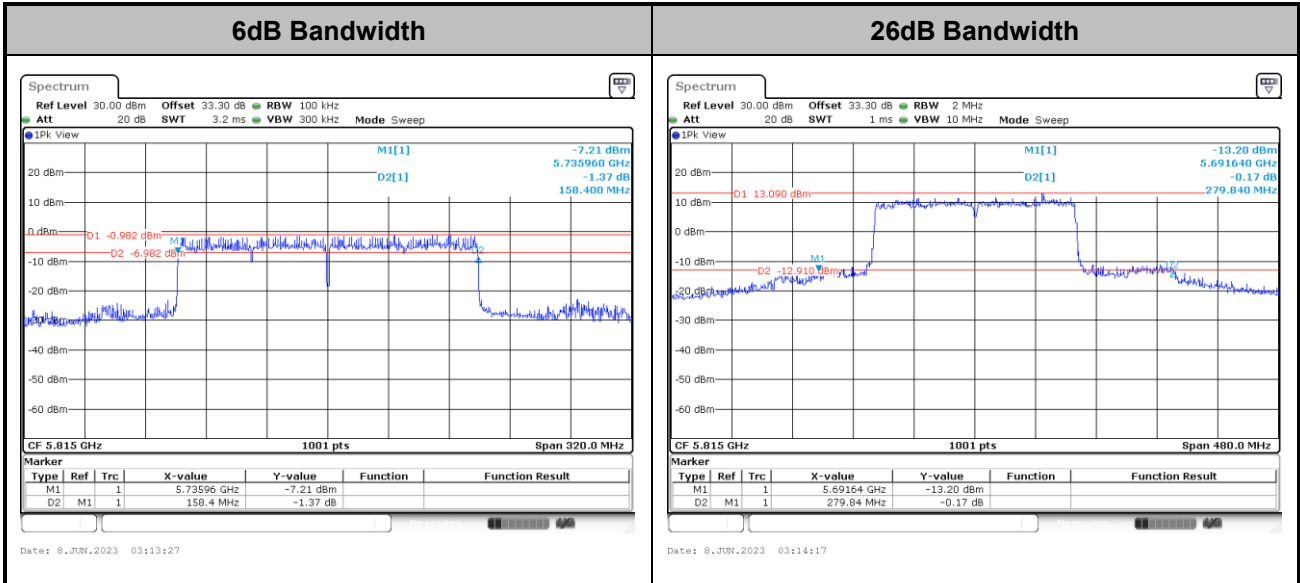

Occupied Bandwidth

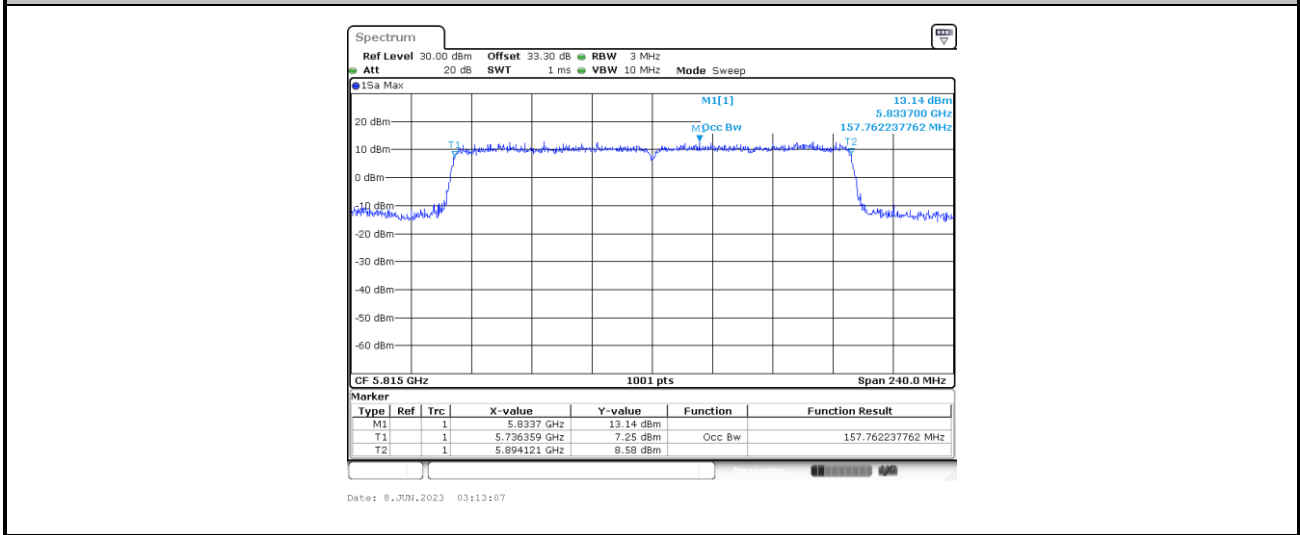

Note: The occupied channel bandwidth is maintained within the band of operation.

3.2 Maximum E.I.R.P Output Power Measurement

3.2.1 Limit of Maximum E.I.R.P Output Power

For client devices operating under the control of an indoor access point in the 5.850-5.895 GHz band, the maximum power spectral density must not exceed 14 dBm e.i.r.p. in any 1-megahertz band, and the maximum e.i.r.p. over the frequency band of operation must not exceed 30 dBm. Client devices operating on a channel that spans the 5.725-5.850 GHz and 5.850-5.895 GHz bands must not exceed an e.i.r.p. of 30 dBm.

3.2.2 Measuring Instruments

See list of measuring equipment of this test report.

3.2.3 Test Procedures

The testing follows Method PM-G of FCC KDB 789033 D02 General UNII Test Procedures New Rules v02r01.

Method PM-G (Measurement using a gated RF average power meter):

1. Measurement is performed using a wideband RF power meter.
2. The EUT is configured to transmit at its maximum power control level.
3. Measure the average power of the transmitter.
4. Since the measurement is made only during the ON time of the transmitter, no duty cycle correction factor is required.
5. For MIMO mode, calculation method follows FCC KDB 662911 D01 Multiple Transmitter Output v02r01.

3.2.4 Test Setup

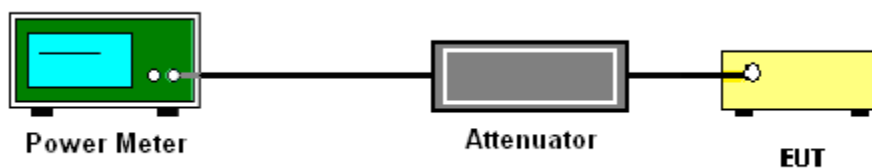

3.2.5 Test Result of Maximum Conducted Output Power

Please refer to Appendix A.



3.3 Power Spectral Density Measurement

3.3.1 Limit of Power Spectral Density

1. For client devices operating under the control of an indoor access point in the 5.850-5.895 GHz band, the maximum power spectral density must not exceed 14 dBm e.i.r.p. in any 1-megahertz band
2. For client devices operating on a channel that spans the 5.725-5.850 GHz and 5.850-5.895 GHz bands shall meet both 15.407(a)(3)(i) 30dBm/500kHz and 15.407(a)(3)(iii) 14dBm/MHz limit, where the stringent limit 14dBm/MHz is applied.

3.3.2 Measuring Instruments

See list of measuring equipment of this test report.

3.3.3 Test Procedures

The testing follows FCC KDB 789033 D02 General UNII Test Procedures New Rules v02r01. Section F) Maximum power spectral density.

Method SA-2

(trace averaging across on and off times of the EUT transmissions, followed by duty cycle correction).

- Measure the duty cycle.
- Set span to encompass the entire emission bandwidth (EBW) of the signal.
- Set RBW = 1 MHz.
- Set VBW \geq 3 MHz.
- Number of points in sweep \geq 2 Span / RBW.
- Sweep time = auto.
- Detector = RMS
- Trace average at least 100 traces in power averaging mode.
- Add $10 \log(1/x)$, where x is the duty cycle, to the measured power in order to compute the average power during the actual transmission times. For example, add $10 \log(1/0.25) = 6$ dB if the duty cycle is 25 percent.

1. The RF output of EUT is connected to the spectrum analyzer by a low loss cable.
2. Each plot has already offset with cable loss, and attenuator loss. Measure the PPSD and record it.
3. For MIMO mode, calculation method follows FCC KDB 662911 D01 Multiple Transmitter Output v02r01.

Method (a): Measure and sum the spectra across the outputs.

The total final Power Spectral Density is from a device with 2 transmitter outputs. The spectrum measurements of the individual outputs are all performed with the same span and number of points; the spectrum value in the first spectral bin of output 1 is summed with that in the first spectral bin of output 2 to obtain the value for the first frequency bin of the summed spectrum.

3.3.4 Test Setup

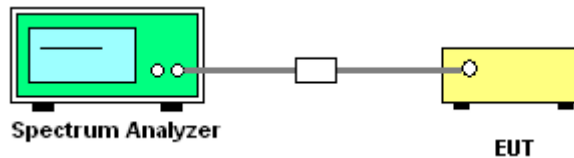

3.3.5 Test Result of Power Spectral Density

Please refer to Appendix A.



<802.11a>

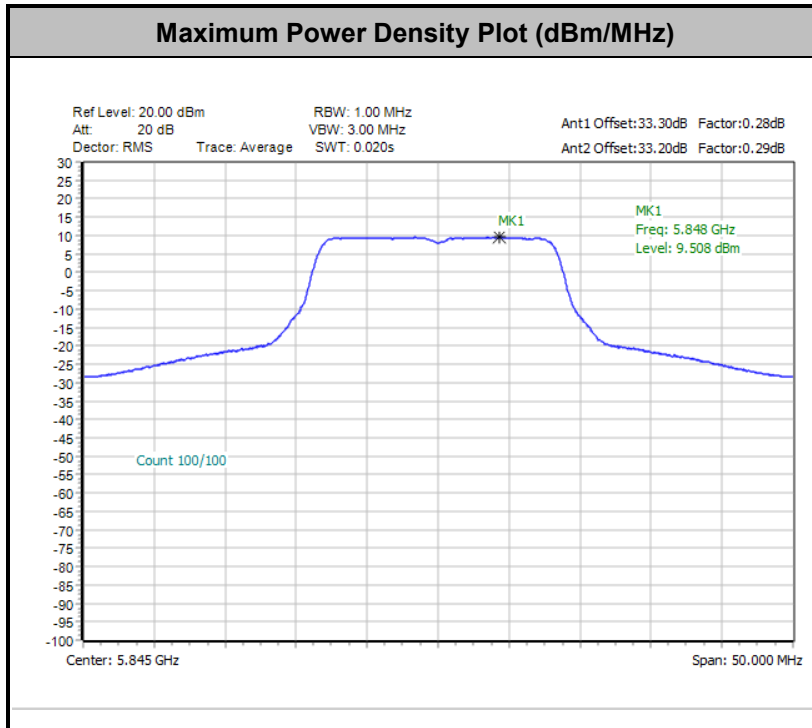

Remark: The test plot is showing a bin by bin combined result mathematically adds two traces.

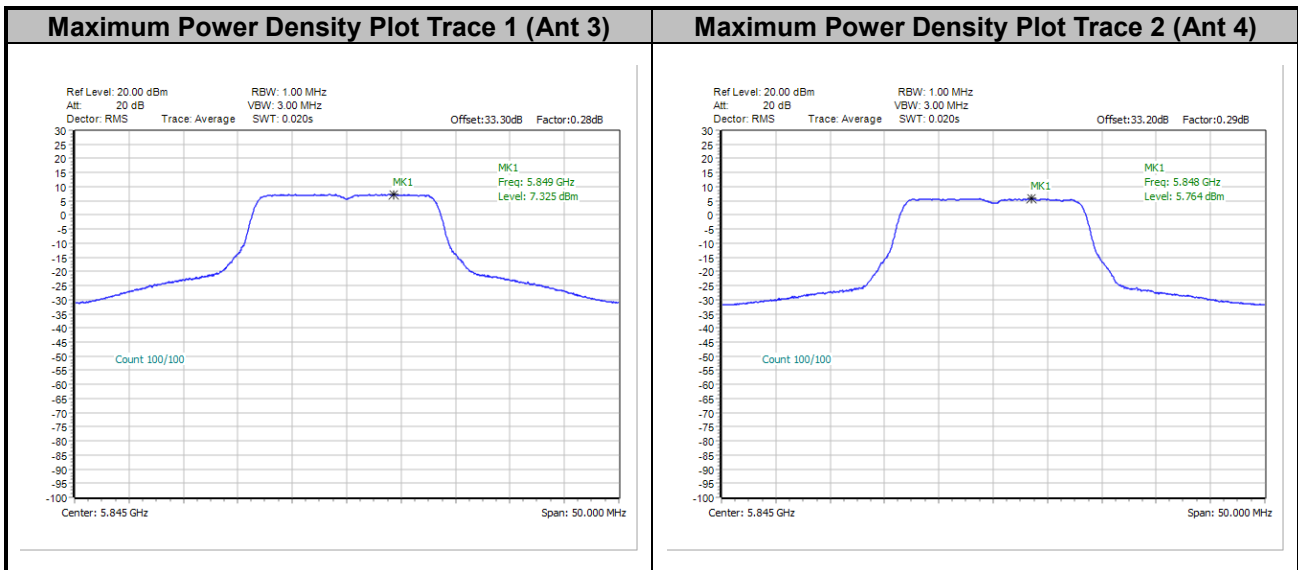



<802.11be EHT20 Full RU>

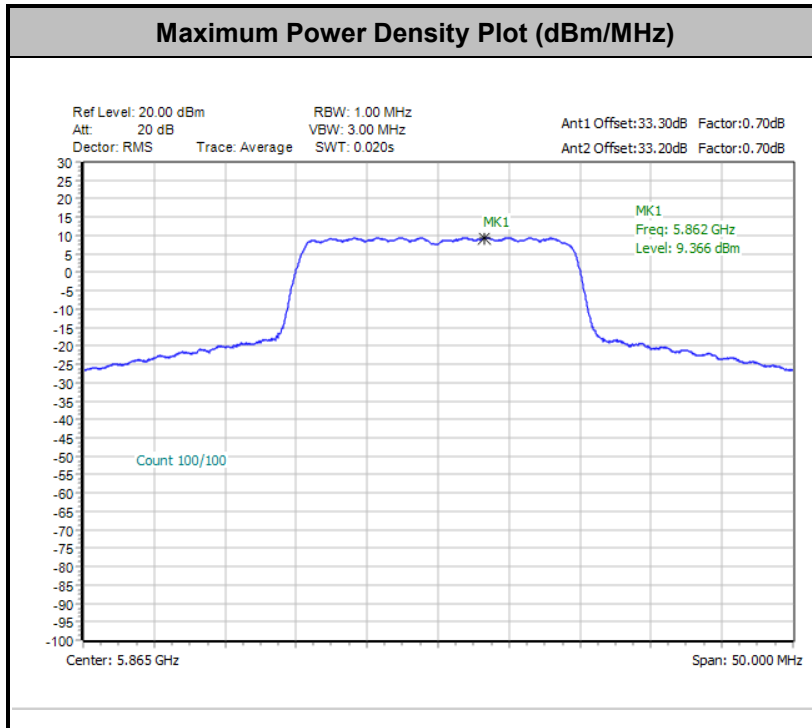

Remark: The test plot is showing a bin by bin combined result mathematically adds two traces.

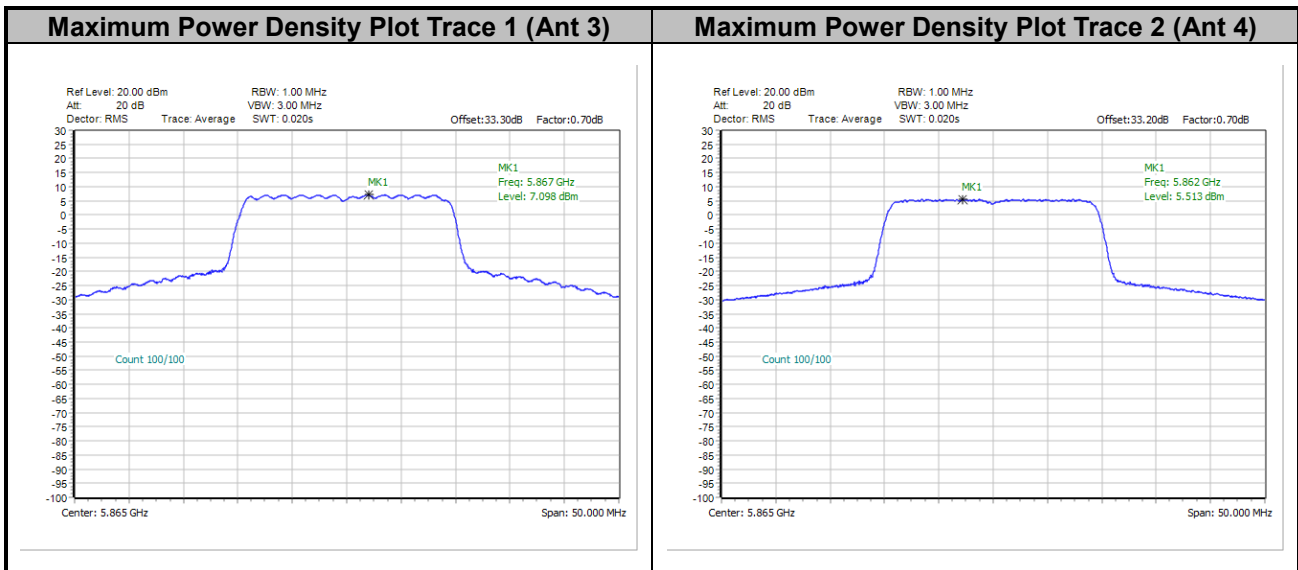



<802.11be EHT40 Full RU>

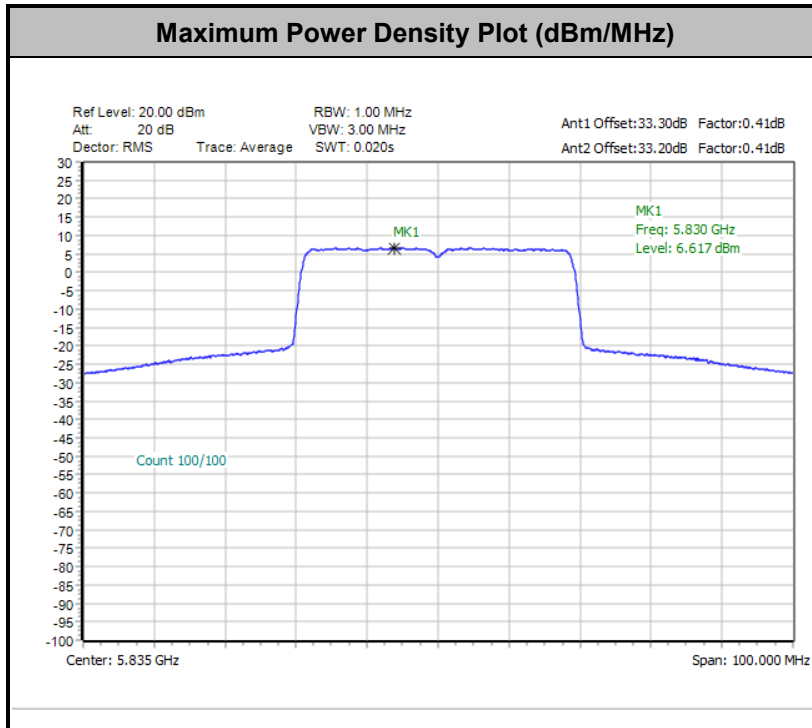

Remark: The test plot is showing a bin by bin combined result mathematically adds two traces.

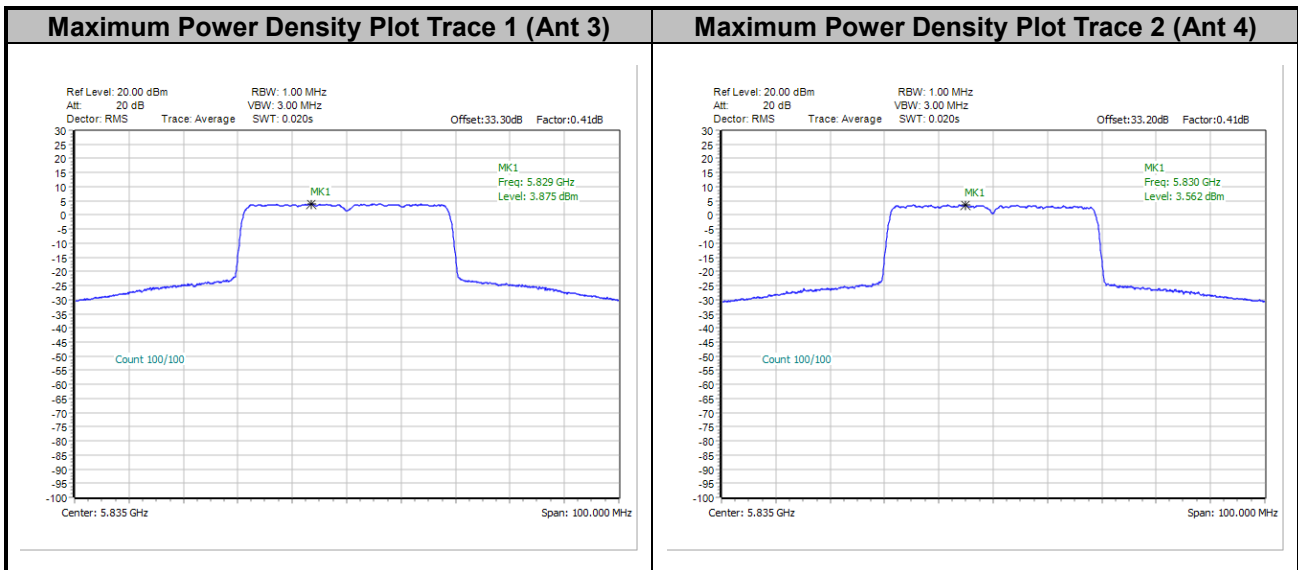



<802.11be EHT80 Full RU>

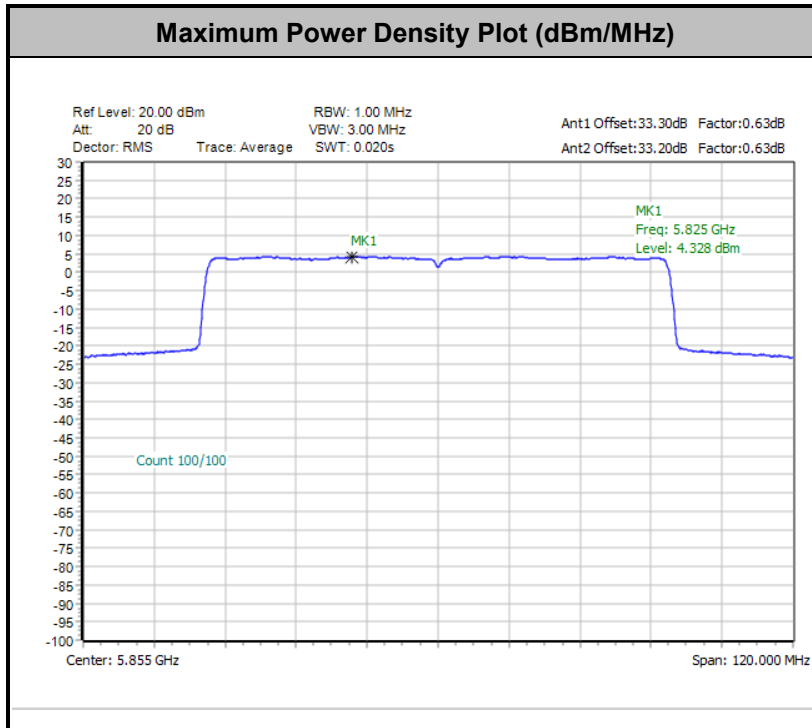

Remark: The test plot is showing a bin by bin combined result mathematically adds two traces.

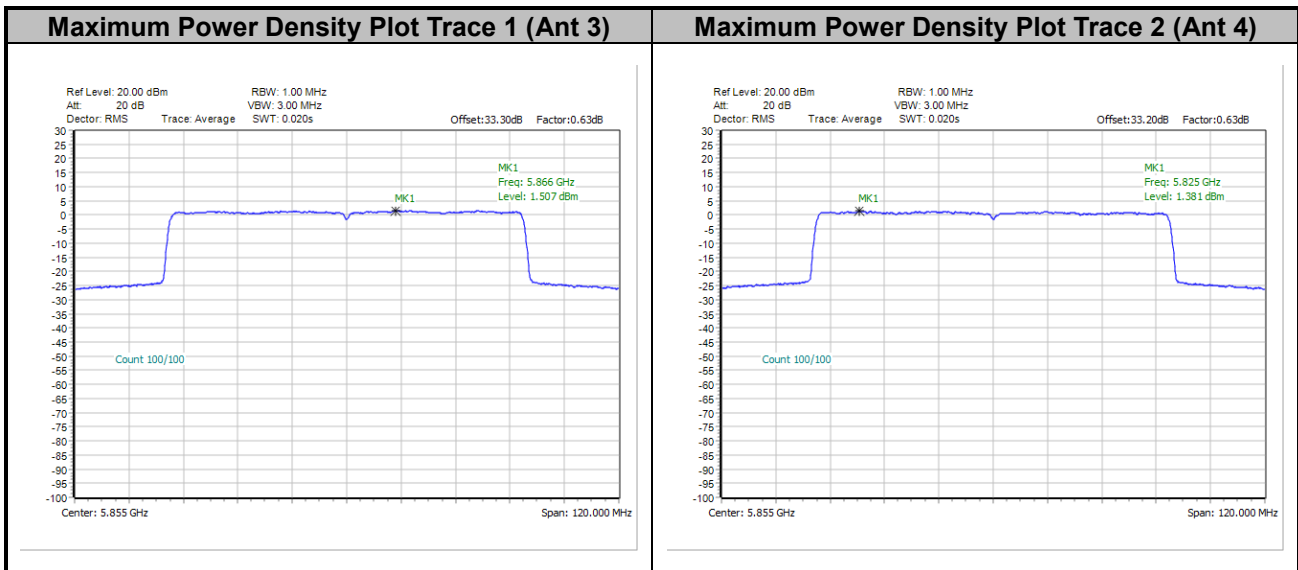



<802.11be EHT160 Full RU>

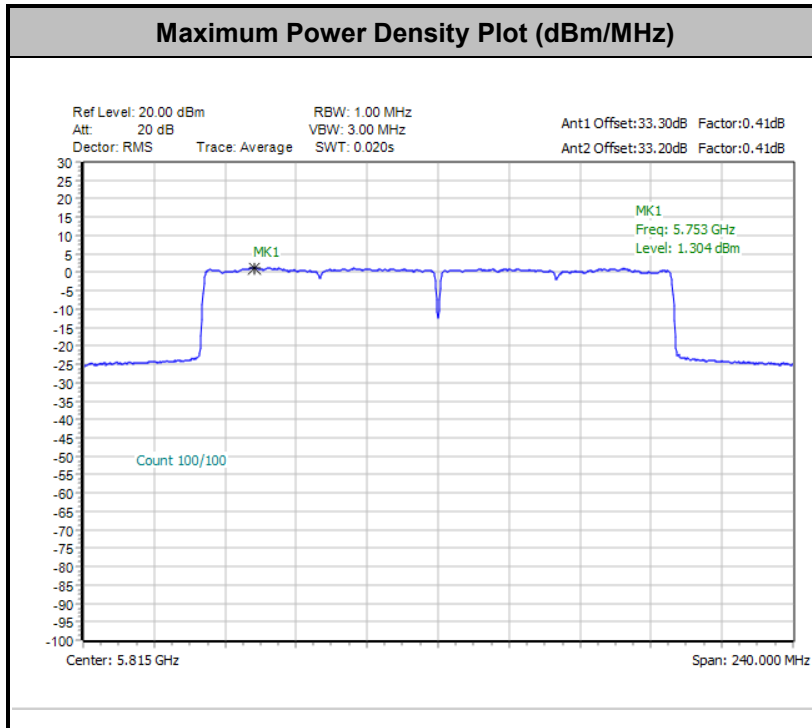

Remark: The test plot is showing a bin by bin combined result mathematically adds two traces.

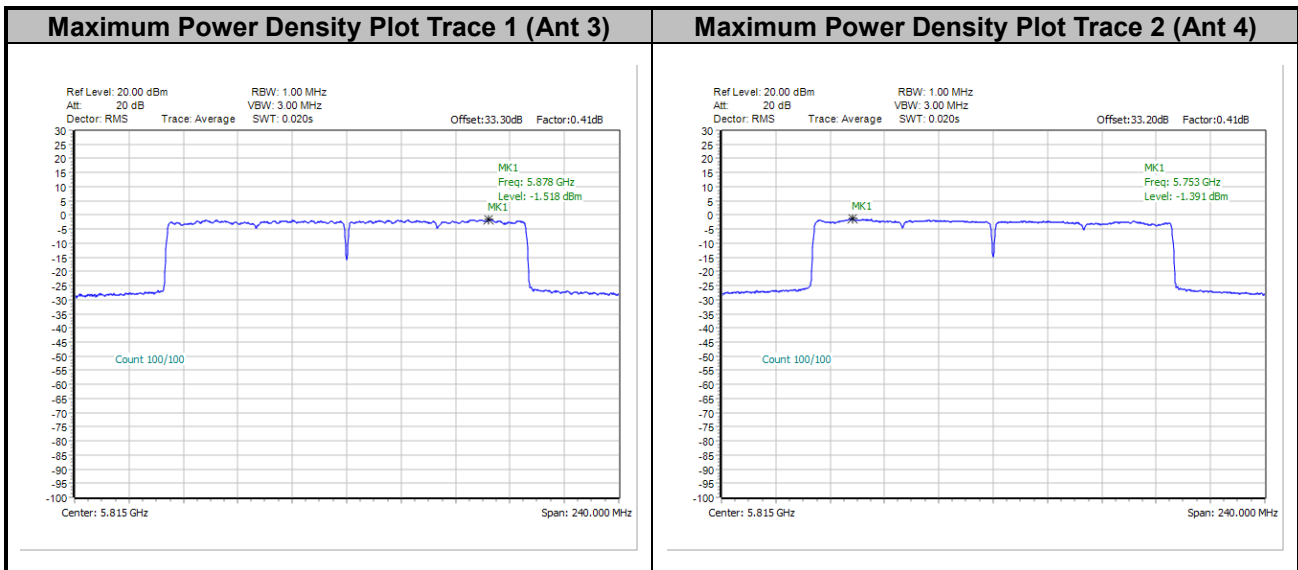



3.4 Unwanted Emissions Measurement

This section is to measure unwanted emissions through radiated measurement for band edge spurious emissions and out of band emissions measurement.

3.4.1 Limit of Unwanted Emissions

(1) Unwanted spurious emissions fallen in restricted bands shall comply with the general field strength limits as the following table:

Frequency (MHz)	Field Strength (microvolts/meter)	Measurement Distance (meters)
0.009 – 0.490	2400/F(kHz)	300
0.490 – 1.705	24000/F(kHz)	30
1.705 – 30.0	30	30
30 – 88	100	3
88 – 216	150	3
216 - 960	200	3
Above 960	500	3

Note: The following formula is used to convert the EIRP to field strength.

$$E = \frac{1000000\sqrt{30P}}{3} \text{ } \mu\text{V/m, where P is the eirp (Watts)}$$

(2) For transmitters operating solely in the 5.850-5.895 GHz band or operating on a channel that spans across 5.725-5.895 GHz:

15.407(b)(5)(i), all emissions at or above 5.895 GHz shall not exceed an e.i.r.p. of 15 dBm/MHz and shall decrease linearly to an e.i.r.p. of -7 dBm/MHz at or above 5.925 GHz.

All emissions below 5.725 GHz shall not exceed an e.i.r.p. of -27 dBm/MHz at 5.65 GHz increasing linearly to 10 dBm/MHz at 5.7 GHz, and from 5.7 GHz increasing linearly to a level of 15.6 dBm/MHz at 5.72 GHz, and from 5.72 GHz increasing linearly to a level of 27 dBm/MHz at 5.725 GHz.

(3) KDB789033 D02 v02r01 G)2)c)

Use guidance in KDB Publication 789033 for all measurements. Unwanted emissions outside of restricted bands are measured with an RMS detector. In addition, 15.35(b) applies where the peak emissions must be limited to no more than 20 dB above the average limit.

Unwanted band-edge emissions may be measured using the integration method as described in KDB Publication 789033 3. d) (ii). Emissions below 5725 MHz should be measured using peak-detection while emission above 5895 MHz should be measured using average.



Frequency(GHz)	EIRP (dBm)	Field Strength @3m distance (dBuV/m)	Note
Below 5.65	-27dBm/MHz	68.2	Peak
5.7	10dBm/MHz	105.2	Peak
5.72	15.6dBm/MHz	110.8	Peak
5.725	27dBm/MHz	122.2	Peak
5.895	-5dBm/MHz	90.2	Average
5.895	15dBm/MHz	110.2	Peak
Above 5.925	-27dBm/MHz	68.2	Average
Above 5.925	-7dBm/MHz	88.2	Peak

Note: Field strength at 3 m distance is converted to EIRP as the following equation:
 $EIRP[dBm] = E[dBuV/m] - 95.2$

3.4.2 Measuring Instruments

See list of measuring equipment of this test report.

3.4.3 Test Procedures

- The testing follows FCC KDB 789033 D02 General UNII Test Procedures New Rules v02r01. Section G) Unwanted emissions measurement.
 - Procedure for Unwanted Emissions Measurements Below 1000 MHz
 - RBW = 120 kHz
 - VBW = 300 kHz
 - Detector = Peak
 - Trace mode = max hold
 - Procedure for Peak Unwanted Emissions Measurements Above 1000 MHz
 - RBW = 1 MHz
 - VBW ≥ 3 MHz
 - Detector = Peak
 - Sweep time = auto
 - Trace mode = max hold
 - Procedures for Average Unwanted Emissions Measurements Above 1000 MHz
 - RBW = 1 MHz
 - VBW = 10 Hz, when duty cycle is no less than 98 percent.
 - VBW ≥ 1/T, when duty cycle is less than 98 percent where T is the minimum transmission duration over which the transmitter is on and is transmitting at its maximum power control level for the tested mode of operation.

2. The EUT was placed on a turntable with 0.8 meter for frequency below 1 GHz and 1.5 meter for frequency above 1 GHz respectively above ground.
3. The EUT was placed at distance 3 meter from measurement antenna which was mounted on the top of a variable height antenna tower.
4. The measurement antenna is a broadband antenna and its height is adjusted between one meter and four meters above ground to find the maximum value of the field strength for both horizontal polarization and vertical polarization.
5. For each suspected emission, the EUT was arranged to its worst case and then adjust the antenna tower (from 1 m to 4 m) and turntable (from 0 degree to 360 degrees) to find the maximum reading.
6. Radiated testing below 1GHz was performed by adjusting the antenna tower from 1m to 4m and by rotating the turn table from 0 degree to 360 degree to find the peak maximum hold reading. When there is no suspected emission found and the emission level is with at least 6dB margin against QP limit line, the position is marked as “-“.
7. Radiated testing above 1GHz was performed by adjusting the antenna tower from 1m to 4m and by rotating the turn table from 0 degree to 360 degree to find the peak maximum hold reading for scanning all frequencies. When there is no suspected emission found and the harmonic emission level is with at least 6dB margin against average limit line, the position is marked as “-“.

3.4.4 Test Setup

For radiated emissions below 30MHz

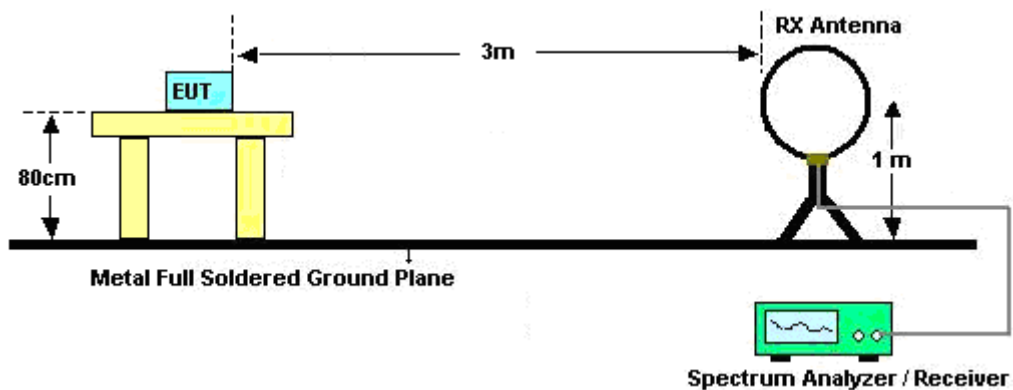

For radiated emissions from 30MHz to 1GHz

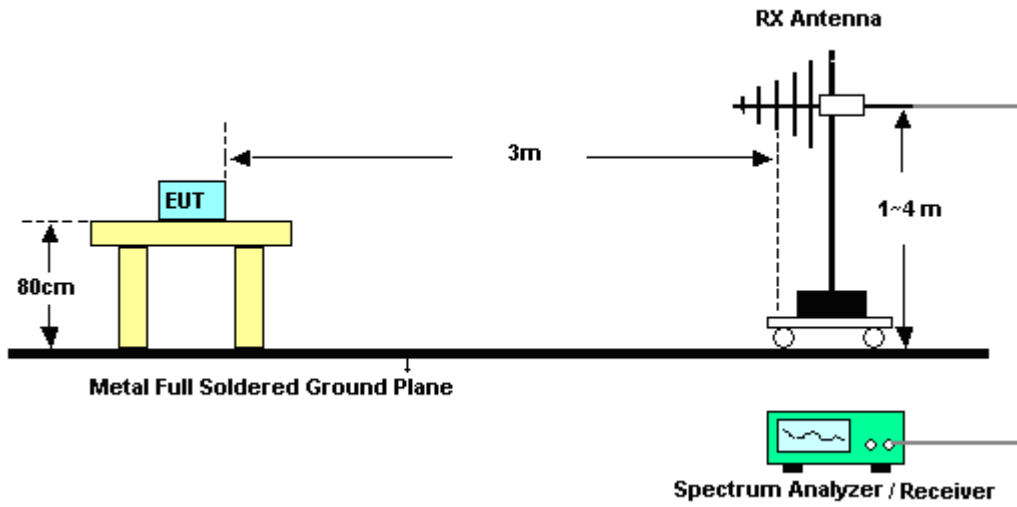

For radiated test from 1GHz to 18GHz

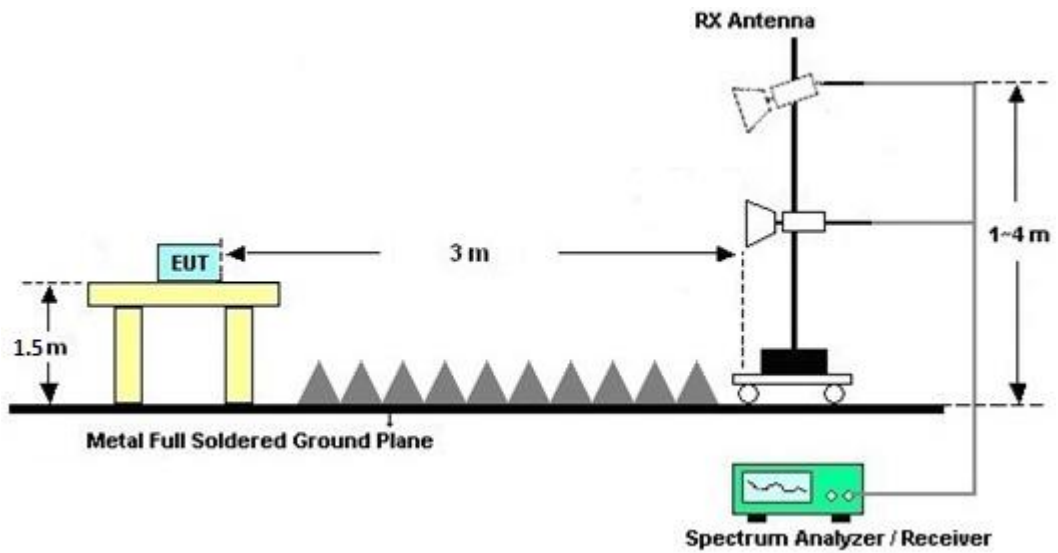

For radiated test above 18GHz

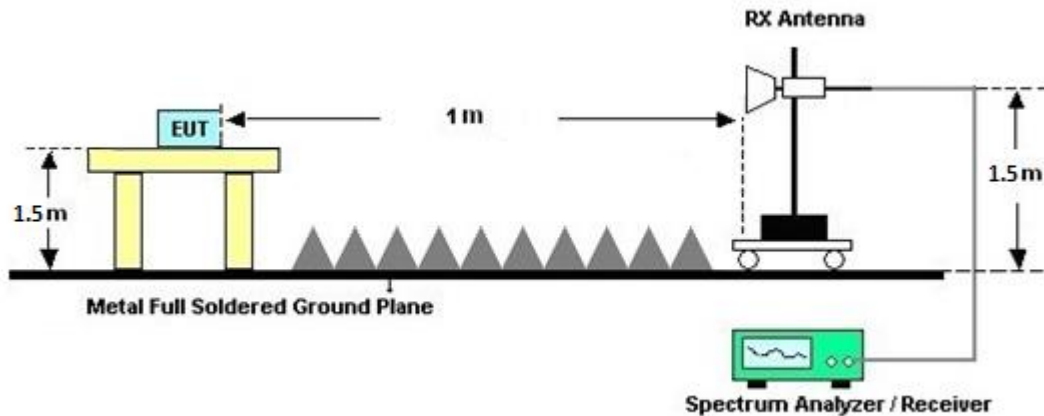

3.4.5 Test Results of Radiated Emissions (9 kHz ~ 30 MHz)

The low frequency, which started from 9 kHz to 30MHz, was pre-scanned and the result which was 20dB lower than the limit line was not reported.

There is adequate comparison measurement of both open-field test site and alternative test site - semi-Anechoic chamber according to 414788 D01 Radiated Test Site v01r01, and the result came out very similar.

3.4.6 Test Result of Radiated Band Edges

Please refer to Appendix C and D.

3.4.7 Duty Cycle

Please refer to Appendix E.

3.4.8 Test Result of Unwanted Radiated Emission (30MHz ~ 10th Harmonic)

Please refer to Appendix C and D.



3.5 AC Conducted Emission Measurement

3.5.1 Limit of AC Conducted Emission

For equipment that is designed to be connected to the public utility (AC) power line, the radio frequency voltage that is conducted back onto the AC power line on any frequency or frequencies within the band 150 kHz to 30 MHz shall not exceed the limits in the following table.

Frequency of emission (MHz)	Conducted limit (dB μ V)	
	Quasi-peak	Average
0.15-0.5	66 to 56*	56 to 46*
0.5-5	56	46
5-30	60	50

*Decreases with the logarithm of the frequency.

3.5.2 Measuring Instruments

See list of measuring equipment of this test report.

3.5.3 Test Procedures

1. The EUT was placed 0.4 meter from the conducting wall of the shielding room was kept at least 80 centimeters from any other grounded conducting surface.
2. Connect EUT to the power mains through a line impedance stabilization network (LISN).
3. All the support units are connecting to the other LISN.
4. The LISN provides 50 ohm coupling impedance for the measuring instrument.
5. The FCC states that a 50 ohm, 50 microhenry LISN shall be used.
6. Both sides of AC line were checked for maximum conducted interference.
7. The frequency range from 150 kHz to 30 MHz was searched.
8. Set the test-receiver system to Peak Detect Function and specified bandwidth with Maximum Hold Mode.

3.5.4 Test Setup

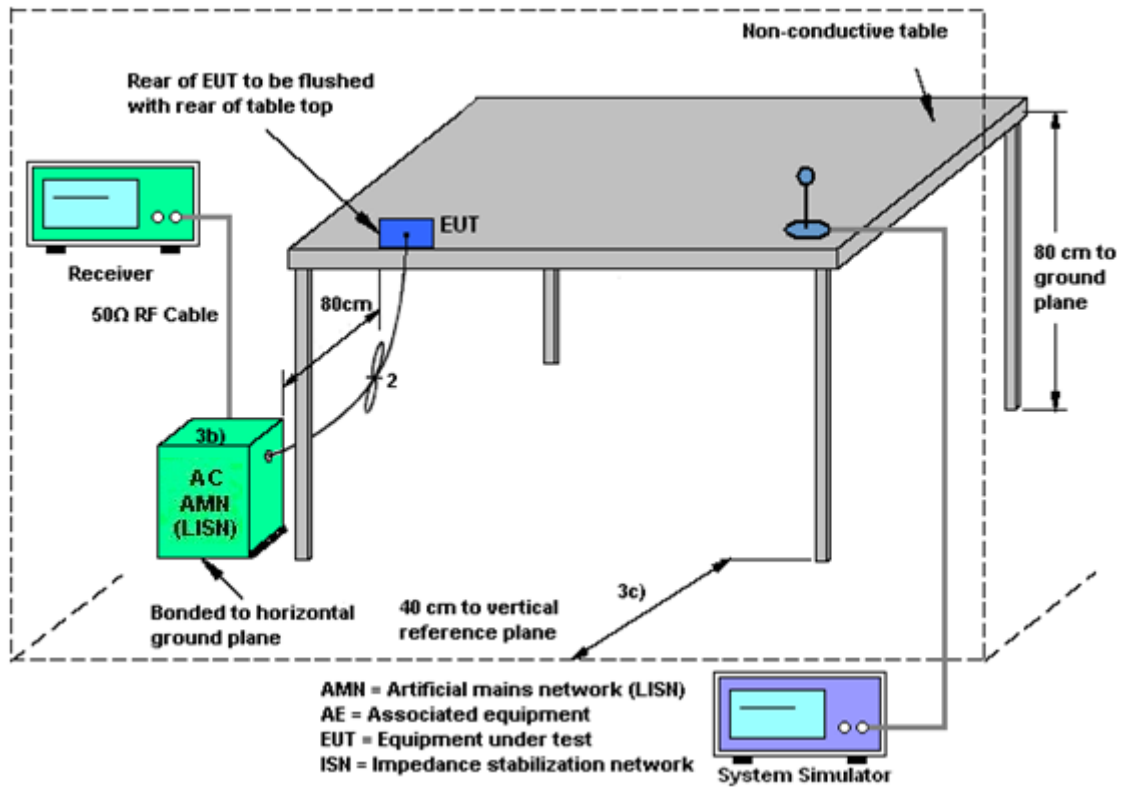

3.5.5 Test Result of AC Conducted Emission

Please refer to Appendix B.



3.6 Antenna Requirements

3.6.1 Standard Applicable

The use of a permanently attached antenna or of an antenna that uses a unique coupling to the intentional radiator shall be considered sufficient to comply with the rule.

3.6.2 Antenna Anti-Replacement Construction

An embedded-in antenna design is used.



4 List of Measuring Equipment

Instrument	Brand Name	Model No.	Serial No.	Characteristics	Calibration Date	Test Date	Due Date	Remark
Hygrometer	TECEPEL	DTM-303B	TP140325	N/A	Nov. 07, 2022	Apr. 16, 2023 ~ Jun. 07, 2023	Nov. 06, 2023	Radiation (03CH13-HY)
Loop Antenna	Rohde & Schwarz	HFH2-Z2	100488	9 kHz~30 MHz	Sep. 20, 2022	Apr. 16, 2023 ~ Jun. 07, 2023	Sep. 19, 2023	Radiation (03CH13-HY)
RF Cable	HUBER + SUHNER	SUCOFLEX 102	803951/2	9K~30M	Mar. 07, 2023	Apr. 16, 2023 ~ Jun. 07, 2023	Mar. 06, 2024	Radiation (03CH13-HY)
Preamplifier	EMEC	EM18G40G	060715	18GHz~40GHz	Dec. 07, 2022	Apr. 16, 2023 ~ Jun. 07, 2023	Dec. 06, 2023	Radiation (03CH13-HY)
SHF-EHF Horn Antenna	SCHWARZBECK	BBHA9170	00993	18GHz-40GHz	Nov. 24, 2022	Apr. 16, 2023 ~ Jun. 07, 2023	Nov. 23, 2023	Radiation (03CH13-HY)
RF Cable	HUBER + SUHNER	SUCOFLEX 102	803953/2	30MHz~40GHz	Dec. 20, 2022	Apr. 16, 2023 ~ Jun. 07, 2023	Dec. 19, 2023	Radiation (03CH13-HY)
Amplifier	SONOMA	310N	187282	9kHz~1GHz	Dec. 14, 2022	Apr. 16, 2023 ~ Jun. 07, 2023	Dec. 13, 2023	Radiation (03CH13-HY)
Bilog Antenna	TESEQ	CBL 6111D & 00800N1D01N-06	40103 & 07	30MHz~1GHz	Apr. 24, 2022	Apr. 16, 2023 ~ Apr. 22, 2023	Apr. 23, 2023	Radiation (03CH13-HY)
Bilog Antenna	TESEQ	CBL 6111D & 00800N1D01N-06	40103 & 07	30MHz~1GHz	Apr. 23, 2023	Apr. 23, 2023 ~ Jun. 07, 2023	Apr. 22, 2024	Radiation (03CH13-HY)
Horn Antenna	SCHWARZBECK	BBHA 9120 D	9120D-1326	1GHz~18GHz	Aug. 24, 2022	Apr. 16, 2023 ~ Jun. 07, 2023	Aug. 23, 2023	Radiation (03CH13-HY)
Preamplifier	MITEQ	AMF-7D-0010180 0-30-10P	1590074	1GHz~18GHz	May 17, 2022	Apr. 16, 2023 ~ May. 15, 2023	May 16, 2023	Radiation (03CH13-HY)
Preamplifier	MITEQ	AMF-7D-0010180 0-30-10P	1590074	1GHz~18GHz	May 16, 2023	May. 16, 2023~ Jun. 07, 2023	May 15, 2024	Radiation (03CH13-HY)
Preamplifier	Keysight	83017A	MY53270147	1GHz~26.5GHz	Oct. 25, 2022	Apr. 16, 2023 ~ Jun. 07, 2023	Oct. 24, 2023	Radiation (03CH13-HY)
Spectrum Analyzer	Keysight	N9010A	MY55370526	10Hz~44GHz	Mar. 23, 2023	Apr. 16, 2023 ~ Jun. 07, 2023	Mar. 22, 2024	Radiation (03CH13-HY)
Filter	Wainwright	WLK4-1000-1530-8000-40SS	SN12	1.53GHz Low Pass Filter	Sep. 13, 2022	Apr. 16, 2023 ~ Jun. 07, 2023	Sep. 12, 2023	Radiation (03CH13-HY)
Filter	Wainwright	WHKX12-2700-3000-18000-60SS	SN2	3GHz High Pass Filter	Jul. 11, 2022	Apr. 16, 2023 ~ Jun. 07, 2023	Jul. 10, 2023	Radiation (03CH13-HY)
Filter	Wainwright	WHKX8-5872.5-6750-18000-40ST	SN5	6.75GHz High Pass Filter	Mar. 09, 2023	Apr. 16, 2023 ~ Jun. 07, 2023	Mar. 08, 2024	Radiation (03CH13-HY)
Filter	Wainwright	WHKX6-7268-9200-26500-40CD	SN4	9GHz High Pass Filter	May 24, 2022	Apr. 16, 2023 ~ May 22, 2023	May 23, 2023	Radiation (03CH13-HY)
Filter	Wainwright	WHKX6-7268-9200-26500-40CD	SN4	9GHz High Pass Filter	May 23, 2023	May 23, 2023~ Jun. 07, 2023	May 22, 2024	Radiation (03CH13-HY)
Notch Filter	Wainwright	WRCQV14-5425-5825-6525-6925-60SS	SN1	N/A	Jan. 07, 2023	Apr. 16, 2023 ~ Jun. 07, 2023	Jan. 06, 2024	Radiation (03CH13-HY)
RF Cable	HUBER + SUHNER	SUCOFLEX 126E	0030/126E	30MHz~18GHz	Feb. 08, 2023	Apr. 16, 2023 ~ Jun. 07, 2023	Feb. 07, 2024	Radiation (03CH13-HY)
RF Cable	HUBER + SUHNER	SUCOFLEX 104	804793/4	30MHz~18GHz	Feb. 08, 2023	Apr. 16, 2023 ~ Jun. 07, 2023	Feb. 07, 2024	Radiation (03CH13-HY)
RF Cable	HUBER + SUHNER	SUCOFLEX 104	MY24961/4	30MHz~18GHz	Feb. 08, 2023	Apr. 16, 2023 ~ Jun. 07, 2023	Feb. 07, 2024	Radiation (03CH13-HY)
Controller	EMEC	EM1000	N/A	Control Turn table & Ant Mast	N/A	Apr. 16, 2023 ~ Jun. 07, 2023	N/A	Radiation (03CH13-HY)
Antenna Mast	EMEC	AM-BS-4500-B	N/A	1m~4m	N/A	Apr. 16, 2023 ~ Jun. 07, 2023	N/A	Radiation (03CH13-HY)
Turn Table	EMEC	TT2000	N/A	0~360 Degree	N/A	Apr. 16, 2023 ~ Jun. 07, 2023	N/A	Radiation (03CH13-HY)
Software	Audix	N/A	RK-001124	N/A	N/A	Apr. 16, 2023 ~ Jun. 07, 2023	N/A	Radiation (03CH13-HY)



Instrument	Brand Name	Model No.	Serial No.	Characteristics	Calibration Date	Test Date	Due Date	Remark
Hygrometer	TECPEL	DTM-303A	TP201996	N/A	Nov. 17, 2022	Apr. 13, 2023~ Jun. 07, 2023	Nov. 16, 2023	Conducted (TH05-HY)
Power Sensor	DARE	RPR3006W	16I00054SNO 12 (NO:113)	10MHz~6GHz	Dec. 13, 2022	Apr. 13, 2023~ Jun. 07, 2023	Dec. 12, 2023	Conducted (TH05-HY)
Signal Analyzer	Rohde & Schwarz	FSV40	101905	10Hz - 40GHz (amp)	Aug. 03, 2022	Apr. 13, 2023~ Jun. 07, 2023	Aug. 02, 2023	Conducted (TH05-HY)
AC Power Source	ChainTek	APC-1000W	N/A	N/A	N/A	Apr. 19, 2023	N/A	Conduction (CO05-HY)
EMI Test Receiver	Rohde & Schwarz	ESR3	102388	9kHz~3.6GHz	Dec. 01, 2022	Apr. 19, 2023	Nov. 30, 2023	Conduction (CO05-HY)
Hygrometer	Testo	608-H1	34913912	N/A	Nov. 17, 2022	Apr. 19, 2023	Nov. 16, 2023	Conduction (CO05-HY)
LISN	Rohde & Schwarz	ENV216	100081	9kHz~30MHz	Nov. 17, 2022	Apr. 19, 2023	Nov. 16, 2023	Conduction (CO05-HY)
Software	Rohde & Schwarz	EMC32	N/A	N/A	N/A	Apr. 19, 2023	N/A	Conduction (CO05-HY)
Pulse Limiter	SCHWARZBE CK	VTSD 9561-F N	00691	N/A	Aug. 01, 2022	Apr. 19, 2023	Jul. 31, 2023	Conduction (CO05-HY)
LISN Cable	MVE	RG-400	260260	N/A	Dec. 29, 2022	Apr. 19, 2023	Dec. 28, 2023	Conduction (CO05-HY)



5 Measurement Uncertainty

Uncertainty of Conducted Emission Measurement (150 kHz ~ 30 MHz)

Measuring Uncertainty for a Level of Confidence of 95% ($U = 2Uc(y)$)	3.5 dB
---	--------

Uncertainty of Radiated Emission Measurement (30 MHz ~ 1000 MHz)

Measuring Uncertainty for a Level of Confidence of 95% ($U = 2Uc(y)$)	6.5 dB
---	--------

Uncertainty of Radiated Emission Measurement (1000 MHz ~ 6000 MHz)

Measuring Uncertainty for a Level of Confidence of 95% ($U = 2Uc(y)$)	4.4 dB
---	--------

Uncertainty of Radiated Emission Measurement (6000 MHz ~ 18000 MHz)

Measuring Uncertainty for a Level of Confidence of 95% ($U = 2Uc(y)$)	4.8 dB
---	--------

Uncertainty of Radiated Emission Measurement (18000 MHz ~ 40000 MHz)

Measuring Uncertainty for a Level of Confidence of 95% ($U = 2Uc(y)$)	5.3 dB
---	--------

Appendix A. Test Result of Conducted Test Items

Test Engineer:	Willy Chang	Temperature:	21~25	°C
Test Date:	2023/4/13~2023/06/07	Relative Humidity:	51~54	%

TEST RESULTS DATA
6dB and 26dB EBW and 99% OBW

UNII-4 MIMO												
Mod.	Data Rate	NTX	CH.	Freq. (MHz)	99% Bandwidth (MHz)		26dB Bandwidth (MHz)		6 dB Bandwidth (MHz)		6 dB Bandwidth Min. Limit (MHz)	Pass/Fail
					Ant 3	Ant 4	Ant 3	Ant 4	Ant 3	Ant 4		
11a	6Mbps	2	169	5845	17.48	17.08	27.54	23.04	16.45	16.45	0.5	Pass
11a	6Mbps	2	173	5865	17.53	17.08	26.46	23.22	16.45	16.45	0.5	Pass
11a	6Mbps	2	177	5885	17.48	17.13	28.20	21.66	16.45	16.50	0.5	Pass

TEST RESULTS DATA
Average Power Table

UNII-4 MIMO										
Mod.	Data Rate	NTX	CH.	Freq. (MHz)	Average Conducted Power (dBm)			DG (dBi)	E.I.R.P Power (dBm)	E.I.R.P Limit (dBm)
					Ant 3	Ant 4	SUM	Ant 3 + Ant 4	Ant 3 + Ant 4	Ant 3 + Ant 4
11a	6Mbps	2	169	5845	18.80	17.40	21.17	-1.20	19.97	30
11a	6Mbps	2	173	5865	18.80	17.30	21.12	-1.20	19.92	30
11a	6Mbps	2	177	5885	18.90	16.60	20.91	-1.20	19.71	30
HT20	MCS0	2	169	5845	18.80	17.50	21.21	-1.20	20.01	30
HT20	MCS0	2	173	5865	18.90	17.60	21.31	-1.20	20.11	30
HT20	MCS0	2	177	5885	18.80	15.90	20.60	-1.20	19.40	30
HT40	MCS0	2	167	5835	18.80	18.30	21.57	-1.20	20.37	30
HT40	MCS0	2	175	5875	18.20	17.60	20.92	-1.20	19.72	30
VHT20	MCS0	2	169	5845	18.70	17.50	21.15	-1.20	19.95	30
VHT20	MCS0	2	173	5865	18.80	17.60	21.25	-1.20	20.05	30
VHT20	MCS0	2	177	5885	18.70	15.90	20.53	-1.20	19.33	30
VHT40	MCS0	2	167	5835	18.80	18.30	21.57	-1.20	20.37	30
VHT40	MCS0	2	175	5875	18.20	17.60	20.92	-1.20	19.72	30
VHT80	MCS0	2	171	5855	19.10	19.10	22.11	-1.20	20.91	30

TEST RESULTS DATA
Power Spectral Density

UNII-4 MIMO											
Mod.	Data Rate	NTX	CH.	Freq. (MHz)	Average Power Density (dBm/MHz)			DG (dBi)	EIRP PSD (dBm/MHz)	EIRP PSD Limit (dBm/MHz)	Pass /Fail
					Ant 3	Ant 4	SUM				
11a	6Mbps	2	169	5845			9.51	1.66	11.17	14.00	Pass
11a	6Mbps	2	173	5865			9.46	1.66	11.12	14.00	Pass
11a	6Mbps	2	177	5885			9.30	1.66	10.96	14.00	Pass

Note: PSD Sum = Max PSD(Ant. 1, Ant. 2) + 10 log (n)

TEST RESULTS DATA
Average Power Table

UNII-4 MIMO													
Mod.	Data Rate	NTX	CH.	Freq. (MHz)	RU Config	Duty Factor (dB)		Average Conducted Power (dBm)			DG (dBi)	E.I.R.P Power (dBm)	E.I.R.P Limit (dBm)
						Ant 1	Ant 2	Ant 3	Ant 4	SUM	Ant 3 + Ant 4	Ant 3 + Ant 4	Ant 3 + Ant 4
HE20	MCS0	2	169	5845	Full	0.21	0.21	18.80	17.50	21.21	-1.20	20.01	30
HE20	MCS0	2	169	5845	26/0	0.21	0.21	9.30	9.10	12.21	-1.20	11.01	30
HE20	MCS0	2	169	5845	52/37	0.21	0.21	12.30	12.20	15.26	-1.20	14.06	30
HE20	MCS0	2	169	5845	106/53	0.21	0.21	15.60	15.20	18.41	-1.20	17.21	30
HE20	MCS0	2	173	5865	Full	0.21	0.21	18.90	17.60	21.31	-1.20	20.11	30
HE20	MCS0	2	173	5865	26/4	0.21	0.21	10.80	10.20	13.52	-1.20	12.32	30
HE20	MCS0	2	173	5865	52/38	0.21	0.21	12.20	12.20	15.21	-1.20	14.01	30
HE20	MCS0	2	173	5865	106/53	0.21	0.21	15.40	15.00	18.21	-1.20	17.01	30
HE20	MCS0	2	177	5885	Full	0.21	0.21	18.80	15.90	20.60	-1.20	19.40	30
HE20	MCS0	2	177	5885	26/8	0.21	0.21	8.70	8.70	11.71	-1.20	10.51	30
HE20	MCS0	2	177	5885	52/40	0.21	0.21	11.50	11.50	14.51	-1.20	13.31	30
HE20	MCS0	2	177	5885	106/54	0.21	0.21	14.50	14.40	17.46	-1.20	16.26	30
HE40	MCS0	2	167	5835	Full	0.43	0.45	18.80	18.30	21.57	-1.20	20.37	30
HE40	MCS0	2	175	5875	Full	0.43	0.45	18.20	17.60	20.92	-1.20	19.72	30
HE80	MCS0	2	171	5855	Full	0.66	0.64	19.10	19.10	22.11	-1.20	20.91	30

TEST RESULTS DATA
Power Spectral Density

UNII-4 MIMO												
Mod.	Data Rate	NTX	CH.	Freq. (MHz)	RU Config	Average Power Density (dBm/MHz)			DG (dBi)	EIRP PSD (dBm/MHz)	EIRP PSD Limit (dBm/MHz)	Pass /Fail
						Ant 3	Ant 4	SUM				
HE20	MCS0	2	169	5845	Full			9.04	1.66	10.70	14.00	Pass
HE20	MCS0	2	173	5865	Full			8.86	1.66	10.52	14.00	Pass
HE20	MCS0	2	177	5885	Full			8.74	1.66	10.40	14.00	Pass
HE40	MCS0	2	167	5835	Full			6.23	1.66	7.89	14.00	Pass
HE40	MCS0	2	175	5875	Full			5.40	1.66	7.06	14.00	Pass
HE80	MCS0	2	171	5855	Full			4.09	1.66	5.75	14.00	Pass
HE160	MCS0	2	163	5815	Full			0.53	1.66	2.19	14.00	Pass

Note: PSD Sum = Max PSD(Ant. 1, Ant. 2) + 10 log (n)

TEST RESULTS DATA
6dB and 26dB EBW and 99% OBW

UNII-4 MIMO													
Mod.	Data Rate	NTX	CH.	Freq. (MHz)	RU Config	99% Bandwidth (MHz)		26dB Bandwidth (MHz)		6 dB Bandwidth (MHz)		6 dB Bandwidth Min. Limit (MHz)	Pass/Fail
						Ant 3	Ant 4	Ant 3	Ant 4	Ant 3	Ant 4		
EHT20	MCS0	2	169	5845	Full	19.33	19.28	27.48	27.30	19.10	18.85	0.5	Pass
EHT20	MCS0	2	173	5865	Full	19.43	19.23	27.00	25.68	19.10	19.05	0.5	Pass
EHT20	MCS0	2	177	5885	Full	19.28	19.18	27.66	22.44	19.00	19.10	0.5	Pass
EHT40	MCS0	2	167	5835	Full	38.16	38.16	42.36	39.96	38.07	37.89	0.5	Pass
EHT40	MCS0	2	175	5875	Full	38.06	37.96	40.56	40.68	37.80	37.89	0.5	Pass
EHT80	MCS0	2	171	5855	Full	77.44	77.56	104.64	101.52	78.08	78.08	0.5	Pass
EHT160	MCS0	2	163	5815	Full	157.76	157.76	279.84	273.60	158.40	158.40	0.5	Pass

TEST RESULTS DATA
Average Power Table

UNII-4 MIMO											
Mod.	Data Rate	NTX	CH.	Freq. (MHz)	RU Config.	Average Conducted Power (dBm)			DG (dBi)	E.I.R.P Power (dBm)	E.I.R.P Limit (dBm)
						Ant 3	Ant 4	SUM			
EHT20	MCS0	2	169	5845	Full	19.10	17.70	21.47	-1.20	20.27	30
EHT20	MCS0	2	169	5845	26/0	9.50	9.40	12.46	-1.20	11.26	30
EHT20	MCS0	2	169	5845	52/37	12.50	12.40	15.46	-1.20	14.26	30
EHT20	MCS0	2	169	5845	106/53	15.70	15.40	18.56	-1.20	17.36	30
EHT20	MCS0	2	169	5845	MRU 52T+26T/70	14.20	14.10	17.16	-1.20	15.96	30
EHT20	MCS0	2	169	5845	MRU 106T+26T/82	16.40	16.10	19.26	-1.20	18.06	30
EHT20	MCS0	2	173	5865	Full	19.00	17.70	21.41	-1.20	20.21	30
EHT20	MCS0	2	173	5865	26/4	10.90	10.50	13.71	-1.20	12.51	30
EHT20	MCS0	2	173	5865	52/38	12.40	12.30	15.36	-1.20	14.16	30
EHT20	MCS0	2	173	5865	106/53	15.60	15.20	18.41	-1.20	17.21	30
EHT20	MCS0	2	173	5865	MRU 52T+26T/71	14.30	13.90	17.11	-1.20	15.91	30
EHT20	MCS0	2	173	5865	MRU 106T+26T/83	16.60	16.00	19.32	-1.20	18.12	30
EHT20	MCS0	2	177	5885	Full	19.10	16.20	20.90	-1.20	19.70	30
EHT20	MCS0	2	177	5885	26/8	8.90	8.80	11.86	-1.20	10.66	30
EHT20	MCS0	2	177	5885	52/40	11.70	11.60	14.66	-1.20	13.46	30
EHT20	MCS0	2	177	5885	106/54	14.90	14.70	17.81	-1.20	16.61	30
EHT20	MCS0	2	177	5885	MRU 52T+26T/72	13.50	13.50	16.51	-1.20	15.31	30
EHT20	MCS0	2	177	5885	MRU 106T+26T/83	16.10	15.80	18.96	-1.20	17.76	30
EHT40	MCS0	2	167	5835	Full	19.00	18.40	21.72	-1.20	20.52	30
EHT40	MCS0	2	175	5875	Full	18.90	17.70	21.35	-1.20	20.15	30
EHT80	MCS0	2	171	5855	Full	19.30	19.30	22.31	-1.20	21.11	30
EHT80	MCS0	2	171	5855	Puncture 20/8	18.40	17.80	21.12	-1.20	19.92	30
EHT160	MCS0	2	163	5815	Full	19.40	19.10	22.26	-1.20	21.06	31
EHT160	MCS0	2	163	5815	Puncture 20/1	18.90	18.40	21.67	-1.20	20.47	32
EHT160	MCS0	2	163	5815	Puncture 40/3	18.00	17.60	20.81	-1.20	19.61	33

TEST RESULTS DATA
Power Spectral Density

UNII-4 MIMO												
Mod.	Data Rate	NTx	CH.	Freq. (MHz)	RU Config.	Average Power Density (dBm/MHz)			DG (dBi)	EIRP PSD (dBm/MHz)	EIRP PSD Limit (dBm/MHz)	Pass /Fail
						Ant 3	Ant 4	SUM	Ant 3 + Ant 4	Ant 3 + Ant 4	Ant 3 + Ant 4	
EHT20	MCS0	2	169	5845	Full			9.24	1.66	10.90	14.00	Pass
EHT20	MCS0	2	169	5845	26/0			9.16	1.66	10.82	14.00	Pass
EHT20	MCS0	2	169	5845	52/37			9.21	1.66	10.88	14.00	Pass
EHT20	MCS0	2	169	5845	106/53			9.15	1.66	10.81	14.00	Pass
EHT20	MCS0	2	169	5845	MRU 52T+26T/70			9.11	1.66	10.77	14.00	Pass
EHT20	MCS0	2	169	5845	MRU 106T+26T/82			9.04	1.66	10.71	14.00	Pass
EHT20	MCS0	2	173	5865	Full			9.37	1.66	11.03	14.00	Pass
EHT20	MCS0	2	173	5865	26/4			9.34	1.66	11.00	14.00	Pass
EHT20	MCS0	2	173	5865	52/38			9.24	1.66	10.90	14.00	Pass
EHT20	MCS0	2	173	5865	106/53			9.11	1.66	10.77	14.00	Pass
EHT20	MCS0	2	173	5865	MRU 52T+26T/71			9.12	1.66	10.78	14.00	Pass
EHT20	MCS0	2	173	5865	MRU 106T+26T/83			9.07	1.66	10.73	14.00	Pass
EHT20	MCS0	2	177	5885	Full			8.83	1.66	10.49	14.00	Pass
EHT20	MCS0	2	177	5885	26/8			8.58	1.66	10.24	14.00	Pass
EHT20	MCS0	2	177	5885	52/40			8.78	1.66	10.44	14.00	Pass
EHT20	MCS0	2	177	5885	106/54			8.70	1.66	10.36	14.00	Pass
EHT20	MCS0	2	177	5885	MRU 52T+26T/72			8.82	1.66	10.48	14.00	Pass
EHT20	MCS0	2	177	5885	MRU 106T+26T/83			8.79	1.66	10.45	14.00	Pass
EHT40	MCS0	2	167	5835	Full			6.62	1.66	8.28	14.00	Pass
EHT40	MCS0	2	175	5875	Full			5.65	1.66	7.32	14.00	Pass
EHT80	MCS0	2	171	5855	Full			4.33	1.66	5.99	14.00	Pass
EHT80	MCS0	2	171	5855	Puncture 20/8			4.06	1.66	5.72	14.00	Pass
EHT160	MCS0	2	163	5815	Full			1.30	1.66	2.97	14.00	Pass
EHT160	MCS0	2	163	5815	Puncture 20/1			0.98	1.66	2.64	14.00	Pass
EHT160	MCS0	2	163	5815	Puncture 40/3			1.03	1.66	2.69	14.00	Pass

Note: PSD Sum = Max PSD(Ant. 1, Ant. 2) + 10 log (n)



Appendix B. AC Conducted Emission Test Results

Test Engineer :	Calvin Wang	Temperature :	23~26°C
		Relative Humidity :	45~55%

EUT Information

Report NO : 2D0206-03
 Test Mode : Mode 1
 Test Voltage : 120Vac/60Hz
 Phase : Line

Full Spectrum

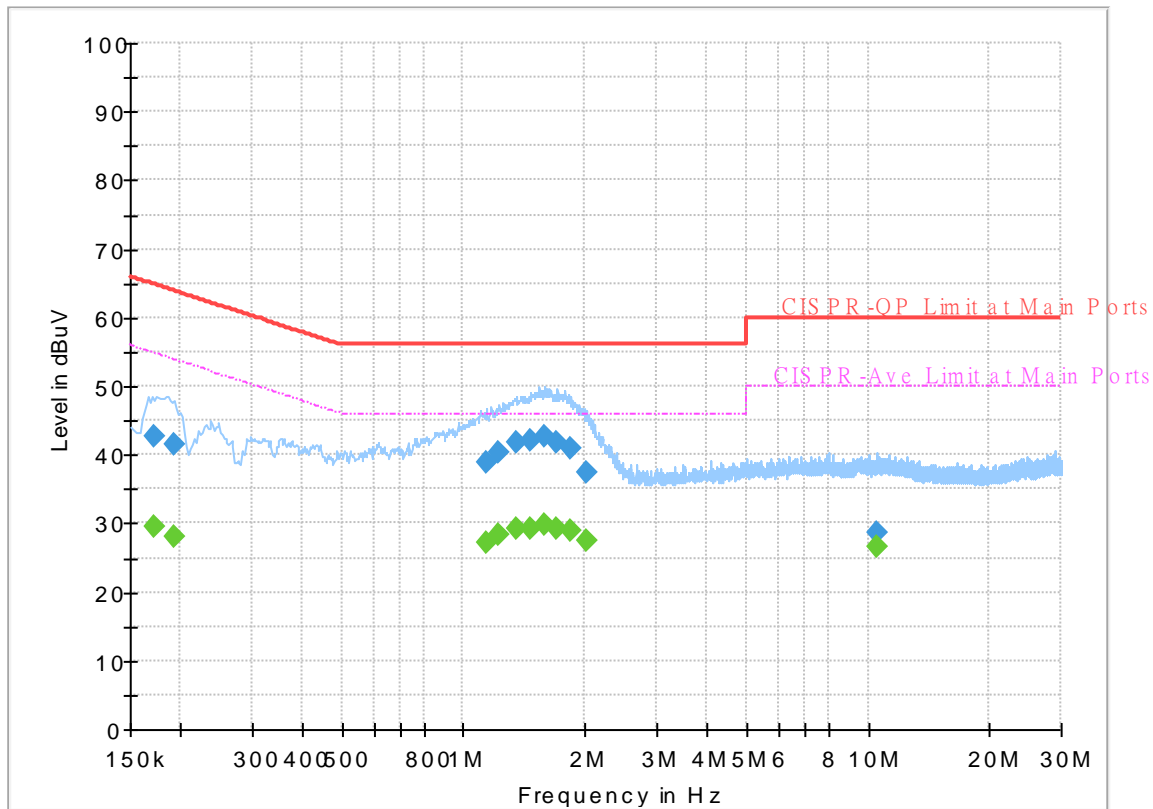

Final Result

Frequency (MHz)	QuasiPeak (dBuV)	CAverage (dBuV)	Limit (dBuV)	Margin (dB)	Line	Filter	Corr. (dB)
0.172500	---	29.65	54.84	25.19	L1	OFF	19.9
0.172500	42.73	---	64.84	22.11	L1	OFF	19.9
0.192750	---	28.05	53.92	25.87	L1	OFF	19.9
0.192750	41.41	---	63.92	22.51	L1	OFF	19.9
1.142250	---	27.31	46.00	18.69	L1	OFF	19.9
1.142250	38.75	---	56.00	17.25	L1	OFF	19.9
1.225500	---	28.25	46.00	17.75	L1	OFF	19.9
1.225500	40.24	---	56.00	15.76	L1	OFF	19.9
1.349250	---	29.29	46.00	16.71	L1	OFF	19.9
1.349250	41.94	---	56.00	14.06	L1	OFF	19.9
1.468500	---	29.14	46.00	16.86	L1	OFF	19.9
1.468500	42.05	---	56.00	13.95	L1	OFF	19.9
1.585500	---	29.92	46.00	16.08	L1	OFF	19.9
1.585500	42.76	---	56.00	13.24	L1	OFF	19.9
1.707000	---	29.22	46.00	16.78	L1	OFF	19.9
1.707000	41.71	---	56.00	14.29	L1	OFF	19.9
1.842000	---	28.81	46.00	17.19	L1	OFF	19.9
1.842000	40.89	---	56.00	15.11	L1	OFF	19.9
2.019750	---	27.42	46.00	18.58	L1	OFF	19.9
2.019750	37.31	---	56.00	18.69	L1	OFF	19.9
10.513500	---	26.65	50.00	23.35	L1	OFF	20.3

10.513500	28.72	---	60.00	31.28	L1	OFF	20.3
-----------	-------	-----	-------	-------	----	-----	------

EUT Information

Report NO : 2D0206-03
 Test Mode : Mode 1
 Test Voltage : 120Vac/60Hz
 Phase : Neutral

Full Spectrum

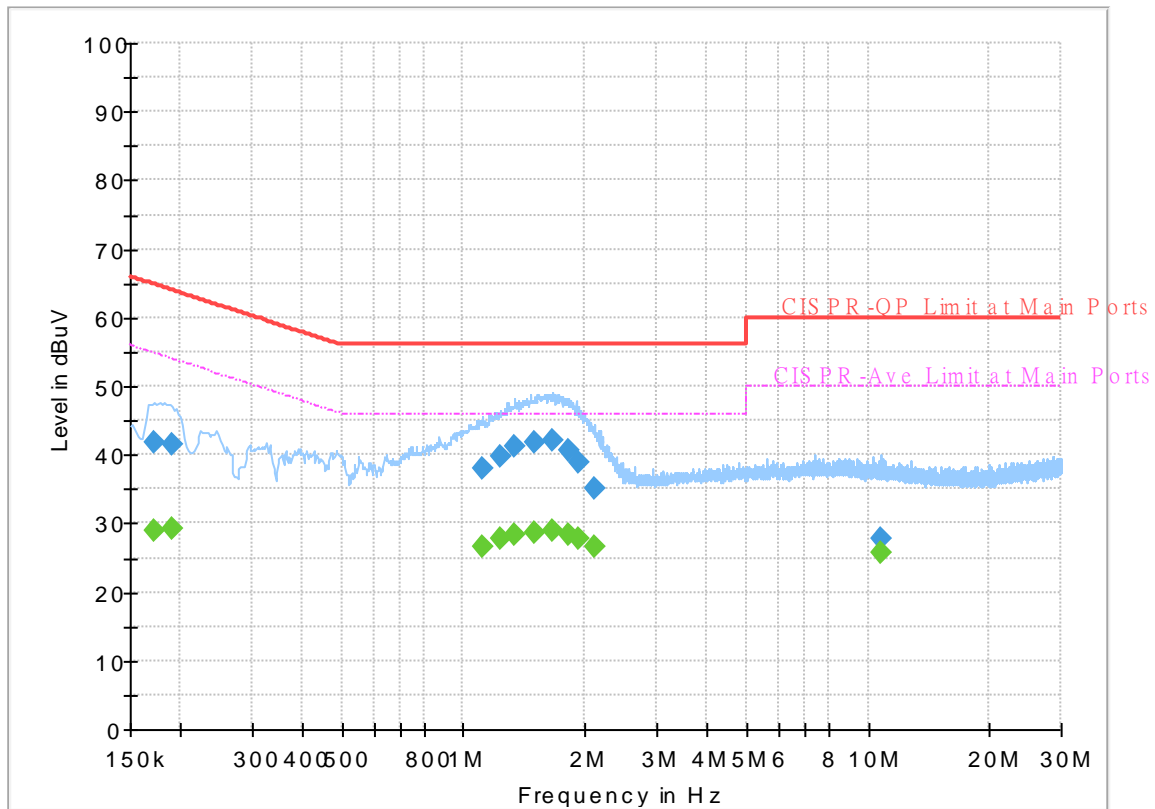

Final_Result

Frequency (MHz)	QuasiPeak (dBuV)	CAverage (dBuV)	Limit (dBuV)	Margin (dB)	Line	Filter	Corr. (dB)
0.172500	---	29.07	54.84	25.77	N	OFF	19.9
0.172500	41.82	---	64.84	23.02	N	OFF	19.9
0.190500	---	29.13	54.02	24.89	N	OFF	19.9
0.190500	41.44	---	64.02	22.58	N	OFF	19.9
1.113000	---	26.70	46.00	19.30	N	OFF	19.9
1.113000	38.04	---	56.00	17.96	N	OFF	19.9
1.239000	---	27.65	46.00	18.35	N	OFF	19.9
1.239000	39.68	---	56.00	16.32	N	OFF	19.9
1.335750	---	28.39	46.00	17.61	N	OFF	19.9
1.335750	41.10	---	56.00	14.90	N	OFF	19.9
1.504500	---	28.64	46.00	17.36	N	OFF	19.9
1.504500	41.71	---	56.00	14.29	N	OFF	19.9
1.657500	---	29.03	46.00	16.97	N	OFF	19.9
1.657500	42.13	---	56.00	13.87	N	OFF	19.9
1.812750	---	28.39	46.00	17.61	N	OFF	19.9
1.812750	40.61	---	56.00	15.39	N	OFF	19.9
1.927500	---	27.70	46.00	18.30	N	OFF	19.9
1.927500	38.83	---	56.00	17.17	N	OFF	19.9
2.105250	---	26.54	46.00	19.46	N	OFF	19.9
2.105250	34.96	---	56.00	21.04	N	OFF	19.9
10.704750	---	25.85	50.00	24.15	N	OFF	20.3

10.704750	27.81	---	60.00	32.19	N	OFF	20.3
-----------	-------	-----	-------	-------	---	-----	------



Appendix C. Radiated Spurious Emission

Test Engineer :	Jacky Hung , Mancy Chou, Michael Liu and Rain Lee	Temperature :	20~26°C
		Relative Humidity :	40~65%

UNII-4 - 5850~5895MHz

WIFI 802.11a (Band Edge @ 3m)

WIFI	Note	Frequency	Level	Margin	Limit	Read	Antenna	Path	Preamp	Ant	Table	Peak	Pol.
Ant.				Limit	Line	Level	Factor	Loss	Factor	Pos	Pos	Avg.	
3+4		(MHz)	(dBµV/m)	(dB)	(dBµV/m)	(dBµV)	(dB/m)	(dB)	(dB)	(cm)	(deg)	(P/A)	(H/V)
802.11a CH 169 5845MHz		5618.29	53.7	-14.5	68.2	41.21	33.14	6.78	27.43	100	88	P	H
		5664.605	53.64	-25.4	79.04	40.94	33.32	6.82	27.44	100	88	P	H
		5719.18	53.28	-57.29	110.57	40.16	33.72	6.86	27.46	100	88	P	H
		5723.9	52.68	-67.01	119.69	39.54	33.74	6.86	27.46	100	88	P	H
	*	5845	106.09	-	-	92.35	34.29	6.94	27.49	100	88	P	H
	*	5845	99.02	-	-	85.28	34.29	6.94	27.49	100	88	A	H
		5909.25	54.3	-45.44	99.74	40.35	34.5	6.96	27.51	100	88	P	H
		5945.25	54.45	-33.75	88.2	40.5	34.5	6.97	27.52	100	88	P	H
		5897	45.46	-43.27	88.73	31.52	34.49	6.95	27.5	100	88	A	H
		5938.5	45.02	-23.18	68.2	31.06	34.5	6.97	27.51	100	88	A	H
		5627.14	53.57	-14.63	68.2	41.06	33.15	6.79	27.43	361	112	P	V
		5665.195	53.59	-25.89	79.48	40.89	33.32	6.82	27.44	361	112	P	V
		5700.3	52.6	-52.68	105.28	39.6	33.6	6.85	27.45	361	112	P	V
		5721.245	52.91	-60.73	113.64	39.78	33.73	6.86	27.46	361	112	P	V
	*	5845	108.03	-	-	94.29	34.29	6.94	27.49	361	112	P	V
	*	5845	100.82	-	-	87.08	34.29	6.94	27.49	361	112	A	V
		5901.75	54.26	-50.98	105.24	40.3	34.5	6.96	27.5	361	112	P	V
		5985	54.32	-33.88	88.2	40.51	34.36	6.98	27.53	361	112	P	V
	5899.25	45.41	-41.67	87.08	31.46	34.5	6.95	27.5	361	112	A	V	
	5928.5	45.11	-23.09	68.2	31.16	34.5	6.96	27.51	361	112	A	V	



WIFI Ant. 3+4	Note	Frequency (MHz)	Level (dBμV/m)	Margin Limit (dB)	Limit Line (dBμV/m)	Read Level (dBμV)	Antenna Factor (dB/m)	Path Loss (dB)	Preamp Factor (dB)	Ant Pos (cm)	Table Pos (deg)	Peak Avg. (P/A)	Pol. (H/V)	
802.11a CH 173 5865MHz		5601.77	52.93	-15.27	68.2	40.49	33.1	6.77	27.43	100	89	P	H	
		5690.27	53.26	-44.77	98.03	40.35	33.52	6.84	27.45	100	89	P	H	
		5707.97	53.51	-53.92	107.43	40.46	33.65	6.85	27.45	100	89	P	H	
		5723.31	52.56	-65.79	118.35	39.42	33.74	6.86	27.46	100	89	P	H	
	*	5865	106.35	-	-	92.54	34.36	6.94	27.49	100	89	P	H	
	*	5865	99.12	-	-	85.31	34.36	6.94	27.49	100	89	A	H	
		5898	57.06	-50.93	107.99	43.12	34.49	6.95	27.5	100	89	P	H	
		5934.75	53.5	-34.7	88.2	39.54	34.5	6.97	27.51	100	89	P	H	
		5897.75	47.21	-40.97	88.18	33.27	34.49	6.95	27.5	100	89	A	H	
		5936.75	45.03	-23.17	68.2	31.07	34.5	6.97	27.51	100	89	A	H	
														H
														H
			5614.75	52.77	-15.43	68.2	40.29	33.13	6.78	27.43	338	116	P	V
			5697.055	53.71	-49.32	103.03	40.74	33.58	6.84	27.45	338	116	P	V
			5713.575	52.94	-56.06	109	39.86	33.68	6.86	27.46	338	116	P	V
			5721.54	51.69	-62.62	114.31	38.56	33.73	6.86	27.46	338	116	P	V
	*		5865	108.49	-	-	94.68	34.36	6.94	27.49	338	116	P	V
	*		5865	100.72	-	-	86.91	34.36	6.94	27.49	338	116	A	V
			5898.75	56.97	-50.47	107.44	43.03	34.49	6.95	27.5	338	116	P	V
			5938.5	54.26	-33.94	88.2	40.3	34.5	6.97	27.51	338	116	P	V
		5896.5	47.69	-41.41	89.1	33.75	34.49	6.95	27.5	338	116	A	V	
		5928	45.14	-23.06	68.2	31.19	34.5	6.96	27.51	338	116	A	V	
													V	
													V	



WiFi Ant. 3+4	Note	Frequency (MHz)	Level (dBμV/m)	Margin Limit (dB)	Limit Line (dBμV/m)	Read Level (dBμV)	Antenna Factor (dB/m)	Path Loss (dB)	Preamp Factor (dB)	Ant Pos (cm)	Table Pos (deg)	Peak Avg. (P/A)	Pol. (H/V)
802.11a CH 177 5885MHz		5642.185	53.51	-14.69	68.2	40.97	33.18	6.8	27.44	100	90	P	H
		5688.795	53.08	-43.86	96.94	40.18	33.51	6.84	27.45	100	90	P	H
		5712.1	53.84	-54.75	108.59	40.78	33.67	6.85	27.46	100	90	P	H
		5721.54	52.71	-61.6	114.31	39.58	33.73	6.86	27.46	100	90	P	H
	*	5885	106.32	-	-	92.43	34.44	6.95	27.5	100	90	P	H
	*	5885	98.3	-	-	84.41	34.44	6.95	27.5	100	90	A	H
		5895.5	84.2	-25.63	109.83	70.27	34.48	6.95	27.5	100	90	P	H
		5957.75	54.12	-34.08	88.2	40.19	34.47	6.98	27.52	100	90	P	H
		5895	74.82	-15.38	90.2	60.89	34.48	6.95	27.5	100	90	A	H
		5927.5	45.36	-22.84	68.2	31.41	34.5	6.96	27.51	100	90	A	H
		5649.56	52.84	-15.36	68.2	40.27	33.2	6.81	27.44	339	111	P	V
		5699.415	53.58	-51.19	104.77	40.59	33.6	6.84	27.45	339	111	P	V
		5717.705	52.84	-57.32	110.16	39.73	33.71	6.86	27.46	339	111	P	V
		5722.13	52.68	-62.98	115.66	39.55	33.73	6.86	27.46	339	111	P	V
	*	5885	108.33	-	-	94.44	34.44	6.95	27.5	339	111	P	V
	*	5885	100.34	-	-	86.45	34.44	6.95	27.5	339	111	A	V
		5895.25	88.91	-21.11	110.02	74.98	34.48	6.95	27.5	339	111	P	V
		5932.25	54.05	-34.15	88.2	40.09	34.5	6.97	27.51	339	111	P	V
		5895	76.84	-13.36	90.2	62.91	34.48	6.95	27.5	339	111	A	V
	5929	45.36	-22.84	68.2	31.4	34.5	6.97	27.51	339	111	A	V	
Remark	1. No other spurious found. 2. All results are PASS against Peak and Average limit line.												



UNII-4 - 5850~5895MHz

WIFI 802.11a (Harmonic @ 3m)

WIFI Ant. 3+4	Note	Frequency (MHz)	Level (dBµV/m)	Margin Limit (dB)	Limit Line (dBµV/m)	Read Level (dBµV)	Antenna Factor (dB/m)	Path Loss (dB)	Preamp Factor (dB)	Ant Pos (cm)	Table Pos (deg)	Peak Avg. (P/A)	Pol. (H/V)
802.11a CH 169 5845MHz		11690	45.63	-28.37	74	52.02	38.52	11.04	55.95	-	-	P	H
		17535	65.23	-2.97	68.2	68.85	39.04	14.02	56.68	147	80	P	H
													H
													H
													H
													H
													H
													H
													H
													H
													H
													H
													H
													H
													H
													H
													H
													H
													H
			11690	46.42	-27.58	74	52.81	38.52	11.04	55.95	-	-	P
		17535	66.53	-1.67	68.2	70.15	39.04	14.02	56.68	109	84	A	V
													V
													V
													V
													V
													V
													V
													V
													V
													V
													V
													V
													V
													V
													V



WIFI Ant. 3+4	Note	Frequency (MHz)	Level (dBµV/m)	Margin Limit (dB)	Limit Line (dBµV/m)	Read Level (dBµV)	Antenna Factor (dB/m)	Path Loss (dB)	Preamp Factor (dB)	Ant Pos (cm)	Table Pos (deg)	Peak Avg. (P/A)	Pol. (H/V)
802.11a CH 173 5865MHz		11730	44.75	-29.25	74	51.16	38.5	11.04	55.95	-	-	P	H
		17595	63.18	-5.02	68.2	66.52	39.28	14.06	56.68	112	74	A	H
												P	H
													H
													H
													H
													H
													H
													H
													H
		11730	44.98	-29.02	74	51.39	38.5	11.04	55.95	-	-	P	V
		17595	66.42	-1.78	68.2	69.76	39.28	14.06	56.68	121	99	A	V
													V
													V
													V
													V
													V
													V
													V
													V
													V



WIFI Ant. 3+4	Note	Frequency (MHz)	Level (dBμV/m)	Margin Limit (dB)	Limit Line (dBμV/m)	Read Level (dBμV)	Antenna Factor (dB/m)	Path Loss (dB)	Preamp Factor (dB)	Ant Pos (cm)	Table Pos (deg)	Peak Avg. (P/A)	Pol. (H/V)
802.11a CH 177 5885MHz		11770	45.08	-28.92	74	51.49	38.5	11.03	55.94	-	-	P	H
		17655	61.6	-6.6	68.2	64.56	39.63	14.09	56.68	124	76	P	H
													H
													H
													H
													H
													H
													H
													H
													H
													H
													H
													H
													H
													H
													H
													H
													H
													H
			11770	44.93	-29.07	74	51.34	38.5	11.03	55.94	-	-	P
		17655	66.52	-1.68	68.2	69.48	39.63	14.09	56.68	110	86	A	V
													V
													V
													V
													V
													V
													V
													V
													V
													V
													V
													V
													V
													V
Remark	<ol style="list-style-type: none"> No other spurious found. All results are PASS against Peak and Average limit line. The emission position marked as "-" means no suspected emission found with sufficient margin against limit line or noise floor only. 												



UNII-4 - 5850~5895MHz

WIFI 802.11be EHT20 Full RU (Band Edge @ 3m)

WIFI Ant. 3+4	Note	Frequency (MHz)	Level (dBμV/m)	Margin Limit (dB)	Limit Line (dBμV/m)	Read Level (dBμV)	Antenna Factor (dB/m)	Path Loss (dB)	Preamp Factor (dB)	Ant Pos (cm)	Table Pos (deg)	Peak Avg. (P/A)	Pol. (H/V)
802.11be EHT20 Full RU CH 169 5845MHz		5638.35	53.24	-14.96	68.2	40.7	33.18	6.8	27.44	111	117	P	H
		5674.045	52.81	-33.22	86.03	40.04	33.39	6.83	27.45	111	117	P	H
		5707.38	53.45	-53.82	107.27	40.41	33.64	6.85	27.45	111	117	P	H
		5724.49	53.6	-67.44	121.04	40.45	33.75	6.86	27.46	111	117	P	H
	*	5845	106.98	-	-	93.24	34.29	6.94	27.49	111	117	P	H
	*	5845	98.45	-	-	84.71	34.29	6.94	27.49	111	117	A	H
		5906.25	54.07	-47.87	101.94	40.12	34.5	6.96	27.51	111	117	P	H
		5927.25	54.26	-33.94	88.2	40.31	34.5	6.96	27.51	111	117	P	H
		5901.75	46.05	-39.19	85.24	32.09	34.5	6.96	27.5	111	117	A	H
		5943.25	45.64	-22.56	68.2	31.69	34.5	6.97	27.52	111	117	A	H
		5631.86	53.56	-14.64	68.2	41.04	33.16	6.79	27.43	345	114	P	V
		5656.345	54.79	-18.12	72.91	42.17	33.25	6.81	27.44	345	114	P	V
		5718.885	53.51	-56.98	110.49	40.4	33.71	6.86	27.46	345	114	P	V
		5722.425	53.12	-63.21	116.33	39.99	33.73	6.86	27.46	345	114	P	V
	*	5845	107.42	-	-	93.68	34.29	6.94	27.49	345	114	P	V
	*	5845	99.23	-	-	85.49	34.29	6.94	27.49	345	114	A	V
		5905.5	54.82	-47.67	102.49	40.87	34.5	6.96	27.51	345	114	P	V
		5944.25	54.25	-33.95	88.2	40.3	34.5	6.97	27.52	345	114	P	V
		5917	45.95	-28.11	74.06	32	34.5	6.96	27.51	345	114	A	V
	5939.5	45.7	-22.5	68.2	31.74	34.5	6.97	27.51	345	114	A	V	



WIFI Ant. 3+4	Note	Frequency (MHz)	Level (dBμV/m)	Margin Limit (dB)	Limit Line (dBμV/m)	Read Level (dBμV)	Antenna Factor (dB/m)	Path Loss (dB)	Preamp Factor (dB)	Ant Pos (cm)	Table Pos (deg)	Peak Avg. (P/A)	Pol. (H/V)
802.11be EHT20 Full RU CH 173 5865MHz		5645.43	52.46	-15.74	68.2	39.91	33.19	6.8	27.44	100	116	P	H
		5695.58	53.94	-48	101.94	40.99	33.56	6.84	27.45	100	116	P	H
		5716.525	53.38	-56.45	109.83	40.28	33.7	6.86	27.46	100	116	P	H
		5724.785	52.02	-69.69	121.71	38.87	33.75	6.86	27.46	100	116	P	H
	*	5865	106.44	-	-	92.63	34.36	6.94	27.49	100	116	P	H
	*	5865	98.3	-	-	84.49	34.36	6.94	27.49	100	116	A	H
		5895.75	58.61	-51.04	109.65	44.68	34.48	6.95	27.5	100	116	P	H
		5973.75	54	-34.2	88.2	40.14	34.4	6.98	27.52	100	116	P	H
		5895.25	50.48	-39.54	90.02	36.55	34.48	6.95	27.5	100	116	A	H
		5936.75	45.76	-22.44	68.2	31.8	34.5	6.97	27.51	100	116	A	H
		5605.015	53.83	-14.37	68.2	41.38	33.11	6.77	27.43	337	113	P	V
		5689.975	53.97	-43.84	97.81	41.06	33.52	6.84	27.45	337	113	P	V
		5712.1	52.31	-56.28	108.59	39.25	33.67	6.85	27.46	337	113	P	V
		5725.08	51.91	-82.29	134.2	38.76	33.75	6.86	27.46	337	113	P	V
	*	5865	107.43	-	-	93.62	34.36	6.94	27.49	337	113	P	V
	*	5865	98.71	-	-	84.9	34.36	6.94	27.49	337	113	A	V
		5895.75	61.12	-48.53	109.65	47.19	34.48	6.95	27.5	337	113	P	V
		5941.25	54.25	-33.95	88.2	40.29	34.5	6.97	27.51	337	113	P	V
	5895.25	51.21	-38.81	90.02	37.28	34.48	6.95	27.5	337	113	A	V	
	5936.25	45.75	-22.45	68.2	31.79	34.5	6.97	27.51	337	113	A	V	



WIFI Ant. 3+4	Note	Frequency (MHz)	Level (dBμV/m)	Margin Limit (dB)	Limit Line (dBμV/m)	Read Level (dBμV)	Antenna Factor (dB/m)	Path Loss (dB)	Preamp Factor (dB)	Ant Pos (cm)	Table Pos (deg)	Peak Avg. (P/A)	Pol. (H/V)
802.11be EHT20 Full RU CH 177 5885MHz		5638.055	52.96	-15.24	68.2	40.42	33.18	6.8	27.44	100	115	P	H
		5691.45	53.78	-45.12	98.9	40.86	33.53	6.84	27.45	100	115	P	H
		5709.15	53.33	-54.43	107.76	40.28	33.65	6.85	27.45	100	115	P	H
		5724.785	53.17	-68.54	121.71	40.02	33.75	6.86	27.46	100	115	P	H
	*	5885	104.97	-	-	91.08	34.44	6.95	27.5	100	115	P	H
	*	5885	96.45	-	-	82.56	34.44	6.95	27.5	100	115	A	H
		5895	92.47	-17.73	110.2	78.54	34.48	6.95	27.5	100	115	P	H
		5927.5	54.11	-34.09	88.2	40.16	34.5	6.96	27.51	100	115	P	H
		5895	86.42	-3.78	90.2	72.49	34.48	6.95	27.5	100	115	A	H
		5946.5	45.89	-22.31	68.2	31.94	34.5	6.97	27.52	100	115	A	H
		5612.39	52.85	-15.35	68.2	40.38	33.12	6.78	27.43	300	114	P	V
		5696.465	53.27	-49.32	102.59	40.31	33.57	6.84	27.45	300	114	P	V
		5709.445	52.61	-55.24	107.85	39.55	33.66	6.85	27.45	300	114	P	V
		5721.835	52	-62.98	114.98	38.87	33.73	6.86	27.46	300	114	P	V
	*	5885	106.93	-	-	93.04	34.44	6.95	27.5	300	114	P	V
	*	5885	97.34	-	-	83.45	34.44	6.95	27.5	300	114	A	V
		5895	94.46	-15.74	110.2	80.53	34.48	6.95	27.5	300	114	P	V
		5926.25	54.95	-33.25	88.2	41	34.5	6.96	27.51	300	114	P	V
	5895	87.67	-2.53	90.2	73.74	34.48	6.95	27.5	300	114	A	V	
	5925.25	46.86	-21.34	68.2	32.91	34.5	6.96	27.51	300	114	A	V	
Remark	1. No other spurious found. 2. All results are PASS against Peak and Average limit line.												



UNII-4 - 5850~5895MHz

WIFI 802.11be EHT20 Full RU (Harmonic @ 3m)

WIFI Ant. 3+4	Note	Frequency (MHz)	Level (dBμV/m)	Margin Limit (dB)	Limit Line (dBμV/m)	Read Level (dBμV)	Antenna Factor (dB/m)	Path Loss (dB)	Preamp Factor (dB)	Ant Pos (cm)	Table Pos (deg)	Peak Avg. (P/A)	Pol. (H/V)
802.11be EHT20 Full RU CH 169 5845MHz		11690	46.46	-27.54	74	52.85	38.52	11.04	55.95	-	-	P	H
		17535	63.27	-4.93	68.2	66.89	39.04	14.02	56.68	128	79	A	H
													H
													H
													H
													H
													H
													H
													H
													H
													H
													H
													H
													H
													H
													H
													H
													H
													H
			11690	45.23	-28.77	74	51.62	38.52	11.04	55.95	-	-	P
		17535	65.89	-2.31	68.2	69.51	39.04	14.02	56.68	115	59	A	V
													V
													V
													V
													V
													V
													V
													V
													V
													V
													V
													V
													V
													V
													V



WIFI Ant. 3+4	Note	Frequency (MHz)	Level (dBµV/m)	Margin Limit (dB)	Limit Line (dBµV/m)	Read Level (dBµV)	Antenna Factor (dB/m)	Path Loss (dB)	Preamp Factor (dB)	Ant Pos (cm)	Table Pos (deg)	Peak Avg. (P/A)	Pol. (H/V)	
802.11be EHT20 Full RU CH 173 5865MHz		11730	46.31	-27.69	74	52.72	38.5	11.04	55.95	-	-	P	H	
		17595	64.1	-4.1	68.2	67.44	39.28	14.06	56.68	116	80	A	H	
													H	
													H	
													H	
													H	
													H	
													H	
													H	
													H	
													H	
													H	
													H	
													H	
													H	
													H	
													H	
													H	
			11730	45.27	-28.73	74	51.68	38.5	11.04	55.95	-	-	P	V
			17595	66.49	-1.71	68.2	69.83	39.28	14.06	56.68	118	98	A	V
													V	
													V	
													V	
													V	
													V	
													V	
													V	
													V	
													V	
													V	
													V	
													V	
													V	
													V	



WiFi Ant. 3+4	Note	Frequency (MHz)	Level (dBµV/m)	Margin Limit (dB)	Limit Line (dBµV/m)	Read Level (dBµV)	Antenna Factor (dB/m)	Path Loss (dB)	Preamp Factor (dB)	Ant Pos (cm)	Table Pos (deg)	Peak Avg. (P/A)	Pol. (H/V)	
802.11be EHT20 Full RU CH 177 5885MHz		11770	45	-29	74	51.41	38.5	11.03	55.94	-	-	P	H	
		17655	62.51	-5.69	68.2	65.47	39.63	14.09	56.68	114	79	A	H	
													H	
													H	
													H	
													H	
													H	
													H	
													H	
													H	
													H	
													H	
													H	
													H	
													H	
													H	
													H	
													H	
			11770	45.46	-28.54	74	51.87	38.5	11.03	55.94	-	-	P	V
			17655	66.6	-1.6	68.2	69.56	39.63	14.09	56.68	111	100	A	V
													V	
													V	
													V	
													V	
													V	
													V	
													V	
													V	
													V	
													V	
													V	
													V	
Remark	1. No other spurious found. 2. All results are PASS against Peak and Average limit line. 3. The emission position marked as "-" means no suspected emission found with sufficient margin against limit line or noise floor only.													



UNII-4 - 5850~5895MHz

WIFI 802.11be EHT40 Full RU (Band Edge @ 3m)

WIFI Ant. 3+4	Note	Frequency (MHz)	Level (dBμV/m)	Margin Limit (dB)	Limit Line (dBμV/m)	Read Level (dBμV)	Antenna Factor (dB/m)	Path Loss (dB)	Preamp Factor (dB)	Ant Pos (cm)	Table Pos (deg)	Peak Avg. (P/A)	Pol. (H/V)
		5648.675	52.9	-15.3	68.2	40.33	33.2	6.81	27.44	104	298	P	H
		5690.27	54.13	-43.9	98.03	41.22	33.52	6.84	27.45	104	298	P	H
		5705.61	52.62	-54.15	106.77	39.59	33.63	6.85	27.45	104	298	P	H
		5721.835	52.32	-62.66	114.98	39.19	33.73	6.86	27.46	104	298	P	H
	*	5835	103.53	-	-	89.82	34.27	6.93	27.49	104	298	P	H
	*	5835	94.33	-	-	80.62	34.27	6.93	27.49	104	298	A	H
		5900.25	57.61	-48.73	106.34	43.65	34.5	6.96	27.5	104	298	P	H
		5944.5	54.8	-33.4	88.2	40.85	34.5	6.97	27.52	104	298	P	H
		5900.25	48.14	-38.2	86.34	34.18	34.5	6.96	27.5	104	298	A	H
		5934.5	45.07	-23.13	68.2	31.11	34.5	6.97	27.51	104	298	A	H
		5612.685	53.53	-14.67	68.2	41.05	33.13	6.78	27.43	348	105	P	V
		5677.585	53.41	-35.24	88.65	40.61	33.42	6.83	27.45	348	105	P	V
		5707.97	54.2	-53.23	107.43	41.15	33.65	6.85	27.45	348	105	P	V
		5720.065	52.48	-58.47	110.95	39.36	33.72	6.86	27.46	348	105	P	V
	*	5835	104.5	-	-	90.79	34.27	6.93	27.49	348	105	P	V
	*	5835	95.65	-	-	81.94	34.27	6.93	27.49	348	105	A	V
		5898.5	58.98	-48.65	107.63	45.04	34.49	6.95	27.5	348	105	P	V
		5950.25	54.3	-33.9	88.2	40.35	34.5	6.97	27.52	348	105	P	V
		5895.25	48.96	-41.06	90.02	35.03	34.48	6.95	27.5	348	105	A	V
		5925	45.41	-22.79	68.2	31.46	34.5	6.96	27.51	348	105	A	V



WIFI Ant. 3+4	Note	Frequency (MHz)	Level (dBμV/m)	Margin Limit (dB)	Limit Line (dBμV/m)	Read Level (dBμV)	Antenna Factor (dB/m)	Path Loss (dB)	Preamp Factor (dB)	Ant Pos (cm)	Table Pos (deg)	Peak Avg. (P/A)	Pol. (H/V)
802.11be EHT40 Full RU CH 175 5875MHz		5641.3	53.55	-14.65	68.2	41.01	33.18	6.8	27.44	100	299	P	H
		5682.6	53.01	-39.35	92.36	40.17	33.46	6.83	27.45	100	299	P	H
		5717.115	53.04	-56.95	109.99	39.94	33.7	6.86	27.46	100	299	P	H
		5724.49	51.91	-69.13	121.04	38.76	33.75	6.86	27.46	100	299	P	H
	*	5875	103.5	-	-	89.65	34.4	6.95	27.5	100	299	P	H
	*	5875	93.8	-	-	79.95	34.4	6.95	27.5	100	299	A	H
		5895	78.11	-32.09	110.2	64.18	34.48	6.95	27.5	100	299	P	H
		5926.25	62.08	-26.12	88.2	48.13	34.5	6.96	27.51	100	299	P	H
		5895	71.66	-18.54	90.2	57.73	34.48	6.95	27.5	100	299	A	H
		5925	50.34	-17.86	68.2	36.39	34.5	6.96	27.51	100	299	A	H
		5600	52.52	-15.68	68.2	40.08	33.1	6.77	27.43	361	107	P	V
		5680.535	52.97	-37.86	90.83	40.15	33.44	6.83	27.45	361	107	P	V
		5707.38	54.11	-53.16	107.27	41.07	33.64	6.85	27.45	361	107	P	V
		5721.54	52.3	-62.01	114.31	39.17	33.73	6.86	27.46	361	107	P	V
	*	5875	105.71	-	-	91.86	34.4	6.95	27.5	361	107	P	V
	*	5875	95.56	-	-	81.71	34.4	6.95	27.5	361	107	A	V
		5895	79.92	-30.28	110.2	65.99	34.48	6.95	27.5	361	107	P	V
		5927.5	61.9	-26.3	88.2	47.95	34.5	6.96	27.51	361	107	P	V
	5895	73.31	-16.89	90.2	59.38	34.48	6.95	27.5	361	107	A	V	
	5925.25	50.88	-17.32	68.2	36.93	34.5	6.96	27.51	361	107	A	V	
Remark	1. No other spurious found. 2. All results are PASS against Peak and Average limit line.												



UNII-4 - 5850~5895MHz

WIFI 802.11be EHT40 Full RU (Harmonic @ 3m)

WIFI Ant. 3+4	Note	Frequency (MHz)	Level (dBμV/m)	Margin Limit (dB)	Limit Line (dBμV/m)	Read Level (dBμV)	Antenna Factor (dB/m)	Path Loss (dB)	Preamp Factor (dB)	Ant Pos (cm)	Table Pos (deg)	Peak Avg. (P/A)	Pol. (H/V)	
802.11be EHT40 Full RU CH 167 5835MHz		11670	45.98	-28.02	74	52.44	38.56	11.05	56.07	-	-	P	H	
		17505	60.97	-7.23	68.2	65.11	38.92	14	57.06	100	70	A	H	
													H	
													H	
													H	
													H	
													H	
													H	
													H	
													H	
													H	
													H	
			11670	45.81	-28.19	74	52.27	38.56	11.05	56.07	-	-	P	V
			17505	65.07	-3.13	68.2	69.21	38.92	14	57.06	100	57	A	V
														V
														V
														V
														V
														V
													V	
													V	



WiFi Ant. 3+4	Note	Frequency (MHz)	Level (dBµV/m)	Margin Limit (dB)	Limit Line (dBµV/m)	Read Level (dBµV)	Antenna Factor (dB/m)	Path Loss (dB)	Preamp Factor (dB)	Ant Pos (cm)	Table Pos (deg)	Peak Avg. (P/A)	Pol. (H/V)	
802.11be EHT40 Full RU CH 175 5875MHz		11750	45.79	-28.21	74	52.33	38.5	11.03	56.07	-	-	P	H	
		17625	60.66	-7.54	68.2	64.18	39.45	14.08	57.05	100	70	A	H	
													H	
													H	
													H	
													H	
													H	
													H	
													H	
													H	
													H	
													H	
													H	
													H	
													H	
													H	
													H	
													H	
			11750	45.12	-28.88	74	51.66	38.5	11.03	56.07	-	-	P	V
			17625	64.6	-3.6	68.2	68.12	39.45	14.08	57.05	100	60	A	V
													V	
													V	
													V	
													V	
													V	
													V	
													V	
													V	
													V	
													V	
													V	
													V	
													V	
Remark	<ol style="list-style-type: none"> No other spurious found. All results are PASS against Peak and Average limit line. The emission position marked as "-" means no suspected emission found with sufficient margin against limit line or noise floor only. 													



UNII-4 - 5850~5895MHz

WIFI 802.11be EHT80 Full RU (Band Edge @ 3m)

WIFI Ant. 3+4	Note	Frequency (MHz)	Level (dBμV/m)	Margin Limit (dB)	Limit Line (dBμV/m)	Read Level (dBμV)	Antenna Factor (dB/m)	Path Loss (dB)	Preamp Factor (dB)	Ant Pos (cm)	Table Pos (deg)	Peak Avg. (P/A)	Pol. (H/V)
802.11be EHT80 Full RU CH 171 5855MHz		5614.16	52.9	-15.3	68.2	40.42	33.13	6.78	27.43	100	299	P	H
		5699.71	54.15	-50.84	104.99	41.16	33.6	6.84	27.45	100	299	P	H
		5710.33	53.98	-54.11	108.09	40.92	33.66	6.85	27.45	100	299	P	H
		5723.31	54.44	-63.91	118.35	41.3	33.74	6.86	27.46	100	299	P	H
	*	5855	102.45	-	-	88.68	34.32	6.94	27.49	100	299	P	H
	*	5855	91.99	-	-	78.22	34.32	6.94	27.49	100	299	A	H
		5895	80.32	-29.88	110.2	66.39	34.48	6.95	27.5	100	299	P	H
		5940.5	68.32	-19.88	88.2	54.36	34.5	6.97	27.51	100	299	P	H
		5895	70.88	-19.32	90.2	56.95	34.48	6.95	27.5	100	299	A	H
		5926.25	58.55	-9.65	68.2	44.6	34.5	6.96	27.51	100	299	A	H
		5619.765	53.12	-15.08	68.2	40.63	33.14	6.78	27.43	342	114	P	V
		5679.945	53.73	-36.67	90.4	40.91	33.44	6.83	27.45	342	114	P	V
		5710.625	54.63	-53.55	108.18	41.57	33.66	6.85	27.45	342	114	P	V
		5725.08	53.9	-80.3	134.2	40.75	33.75	6.86	27.46	342	114	P	V
	*	5855	103.29	-	-	89.52	34.32	6.94	27.49	342	114	P	V
	*	5855	93.92	-	-	80.15	34.32	6.94	27.49	342	114	A	V
		5895	82.57	-27.63	110.2	68.64	34.48	6.95	27.5	342	114	P	V
		5927.5	71.35	-16.85	88.2	57.4	34.5	6.96	27.51	342	114	P	V
		5895	72.97	-17.23	90.2	59.04	34.48	6.95	27.5	342	114	A	V
	5925	60.33	-7.87	68.2	46.38	34.5	6.96	27.51	342	114	A	V	
Remark	1. No other spurious found. 2. All results are PASS against Peak and Average limit line.												



UNII-4 - 5850~5895MHz

WIFI 802.11be EHT80 Full RU (Harmonic @ 3m)

WIFI Ant. 3+4	Note	Frequency (MHz)	Level (dBμV/m)	Margin Limit (dB)	Limit Line (dBμV/m)	Read Level (dBμV)	Antenna Factor (dB/m)	Path Loss (dB)	Preamp Factor (dB)	Ant Pos (cm)	Table Pos (deg)	Peak Avg. (P/A)	Pol. (H/V)
802.11be EHT80 Full RU CH 171 5855MHz		11710	46.03	-27.97	74	52.56	38.5	11.04	56.07	-	-	P	H
		17565	57.95	-10.25	68.2	61.81	39.16	14.04	57.06	100	63	A	H
													H
													H
													H
													H
													H
													H
													H
													H
													H
													H
													H
													H
													H
													H
													H
													H
													H
			11710	45.78	-28.22	74	52.31	38.5	11.04	56.07	-	-	P
		17565	63.35	-4.85	68.2	67.21	39.16	14.04	57.06	100	60	A	V
													V
													V
													V
													V
													V
													V
													V
													V
													V
													V
													V
													V
Remark	<ol style="list-style-type: none"> No other spurious found. All results are PASS against Peak and Average limit line. The emission position marked as "-" means no suspected emission found with sufficient margin against limit line or noise floor only. 												



UNII-4 - 5850~5895MHz

WIFI 802.11be EHT160 Full RU (Band Edge @ 3m)

WIFI Ant. 3+4	Note	Frequency (MHz)	Level (dBμV/m)	Margin Limit (dB)	Limit Line (dBμV/m)	Read Level (dBμV)	Antenna Factor (dB/m)	Path Loss (dB)	Preamp Factor (dB)	Ant Pos (cm)	Table Pos (deg)	Peak Avg. (P/A)	Pol. (H/V)
802.11be EHT160 Full RU CH 163 5815MHz		5642.48	64.23	-3.97	68.2	51.69	33.18	6.8	27.44	105	297	P	H
		5700.005	72.24	-32.96	105.2	59.24	33.6	6.85	27.45	105	297	P	H
		5704.43	72.72	-33.72	106.44	59.69	33.63	6.85	27.45	105	297	P	H
		5723.9	70.82	-48.87	119.69	57.68	33.74	6.86	27.46	105	297	P	H
	*	5815	99.46	-	-	85.78	34.23	6.93	27.48	105	297	P	H
	*	5815	89.53	-	-	75.85	34.23	6.93	27.48	105	297	A	H
		5895	77.24	-32.96	110.2	63.31	34.48	6.95	27.5	105	297	P	H
		5950.5	72.93	-15.27	88.2	58.98	34.5	6.97	27.52	105	297	P	H
		5895	70.07	-20.13	90.2	56.14	34.48	6.95	27.5	105	297	A	H
		5940.25	63.05	-5.15	68.2	49.09	34.5	6.97	27.51	105	297	A	H
		5646.02	61.2	-7	68.2	48.65	33.19	6.8	27.44	342	119	P	V
		5695.58	70.73	-31.21	101.94	57.78	33.56	6.84	27.45	342	119	P	V
		5712.1	73.69	-34.9	108.59	60.63	33.67	6.85	27.46	342	119	P	V
		5721.54	69.74	-44.57	114.31	56.61	33.73	6.86	27.46	342	119	P	V
	*	5815	100.61	-	-	86.93	34.23	6.93	27.48	342	119	P	V
	*	5815	91.16	-	-	77.48	34.23	6.93	27.48	342	119	A	V
		5895	82.72	-27.48	110.2	68.79	34.48	6.95	27.5	342	119	P	V
		5962	75.34	-12.86	88.2	61.43	34.45	6.98	27.52	342	119	P	V
	5895	72.03	-18.17	90.2	58.1	34.48	6.95	27.5	342	119	A	V	
	5942.25	65.23	-2.97	68.2	51.27	34.5	6.97	27.51	342	119	A	V	
Remark	1. No other spurious found. 2. All results are PASS against Peak and Average limit line.												



UNII-4 - 5850~5895MHz

WIFI 802.11be EHT160 Full RU (Harmonic @ 3m)

WIFI Ant. 3+4	Note	Frequency (MHz)	Level (dBμV/m)	Margin Limit (dB)	Limit Line (dBμV/m)	Read Level (dBμV)	Antenna Factor (dB/m)	Path Loss (dB)	Preamp Factor (dB)	Ant Pos (cm)	Table Pos (deg)	Peak Avg. (P/A)	Pol. (H/V)
802.11be EHT160 Full RU CH 163 5815MHz		11630	45.96	-28.04	74	52.34	38.64	11.05	56.07	-	-	P	H
		17445	54.73	-13.47	68.2	58.94	38.79	13.96	56.96	100	63	P	H
													H
													H
													H
													H
													H
													H
													H
													H
													H
													H
													H
													H
													H
													H
													H
													H
													H
			11630	45.35	-28.65	74	51.73	38.64	11.05	56.07	-	-	P
		17445	59.58	-8.62	68.2	63.79	38.79	13.96	56.96	100	59	A	V
													V
													V
													V
													V
													V
													V
													V
													V
													V
													V
													V
													V
													V
Remark	<ol style="list-style-type: none"> No other spurious found. All results are PASS against Peak and Average limit line. The emission position marked as "-" means no suspected emission found with sufficient margin against limit line or noise floor only. 												



Emission above 18GHz

5GHz WIFI 802. 11a (SHF @ 1m)

WIFI	Note	Frequency	Level	Margin	Limit	Read	Antenna	Path	Preamp	Ant	Table	Peak	Pol.
Ant.				Limit	Line	Level	Factor	Loss	Factor	Pos	Pos	Avg.	
3+4		(MHz)	(dBμV/m)	(dB)	(dBμV/m)	(dBμV)	(dB/m)	(dB)	(dB)	(cm)	(deg)	(P/A)	(H/V)
802. 11a SHF		18132	45.14	-28.86	74	66.9	37.75	-3.69	55.82	-	-	P	H
		31354	46.51	-27.49	74	63.7	40.84	-1.61	56.42	-	-	P	H
													H
													H
													H
													H
													H
													H
													H
													H
													H
													H
													H
													H
													H
													H
													H
													H
													H
			18240	45.31	-28.69	74	66.91	37.8	-3.64	55.76	-	-	P
		31706	44.93	-29.07	74	62.92	40.53	-1.76	56.76	-	-	P	V
													V
													V
													V
													V
													V
													V
													V
													V
													V
													V
													V
													V
													V
													V
													V
													V

Remark

1. No other spurious found.
2. All results are PASS against limit line.
3. The emission position marked as "-" means no suspected emission found with sufficient margin against limit line or noise floor only.



Emission below 1GHz

WIFI 802. 11a Full (LF @ 3m)

WIFI	Note	Frequency	Level	Margin	Limit	Read	Antenna	Path	Preamp	Ant	Table	Peak	Pol.	
Ant.				Limit	Line	Level	Factor	Loss	Factor	Pos	Pos	Avg.		
3+4		(MHz)	(dBμV/m)	(dB)	(dBμV/m)	(dBμV)	(dB/m)	(dB)	(dB)	(cm)	(deg)	(P/A)	(H/V)	
802. 11a LF		53.28	25.79	-14.21	40	43.65	13.24	1.09	32.19	-	-	P	H	
		94.99	31.06	-12.44	43.5	46.53	15.39	1.28	32.14	-	-	P	H	
		185.2	24.64	-18.86	43.5	40.24	14.95	1.55	32.1	-	-	P	H	
		329.73	23.1	-22.9	46	33.34	19.91	1.92	32.07	-	-	P	H	
		720.64	35.85	-10.15	46	38.08	27.2	2.64	32.07	-	-	P	H	
		992.24	33.45	-20.55	54	30.67	30.4	2.92	30.54	-	-	P	H	
														H
														H
														H
														H
														H
														H
			30.97	31.63	-8.37	40	38.63	24.17	0.99	32.16	-	-	P	V
			94.02	28.35	-15.15	43.5	44	15.22	1.27	32.14	-	-	P	V
			180.35	22.95	-20.55	43.5	38.47	15.07	1.52	32.11	-	-	P	V
			730.34	37.02	-8.98	46	38.83	27.58	2.66	32.05	-	-	P	V
			896.21	36.81	-9.19	46	36.33	29.02	2.86	31.4	-	-	P	V
			965.08	33.35	-20.65	54	30.14	31.13	2.9	30.82	-	-	P	V
													V	
													V	
													V	
													V	
													V	
													V	

Remark

- No other spurious found.
- All results are PASS against limit line.
- The emission position marked as "-" means no suspected emission found and emission level has at least 6dB margin against limit or emission is noise floor only.



Note symbol

*	Fundamental Frequency which can be ignored. However, tEHT level of any unwanted emissions shall not exceed tEHT level of tEHT fundamental frequency.
!	Test result is Margin limit line.
P/A	Peak or Average
H/V	Horizontal or Vertical



A calculation example for radiated spurious emission is shown as below:

WIFI	Note	Frequency	Level	Margin	Limit	Read	Antenna	Path	Preamp	Ant	Table	Peak	Pol.
Ant.				Limit	Line	Level	Factor	Loss	Factor	Pos	Pos	Avg.	
3+4		(MHz)	(dBμV/m)	(dB)	(dBμV/m)	(dBμV)	(dB/m)	(dB)	(dB)	(cm)	(deg)	(P/A)	(H/V)
802.11a		5945	55.45	-18.55	74	54.51	32.22	4.58	35.86	103	308	P	H
CH 169		5945	43.54	-10.46	54	42.6	32.22	4.58	35.86	103	308	A	H
5845MHz													

1. Path Loss(dB) = Cable loss(dB) + Filter loss(dB) + Attenuator loss(dB)
2. Level(dBμV/m) = Antenna Factor(dB/m) + Path Loss(dB) + Read Level(dBμV) - Preamp Factor(dB)
3. Margin Limit(dB) = Level(dBμV/m) – Limit Line(dBμV/m)

For Peak Limit @ 5945MHz:

1. Level(dBμV/m)
= Antenna Factor(dB/m) + Path Loss(dB) + Read Level(dBμV) - Preamp Factor(dB)
= 32.22(dB/m) + 4.58(dB) + 54.51(dBμV) – 35.86 (dB)
= 55.45 (dBμV/m)
2. Margin Limit(dB)
= Level(dBμV/m) – Limit Line(dBμV/m)
= 55.45(dBμV/m) – 74(dBμV/m)
= -18.55(dB)

For Average Limit @ 5945MHz:

1. Level(dBμV/m)
= Antenna Factor(dB/m) + Path Loss(dB) + Read Level(dBμV) - Preamp Factor(dB)
= 32.22(dB/m) + 4.58(dB) + 42.6(dBμV) – 35.86 (dB)
= 43.54 (dBμV/m)
2. Margin Limit(dB) = Level(dBμV/m) – Limit Line(dBμV/m)
= 43.54(dBμV/m) – 54(dBμV/m)
= -10.46(dB)

Both peak and average measured complies with tEHT limit line, so test result is “PASS”.



Appendix D. Radiated Spurious Emission Plots

Test Engineer :	Jacky Hung , Mancy Chou, Michael Liu and Rain Lee	Temperature :	20~26°C
		Relative Humidity :	40~65%

Note symbol

-L	Low channel location
-R	High channel location



UNII-4 - 5850~5895MHz
WIFI 802.11a (Band Edge @ 3m)

WIFI	UNII-4 5850~5895MHz Band Edge @ 3m	
ANT	802.11a CH169 5845MHz - L	
3+4	Horizontal	Fundamental
Peak	<p>Site : 03CH13-HY Condition : PEAK_SE(UNITA)_16-24 3m HORN_91200_1326 HORIZONTAL : RBW:1000.000kHz VBW:3000.000kHz SWT:Auto</p>	<p>Site : 03CH13-HY Condition : PEAK(UNITI) 3m HORN_91200_1326 HORIZONTAL : RBW:1000.000kHz VBW:3000.000kHz SWT:Auto</p>
Avg	Left blank	<p>Site : 03CH13-HY Condition : AV6_54 3m HORN_91200_1326 HORIZONTAL : RBW:1000.000kHz VBW:1.000kHz SWT:Auto</p>



WIFI	UNII-4 5850~5895MHz Band Edge @ 3m	
ANT	802.11a CH169 5845MHz - R	
3+4	Horizontal	Fundamental
Peak	<p>Site : 03CH13-HY Condition : PEAK_BE(UNIT 4) 3m HORN_91200_1326 HORIZONTAL : RBW:1000.000KHz VBW:3000.000KHz SWT:Auto</p>	Left blank
Avg.	<p>Site : 03CH13-HY Condition : AVG_BE(UNIT 4) 3m HORN_91200_1326 HORIZONTAL : RBW:1000.000KHz VBW:1000KHz SWT:Auto</p>	Left blank

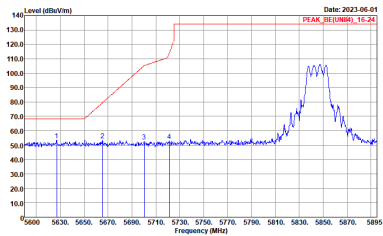
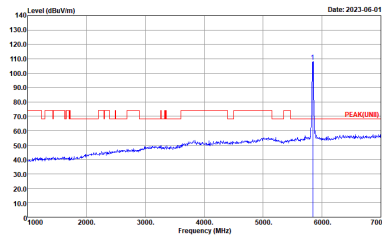
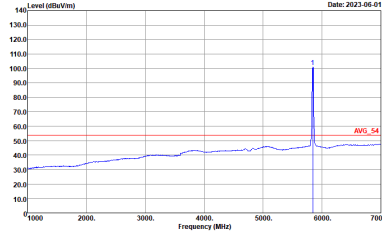

WIFI	UNII-4 5850~5895MHz Band Edge @ 3m	
ANT	802.11a CH169 5845MHz - L	
3+4	Vertical	Fundamental
Peak	 <p>Site : 03CH13-HY Condition : :PEAK_BCFUNII4_16-24 3m HORN_9120D_1326 VERTICAL :RBW:1000.000KHz VBW:3000.000KHz SWT:Auto</p>	 <p>Site : 03CH13-HY Condition : :PEAK(LINE) 3m HORN_9120D_1326 VERTICAL :RBW:1000.000KHz VBW:3000.000KHz SWT:Auto</p>
Avg	Left blank	 <p>Site : 03CH13-HY Condition : :AVG_54 3m HORN_9120D_1326 VERTICAL :RBW:1000.000KHz VBW:1000KHz SWT:Auto</p>

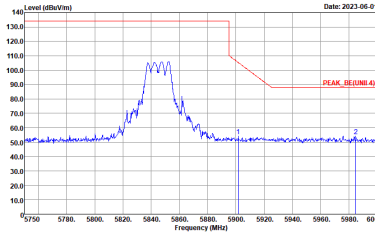
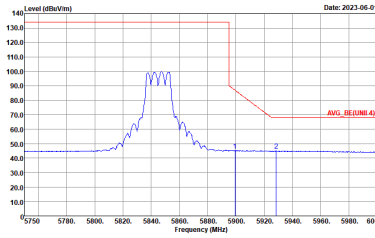

WIFI	UNII-4 5850~5895MHz Band Edge @ 3m	
ANT	802.11a CH169 5845MHz - R	
3+4	Vertical	Fundamental
Peak	 <p>Site : 03CH13-HY Condition : PEAK_BE(UNIT 4) 3m HORN_91200_1326 VERTICAL : RBW:1000.000KHz VBW:3000.000KHz SWT:Auto</p>	Left blank
Avg.	 <p>Site : 03CH13-HY Condition : AVG_BE(UNIT 4) 3m HORN_91200_1326 VERTICAL : RBW:1000.000KHz VBW:1000KHz SWT:Auto</p>	Left blank



WIFI	UNII-4 5850~5895MHz Band Edge @ 3m	
ANT	802.11a CH173 5865MHz - L	
3+4	Horizontal	Fundamental
Peak	<p>Site : 03CH13-HY Condition : PEAK_BE(UNII4)_16-24 3m HORN_91200_1326 HORIZONTAL : RBW:1000.000KHz VBW:3000.000KHz SWT:Auto</p>	<p>Site : 03CH13-HY Condition : PEAK(LINE) 3m HORN_91200_1326 HORIZONTAL : RBW:1000.000KHz VBW:3000.000KHz SWT:Auto</p>
Avg	Left blank	
		<p>Site : 03CH13-HY Condition : AV6_54 3m HORN_91200_1326 HORIZONTAL : RBW:1000.000KHz VBW:1000KHz SWT:Auto</p>



WIFI	UNII-4 5850~5895MHz Band Edge @ 3m	
ANT	802.11a CH173 5865MHz - R	
3+4	Horizontal	Fundamental
Peak	<p>Site : 03CH13-HY Condition : PEAK_BE(UNII 4) 3m HORN_91200_1326 HORIZONTAL : RBW:1000.000KHz VBW:3000.000KHz SWT:Auto</p>	Left blank
Avg.	<p>Site : 03CH13-HY Condition : AVG_BE(UNII 4) 3m HORN_91200_1326 HORIZONTAL : RBW:1000.000KHz VBW:10.000KHz SWT:Auto</p>	Left blank

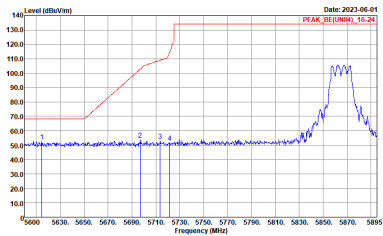
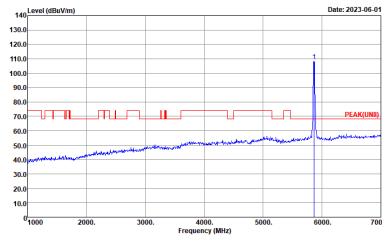
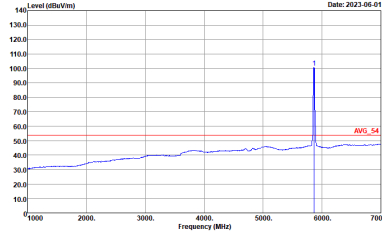

WIFI	UNII-4 5850~5895MHz Band Edge @ 3m	
ANT	802.11a CH173 5865MHz - L	
3+4	Vertical	Fundamental
Peak	 <p>Site : 03CH13-HY Condition : :PEAK_BCFUNII4_16-24 3m HORN_9120D_1326 VERTICAL :RBW:1000.000KHz VBW:3000.000KHz SWT:Auto</p>	 <p>Site : 03CH13-HY Condition : :PEAK(LINE) 3m HORN_9120D_1326 VERTICAL :RBW:1000.000KHz VBW:3000.000KHz SWT:Auto</p>
Avg	Left blank	
		 <p>Site : 03CH13-HY Condition : :AVG_54 3m HORN_9120D_1326 VERTICAL :RBW:1000.000KHz VBW:1000KHz SWT:Auto</p>

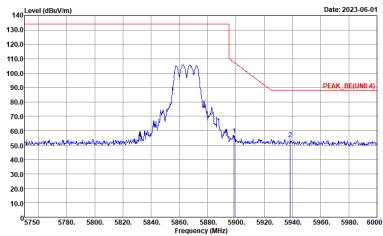
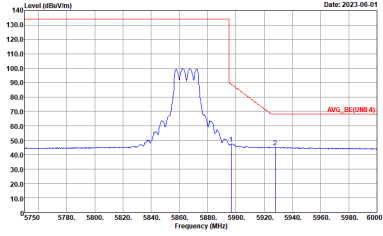

WIFI	UNII-4 5850~5895MHz Band Edge @ 3m	
ANT	802.11a CH173 5865MHz - R	
3+4	Vertical	Fundamental
<p>Peak</p>	 <p>Site : 03CH13-HY Condition : PEAK_BE(UNII 4) 3m HORN_9120D_1326 VERTICAL : RBW:1000.000KHz VBW:3000.000KHz SWT:Auto</p>	<p>Left blank</p>
<p>Avg.</p>	 <p>Site : 03CH13-HY Condition : AVG_BE(UNII 4) 3m HORN_9120D_1326 VERTICAL : RBW:1000.000KHz VBW:1000KHz SWT:Auto</p>	<p>Left blank</p>

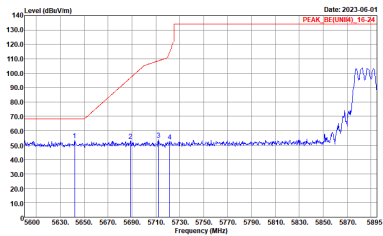
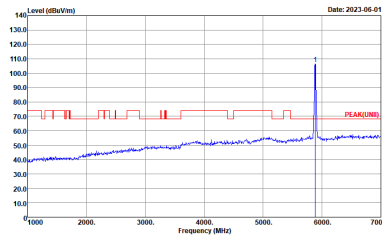
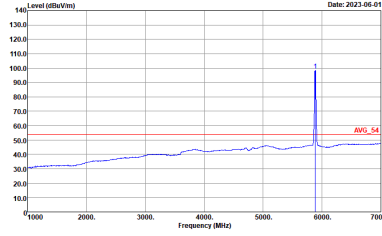

WIFI	UNII-4 5850~5895MHz Band Edge @ 3m	
ANT	802.11a CH177 5885MHz - L	
3+4	Horizontal	Fundamental
Peak	 <p>Date: 2023-06-01 PEAK_BE(HORN)_16-24</p> <p>Site : 03CH13-HY Condition : PEAK_BE(UNII4)_16-24 3m HORN_9120D_1326 HORIZONTAL : RBW:1000.000KHz VBW:3000.000KHz SWT:Auto</p>	 <p>Date: 2023-06-01 PEAK(LINE)</p> <p>Site : 03CH13-HY Condition : PEAK(LINE) 3m HORN_9120D_1326 HORIZONTAL : RBW:1000.000KHz VBW:3000.000KHz SWT:Auto</p>
Avg	Left Blank	
		 <p>Date: 2023-06-01 AVG_54</p> <p>Site : 03CH13-HY Condition : AVG_54 3m HORN_9120D_1326 HORIZONTAL : RBW:1000.000KHz VBW:1.000KHz SWT:Auto</p>

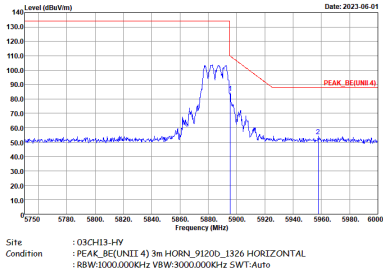
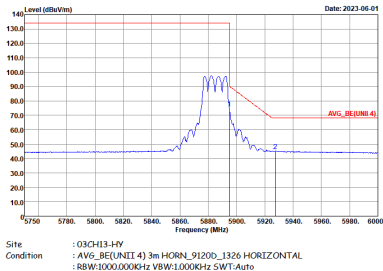

WIFI	UNII-4 5850~5895MHz Band Edge @ 3m	
ANT	802.11a CH177 5885MHz - R	
3+4	Horizontal	Fundamental
Peak		Left blank
Avg.		Left blank



WIFI	UNII-4 5850~5895MHz Band Edge @ 3m	
ANT	802.11a CH177 5885MHz - L	
3+4	Vertical	Fundamental
Peak	<p>Site : 03CH13-HY Condition : PEAK_03(UNII4)_16-24 3m HORN_9120D_1326 VERTICAL : RBW:1000.000KHz VBW:3000.000KHz SWT:Auto</p>	<p>Site : 03CH13-HY Condition : PEAK(LINE) 3m HORN_9120D_1326 VERTICAL : RBW:1000.000KHz VBW:3000.000KHz SWT:Auto</p>
Avg	Left Blank	
		<p>Site : 03CH13-HY Condition : AVG_54 3m HORN_9120D_1326 VERTICAL : RBW:1000.000KHz VBW:1000KHz SWT:Auto</p>

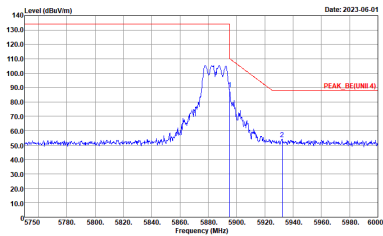
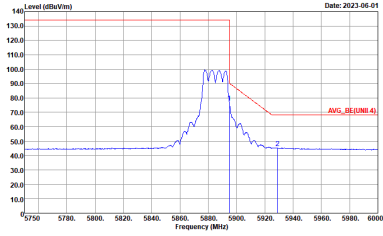

WIFI	UNII-4 5850~5895MHz Band Edge @ 3m	
ANT	802.11a CH177 5885MHz - R	
3+4	Vertical	Fundamental
<p>Peak</p>	 <p>Site : 03CH13-HY Condition : PEAK_BE(UNIT 4) 3m HORN_9120D_1326 VERTICAL : RBW:1000.000kHz VBW:3000.000kHz SWT:Auto</p>	<p>Left blank</p>
<p>Avg.</p>	 <p>Site : 03CH13-HY Condition : AVG_BE(UNIT 4) 3m HORN_9120D_1326 VERTICAL : RBW:1000.000kHz VBW:1.000kHz SWT:Auto</p>	<p>Left blank</p>

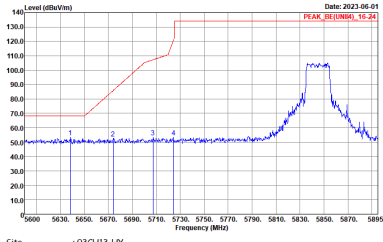
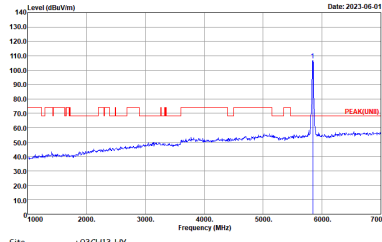
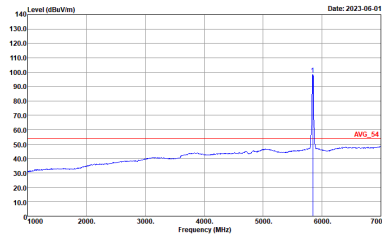

UNII-4 - 5850~5895MHz
WIFI 802.11be EHT20 Full RU (Band Edge @ 3m)

WIFI	UNII-4 5850~5895MHz Band Edge @ 3m	
ANT	802.11be EHT20 Full RU CH169 5845MHz - L	
3+4	Horizontal	Fundamental
Peak	 <p>Site : 03CH13-HY Condition : PEAK_BE(UNII4)_16-24 3m HORN_91200_1326 HORIZONTAL : RBW:1000.000KHz VSW:3000.000KHz SWT:Auto</p>	 <p>Site : 03CH13-HY Condition : PEAK(UNII) 3m HORN_91200_1326 HORIZONTAL : RBW:1000.000KHz VSW:3000.000KHz SWT:Auto</p>
Avg	Left Blank	 <p>Site : 03CH13-HY Condition : AVG_54 3m HORN_91200_1326 HORIZONTAL : RBW:1000.000KHz VSW:3000.000KHz SWT:Auto</p>

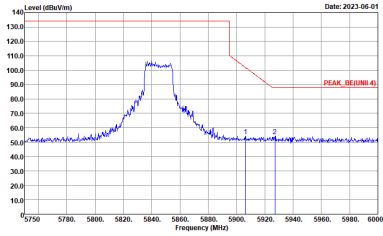
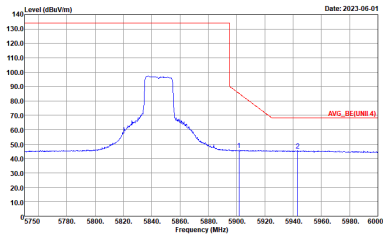

WIFI	UNII-4 5850~5895MHz Band Edge @ 3m	
ANT	802.11be EHT20 Full RU CH169 5845MHz - R	
3+4	Horizontal	Fundamental
<p>Peak</p>	 <p>Site : 03CH13-HY Condition : PEAK_BE(UNIT 4) 3m HORN_9120D_1326 HORIZONTAL : RBW:1000.000KHz VBW:3000.000KHz SWT:Auto</p>	<p>Left blank</p>
<p>Avg.</p>	 <p>Site : 03CH13-HY Condition : AVG_BE(UNIT 4) 3m HORN_9120D_1326 HORIZONTAL : RBW:1000.000KHz VBW:3.000KHz SWT:Auto</p>	<p>Left blank</p>



WIFI	UNII-4 5850~5895MHz Band Edge @ 3m	
ANT	802.11be EHT20 Full RU CH169 5845MHz - L	
3+4	Vertical	Fundamental
Peak	<p>Site : 03CH13-HY Condition : PEAK_BF(UNII4)_16-24 3m HORN_9120D_1326 VERTICAL : RBW:1000.000KHz VBW:3000.000KHz SWT:Auto</p>	<p>Site : 03CH13-HY Condition : PEAK(LINB) 3m HORN_9120D_1326 VERTICAL : RBW:1000.000KHz VBW:3000.000KHz SWT:Auto</p>
Avg	Left Blank	
		<p>Site : 03CH13-HY Condition : AVG_54 3m HORN_9120D_1326 VERTICAL : RBW:1000.000KHz VBW:3000.000KHz SWT:Auto</p>



WIFI	UNII-4 5850~5895MHz Band Edge @ 3m	
ANT	802.11be EHT20 Full RU CH169 5845MHz - R	
3+4	Vertical	Fundamental
Peak		Left blank
Avg.		Left blank

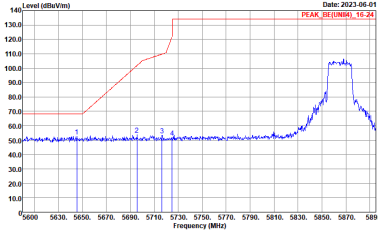
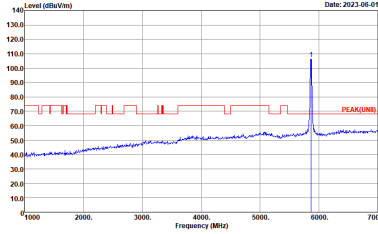
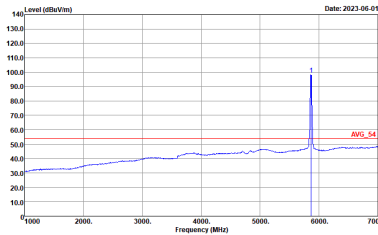

WIFI	UNII-4 5850~5895MHz Band Edge @ 3m	
ANT	802.11be EHT20 Full RU CH173 5865MHz - L	
3+4	Horizontal	Fundamental
Peak	 <p>Site : 03CH13-HY Condition : PEAK_SE(UNII4)_16-24 3m HORN_9120D_1326 HORIZONTAL : RBW:1000.000KHz VBW:3000.000KHz SWT:Auto</p>	 <p>Site : 03CH13-HY Condition : PEAK(LINE) 3m HORN_9120D_1326 HORIZONTAL : RBW:1000.000KHz VBW:3000.000KHz SWT:Auto</p>
Avg	Left Blank	
		 <p>Site : 03CH13-HY Condition : AV6_54 3m HORN_9120D_1326 HORIZONTAL : RBW:1000.000KHz VBW:3000.000KHz SWT:Auto</p>



WIFI	UNII-4 5850~5895MHz Band Edge @ 3m	
ANT	802.11be EHT20 Full RU CH173 5865MHz - R	
3+4	Horizontal	Fundamental
Peak	<p>Site : 03CH13-HY Condition : PEAK_BE(UNII 4) 3m HORN_9120D_1326 HORIZONTAL : RBW:1000.000kHz VBW:3000.000kHz SWT:Auto</p>	Left blank
Avg.	<p>Site : 03CH13-HY Condition : AVG_BE(UNII 4) 3m HORN_9120D_1326 HORIZONTAL : RBW:1000.000kHz VBW:3.000kHz SWT:Auto</p>	Left blank



WIFI	UNII-4 5850~5895MHz Band Edge @ 3m	
ANT	802.11be EHT20 Full RU CH173 5865MHz - L	
3+4	Vertical	Fundamental
Peak	<p>Site : 03CH13-HY Condition : PEAK_9E10899_16-24 3m HORN_9120D_1326 VERTICAL RBW:1000.000KHz VBW:3000.000KHz SWT:Auto</p>	<p>Site : 03CH13-HY Condition : PEAK(LINE) 3m HORN_9120D_1326 VERTICAL RBW:1000.000KHz VBW:3000.000KHz SWT:Auto</p>
Avg	Left Blank	<p>Site : 03CH13-HY Condition : AVG_54 3m HORN_9120D_1326 VERTICAL RBW:1000.000KHz VBW:3000.000KHz SWT:Auto</p>



WIFI	UNII-4 5850~5895MHz Band Edge @ 3m	
ANT	802.11be EHT20 Full RU CH173 5865MHz - R	
3+4	Vertical	Fundamental
<p>Peak</p>		<p>Left blank</p>
<p>Avg.</p>		<p>Left blank</p>

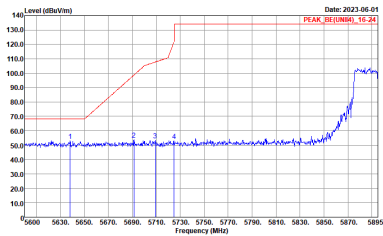
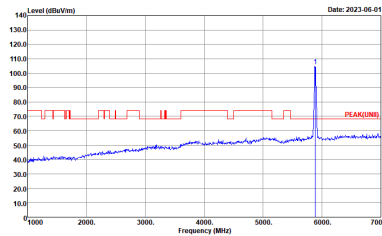
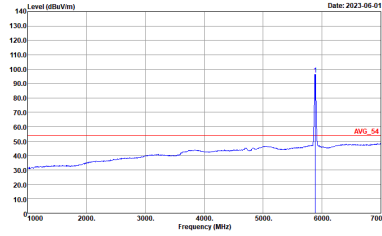

WIFI	UNII-4 5850~5895MHz Band Edge @ 3m	
ANT	802.11be EHT20 Full RU CH177 5885MHz - L	
3+4	Horizontal	Fundamental
Peak	 <p>Site : 03CH13-HY Condition : PEAK_8E(UNII4)_16-24 3m HORN_9120D_1326 HORIZONTAL : RBW:1000.000KHz VBW:3000.000KHz SWT:Auto</p>	 <p>Site : 03CH13-HY Condition : PEAK(LINE) 3m HORN_9120D_1326 HORIZONTAL : RBW:1000.000KHz VBW:3000.000KHz SWT:Auto</p>
Avg	Left Blank	 <p>Site : 03CH13-HY Condition : AV6_54 3m HORN_9120D_1326 HORIZONTAL : RBW:1000.000KHz VBW:3000.000KHz SWT:Auto</p>

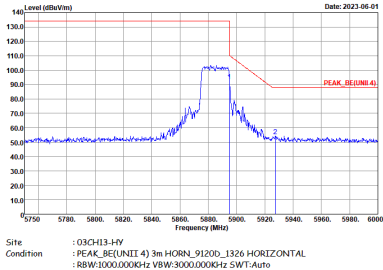
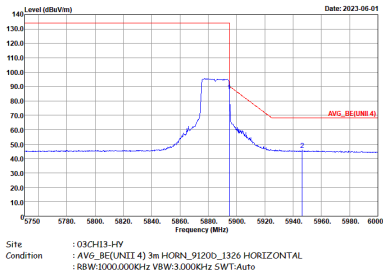

WIFI	UNII-4 5850~5895MHz Band Edge @ 3m	
ANT	802.11be EHT20 Full RU CH177 5885MHz - R	
3+4	Horizontal	Fundamental
Peak		Left blank
Avg.		Left blank



WIFI	UNII-4 5850~5895MHz Band Edge @ 3m	
ANT	802.11be EHT20 Full RU CH177 5885MHz - L	
3+4	Vertical	Fundamental
Peak	<p>Site : 03CH13-HY Condition : PEAK_03(UNII4)_16-24 3m HORN_9120D_1326 VERTICAL RBW:1000.000KHz VBW:3000.000KHz SWT:Auto</p>	<p>Site : 03CH13-HY Condition : PEAK(LINE) 3m HORN_9120D_1326 VERTICAL RBW:1000.000KHz VBW:3000.000KHz SWT:Auto</p>
Avg	Left Blank	
		<p>Site : 03CH13-HY Condition : AVG_54 3m HORN_9120D_1326 VERTICAL RBW:1000.000KHz VBW:3000.000KHz SWT:Auto</p>



WIFI	UNII-4 5850~5895MHz Band Edge @ 3m	
ANT	802.11be EHT20 Full RU CH177 5885MHz - R	
3+4	Vertical	Fundamental
<p>Peak</p>		<p>Left blank</p>
<p>Avg.</p>		<p>Left blank</p>



UNII-4 - 5850~5895MHz
WIFI 802.11be EHT40 Full RU (Band Edge @ 3m)

WIFI	UNII-4 5850~5895MHz Band Edge @ 3m	
ANT	802.11be EHT40 Full RU CH167 5835MHz - L	
3+4	Horizontal	Fundamental
Peak	<p>Site : 03CH13-HY Condition : PEAK_BE(UNII4)_16-24 3m HORN_9120D_1326 HORIZONTAL : RBW:1000.000KHz VSW:3000.000KHz SWT:Auto</p>	<p>Site : 03CH13-HY Condition : PEAK(UNII) 3m HORN_9120D_1326 HORIZONTAL : RBW:1000.000KHz VSW:3000.000KHz SWT:Auto</p>
Avg	Left Blank	<p>Site : 03CH13-HY Condition : AVG_54 3m HORN_9120D_1326 HORIZONTAL : RBW:1000.000KHz VSW:1.000KHz SWT:Auto</p>

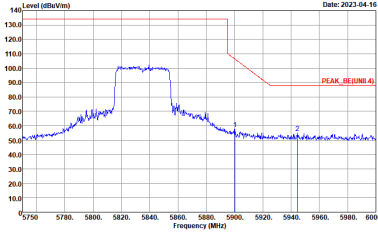
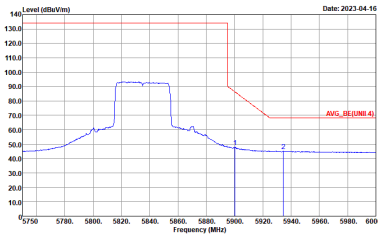

WIFI	UNII-4 5850~5895MHz Band Edge @ 3m	
ANT	802.11be EHT40 Full RU CH167 5835MHz - R	
3+4	Horizontal	Fundamental
<p>Peak</p>	 <p>Site : 03CH13-HY Condition : PEAK_BE(UNII 4) 3m HORN_9120D_1326 HORIZONTAL : RBW:1000.000KHz VBW:3000.000KHz SWT:Auto</p>	<p>Left blank</p>
<p>Avg.</p>	 <p>Site : 03CH13-HY Condition : AVG_BE(UNII 4) 3m HORN_9120D_1326 HORIZONTAL : RBW:1000.000KHz VBW:1.000KHz SWT:Auto</p>	<p>Left blank</p>

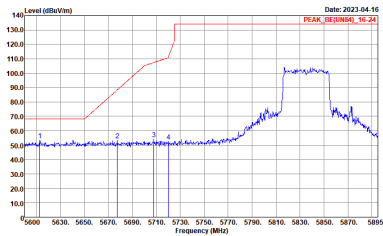
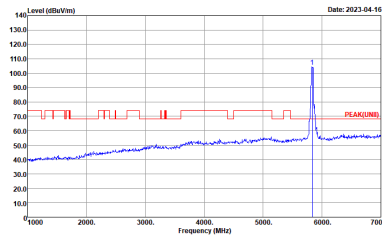
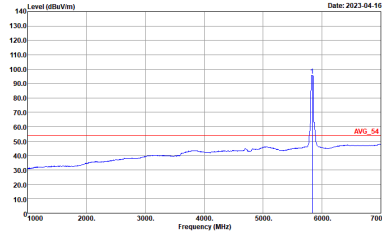

WIFI	UNII-4 5850~5895MHz Band Edge @ 3m	
ANT	802.11be EHT40 Full RU CH167 5835MHz - L	
3+4	Vertical	Fundamental
Peak	 <p>Site : 03CH13-HY Condition : PEAK_SE(UNII4)_16-24 3m HORN_9120D_1326 VERTICAL : RBW:1000.000KHz VBW:3000.000KHz SWT:Auto</p>	 <p>Site : 03CH13-HY Condition : PEAK(LINE) 3m HORN_9120D_1326 VERTICAL : RBW:1000.000KHz VBW:3000.000KHz SWT:Auto</p>
Avg	<p>Left Blank</p>  <p>Site : 03CH13-HY Condition : AV6_54 3m HORN_9120D_1326 VERTICAL : RBW:1000.000KHz VBW:1000KHz SWT:Auto</p>	

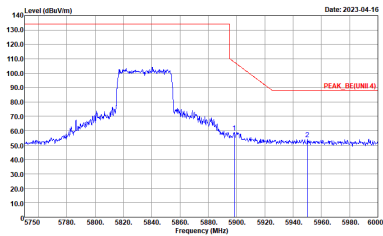
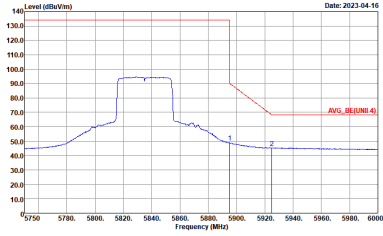

WIFI	UNII-4 5850~5895MHz Band Edge @ 3m	
ANT	802.11be EHT40 Full RU CH167 5835MHz - R	
3+4	Vertical	Fundamental
Peak	 <p>Site : 03CH13-HY Condition : PEAK_BE(UNIT 4) 3m HORN_9120D_1326 VERTICAL : RBW:1000.000kHz VBW:3000.000kHz SWT:Auto</p>	Left blank
Avg.	 <p>Site : 03CH13-HY Condition : AVG_BE(UNIT 4) 3m HORN_9120D_1326 VERTICAL : RBW:1000.000kHz VBW:11.000kHz SWT:Auto</p>	Left blank

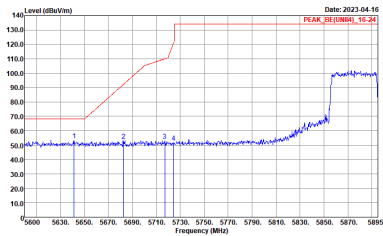
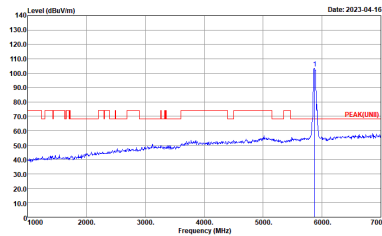
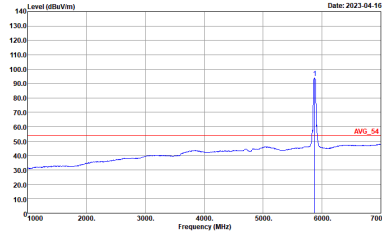

WIFI	UNII-4 5850~5895MHz Band Edge @ 3m	
ANT	802.11be EHT40 Full RU CH175 5875MHz - L	
3+4	Horizontal	Fundamental
Peak	 <p>Site : 03CH13-HY Condition : PEAK_SE[UNII4]_16-24 3m HORN_9120D_1326 HORIZONTAL : RBW:1000.000KHz VBW:3000.000KHz SWT:Auto</p>	 <p>Site : 03CH13-HY Condition : PEAK[LINE3] 3m HORN_9120D_1326 HORIZONTAL : RBW:1000.000KHz VBW:3000.000KHz SWT:Auto</p>
Avg	Left Blank	
		 <p>Site : 03CH13-HY Condition : AV6_54 3m HORN_9120D_1326 HORIZONTAL : RBW:1000.000KHz VBW:1000KHz SWT:Auto</p>

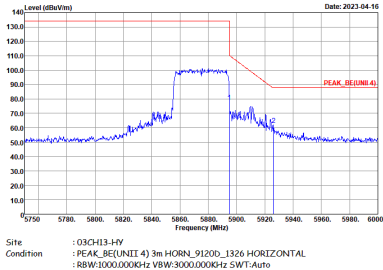
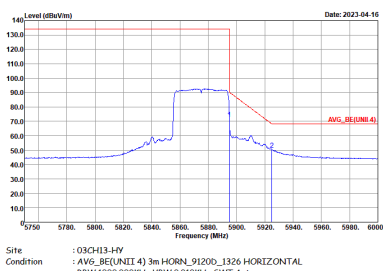

WIFI	UNII-4 5850~5895MHz Band Edge @ 3m	
ANT	802.11be EHT40 Full RU CH175 5875MHz - R	
3+4	Horizontal	Fundamental
Peak		Left blank
Avg.		Left blank

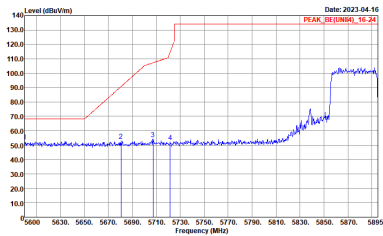
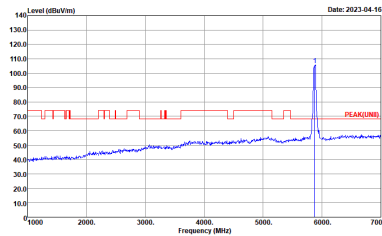
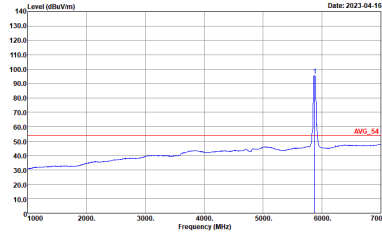

WIFI	UNII-4 5850~5895MHz Band Edge @ 3m	
ANT	802.11be EHT40 Full RU CH175 5875MHz - L	
3+4	Vertical	Fundamental
Peak	 <p>Site : 03CH13-HY Condition : PEAK_SE[UNII4]_16-24 3m HORN_9120D_1326 VERTICAL : RBW:1000.000KHz VBW:3000.000KHz SWT:Auto</p>	 <p>Site : 03CH13-HY Condition : PEAK[LINE3] 3m HORN_9120D_1326 VERTICAL : RBW:1000.000KHz VBW:3000.000KHz SWT:Auto</p>
Avg	Left Blank	
		 <p>Site : 03CH13-HY Condition : AV6_54 3m HORN_9120D_1326 VERTICAL : RBW:1000.000KHz VBW:1000KHz SWT:Auto</p>

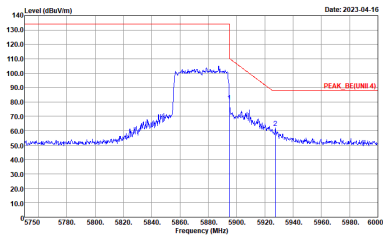
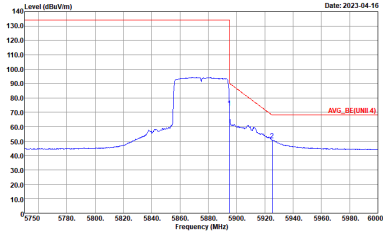

WIFI	UNII-4 5850~5895MHz Band Edge @ 3m	
ANT	802.11be EHT40 Full RU CH175 5875MHz - R	
3+4	Vertical	Fundamental
<p style="text-align: center;">Peak</p>	 <p>Site : 03CH13-HY Condition : PEAK_BE(UNIT 4) 3m HORN_9120D_1326 VERTICAL : RBW:1000.000kHz VBW:3000.000kHz SWT:Auto</p>	<p style="text-align: center;">Left blank</p>
<p style="text-align: center;">Avg.</p>	 <p>Site : 03CH13-HY Condition : AVG_BE(UNIT 4) 3m HORN_9120D_1326 VERTICAL : RBW:1000.000kHz VBW:0.010kHz SWT:Auto</p>	<p style="text-align: center;">Left blank</p>

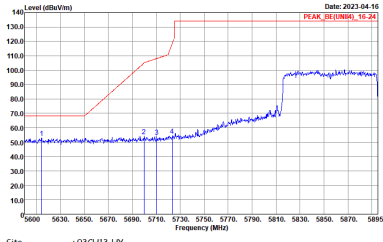
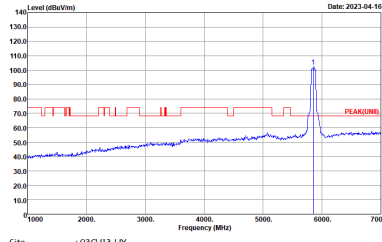
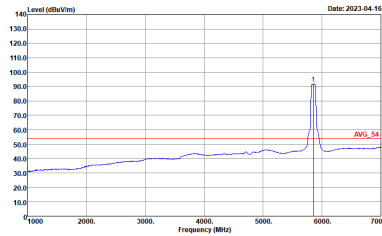

UNII-4 -5850~5895MHz
WIFI 802.11be EHT80 Full RU (Band Edge @ 3m)

WIFI	UNII-4 5850~5895MHz Band Edge @ 3m	
ANT	802.11be EHT80 Full RU CH171 5855MHz - L	
3+4	Horizontal	Fundamental
Peak	 <p>Site : 03CH13-HY Condition : PEAK_BE(UNII4)_16-24 3m HORN_91200_1326 HORIZONTAL : RBW:1000.000KHz VSW:3000.000KHz SWT:Auto</p>	 <p>Site : 03CH13-HY Condition : PEAK(UNII) 3m HORN_91200_1326 HORIZONTAL : RBW:1000.000KHz VSW:3000.000KHz SWT:Auto</p>
Avg	Left Blank	 <p>Site : 03CH13-HY Condition : AVG_54 3m HORN_91200_1326 HORIZONTAL : RBW:1000.000KHz VSW:1.000KHz SWT:Auto</p>



WIFI	UNII-4 5850~5895MHz Band Edge @ 3m	
ANT	802.11be EHT80 Full RU CH171 5855MHz - R	
3+4	Horizontal	Fundamental
Peak	<p>Site : 03CH13-HY Condition : PEAK_BE(UNII 4) 3m HORN_9120D_1326 HORIZONTAL : RBW:1000.000KHz VBW:3000.000KHz SWT:Auto</p>	Left blank
Avg.	<p>Site : 03CH13-HY Condition : AVG_BE(UNII 4) 3m HORN_9120D_1326 HORIZONTAL : RBW:1000.000KHz VBW:1.000KHz SWT:Auto</p>	Left blank



WIFI	UNII-4 5850~5895MHz Band Edge @ 3m	
ANT	802.11be EHT80 Full RU CH171 5855MHz - L	
3+4	Vertical	Fundamental
Peak	<p>Site : 03CH13-HY Condition : PEAK_SE[UNII4]_16-24 3m HORN_9120D_1326 VERTICAL : RBW:1000.000KHz VBW:3000.000KHz SWT:Auto</p>	<p>Site : 03CH13-HY Condition : PEAK[LINE3] 3m HORN_9120D_1326 VERTICAL : RBW:1000.000KHz VBW:3000.000KHz SWT:Auto</p>
Avg	Left Blank	
		<p>Site : 03CH13-HY Condition : AV6_54 3m HORN_9120D_1326 VERTICAL : RBW:1000.000KHz VBW:1000KHz SWT:Auto</p>



WIFI	UNII-4 5850~5895MHz Band Edge @ 3m	
ANT	802.11be EHT80 Full RU CH171 5855MHz - R	
3+4	Vertical	Fundamental
Peak	<p>Site : 03CH13-HY Condition : PEAK_BE(UNII 4) 3m HORN_9120D_1326 VERTICAL : RBW:1000.000KHz VBW:3000.000KHz SWT:Auto</p>	Left blank
Avg.	<p>Site : 03CH13-HY Condition : AVG_BE(UNII 4) 3m HORN_9120D_1326 VERTICAL : RBW:1000.000KHz VBW:1.000KHz SWT:Auto</p>	Left blank



UNII-4 - 5850~5895MHz
WIFI 802.11be EHT160 Full RU (Band Edge @ 3m)

WIFI	UNII-4 5850~5895MHz Band Edge @ 3m	
ANT	802.11be EHT160 Full RU CH163 5815MHz - L	
3+4	Horizontal	Fundamental
Peak	<p>Site : 03CH13-HY Condition : PEAK_BE(UNII4)_16-24 3m HORN_9120D_1326 HORIZONTAL : RBW:1000.000KHz VSW:3000.000KHz SWT:Auto</p>	<p>Site : 03CH13-HY Condition : PEAK(UNII) 3m HORN_9120D_1326 HORIZONTAL : RBW:1000.000KHz VSW:3000.000KHz SWT:Auto</p>
Avg	Left Blank	<p>Site : 03CH13-HY Condition : AVG_54 3m HORN_9120D_1326 HORIZONTAL : RBW:1000.000KHz VSW:3000.000KHz SWT:Auto</p>

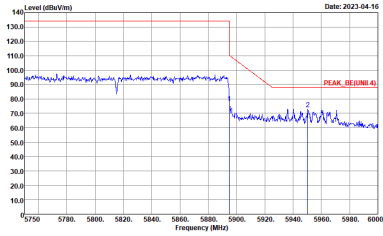
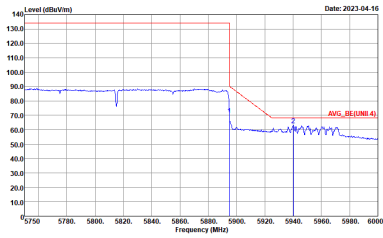

WIFI	UNII-4 5850~5895MHz Band Edge @ 3m	
ANT	802.11be EHT160 Full RU CH163 5815MHz - R	
3+4	Horizontal	Fundamental
Peak	 <p>Site : 03CH13-HY Condition : PEAK_BE(UNII-4) 3m HORN_9120D_1326 HORIZONTAL : RBW:1000.000kHz VBW:3000.000kHz SWT:Auto</p>	Left blank
Avg.	 <p>Site : 03CH13-HY Condition : AVG_BE(UNII-4) 3m HORN_9120D_1326 HORIZONTAL : RBW:1000.000kHz VBW:3.000kHz SWT:Auto</p>	Left blank

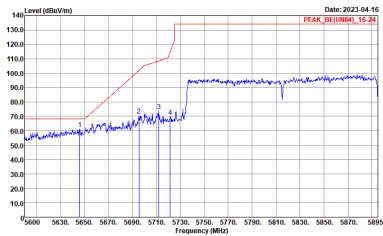
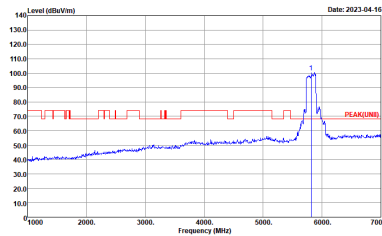
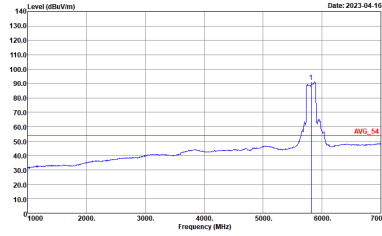

WIFI	UNII-4 5850~5895MHz Band Edge @ 3m	
ANT	802.11be EHT160 Full RU CH163 5815MHz - L	
3+4	Vertical	Fundamental
Peak	 <p>Site : 03CH13-HY Condition : PEAK_SE[UNITE]_16-24 3m HORN_9120D_1326 VERTICAL : RBW:1000.000KHz VBW:3000.000KHz SWT:Auto</p>	 <p>Site : 03CH13-HY Condition : PEAK[LINE] 3m HORN_9120D_1326 VERTICAL : RBW:1000.000KHz VBW:3000.000KHz SWT:Auto</p>
Avg	Left Blank	
		 <p>Site : 03CH13-HY Condition : AV6_54 3m HORN_9120D_1326 VERTICAL : RBW:1000.000KHz VBW:3000.000KHz SWT:Auto</p>

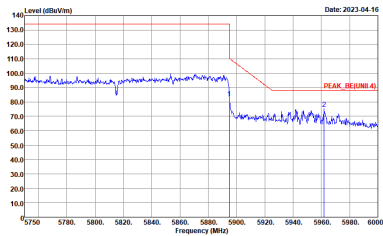
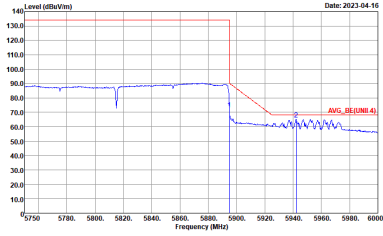

WIFI	UNII-4 5850~5895MHz Band Edge @ 3m	
ANT	802.11be EHT160 Full RU CH163 5815MHz - R	
3+4	Vertical	Fundamental
<p>Peak</p>	 <p>Site : 03CH13-HY Condition : PEAK_BE(UNIT 4) 3m HORN_9120D_1326 VERTICAL : RBW:1000.000kHz VBW:3000.000kHz SWT:Auto</p>	<p>Left blank</p>
<p>Avg.</p>	 <p>Site : 03CH13-HY Condition : AVG_BE(UNIT 4) 3m HORN_9120D_1326 VERTICAL : RBW:1000.000kHz VBW:3.000kHz SWT:Auto</p>	<p>Left blank</p>



UNII-4 - 5850~5895MHz
WIFI 802.11a (Harmonic @ 3m)

WIFI	UNII-4 5850~5895MHz Harmonic @ 3m	
ANT	802.11a CH169 5845MHz	
3+4	Horizontal	Vertical
Peak Avg.	<p>Site : 03CH13-HY Condition : :PEAK[UNII] 3m HORN_9120D_1326 HORIZONTAL</p>	<p>Site : 03CH13-HY Condition : :PEAK[UNII] 3m HORN_9120D_1326 VERTICAL</p>

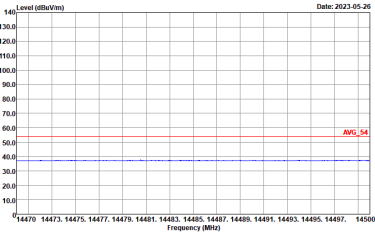
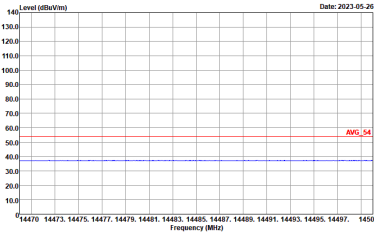
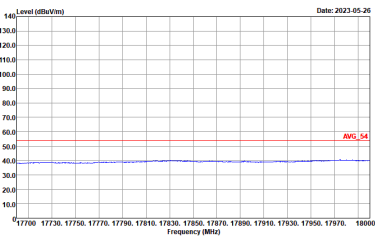
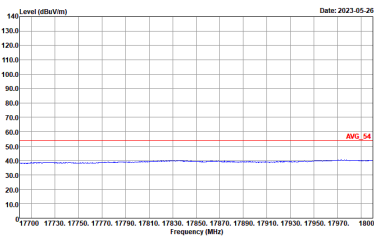

WIFI	UNII-4 5850~5895MHz Harmonic @ 3m	
ANT	802.11a CH169 5845MHz	
3+4	Horizontal	Vertical
<p>14.47G ~14.5G Avg.</p>	 <p>Date: 2023-05-26</p> <p>Site : 03CH13-HY Condition : AV6_54 3m HORN_91200_1326 HORIZONTAL</p>	 <p>Date: 2023-05-26</p> <p>Site : 03CH13-HY Condition : AV6_54 3m HORN_91200_1326 VERTICAL</p>
<p>17.7G ~18G Avg</p>	 <p>Date: 2023-05-26</p> <p>Site : 03CH13-HY Condition : AV6_54 3m HORN_91200_1326 HORIZONTAL</p>	 <p>Date: 2023-05-26</p> <p>Site : 03CH13-HY Condition : AV6_54 3m HORN_91200_1326 VERTICAL</p>

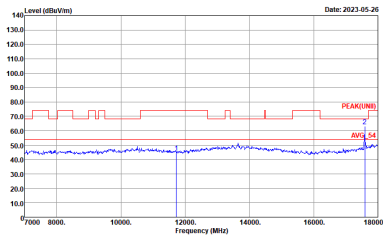
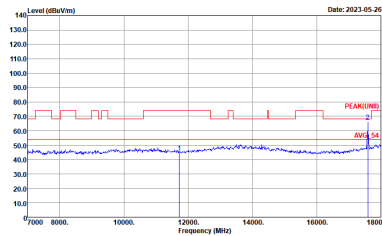

WIFI	UNII-4 5850~5895MHz Harmonic @ 3m	
ANT	802.11a CH173 5865MHz	
3+4	Horizontal	Vertical
Peak Avg.	 <p>Site : 03CH13-HY Condition : PEAK(UNII) 3m HORN_91200_1326 HORIZONTAL</p>	 <p>Site : 03CH13-HY Condition : PEAK(UNII) 3m HORN_91200_1326 VERTICAL</p>

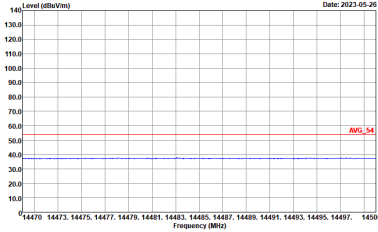
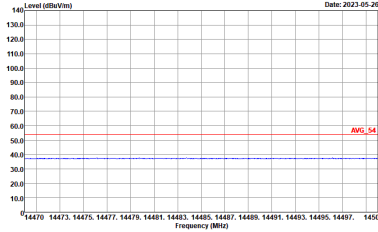
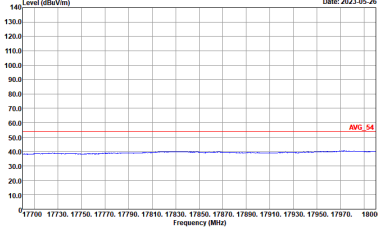
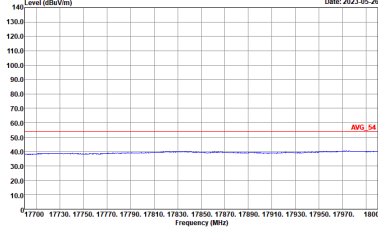

WIFI	UNII-4 5850~5895MHz Harmonic @ 3m	
ANT	802.11a CH173 5865MHz	
3+4	Horizontal	Vertical
<p>14.47G ~14.5G Avg.</p>	 <p>Date: 2023-05-26</p> <p>Site : 03CH13-HY Condition : AV6_54 3m HORN_91200_1326 HORIZONTAL</p>	 <p>Date: 2023-05-26</p> <p>Site : 03CH13-HY Condition : AV6_54 3m HORN_91200_1326 VERTICAL</p>
<p>17.7G ~18G Avg</p>	 <p>Date: 2023-05-26</p> <p>Site : 03CH13-HY Condition : AV6_54 3m HORN_91200_1326 HORIZONTAL</p>	 <p>Date: 2023-05-26</p> <p>Site : 03CH13-HY Condition : AV6_54 3m HORN_91200_1326 VERTICAL</p>

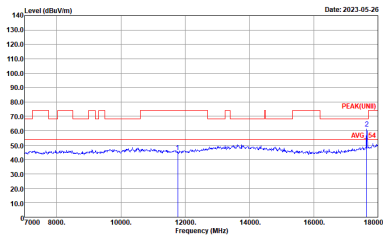
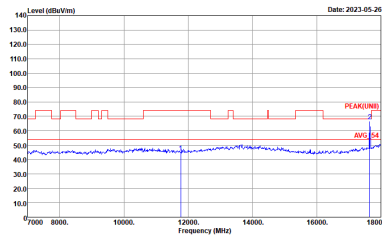

WIFI	UNII-4 5850~5895MHz Harmonic @ 3m	
ANT	802.11a CH177 5885MHz	
3+4	Horizontal	Vertical
Peak Avg.	 <p>Site : 03CH13-HY Condition : PEAK(UNII) 3m HORN_91200_1326 HORIZONTAL :</p>	 <p>Site : 03CH13-HY Condition : PEAK(UNII) 3m HORN_91200_1326 VERTICAL :</p>



WIFI	UNII-4 5850~5895MHz Harmonic @ 3m	
ANT	802.11a CH177 5885MHz	
3+4	Horizontal	Vertical
<p>14.47G ~14.5G Avg.</p>	<p>Date: 2023-05-26</p> <p>Site : 03CH13-HY Condition : AV6_54 3m HORN_9120D_1326 HORIZONTAL</p>	<p>Date: 2023-05-26</p> <p>Site : 03CH13-HY Condition : AV6_54 3m HORN_9120D_1326 VERTICAL</p>
<p>17.7G ~18G Avg</p>	<p>Date: 2023-05-26</p> <p>Site : 03CH13-HY Condition : AV6_54 3m HORN_9120D_1326 HORIZONTAL</p>	<p>Date: 2023-05-26</p> <p>Site : 03CH13-HY Condition : AV6_54 3m HORN_9120D_1326 VERTICAL</p>



UNII-4 - 5850~5895MHz
WIFI 802.11be EHT20 Full RU (Harmonic @ 3m)

Table with 3 rows and 2 columns. Row 1: WIFI UNII-4 5850~5895MHz Harmonic @ 3m. Row 2: ANT 802.11be EHT20 Full RU CH169 5845MHz. Row 3: 3+4 Horizontal and Vertical. The main content area contains two graphs: 'Horizontal' and 'Vertical'. Each graph plots Level (dBm/Vm) vs Frequency (MHz) from 7000 to 18000. Both graphs show a red 'PEAK(UNII)' line and a blue 'AVG_54' line. The horizontal graph has a site condition of 'PEAK(UNII) 3m HORN_9120D_1326 HORIZONTAL' and the vertical graph has 'PEAK(UNII) 3m HORN_9120D_1326 VERTICAL'.

Peak
Avg.



WIFI	UNII-4 5850~5895MHz Harmonic @ 3m	
ANT	802.11be EHT20 Full RU CH169 5845MHz	
3+4	Horizontal	Vertical
<p>14.47G ~14.5G Avg.</p>	<p>Date: 2023-05-26</p> <p>Site : 03CH13-HY Condition : AV6_54 3m HORN_9120D_1326 HORIZONTAL</p>	<p>Date: 2023-05-26</p> <p>Site : 03CH13-HY Condition : AV6_54 3m HORN_9120D_1326 VERTICAL</p>
<p>17.7G ~18G Avg</p>	<p>Date: 2023-05-26</p> <p>Site : 03CH13-HY Condition : AV6_54 3m HORN_9120D_1326 HORIZONTAL</p>	<p>Date: 2023-05-26</p> <p>Site : 03CH13-HY Condition : AV6_54 3m HORN_9120D_1326 VERTICAL</p>



WIFI	UNII-4 5850~5895MHz Harmonic @ 3m	
ANT	802.11be EHT20 Full RU CH173 5865MHz	
3+4	Horizontal	Vertical
Peak Avg.	<p>Site : 03CH13-HY Condition : PEAK(UNII) 3m HORN_9120D_1326 HORIZONTAL</p>	<p>Site : 03CH13-HY Condition : PEAK(UNII) 3m HORN_9120D_1326 VERTICAL</p>

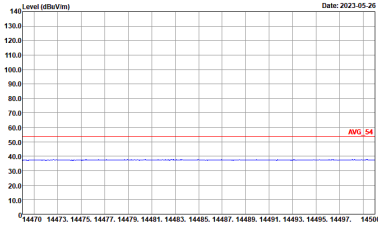
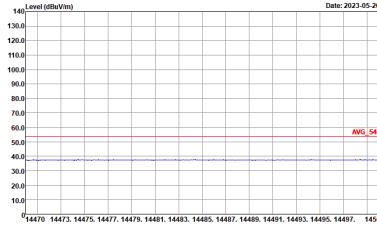
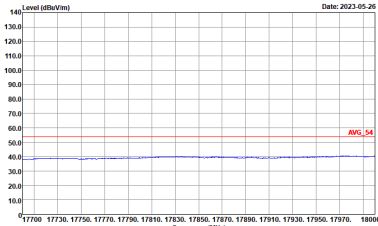
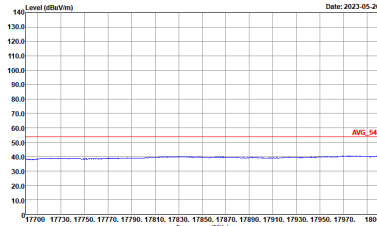

WIFI	UNII-4 5850~5895MHz Harmonic @ 3m	
ANT	802.11be EHT20 Full RU CH173 5865MHz	
3+4	Horizontal	Vertical
<p>14.47G ~14.5G Avg.</p>	 <p>Site : 03CH13-HY Condition : AV6_54 3m HORN_91200_1326 HORIZONTAL</p>	 <p>Site : 03CH13-HY Condition : AV6_54 3m HORN_91200_1326 VERTICAL</p>
<p>17.7G ~18G Avg</p>	 <p>Site : 03CH13-HY Condition : AV6_54 3m HORN_91200_1326 HORIZONTAL</p>	 <p>Site : 03CH13-HY Condition : AV6_54 3m HORN_91200_1326 VERTICAL</p>

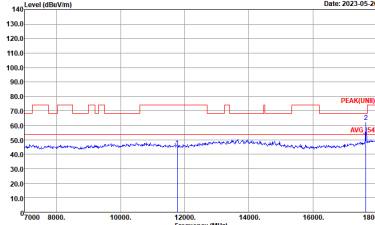
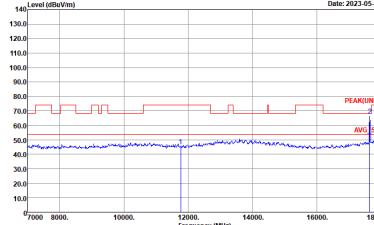

WIFI	UNII-4 5850~5895MHz Harmonic @ 3m	
ANT	802.11be EHT20 Full RU CH177 5885MHz	
3+4	Horizontal	Vertical
Peak Avg.	 <p>Site : 03CH13-HY Condition : PEAK(UNII) 3m HORN_9120D_1326 HORIZONTAL</p>	 <p>Site : 03CH13-HY Condition : PEAK(UNII) 3m HORN_9120D_1326 VERTICAL</p>

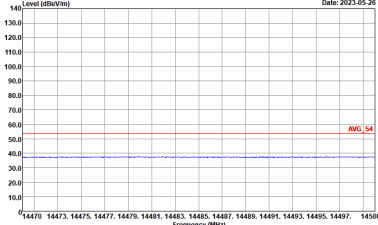
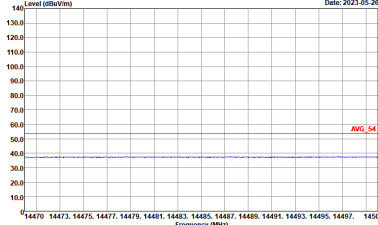
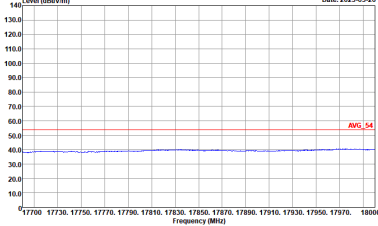
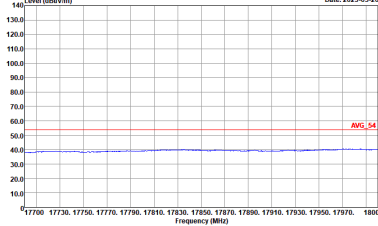

WIFI	UNII-4 5850~5895MHz Harmonic @ 3m	
ANT	802.11be EHT20 Full RU CH177 5885MHz	
3+4	Horizontal	Vertical
<p>14.47G ~14.5G Avg.</p>	 <p>Site : 03CH13-HY Condition : AV6_54 3m HORN_91200_1326 HORIZONTAL</p>	 <p>Site : 03CH13-HY Condition : AV6_54 3m HORN_91200_1326 VERTICAL</p>
<p>17.7G ~18G Avg</p>	 <p>Site : 03CH13-HY Condition : AV6_54 3m HORN_91200_1326 HORIZONTAL</p>	 <p>Site : 03CH13-HY Condition : AV6_54 3m HORN_91200_1326 VERTICAL</p>



UNII-4 - 5850~5895MHz
WIFI 802.11be EHT40 Full RU (Harmonic @ 3m)

WIFI	UNII-4 5850~5895MHz Harmonic @ 3m	
ANT	802.11be EHT40 Full RU CH167 5835MHz	
3+4	Horizontal	Vertical
Peak Avg.	<p>Site : 03CH18-14Y Condition : -PEAK(LINE) 3m HORN_9120D_1326 HORIZONTAL</p>	<p>Site : 03CH18-14Y Condition : -PEAK(LINE) 3m HORN_9120D_1326 VERTICAL</p>



WIFI	UNII-4 5850~5895MHz Harmonic @ 3m	
ANT	802.11be EHT40 Full RU CH167 5835MHz	
3+4	Horizontal	Vertical
<p>14.47G ~14.5G Avg.</p>	<p>Site : 03CH13-HY Condition : AV6_54 3m HORN_9120D_1326 HORIZONTAL</p>	<p>Site : 03CH13-HY Condition : AV6_54 3m HORN_9120D_1326 VERTICAL</p>
<p>17.7G ~18G Avg</p>	<p>Site : 03CH13-HY Condition : AV6_54 3m HORN_9120D_1326 HORIZONTAL</p>	<p>Site : 03CH13-HY Condition : AV6_54 3m HORN_9120D_1326 VERTICAL</p>



WIFI	UNII-4 5850~5895MHz Harmonic @ 3m	
ANT	802.11be EHT40 Full RU CH175 5875MHz	
3+4	Horizontal	Vertical
Peak Avg.	<p>Site : 03CH13-HY Condition : PEAK(UNII) 3m HORN_9120D_1326 HORIZONTAL</p>	<p>Site : 03CH13-HY Condition : PEAK(UNII) 3m HORN_9120D_1326 VERTICAL</p>



WIFI	UNII-4 5850~5895MHz Harmonic @ 3m	
ANT	802.11be EHT40 Full RU CH175 5875MHz	
3+4	Horizontal	Vertical
<p>14.47G ~14.5G Avg.</p>	<p>Date: 2023-04-13</p> <p>Site : 03CH13-HY Condition : AV6_54 3m HORN_91200_1326 HORIZONTAL</p>	<p>Date: 2023-04-13</p> <p>Site : 03CH13-HY Condition : AV6_54 3m HORN_91200_1326 VERTICAL</p>
<p>17.7G ~18G Avg</p>	<p>Date: 2023-04-13</p> <p>Site : 03CH13-HY Condition : AV6_54 3m HORN_91200_1326 HORIZONTAL</p>	<p>Date: 2023-04-13</p> <p>Site : 03CH13-HY Condition : AV6_54 3m HORN_91200_1326 VERTICAL</p>



UNII-4 - 5850~5895MHz
WIFI 802.11be EHT80 Full RU (Harmonic @ 3m)

WIFI	UNII-4 5850~5895MHz Harmonic @ 3m	
ANT	802.11be EHT80 Full RU CH171 5855MHz	
3+4	Horizontal	Vertical
Peak Avg.	<p>Site : 03CH18-14Y Condition : -PEAK(LINE) 3m HORN_9120D_1326 HORIZONTAL</p>	<p>Site : 03CH18-14Y Condition : -PEAK(LINE) 3m HORN_9120D_1326 VERTICAL</p>



WIFI	UNII-4 5850~5895MHz Harmonic @ 3m	
ANT	802.11be EHT80 Full RU CH171 5855MHz	
3+4	Horizontal	Vertical
<p>14.47G ~14.5G Avg.</p>	<p>Site : 03CH13-HY Condition : AV6_54 3m HORN_91200_1326 HORIZONTAL</p>	<p>Site : 03CH13-HY Condition : AV6_54 3m HORN_91200_1326 VERTICAL</p>
<p>17.7G ~18G Avg</p>	<p>Site : 03CH13-HY Condition : AV6_54 3m HORN_91200_1326 HORIZONTAL</p>	<p>Site : 03CH13-HY Condition : AV6_54 3m HORN_91200_1326 VERTICAL</p>



UNII-4 - 5850~5895MHz
WIFI 802.11be EHT160 Full RU (Harmonic @ 3m)

WIFI	UNII-4 5850~5895MHz Harmonic @ 3m	
ANT	802.11be EHT160 Full RU CH163 5815MHz	
3+4	Horizontal	Vertical
Peak Avg.	<p>Site : 03CH18-14Y Condition : -PEAK(UNII) 3m HORN_9120D_1326 HORIZONTAL</p>	<p>Site : 03CH18-14Y Condition : -PEAK(UNII) 3m HORN_9120D_1326 VERTICAL</p>

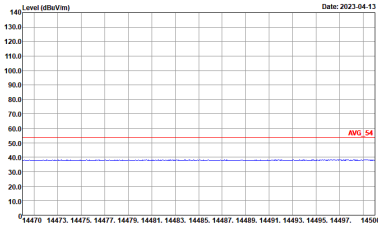
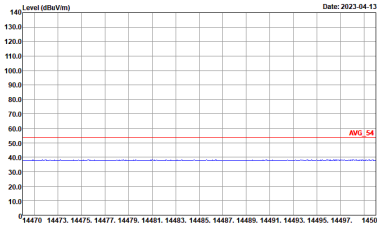
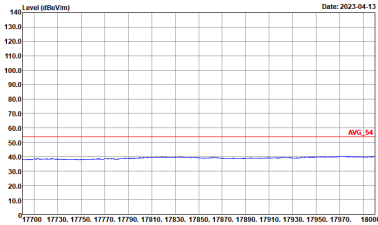
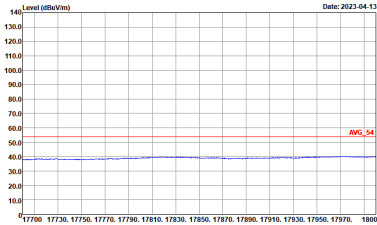

WIFI	UNII-4 5850~5895MHz Harmonic @ 3m	
ANT	802.11be EHT160 Full RU CH163 5815MHz	
3+4	Horizontal	Vertical
<p>14.47G ~14.5G Avg.</p>	 <p>Site : 03CH13-HY Condition : AV6_54 3m HORN_91200_1326 HORIZONTAL</p>	 <p>Site : 03CH13-HY Condition : AV6_54 3m HORN_91200_1326 VERTICAL</p>
<p>17.7G ~18G Avg</p>	 <p>Site : 03CH13-HY Condition : AV6_54 3m HORN_91200_1326 HORIZONTAL</p>	 <p>Site : 03CH13-HY Condition : AV6_54 3m HORN_91200_1326 VERTICAL</p>



Emission above 18GHz
5GHz WIFI 802. 11a Full (SHF @ 1m)

WIFI	5GHz WIFI	
ANT	802. 11a EHT20 Full SHF	
3+4	Horizontal	Vertical
Peak Avg.	<p>Site : 03CH13-HY Condition : PEAK(UNIT) 1m SHF_00993_221124 HORIZONTAL Detector : Peak</p>	<p>Site : 03CH13-HY Condition : PEAK(UNIT) 1m SHF_00993_221124 VERTICAL Detector : Peak</p>



Emission below 1GHz
5GHz WIFI 802.11a Full (LF @ 3m)

WIFI	5GHz WIFI	
ANT	802.11a Full LF	
3+4	Horizontal	Vertical
QP / Peak	<p>Site : 03CH13-HY Condition : QP 3m BIL06_55606 VERTICAL</p>	<p>Site : 03CH13-HY Condition : QP 3m BIL06_55606 HORIZONTAL</p>



Appendix E. Duty Cycle Plots

<For Radiated Spurious Emission test>

Antenna	Band	Duty Cycle(%)	T(us)	1/T(kHz)	VBW Setting
3+4	5GHz 802.11a	93.44	1425	0.70	1kHz
3+4	5GHz 802.11be EHT20 Full RU	84.96	565	1.77	3kHz
3+4	5GHz 802.11be EHT40 Full RU	96.02	2410	0.41	1kHz
3+4	5GHz 802.11be EHT80 Full RU	92.22	1185	0.84	1kHz
3+4	5GHz 802.11be EHT160 Full RU	86.34	632	1.58	3kHz

MIMO <Ant. 3+4>

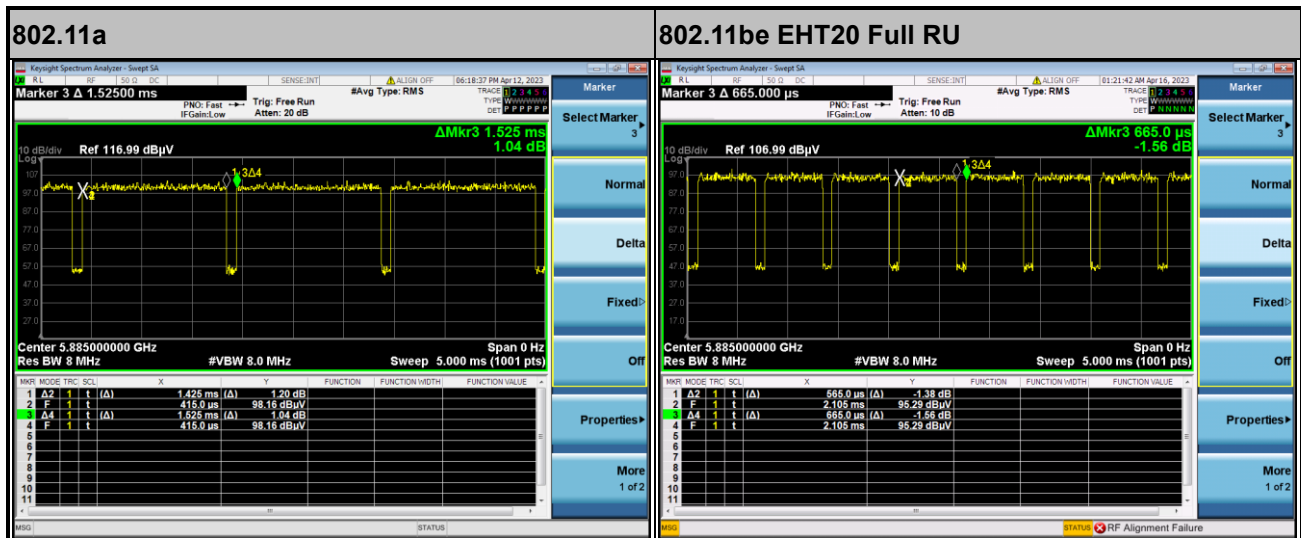



802.11be EHT40 Full RU

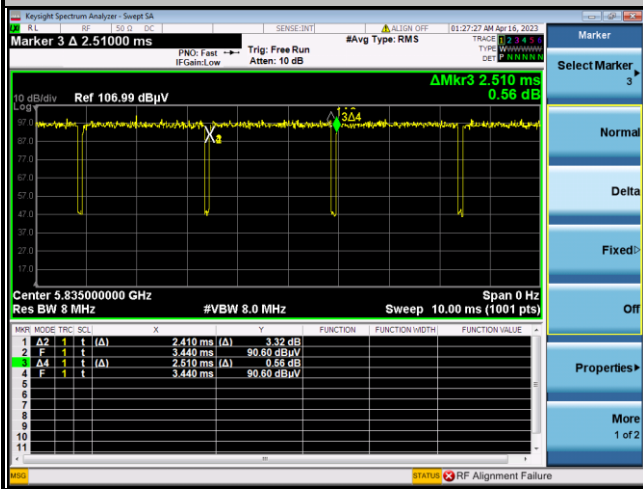

802.11be EHT80 Full RU

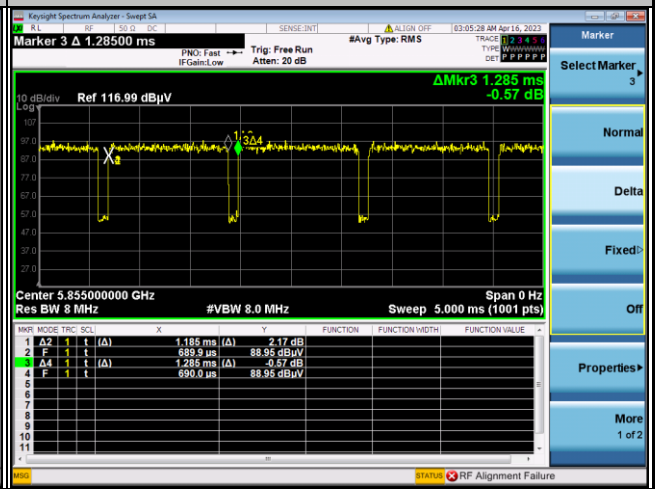

802.11be EHT160 Full RU

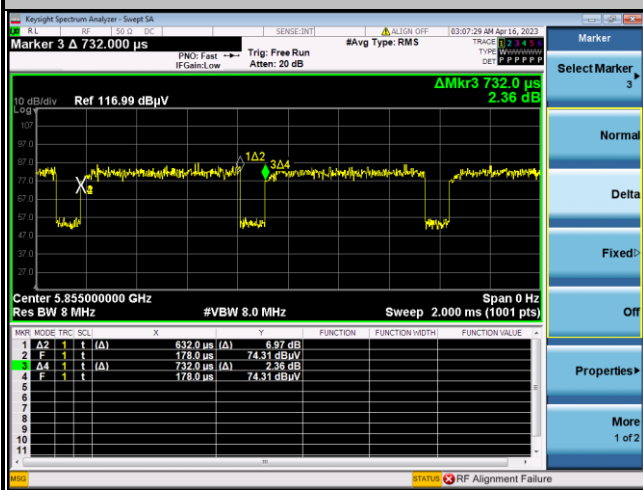

**<For Conducted test>**

Antenna	Band	Duty Cycle(%)	T(us)	Duty Factor(dB)
3+4	5GHz 802.11a for Ant. 3	93.44	1424	0.29
3+4	5GHz 802.11a for Ant. 4	93.33	1428	0.30
3+4	5GHz 802.11be EHT20 Full RU for Ant 3	96.02	2410	0.18
3+4	5GHz 802.11be EHT20 Full RU for Ant 4	96.03	2420	0.18
3+4	5GHz 802.11be EHT20 26 RU for Ant 3	89.08	848	0.50
3+4	5GHz 802.11be EHT20 26 RU for Ant 4	89.50	852	0.48
3+4	5GHz 802.11be EHT20 52 RU for Ant 3	88.58	776	0.24
3+4	5GHz 802.11be EHT20 52 RU for Ant 4	88.58	776	0.26
3+4	5GHz 802.11be EHT20 106 RU for Ant 3	87.50	693	0.58
3+4	5GHz 802.11be EHT20 106 RU for Ant 4	87.45	690	0.58
3+4	5GHz 802.11be EHT20 52+26 RU for Ant 3	94.55	1768	0.24
3+4	5GHz 802.11be EHT20 52+26 RU for Ant 4	94.24	1766	0.26
3+4	5GHz 802.11be EHT20 106+26 RU for Ant 3	91.23	1040	0.40
3+4	5GHz 802.11be EHT20 106+26 RU for Ant 4	91.23	1040	0.40
3+4	5GHz 802.11be EHT40 Full RU for Ant 3	91.04	1220	0.41
3+4	5GHz 802.11be EHT40 Full RU for Ant 4	91.08	1225	0.41
3+4	5GHz 802.11be EHT80 Full RU for Ant 3	86.48	633	0.63
3+4	5GHz 802.11be EHT80 Full RU for Ant 4	86.53	636	0.63
3+4	5GHz 802.11be EHT80 Puncture20 for Ant 3	93.10	1322	0.31
3+4	5GHz 802.11be EHT80 Puncture20 for Ant 4	92.71	1322	0.33
3+4	5GHz 802.11be EHT160 Full RU for Ant 3	85.33	576	0.69
3+4	5GHz 802.11be EHT160 Full RU for Ant 4	85.33	576	0.69
3+4	5GHz 802.11be EHT160 Puncture20 for Ant 3	87.64	723	0.57
3+4	5GHz 802.11be EHT160 Puncture20 for Ant 4	87.96	723	0.56
3+4	5GHz 802.11be EHT160 Puncture40 for Ant 3	89.27	832	0.49
3+4	5GHz 802.11be EHT160 Puncture40 for Ant 4	89.27	832	0.49



MIMO <Ant. 3>

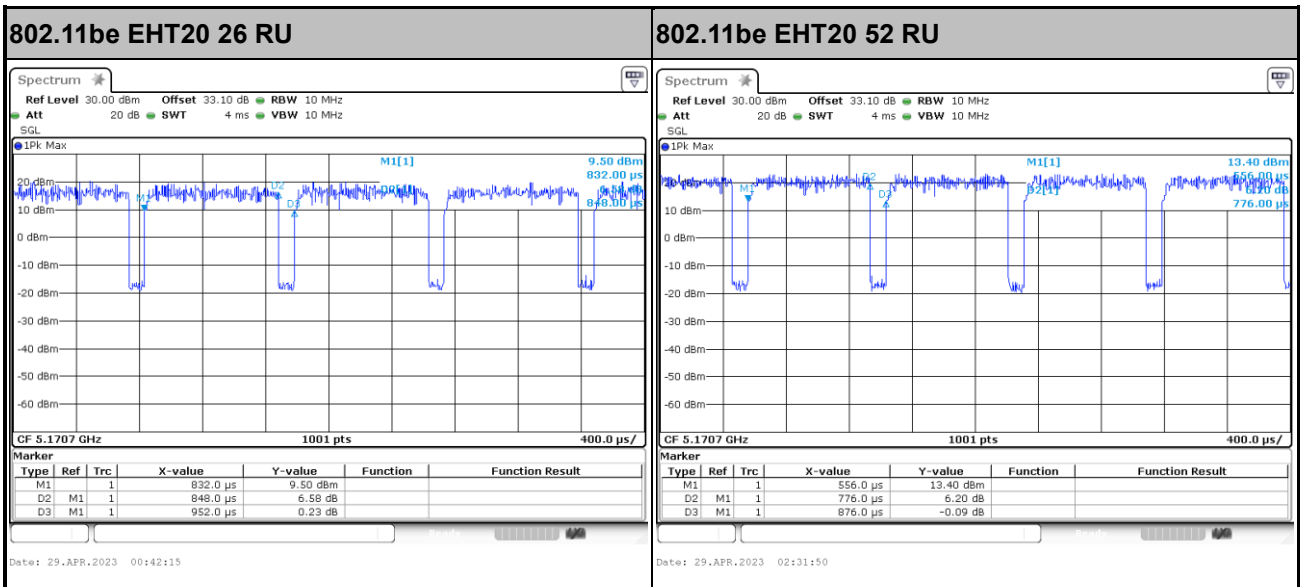
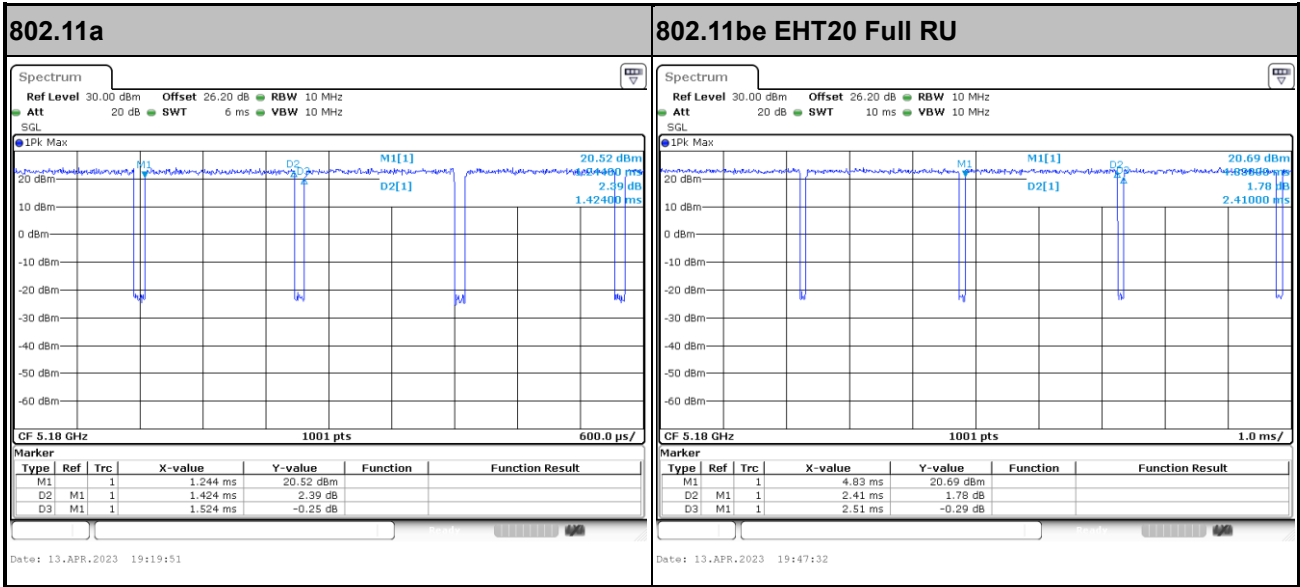

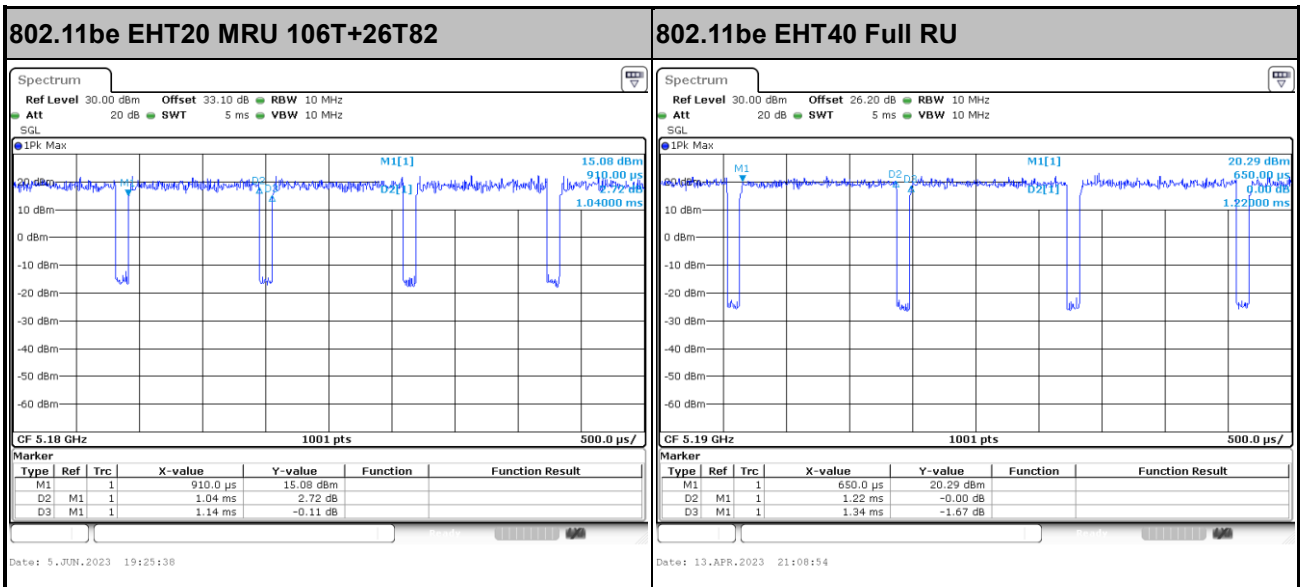
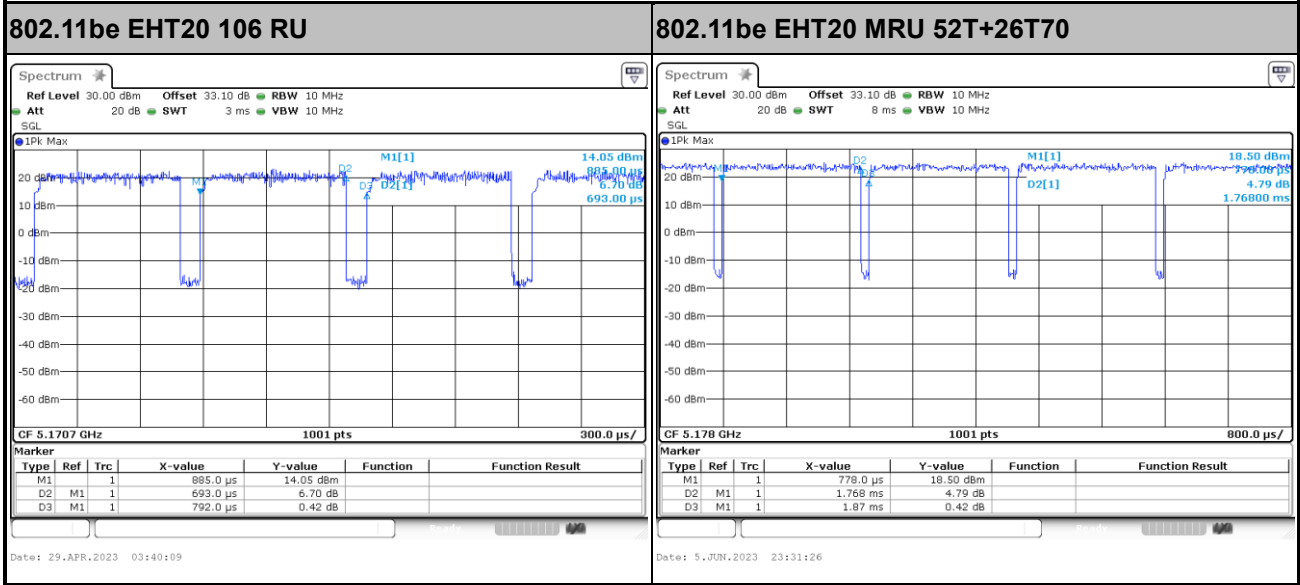



802.11be EHT80 Full RU

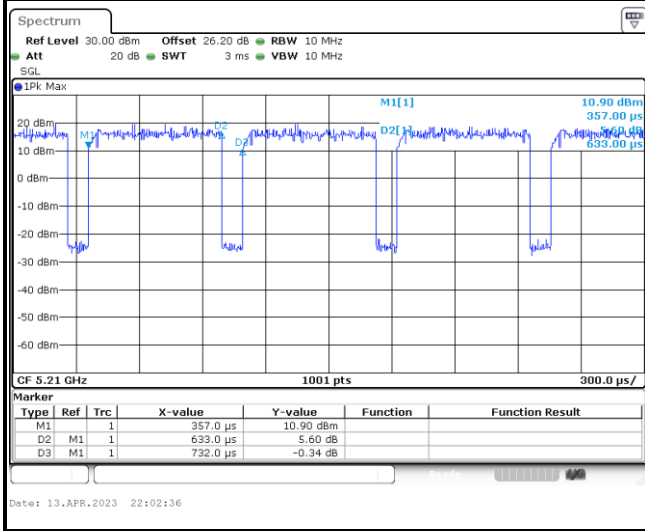

802.11be EHT80 Puncture 20RU8

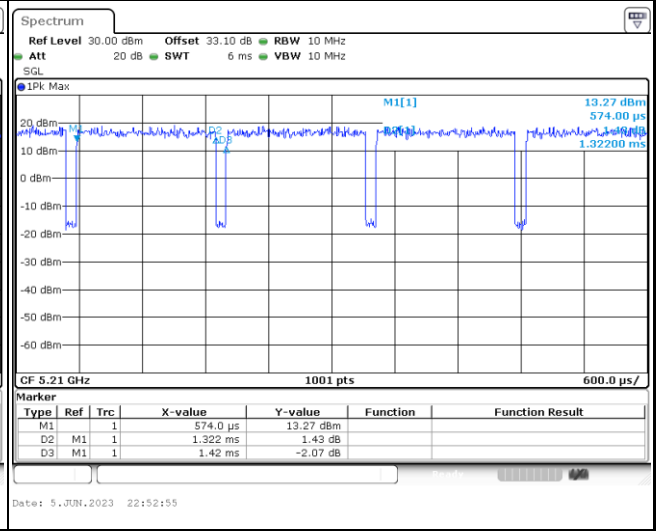

802.11be EHT160 Full RU

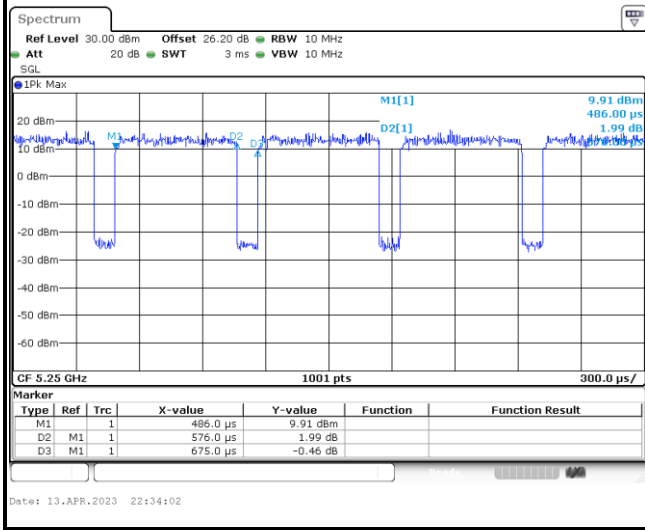

802.11be EHT160 Puncture 20RU128

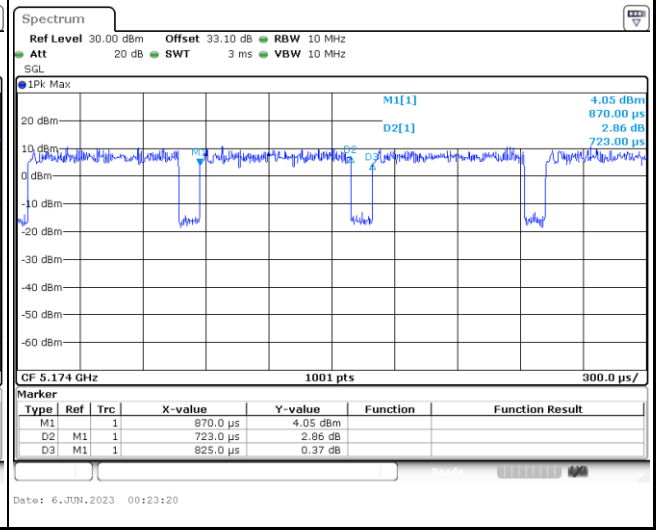

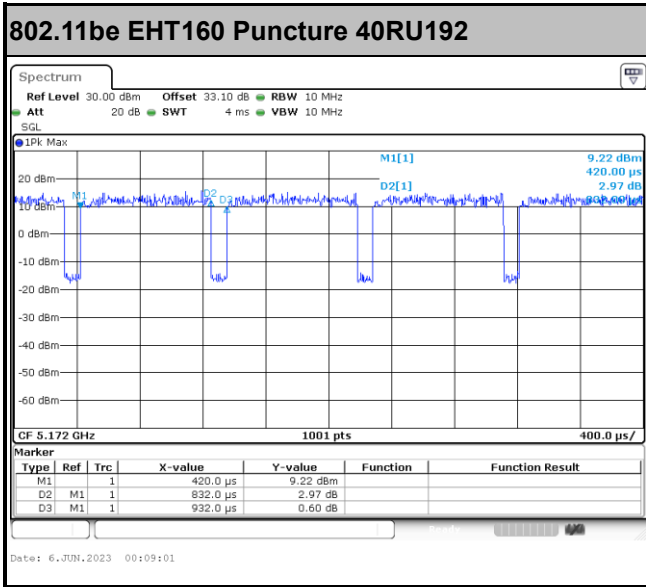



MIMO <Ant. 4>

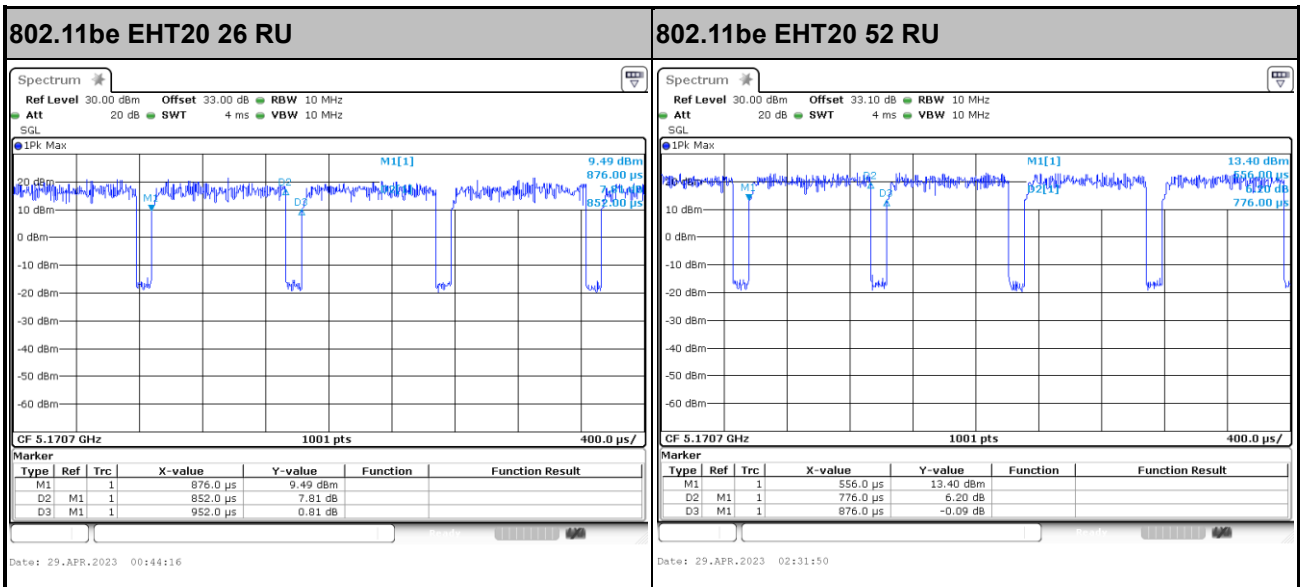
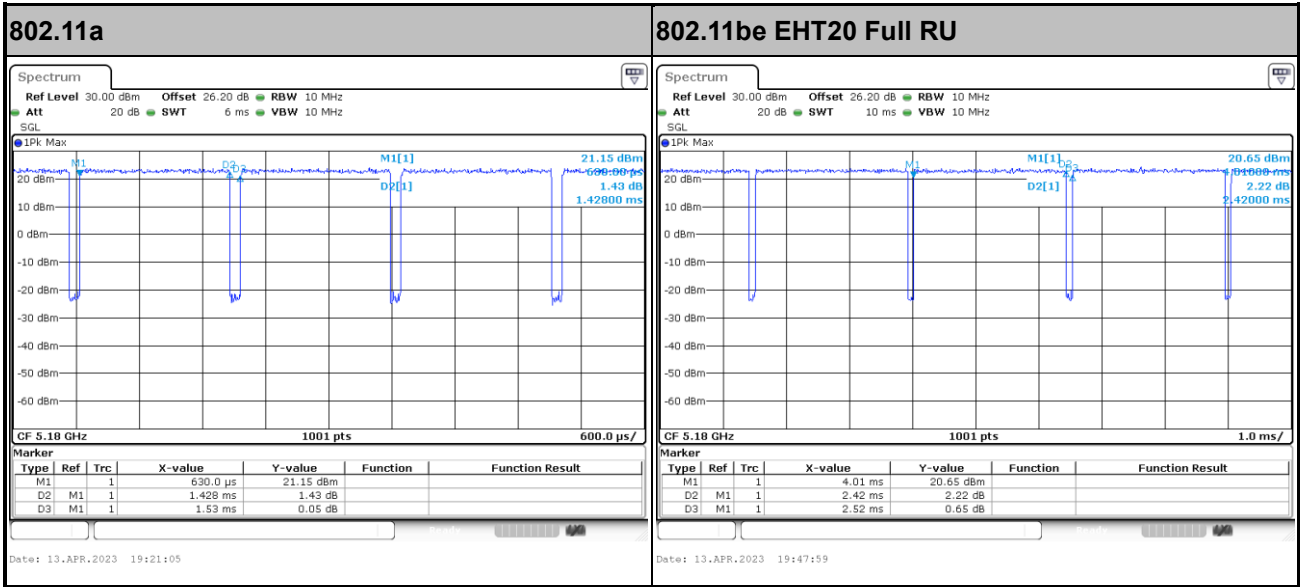

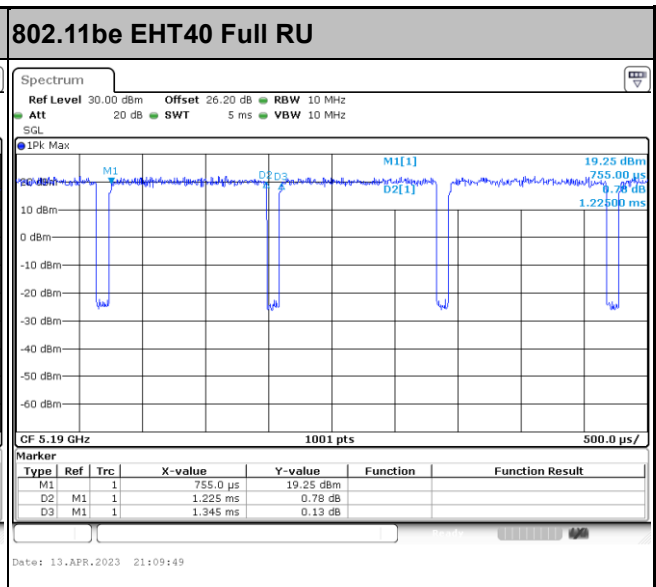
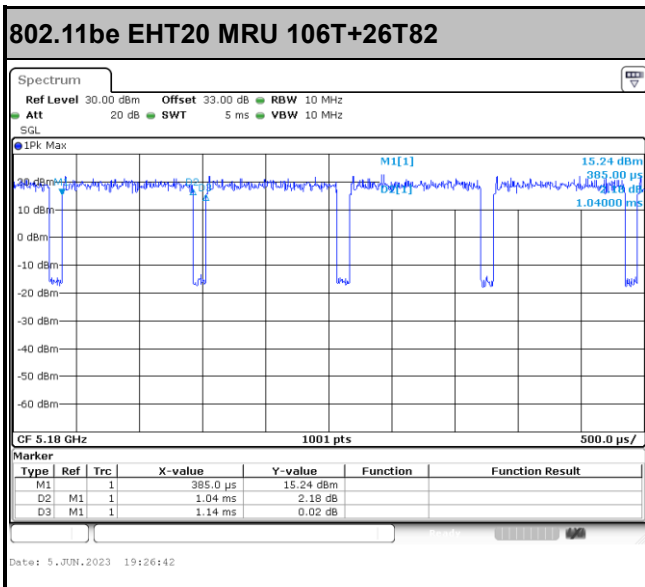
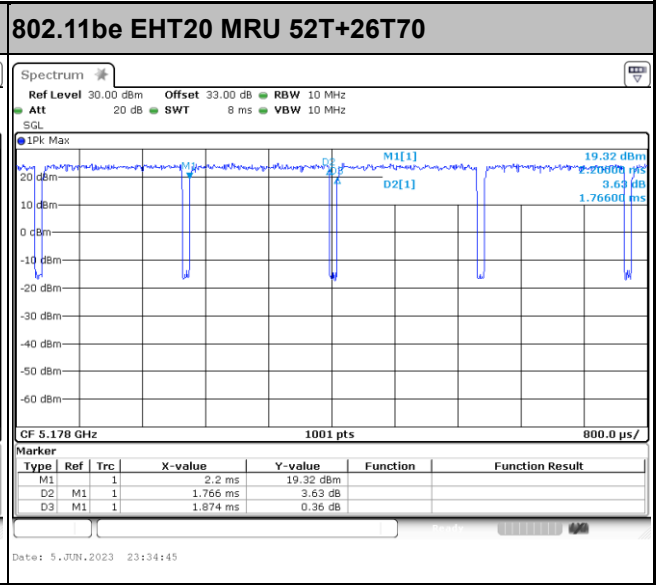
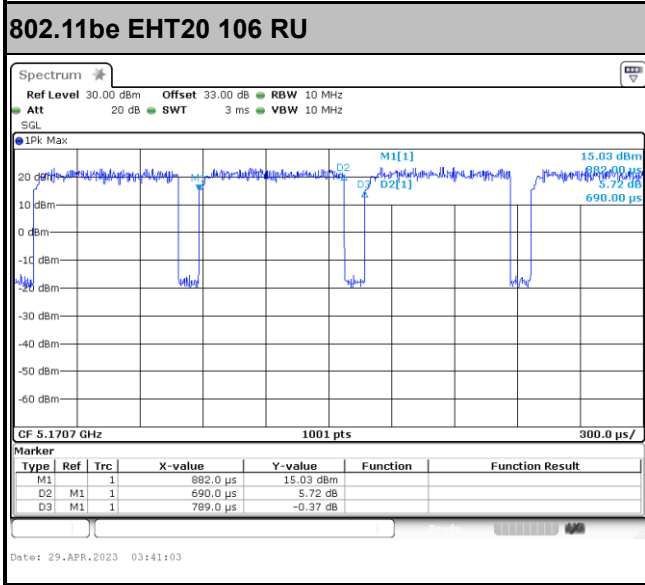



802.11be EHT80 Full RU

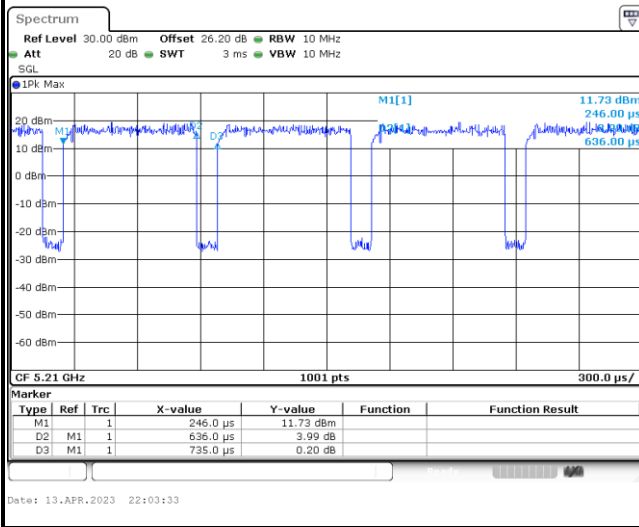

802.11be EHT80 Puncture 20RU8

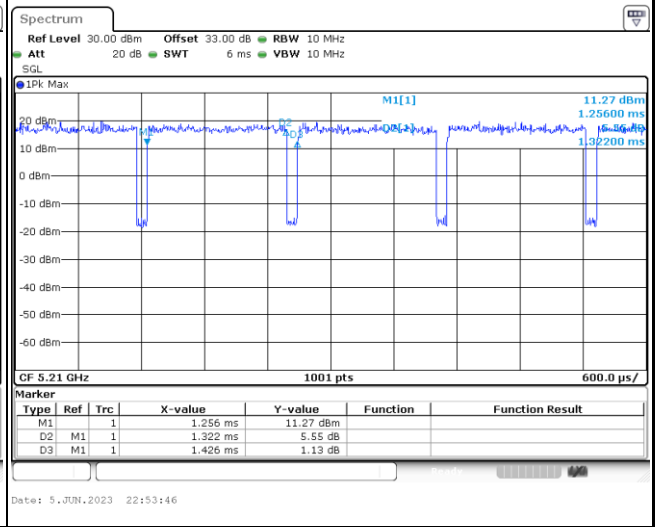

802.11be EHT160 Full RU

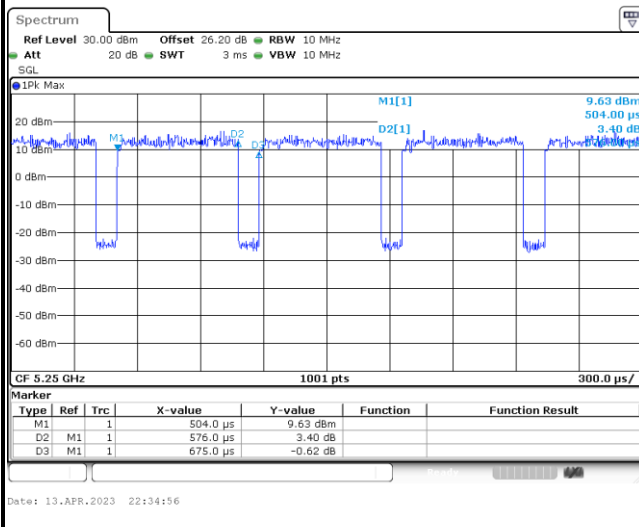

802.11be EHT160 Puncture 20RU128

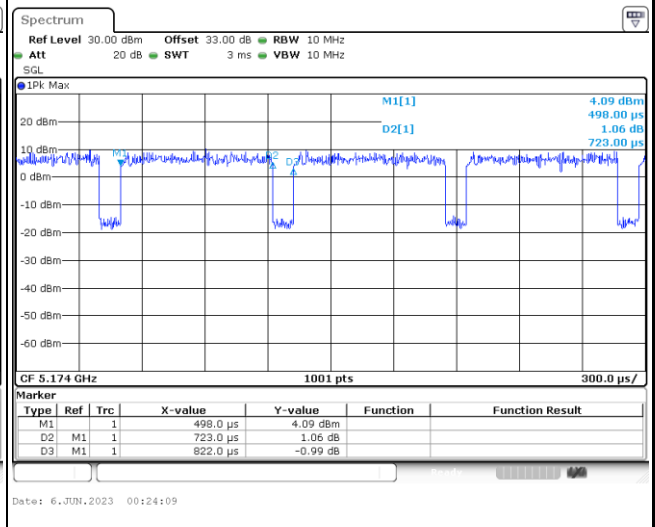

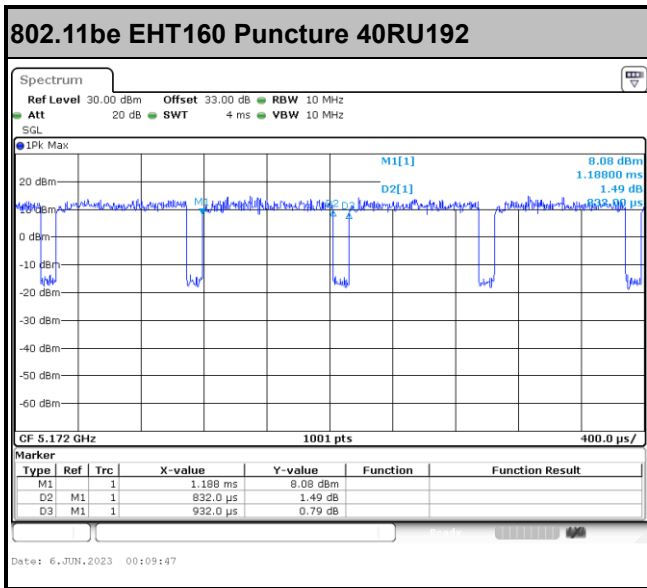

————THE END————