



FCC RADIO TEST REPORT

FCC ID : A4RGBDU9
Equipment : Wireless Device
Model Name : GBDU9
Applicant : Google LLC
1600 Amphitheatre Parkway,
Mountain View, California, 94043 USA
Standard : FCC Part 15 Subpart C §15.247

The product was received on Feb. 06, 2024 and testing was performed from Feb. 22, 2024 to Mar. 26, 2024. We, Sporton International Inc. Wensan Laboratory, would like to declare that the tested sample has been evaluated in accordance with the test procedures and has been in compliance with the applicable technical standards.

The test results in this report apply exclusively to the tested model / sample. Without written approval from Sporton International Inc. Wensan Laboratory, the test report shall not be reproduced except in full.

Approved by: Louis Wu

Sporton International Inc. Wensan Laboratory

No.58, Aly. 75, Ln. 564, Wenhua 3rd, Rd., Guishan Dist., Taoyuan City 333010, Taiwan (R.O.C.)



Table of Contents

History of this test report.....	3
Summary of Test Result.....	4
1 General Description.....	5
1.1 Product Feature of Equipment Under Test.....	5
1.2 Modification of EUT	5
1.3 Testing Location	6
1.4 Applicable Standards.....	6
2 Test Configuration of Equipment Under Test	7
2.1 Carrier Frequency Channel	7
2.2 Test Mode.....	8
2.3 Connection Diagram of Test System.....	9
2.4 Support Unit used in test configuration and system	10
2.5 EUT Operation Test Setup	10
2.6 Measurement Results Explanation Example.....	10
3 Test Result.....	11
3.1 6dB and 99% Bandwidth Measurement	11
3.2 Output Power Measurement.....	12
3.3 Power Spectral Density Measurement	13
3.4 Conducted Band Edges and Spurious Emission Measurement	14
3.5 Radiated Band Edges and Spurious Emission Measurement	15
3.6 AC Conducted Emission Measurement.....	19
3.7 Antenna Requirements	21
4 List of Measuring Equipment	22
5 Measurement Uncertainty	24
Appendix A. Conducted Test Results	
Appendix B. AC Conducted Emission Test Result	
Appendix C. Radiated Spurious Emission	
Appendix D. Radiated Spurious Emission Plots	
Appendix E. Duty Cycle Plots	
Appendix F. Setup Photographs	



Summary of Test Result

Report Clause	Ref Std. Clause	Test Items	Result (PASS/FAIL)	Remark
3.1	15.247(a)(2)	6dB Bandwidth	Pass	-
3.1	2.1049	99% Occupied Bandwidth	Reporting only	-
3.2	15.247(b)(3) 15.247(b)(4)	Output Power	Pass	-
3.3	15.247(e)	Power Spectral Density	Pass	-
3.4	15.247(d)	Conducted Band Edges and Spurious Emission	Pass	-
3.5	15.247(d)	Radiated Band Edges and Spurious Emission	Pass	6.32 dB under the limit at 30.00 MHz
3.6	15.207	AC Conducted Emission	Pass	17.83 dB under the limit at 0.15 MHz
3.7	15.203	Antenna Requirement	Pass	-

Conformity Assessment Condition:

1. The test results (PASS/FAIL) with all measurement uncertainty excluded are presented against the regulation limits or in accordance with the requirements stipulated by the applicant/manufacturer who shall bear all the risks of non-compliance that may potentially occur if measurement uncertainty is taken into account.
2. The measurement uncertainty please refer to each test result in the section "Measurement Uncertainty".

Disclaimer:

The product specifications of the EUT presented in the test report that may affect the test assessments are declared by the manufacturer who shall take full responsibility for the authenticity.

Reviewed by: Yun Huang
Report Producer: Lucy Wu



1 General Description

1.1 Product Feature of Equipment Under Test

Product Feature
<p>General Specs WCDMA/LTE, Bluetooth, BLE, BLE (CH2-76), Wi-Fi 2.4GHz 802.11b/g/n/ax, Wi-Fi 5GHz 802.11a/n/ac/ax, NFC, UWB and GPS.</p> <p>Antenna Type Bluetooth: PIFA Antenna</p>

EUT Information List	
S/N	Performed Test Item
1JE65010697050541D0381C	RF Conducted Measurement
41171JEAVL0007	Radiated Spurious Emission
41291JEAVL007H	Conducted Emission

Antenna information		
2400 MHz ~ 2483.5 MHz	Peak Gain (dBi)	-6.1

Remark: The EUT's information above is declared by manufacturer. Please refer to Disclaimer in report summary.

1.2 Modification of EUT

No modifications made to the EUT during the testing.



1.3 Testing Location

Test Site	Sporton International Inc. Wensan Laboratory
Test Site Location	No.58, Aly. 75, Ln. 564, Wenhua 3rd, Rd., Guishan Dist., Taoyuan City 333010, Taiwan (R.O.C.) TEL: +886-3-327-0868 FAX: +886-3-327-0855
Test Site No.	Sporton Site No. TH05-HY, CO07-HY, 03CH11-HY

Note: The test site complies with ANSI C63.4 2014 requirement.

FCC designation No.: TW3786

1.4 Applicable Standards

According to the specifications declared by the manufacturer, the EUT must comply with the requirements of the following standards:

- ♦ FCC Part 15 Subpart C §15.247
- ♦ FCC KDB Publication No. 558074 D01 15.247 Meas Guidance v05r02
- ♦ FCC KDB 414788 D01 Radiated Test Site v01r01
- ♦ ANSI C63.10-2013

Remark:

1. All the test items were validated and recorded in accordance with the standards without any modification during the testing.
2. The TAF code is not including all the FCC KDB listed without accreditation.



2 Test Configuration of Equipment Under Test

2.1 Carrier Frequency Channel

<Bluetooth - LE GFSK>

Frequency Band	Channel	Freq. (MHz)	Channel	Freq. (MHz)	Channel	Freq. (MHz)
2400-2483.5 MHz	-	-	27	2429	54	2456
	-	-	28	2430	55	2457
	2	2404	29	2431	56	2458
	3	2405	30	2432	57	2459
	4	2406	31	2433	58	2460
	5	2407	32	2434	59	2461
	6	2408	33	2435	60	2462
	7	2409	34	2436	61	2463
	8	2410	35	2437	62	2464
	9	2411	36	2438	63	2465
	10	2412	37	2439	64	2466
	11	2413	38	2440	65	2467
	12	2414	39	2441	66	2468
	13	2415	40	2442	67	2469
	14	2416	41	2443	68	2470
	15	2417	42	2444	69	2471
	16	2418	43	2445	70	2472
	17	2419	44	2446	71	2473
	18	2420	45	2447	72	2474
	19	2421	46	2448	73	2475
	20	2422	47	2449	74	2476
	21	2423	48	2450	75	2477
	22	2424	49	2451	76	2478
	-	-	50	2452	-	-
	-	-	51	2453	-	-
	-	-	52	2454	-	-
26	2428	53	2455	-	-	



2.2 Test Mode

- a. The EUT has been associated with peripherals and configuration operated in a manner tended to maximize its emission characteristics in a typical application. Frequency range investigated: conduction emission (150 kHz to 30 MHz), radiation emission (9 kHz to the 10th harmonic of the highest fundamental frequency or to 40 GHz, whichever is lower). For radiated measurement, the measured emission level of the EUT was maximized by rotating the EUT on a turntable, adjusting the orientation of the EUT and EUT antenna in three orthogonal axis (X: flat, Y: portrait, Z: landscape), and adjusting the measurement antenna orientation, following C63.10 exploratory test procedures and find X plane with Adapter as worst plane.
- b. AC power line Conducted Emission was tested under maximum output power.

The following summary table is showing all test modes to demonstrate in compliance with the standard.

Summary table of Test Cases	
Test Item	Data Rate / Modulation
Conducted Test Cases	Bluetooth-LE GFSK / GFSK
	Mode 1: Bluetooth-LE GFSK Tx CH02_2404 MHz_1Mbps
	Mode 2: Bluetooth-LE GFSK Tx CH38_2440 MHz_1Mbps
	Mode 3: Bluetooth-LE GFSK Tx CH76_2478 MHz_1Mbps
	Mode 4: Bluetooth-LE GFSK Tx CH02_2404 MHz_2Mbps
	Mode 5: Bluetooth-LE GFSK Tx CH38_2440 MHz_2Mbps
	Mode 6: Bluetooth-LE GFSK Tx CH76_2478 MHz_2Mbps
Radiated Test Cases	Mode 1: Bluetooth-LE GFSK Tx CH02_2404 MHz_1Mbps
	Mode 2: Bluetooth-LE GFSK Tx CH38_2440 MHz_1Mbps
	Mode 3: Bluetooth-LE GFSK Tx CH76_2478 MHz_1Mbps
	Mode 4: Bluetooth-LE GFSK Tx CH02_2404 MHz_2Mbps
	Mode 5: Bluetooth-LE GFSK Tx CH38_2440 MHz_2Mbps
	Mode 6: Bluetooth-LE GFSK Tx CH76_2478 MHz_2Mbps
AC Conducted Emission	Mode 1: Bluetooth Link + WLAN (2.4GHz) Link + USB Cable (Charging from AC Adapter)
Remark: For radiation spurious emission, the modulation and the data rate picked for testing are determined by the Max. RF conducted power.	

2.3 Connection Diagram of Test System

<AC Conducted Emission Mode>

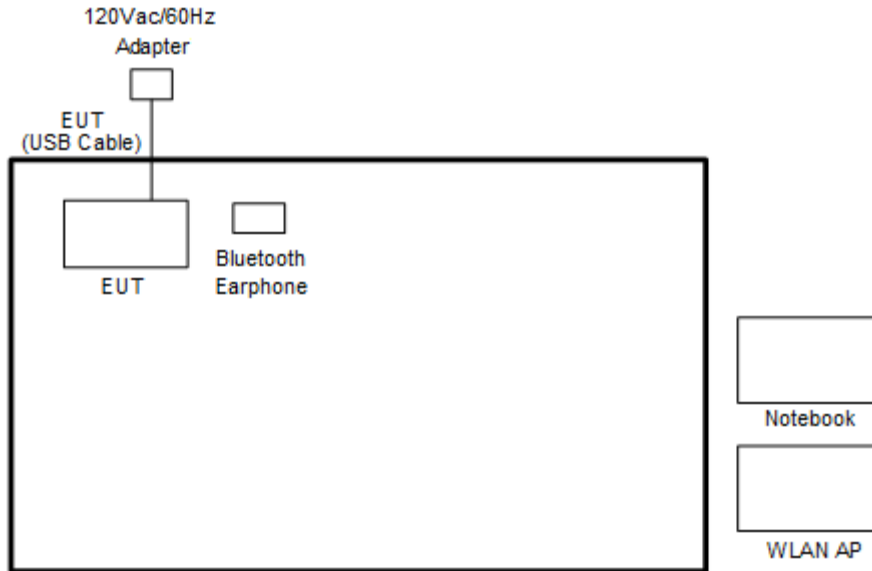

<Bluetooth-LE Tx Mode>

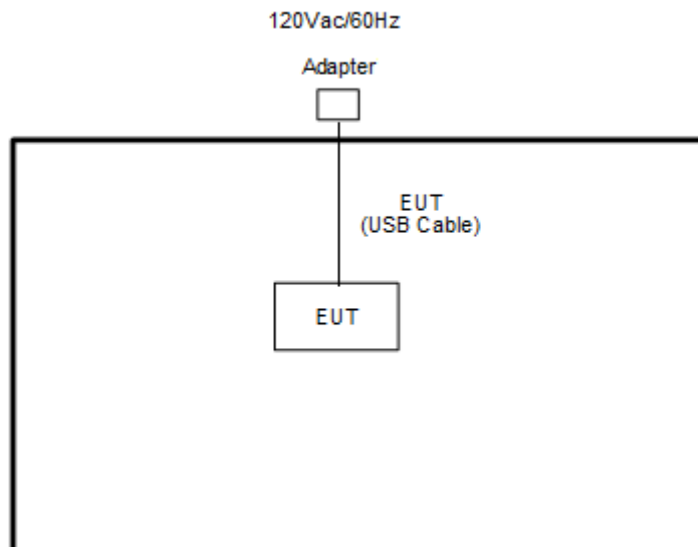



2.4 Support Unit used in test configuration and system

Item	Equipment	Brand Name	Model Name	FCC ID	Data Cable	Power Cord
1.	Bluetooth Earphone	Sony	SBH20	PY7-RD0010	N/A	N/A
2.	WLAN AP	ASUS	RT-AC52	MSQ-RTAC4A00	N/A	Unshielded, 1.8 m
3.	Notebook	DELL	Latitude 3400	FCC DoC	N/A	AC I/P: Unshielded, 1.2 m DC O/P: Shielded, 1.8 m
4.	Adapter	Chicony	G9BR1	N/A	N/A	N/A
5.	Adapter	Aohai	G9BR1	N/A	N/A	N/A

2.5 EUT Operation Test Setup

The RF test items, utility “CMD v.10.0.18362.1256” was installed in Notebook which was programmed in order to make the EUT get into the engineering modes to provide channel selection, power level, data rate and the application type and for continuous transmitting signals.

2.6 Measurement Results Explanation Example

For all conducted test items:

The offset level is set in the spectrum analyzer to compensate the RF cable loss and attenuator factor between EUT conducted output port and spectrum analyzer. With the offset compensation, the spectrum analyzer reading level is exactly the EUT RF output level.

Example :

The spectrum analyzer offset is derived from RF cable loss and attenuator factor.

Offset = RF cable loss + attenuator factor.

Following shows an offset computation example with cable loss 4.2 dB and 10 dB attenuator.

$$\begin{aligned} \text{Offset(dB)} &= \text{RF cable loss(dB)} + \text{attenuator factor(dB)}. \\ &= 4.2 + 10 = 14.2 \text{ (dB)} \end{aligned}$$

3 Test Result

3.1 6dB and 99% Bandwidth Measurement

3.1.1 Limit of 6dB and 99% Bandwidth

The minimum 6 dB bandwidth shall be at least 500 kHz.

3.1.2 Measuring Instruments

Please refer to the measuring equipment list in this test report.

3.1.3 Test Procedures

1. The testing follows the ANSI C63.10 Section 6.9.3 (OBW) and 11.8.1 (6dB BW).
2. The RF output of EUT is connected to the spectrum analyzer by RF cable and attenuator. The path loss is compensated to the results for each measurement.
3. Set the maximum power setting and enable the EUT to transmit continuously.
4. Make the measurement with the spectrum analyzer's resolution bandwidth (RBW) = 100 kHz. Set the Video bandwidth (VBW) = 300 kHz. In order to make an accurate measurement. The 6dB bandwidth must be greater than 500 kHz.
5. For 99% Bandwidth Measurement, the spectrum analyzer's resolution bandwidth (RBW) is set 1-5% of the emission bandwidth and set the Video bandwidth (VBW) $\geq 3 * RBW$.
6. Measure and record the results in the test report.

3.1.4 Test Setup



3.1.5 Test Result of 6dB Bandwidth

Please refer to Appendix A.

3.1.6 Test Result of 99% Occupied Bandwidth

Please refer to Appendix A.

3.2 Output Power Measurement

3.2.1 Limit of Output Power

For systems using digital modulation in the 2400-2483.5 MHz, the limit for output power is 30 dBm. If transmitting antenna of directional gain greater than 6 dBi is used, the peak output power from the intentional radiator shall be reduced below the above stated value by the amount in dB that the directional gain of the antenna exceeds 6 dBi. In case of point-to-point operation, the limit has to be reduced by 1 dB for every 3 dB that the directional gain of the antenna exceeds 6 dBi.

3.2.2 Measuring Instruments

Please refer to the measuring equipment list in this test report.

3.2.3 Test Procedures

1. For Average Power, the testing follows ANSI C63.10 Section 11.9.2.3.2 Method AVGPM-G
2. The RF output of EUT is connected to the power meter by RF cable and attenuator.
3. The path loss is compensated to the results for each measurement.
4. Set the maximum power setting and enable the EUT to transmit continuously.
5. Measure the conducted output power and record the results in the test report.

3.2.4 Test Setup

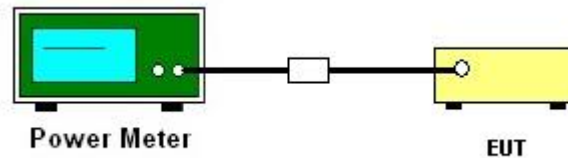

3.2.5 Test Result of Average Output Power

Please refer to Appendix A.

3.3 Power Spectral Density Measurement

3.3.1 Limit of Power Spectral Density

The peak power spectral density shall not be greater than 8 dBm in any 3 kHz band at any time interval of continuous transmission.

3.3.2 Measuring Instruments

Please refer to the measuring equipment list in this test report.

3.3.3 Test Procedures

1. The testing follows the ANSI C63.10 Section 11.10.2 Method PKPSD.
2. The RF output of EUT is connected to the spectrum analyzer by RF cable and attenuator. The path loss is compensated to the results for each measurement.
3. Set the maximum power setting and enable the EUT to transmit continuously.
4. Make the measurement with the spectrum analyzer's resolution bandwidth (RBW) = 3 kHz. Video bandwidth (VBW) = 10 kHz. In order to make an accurate measurement, set the span to 1.5 times DTS Channel Bandwidth. (6 dB BW)
5. Detector = peak, Sweep time = auto couple, Trace mode = max hold, Allow trace to fully stabilize. Use the peak marker function to determine the maximum power level.
6. Measure and record the results in the test report.
7. The Measured power density (dBm)/ 100 kHz is a reference level and is used as 20 dBc down limit line for Conducted Band Edges and Conducted Spurious Emission.

3.3.4 Test Setup

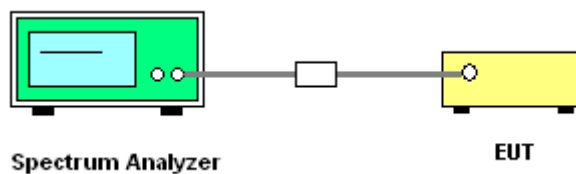

3.3.5 Test Result of Power Spectral Density

Please refer to Appendix A.

3.4 Conducted Band Edges and Spurious Emission Measurement

3.4.1 Limit of Conducted Band Edges and Spurious Emission

All harmonics/spurious must be at least 30 dB down from the highest emission level within the authorized band.

3.4.2 Measuring Instruments

Please refer to the measuring equipment list in this test report.

3.4.3 Test Procedure

1. The testing follows the ANSI C63.10 Section 11.11.3 Emission level measurement.
2. The RF output of EUT is connected to the spectrum analyzer by RF cable and attenuator. The path loss is compensated to the results for each measurement.
3. Set the maximum power setting and enable the EUT to transmit continuously.
4. Set RBW = 100 kHz, VBW = 300 kHz, Peak Detector. Unwanted Emissions measured in any 100 kHz bandwidth outside of the authorized frequency band shall be attenuated by at least 20 dB relative to the maximum in-band peak PSD level in 100 kHz when maximum peak conducted output power procedure is used. If the transmitter complies with the conducted power limits based on the use of RMS averaging over a time interval, the attenuation required under this paragraph shall be 30 dB instead of 20 dB.
5. Measure and record the results in the test report.
6. The RF fundamental frequency should be excluded against the limit line in the operating frequency band.

3.4.4 Test Setup

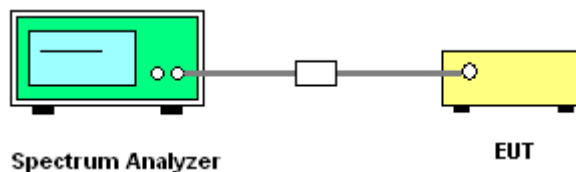

3.4.5 Test Result of Conducted Band Edges Plots

Please refer to Appendix A.

3.4.6 Test Result of Conducted Spurious Emission Plots

Please refer to Appendix A.



3.5 Radiated Band Edges and Spurious Emission Measurement

3.5.1 Limit of Radiated Band Edges and Spurious Emission

In any 100 kHz bandwidth outside the intentional radiator frequency band, all harmonics/spurious must be at least 20 dB below the highest emission level within the authorized band. If the output power of this device is measured by spectrum analyzer, the attenuation under this paragraph shall be 30 dB instead of 20 dB. In addition, radiated emissions which fall in the restricted bands must also comply with the limits as below.

Frequency (MHz)	Field Strength (microvolts/meter)	Measurement Distance (meters)
0.009 – 0.490	2400/F(kHz)	300
0.490 – 1.705	24000/F(kHz)	30
1.705 – 30.0	30	30
30 – 88	100	3
88 – 216	150	3
216 - 960	200	3
Above 960	500	3

3.5.2 Measuring Instruments

Please refer to the measuring equipment list in this test report.

**3.5.3 Test Procedures**

1. The testing follows the ANSI C63.10 Section 11.12.1 Radiated emission measurements.
2. The EUT is arranged to its worst case and then tune the antenna tower (from 1 m to 4 m) and turntable (from 0 degree to 360 degrees) to find the maximum reading. A pre-amp and a high pass filter are used for the test in order to get better signal level.
3. The EUT is placed on a turntable with 0.8 meter for frequency below 1 GHz and 1.5 meter for frequency above 1 GHz respectively above ground.
4. The EUT is set 3 meters away from the receiving antenna, which is mounted on the top of a variable height antenna tower.
5. Corrected Reading: Antenna Factor + Cable Loss + Read Level - Preamp Factor = Level
6. Radiated testing below 1 GHz is performed by adjusting the antenna tower from 1 m to 4 m and by rotating the turn table from 0 degree to 360 degrees to find the peak maximum hold reading. When there is no suspected emission found and the emission level is with at least 6 dB margin against QP limit line, the position is marked as “-“.
7. Radiated testing above 1 GHz is performed by adjusting the antenna tower from 1 m to 4 m and by rotating the turn table from 0 degree to 360 degrees to find the peak maximum hold reading for scanning all frequencies. When there is no suspected emission found and the harmonic emission level is with at least 6 dB margin against average limit line, the position is marked as “-“.
8. Use the following spectrum analyzer settings:
 - (1) Span shall wide enough to fully capture the emission being measured;
 - (2) Set RBW = 100 kHz for $f < 1$ GHz; VBW \geq RBW; Sweep = auto; Detector function = peak; Trace = max hold;
 - (3) Set RBW = 1 MHz, VBW = 3 MHz for $f \geq 1$ GHz for peak measurement.
For average measurement:
 - VBW = 10 Hz, when duty cycle is no less than 98 percent.
 - VBW $\geq 1/T$, when duty cycle is less than 98 percent where T is the minimum transmission duration over which the transmitter is on and is transmitting at its maximum power control level for the tested mode of operation.

3.5.4 Test Setup

For radiated test below 30MHz

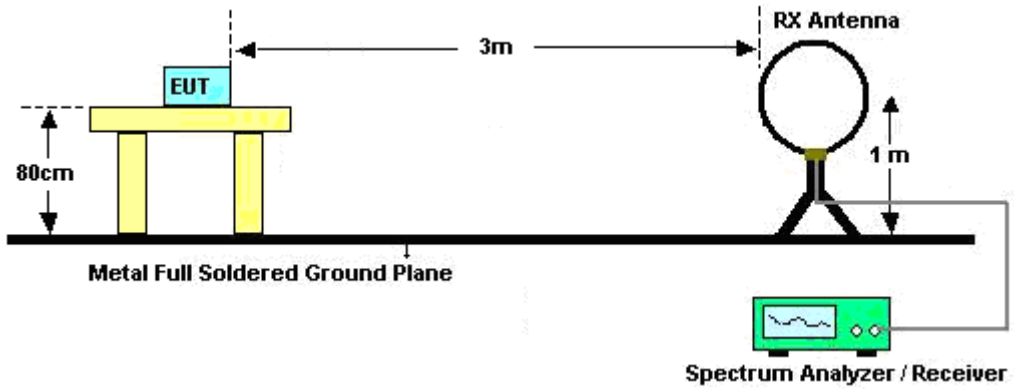

For radiated test from 30MHz to 1GHz

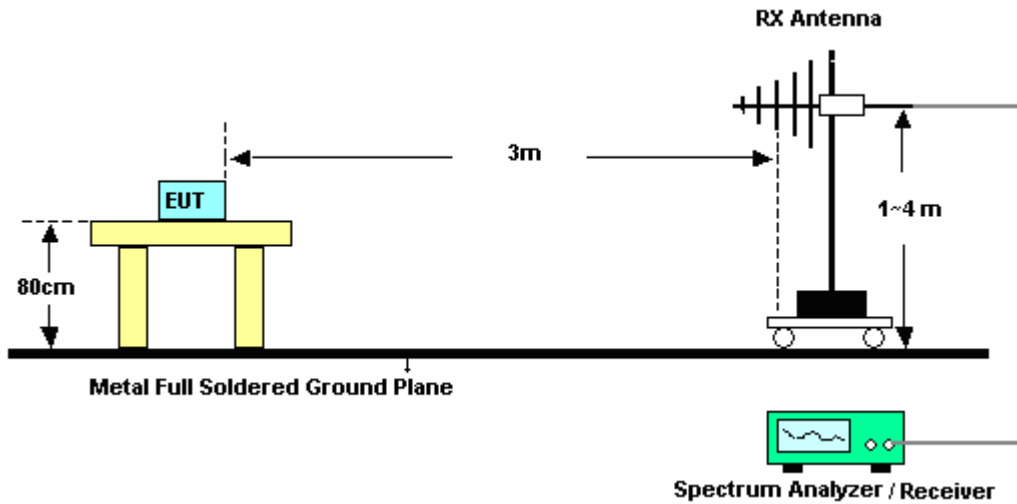

For radiated test from 1GHz to 18GHz

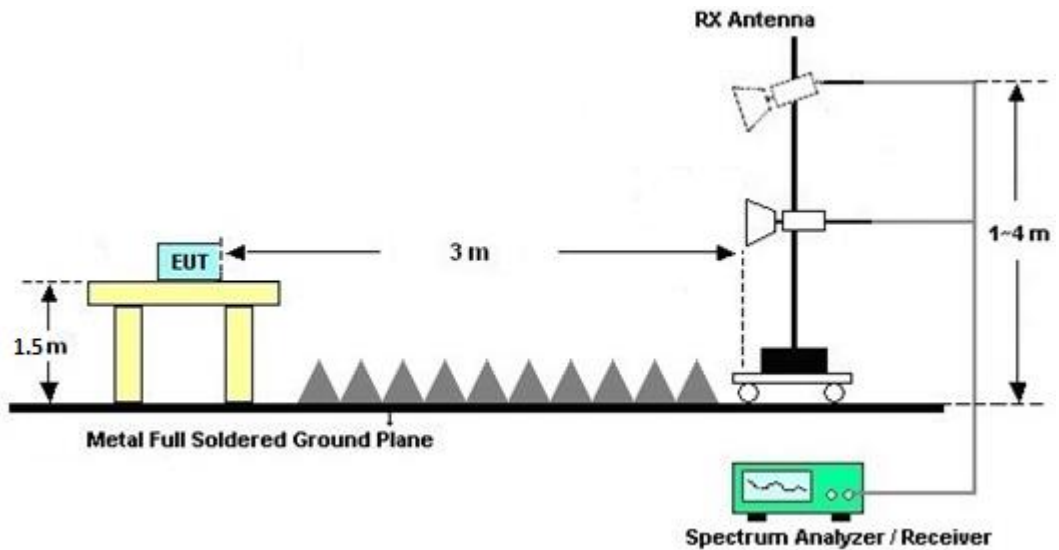

For radiated test above 18GHz

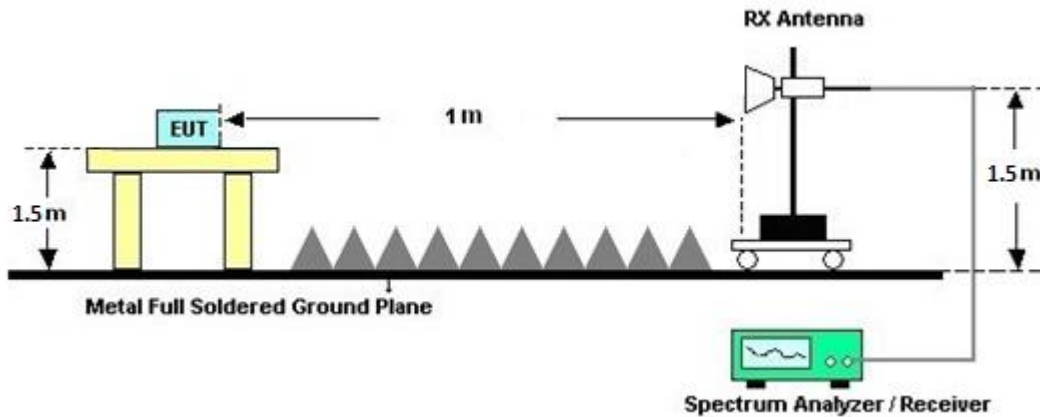

3.5.5 Test Results of Radiated Spurious Emissions (9 kHz ~ 30 MHz)

The low frequency, which starts from 9 kHz to 30 MHz, is pre-scanned and the result which is 20 dB lower than the limit line is not reported.

There is adequate comparison measurement of both open-field test site and alternative test site - semi-Anechoic chamber according to 414788 D01 Radiated Test Site v01r01, and the result comes out very similar.

3.5.6 Test Result of Radiated Spurious at Band Edges

Please refer to Appendix C and D.

3.5.7 Duty Cycle

Please refer to Appendix E.

3.5.8 Test Result of Radiated Spurious Emission (30 MHz ~ 10th Harmonic)

Please refer to Appendix C and D.



3.6 AC Conducted Emission Measurement

3.6.1 Limit of AC Conducted Emission

For equipment that is designed to be connected to the public utility (AC) power line, the radio frequency voltage that is conducted back onto the AC power line on any frequency or frequencies within the band 150 kHz to 30 MHz shall not exceed the limits in the following table.

Frequency of emission (MHz)	Conducted limit (dB μ V)	
	Quasi-peak	Average
0.15-0.5	66 to 56*	56 to 46*
0.5-5	56	46
5-30	60	50

*Decreases with the logarithm of the frequency.

3.6.2 Measuring Instruments

Please refer to the measuring equipment list in this test report.

3.6.3 Test Procedures

1. The EUT is placed 0.4 meter away from the conducting wall of the shielding room, and is kept at least 80 centimeters from any other grounded conducting surface.
2. Connect EUT to the power mains through a line impedance stabilization network (LISN).
3. All the support units are connecting to the other LISN.
4. The LISN provides 50 ohm coupling impedance for the measuring instrument.
5. The FCC states that a 50 ohm, 50 microhenry LISN shall be used.
6. Both Line and Neutral shall be tested in order to find out the maximum conducted emission.
7. The frequency range from 150 kHz to 30 MHz is scanned.
8. Set the test-receiver system to Peak Detect Function and specified bandwidth (IF Bandwidth = 9 kHz) with Maximum Hold Mode. Then measurement is also conducted by Average Detector and Quasi-Peak Detector Function respectively.

3.6.4 Test Setup

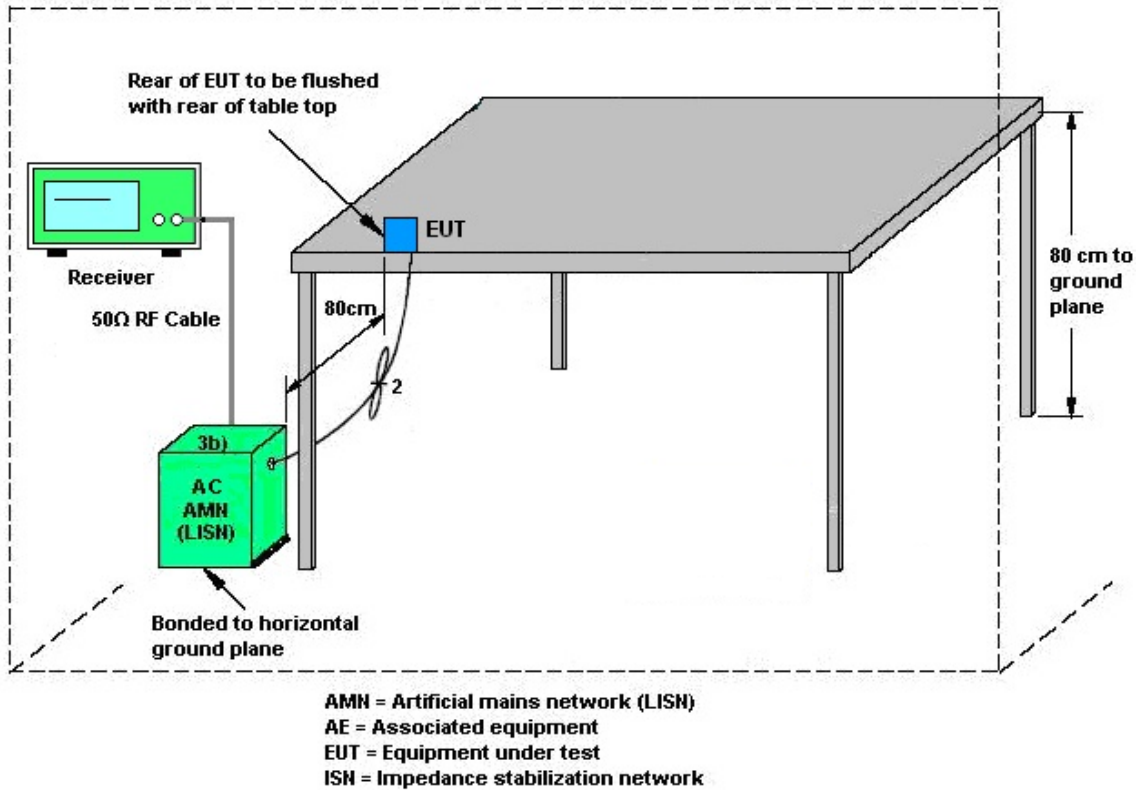

3.6.5 Test Result of AC Conducted Emission

Please refer to Appendix B.



3.7 Antenna Requirements

3.7.1 Standard Applicable

The use of a permanently attached antenna or of an antenna that uses a unique coupling to the intentional radiator shall be considered sufficient to comply with the rule.

3.7.2 Antenna Anti-Replacement Construction

An embedded-in antenna design is used.



4 List of Measuring Equipment

Instrument	Brand Name	Model No.	Serial No.	Characteristics	Calibration Date	Test Date	Due Date	Remark
Bilog Antenna	TESEQ	CBL 6111D & N-6-06	35414 & AT-N0602	30MHz~1GHz	Oct. 07, 2023	Feb. 22, 2024~ Mar. 26, 2024	Oct. 06, 2024	Radiation (03CH11-HY)
Loop Antenna	Rohde & Schwarz	HFH2-Z2	100488	9 kHz~30 MHz	Sep. 12, 2023	Feb. 22, 2024~ Mar. 26, 2024	Sep. 11, 2024	Radiation (03CH11-HY)
Horn Antenna	SCHWARZBECK	BBHA 9120 D	9120D-01620	1GHz~18GHz	Aug. 17, 2023	Feb. 22, 2024~ Mar. 26, 2024	Aug. 16, 2024	Radiation (03CH11-HY)
SHF-EHF Horn Antenna	SCHWARZBECK	BBHA 9170	1223	18GHz~40GHz	Jul. 10, 2023	Feb. 22, 2024~ Mar. 26, 2024	Jul. 09, 2024	Radiation (03CH11-HY)
Amplifier	SONOMA	310N	187312	9kHz~1GHz	Dec. 08, 2023	Feb. 22, 2024~ Mar. 26, 2024	Dec. 07, 2024	Radiation (03CH11-HY)
Preamplifier	E-INSTRUMENT TECH LTD.	ERA-10M-7000-MR	EC1900245	10MHz-7GHz	Jan. 09, 2024	Feb. 22, 2024~ Mar. 26, 2024	Jan. 08, 2025	Radiation (03CH11-HY)
Preamplifier	Jet-Power	JPA0118-55-303	1710001800055007	1GHz~18GHz	Jun. 14, 2023	Feb. 22, 2024~ Mar. 26, 2024	Jun. 13, 2024	Radiation (03CH11-HY)
Preamplifier	EMEC	EM18G40G	060801	18GHz~40GHz	Jun. 27, 2023	Feb. 22, 2024~ Mar. 26, 2024	Jun. 26, 2024	Radiation (03CH11-HY)
Spectrum Analyzer	Keysight	N9010A	MY54200486	10Hz~44GHz	Oct. 05, 2023	Feb. 22, 2024~ Mar. 26, 2024	Oct. 04, 2024	Radiation (03CH11-HY)
Controller	EMEC	EM 1000	N/A	Control Turn table & Ant Mast	N/A	Feb. 22, 2024~ Mar. 26, 2024	N/A	Radiation (03CH11-HY)
Antenna Mast	EMEC	AM-BS-4500-B	N/A	1~4m	N/A	Feb. 22, 2024~ Mar. 26, 2024	N/A	Radiation (03CH11-HY)
Turn Table	EMEC	TT 2000	N/A	0~360 Degree	N/A	Feb. 22, 2024~ Mar. 26, 2024	N/A	Radiation (03CH11-HY)
Software	Audix	E3 6.2009-8-24	RK-001053	N/A	N/A	Feb. 22, 2024~ Mar. 26, 2024	N/A	Radiation (03CH11-HY)
RF Cable	HUBER + SUHNER	SUCOFLEX 102	MY1595/2	30MHz~40GHz	Mar. 07, 2023	Feb. 22, 2024~ Mar. 05, 2024	Mar. 06, 2024	Radiation (03CH11-HY)
RF Cable	HUBER + SUHNER	SUCOFLEX 102	MY1595/2	30MHz~40GHz	Mar. 06, 2024	Mar. 06, 2024~ Mar. 26, 2024	Mar. 05, 2025	Radiation (03CH11-HY)
RF Cable	HUBER + SUHNER	SUCOFLEX 102	MY2859/2	30MHz~40GHz	Mar. 07, 2023	Feb. 22, 2024~ Mar. 05, 2024	Mar. 06, 2024	Radiation (03CH11-HY)
RF Cable	HUBER + SUHNER	SUCOFLEX 102	MY2859/2	30MHz~40GHz	Mar. 06, 2024	Mar. 06, 2024~ Mar. 26, 2024	Mar. 05, 2025	Radiation (03CH11-HY)
RF Cable	HUBER + SUHNER	SUCOFLEX 102	803951/2	9K~30M	Mar. 07, 2023	Feb. 22, 2024~ Mar. 05, 2024	Mar. 06, 2024	Radiation (03CH11-HY)
RF Cable	HUBER + SUHNER	SUCOFLEX 102	803951/2	9K~30M	Mar. 06, 2024	Mar. 06, 2024~ Mar. 26, 2024	Mar. 05, 2025	Radiation (03CH11-HY)
RF Cable	HUBER + SUHNER	SUCOFLEX 102	803951/2	30M~40G	Mar. 07, 2023	Feb. 22, 2024~ Mar. 05, 2024	Mar. 06, 2024	Radiation (03CH11-HY)
RF Cable	HUBER + SUHNER	SUCOFLEX 102	803951/2	30M~40G	Mar. 06, 2024	Mar. 06, 2024~ Mar. 26, 2024	Mar. 05, 2025	Radiation (03CH11-HY)
Filter	Wainwright	WLK4-1000-1530-8000-40SS	SN11	1.53G Low Pass	Sep. 11, 2023	Feb. 22, 2024~ Mar. 26, 2024	Sep. 10, 2024	Radiation (03CH11-HY)
Filter	Wainwright	WHKX12-2700-3000-18000-60SS	SN3	3GHz High Pass Filter	Sep. 11, 2023	Feb. 22, 2024~ Mar. 26, 2024	Sep. 10, 2024	Radiation (03CH11-HY)
Hygrometer	TECPEL	DTM-303A	TP201996	N/A	Nov. 07, 2023	Feb. 22, 2024~ Feb. 23, 2024	Nov. 06, 2024	Conducted (TH05-HY)
Power Sensor	DARE	RPR3006W	15100041SNO10 (NO:248)	10MHz~6GHz	Jun. 05, 2023	Feb. 22, 2024~ Feb. 23, 2024	Jun. 04, 2024	Conducted (TH05-HY)
Signal Analyzer	Rohde & Schwarz	FSV40	101566	10Hz~40GHz	Aug. 23, 2023	Feb. 22, 2024~ Feb. 23, 2024	Aug. 22, 2024	Conducted (TH05-HY)



Instrument	Brand Name	Model No.	Serial No.	Characteristics	Calibration Date	Test Date	Due Date	Remark
AC Power Source	ACPOWER	AFC-11003G	F317040033	N/A	N/A	Mar. 15, 2024	N/A	Conduction (CO07-HY)
Software	Rohde & Schwarz	EMC32 V10.30	N/A	N/A	N/A	Mar. 15, 2024	N/A	Conduction (CO07-HY)
Pulse Limiter	SCHWARZBECK	VTSD 9561-F N	9561-F N00373	9kHz-200MHz	Oct. 20, 2023	Mar. 15, 2024	Oct. 19, 2024	Conduction (CO07-HY)
Two-Line V-Network	TESEQ	NNB 51	45051	N/A	Mar. 10, 2024	Mar. 15, 2024	Mar. 09, 2025	Conduction (CO07-HY)
Four-Line V-Network	TESEQ	NNB 52	36122	N/A	Mar. 07, 2024	Mar. 15, 2024	Mar. 06, 2025	Conduction (CO07-HY)
EMI Test Receiver	Rohde & Schwarz	ESR3	102317	9kHz~3.6GHz	Sep. 20, 2023	Mar. 15, 2024	Sep. 19, 2024	Conduction (CO07-HY)



5 Measurement Uncertainty

Uncertainty of Conducted Emission Measurement (150 kHz ~ 30 MHz)

Measuring Uncertainty for a Level of Confidence of 95% ($U = 2Uc(y)$)	3.44 dB
---	---------

Uncertainty of Radiated Emission Measurement (30 MHz ~ 1000 MHz)

Measuring Uncertainty for a Level of Confidence of 95% ($U = 2Uc(y)$)	6.1 dB
---	--------

Uncertainty of Radiated Emission Measurement (1000 MHz ~ 6000 MHz)

Measuring Uncertainty for a Level of Confidence of 95% ($U = 2Uc(y)$)	4.3 dB
---	--------

Uncertainty of Radiated Emission Measurement (6000 MHz ~ 18000 MHz)

Measuring Uncertainty for a Level of Confidence of 95% ($U = 2Uc(y)$)	4.3 dB
---	--------

Uncertainty of Radiated Emission Measurement (18000 MHz ~ 40000 MHz)

Measuring Uncertainty for a Level of Confidence of 95% ($U = 2Uc(y)$)	5.3 dB
---	--------

Appendix A. Test Result of Conducted Test Items

Test Engineer:	Eason Huang	Temperature:	21~25	°C
Test Date:	2024/02/22~2024/02/23	Relative Humidity:	51~54	%

TEST RESULTS DATA
6dB and 99% Occupied Bandwidth

Mod.	Data Rate	NTX	CH.	Freq. (MHz)	99% Occupied BW (MHz)	6dB BW (MHz)	6dB BW Limit (MHz)	Pass/Fail
BLE GFSK	1Mbps	1	2	2404	1.075	0.700	0.50	Pass
BLE GFSK	1Mbps	1	38	2440	1.057	0.700	0.50	Pass
BLE GFSK	1Mbps	1	76	2478	1.079	0.695	0.50	Pass

TEST RESULTS DATA
Average Power Table

Mod.	Data Rate	NTX	CH.	Freq. (MHz)	Average Conducted Power (dBm)	Conducted Power Limit (dBm)	DG (dBi)	EIRP Power (dBm)	EIRP Power Limit (dBm)	Pass /Fail
BLE GFSK	1Mbps	1	2	2404	18.40	30.00	-6.10	12.30	36.00	Pass
BLE GFSK	1Mbps	1	38	2440	18.20	30.00	-6.10	12.10	36.00	Pass
BLE GFSK	1Mbps	1	76	2478	18.70	30.00	-6.10	12.60	36.00	Pass

TEST RESULTS DATA
Peak Power Density

Mod.	Data Rate	NTX	CH.	Freq. (MHz)	Peak PSD (dBm /100kHz)	Peak PSD (dBm /3kHz)	DG (dBi)	Peak PSD Limit (dBm /3kHz)	Pass/Fail
BLE GFSK	1Mbps	1	2	2404	18.19	0.30	-6.10	8.00	Pass
BLE GFSK	1Mbps	1	38	2440	18.50	0.64	-6.10	8.00	Pass
BLE GFSK	1Mbps	1	76	2478	18.77	0.16	-6.10	8.00	Pass

Note: PSD (dBm/ 100kHz) is a reference level used for Conducted Band Edges and Conducted Spurious Emission 30dBc limit.

TEST RESULTS DATA
6dB and 99% Occupied Bandwidth

Mod.	Data Rate	NTX	CH.	Freq. (MHz)	99% Occupied BW (MHz)	6dB BW (MHz)	6dB BW Limit (MHz)	Pass/Fail
BLE GFSK	2Mbps	1	2	2404	2.134	1.155	0.50	Pass
BLE GFSK	2Mbps	1	38	2440	2.130	1.175	0.50	Pass
BLE GFSK	2Mbps	1	76	2478	2.142	1.139	0.50	Pass

TEST RESULTS DATA
Average Power Table

Mod.	Data Rate	NTX	CH.	Freq. (MHz)	Average Conducted Power (dBm)	Conducted Power Limit (dBm)	DG (dBi)	EIRP Power (dBm)	EIRP Power Limit (dBm)	Pass /Fail
BLE GFSK	2Mbps	1	2	2404	18.50	30.00	-6.10	12.40	36.00	Pass
BLE GFSK	2Mbps	1	38	2440	18.30	30.00	-6.10	12.20	36.00	Pass
BLE GFSK	2Mbps	1	76	2478	18.80	30.00	-6.10	12.70	36.00	Pass

TEST RESULTS DATA
Peak Power Density

Mod.	Data Rate	NTX	CH.	Freq. (MHz)	Peak PSD (dBm /100kHz)	Peak PSD (dBm /3kHz)	DG (dBi)	Peak PSD Limit (dBm /3kHz)	Pass/Fail
BLE GFSK	2Mbps	1	2	2404	17.73	-4.15	-6.10	8.00	Pass
BLE GFSK	2Mbps	1	38	2440	16.78	-3.88	-6.10	8.00	Pass
BLE GFSK	2Mbps	1	76	2478	18.68	-3.25	-6.10	8.00	Pass

Note: PSD (dBm/ 100kHz) is a reference level used for Conducted Band Edges and Conducted Spurious Emission 30dBc limit.



6dB Bandwidth

<1Mbps>

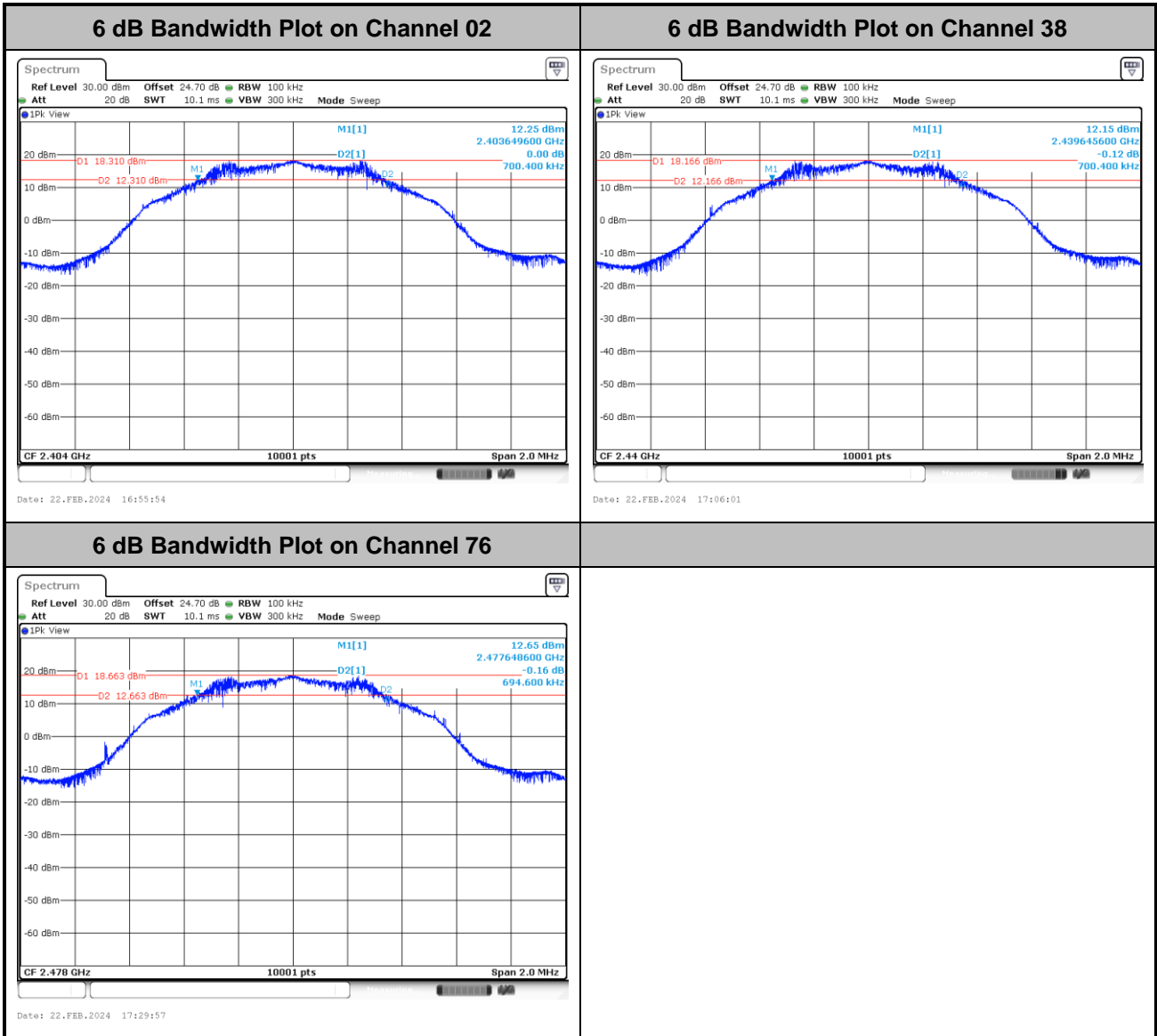



<2Mbps>

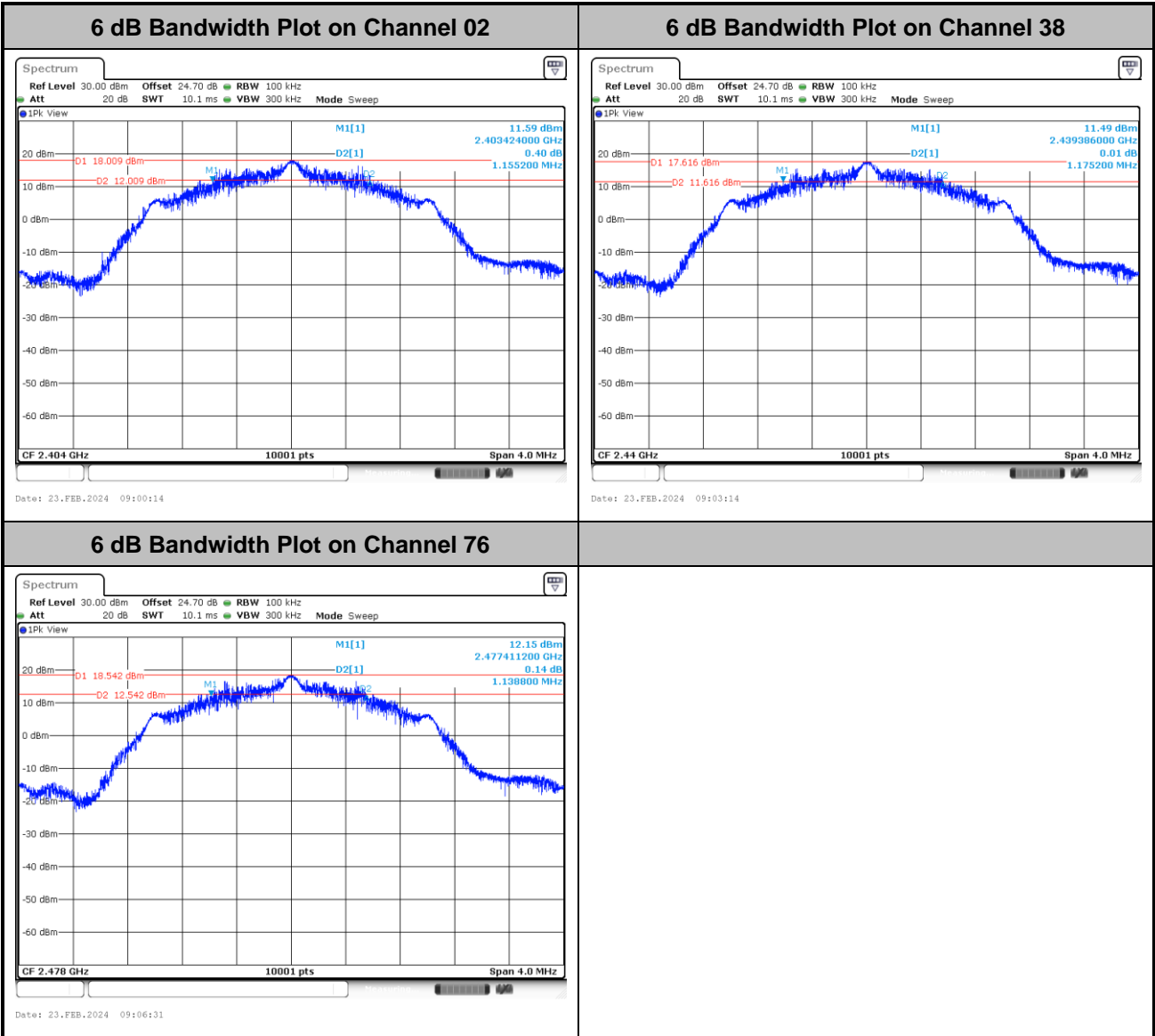



99% Occupied Bandwidth

<1Mbps>

99% Occupied Bandwidth Plot on Channel 02

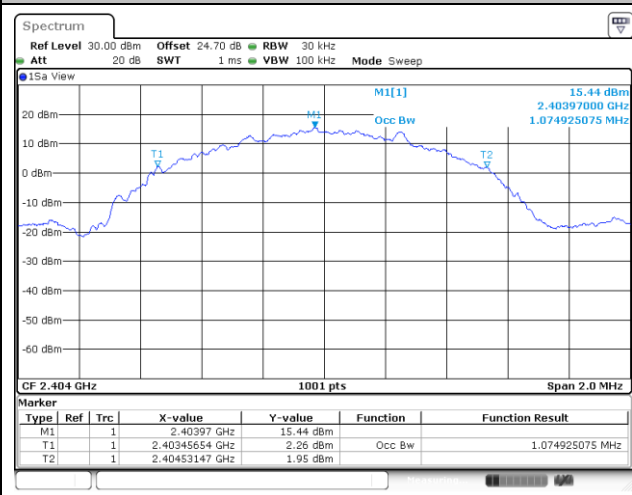

Date: 22.FEB.2024 16:55:02

99% Occupied Bandwidth Plot on Channel 38

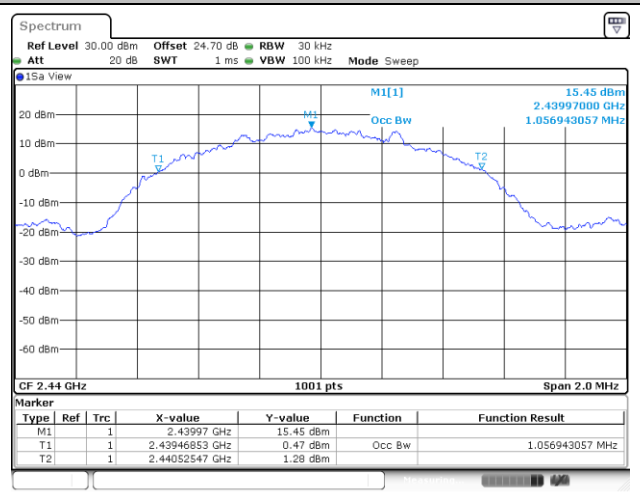

Date: 22.FEB.2024 17:06:18

99% Occupied Bandwidth Plot on Channel 76

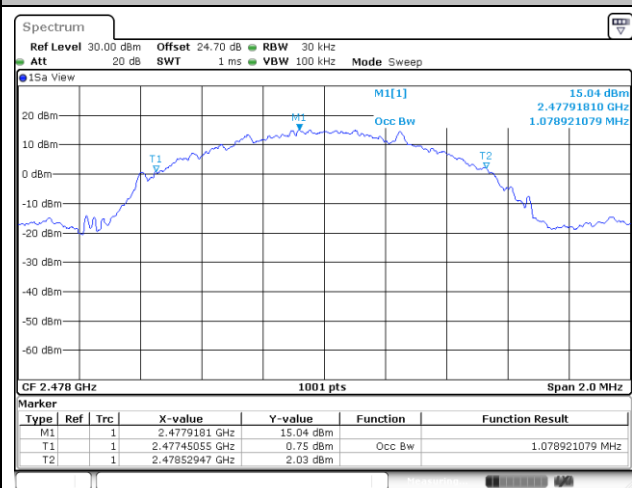

Date: 22.FEB.2024 17:29:16



<2Mbps>

99% Occupied Bandwidth Plot on Channel 02

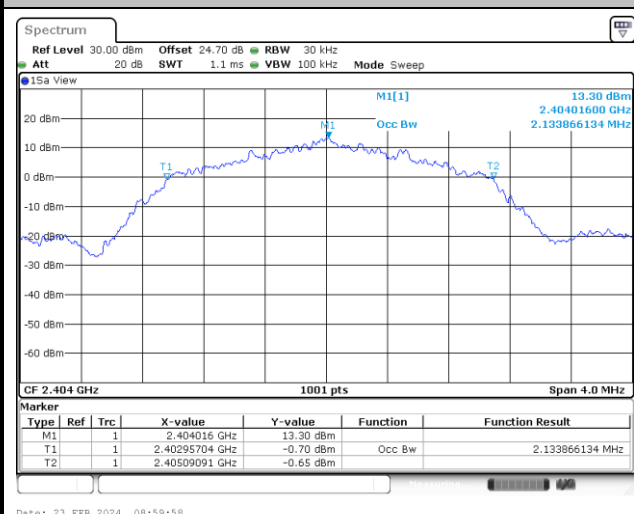

99% Occupied Bandwidth Plot on Channel 38

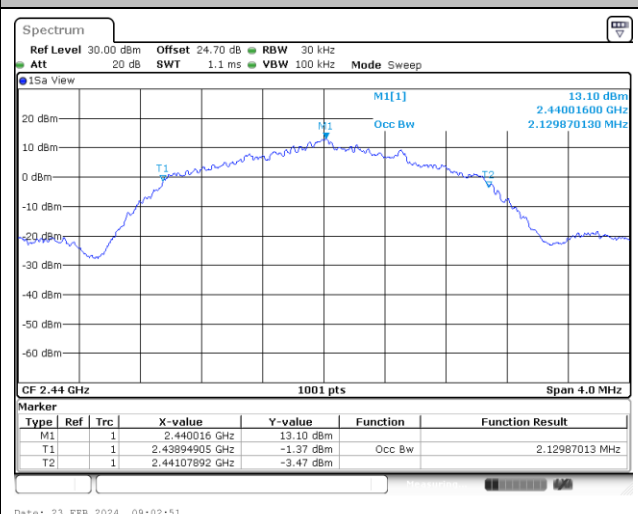

99% Occupied Bandwidth Plot on Channel 76

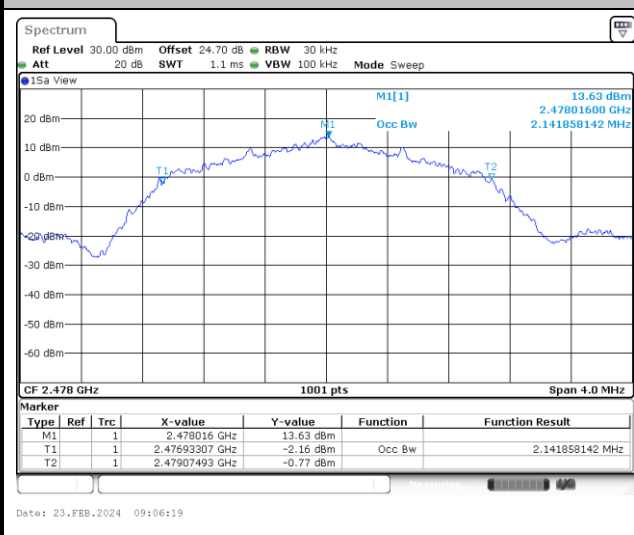



Power Spectral Density (dBm/3kHz)

<1Mbps>

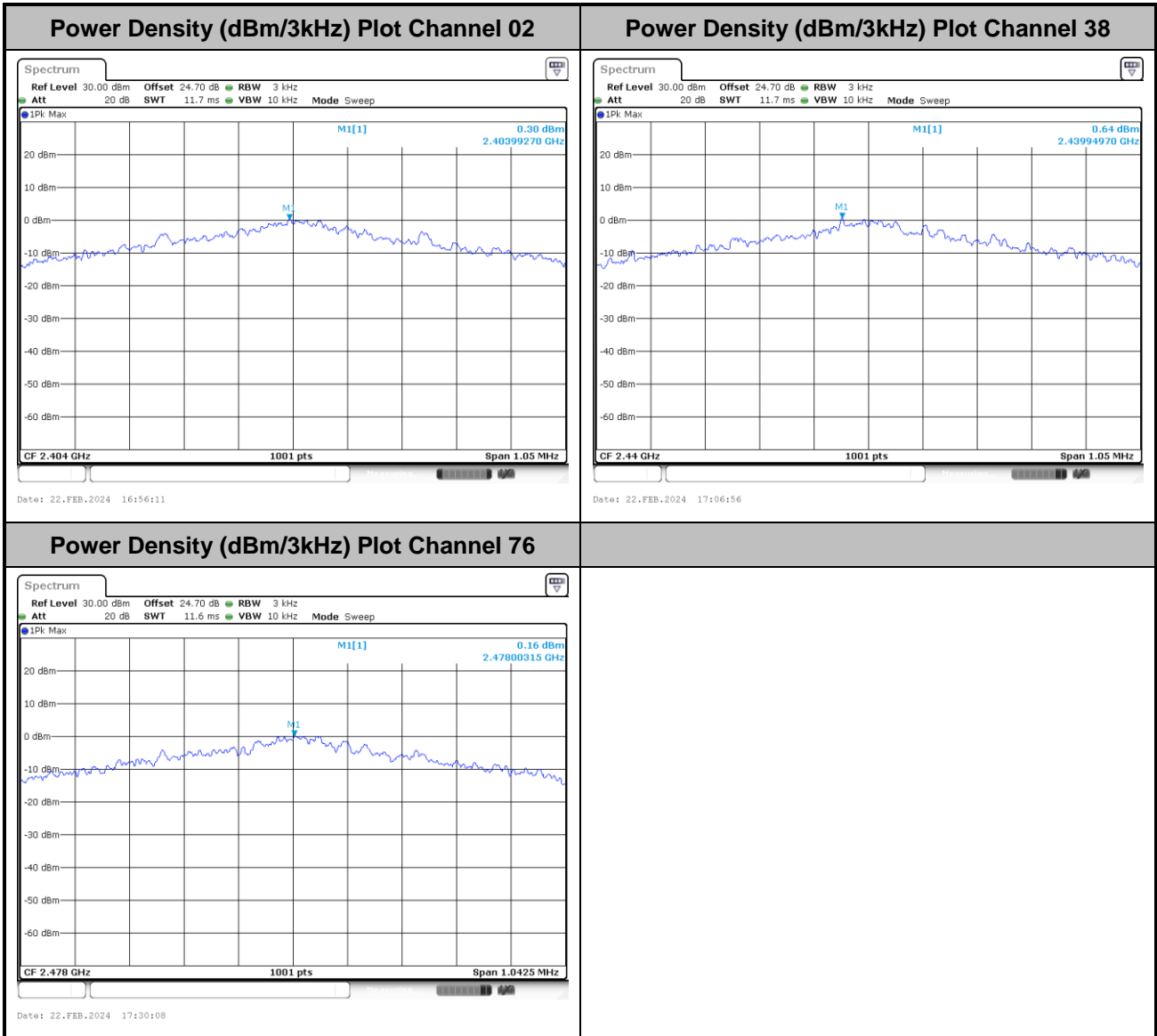



<2Mbps>

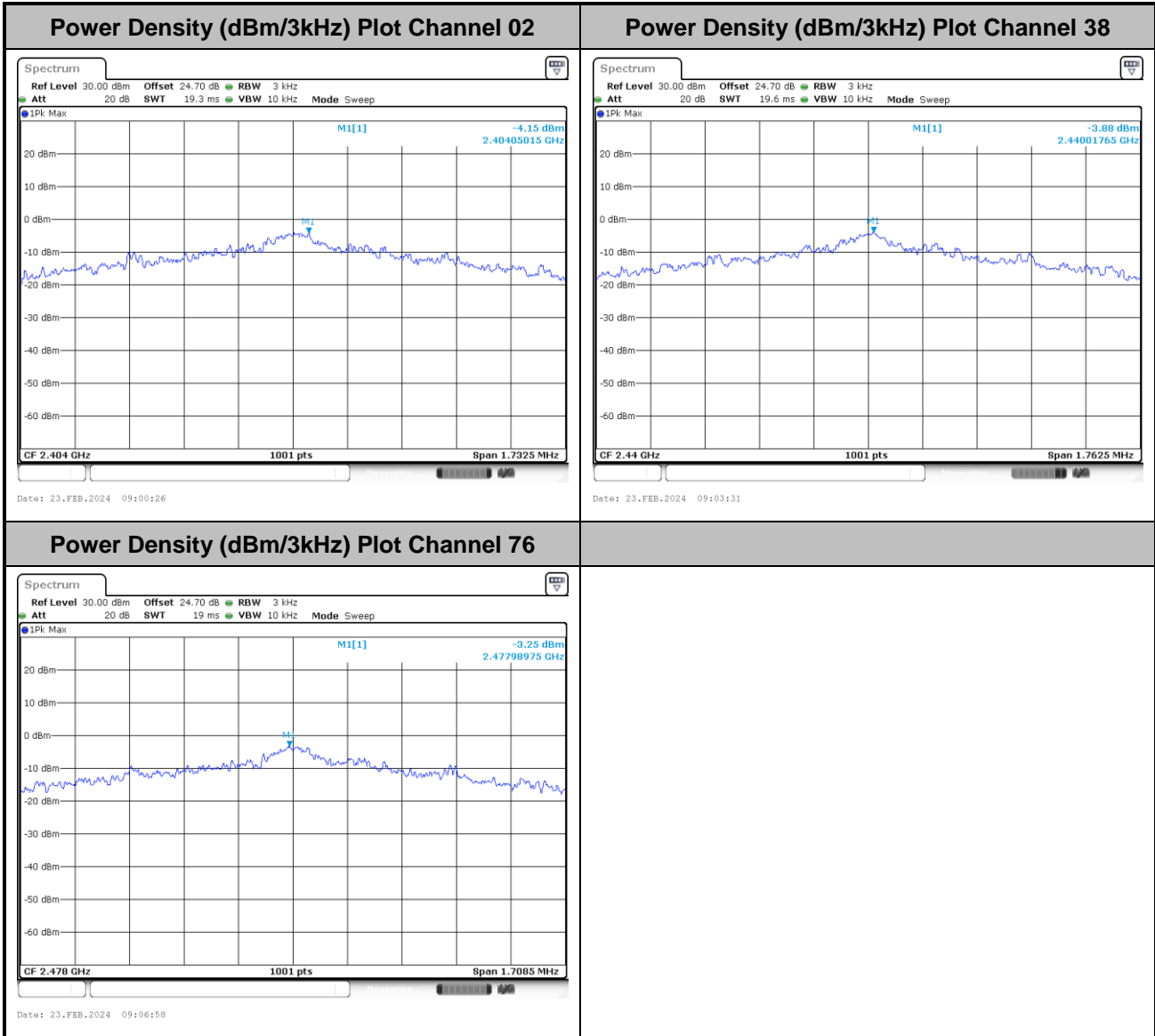



Band Edge and Conducted Spurious Emission

<1Mbps>

Channel 02

100kHz PSD reference Level Plot

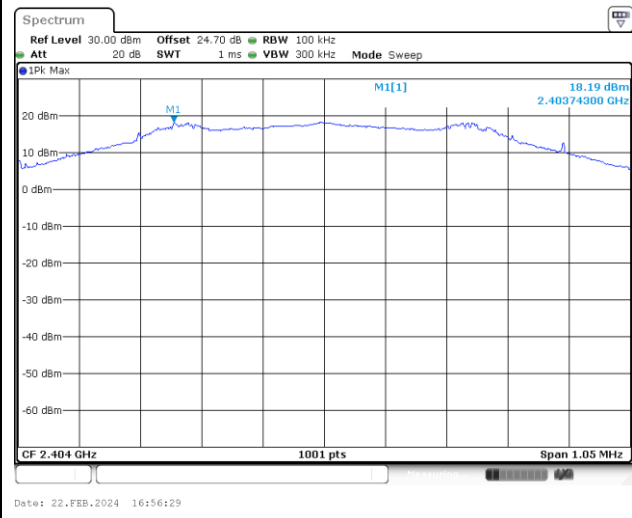

Low Channel Plot

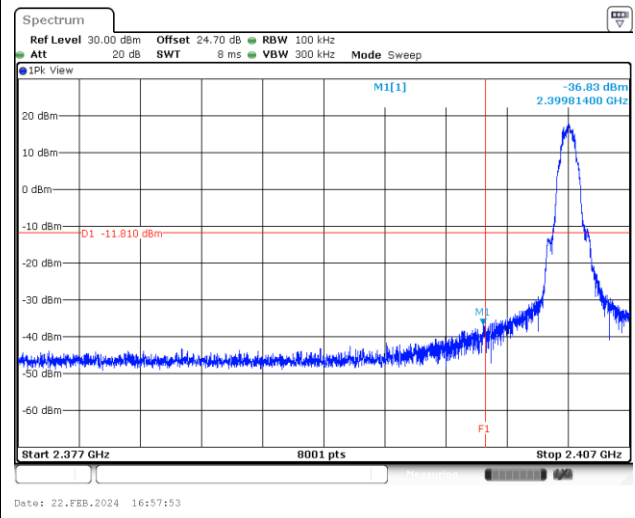

Spurious Emission 30MHz~1GHz Plot

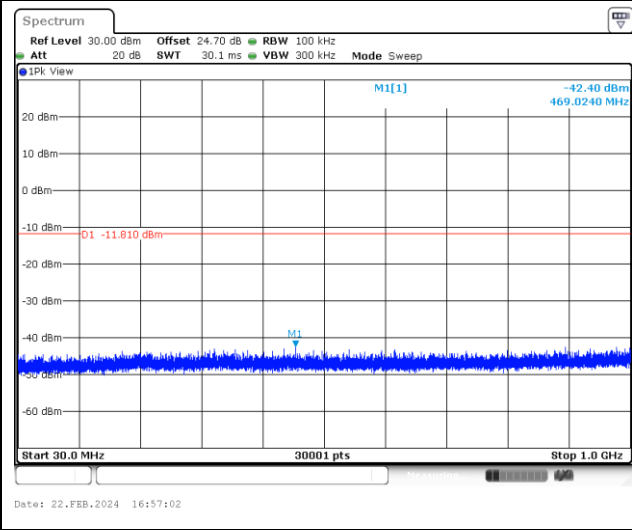

Spurious Emission 1GHz~26.5GHz Plot

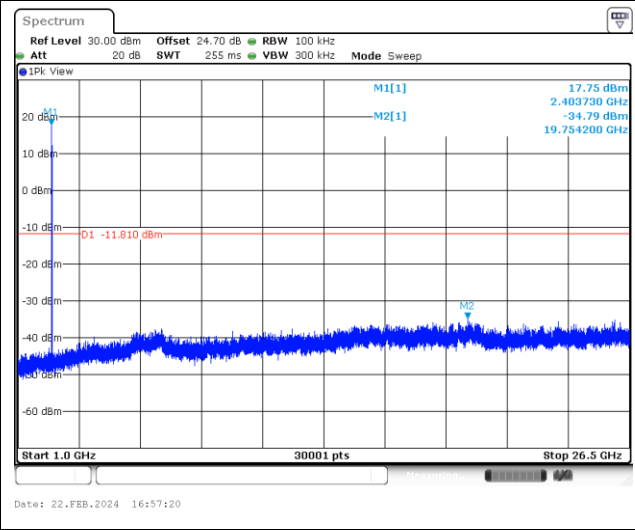



Channel 38

100kHz PSD reference Level Plot

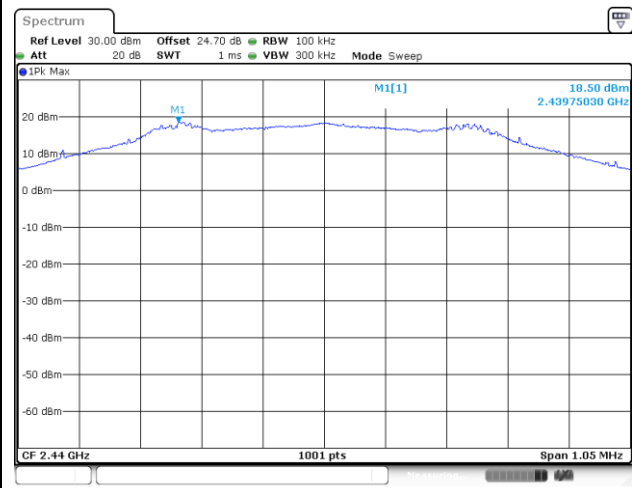

Date: 22.FEB.2024 17:07:23

Low Channel Plot

Spurious Emission 30MHz~1GHz Plot

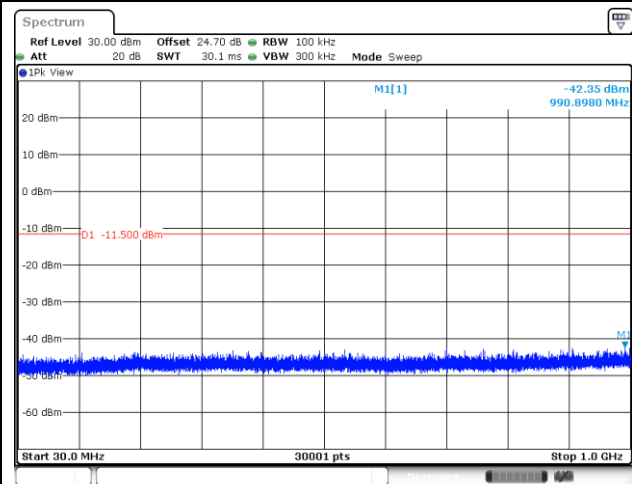

Date: 22.FEB.2024 17:07:49

Spurious Emission 1GHz~26.5GHz Plot

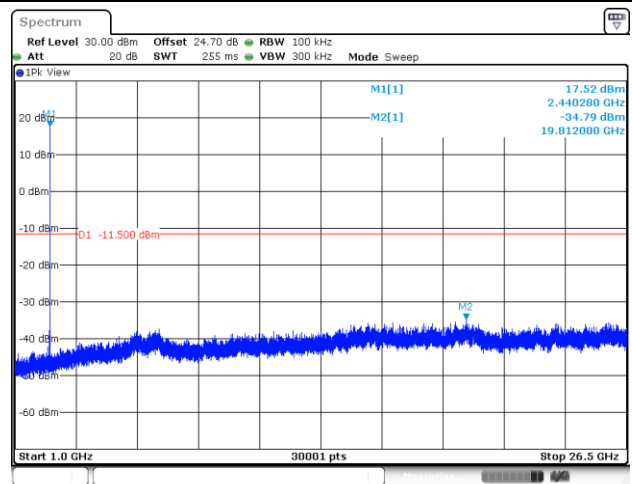

Date: 22.FEB.2024 17:08:06



Channel 76

100kHz PSD reference Level Plot

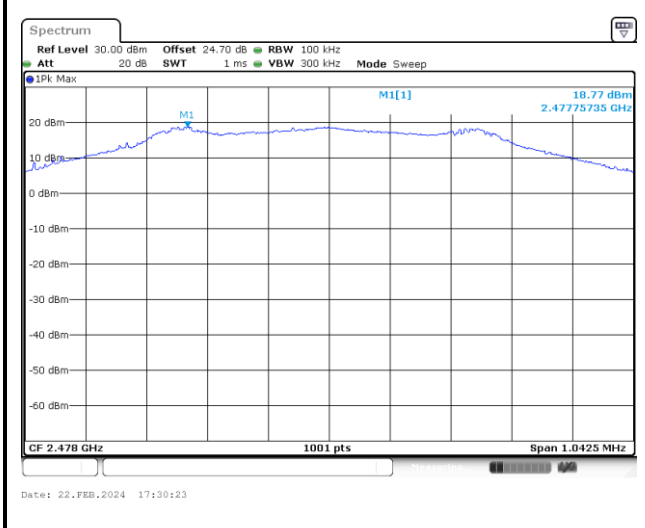

Low Channel Plot

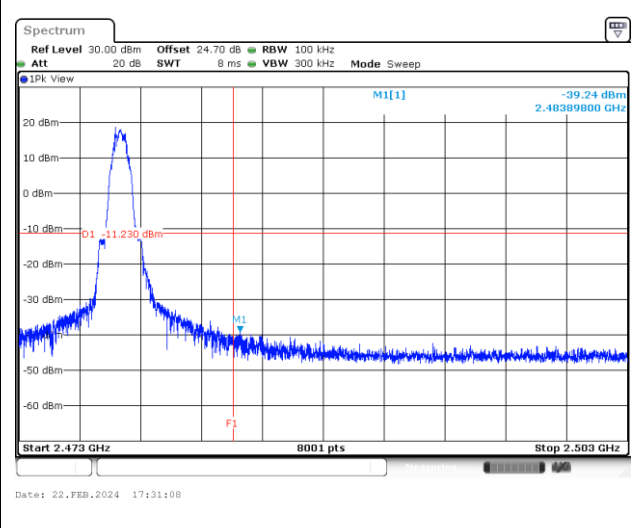

Spurious Emission 30MHz~1GHz Plot

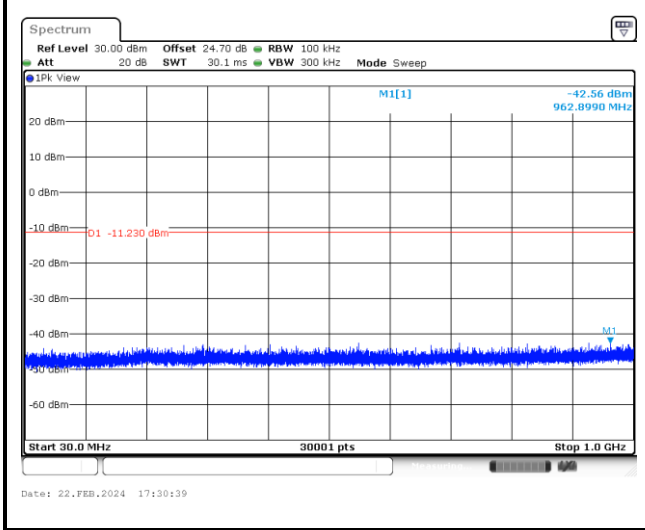

Spurious Emission 1GHz~26.5GHz Plot

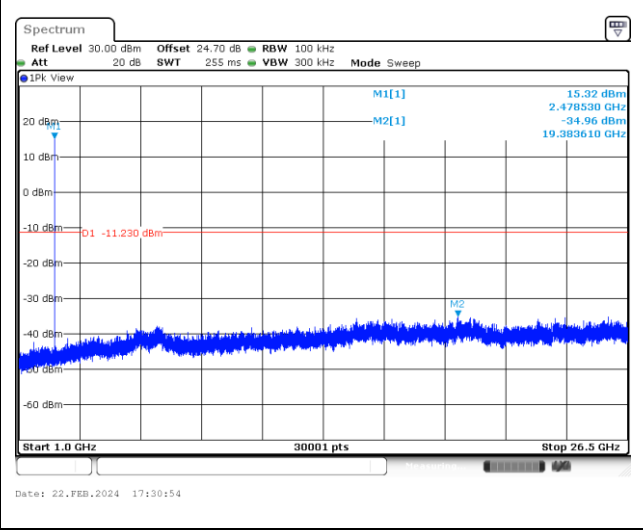



<2Mbps>

Channel 02

100kHz PSD reference Level Plot

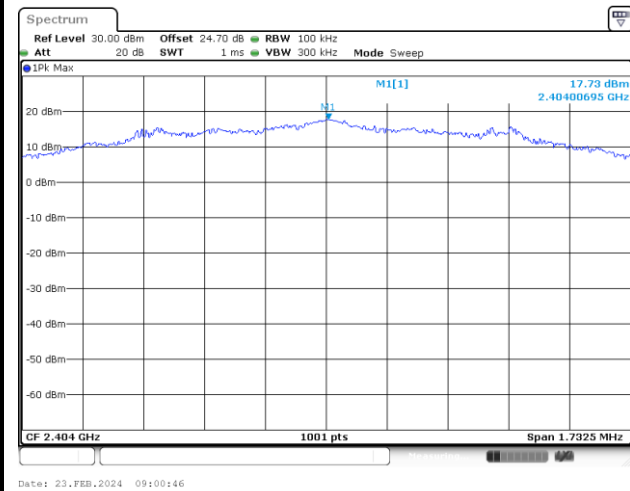

Date: 23.FEB.2024 09:00:46

Low Channel Plot

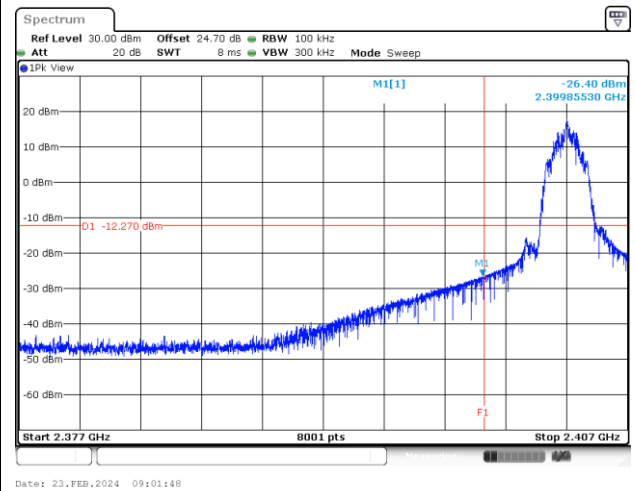

Date: 23.FEB.2024 09:01:48

Spurious Emission 30MHz~1GHz Plot

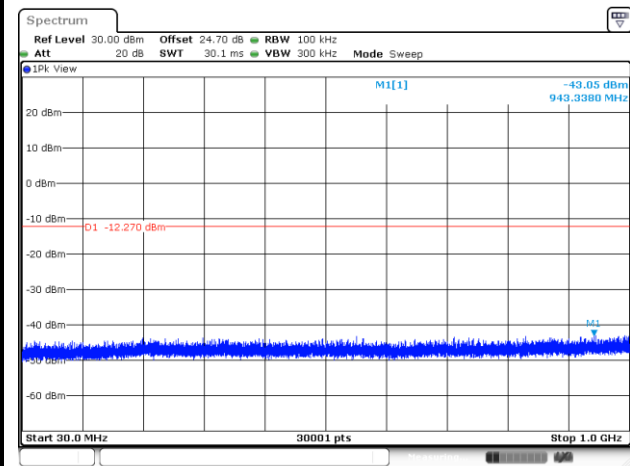

Date: 23.FEB.2024 09:01:10

Spurious Emission 1GHz~26.5GHz Plot

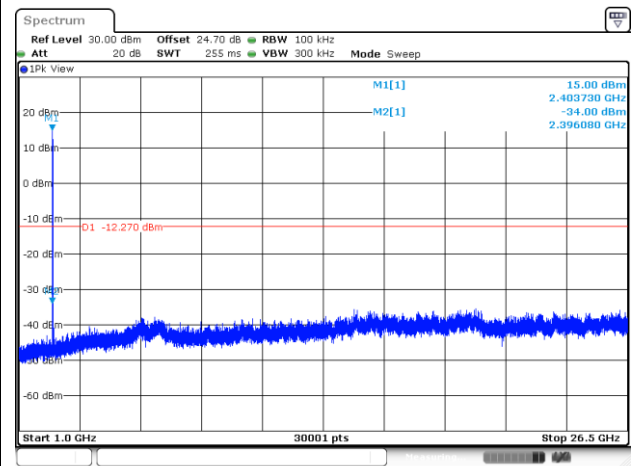

Date: 23.FEB.2024 09:01:25



Channel 38

100kHz PSD reference Level Plot

Low Channel Plot

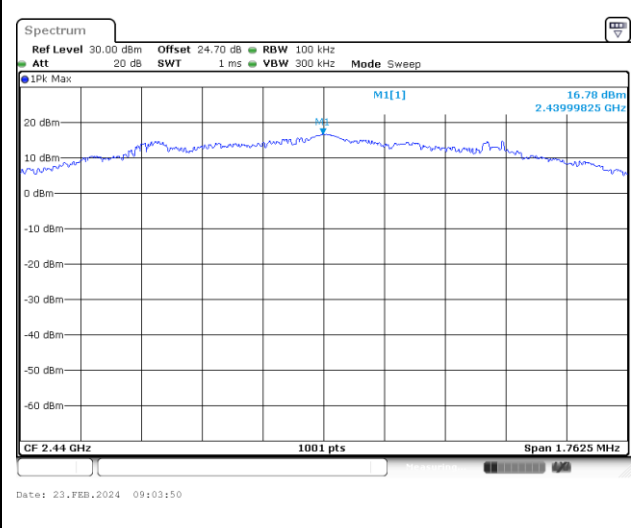

Spurious Emission 30MHz~1GHz Plot

Spurious Emission 1GHz~26.5GHz Plot

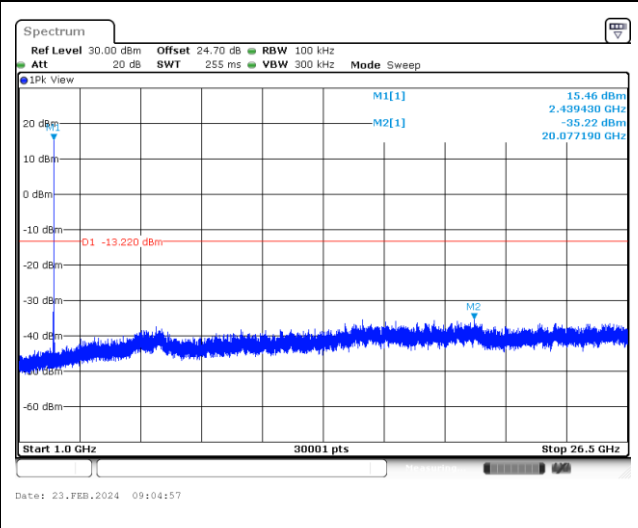
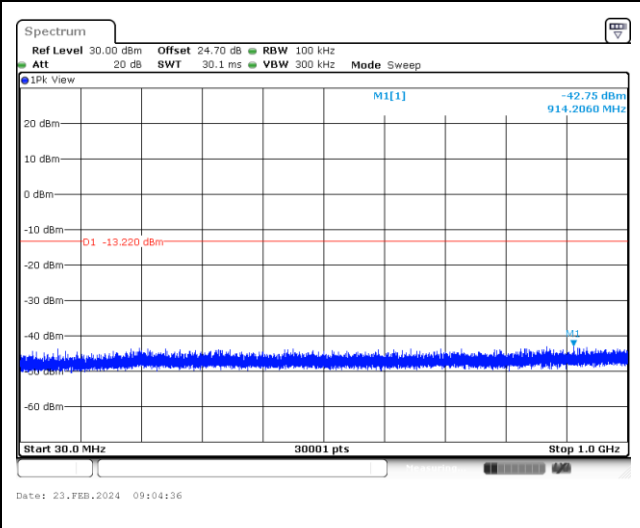



Channel 76

100kHz PSD reference Level Plot

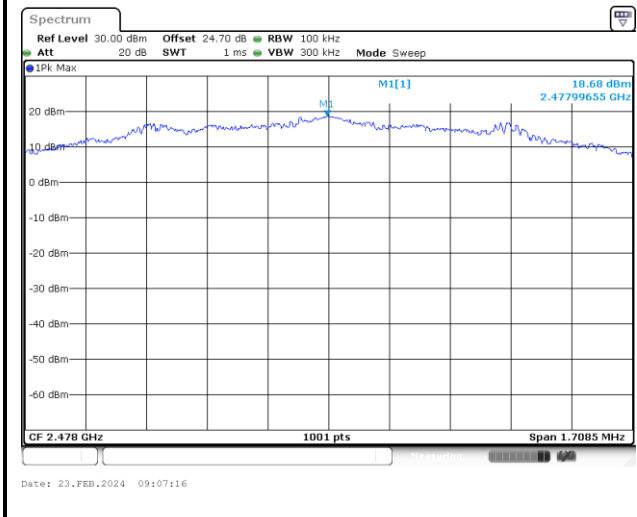

Low Channel Plot

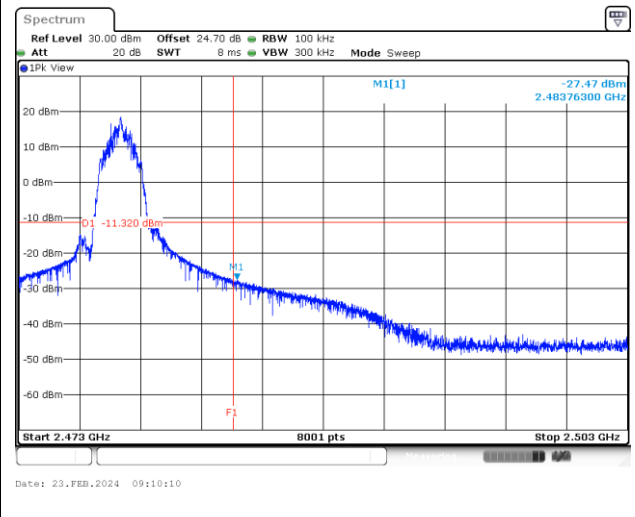

Spurious Emission 30MHz~1GHz Plot

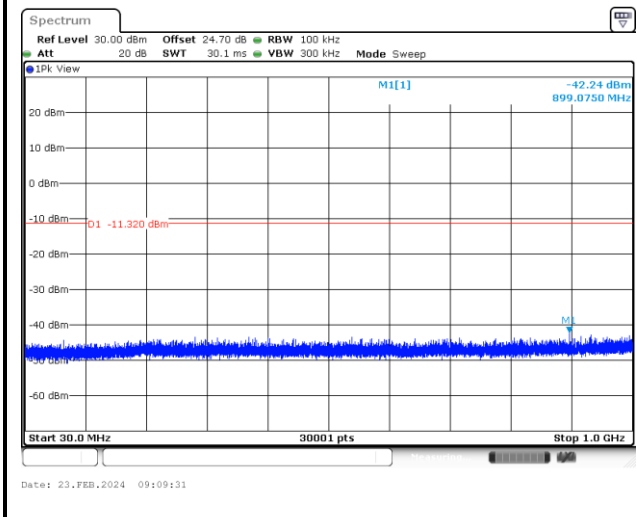

Spurious Emission 1GHz~26.5GHz Plot

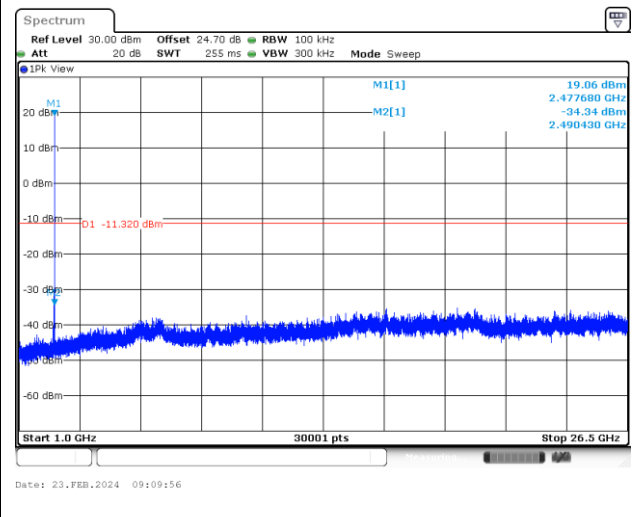



Appendix B. AC Conducted Emission Test Results

Test Engineer :	Louis Chung	Temperature :	20.5~21.7°C
		Relative Humidity :	41.2~46.4%

EUT Information

Report NO : 412509
 Test Mode : Mode 1
 Test Voltage : 120Vac/60Hz
 Phase : Line

Full Spectrum

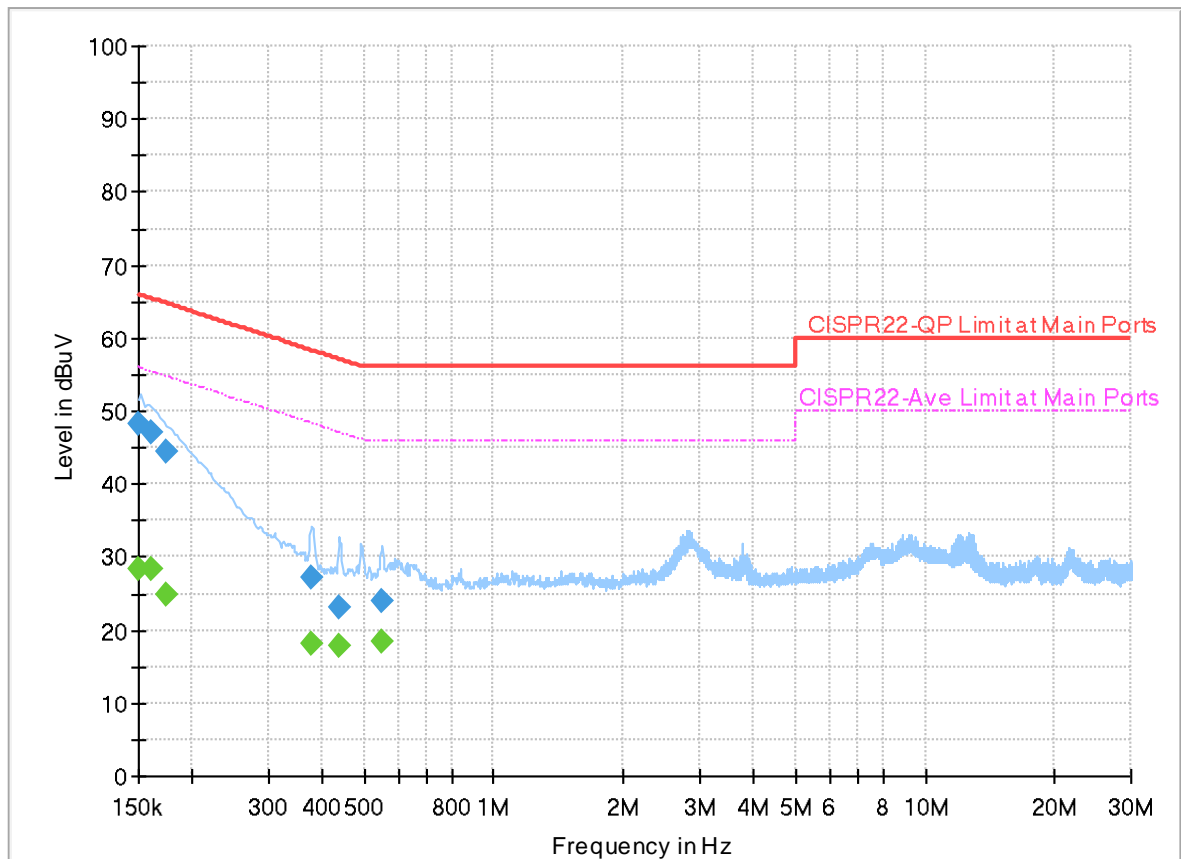

Final_Result

Frequency (MHz)	QuasiPeak (dBuV)	CAverage (dBuV)	Limit (dBuV)	Margin (dB)	Line	Filter	Corr. (dB)
0.150000	---	28.46	56.00	27.54	L1	OFF	19.9
0.150000	48.17	---	66.00	17.83	L1	OFF	19.9
0.161250	---	28.32	55.40	27.08	L1	OFF	19.9
0.161250	47.06	---	65.40	18.34	L1	OFF	19.9
0.173040	---	24.74	54.81	30.07	L1	OFF	19.9
0.173040	44.53	---	64.81	20.28	L1	OFF	19.9
0.379500	---	18.09	48.29	30.20	L1	OFF	19.9
0.379500	27.26	---	58.29	31.03	L1	OFF	19.9
0.435930	---	17.89	47.14	29.25	L1	OFF	19.9
0.435930	23.13	---	57.14	34.01	L1	OFF	19.9
0.550140	---	18.37	46.00	27.63	L1	OFF	19.9
0.550140	23.97	---	56.00	32.03	L1	OFF	19.9

EUT Information

Report NO : 412509
 Test Mode : Mode 1
 Test Voltage : 120Vac/60Hz
 Phase : Neutral

Full Spectrum

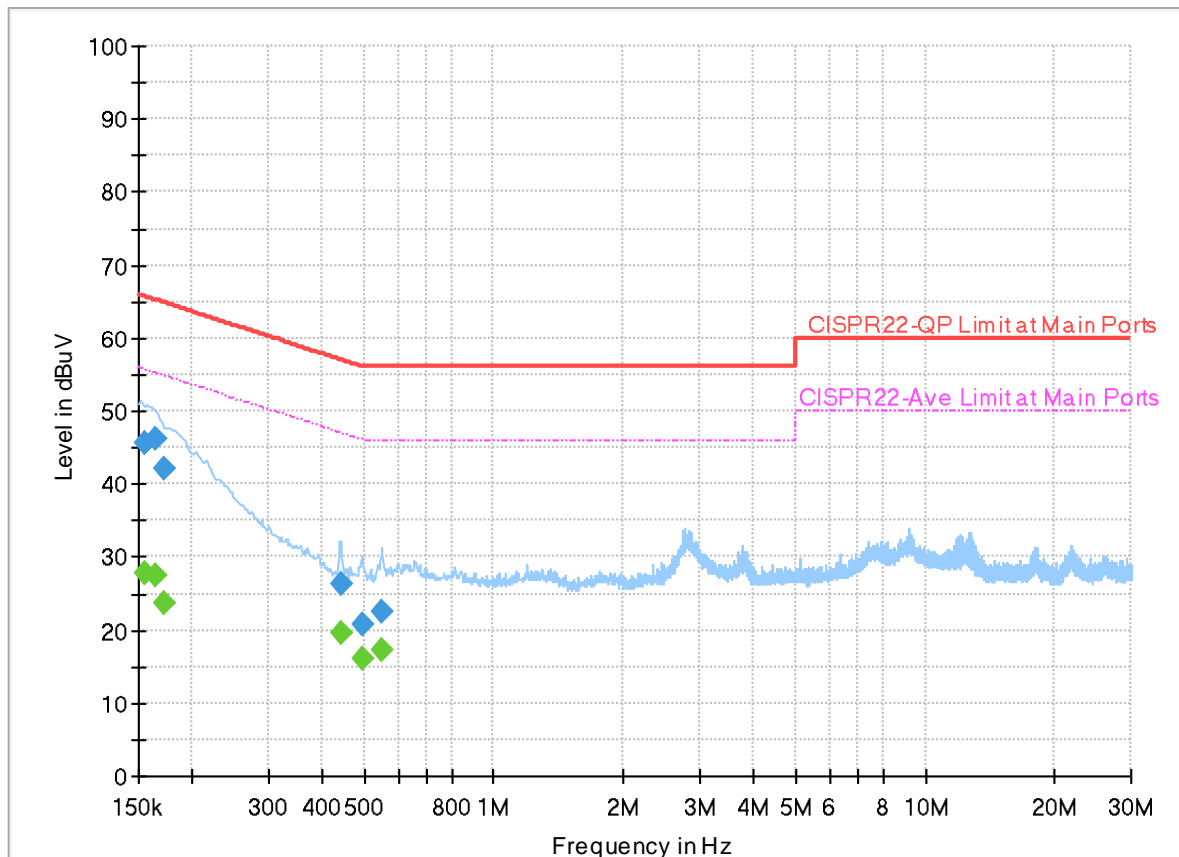

Final_Result

Frequency (MHz)	QuasiPeak (dBuV)	CAverage (dBuV)	Limit (dBuV)	Margin (dB)	Line	Filter	Corr. (dB)
0.155805	---	27.83	55.69	27.86	N	OFF	19.9
0.155805	45.64	---	65.69	20.05	N	OFF	19.9
0.163500	---	27.50	55.28	27.78	N	OFF	19.9
0.163500	46.12	---	65.28	19.16	N	OFF	19.9
0.172590	---	23.78	54.84	31.06	N	OFF	19.9
0.172590	42.15	---	64.84	22.69	N	OFF	19.9
0.440610	---	19.52	47.05	27.53	N	OFF	19.9
0.440610	26.29	---	57.05	30.76	N	OFF	19.9
0.498750	---	16.10	46.02	29.92	N	OFF	19.9
0.498750	20.64	---	56.02	35.38	N	OFF	19.9
0.552570	---	17.23	46.00	28.77	N	OFF	19.9
0.552570	22.64	---	56.00	33.36	N	OFF	19.9



Appendix C. Radiated Spurious Emission

Test Engineer :	Fu Chen, Sam Chou and Troye Hsieh	Temperature :	18.9~22.1°C
		Relative Humidity :	43.7~67.1%

<GFSK 1Mbps>

2.4GHz 2400~2483.5MHz

BLE (Band Edge @ 3m)

BLE	Note	Frequency	Level	Margin	Limit	Read	Antenna	Path	Preamp	Ant	Table	Peak	Pol.	
		(MHz)	(dBμV/m)	(dB)	(dBμV/m)	(dBμV)	(dB/m)	(dB)	(dB)	(cm)	(deg)	(P/A)	(H/V)	
BLE CH 02 2404MHz		2332.89	51	-23	74	41.89	27.23	16.67	34.79	150	158	P	H	
		2338.665	44.73	-9.27	54	35.56	27.29	16.67	34.79	150	158	A	H	
	*	2404	106.59	-	-	97.16	27.5	16.73	34.8	150	158	P	H	
	*	2404	105.72	-	-	96.29	27.5	16.73	34.8	150	158	A	H	
													H	
														H
			2366.28	50.57	-23.43	74	41.37	27.3	16.69	34.79	250	271	P	V
			2390	45.29	-8.71	54	35.88	27.5	16.71	34.8	250	271	A	V
	*		2404	108.62	-	-	99.19	27.5	16.73	34.8	250	271	P	V
	*		2404	107.81	-	-	98.38	27.5	16.73	34.8	250	271	A	V
														V
														V
BLE CH 38 2440MHz		2348.24	50.62	-23.38	74	41.43	27.3	16.68	34.79	150	158	P	H	
		2381.84	44.55	-9.45	54	35.22	27.42	16.71	34.8	150	158	A	H	
	*	2440	106.5	-	-	96.92	27.6	16.78	34.8	150	158	P	H	
	*	2440	105.56	-	-	95.98	27.6	16.78	34.8	150	158	A	H	
			2484.16	50.53	-23.47	74	40.79	27.7	16.84	34.8	150	158	P	H
			2484.24	44.53	-9.47	54	34.79	27.7	16.84	34.8	150	158	A	H
			2345.04	51.31	-22.69	74	42.12	27.3	16.68	34.79	250	271	P	V
			2388.24	44.72	-9.28	54	35.33	27.48	16.71	34.8	250	271	A	V
	*		2440	110.29	-	-	100.71	27.6	16.78	34.8	250	271	P	V
	*		2440	109.43	-	-	99.85	27.6	16.78	34.8	250	271	A	V
			2498.88	50.59	-23.41	74	40.83	27.7	16.86	34.8	250	271	P	V
			2493.2	44.43	-9.57	54	34.67	27.7	16.86	34.8	250	271	A	V



BLE CH 76 2478MHz	*	2478	104.02	-	-	94.31	27.68	16.83	34.8	250	313	P	H
	*	2478	103.16	-	-	93.45	27.68	16.83	34.8	250	313	A	H
		2487.72	51.24	-22.76	74	41.49	27.7	16.85	34.8	250	313	P	H
		2495.24	45.25	-8.75	54	35.49	27.7	16.86	34.8	250	313	A	H
													H
													H
	*	2478	107.69	-	-	97.98	27.68	16.83	34.8	300	277	P	V
	*	2478	107.04	-	-	97.33	27.68	16.83	34.8	300	277	A	V
		2495.84	51.64	-22.36	74	41.88	27.7	16.86	34.8	300	277	P	V
		2493.72	45.27	-8.73	54	35.51	27.7	16.86	34.8	300	277	A	V
													V
													V
Remark	1. No other spurious found. 2. All results are PASS against Peak and Average limit line.												



2.4GHz 2400~2483.5MHz
BLE (Harmonic @ 3m)

BLE	Note	Frequency	Level	Margin	Limit	Read	Antenna	Path	Preamp	Ant	Table	Peak	Pol.
		(MHz)	(dBμV/m)	(dB)	(dBμV/m)	(dBμV)	(dB/m)	(dB)	(dB)	(cm)	(deg)	(P/A)	(H/V)
BLE CH 02 2404MHz		4808	40.85	-33.15	74	54.39	32.45	11.81	57.8	-	-	P	H
													H
													H
													H
													H
													H
													H
													H
													H
													H
													H
													H
													H
													H
													H
													H
													H
													H
													H
			4808	40.48	-33.52	74	54.02	32.45	11.81	57.8	-	-	P
													V
													V
													V
													V
													V
													V
													V
													V
													V
													V
													V
													V
													V
													V



BLE	Note	Frequency	Level	Margin	Limit	Read	Antenna	Path	Preamp	Ant	Table	Peak	Pol.
		(MHz)	(dBμV/m)	(dB)	(dBμV/m)	(dBμV)	(dB/m)	(dB)	(dB)	(cm)	(deg)	(P/A)	(H/V)
BLE CH 38 2440MHz		4880	41.1	-32.9	74	54.41	32.7	11.81	57.82	-	-	P	H
		7320	44.77	-29.23	74	51.63	36.82	14.77	58.45	-	-	P	H
													H
													H
													H
													H
													H
													H
													H
													H
													H
													H
													H
													H
													H
													H
													H
													H
													H
			4880	41.15	-32.85	74	54.46	32.7	11.81	57.82	-	-	P
		7320	45.13	-28.87	74	51.99	36.82	14.77	58.45	-	-	P	V
													V
													V
													V
													V
													V
													V
													V
													V
													V
													V
													V
													V
													V
													V
													V



BLE	Note	Frequency	Level	Margin	Limit	Read	Antenna	Path	Preamp	Ant	Table	Peak	Pol.
		(MHz)	(dBμV/m)	(dB)	(dBμV/m)	(dBμV)	(dB/m)	(dB)	(dB)	(cm)	(deg)	(P/A)	(H/V)
BLE CH 76 2478MHz		4956	41.84	-32.16	74	54.86	33.02	11.81	57.85	-	-	P	H
		7434	43.48	-30.52	74	50.66	36.33	14.9	58.41	-	-	P	H
													H
													H
													H
													H
													H
													H
													H
													H
													H
													H
													H
													H
													H
													H
													H
													H
													H
			4956	41.91	-32.09	74	54.93	33.02	11.81	57.85	-	-	P
		7434	44.23	-29.77	74	51.41	36.33	14.9	58.41	-	-	P	V
													V
													V
													V
													V
													V
													V
													V
													V
													V
													V
													V
													V
													V
Remark	<ol style="list-style-type: none"> No other spurious found. All results are PASS against Peak and Average limit line. The emission position marked as "-" means no suspected emission found with sufficient margin against limit line or noise floor only. 												



<GFSK 2Mbps>

2.4GHz 2400~2483.5MHz

BLE (Band Edge @ 3m)

BLE	Note	Frequency	Level	Margin	Limit	Read	Antenna	Path	Preamp	Ant	Table	Peak	Pol.	
					Line	Level	Factor	Loss	Factor	Pos	Pos	Avg.		
		(MHz)	(dBμV/m)	(dB)	(dBμV/m)	(dBμV)	(dB/m)	(dB)	(dB)	(cm)	(deg)	(P/A)	(H/V)	
BLE CH 02 2404MHz		2336.46	50.68	-23.32	74	41.54	27.26	16.67	34.79	200	154	P	H	
		2387.595	44.64	-9.36	54	35.25	27.48	16.71	34.8	200	154	A	H	
	*	2404	109.31	-	-	99.88	27.5	16.73	34.8	200	154	P	H	
	*	2404	107.22	-	-	97.79	27.5	16.73	34.8	200	154	A	H	
													H	
													H	
			2334.78	50.92	-23.08	74	41.79	27.25	16.67	34.79	400	268	P	V
			2320.395	45.13	-8.87	54	35.96	27.3	16.66	34.79	400	268	A	V
	*		2404	112.74	-	-	103.31	27.5	16.73	34.8	400	268	P	V
	*		2404	110.2	-	-	100.77	27.5	16.73	34.8	400	268	A	V
													V	
												V		
BLE CH 38 2440MHz		2375.28	51.91	-22.09	74	42.66	27.35	16.7	34.8	350	144	P	H	
		2330.8	45.64	-8.36	54	36.55	27.21	16.67	34.79	350	144	A	H	
	*	2440	106.11	-	-	96.53	27.6	16.78	34.8	350	144	P	H	
	*	2440	106.17	-	-	96.59	27.6	16.78	34.8	350	144	A	H	
			2484.48	50.7	-23.3	74	40.96	27.7	16.84	34.8	350	144	P	H
			2490.08	46.51	-7.49	54	36.76	27.7	16.85	34.8	350	144	A	H
			2340.08	51.05	-22.95	74	41.86	27.3	16.68	34.79	200	290	P	V
			2365.36	45.39	-8.61	54	36.19	27.3	16.69	34.79	200	290	A	V
	*		2440	111.23	-	-	101.65	27.6	16.78	34.8	200	290	P	V
	*		2440	110.25	-	-	100.67	27.6	16.78	34.8	200	290	A	V
			2483.84	51.21	-22.79	74	41.47	27.7	16.84	34.8	200	290	P	V
		2492.4	45.71	-8.29	54	35.96	27.7	16.85	34.8	200	290	A	V	



BLE CH 76 2478MHz	*	2478	108.78	-	-	99.07	27.68	16.83	34.8	250	331	P	H
	*	2478	107.73	-	-	98.02	27.68	16.83	34.8	250	331	A	H
		2486.32	51.01	-22.99	74	41.26	27.7	16.85	34.8	250	331	P	H
		2487.68	46.16	-7.84	54	36.41	27.7	16.85	34.8	250	331	A	H
													H
													H
	*	2478	112.33	-	-	102.62	27.68	16.83	34.8	300	274	P	V
	*	2478	110.19	-	-	100.48	27.68	16.83	34.8	300	274	A	V
		2483.72	51.57	-22.43	74	41.83	27.7	16.84	34.8	300	274	P	V
		2483.8	46.8	-7.2	54	37.06	27.7	16.84	34.8	300	274	A	V
													V
													V
Remark	<ol style="list-style-type: none"> 1. No other spurious found. 2. All results are PASS against Peak and Average limit line. 												



2.4GHz 2400~2483.5MHz
BLE (Harmonic @ 3m)

BLE	Note	Frequency	Level	Margin	Limit	Read	Antenna	Path	Preamp	Ant	Table	Peak	Pol.	
		(MHz)	(dBμV/m)	(dB)	(dBμV/m)	(dBμV)	(dB/m)	(dB)	(dB)	(cm)	(deg)	(P/A)	(H/V)	
BLE CH 02 2404MHz		4808	40.51	-33.49	74	54.05	32.45	11.81	57.8	-	-	P	H	
													H	
													H	
													H	
													H	
													H	
													H	
													H	
													H	
													H	
													H	
													H	
													H	
													H	
													H	
													H	
													H	
			4808	41.54	-32.46	74	55.08	32.45	11.81	57.8	-	-	P	V
														V
														V
													V	
													V	
													V	
													V	
													V	
													V	
													V	



BLE	Note	Frequency	Level	Margin	Limit	Read	Antenna	Path	Preamp	Ant	Table	Peak	Pol.
		(MHz)	(dBμV/m)	(dB)	(dBμV/m)	(dBμV)	(dB/m)	(dB)	(dB)	(cm)	(deg)	(P/A)	(H/V)
BLE CH 38 2440MHz		4880	41.7	-32.3	74	55.01	32.7	11.81	57.82	-	-	P	H
		7320	44.62	-29.38	74	51.48	36.82	14.77	58.45	-	-	P	H
													H
													H
													H
													H
													H
													H
													H
													H
													H
													H
													H
													H
													H
													H
													H
													H
													H
			4880	41.24	-32.76	74	54.55	32.7	11.81	57.82	-	-	P
		7320	45.01	-28.99	74	51.87	36.82	14.77	58.45	-	-	P	V
													V
													V
													V
													V
													V
													V
													V
													V
													V
													V
													V
													V
													V
													V
													V



Emission above 18GHz

2.4GHz BLE (SHF)

BLE	Note	Frequency	Level	Margin	Limit	Read	Antenna	Path	Preamp	Ant	Table	Peak	Pol.
		(MHz)	(dBμV/m)	(dB)	(dBμV/m)	(dBμV)	(dB/m)	(dB)	(dB)	(cm)	(deg)	(P/A)	(H/V)
2.4GHz BLE SHF		23670	38.89	-35.11	74	37.79	38.82	16.38	54.1	-	-	P	H
													H
													H
													H
													H
													H
													H
													H
													H
													H
													H
													H
													H
													H
													H
													H
													H
													H
													H
			24937	38.75	-35.25	74	35.13	39.27	17.68	53.33	-	-	P
													V
													V
													V
													V
													V
													V
													V
													V
													V
													V
													V
													V
													V
													V
Remark	1. No other spurious found. 2. All results are PASS against limit line. 3. The emission position marked as "-" means no suspected emission found with sufficient margin against limit line or noise floor only.												



Emission below 1GHz

2.4GHz BLE (LF)

BLE	Note	Frequency	Level	Margin	Limit	Read	Antenna	Path	Preamp	Ant	Table	Peak	Pol.	
		(MHz)	(dBμV/m)	(dB)	(dBμV/m)	(dBμV)	(dB/m)	(dB)	(dB)	(cm)	(deg)	(P/A)	(H/V)	
2.4GHz BLE LF		30	33.68	-6.32	40	41.47	24	0.67	32.46	-	-	P	H	
		165.54	25.41	-18.09	43.5	40.02	15.8	1.71	32.12	-	-	P	H	
		210.63	25.85	-17.65	43.5	41.37	14.86	1.94	32.32	-	-	P	H	
		745.9	32.73	-13.27	46	32.41	27.97	3.89	31.54	-	-	P	H	
		957.3	34.17	-11.83	46	29.6	30.93	4.55	30.91	-	-	P	H	
		972.7	35.26	-18.74	54	30.29	31.1	4.59	30.72	-	-	P	H	
														H
														H
														H
														H
														H
														H
			30.81	32.57	-7.43	40	40.62	23.74	0.66	32.45	-	-	P	V
			43.77	32.89	-7.11	40	47.02	17.48	0.68	32.29	-	-	P	V
			65.91	32.4	-7.6	40	51.81	11.79	0.92	32.12	-	-	P	V
			924.4	33.38	-12.62	46	30.82	29.37	4.45	31.26	-	-	P	V
			952.4	34.68	-11.32	46	30.39	30.71	4.55	30.97	-	-	P	V
			974.8	34.87	-19.13	54	29.96	31.02	4.59	30.7	-	-	P	V
														V
														V
													V	
													V	
													V	
													V	
Remark	1. No other spurious found. 2. All results are PASS against limit line. 3. The emission position marked as "-" means no suspected emission found and emission level has at least 6dB margin against limit or emission is noise floor only.													



Note symbol

*	Fundamental Frequency which can be ignored. However, the level of any unwanted emissions shall not exceed the level of the fundamental frequency.
!	Test result is Margin line.
P/A	Peak or Average
H/V	Horizontal or Vertical



A calculation example for radiated spurious emission is shown as below:

BLE	Note	Frequency	Level	Margin	Limit	Read	Antenna	Path	Preamp	Ant	Table	Peak	Pol.
		(MHz)	(dBμV/m)	(dB)	(dBμV/m)	(dBμV)	(dB/m)	(dB)	(dB)	(cm)	(deg)	(P/A)	(H/V)
BLE CH 00 2402MHz		2390	55.45	-18.55	74	54.51	32.22	4.58	35.86	103	308	P	H
		2390	43.54	-10.46	54	42.6	32.22	4.58	35.86	103	308	A	H

1. Path Loss(dB) = Cable loss(dB) + Filter loss(dB) + Attenuator loss(dB)
2. Level(dBμV/m) =
Antenna Factor(dB/m) + Path Loss(dB) + Read Level(dBμV) - Preamp Factor(dB)
3. Margin (dB) = Level(dBμV/m) – Limit Line(dBμV/m)

For Peak Limit @ 2390MHz:

1. Level(dBμV/m)
= Antenna Factor(dB/m) + Path Loss(dB) + Read Level(dBμV) - Preamp Factor(dB)
= 32.22(dB/m) + 4.58(dB) + 54.51(dBμV) – 35.86 (dB)
= 55.45 (dBμV/m)
2. Margin (dB)
= Level(dBμV/m) – Limit Line(dBμV/m)
= 55.45(dBμV/m) – 74(dBμV/m)
= -18.55(dB)

For Average Limit @ 2390MHz:

1. Level(dBμV/m)
= Antenna Factor(dB/m) + Path Loss(dB) + Read Level(dBμV) - Preamp Factor(dB)
= 32.22(dB/m) + 4.58(dB) + 42.6(dBμV) – 35.86 (dB)
= 43.54 (dBμV/m)
2. Margin (dB)
= Level(dBμV/m) – Limit Line(dBμV/m)
= 43.54(dBμV/m) – 54(dBμV/m)
= -10.46(dB)

Both peak and average measured complies with the limit line, so test result is “PASS”.



Appendix D. Radiated Spurious Emission Plots

Test Engineer :	Fu Chen, Sam Chou and Troye Hsieh	Temperature :	18.9~22.1°C
		Relative Humidity :	43.7~67.1%

Note symbol

-L	Low channel location
-R	High channel location



<GFSK 1Mbps>

2.4GHz 2400~2483.5MHz

BLE (Band Edge @ 3m)

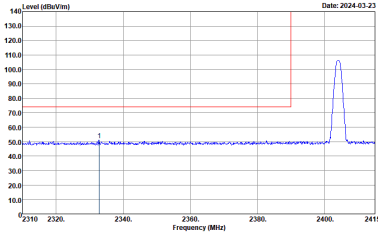
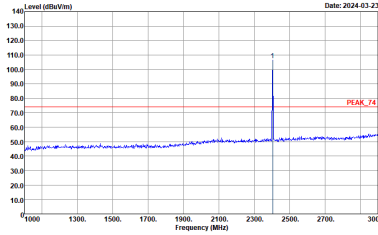
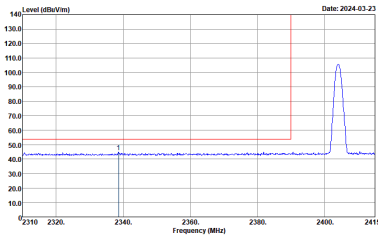
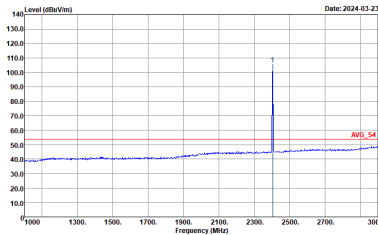
BLE	2.4GHz 2400~2483.5MHz Band Edge @ 3m	
	BLE CH02 2404MHz	
	Horizontal	Fundamental
Peak	 <p>Site : 03CH11-4Y Condition : PEAK_BE_74 3m 91200_01620_230817 HORIZONTAL : RBW:1000.000kHz VBW:3000.000kHz SWT:Auto</p>	 <p>Site : 03CH11-4Y Condition : PEAK_74 3m 91200_01620_230817 HORIZONTAL : RBW:1000.000kHz VBW:3000.000kHz SWT:Auto</p>
Avg.	 <p>Site : 03CH11-4Y Condition : AVG_BE_54 3m 91200_01620_230817 HORIZONTAL : RBW:1000.000kHz VBW:24.000kHz SWT:Auto</p>	 <p>Site : 03CH11-4Y Condition : AVG_54 3m 91200_01620_230817 HORIZONTAL : RBW:1000.000kHz VBW:24.000kHz SWT:Auto</p>

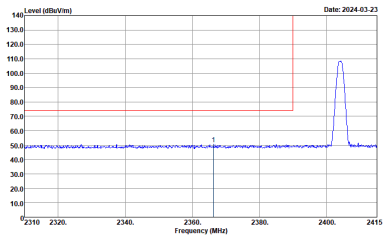
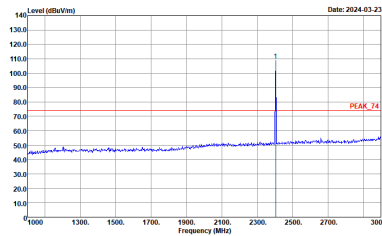
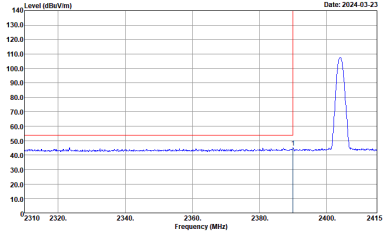
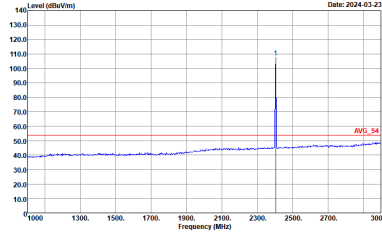

BLE	2.4GHz 2400~2483.5MHz Band Edge @ 3m	
BLE CH02 2404MHz		
Vertical		Fundamental
Peak	 <p>Level (dBm/100kHz) vs Frequency (MHz) plot showing a peak at 2404 MHz. The y-axis ranges from 10.0 to 140.0 dBm/100kHz, and the x-axis ranges from 2310 to 2415 MHz. A red vertical line marks the peak at 2404 MHz.</p> <p>Site : 03CHI1-HY Condition : PEAK_BE_74 3m 91200_01620_230817 VERTICAL : RBW:1000.000KHz VBW:3000.000KHz SWT:Auto</p>	 <p>Level (dBm/100kHz) vs Frequency (MHz) plot showing a peak at 2404 MHz. The y-axis ranges from 10.0 to 140.0 dBm/100kHz, and the x-axis ranges from 1000 to 3000 MHz. A red vertical line marks the peak at 2404 MHz, labeled 'PEAK_74'.</p> <p>Site : 03CHI1-HY Condition : PEAK_74 3m 91200_01620_230817 VERTICAL : RBW:1000.000KHz VBW:3000.000KHz SWT:Auto</p>
Avg	 <p>Level (dBm/100kHz) vs Frequency (MHz) plot showing an average level at 2404 MHz. The y-axis ranges from 10.0 to 140.0 dBm/100kHz, and the x-axis ranges from 2310 to 2415 MHz. A red vertical line marks the average level at 2404 MHz.</p> <p>Site : 03CHI1-HY Condition : AV6_BE_54 3m 91200_01620_230817 VERTICAL : RBW:1000.000KHz VBW:24.000KHz SWT:Auto</p>	 <p>Level (dBm/100kHz) vs Frequency (MHz) plot showing an average level at 2404 MHz. The y-axis ranges from 10.0 to 140.0 dBm/100kHz, and the x-axis ranges from 1000 to 3000 MHz. A red vertical line marks the average level at 2404 MHz, labeled 'AVG_54'.</p> <p>Site : 03CHI1-HY Condition : AV6_54 3m 91200_01620_230817 VERTICAL : RBW:1000.000KHz VBW:24.000KHz SWT:Auto</p>



BLE	2.4GHz 2400~2483.5MHz Band Edge @ 3m	
	BLE CH38 2440MHz - L	
	Horizontal	Fundamental
Peak	<p>Site : 03CH11-HY Condition : PEAK_BE_74 3m 91200_01620_230817 HORIZONTAL : RBW:1000.000kHz VBW:3000.000kHz SWT:Auto</p>	<p>Site : 03CH11-HY Condition : PEAK_74 3m 91200_01620_230817 HORIZONTAL : RBW:1000.000kHz VBW:3000.000kHz SWT:Auto</p>
Avg.	<p>Site : 03CH11-HY Condition : AVG_BE_54 3m 91200_01620_230817 HORIZONTAL : RBW:1000.000kHz VBW:24.000kHz SWT:Auto</p>	<p>Site : 03CH11-HY Condition : AVG_54 3m 91200_01620_230817 HORIZONTAL : RBW:1000.000kHz VBW:24.000kHz SWT:Auto</p>

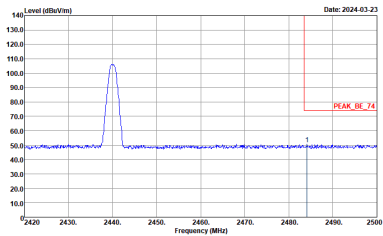
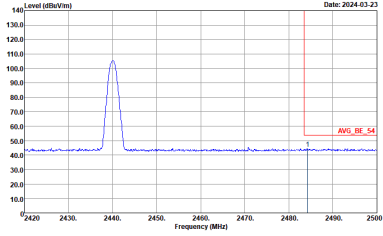

BLE	2.4GHz 2400~2483.5MHz Band Edge @ 3m	
	BLE CH38 2440MHz - R	
	Horizontal	Fundamental
Peak	 <p>Site : 03CH11-HY Condition : PEAK_BE_74 3m 91200_01620_230817 HORIZONTAL : RBW:1000.000kHz VBW:3000.000kHz SWF:Auto</p>	Left blank
Avg.	 <p>Site : 03CH11-HY Condition : AVG_BE_54 3m 91200_01620_230817 HORIZONTAL : RBW:1000.000kHz VBW:24.000kHz SWF:Auto</p>	Left blank

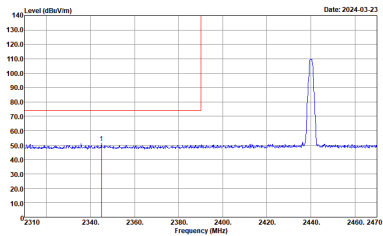
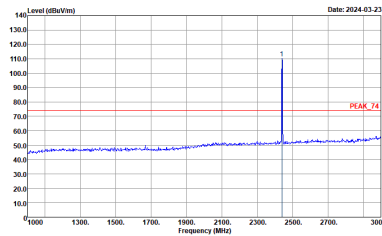
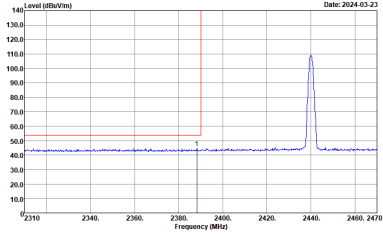
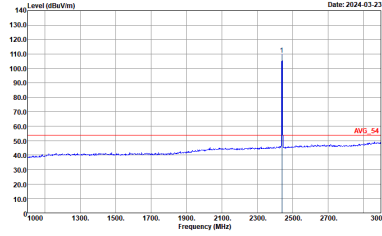

BLE	2.4GHz 2400~2483.5MHz Band Edge @ 3m	
BLE CH38 2440MHz - L		
Vertical		Fundamental
Peak	 <p>Level (dBm/100kHz) vs Frequency (MHz) plot showing a peak at 2440 MHz. The y-axis ranges from 10.0 to 140.0 dBm/100kHz, and the x-axis ranges from 2310 to 2470 MHz. A red vertical line is at 2440 MHz. The peak is labeled '1'.</p> <p>Site : 03CH11-HY Condition : PEAK_BE_74 3m 91200_01620_230817 VERTICAL : RBW:1000.000kHz VBW:3000.000kHz SWT:Auto</p>	 <p>Level (dBm/100kHz) vs Frequency (MHz) plot showing a peak at 2440 MHz. The y-axis ranges from 10.0 to 140.0 dBm/100kHz, and the x-axis ranges from 1000 to 3000 MHz. A red horizontal line is at approximately 75 dBm/100kHz, labeled 'PEAK_74'.</p> <p>Site : 03CH11-HY Condition : PEAK_74 3m 91200_01620_230817 VERTICAL : RBW:1000.000kHz VBW:3000.000kHz SWT:Auto</p>
Avg.	 <p>Level (dBm/100kHz) vs Frequency (MHz) plot showing an average peak at 2440 MHz. The y-axis ranges from 10.0 to 140.0 dBm/100kHz, and the x-axis ranges from 2310 to 2470 MHz. A red vertical line is at 2440 MHz. The peak is labeled '1'.</p> <p>Site : 03CH11-HY Condition : AVG_BE_54 3m 91200_01620_230817 VERTICAL : RBW:1000.000kHz VBW:24.000kHz SWT:Auto</p>	 <p>Level (dBm/100kHz) vs Frequency (MHz) plot showing an average peak at 2440 MHz. The y-axis ranges from 10.0 to 140.0 dBm/100kHz, and the x-axis ranges from 1000 to 3000 MHz. A red horizontal line is at approximately 55 dBm/100kHz, labeled 'AVG_54'.</p> <p>Site : 03CH11-HY Condition : AVG_54 3m 91200_01620_230817 VERTICAL : RBW:1000.000kHz VBW:24.000kHz SWT:Auto</p>

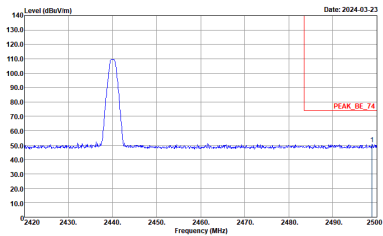
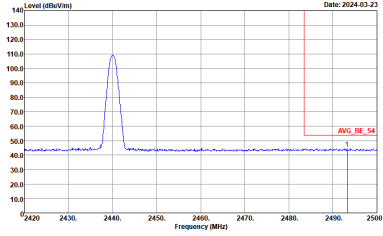

BLE	2.4GHz 2400~2483.5MHz Band Edge @ 3m	
	BLE CH38 2440MHz - R	
	Vertical	Fundamental
<p>Peak</p>	 <p>Site : 03CH11-HY Condition : PEAK_BE_74 3m 91200_01620_230817 VERTICAL : RBW:1000.000kHz VBW:3000.000kHz SWF:Auto</p>	<p>Left blank</p>
<p>Avg.</p>	 <p>Site : 03CH11-HY Condition : AVG_BE_54 3m 91200_01620_230817 VERTICAL : RBW:1000.000kHz VBW:24.000kHz SWF:Auto</p>	<p>Left blank</p>

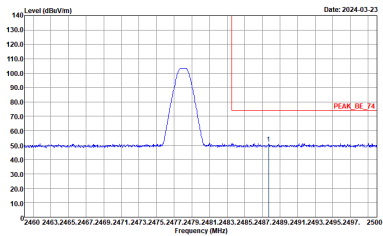
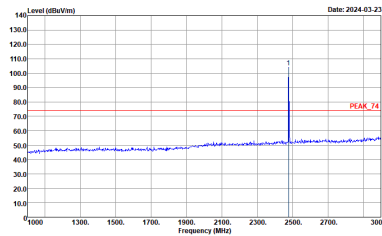
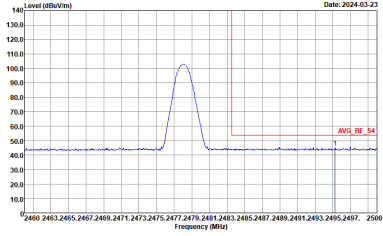
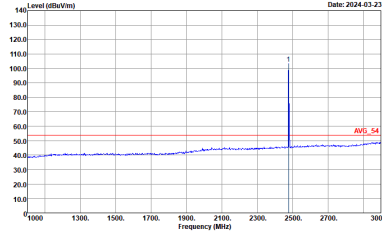

BLE	2.4GHz 2400~2483.5MHz Band Edge @ 3m	
	BLE CH76 2478MHz	
	Horizontal	Fundamental
Peak	 <p>Site : 03CH11-HY Condition : PEAK_BE_74 3m 91200_01620_230817 HORIZONTAL : RBW:1000.000KHz VBW:3000.000KHz SWT:Auto</p>	 <p>Site : 03CH11-HY Condition : PEAK_74 3m 91200_01620_230817 HORIZONTAL : RBW:1000.000KHz VBW:3000.000KHz SWT:Auto</p>
Avg.	 <p>Site : 03CH11-HY Condition : AV6_BE_54 3m 91200_01620_230817 HORIZONTAL : RBW:1000.000KHz VBW:24.000KHz SWT:Auto</p>	 <p>Site : 03CH11-HY Condition : AV6_54 3m 91200_01620_230817 HORIZONTAL : RBW:1000.000KHz VBW:24.000KHz SWT:Auto</p>

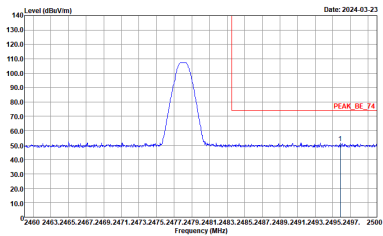
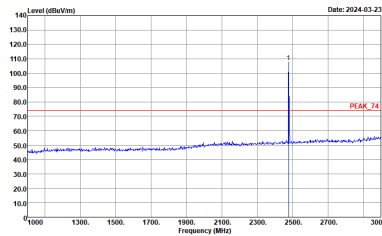
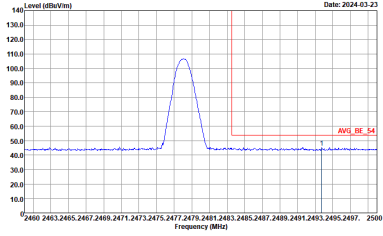
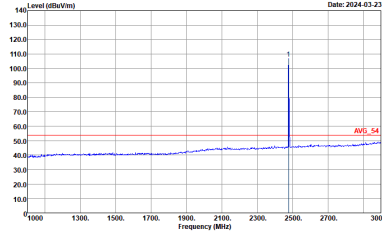

BLE	2.4GHz 2400~2483.5MHz Band Edge @ 3m	
	BLE CH76 2478MHz	
	Vertical	Fundamental
Peak	 <p>Level (dBm/100kHz) vs Frequency (MHz) plot showing a peak at 2478 MHz. The peak level is approximately 110 dBm/100kHz. The plot includes a red line indicating the peak level and a blue line for the signal. The x-axis ranges from 2460 to 2500 MHz, and the y-axis ranges from 10.0 to 140.0 dBm/100kHz.</p> <p>Site : 03CH11-HY Condition : PEAK_BE_74 3m 91200_01620_230817 VERTICAL : RBW:1000.000kHz VBW:3000.000kHz SWT:Auto</p>	 <p>Level (dBm/100kHz) vs Frequency (MHz) plot showing a peak at 2478 MHz. The peak level is approximately 110 dBm/100kHz. The plot includes a red line indicating the peak level and a blue line for the signal. The x-axis ranges from 1000 to 3000 MHz, and the y-axis ranges from 10.0 to 140.0 dBm/100kHz.</p> <p>Site : 03CH11-HY Condition : PEAK_74 3m 91200_01620_230817 VERTICAL : RBW:1000.000kHz VBW:3000.000kHz SWT:Auto</p>
Avg.	 <p>Level (dBm/100kHz) vs Frequency (MHz) plot showing an average level at 2478 MHz. The average level is approximately 60 dBm/100kHz. The plot includes a red line indicating the average level and a blue line for the signal. The x-axis ranges from 2460 to 2500 MHz, and the y-axis ranges from 10.0 to 140.0 dBm/100kHz.</p> <p>Site : 03CH11-HY Condition : AV6_BE_54 3m 91200_01620_230817 VERTICAL : RBW:1000.000kHz VBW:24.000kHz SWT:Auto</p>	 <p>Level (dBm/100kHz) vs Frequency (MHz) plot showing an average level at 2478 MHz. The average level is approximately 60 dBm/100kHz. The plot includes a red line indicating the average level and a blue line for the signal. The x-axis ranges from 1000 to 3000 MHz, and the y-axis ranges from 10.0 to 140.0 dBm/100kHz.</p> <p>Site : 03CH11-HY Condition : AV6_54 3m 91200_01620_230817 VERTICAL : RBW:1000.000kHz VBW:24.000kHz SWT:Auto</p>



2.4GHz 2400~2483.5MHz

BLE (Harmonic @ 3m)

BLE	2.4GHz 2400~2483.5MHz Harmonic @ 3m	
	BLE CH02 2404MHz	
	Horizontal	Vertical
Peak Avg.	<p>Site : 03CH11-4FY Condition : PEAK_74 3m 91200_01620_230817 HORIZONTAL</p>	<p>Site : 03CH11-4FY Condition : PEAK_74 3m 91200_01620_230817 VERTICAL</p>

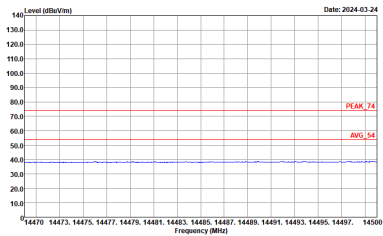
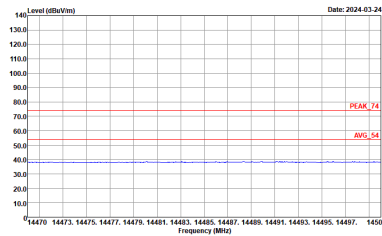
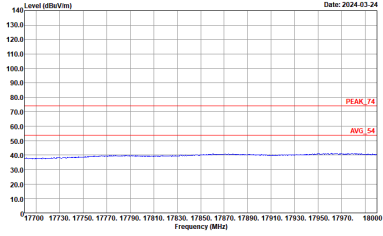
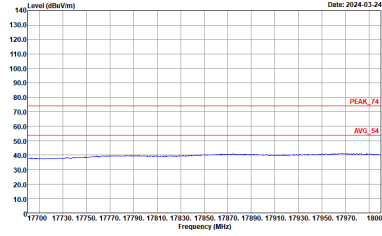

BLE	2.4GHz 2400~2483.5MHz Harmonic @ 3m	
BLE CH02 2404MHz		
Horizontal		Vertical
<p>14.47G ~14.5G Avg.</p>	 <p>Site : 03CH11-HY Condition : PEAK_74 3m 91200_01620_230817 HORIZONTAL</p>	 <p>Site : 03CH11-HY Condition : PEAK_74 3m 91200_01620_230817 VERTICAL</p>
<p>17.7G ~18G Avg</p>	 <p>Site : 03CH11-HY Condition : PEAK_74 3m 91200_01620_230817 HORIZONTAL</p>	 <p>Site : 03CH11-HY Condition : PEAK_74 3m 91200_01620_230817 VERTICAL</p>

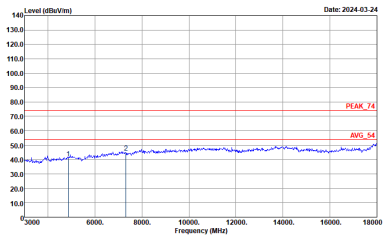
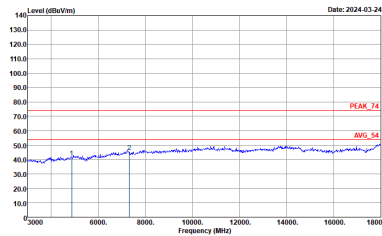

BLE	2.4GHz 2400~2483.5MHz Harmonic @ 3m	
	BLE CH38 2440MHz	
	Horizontal	Vertical
Peak Avg.	 <p>Site : 03CH11-HY Condition : PEAK_74 3m 91200_01620_230817 HORIZONTAL</p>	 <p>Site : 03CH11-HY Condition : PEAK_74 3m 91200_01620_230817 VERTICAL</p>

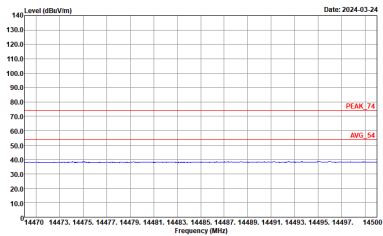
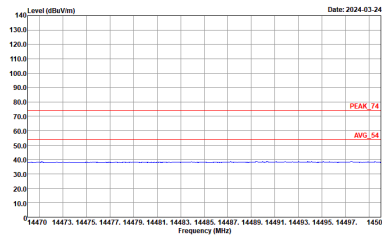
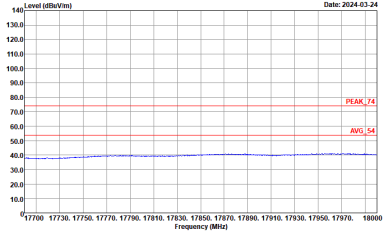
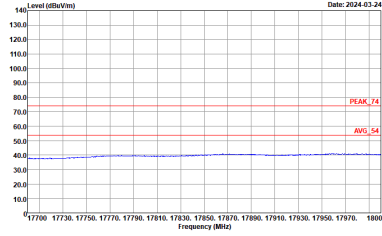

BLE	2.4GHz 2400~2483.5MHz Harmonic @ 3m	
BLE CH38 2440MHz		
Horizontal		Vertical
<p>14.47G ~14.5G Avg.</p>	 <p>Site : 03CH11-HY Condition : PEAK_74 3m 91200_01620_230817 HORIZONTAL</p>	 <p>Site : 03CH11-HY Condition : PEAK_74 3m 91200_01620_230817 VERTICAL</p>
<p>17.7G ~18G Avg</p>	 <p>Site : 03CH11-HY Condition : PEAK_74 3m 91200_01620_230817 HORIZONTAL</p>	 <p>Site : 03CH11-HY Condition : PEAK_74 3m 91200_01620_230817 VERTICAL</p>

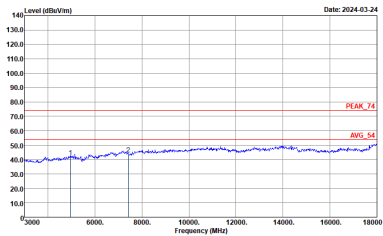
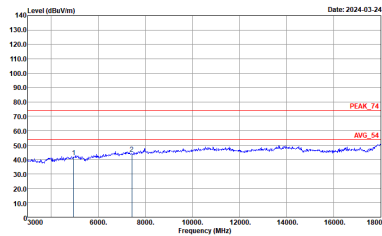

BLE	2.4GHz 2400~2483.5MHz Harmonic @ 3m	
	BLE CH76 2478MHz	
	Horizontal	Vertical
Peak	 <p>Site : 03CH11-HY Condition : PEAK_74 3m 9120D_01620_230817 HORIZONTAL</p>	 <p>Site : 03CH11-HY Condition : PEAK_74 3m 9120D_01620_230817 VERTICAL</p>

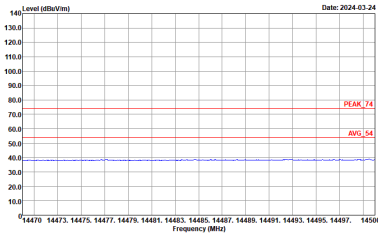
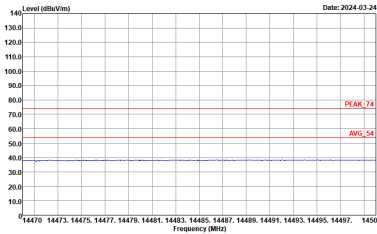
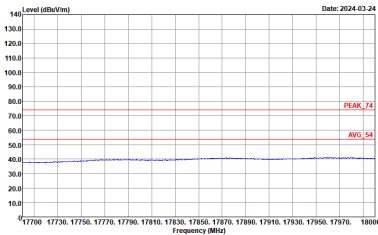
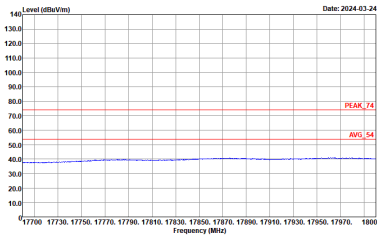

BLE	2.4GHz 2400~2483.5MHz Harmonic @ 3m	
BLE CH76 2478MHz		
Horizontal		Vertical
<p>14.47G ~14.5G Avg.</p>	 <p>Site : 03CH11-HY Condition : PEAK_74 3m 91200_01620_230817 HORIZONTAL</p>	 <p>Site : 03CH11-HY Condition : PEAK_74 3m 91200_01620_230817 VERTICAL</p>
<p>17.7G ~18G Avg</p>	 <p>Site : 03CH11-HY Condition : PEAK_74 3m 91200_01620_230817 HORIZONTAL</p>	 <p>Site : 03CH11-HY Condition : PEAK_74 3m 91200_01620_230817 VERTICAL</p>



<GFSK 2Mbps>

2.4GHz 2400~2483.5MHz

BLE (Band Edge @ 3m)

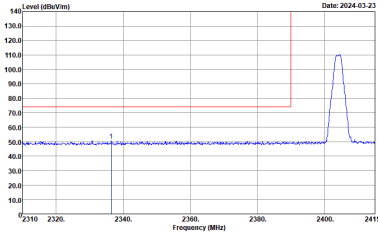
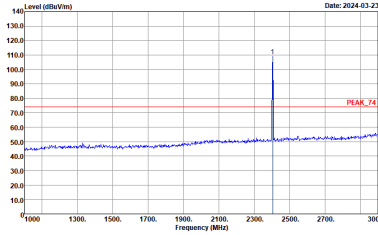
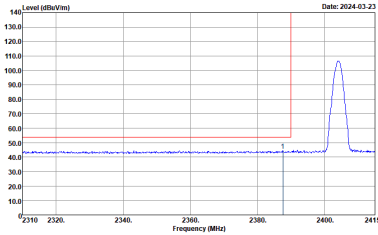
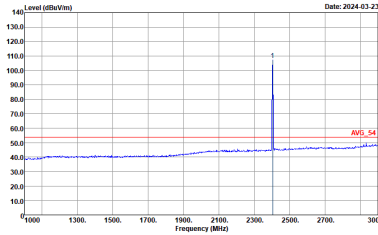
BLE	2.4GHz 2400~2483.5MHz Band Edge @ 3m	
BLE CH02 2404MHz		
Horizontal		Fundamental
Peak	 <p>Date: 2024-03-23</p> <p>Site : 03CH11-4Y Condition : PEAK_BE_74 3m 91200_01620_230817 HORIZONTAL : RBW:1000.000KHz VBW:3000.000KHz SWT:Auto</p>	 <p>Date: 2024-03-23</p> <p>Site : 03CH11-4Y Condition : PEAK_74 3m 91200_01620_230817 HORIZONTAL : RBW:1000.000KHz VBW:3000.000KHz SWT:Auto</p>
Avg.	 <p>Date: 2024-03-23</p> <p>Site : 03CH11-4Y Condition : AVG_BE_54 3m 91200_01620_230817 HORIZONTAL : RBW:1000.000KHz VBW:43.000KHz SWT:Auto</p>	 <p>Date: 2024-03-23</p> <p>Site : 03CH11-4Y Condition : AVG_54 3m 91200_01620_230817 HORIZONTAL : RBW:1000.000KHz VBW:43.000KHz SWT:Auto</p>



BLE	2.4GHz 2400~2483.5MHz Band Edge @ 3m	
	BLE CH02 2404MHz	
	Vertical	Fundamental
Peak	<p>Level (dBm/100kHz) vs Frequency (MHz) for Peak. The plot shows a sharp peak at approximately 2404 MHz. The y-axis ranges from 10.0 to 140.0 dBm/100kHz, and the x-axis ranges from 2310 to 2415 MHz. A red horizontal line is drawn at approximately 75 dBm/100kHz. The peak reaches about 115 dBm/100kHz.</p> <p>Site : 03CH11-HY Condition : PEAK_BE_74 3m 91200_01620_230817 VERTICAL : RBW:1000.000kHz VBW:3000.000kHz SWT:Auto</p>	<p>Level (dBm/100kHz) vs Frequency (MHz) for Fundamental. The plot shows a sharp peak at approximately 2404 MHz. The y-axis ranges from 10.0 to 140.0 dBm/100kHz, and the x-axis ranges from 1000 to 3000 MHz. A red horizontal line is labeled 'PEAK_74' at approximately 75 dBm/100kHz. The peak reaches about 115 dBm/100kHz.</p> <p>Site : 03CH11-HY Condition : PEAK_74 3m 91200_01620_230817 VERTICAL : RBW:1000.000kHz VBW:3000.000kHz SWT:Auto</p>
Avg	<p>Level (dBm/100kHz) vs Frequency (MHz) for Avg. The plot shows a sharp peak at approximately 2404 MHz. The y-axis ranges from 10.0 to 140.0 dBm/100kHz, and the x-axis ranges from 2310 to 2415 MHz. A red horizontal line is drawn at approximately 55 dBm/100kHz. The peak reaches about 115 dBm/100kHz.</p> <p>Site : 03CH11-HY Condition : AV6_BE_54 3m 91200_01620_230817 VERTICAL : RBW:1000.000kHz VBW:43.000kHz SWT:Auto</p>	<p>Level (dBm/100kHz) vs Frequency (MHz) for Fundamental. The plot shows a sharp peak at approximately 2404 MHz. The y-axis ranges from 10.0 to 140.0 dBm/100kHz, and the x-axis ranges from 1000 to 3000 MHz. A red horizontal line is labeled 'AVG_54' at approximately 55 dBm/100kHz. The peak reaches about 115 dBm/100kHz.</p> <p>Site : 03CH11-HY Condition : AV6_54 3m 91200_01620_230817 VERTICAL : RBW:1000.000kHz VBW:43.000kHz SWT:Auto</p>

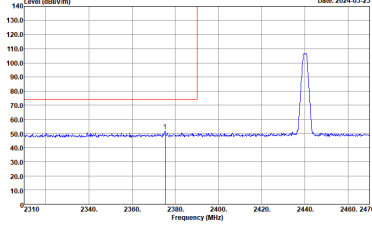
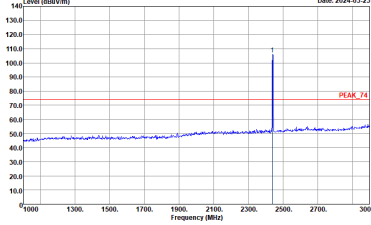
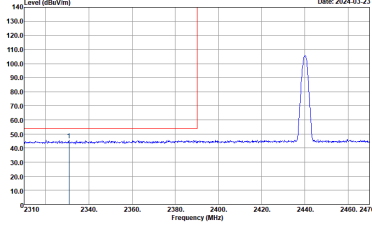
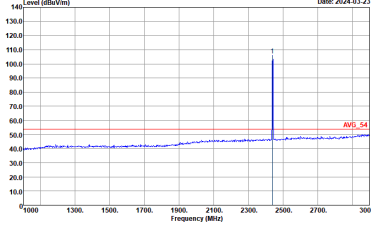

BLE	2.4GHz 2400~2483.5MHz Band Edge @ 3m	
BLE CH38 2440MHz - L		
Horizontal		Fundamental
Peak	 <p>Site : 03CH11-HY Condition : PEAK_BE_74 3m 91200_01620_230817 HORIZONTAL : RBW:1000.000KHz VBW:3000.000KHz SWT:Auto</p>	 <p>Site : 03CH11-HY Condition : PEAK_74 3m 91200_01620_230817 HORIZONTAL : RBW:1000.000KHz VBW:3000.000KHz SWT:Auto</p>
Avg.	 <p>Site : 03CH11-HY Condition : AVG_BE_54 3m 91200_01620_230817 HORIZONTAL : RBW:1000.000KHz VBW:43.000KHz SWT:Auto</p>	 <p>Site : 03CH11-HY Condition : AVG_54 3m 91200_01620_230817 HORIZONTAL : RBW:1000.000KHz VBW:43.000KHz SWT:Auto</p>

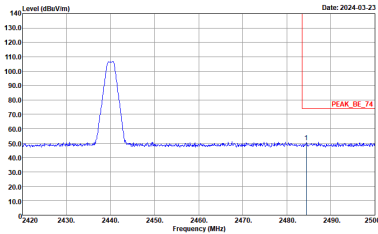
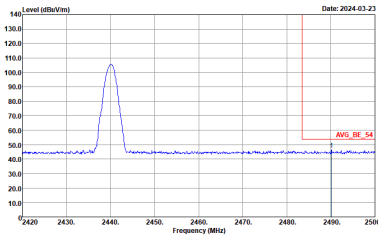

BLE	2.4GHz 2400~2483.5MHz Band Edge @ 3m	
BLE CH38 2440MHz - R		
Horizontal		Fundamental
Peak	 <p>Site : 03CH11-HY Condition : PEAK_BE_74 3m 91200_01620_230817 HORIZONTAL : RBW:1000.000KHz VBW:3000.000KHz SWT:Auto</p>	Left blank
Avg.	 <p>Site : 03CH11-HY Condition : AVG_BE_54 3m 91200_01620_230817 HORIZONTAL : RBW:1000.000KHz VBW:43.000KHz SWT:Auto</p>	Left blank

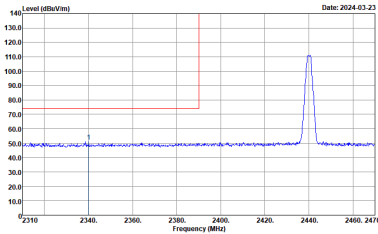
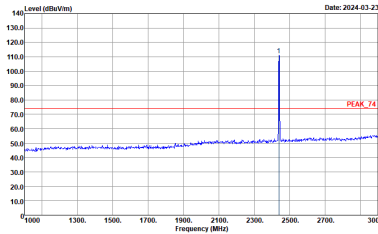
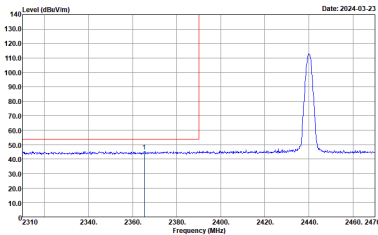
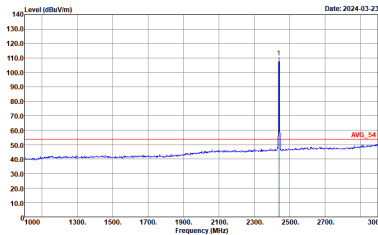

BLE	2.4GHz 2400~2483.5MHz Band Edge @ 3m	
	BLE CH38 2440MHz - L	
	Vertical	Fundamental
Peak	 <p>Date: 2024-03-23</p> <p>Site : 03CH11-HY Condition : PEAK_BE_74 3m 91200_01620_230817 VERTICAL : RBW:1000.000kHz VBW:3000.000kHz SWT:Auto</p>	 <p>Date: 2024-03-23</p> <p>Site : 03CH11-HY Condition : PEAK_74 3m 91200_01620_230817 VERTICAL : RBW:1000.000kHz VBW:3000.000kHz SWT:Auto</p>
Avg.	 <p>Date: 2024-03-23</p> <p>Site : 03CH11-HY Condition : AV6_BE_54 3m 91200_01620_230817 VERTICAL : RBW:1000.000kHz VBW:43.000kHz SWT:Auto</p>	 <p>Date: 2024-03-23</p> <p>Site : 03CH11-HY Condition : AV6_54 3m 91200_01620_230817 VERTICAL : RBW:1000.000kHz VBW:43.000kHz SWT:Auto</p>

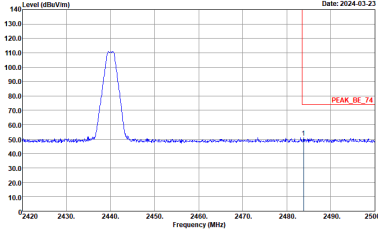
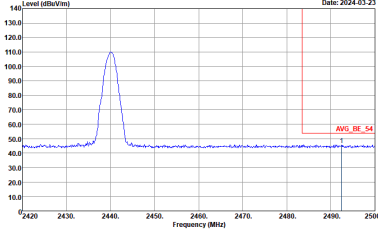

BLE	2.4GHz 2400~2483.5MHz Band Edge @ 3m	
BLE CH38 2440MHz - R		
	Vertical	Fundamental
<p>Peak</p>	 <p>Site : 03CH11-HY Condition : PEAK_BE_74 3m 91200_01620_230817 VERTICAL : RBW:1000.000KHz VBW:3000.000KHz SWF:Auto</p>	<p>Left blank</p>
<p>Avg.</p>	 <p>Site : 03CH11-HY Condition : AVG_BE_54 3m 91200_01620_230817 VERTICAL : RBW:1000.000KHz VBW:43.000KHz SWF:Auto</p>	<p>Left blank</p>

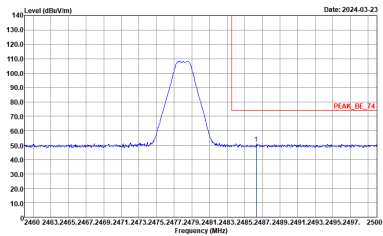
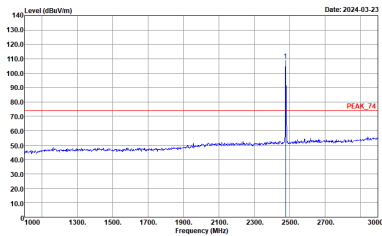
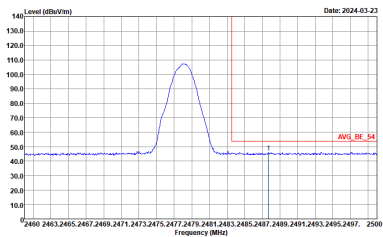
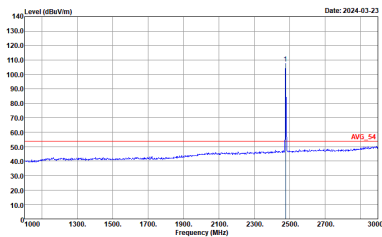

BLE	2.4GHz 2400~2483.5MHz Band Edge @ 3m	
	BLE CH76 2478MHz	
	Horizontal	Fundamental
Peak	 <p>Site : 03CH11-HY Condition : PEAK_BE_74 3m 91200_01620_230817 HORIZONTAL : RBW:1000.000KHz VBW:3000.000KHz SWT:Auto</p>	 <p>Site : 03CH11-HY Condition : PEAK_74 3m 91200_01620_230817 HORIZONTAL : RBW:1000.000KHz VBW:3000.000KHz SWT:Auto</p>
Avg.	 <p>Site : 03CH11-HY Condition : AV6_BE_54 3m 91200_01620_230817 HORIZONTAL : RBW:1000.000KHz VBW:43.000KHz SWT:Auto</p>	 <p>Site : 03CH11-HY Condition : AV6_54 3m 91200_01620_230817 HORIZONTAL : RBW:1000.000KHz VBW:43.000KHz SWT:Auto</p>

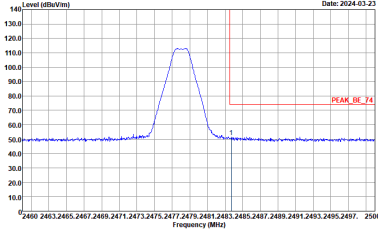
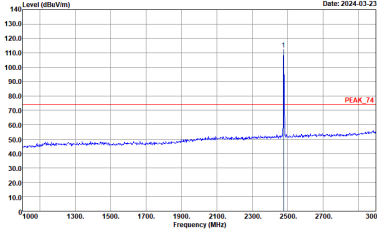
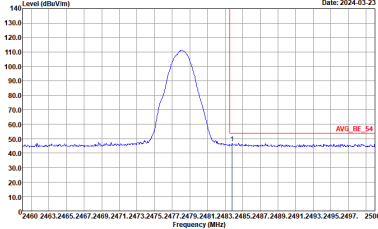
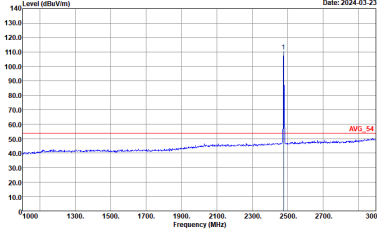

BLE	2.4GHz 2400~2483.5MHz Band Edge @ 3m	
BLE CH76 2478MHz		
Vertical		Fundamental
Peak	 <p>Level (dBm/100kHz) vs Frequency (MHz) plot showing a peak at 2478 MHz. The peak level is approximately 115 dBm/100kHz. The plot includes a red line indicating the peak level and a blue line for the spectrum. The x-axis ranges from 2460 to 2500 MHz, and the y-axis ranges from 10.0 to 140.0 dBm/100kHz.</p> <p>Site : 03CH11-HY Condition : PEAK_BE_74 3m 91200_01620_230817 VERTICAL : RBW:1000.000KHz VBW:3000.000KHz SWT:Auto</p>	 <p>Level (dBm/100kHz) vs Frequency (MHz) plot showing a sharp peak at 2478 MHz. The peak level is approximately 115 dBm/100kHz. The plot includes a red line indicating the peak level and a blue line for the spectrum. The x-axis ranges from 1000 to 3000 MHz, and the y-axis ranges from 10.0 to 140.0 dBm/100kHz.</p> <p>Site : 03CH11-HY Condition : PEAK_74 3m 91200_01620_230817 VERTICAL : RBW:1000.000KHz VBW:3000.000KHz SWT:Auto</p>
Avg.	 <p>Level (dBm/100kHz) vs Frequency (MHz) plot showing the average spectrum. The peak level is approximately 115 dBm/100kHz. The plot includes a red line indicating the average level and a blue line for the spectrum. The x-axis ranges from 2460 to 2500 MHz, and the y-axis ranges from 10.0 to 140.0 dBm/100kHz.</p> <p>Site : 03CH11-HY Condition : AV6_BE_54 3m 91200_01620_230817 VERTICAL : RBW:1000.000KHz VBW:43.000KHz SWT:Auto</p>	 <p>Level (dBm/100kHz) vs Frequency (MHz) plot showing the average spectrum. The peak level is approximately 115 dBm/100kHz. The plot includes a red line indicating the average level and a blue line for the spectrum. The x-axis ranges from 1000 to 3000 MHz, and the y-axis ranges from 10.0 to 140.0 dBm/100kHz.</p> <p>Site : 03CH11-HY Condition : AV6_54 3m 91200_01620_230817 VERTICAL : RBW:1000.000KHz VBW:43.000KHz SWT:Auto</p>



2.4GHz 2400~2483.5MHz

BLE (Harmonic @ 3m)

BLE	2.4GHz 2400~2483.5MHz Harmonic @ 3m	
	BLE CH02 2404MHz	
	Horizontal	Vertical
Peak Avg.	<p>Site : 03CH11-4FY Condition : PEAK_74 3m 91200_01620_230817 HORIZONTAL</p>	<p>Site : 03CH11-4FY Condition : PEAK_74 3m 91200_01620_230817 VERTICAL</p>

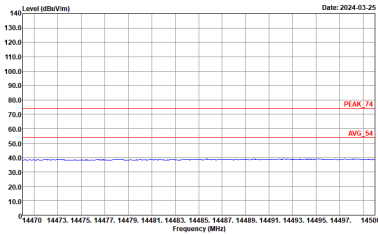
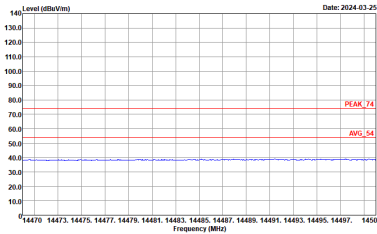
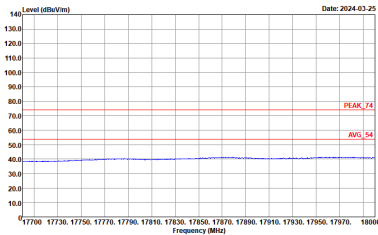
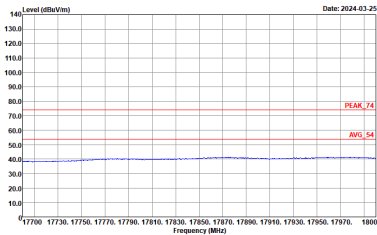

BLE	2.4GHz 2400~2483.5MHz Harmonic @ 3m	
BLE CH02 2404MHz		
Horizontal		Vertical
<p>14.47G ~14.5G Avg.</p>	 <p>Site : 03CH11-HY Condition : PEAK_74 3m 91200_01620_230817 HORIZONTAL</p>	 <p>Site : 03CH11-HY Condition : PEAK_74 3m 91200_01620_230817 VERTICAL</p>
<p>17.7G ~18G Avg</p>	 <p>Site : 03CH11-HY Condition : PEAK_74 3m 91200_01620_230817 HORIZONTAL</p>	 <p>Site : 03CH11-HY Condition : PEAK_74 3m 91200_01620_230817 VERTICAL</p>



BLE	2.4GHz 2400~2483.5MHz Harmonic @ 3m	
	BLE CH38 2440MHz	
	Horizontal	Vertical
Peak Avg.	<p>Site : 03CH11-HY Condition : PEAK_74 3m 91200_01620_230817 HORIZONTAL</p>	<p>Site : 03CH11-HY Condition : PEAK_74 3m 91200_01620_230817 VERTICAL</p>



BLE	2.4GHz 2400~2483.5MHz Harmonic @ 3m	
BLE CH38 2440MHz		
Horizontal		Vertical
<p>14.47G ~14.5G Avg.</p>	<p>Site : 03CH11-HY Condition : PEAK_74 3m 91200_01620_230817 HORIZONTAL</p>	<p>Site : 03CH11-HY Condition : PEAK_74 3m 91200_01620_230817 VERTICAL</p>
<p>17.7G ~18G Avg</p>	<p>Site : 03CH11-HY Condition : PEAK_74 3m 91200_01620_230817 HORIZONTAL</p>	<p>Site : 03CH11-HY Condition : PEAK_74 3m 91200_01620_230817 VERTICAL</p>



BLE	2.4GHz 2400~2483.5MHz Harmonic @ 3m	
	BLE CH76 2478MHz	
	Horizontal	Vertical
Peak	<p>Site : 03CH11-HY Condition : PEAK_74 3m 9120D_01620_230817 HORIZONTAL</p>	<p>Site : 03CH11-HY Condition : PEAK_74 3m 9120D_01620_230817 VERTICAL</p>

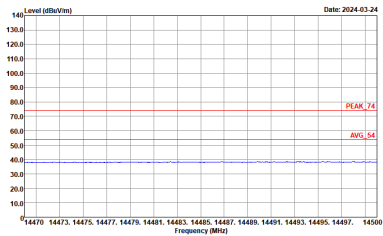
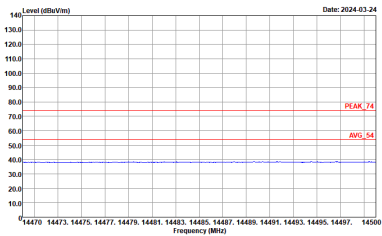
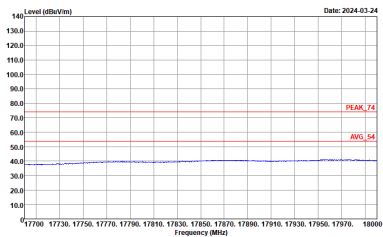
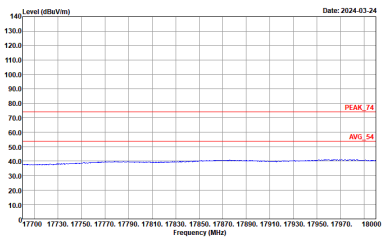

BLE	2.4GHz 2400~2483.5MHz Harmonic @ 3m	
BLE CH76 2478MHz		
Horizontal		Vertical
<p>14.47G ~14.5G Avg.</p>	 <p>Site : 03CH11-HY Condition : PEAK_74 3m 9120D_01620_230817 HORIZONTAL</p>	 <p>Site : 03CH11-HY Condition : PEAK_74 3m 9120D_01620_230817 VERTICAL</p>
<p>17.7G ~18G Avg</p>	 <p>Site : 03CH11-HY Condition : PEAK_74 3m 9120D_01620_230817 HORIZONTAL</p>	 <p>Site : 03CH11-HY Condition : PEAK_74 3m 9120D_01620_230817 VERTICAL</p>



Emission above 18GHz

2.4GHz BLE (SHF @ 1m)

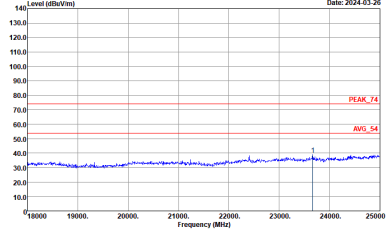
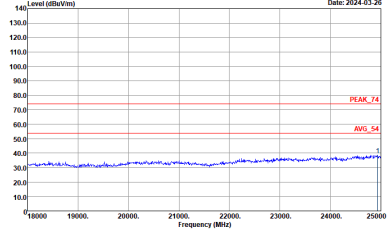
BLE	2.4GHz 2400~2483.5MHz	
	BLE SHF	
	Horizontal	Vertical
Peak Avg.	 <p>Site : 03CH11-4FY Condition : PEAK_74 1m SHF_00993_231124 HORIZONTAL</p>	 <p>Site : 03CH11-4FY Condition : PEAK_74 1m SHF_00993_231124 VERTICAL</p>



Emission below 1GHz

2.4GHz BLE (LF)

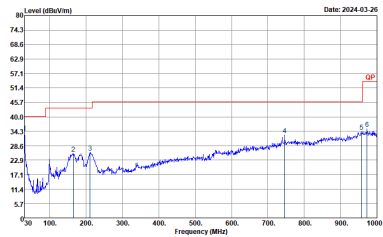
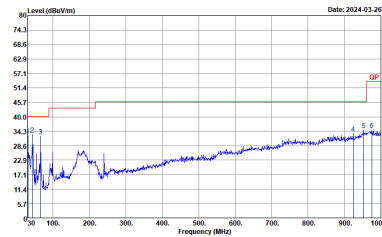
BLE	2.4GHz 2400~2483.5MHz	
	BLE LF	
	Horizontal	Vertical
QP / Peak	 <p>Site : 03CH11-HY Condition : QP 3m 2_BILO6_35414_231007 HORIZONTAL</p>	 <p>Site : 03CH11-HY Condition : QP 3m 2_BILO6_35414_231007 VERTICAL</p>



Appendix E. Duty Cycle Plots

Band	Duty Cycle(%)	T(us)	1/T(kHz)	VBW Setting
Bluetooth - LE GFSK for 1Mbps	15.28	44	22.727	24KHz
Bluetooth - LE GFSK for 2Mbps	9.92	25	40.000	43kHz

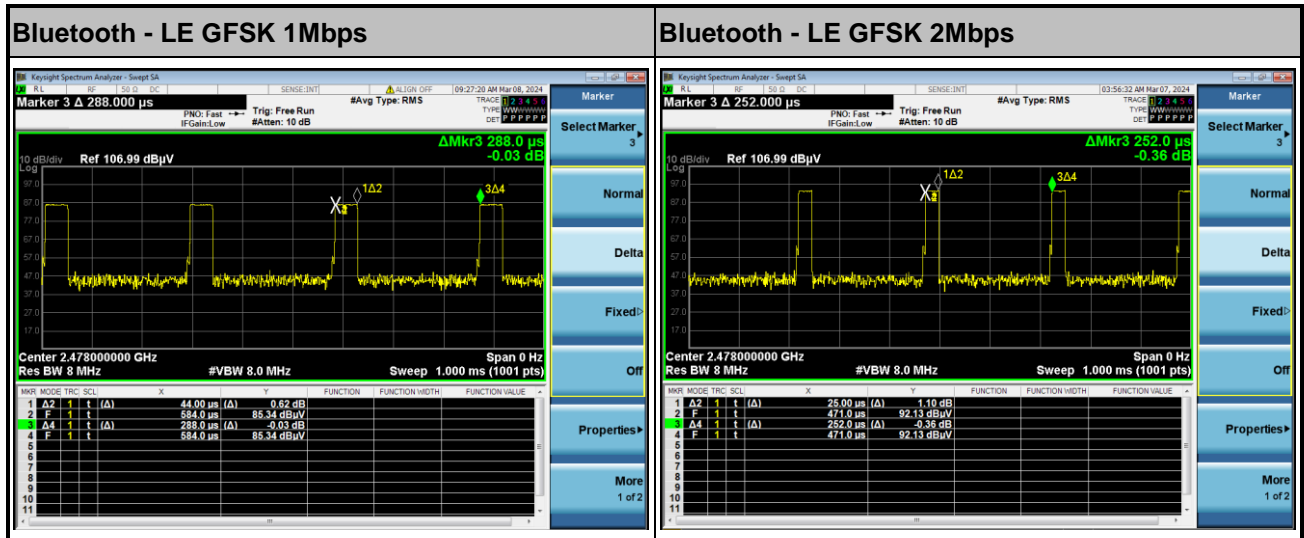

—THE END—