



FCC RADIO TEST REPORT

FCC ID : A4RG9S9B
Equipment : Phone
Model Name : G9S9B
Applicant : Google LLC
1600 Amphitheatre Parkway,
Mountain View, California, 94043 USA
Standard : FCC 47 CFR Part 2, 27

The product was received on Jun. 08, 2021 and testing was started from Jun. 08, 2021 and completed on Aug. 05, 2021. We, Sporton International Inc. EMC & Wireless Communications Laboratory, would like to declare that the tested sample has been evaluated in accordance with the test procedures given in ANSI / TIA-603-E and has been in compliance with the applicable technical standards.

The test results in this report apply exclusively to the tested model / sample. Without written approval of Sporton International Inc. EMC & Wireless Communications Laboratory, the test report shall not be reproduced except in full.

Louis Wu

Approved by: Louis Wu

Sporton International Inc. EMC & Wireless Communications Laboratory

No. 52, Huaya 1st Rd., Guishan Dist., Taoyuan City 333, Taiwan (R.O.C.)



Table of Contents

History of this test report..... 3

Summary of Test Result..... 4

1 General Description 5

 1.1 Product Feature of Equipment Under Test..... 5

 1.2 Product Specification of Equipment Under Test..... 6

 1.3 Modification of EUT 6

 1.4 Testing Location 7

 1.5 Applicable Standards..... 7

2 Test Configuration of Equipment Under Test 8

 2.1 Test Mode..... 8

 2.2 Connection Diagram of Test System..... 9

 2.3 Support Unit used in test configuration and system 9

 2.4 Measurement Results Explanation Example..... 9

 2.5 Frequency List of Low/Middle/High Channels 10

3 Conducted Test Items..... 11

 3.1 Measuring Instruments 11

 3.2 Conducted Output Power and EIRP..... 12

 3.3 Peak-to-Average Ratio 13

 3.4 Occupied Bandwidth..... 14

 3.5 Conducted Band Edge 15

 3.6 Conducted Spurious Emission 16

 3.7 Frequency Stability 17

4 Radiated Test Items 18

 4.1 Measuring Instruments 18

 4.2 Radiated Spurious Emission Measurement 20

5 List of Measuring Equipment..... 21

6 Uncertainty of Evaluation..... 23

Appendix A. Test Results of Conducted Test

Appendix B. Test Results of Radiated Test



Summary of Test Result

Report Clause	Ref Std. Clause	Test Items	Result (PASS/FAIL)	Remark
3.2	§2.1046	Conducted Output Power	Reporting only	-
	§27.50 (k)(3)	Equivalent Isotropic Radiated Power (n77)	Pass	
3.3	§27.50 (k)(4)	Peak-to-Average Ratio	Pass	-
3.4	§2.1049	Occupied Bandwidth	Reporting only	-
3.5	§2.1051	Conducted Band Edge Measurement (n77)	Pass	-
	§27.53 (n)(2)			
3.6	§2.1051	Conducted Spurious Emission (n77)	Pass	-
	§27.53 (n)(2)			
3.7	§2.1055	Frequency Stability Temperature & Voltage	Pass	-
	§27.54			
4.2	§2.1053 §27.53 (n)(2)	Radiated Spurious Emission (n77)	Pass	Under limit 24.06 dB at 13806.000 MHz for Primary Antenna Under limit 23.58 dB at 13806.000 MHz for ASDIV Antenna

Declaration of Conformity:

The test results with all measurement uncertainty excluded are presented in accordance with the regulation limits or requirements declared by manufacturers.

Comments and Explanations:

The declared of product specification for EUT presented in the report are provided by the manufacturer, and the manufacturer takes all the responsibilities for the accuracy of product specification.

Reviewed by: William Chen

Report Producer: Ruby Zou



1 General Description

1.1 Product Feature of Equipment Under Test

Product Feature	
Equipment	Phone
Model Name	G9S9B
FCC ID	A4RG9S9B
EUT supports Radios application	GSM/EGPRS/WCDMA/HSPA/LTE/5G NR/NFC/ GNSS/WPC/WPT WLAN 11b/g/n HT20 WLAN 11a/n HT20/HT40 WLAN 11ac VHT20/VHT40/VHT80/VHT160 WLAN 11ax HE20/HE40/HE80/HE160 Bluetooth BR/EDR/LE

Remark: The above EUT's information was declared by manufacturer.

EUT Information List	
S/N	Performed Test Item
14191FDF60001D	Conducted Measurement EIRP
15211FDF600057	Radiated Spurious Emission



1.2 Product Specification of Equipment Under Test

Product Specification subjective to this standard	
Tx Frequency	5G NR n77: 3455.01 MHz ~ 3544.98 MHz
Rx Frequency	5G NR n77: 3455.01 MHz ~ 3544.98 MHz
Bandwidth	5G NR n77: 10MHz / 15MHz / 20MHz / 30MHz / 40MHz / 50MHz / 60MHz / 70MHz / 80MHz / 90MHz / 100MHz
Maximum Output Power to Antenna <DFT-s-OFDM>	<Primary Antenna> <Ant. 6> 5G NR n77: 24.46 dBm 5G NR n77: 26.78 dBm for HPUE <ASDIV Antenna> <Ant. 2> 5G NR n77: 24.54 dBm 5G NR n77: 26.69 dBm for HPUE
Antenna Type	<Primary Antenna>: <Ant. 6>: IFA Antenna type <ASDIV Antenna>: <Ant. 2>: ILA Antenna type
Type of Modulation	PI/2 BPSK / QPSK / 16QAM / 64QAM / 256QAM

<Primary Antenna>

Radio Tech	Band Number	Antenna name	Gain
5G NR	n77	ANT6	0.5
	n77_HPUE		

<ASDIV Antenna>

Radio Tech	Band Number	Antenna name	Gain
5G NR	n77	ANT2	-0.5
	n77_HPUE		

Remark: The above EUT's information was declared by manufacturer. Please refer to Comments and Explanations in report summary.

1.3 Modification of EUT

No modifications are made to the EUT during all test items.



1.4 Testing Location

Test Site	Sporton International Inc. EMC & Wireless Communications Laboratory
Test Site Location	No.52, Huaya 1st Rd., Guishan Dist., Taoyuan City 333, Taiwan (R.O.C.) TEL: +886-3-327-3456 FAX: +886-3-328-4978
Test Site No.	Sporton Site No. TH03-HY
Test Engineer	Sherry Wu
Temperature	23.5~26.4°C
Relative Humidity	49.8~55.5%

Test Site	Sporton International Inc. Wensan Laboratory
Test Site Location	No.58, Aly. 75, Ln. 564, Wenhua 3rd, Rd., Guishan Dist., Taoyuan City 333010, Taiwan (R.O.C.) TEL: +886-3-327-0868 FAX: +886-3-327-0855
Test Site No.	Sporton Site No. 03CH12-HY (TAF Code: 3786)
Test Engineer	Jack Cheng, Lance Chiang and Chuan Chu
Temperature	22.6~26.2°C
Relative Humidity	56.6~68.2%
Remark	The Radiated Spurious Emission test item subcontracted to Sporton International Inc. Wensan Laboratory.

Note: The test site complies with ANSI C63.4 2014 requirement.

FCC Designation No.: TW1190 and TW3786

1.5 Applicable Standards

According to the specifications of the manufacturer, the EUT must comply with the requirements of the following standards:

- ♦ ANSI C63.26-2015
- ♦ ANSI / TIA-603-E
- ♦ FCC 47 CFR Part 2, 27
- ♦ FCC KDB 971168 D01 Power Meas. License Digital Systems v03r01
- ♦ FCC KDB 412172 D01 Determining ERP and EIRP v01r01
- ♦ FCC KDB 414788 D01 Radiated Test Site v01r01.

Remark:

1. All test items were verified and recorded according to the standards and without any deviation during the test.
2. The TAF code is not including all the FCC KDB listed without accreditation.



2 Test Configuration of Equipment Under Test

2.1 Test Mode

Antenna port conducted and radiated test items listed below are performed according to KDB 971168 D01 Power Meas. License Digital Systems v03r01 with maximum output power.

For radiated measurement, the measured emission level of the EUT was maximized by rotating the EUT on a turntable, adjusting the orientation of the EUT and EUT antenna in three orthogonal axis (X: flat, Y: portrait, Z: landscape), and adjusting the measurement antenna orientation, following C63.26 exploratory test procedures and find <Primary Antenna>: X Plane with Adapter; <ASDIV Antenna>: Z Plane with Adapter as worst plane.

Test Items	NR Band	Bandwidth (MHz)												Modulation					RB #			Test Channel		
		10	15	20	30	40	50	60	70	80	90	100	PI/2 BPSK	QPSK	16QAM	64QAM	256QAM	1	Half	Full	L	M	H	
Max. Output Power	n77	v	v	v	v	v	v	v	v	v	v	v	v	v	v	v	v	v	v	v	v	v	v	
Peak-to-Average Ratio	n77			v									v	v	v	v	v			v		v		
26dB and 99% Bandwidth	n77	v	v	v	v	v	v	v	v	v	v	v	v	v	v	v	v			v		v		
Conducted Band Edge	n77	v	v	v	v	v	v	v	v	v	v	v	v	v	v	v	v			v	v		v	
Conducted Spurious Emission	n77	v													v				v		v	v	v	
Frequency Stability	n77			v										v						v		v		
E.I.R.P	n77	v	v	v	v	v	v	v	v	v	v	v	v	v	v	v	v	Max. Power						
Radiated Spurious Emission	n77	Worst Case																			v	v	v	
Remark	<ol style="list-style-type: none"> The mark "v" means that this configuration is chosen for testing The mark "-" means that this bandwidth is not supported. The device is investigated from 30MHz to 10 times of fundamental signal for radiated spurious emission test under different RB size/offset and modulations in exploratory test. Subsequently, only the worst case emissions are reported. Test combination is EN-DC 7A_n77A. For radiated measurement, pre-scanned in two modes, DFT-s OFDM and CP OFDM. The worst cases (DFT-s OFDM) were recorded in this report, and the worst modes of FR1 and LTE for simultaneous transmission were verified and compliant. All the radiated test cases were performed with Adapter 2 and USB Cable 1. During the preliminary test, both charging modes (Adapter mode and WPC Charging mode) were verified. It is determined that the adaptor mode is the worst case for official test. All the NR SA/NSA modes are evaluated conducted power to determine the worst case mode for conducted items to be reported, for RSE, the NSA mode is selected to be performed instead of SA mode based on the NR output power is similar. 																							

2.2 Connection Diagram of Test System

<EUT with Adapter>

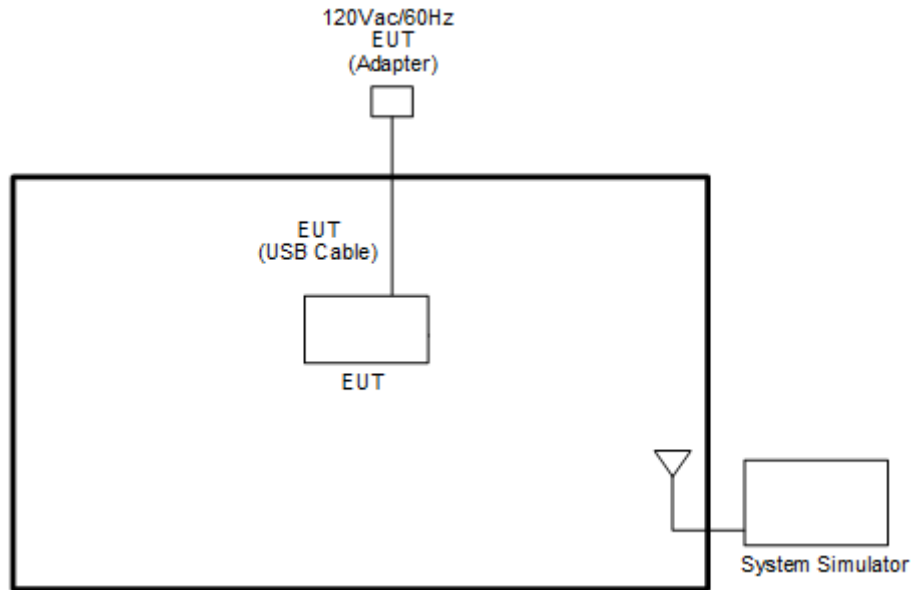

2.3 Support Unit used in test configuration and system

Item	Equipment	Brand Name	Model No.	FCC ID	Data Cable	Power Cord
1.	System Simulator	Anritsu	MT8821C	N/A	N/A	Unshielded, 1.8 m
2.	System Simulator	Anritsu	MT8000A	N/A	N/A	Unshielded, 1.8 m

2.4 Measurement Results Explanation Example

For all conducted test items:

The offset level is set in the spectrum analyzer to compensate the RF cable loss and attenuator factor between EUT conducted output port and spectrum analyzer. With the offset compensation, the spectrum analyzer reading level is exactly the EUT RF output level.

The spectrum analyzer offset is derived from RF cable loss and attenuator factor.

Offset = RF cable loss + attenuator factor.

Following shows an offset computation example with cable loss 4.2 dB and 10dB attenuator.

Example :

$$\begin{aligned} \text{Offset(dB)} &= \text{RF cable loss(dB)} + \text{attenuator factor(dB)}. \\ &= 4.2 + 10 = 14.2 \text{ (dB)} \end{aligned}$$



2.5 Frequency List of Low/Middle/High Channels

5G NR Band n77 Channel and Frequency List				
BW [MHz]	Channel/Frequency(MHz)	Lowest	Middle	Highest
100	Channel	-	633334	-
	Frequency	-	3500.01	-
90	Channel	633000	633334	633666
	Frequency	3495	3500.01	3504.99
80	Channel	632668	633334	634000
	Frequency	3490.02	3500.01	3510
70	Channel	632334	633334	634332
	Frequency	3485.01	3500.01	3514.98
60	Channel	632000	633334	634666
	Frequency	3480	3500.01	3519.99
50	Channel	631668	633334	635000
	Frequency	3475.02	3500.01	3525
40	Channel	631334	633334	635332
	Frequency	3470.01	3500.01	3529.98
30	Channel	631000	633334	635666
	Frequency	3465	3500.01	3534.99
20	Channel	630668	633334	636000
	Frequency	3460.02	3500.01	3540
15	Channel	630500	633334	636166
	Frequency	3457.5	3500.01	3542.49
10	Channel	630334	633334	636332
	Frequency	3455.01	3500.01	3544.98

3 Conducted Test Items

3.1 Measuring Instruments

See list of measuring instruments of this test report.

3.1.1 Test Setup

3.1.2 Conducted Output Power

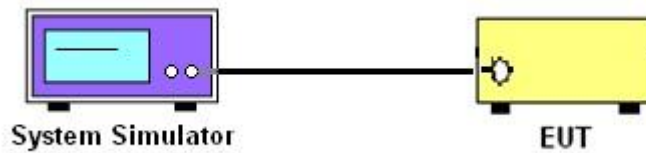

3.1.3 Peak-to-Average Ratio, Occupied Bandwidth ,Conducted Band-Edge and Conducted Spurious Emission

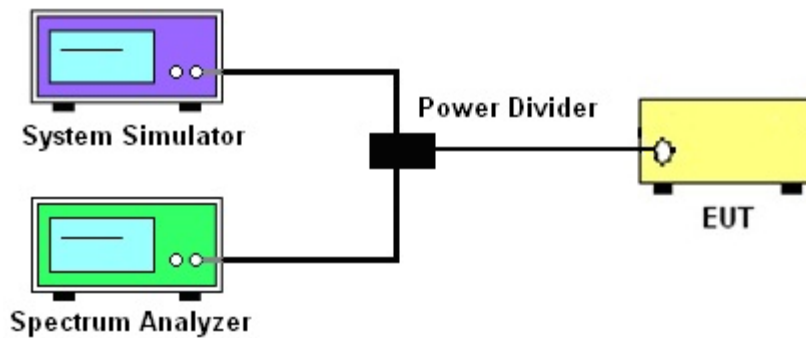

3.1.4 Frequency Stability

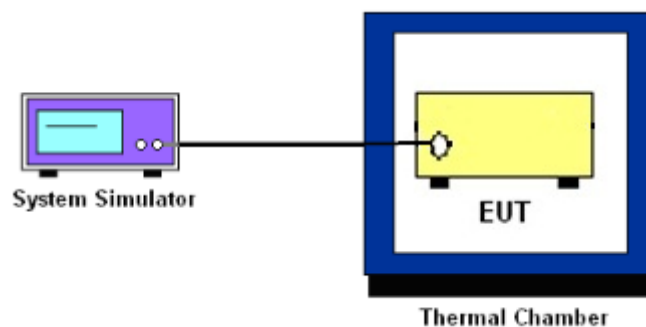

3.1.5 Test Result of Conducted Test

Please refer to Appendix A.



3.2 Conducted Output Power and EIRP

3.2.1 Description of the Conducted Output Power Measurement and EIRP Measurement

A system simulator was used to establish communication with the EUT. Its parameters were set to force the EUT transmitting at maximum output power. The measured power in the radio frequency on the transmitter output terminals shall be reported.

The EIRP of mobile transmitters must not exceed 1 Watts for 5G NR n77

According to KDB 412172 D01 Power Approach,

$EIRP = P_T + G_T - L_C$, $ERP = EIRP - 2.15$, where

P_T = transmitter output power in dBm

G_T = gain of the transmitting antenna in dBi

L_C = signal attenuation in the connecting cable between the transmitter and antenna in dB

3.2.2 Test Procedures

1. The transmitter output port was connected to the system simulator.
2. Set EUT at maximum power through the system simulator.
3. Select lowest, middle, and highest channels for each band and different modulation.
4. Measure and record the power level from the system simulator.



3.3 Peak-to-Average Ratio

3.3.1 Description of the PAR Measurement

Power Complementary Cumulative Distribution Function (CCDF) curves provide a means for characterizing the power peaks of a digitally modulated signal on a statistical basis. A CCDF curve depicts the probability of the peak signal amplitude exceeding the average power level. Most contemporary measurement instrumentation include the capability to produce CCDF curves for an input signal provided that the instrument's resolution bandwidth can be set wide enough to accommodate the entire input signal bandwidth. In measuring transmissions in this band using an average power technique, the peak-to-average ratio (PAR) of the transmission may not exceed 13 dB.

3.3.2 Test Procedures

The testing follows ANSI C63.26-2015 Section 5.2.6

1. The EUT was connected to spectrum and system simulator via a power divider.
2. Set the CCDF (Complementary Cumulative Distribution Function) option in spectrum analyzer.
3. The highest RF powers were measured and recorded the maximum PAPR level associated with a probability of 0.1 %.
4. Record the deviation as Peak to Average Ratio.



3.4 Occupied Bandwidth

3.4.1 Description of Occupied Bandwidth Measurement

The occupied bandwidth is the width of a frequency band such that, below the lower and above the upper frequency limits, the mean powers emitted are each equal to a specified percentage 0.5% of the total mean transmitted power.

The 26 dB emission bandwidth is defined as the frequency range between two points, one above and one below the carrier frequency, at which the spectral density of the emission is attenuated 26 dB below the maximum in-band spectral density of the modulated signal. Spectral density (power per unit bandwidth) is to be measured with a detector of resolution bandwidth equal to approximately 1.0% of the emission bandwidth.

3.4.2 Test Procedures

The testing follows ANSI C63.26-2015 Section 5.4.3 (26dB) and Section 5.4.4 (99OB)

1. The EUT was connected to spectrum analyzer and system simulator via a power divider.
2. The spectrum analyzer center frequency is set to the nominal EUT channel center frequency. The span range for the spectrum analyzer shall be between two and five times the anticipated OBW.
3. The nominal resolution bandwidth (RBW) shall be in the range of 1 to 5 % of the anticipated OBW, and the VBW shall be at least 3 times the RBW.
4. Set the detection mode to peak, and the trace mode to max hold.
5. Determine the reference value: Set the EUT to transmit a modulated signal. Allow the trace to stabilize. Set the spectrum analyzer marker to the highest level of the displayed trace.
(this is the reference value)
6. Determine the “-26 dB down amplitude” as equal to (Reference Value – X).
7. Place two markers, one at the lowest and the other at the highest frequency of the envelope of the spectral display such that each marker is at or slightly below the “-X dB down amplitude” determined in step 6. If a marker is below this “-X dB down amplitude” value it shall be placed as close as possible to this value. The OBW is the positive frequency difference between the two markers.
8. Use the 99 % power bandwidth function of the spectrum analyzer and report the measured bandwidth.



3.5 Conducted Band Edge

3.5.1 Description of Conducted Band Edge Measurement

27.53 (n)(2)

(2) For mobile operations in the 3450-3550 MHz band, the conducted power of any emission outside the licensee's authorized bandwidth shall not exceed -13 dBm/MHz. Compliance with this paragraph (n)(2) is based on the use of measurement instrumentation employing a resolution bandwidth of 1 megahertz or greater. However, in the 1 megahertz bands immediately outside and adjacent to the licensee's frequency block, a resolution bandwidth of at least one percent of the emission bandwidth of the fundamental emission of the transmitter may be employed, but limited to a maximum of 200 kHz. In the bands between 1 and 5 MHz removed from the licensee's frequency block, the minimum resolution bandwidth for the measurement shall be 500 kHz. The emission bandwidth is defined as the width of the signal between two points, one below the carrier center frequency and one above the carrier center frequency, outside of which all emissions are attenuated at least 26 dB below the transmitter power.

3.5.2 Test Procedures

The testing follows FCC KDB 971168 D01 v03r01 Section 6.1.

1. The EUT was connected to spectrum analyzer and system simulator via a power divider.
2. The band edges of low and high channels for the highest RF powers were measured.
3. For $EBW < 20\text{MHz}$, set $RBW \geq 1\%$ EBW in the 1MHz band immediately outside and adjacent to the band edge.
4. For $EBW \geq 20\text{MHz}$, set $RBW = 200\text{kHz}$ in the 1MHz band immediately outside and adjacent to the band edge.
5. Between 1 ~5 MHz from the band edge, $RBW=500$ kHz was used.
6. Set spectrum analyzer with RMS detector.
7. The RF fundamental frequency should be excluded against the limit line in the operating frequency band.
8. Checked that all the results comply with the emission limit line.

The limit line is derived from $43 + 10\log(P)\text{dB}$ below the transmitter power P(Watts)



3.6 Conducted Spurious Emission

3.6.1 Description of Conducted Spurious Emission Measurement

The power of any emission outside of the authorized operating frequency ranges must be lower than the transmitter power (P) by a factor of at least $43 + 10 \log (P)$ dB.

It is measured by means of a calibrated spectrum analyzer and scanned from 30 MHz up to a frequency including its 10th harmonic.

3.6.2 Test Procedures

The testing follows FCC KDB 971168 D01 v03r01 Section 6.1.

1. The EUT was connected to spectrum analyzer and system simulator via a power divider.
2. The RF output of EUT was connected to the spectrum analyzer by RF cable and attenuator.
The path loss was compensated to the results for each measurement.
3. The middle channel for the highest RF power within the transmitting frequency was measured.
4. The conducted spurious emission for the whole frequency range was taken.
5. Make the measurement with the spectrum analyzer's RBW = 1MHz, VBW = 3MHz.
6. Set spectrum analyzer with RMS detector.
7. Taking the record of maximum spurious emission.
8. The RF fundamental frequency should be excluded against the limit line in the operating frequency band.
9. The limit line is derived from $43 + 10\log(P)$ dB below the transmitter power P(Watts)



3.7 Frequency Stability

3.7.1 Description of Frequency Stability Measurement

27.54

The frequency stability shall be sufficient to ensure that the fundamental emission stays within the authorized frequency block.

3.7.2 Test Procedures for Temperature Variation

The testing follows FCC KDB 971168 D01 v03r01 Section 9.0.

1. The EUT was set up in the thermal chamber and connected with the system simulator.
2. With power OFF, the temperature was decreased to -30°C and the EUT was stabilized before testing. Power was applied and the maximum change in frequency was recorded within one minute.
3. With power OFF, the temperature was raised in 10°C step up to 50°C. The EUT was stabilized at each step for at least half an hour. Power was applied and the maximum frequency change was recorded within one minute.

3.7.3 Test Procedures for Voltage Variation

The testing follows FCC KDB 971168 D01 v03r01 Section 9.0.

1. The EUT was placed in a temperature chamber at 20±5° C and connected with the system simulator.
2. The power supply voltage to the EUT was varied from 85% to 115% of the nominal value measured at the input to the EUT.
3. The variation in frequency was measured for the worst case.

4 Radiated Test Items

4.1 Measuring Instruments

See list of measuring instruments of this test report.

4.1.1 Test Setup

For radiated test below 30MHz

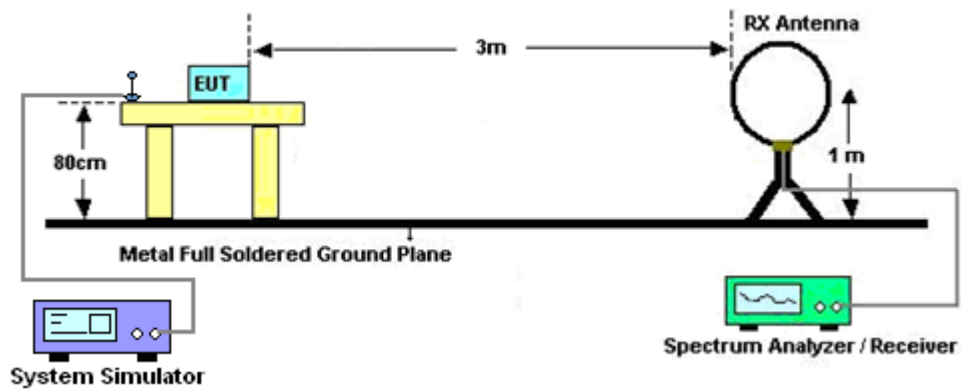

For radiated test from 30MHz to 1GHz

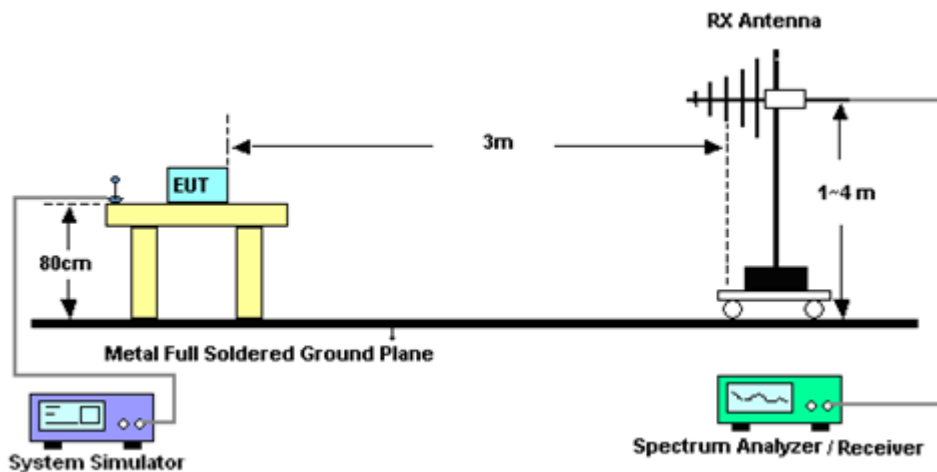

For radiated test from 1GHz to 18GHz

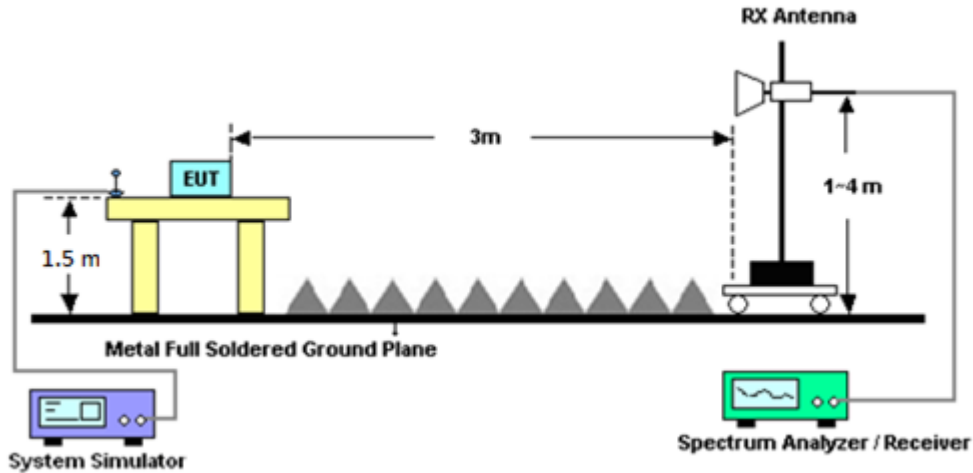

For radiated test above 18GHz

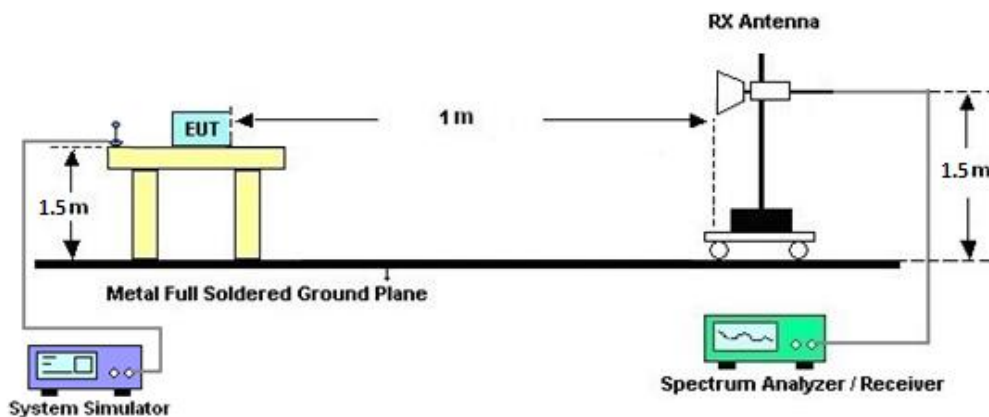

4.1.2 Test Result of Radiated Test

Please refer to Appendix B.

Note:

The low frequency, which started from 9 kHz to 30MHz, was pre-scanned and the result which was 20dB lower than the limit line was not reported.

There is adequate comparison measurement of both open-field test site and alternative test site - semi-Anechoic chamber according to 414788 D01 Radiated Test Site v01r01, and the result came out very similar.



4.2 Radiated Spurious Emission Measurement

4.2.1 Description of Radiated Spurious Emission Measurement

The radiated spurious emission was measured by substitution method according to ANSI / TIA-603-E. The power of any emission outside of the authorized operating frequency ranges must be attenuated below the transmitter power (P) by a factor of at least $43 + 10 \log (P)$ dB. The spectrum is scanned from 30 MHz up to a frequency including its 10th harmonic.

4.2.2 Test Procedures

The testing follows FCC KDB 971168 D01 v03r01 Section 7 and ANSI / TIA-603-E Section 2.2.12.

1. The EUT was placed on a turntable with 0.8 meter for frequency below 1GHz and 1.5 meter for frequency above 1GHz respectively above ground.
2. The EUT was set 3 meters from the receiving antenna, which was mounted on the antenna tower.
3. The table was rotated 360 degrees to determine the position of the highest spurious emission.
4. The height of the receiving antenna is varied between one meter and four meters to search the maximum spurious emission for both horizontal and vertical polarizations.
5. Make the measurement with the spectrum analyzer's RBW = 1MHz, VBW = 3MHz, taking the record of maximum spurious emission.
6. A horn antenna was substituted in place of the EUT and was driven by a signal generator.
7. Tune the output power of signal generator to the same emission level with EUT maximum spurious emission.
8. Taking the record of output power at antenna port.
9. Repeat step 7 to step 8 for another polarization.
10. The RF fundamental frequency should be excluded against the limit line in the operating frequency band.

The limit line is derived from $43 + 10\log(P)$ dB below the transmitter power P(Watts)

$EIRP \text{ (dBm)} = S.G. \text{ Power} - Tx \text{ Cable Loss} + Tx \text{ Antenna Gain}$

$ERP \text{ (dBm)} = EIRP - 2.15$



5 List of Measuring Equipment

Instrument	Brand Name	Model No.	Serial No.	Characteristics	Calibration Date	Test Date	Due Date	Remark
Loop Antenna	Rohde & Schwarz	HFH2-Z2	100315	9 kHz~30 MHz	Jan. 04, 2021	Jun. 16, 2021~ Jul. 09, 2021	Jan. 03, 2022	Radiation (03CH12-HY)
Bilog Antenna	TESEQ	CBL 6111D & 00800N1D01N -06	37059 & 01	30MHz~1GHz	Oct. 11, 2020	Jun. 16, 2021~ Jul. 09, 2021	Oct. 10, 2021	Radiation (03CH12-HY)
Horn Antenna	SCHWARZBE CK	BBHA 9120 D	9120D-1328	1GHz~18GHz	Nov. 23, 2020	Jun. 16, 2021~ Jul. 09, 2021	Nov. 22, 2021	Radiation (03CH12-HY)
Horn Antenna	SCHWARZBE CK	BBHA 9120 D	9120D-1212	1GHz~18GHz	May 05, 2021	Jun. 16, 2021~ Jul. 09, 2021	May 04, 2022	Radiation (03CH12-HY)
SHF-EHF Horn Antenna	SCHWARZBE CK	BBHA 9170	00993	18GHz~40GHz	Nov. 19, 2020	Jun. 16, 2021~ Jul. 09, 2021	Nov. 18, 2021	Radiation (03CH12-HY)
SHF-EHF Horn Antenna	SCHWARZBE CK	BBHA 9170	BBHA917057 6	18GHz~40GHz	May 21, 2021	Jun. 16, 2021~ Jul. 09, 2021	May 20, 2022	Radiation (03CH12-HY)
Preamplifier	COM-POWER	PA-103	161075	10MHz~1GHz	Mar. 24, 2021	Jun. 16, 2021~ Jul. 09, 2021	Mar. 23, 2022	Radiation (03CH12-HY)
Preamplifier	Keysight	83017A	MY57280120	1GHz~26.5GHz	Jul. 20, 2020	Jun. 16, 2021~ Jul. 09, 2021	Jul. 19, 2021	Radiation (03CH12-HY)
Preamplifier	E-INSTRUME NT TECH LTD.	ERA-100M-18 G-56-01-A70	EC1900249	1GHz-18GHz	Dec. 05, 2020	Jun. 16, 2021~ Jul. 09, 2021	Dec. 04, 2021	Radiation (03CH12-HY)
Preamplifier	EMEC	EM18G40G	060715	18GHz~40GHz	Dec. 11, 2020	Jun. 16, 2021~ Jul. 09, 2021	Dec. 10, 2021	Radiation (03CH12-HY)
Spectrum Analyzer	Agilent	N9010A	MY53470118	10Hz~44GHz	Jan. 15, 2021	Jun. 16, 2021~ Jul. 09, 2021	Jan. 14, 2022	Radiation (03CH12-HY)
RF Cable	HUBER + SUHNER	SUCOFLEX 104	MY9837/4PE	9kHz~30MHz	Mar. 11, 2021	Jun. 16, 2021~ Jul. 09, 2021	Mar. 10, 2022	Radiation (03CH12-HY)
RF Cable	HUBER + SUHNER	SUCOFLEX 126E	0058/126E	30MHz~18GHz	Dec. 11, 2020	Jun. 16, 2021~ Jul. 09, 2021	Dec. 10, 2021	Radiation (03CH12-HY)
RF Cable	HUBER + SUHNER	SUCOFLEX 102	505134/2	30MHz~40GHz	Feb. 22, 2021	Jun. 16, 2021~ Jul. 09, 2021	Feb. 21, 2022	Radiation (03CH12-HY)
RF Cable	HUBER + SUHNER	SUCOFLEX 102	800740/2	30MHz~40GHz	Feb. 22, 2021	Jun. 16, 2021~ Jul. 09, 2021	Feb. 21, 2022	Radiation (03CH12-HY)
Antenna Mast	EMEC	AM-BS-4500-B	N/A	1m~4m	N/A	Jun. 16, 2021~ Jul. 09, 2021	N/A	Radiation (03CH12-HY)
Turn Table	EMEC	TT2000	N/A	0~360 Degree	N/A	Jun. 16, 2021~ Jul. 09, 2021	N/A	Radiation (03CH12-HY)
Software	Audix	E3 6.2009-8-24	RK-000989	N/A	N/A	Jun. 16, 2021~ Jul. 09, 2021	N/A	Radiation (03CH12-HY)
Filter	Wainwright	WLKS1200-12 SS	SN2	1.2GHz Low Pass Filter	Mar. 17, 2021	Jun. 16, 2021~ Jul. 09, 2021	Mar. 16, 2022	Radiation (03CH12-HY)
Filter	Wainwright	WHKX12-2700 -3000-18000-6 0ST	SN2	3GHz High Pass Filter	Jul. 14, 2020	Jun. 16, 2021~ Jul. 09, 2021	Jul. 13, 2021	Radiation (03CH12-HY)
Filter	Wainwright	WHKX8-5872. 5-6750-18000- 40ST	SN2	6.75GHz High Pass Filter	Mar. 17, 2021	Jun. 16, 2021~ Jul. 09, 2021	Mar. 16, 2022	Radiation (03CH12-HY)



Instrument	Brand Name	Model No.	Serial No.	Characteristics	Calibration Date	Test Date	Due Date	Remark
Programmable Power Supply	GW Instek	PSS-2005	EL890001	50Hz~60Hz	Oct. 05, 2020	Jun. 08, 2021~ Aug. 05, 2021	Oct. 04, 2021	Conducted (TH03-HY)
Signal Analyzer	Rohde & Schwarz	FSV3044	101048	10Hz~44GHz	Apr. 20, 2021	Jun. 08, 2021~ Aug. 05, 2021	Apr. 19, 2022	Conducted (TH03-HY)
Temperature Chamber	ESPEC	SU-241	92003713	-30°C ~95°C	May 21, 2021	Jun. 08, 2021~ Aug. 05, 2021	May 20, 2022	Conducted (TH03-HY)
Hygrometer	Testo	608-H11	3489324	NA	Jan. 18, 2021	Jun. 08, 2021~ Aug. 05, 2021	Jan. 17, 2022	Conducted (TH03-HY)
Base Station (Measure)	Anritsu	MT8821C	6261849015	LTE	Sep. 18, 2020	Jun. 08, 2021~ Aug. 05, 2021	Sep. 17, 2021	Conducted (TH03-HY)
Base Station (Measure)	Anritsu	MT8000A	6261940327	FR1	Sep. 23, 2020	Jun. 08, 2021~ Aug. 05, 2021	Sep. 22, 2021	Conducted (TH03-HY)



6 Uncertainty of Evaluation

Uncertainty of Radiated Emission Measurement (30 MHz ~ 1000 MHz)

Measuring Uncertainty for a Level of Confidence of 95% ($U = 2Uc(y)$)	3.10 dB
---	---------

Uncertainty of Radiated Emission Measurement (1 GHz ~ 18 GHz)

Measuring Uncertainty for a Level of Confidence of 95% ($U = 2Uc(y)$)	3.39 dB
---	---------

Uncertainty of Radiated Emission Measurement (18 GHz ~ 40 GHz)

Measuring Uncertainty for a Level of Confidence of 95% ($U = 2Uc(y)$)	4.34 dB
---	---------



Appendix A. Test Results of Conducted Test

Conducted Output Power(Average power) and EIRP

<Primary Antenna>

NR n77 Maximum Average Power [dBm] (GT - LC = 0.5 dB)										
BW [MHz]	RB Size	RB Offset	Mod	Lowest	Middle	Highest	EIRP (dBm)	EIRP(W)		
10	1	1	PI/2 BPSK	24.11	24.01	23.88	24.84	0.3048		
10	1	22		24.10	23.96	24.00				
10	12	6		24.11	24.00	24.01				
10	1	0		22.78	22.71	22.60				
10	1	23		22.70	22.64	22.69				
10	24	0		22.82	22.70	22.70				
10	1	1	QPSK	24.31	24.25	24.11			23.84	0.2421
10	1	22		24.34	24.19	24.19				
10	12	6		24.33	24.21	24.24				
10	1	0		23.31	23.26	23.11				
10	1	23		23.37	23.17	23.24				
10	24	0		23.32	23.21	23.21				
10	1	1	16-QAM	23.34	23.24	23.30	23.84	0.2421		
10	1	1	64-QAM	21.84	21.92	21.78				
10	1	1	256-QAM	19.64	19.60	19.49				
Limit	EIRP < 1W			Result			Pass			

NR n77 Maximum Average Power [dBm] (GT - LC = 0.5 dB)										
BW [MHz]	RB Size	RB Offset	Mod	Lowest	Middle	Highest	EIRP (dBm)	EIRP(W)		
15	1	1	PI/2 BPSK	24.14	24.01	23.85	24.94	0.3119		
15	1	36		24.23	23.95	23.97				
15	18	9		24.21	24.04	23.92				
15	1	0		22.83	22.70	22.60				
15	1	37		22.92	22.62	22.65				
15	36	0		22.91	22.68	22.61				
15	1	1	QPSK	24.37	24.22	24.04			23.87	0.2438
15	1	36		24.44	24.14	24.15				
15	18	9		24.37	24.21	24.15				
15	1	0		23.29	23.25	23.04				
15	1	37		23.45	23.16	23.15				
15	36	0		23.38	23.20	23.11				
15	1	1	16-QAM	23.37	23.17	22.70	23.87	0.2438		
15	1	1	64-QAM	22.02	21.60	21.44				
15	1	1	256-QAM	19.81	19.53	19.62				
Limit	EIRP < 1W			Result			Pass			



NR n77 Maximum Average Power [dBm] (GT - LC = 0.5 dB)								
BW [MHz]	RB Size	RB Offset	Mod	Lowest	Middle	Highest	EIRP (dBm)	EIRP(W)
20	1	1	PI/2 BPSK	24.14	24.00	23.77	24.96	0.3133
20	1	49		24.16	23.85	23.91		
20	25	12		24.24	24.02	23.84		
20	1	0		22.83	22.68	22.49		
20	1	50		22.88	22.59	22.61		
20	50	0		22.90	22.70	22.54		
20	1	1	QPSK	24.43	24.20	23.99		
20	1	49		24.46	24.12	24.11		
20	25	12		24.42	24.23	24.07		
20	1	0		23.40	23.22	23.01		
20	1	50		23.43	23.14	23.12		
20	50	0		23.40	23.20	23.03		
20	1	1	16-QAM	23.19	23.01	23.04	23.69	0.2339
20	1	1	64-QAM	22.06	21.77	21.75		
20	1	1	256-QAM	20.04	19.73	19.32		
Limit	EIRP < 1W			Result			Pass	



NR n77 Maximum Average Power [dBm] (GT - LC = 0.5 dB)										
BW [MHz]	RB Size	RB Offset	Mod	Lowest	Middle	Highest	EIRP (dBm)	EIRP(W)		
30	1	1	PI/2 BPSK	23.97	23.86	23.82	24.87	0.3069		
30	1	76		24.01	23.84	23.89				
30	36	18		24.16	24.05	23.93				
30	1	0		22.64	22.56	22.50				
30	1	77		22.69	22.53	22.60				
30	75	0		22.80	22.70	22.59				
30	1	1	QPSK	24.16	24.08	24.00			23.6	0.2291
30	1	76		24.21	24.04	24.14				
30	36	18		24.37	24.23	24.13				
30	1	0		23.19	23.07	23.04				
30	1	77		23.22	23.03	23.15				
30	75	0		23.33	23.17	23.10				
30	1	1	16-QAM	23.09	23.01	23.10	23.6	0.2291		
30	1	1	64-QAM	21.79	21.50	21.83				
30	1	1	256-QAM	19.73	19.51	18.52				
Limit	EIRP < 1W			Result			Pass			

NR n77 Maximum Average Power [dBm] (GT - LC = 0.5 dB)										
BW [MHz]	RB Size	RB Offset	Mod	Lowest	Middle	Highest	EIRP (dBm)	EIRP(W)		
40	1	1	PI/2 BPSK	24.02	23.78	23.70	24.95	0.3126		
40	1	104		23.86	23.71	23.79				
40	50	25		24.23	24.01	23.84				
40	1	0		22.72	22.52	22.37				
40	1	105		22.59	22.41	22.51				
40	100	0		22.91	22.66	22.46				
40	1	1	QPSK	24.18	23.89	23.91			23.71	0.235
40	1	104		24.01	23.84	24.00				
40	50	25		24.45	24.20	24.03				
40	1	0		23.20	22.92	22.85				
40	1	105		23.05	22.89	22.98				
40	100	0		23.38	23.16	23.00				
40	1	1	16-QAM	23.21	23.01	22.77	23.71	0.235		
40	1	1	64-QAM	21.98	21.49	21.49				
40	1	1	256-QAM	19.93	19.55	19.20				
Limit	EIRP < 1W			Result			Pass			



NR n77 Maximum Average Power [dBm] (GT - LC = 0.5 dB)										
BW [MHz]	RB Size	RB Offset	Mod	Lowest	Middle	Highest	EIRP (dBm)	EIRP(W)		
50	1	1	PI/2 BPSK	23.84	23.83	23.56	24.79	0.3013		
50	1	131		23.77	23.67	23.67				
50	64	32		24.09	23.97	23.73				
50	1	0		22.51	22.56	22.26				
50	1	132		22.49	22.37	22.37				
50	128	0		22.73	22.62	22.37				
50	1	1	QPSK	24.06	24.01	23.77			23.69	0.2339
50	1	131		24.04	23.81	23.88				
50	64	32		24.29	24.17	23.93				
50	1	0		23.08	23.00	22.78				
50	1	132		23.04	22.83	22.91				
50	128	0		23.23	23.12	22.90				
50	1	1	16-QAM	23.19	22.98	22.68	23.69	0.2339		
50	1	1	64-QAM	21.49	21.73	21.29				
50	1	1	256-QAM	19.38	19.34	19.31				
Limit	EIRP < 1W			Result			Pass			

NR n77 Maximum Average Power [dBm] (GT - LC = 0.5 dB)										
BW [MHz]	RB Size	RB Offset	Mod	Lowest	Middle	Highest	EIRP (dBm)	EIRP(W)		
60	1	1	PI/2 BPSK	23.83	23.81	23.67	24.83	0.3041		
60	1	160		23.64	23.53	23.66				
60	81	40		24.14	23.94	23.81				
60	1	0		22.50	22.49	22.35				
60	1	161		22.34	22.25	22.33				
60	162	0		22.55	22.52	22.42				
60	1	1	QPSK	24.00	24.00	23.84			23.83	0.2415
60	1	160		23.76	23.75	23.83				
60	81	40		24.33	24.18	24.01				
60	1	0		23.01	23.08	22.80				
60	1	161		22.81	22.78	22.85				
60	162	0		23.07	23.06	22.92				
60	1	1	16-QAM	23.33	22.77	22.73	23.83	0.2415		
60	1	1	64-QAM	21.62	21.68	21.58				
60	1	1	256-QAM	19.48	19.48	19.37				
Limit	EIRP < 1W			Result			Pass			



NR n77 Maximum Average Power [dBm] (GT - LC = 0.5 dB)								
BW [MHz]	RB Size	RB Offset	Mod	Lowest	Middle	Highest	EIRP (dBm)	EIRP(W)
70	1	1	PI/2 BPSK	23.70	23.80	23.65	24.64	0.2911
70	1	187		23.61	23.51	23.57		
70	90	45		23.85	23.96	23.90		
70	1	0		22.44	22.48	22.34		
70	1	188		22.31	22.22	22.23		
70	180	0		22.45	22.55	22.51		
70	1	1	QPSK	23.92	24.01	23.82		
70	1	187		23.81	23.76	23.75		
70	90	45		24.07	24.14	24.10		
70	1	0		22.97	23.00	22.83		
70	1	188		22.87	22.75	22.74		
70	180	0		22.95	23.04	23.00		
70	1	1	16-QAM	22.96	23.35	22.63	23.85	0.2427
70	1	1	64-QAM	21.32	21.10	21.26		
70	1	1	256-QAM	19.23	19.70	19.45		
Limit	EIRP < 1W			Result			Pass	

NR n77 Maximum Average Power [dBm] (GT - LC = 0.5 dB)								
BW [MHz]	RB Size	RB Offset	Mod	Lowest	Middle	Highest	EIRP (dBm)	EIRP(W)
80	1	1	PI/2 BPSK	23.79	23.76	23.81	24.72	0.2965
80	1	215		23.59	23.56	23.67		
80	108	54		24.04	23.91	23.86		
80	1	0		22.49	22.45	22.50		
80	1	216		22.33	22.27	22.40		
80	216	0		22.60	22.50	22.44		
80	1	1	QPSK	24.04	23.98	24.00		
80	1	215		23.85	23.81	23.87		
80	108	54		24.22	24.12	24.06		
80	1	0		23.03	23.00	22.99		
80	1	216		22.85	22.78	22.89		
80	216	0		23.12	23.01	22.95		
80	1	1	16-QAM	23.14	22.98	23.07	23.64	0.2312
80	1	1	64-QAM	21.61	21.61	21.18		
80	1	1	256-QAM	19.45	19.66	19.56		
Limit	EIRP < 1W			Result			Pass	



NR n77 Maximum Average Power [dBm] (GT - LC = 0.5 dB)								
BW [MHz]	RB Size	RB Offset	Mod	Lowest	Middle	Highest	EIRP (dBm)	EIRP(W)
90	1	1	PI/2 BPSK	23.86	23.91	23.90	24.68	0.2938
90	1	243		23.79	23.80	23.70		
90	120	60		23.89	23.94	23.96		
90	1	0		22.55	22.61	22.61		
90	1	244		22.47	22.45	22.37		
90	243	0		22.53	22.50	22.55		
90	1	1	QPSK	23.98	24.08	24.09		
90	1	243		23.91	24.01	23.92		
90	120	60		24.10	24.17	24.18		
90	1	0		23.06	23.15	23.20		
90	1	244		22.92	22.98	22.96		
90	243	0		23.01	23.03	23.01		
90	1	1	16-QAM	23.39	23.31	23.22	23.89	0.2449
90	1	1	64-QAM	21.93	21.54	21.55		
90	1	1	256-QAM	19.35	19.71	19.52		
Limit	EIRP < 1W			Result			Pass	

NR n77 Maximum Average Power [dBm] (GT - LC = 0.5 dB)								
BW [MHz]	RB Size	RB Offset	Mod	Lowest	Middle	Highest	EIRP (dBm)	EIRP(W)
100	1	1	PI/2 BPSK	-	24.09	-	24.83	0.3041
100	1	271		-	23.96	-		
100	135	67		-	22.63	-		
100	1	0		-	22.81	-		
100	1	272		-	22.68	-		
100	270	0		-	22.55	-		
100	1	1	QPSK	-	24.33	-		
100	1	271		-	24.22	-		
100	135	67		-	23.15	-		
100	1	0		-	23.32	-		
100	1	272		-	23.21	-		
100	270	0		-	23.07	-		
100	1	1	16-QAM	-	23.21	-	23.71	0.2350
100	1	1	64-QAM	-	21.76	-		
100	1	1	256-QAM	-	19.67	-		
Limit	EIRP < 1W			Result			Pass	



NR n77 (HPUE) Maximum Average Power [dBm] (GT - LC = 0.5 dB)								
BW [MHz]	RB Size	RB Offset	Mod	Lowest	Middle	Highest	EIRP (dBm)	EIRP(W)
10	1	1	PI/2 BPSK	26.61	26.64	26.62	27.28	0.5346
10	1	22		26.64	26.61	26.73		
10	12	6		26.61	26.66	26.78		
10	1	0		23.11	23.17	23.16		
10	1	23		23.10	23.08	23.24		
10	24	0		26.12	26.15	26.26		
10	1	1	QPSK	26.66	26.67	26.65		
10	1	22		26.67	26.64	26.73		
10	12	6		26.62	26.64	26.74		
10	1	0		23.11	23.17	23.12		
10	1	23		23.11	23.11	23.19		
10	24	0		25.60	25.65	25.76		
10	1	1	16-QAM	25.52	25.50	25.77	26.27	0.4236
10	1	1	64-QAM	24.15	24.19	24.24		
10	1	1	256-QAM	21.96	22.21	22.11		
Limit	EIRP < 1W			Result			Pass	

NR n77 (HPUE) Maximum Average Power [dBm] (GT - LC = 0.5 dB)								
BW [MHz]	RB Size	RB Offset	Mod	Lowest	Middle	Highest	EIRP (dBm)	EIRP(W)
15	1	1	PI/2 BPSK	26.61	26.64	26.57	27.21	0.5260
15	1	36		26.70	26.56	26.71		
15	18	9		26.66	26.62	26.63		
15	1	0		23.09	23.13	23.05		
15	1	37		23.15	23.06	23.15		
15	36	0		26.15	26.10	26.11		
15	1	1	QPSK	26.61	26.66	26.56		
15	1	36		26.62	26.59	26.67		
15	18	9		26.67	26.65	26.66		
15	1	0		23.10	23.20	23.05		
15	1	37		23.14	23.09	23.19		
15	36	0		25.65	25.65	25.64		
15	1	1	16-QAM	25.69	25.70	25.45	26.2	0.4169
15	1	1	64-QAM	24.33	24.44	24.02		
15	1	1	256-QAM	22.01	21.99	22.07		
Limit	EIRP < 1W			Result			Pass	



NR n77 (HPUE) Maximum Average Power [dBm] (GT - LC = 0.5 dB)								
BW [MHz]	RB Size	RB Offset	Mod	Lowest	Middle	Highest	EIRP (dBm)	EIRP(W)
20	1	1	PI/2 BPSK	26.62	26.63	26.41	27.22	0.5272
20	1	49		26.63	26.46	26.58		
20	25	12		26.68	26.62	26.56		
20	1	0		23.11	23.15	22.90		
20	1	50		23.12	22.97	23.07		
20	50	0		26.16	26.12	26.30		
20	1	1	QPSK	26.60	26.62	26.40		
20	1	49		26.63	26.44	26.58		
20	25	12		26.72	26.65	26.54		
20	1	0		23.09	23.11	22.91		
20	1	50		23.11	22.97	23.07		
20	50	0		25.64	25.61	25.55		
20	1	1	16-QAM	25.48	25.27	25.27	25.98	0.3963
20	1	1	64-QAM	24.12	24.26	23.89		
20	1	1	256-QAM	22.11	22.12	21.75		
Limit	EIRP < 1W			Result			Pass	



NR n77 (HPUE) Maximum Average Power [dBm] (GT - LC = 0.5 dB)								
BW [MHz]	RB Size	RB Offset	Mod	Lowest	Middle	Highest	EIRP (dBm)	EIRP(W)
30	1	1	PI/2 BPSK	26.46	26.41	26.39	27.16	0.5200
30	1	76		26.56	26.41	26.64		
30	36	18		26.62	26.66	26.61		
30	1	0		22.96	22.93	22.88		
30	1	77		23.06	22.84	23.11		
30	75	0		26.12	26.07	26.05		
30	1	1	QPSK	26.45	26.37	26.41		
30	1	76		26.56	26.35	26.64		
30	36	18		26.64	26.64	26.64		
30	1	0		22.97	22.85	22.93		
30	1	77		23.09	22.82	23.15		
30	75	0		25.59	25.59	25.59		
30	1	1	16-QAM	25.26	25.45	25.30	25.95	0.3936
30	1	1	64-QAM	23.82	23.77	24.11		
30	1	1	256-QAM	22.12	21.77	21.74		
Limit	EIRP < 1W			Result			Pass	

NR n77 (HPUE) Maximum Average Power [dBm] (GT - LC = 0.5 dB)								
BW [MHz]	RB Size	RB Offset	Mod	Lowest	Middle	Highest	EIRP (dBm)	EIRP(W)
40	1	1	PI/2 BPSK	26.50	26.31	26.24	27.2	0.5248
40	1	104		24.48	26.31	26.50		
40	50	25		26.70	26.57	26.46		
40	1	0		22.92	22.79	22.74		
40	1	105		23.01	22.71	22.96		
40	100	0		26.15	26.03	25.96		
40	1	1	QPSK	26.48	26.19	26.17		
40	1	104		26.48	26.32	26.43		
40	50	25		26.67	26.61	26.47		
40	1	0		22.99	22.80	22.70		
40	1	105		22.95	22.69	22.91		
40	100	0		25.65	25.54	25.40		
40	1	1	16-QAM	25.66	25.07	25.13	26.16	0.4130
40	1	1	64-QAM	23.95	23.59	23.81		
40	1	1	256-QAM	22.00	22.54	21.66		
Limit	EIRP < 1W			Result			Pass	



NR n77 (HPUE) Maximum Average Power [dBm] (GT - LC = 0.5 dB)								
BW [MHz]	RB Size	RB Offset	Mod	Lowest	Middle	Highest	EIRP (dBm)	EIRP(W)
50	1	1	PI/2 BPSK	26.22	26.33	26.22	27.11	0.5140
50	1	131		26.44	26.24	26.35		
50	64	32		26.57	26.61	26.35		
50	1	0		22.77	22.83	22.67		
50	1	132		22.92	22.71	22.87		
50	128	0		26.03	25.97	25.81		
50	1	1	QPSK	26.27	26.32	26.12		
50	1	131		26.42	26.27	26.27		
50	64	32		26.59	26.58	26.34		
50	1	0		22.73	22.81	22.62		
50	1	132		22.92	22.75	22.76		
50	128	0		25.52	25.47	25.30		
50	1	1	16-QAM	25.27	25.44	25.27	25.94	0.3926
50	1	1	64-QAM	23.49	23.87	23.81		
50	1	1	256-QAM	22.02	21.80	21.68		
Limit	EIRP < 1W			Result			Pass	

NR n77 (HPUE) Maximum Average Power [dBm] (GT - LC = 0.5 dB)								
BW [MHz]	RB Size	RB Offset	Mod	Lowest	Middle	Highest	EIRP (dBm)	EIRP(W)
60	1	1	PI/2 BPSK	26.29	26.24	26.28	27.18	0.5224
60	1	160		26.21	26.19	26.36		
60	81	40		26.68	26.57	26.43		
60	1	0		22.78	22.73	22.78		
60	1	161		22.75	22.67	22.85		
60	162	0		25.91	25.94	25.85		
60	1	1	QPSK	26.33	26.28	26.22		
60	1	160		26.30	22.61	26.28		
60	81	40		26.67	26.54	26.41		
60	1	0		22.82	22.77	22.75		
60	1	161		22.75	22.65	22.77		
60	162	0		25.42	25.42	25.35		
60	1	1	16-QAM	25.37	25.16	25.11	25.87	0.3864
60	1	1	64-QAM	23.76	23.72	23.84		
60	1	1	256-QAM	21.33	21.50	21.80		
Limit	EIRP < 1W			Result			Pass	



NR n77 (HPUE) Maximum Average Power [dBm] (GT - LC = 0.5 dB)										
BW [MHz]	RB Size	RB Offset	Mod	Lowest	Middle	Highest	EIRP (dBm)	EIRP(W)		
70	1	1	PI/2 BPSK	26.18	26.18	26.18	27.05	0.5070		
70	1	187		26.17	26.21	26.28				
70	90	45		26.41	26.55	26.53				
70	1	0		22.68	22.69	22.66				
70	1	188		22.68	22.67	22.75				
70	180	0		25.79	25.89	25.94				
70	1	1	QPSK	26.19	26.17	26.19			25.7	0.3715
70	1	187		26.19	26.17	26.25				
70	90	45		26.41	26.53	26.49				
70	1	0		22.67	22.69	22.68				
70	1	188		22.67	22.68	22.75				
70	180	0		25.30	25.42	25.42				
70	1	1	16-QAM	25.20	24.98	25.16	25.7	0.3715		
70	1	1	64-QAM	23.81	23.93	23.81				
70	1	1	256-QAM	21.64	21.94	21.52				
Limit	EIRP < 1W			Result			Pass			

NR n77 (HPUE) Maximum Average Power [dBm] (GT - LC = 0.5 dB)										
BW [MHz]	RB Size	RB Offset	Mod	Lowest	Middle	Highest	EIRP (dBm)	EIRP(W)		
80	1	1	PI/2 BPSK	26.26	26.20	26.24	27.12	0.5152		
80	1	215		26.15	26.31	26.35				
80	108	54		26.62	26.51	26.42				
80	1	0		22.76	22.67	22.72				
80	1	216		22.71	22.79	22.85				
80	216	0		25.93	25.87	25.83				
80	1	1	QPSK	26.19	26.17	26.17			25.6	0.3631
80	1	215		26.17	26.23	26.35				
80	108	54		26.61	26.53	26.42				
80	1	0		22.73	22.73	22.65				
80	1	216		22.69	22.81	22.82				
80	216	0		25.45	25.37	25.30				
80	1	1	16-QAM	25.10	24.91	24.86	25.6	0.3631		
80	1	1	64-QAM	24.04	23.66	23.55				
80	1	1	256-QAM	21.82	21.71	21.96				
Limit	EIRP < 1W			Result			Pass			



NR n77 (HPUE) Maximum Average Power [dBm] (GT - LC = 0.5 dB)								
BW [MHz]	RB Size	RB Offset	Mod	Lowest	Middle	Highest	EIRP (dBm)	EIRP(W)
90	1	1	PI/2 BPSK	26.30	26.30	26.33	27.06	0.5082
90	1	243		26.44	26.45	26.34		
90	120	60		26.43	26.49	26.53		
90	1	0		22.79	22.79	22.81		
90	1	244		22.94	22.96	22.87		
90	243	0		25.86	25.87	25.88		
90	1	1	QPSK	26.32	26.39	26.34		
90	1	243		26.45	26.48	26.34		
90	120	60		26.43	26.52	26.56		
90	1	0		22.75	22.85	22.77		
90	1	244		22.96	23.04	22.82		
90	243	0		25.35	25.36	25.39		
90	1	1	16-QAM	25.14	25.27	25.18	25.77	0.3776
90	1	1	64-QAM	23.90	24.07	23.87		
90	1	1	256-QAM	21.98	21.62	21.60		
Limit	EIRP < 1W			Result			Pass	

NR n77 (HPUE) Maximum Average Power [dBm] (GT - LC = 0.5 dB)								
BW [MHz]	RB Size	RB Offset	Mod	Lowest	Middle	Highest	EIRP (dBm)	EIRP(W)
100	1	1	PI/2 BPSK	-	26.51	-	27.11	0.5140
100	1	271		-	26.61	-		
100	135	67		-	26.44	-		
100	1	0		-	23.00	-		
100	1	272		-	23.11	-		
100	270	0		-	25.82	-		
100	1	1	QPSK	-	26.50	-		
100	1	271		-	26.60	-		
100	135	67		-	26.44	-		
100	1	0		-	22.99	-		
100	1	272		-	23.16	-		
100	270	0		-	25.43	-		
100	1	1	16-QAM	-	25.33	-	25.83	0.3828
100	1	1	64-QAM	-	23.85	-		
100	1	1	256-QAM	-	22.21	-		
Limit	EIRP < 1W			Result			Pass	



<ASDIV Antenna>

NR n77 Maximum Average Power [dBm] (GT - LC = -0.5 dB)										
BW [MHz]	RB Size	RB Offset	Mod	Lowest	Middle	Highest	EIRP (dBm)	EIRP(W)		
10	1	1	PI/2 BPSK	24.01	24.20	24.07	23.94	0.2477		
10	1	22		24.11	23.87	23.98				
10	12	6		24.04	24.09	24.10				
10	1	0		22.84	22.71	22.50				
10	1	23		22.78	22.56	22.70				
10	24	0		22.73	22.87	22.88				
10	1	1	QPSK	24.16	24.35	24.30			23.94	0.2477
10	1	22		24.44	24.29	24.13				
10	12	6		24.32	24.17	24.22				
10	1	0		23.33	23.33	23.02				
10	1	23		23.34	23.16	23.26				
10	24	0		23.28	23.36	23.41				
10	1	1	16-QAM	23.24	23.27	23.34	22.84	0.1923		
10	1	1	64-QAM	21.51	21.97	21.81				
10	1	1	256-QAM	19.64	19.86	19.70				
Limit	EIRP < 1W			Result			Pass			

NR n77 Maximum Average Power [dBm] (GT - LC = -0.5 dB)										
BW [MHz]	RB Size	RB Offset	Mod	Lowest	Middle	Highest	EIRP (dBm)	EIRP(W)		
15	1	1	PI/2 BPSK	24.04	24.15	24.01	23.86	0.2432		
15	1	36		24.28	23.99	24.05				
15	18	9		24.20	24.01	23.83				
15	1	0		22.77	22.67	22.58				
15	1	37		22.85	22.58	22.66				
15	36	0		22.79	22.83	22.75				
15	1	1	QPSK	24.23	24.31	24.24			23.86	0.2432
15	1	36		24.36	24.22	24.18				
15	18	9		24.30	24.11	24.18				
15	1	0		23.34	23.30	23.10				
15	1	37		23.41	23.21	23.05				
15	36	0		23.29	23.36	23.24				
15	1	1	16-QAM	23.32	23.18	23.24	22.82	0.1914		
15	1	1	64-QAM	21.67	21.94	21.77				
15	1	1	256-QAM	19.60	19.67	19.79				
Limit	EIRP < 1W			Result			Pass			



NR n77 Maximum Average Power [dBm] (GT - LC = -0.5 dB)								
BW [MHz]	RB Size	RB Offset	Mod	Lowest	Middle	Highest	EIRP (dBm)	EIRP(W)
20	1	1	PI/2 BPSK	24.04	23.91	23.92	24.04	0.2535
20	1	49		24.22	23.87	23.83		
20	25	12		24.26	23.95	23.78		
20	1	0		22.90	22.58	22.49		
20	1	50		22.91	22.68	22.54		
20	50	0		22.82	22.85	22.67		
20	1	1	QPSK	24.25	24.11	24.13		
20	1	49		24.54	24.12	24.06		
20	25	12		24.37	24.19	24.07		
20	1	0		23.41	23.30	23.10		
20	1	50		23.51	23.12	23.15		
20	50	0		23.34	23.36	23.16		
20	1	1	16-QAM	23.19	23.17	23.17	22.69	0.1858
20	1	1	64-QAM	21.66	21.57	21.60		
20	1	1	256-QAM	19.74	19.68	19.52		
Limit	EIRP < 1W			Result			Pass	



NR n77 Maximum Average Power [dBm] (GT - LC = -0.5 dB)								
BW [MHz]	RB Size	RB Offset	Mod	Lowest	Middle	Highest	EIRP (dBm)	EIRP(W)
30	1	1	PI/2 BPSK	23.91	24.14	24.17	23.93	0.2472
30	1	76		24.02	23.83	23.85		
30	36	18		24.19	23.97	23.89		
30	1	0		22.62	22.61	22.57		
30	1	77		22.77	22.62	22.61		
30	75	0		22.70	22.81	22.81		
30	1	1	QPSK	24.07	24.32	24.43		
30	1	76		24.20	23.96	24.08		
30	36	18		24.41	24.27	24.17		
30	1	0		23.19	23.12	23.06		
30	1	77		23.31	22.97	23.16		
30	75	0		23.22	23.33	23.33		
30	1	1	16-QAM	23.16	23.37	23.38	22.88	0.1941
30	1	1	64-QAM	21.64	21.94	21.87		
30	1	1	256-QAM	19.63	19.82	19.89		
Limit	EIRP < 1W			Result			Pass	

NR n77 Maximum Average Power [dBm] (GT - LC = -0.5 dB)								
BW [MHz]	RB Size	RB Offset	Mod	Lowest	Middle	Highest	EIRP (dBm)	EIRP(W)
40	1	1	PI/2 BPSK	23.94	24.04	24.20	24.04	0.2535
40	1	104		23.79	23.80	23.83		
40	50	25		24.15	24.00	23.77		
40	1	0		22.77	22.56	22.30		
40	1	105		22.56	22.40	22.58		
40	100	0		22.81	22.78	22.71		
40	1	1	QPSK	24.15	24.18	24.26		
40	1	104		23.98	23.78	23.93		
40	50	25		24.54	24.10	23.99		
40	1	0		23.26	22.90	22.81		
40	1	105		23.09	22.97	22.92		
40	100	0		23.30	23.28	23.21		
40	1	1	16-QAM	23.04	23.30	23.12	22.8	0.1905
40	1	1	64-QAM	21.64	21.81	21.86		
40	1	1	256-QAM	19.50	19.91	19.92		
Limit	EIRP < 1W			Result			Pass	



NR n77 Maximum Average Power [dBm] (GT - LC = -0.5 dB)										
BW [MHz]	RB Size	RB Offset	Mod	Lowest	Middle	Highest	EIRP (dBm)	EIRP(W)		
50	1	1	PI/2 BPSK	23.77	23.84	23.86	23.85	0.2427		
50	1	131		23.78	23.77	23.61				
50	64	32		24.12	23.93	23.63				
50	1	0		22.57	22.55	22.26				
50	1	132		22.45	22.39	22.29				
50	128	0		22.70	22.74	22.72				
50	1	1	QPSK	24.00	23.95	24.04			22.52	0.1786
50	1	131		24.14	23.77	23.79				
50	64	32		24.35	24.08	24.02				
50	1	0		23.17	23.07	22.70				
50	1	132		23.05	22.81	22.94				
50	128	0		23.24	23.26	23.18				
50	1	1	16-QAM	22.94	22.97	23.02	22.52	0.1786		
50	1	1	64-QAM	21.53	21.63	21.64				
50	1	1	256-QAM	19.41	19.38	19.35				
Limit	EIRP < 1W			Result			Pass			

NR n77 Maximum Average Power [dBm] (GT - LC = -0.5 dB)										
BW [MHz]	RB Size	RB Offset	Mod	Lowest	Middle	Highest	EIRP (dBm)	EIRP(W)		
60	1	1	PI/2 BPSK	23.82	23.78	23.87	23.81	0.2404		
60	1	160		23.68	23.55	23.60				
60	81	40		24.21	23.99	23.76				
60	1	0		22.56	22.41	22.32				
60	1	161		22.27	22.18	22.29				
60	162	0		22.90	22.71	22.81				
60	1	1	QPSK	23.97	24.02	23.99			22.44	0.1754
60	1	160		23.75	23.72	23.92				
60	81	40		24.31	24.18	23.99				
60	1	0		23.00	22.99	22.71				
60	1	161		22.79	22.73	22.76				
60	162	0		23.38	23.20	23.27				
60	1	1	16-QAM	22.94	22.63	22.86	22.44	0.1754		
60	1	1	64-QAM	21.47	21.51	21.57				
60	1	1	256-QAM	19.37	19.47	19.78				
Limit	EIRP < 1W			Result			Pass			



NR n77 Maximum Average Power [dBm] (GT - LC = -0.5 dB)								
BW [MHz]	RB Size	RB Offset	Mod	Lowest	Middle	Highest	EIRP (dBm)	EIRP(W)
70	1	1	PI/2 BPSK	23.71	23.38	23.51	23.67	0.2328
70	1	187		23.58	23.47	23.53		
70	90	45		23.85	23.92	23.83		
70	1	0		22.36	22.51	22.35		
70	1	188		22.33	22.22	22.18		
70	180	0		22.80	22.57	22.59		
70	1	1	QPSK	23.94	23.55	23.71		
70	1	187		23.74	23.85	23.74		
70	90	45		23.99	24.16	24.17		
70	1	0		22.94	23.04	22.80		
70	1	188		22.90	22.78	22.71		
70	180	0		23.31	22.71	22.76		
70	1	1	16-QAM	22.87	22.62	22.59	22.37	0.1726
70	1	1	64-QAM	21.65	21.30	21.57		
70	1	1	256-QAM	19.57	19.79	19.62		
Limit	EIRP < 1W			Result			Pass	

NR n77 Maximum Average Power [dBm] (GT - LC = -0.5 dB)								
BW [MHz]	RB Size	RB Offset	Mod	Lowest	Middle	Highest	EIRP (dBm)	EIRP(W)
80	1	1	PI/2 BPSK	23.81	23.38	23.44	23.70	0.2344
80	1	215		23.54	23.47	23.71		
80	108	54		24.12	23.98	23.81		
80	1	0		22.59	22.36	22.43		
80	1	216		22.30	22.27	22.33		
80	216	0		22.75	22.50	22.41		
80	1	1	QPSK	24.03	23.56	23.65		
80	1	215		23.95	23.80	23.84		
80	108	54		24.20	24.20	23.99		
80	1	0		22.98	22.95	22.95		
80	1	216		22.91	22.70	22.85		
80	216	0		23.25	22.73	22.73		
80	1	1	16-QAM	23.01	22.71	22.41	22.51	0.1782
80	1	1	64-QAM	21.82	21.22	21.23		
80	1	1	256-QAM	19.44	19.55	19.70		
Limit	EIRP < 1W			Result			Pass	



NR n77 Maximum Average Power [dBm] (GT - LC = -0.5 dB)								
BW [MHz]	RB Size	RB Offset	Mod	Lowest	Middle	Highest	EIRP (dBm)	EIRP(W)
90	1	1	PI/2 BPSK	23.90	23.41	23.47	23.69	0.2339
90	1	243		23.87	23.80	23.76		
90	120	60		23.96	23.97	24.04		
90	1	0		22.50	22.70	22.57		
90	1	244		22.54	22.54	22.39		
90	243	0		22.64	22.54	22.58		
90	1	1	QPSK	24.07	23.62	23.64		
90	1	243		24.00	23.92	23.99		
90	120	60		24.09	24.16	24.19		
90	1	0		22.97	23.11	23.18		
90	1	244		22.87	23.02	22.93		
90	243	0		23.18	22.73	22.78		
90	1	1	16-QAM	23.18	22.61	22.80	22.68	0.1854
90	1	1	64-QAM	21.85	21.16	21.23		
90	1	1	256-QAM	19.53	19.87	19.90		
Limit	EIRP < 1W			Result			Pass	

NR n77 Maximum Average Power [dBm] (GT - LC = -0.5 dB)								
BW [MHz]	RB Size	RB Offset	Mod	Lowest	Middle	Highest	EIRP (dBm)	EIRP(W)
100	1	1	PI/2 BPSK	-	23.36	-	23.65	0.2317
100	1	271		-	23.92	-		
100	135	67		-	22.55	-		
100	1	0		-	22.77	-		
100	1	272		-	22.61	-		
100	270	0		-	22.56	-		
100	1	1	QPSK	-	23.50	-		
100	1	271		-	24.15	-		
100	135	67		-	23.11	-		
100	1	0		-	23.29	-		
100	1	272		-	23.30	-		
100	270	0		-	22.67	-		
100	1	1	16-QAM	-	22.50	-	22.00	0.1585
100	1	1	64-QAM	-	21.37	-		
100	1	1	256-QAM	-	19.61	-		
Limit	EIRP < 1W			Result			Pass	



NR n77 (HPUE) Maximum Average Power [dBm] (GT - LC = -0.5 dB)								
BW [MHz]	RB Size	RB Offset	Mod	Lowest	Middle	Highest	EIRP (dBm)	EIRP(W)
10	1	1	PI/2 BPSK	26.25	26.46	26.51	26.19	0.4159
10	1	22		26.34	26.40	26.66		
10	12	6		26.34	26.43	26.69		
10	1	0		22.74	22.95	23.03		
10	1	23		22.85	22.89	23.15		
10	24	0		25.84	25.91	26.18		
10	1	1	QPSK	26.22	26.53	26.56		
10	1	22		26.34	26.45	26.64		
10	12	6		26.38	26.43	26.68		
10	1	0		22.78	22.98	23.03		
10	1	23		22.85	22.91	23.13		
10	24	0		25.36	25.41	25.67		
10	1	1	16-QAM	25.36	25.44	25.47	24.97	0.3141
10	1	1	64-QAM	23.94	23.84	24.19		
10	1	1	256-QAM	21.80	22.07	21.90		
Limit	EIRP < 1W			Result			Pass	

NR n77 (HPUE) Maximum Average Power [dBm] (GT - LC = -0.5 dB)								
BW [MHz]	RB Size	RB Offset	Mod	Lowest	Middle	Highest	EIRP (dBm)	EIRP(W)
15	1	1	PI/2 BPSK	26.30	26.45	26.45	26.01	0.3990
15	1	36		26.42	26.41	26.40		
15	18	9		26.40	26.42	26.49		
15	1	0		22.78	22.94	22.95		
15	1	37		22.94	22.91	23.08		
15	36	0		25.91	25.94	26.00		
15	1	1	QPSK	26.23	26.47	26.38		
15	1	36		26.36	26.40	26.30		
15	18	9		26.40	26.44	26.51		
15	1	0		22.76	22.93	22.98		
15	1	37		22.90	22.87	23.07		
15	36	0		25.40	25.42	25.50		
15	1	1	16-QAM	25.20	25.30	25.51	25.01	0.3170
15	1	1	64-QAM	23.72	23.99	23.97		
15	1	1	256-QAM	21.59	21.62	21.99		
Limit	EIRP < 1W			Result			Pass	



NR n77 (HPUE) Maximum Average Power [dBm] (GT - LC = -0.5 dB)								
BW [MHz]	RB Size	RB Offset	Mod	Lowest	Middle	Highest	EIRP (dBm)	EIRP(W)
20	1	1	PI/2 BPSK	26.31	26.30	26.20	25.99	0.3972
20	1	49		26.47	26.41	26.13		
20	25	12		26.45	26.44	26.46		
20	1	0		22.78	22.79	22.79		
20	1	50		22.94	22.96	22.89		
20	50	0		25.99	25.91	25.95		
20	1	1	QPSK	26.32	26.24	26.15		
20	1	49		26.47	26.34	26.01		
20	25	12		26.49	26.43	26.48		
20	1	0		22.78	22.75	22.78		
20	1	50		22.95	22.94	22.90		
20	50	0		25.48	25.42	25.44		
20	1	1	16-QAM	25.44	25.11	25.26	24.94	0.3119
20	1	1	64-QAM	23.91	23.67	23.74		
20	1	1	256-QAM	21.85	21.85	21.70		
Limit	EIRP < 1W			Result			Pass	



NR n77 (HPUE) Maximum Average Power [dBm] (GT - LC = -0.5 dB)								
BW [MHz]	RB Size	RB Offset	Mod	Lowest	Middle	Highest	EIRP (dBm)	EIRP(W)
30	1	1	PI/2 BPSK	26.17	26.45	26.50	26.12	0.4093
30	1	76		26.34	26.44	26.57		
30	36	18		26.34	26.39	26.54		
30	1	0		22.63	22.92	22.99		
30	1	77		22.88	22.91	23.03		
30	75	0		25.84	25.89	26.03		
30	1	1	QPSK	26.15	26.43	26.55		
30	1	76		26.37	26.43	26.62		
30	36	18		26.37	26.42	26.51		
30	1	0		22.57	22.96	23.05		
30	1	77		22.83	22.94	23.06		
30	75	0		25.30	25.40	25.53		
30	1	1	16-QAM	25.20	25.52	25.43	25.02	0.3177
30	1	1	64-QAM	23.53	23.75	24.11		
30	1	1	256-QAM	21.75	21.94	21.98		
Limit	EIRP < 1W			Result			Pass	

NR n77 (HPUE) Maximum Average Power [dBm] (GT - LC = -0.5 dB)								
BW [MHz]	RB Size	RB Offset	Mod	Lowest	Middle	Highest	EIRP (dBm)	EIRP(W)
40	1	1	PI/2 BPSK	26.17	26.42	26.34	26	0.3981
40	1	104		26.50	26.38	26.49		
40	50	25		26.49	26.40	26.40		
40	1	0		22.66	22.92	22.76		
40	1	105		22.98	22.90	22.94		
40	100	0		25.90	25.86	25.82		
40	1	1	QPSK	26.13	26.37	26.32		
40	1	104		26.50	26.41	26.43		
40	50	25		26.48	26.41	26.40		
40	1	0		22.64	22.87	22.76		
40	1	105		22.93	22.89	22.92		
40	100	0		25.41	25.36	25.33		
40	1	1	16-QAM	25.20	25.31	25.40	24.9	0.3090
40	1	1	64-QAM	23.60	24.07	24.04		
40	1	1	256-QAM	21.84	21.85	21.99		
Limit	EIRP < 1W			Result			Pass	



NR n77 (HPUE) Maximum Average Power [dBm] (GT - LC = -0.5 dB)								
BW [MHz]	RB Size	RB Offset	Mod	Lowest	Middle	Highest	EIRP (dBm)	EIRP(W)
50	1	1	PI/2 BPSK	26.01	26.13	26.10	25.95	0.3936
50	1	131		26.24	26.04	25.88		
50	64	32		26.39	26.36	26.24		
50	1	0		22.50	22.68	22.58		
50	1	132		22.72	22.82	22.75		
50	128	0		25.83	25.81	25.84		
50	1	1	QPSK	26.11	25.99	25.99		
50	1	131		26.30	25.95	25.84		
50	64	32		26.45	26.38	26.19		
50	1	0		22.50	22.71	22.52		
50	1	132		22.67	22.81	22.80		
50	128	0		25.33	25.36	25.35		
50	1	1	16-QAM	25.04	25.26	24.89	24.76	0.2992
50	1	1	64-QAM	23.80	23.91	23.62		
50	1	1	256-QAM	21.05	21.44	21.55		
Limit	EIRP < 1W			Result			Pass	

NR n77 (HPUE) Maximum Average Power [dBm] (GT - LC = -0.5 dB)								
BW [MHz]	RB Size	RB Offset	Mod	Lowest	Middle	Highest	EIRP (dBm)	EIRP(W)
60	1	1	PI/2 BPSK	26.10	26.08	26.15	26.04	0.4018
60	1	160		26.38	25.94	25.82		
60	81	40		26.49	26.38	26.28		
60	1	0		22.56	22.63	22.75		
60	1	161		22.85	22.66	22.76		
60	162	0		26.02	25.81	26.01		
60	1	1	QPSK	26.11	26.01	26.01		
60	1	160		26.46	25.94	25.76		
60	81	40		26.54	26.34	26.21		
60	1	0		22.58	22.59	22.71		
60	1	161		22.92	22.62	22.66		
60	162	0		25.56	25.30	25.48		
60	1	1	16-QAM	25.21	24.87	24.95	24.71	0.2958
60	1	1	64-QAM	23.59	23.45	23.66		
60	1	1	256-QAM	21.60	21.56	21.83		
Limit	EIRP < 1W			Result			Pass	



NR n77 (HPUE) Maximum Average Power [dBm] (GT - LC = -0.5 dB)										
BW [MHz]	RB Size	RB Offset	Mod	Lowest	Middle	Highest	EIRP (dBm)	EIRP(W)		
70	1	1	PI/2 BPSK	25.97	25.74	25.83	26.01	0.3990		
70	1	187		26.20	25.52	25.37				
70	90	45		26.51	25.76	25.85				
70	1	0		22.50	22.47	22.78				
70	1	188		22.92	22.47	22.33				
70	180	0		25.94	25.29	25.44				
70	1	1	QPSK	26.00	25.65	25.74			24.63	0.2904
70	1	187		25.99	25.46	25.25				
70	90	45		26.44	25.72	25.77				
70	1	0		22.50	22.62	22.74				
70	1	188		22.90	22.45	22.32				
70	180	0		25.36	24.83	24.92				
70	1	1	16-QAM	25.13	24.71	25.09	24.63	0.2904		
70	1	1	64-QAM	23.98	23.26	23.30				
70	1	1	256-QAM	21.36	21.64	21.73				
Limit	EIRP < 1W			Result			Pass			

NR n77 (HPUE) Maximum Average Power [dBm] (GT - LC = -0.5 dB)										
BW [MHz]	RB Size	RB Offset	Mod	Lowest	Middle	Highest	EIRP (dBm)	EIRP(W)		
80	1	1	PI/2 BPSK	26.05	25.67	25.68	25.98	0.3963		
80	1	215		26.05	25.46	25.37				
80	108	54		26.48	25.80	25.70				
80	1	0		22.56	22.62	22.68				
80	1	216		22.80	22.42	22.39				
80	216	0		25.90	25.36	25.38				
80	1	1	QPSK	26.06	25.67	25.66			24.41	0.2761
80	1	215		25.86	25.43	25.47				
80	108	54		26.42	25.71	25.72				
80	1	0		22.57	22.59	22.71				
80	1	216		22.76	22.42	22.42				
80	216	0		25.37	24.85	24.87				
80	1	1	16-QAM	24.91	24.70	24.84	24.41	0.2761		
80	1	1	64-QAM	23.58	23.00	23.18				
80	1	1	256-QAM	21.56	21.54	21.70				
Limit	EIRP < 1W			Result			Pass			



NR n77 (HPUE) Maximum Average Power [dBm] (GT - LC = -0.5 dB)								
BW [MHz]	RB Size	RB Offset	Mod	Lowest	Middle	Highest	EIRP (dBm)	EIRP(W)
90	1	1	PI/2 BPSK	26.15	25.68	25.73	25.86	0.3855
90	1	243		25.97	25.52	25.27		
90	120	60		26.33	25.87	25.81		
90	1	0		22.61	22.47	22.73		
90	1	244		22.89	22.36	22.31		
90	243	0		25.80	25.29	25.37		
90	1	1	QPSK	23.79	25.61	25.64		
90	1	243		24.14	25.43	25.27		
90	120	60		26.36	25.80	25.77		
90	1	0		22.64	22.51	22.68		
90	1	244		22.87	22.33	22.28		
90	243	0		25.29	24.77	24.96		
90	1	1	16-QAM	25.03	24.67	25.04	24.54	0.2844
90	1	1	64-QAM	23.74	23.09	23.40		
90	1	1	256-QAM	21.52	21.59	21.72		
Limit	EIRP < 1W			Result			Pass	

NR n77 (HPUE) Maximum Average Power [dBm] (GT - LC = -0.5 dB)								
BW [MHz]	RB Size	RB Offset	Mod	Lowest	Middle	Highest	EIRP (dBm)	EIRP(W)
100	1	1	PI/2 BPSK	-	25.73	-	25.32	0.3404
100	1	271		-	25.40	-		
100	135	67		-	25.82	-		
100	1	0		-	22.46	-		
100	1	272		-	22.30	-		
100	270	0		-	25.33	-		
100	1	1	QPSK	-	25.69	-		
100	1	271		-	25.38	-		
100	135	67		-	25.79	-		
100	1	0		-	22.56	-		
100	1	272		-	22.23	-		
100	270	0		-	24.77	-		
100	1	1	16-QAM	-	24.70	-	24.2	0.2630
100	1	1	64-QAM	-	23.06	-		
100	1	1	256-QAM	-	21.87	-		
Limit	EIRP < 1W			Result			Pass	



FR1 n77_HPUE

Peak-to-Average Ratio

Mode	FR1 n77 / 20MHz / DFT-S OFDM				
Mod.	PI/2 BPSK	QPSK	16QAM	64QAM	Limit: 13dB
RB Size	Full RB	Full RB	Full RB	Full RB	Result
Middle CH	4.34	5.56	6.34	6.62	PASS
Mode	FR1 n77 / 20MHz / DFT-S OFDM				
Mod.	256QAM				Limit: 13dB
RB Size	Full RB				Result
Middle CH	6.52				PASS



FR1 n77 / 20MHz / DFT-S OFDM / Middle Channel / Full RB

PI/2 BPSK

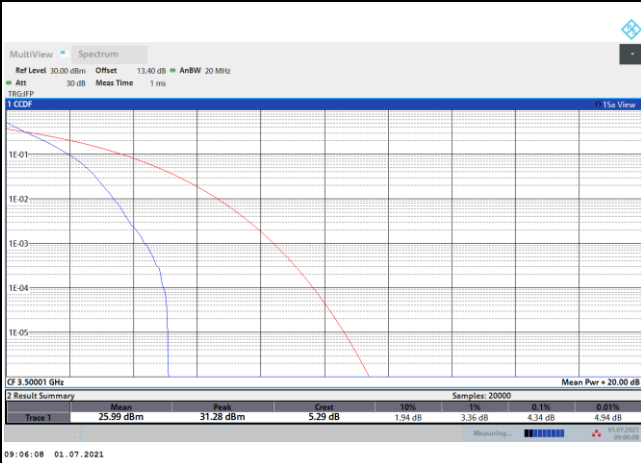

QPSK

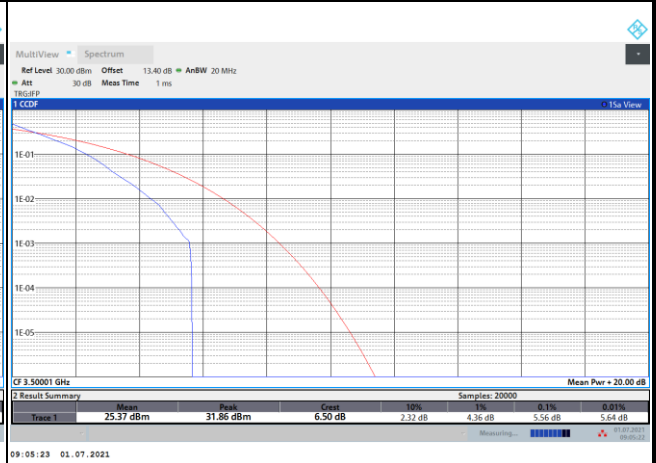

16QAM

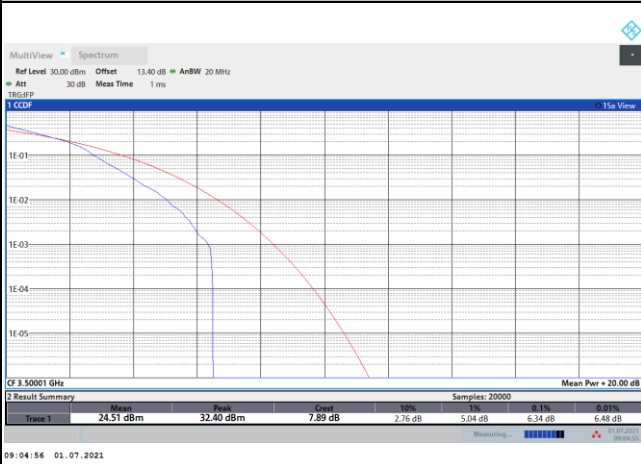

64QAM

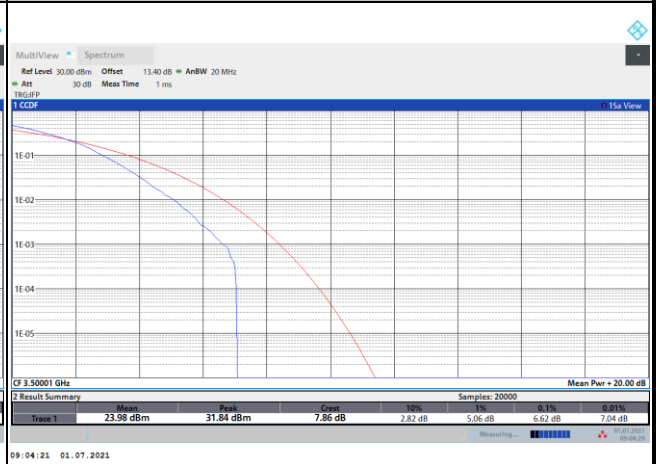

256QAM

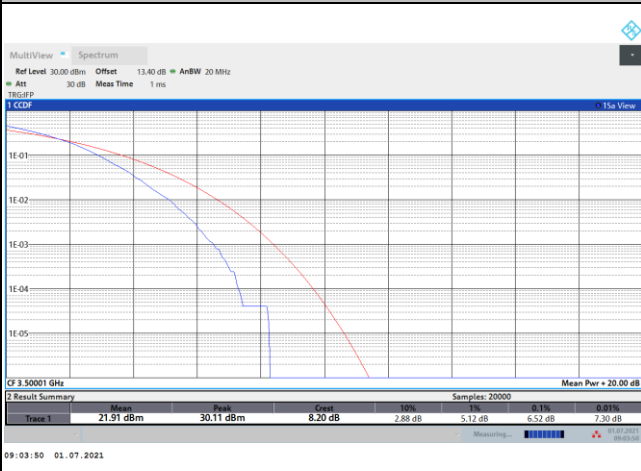



26dB Bandwidth

Mode	FR1 n77 : 26dB BW(MHz) / DFT-S OFDM							
BW	10MHz	15MHz	20MHz	25MHz	30MHz	40MHz	50MHz	60MHz
Mod.	PI/2 BPSK	PI/2 BPSK	PI/2 BPSK	PI/2 BPSK	PI/2 BPSK	PI/2 BPSK	PI/2 BPSK	PI/2 BPSK
Middle CH	9.45	14.03	18.78	-	27.75	37.16	48.25	60.66
BW	70MHz	80MHz	90MHz	100MHz				
Mod.	PI/2 BPSK	PI/2 BPSK	PI/2 BPSK	PI/2 BPSK				
Middle CH	67.13	80.08	90.63	100.10				

Mode	FR1 n77 : 26dB BW(MHz) / CP OFDM							
BW	10MHz		15MHz		20MHz		25MHz	
Mod.	QPSK	16QAM	QPSK	16QAM	QPSK	16QAM	QPSK	16QAM
Middle CH	9.19	9.41	14.33	14.66	19.14	19.22	-	-
Mod.	64QAM	256QAM	64QAM	256QAM	64QAM	256QAM	64QAM	256QAM
Middle CH	9.49	9.17	14.42	14.39	19.06	19.42	-	-
BW	30MHz		40MHz		50MHz		60MHz	
Mod.	QPSK	16QAM	QPSK	16QAM	QPSK	16QAM	QPSK	16QAM
Middle CH	29.31	29.13	39.64	39.00	50.05	50.05	60.54	60.78
Mod.	64QAM	256QAM	64QAM	256QAM	64QAM	256QAM	64QAM	256QAM
Middle CH	28.83	29.19	39.88	38.92	50.05	50.15	61.02	60.78
BW	70MHz		80MHz		90MHz		100MHz	
Mod.	QPSK	16QAM	QPSK	16QAM	QPSK	16QAM	QPSK	16QAM
Middle CH	70.35	70.63	80.24	80.40	91.17	90.99	100.30	100.50
Mod.	64QAM	256QAM	64QAM	256QAM	64QAM	256QAM	64QAM	256QAM
Middle CH	70.49	70.35	80.72	81.04	90.63	92.07	101.10	100.90



FR1 n77 / 10MHz / DFT-S OFDM / Middle Channel / Full RB

PI/2 BPSK

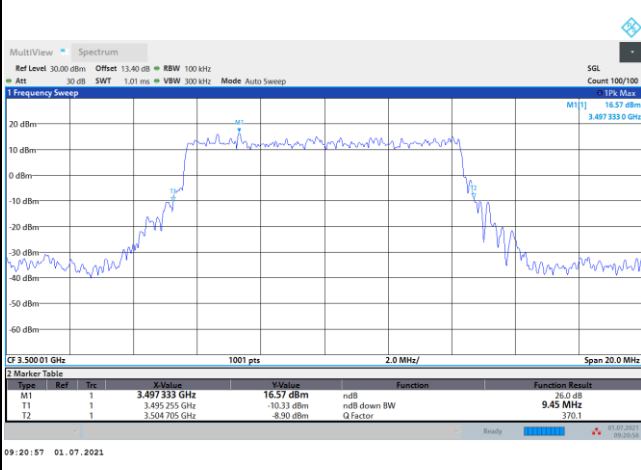

FR1 n77 / 10MHz / CP OFDM / Middle Channel / Full RB

QPSK

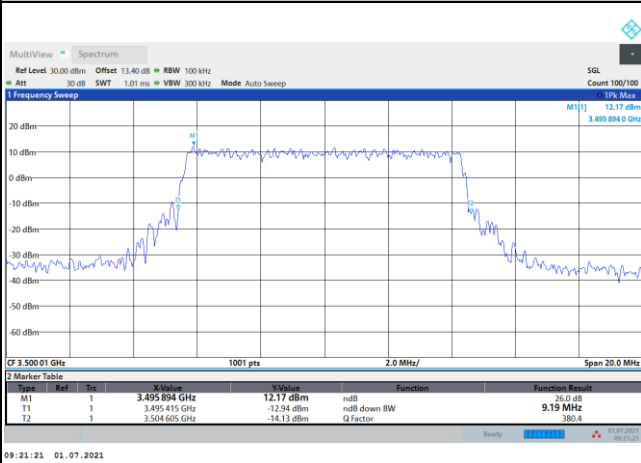

16QAM

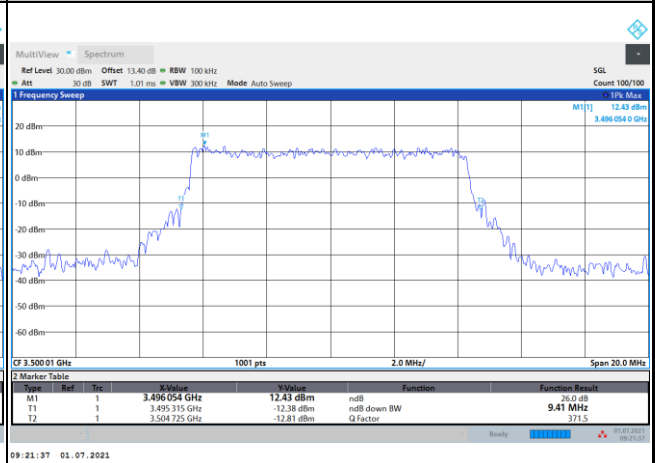

64QAM

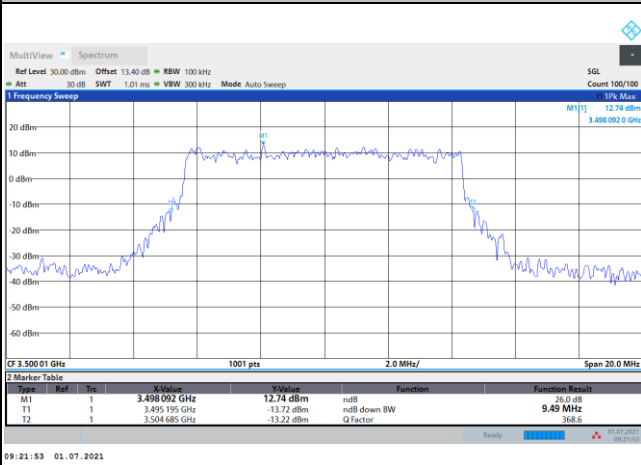

256QAM

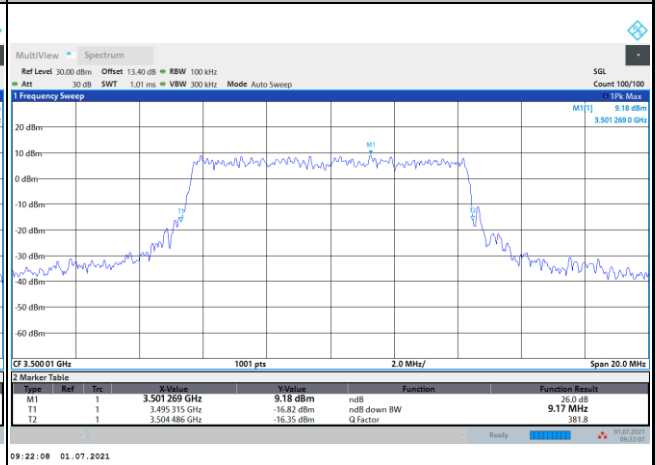



FR1 n77 / 15MHz / DFT-S OFDM / Middle Channel / Full RB

PI/2 BPSK



FR1 n77 / 15MHz / CP OFDM / Middle Channel / Full RB

QPSK

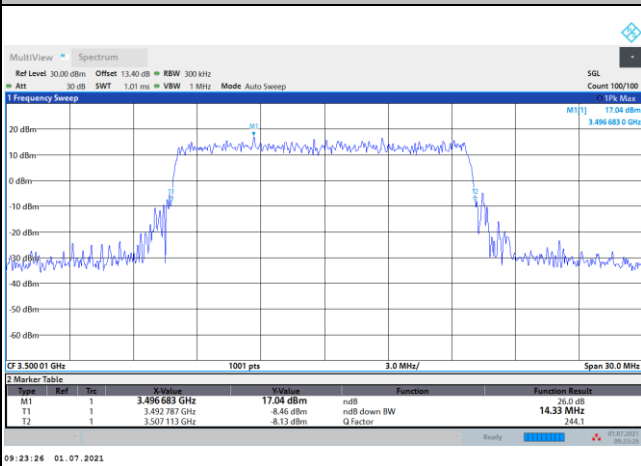

16QAM

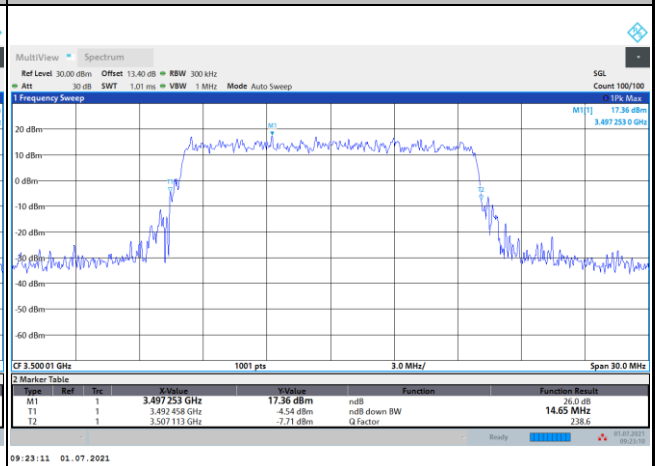

64QAM

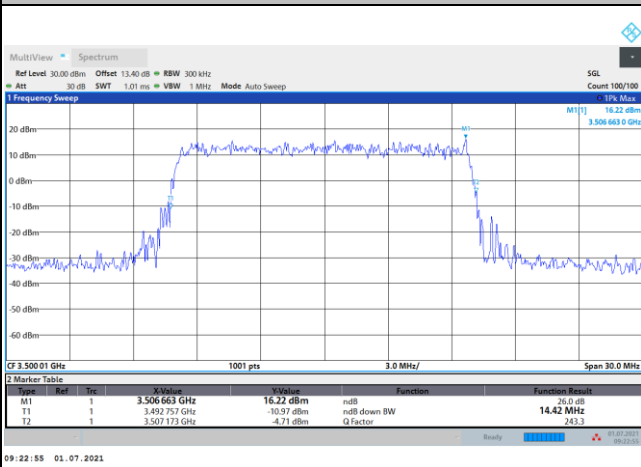

256QAM

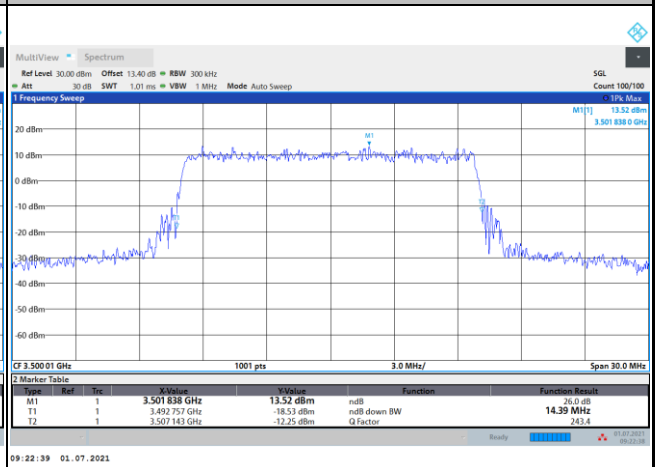



FR1 n77 / 20MHz / DFT-S OFDM / Middle Channel / Full RB

PI/2 BPSK

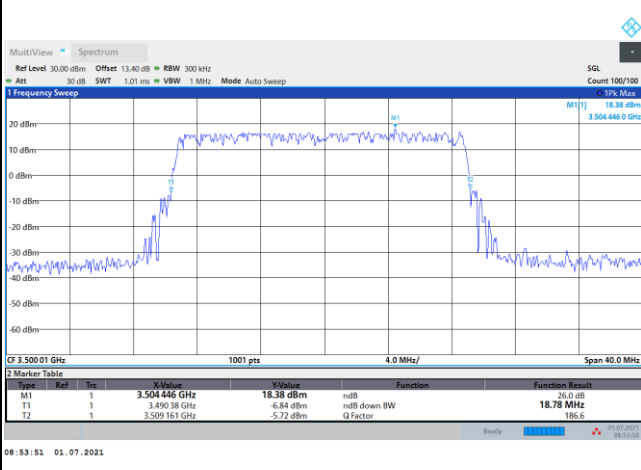

FR1 n77 / 20MHz / CP OFDM / Middle Channel / Full RB

QPSK

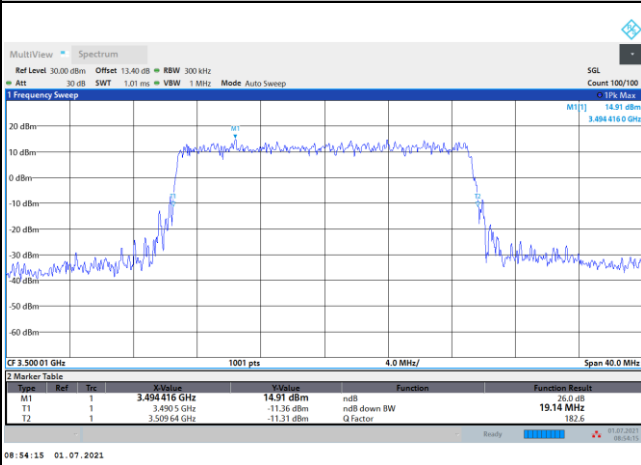

16QAM

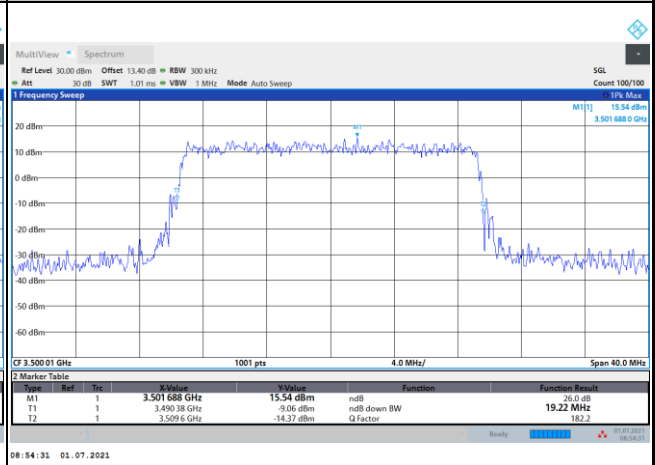

64QAM

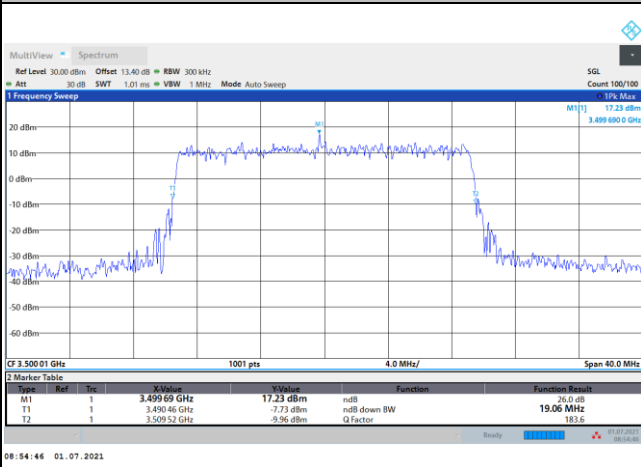

256QAM

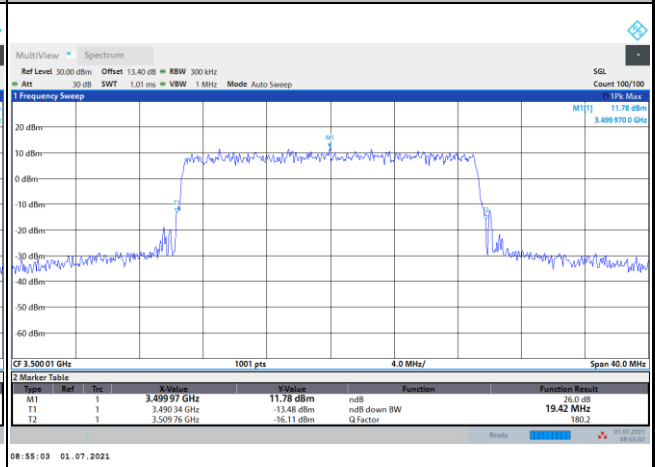



FR1 n77 / 30MHz / DFT-S OFDM / Middle Channel / Full RB

PI/2 BPSK

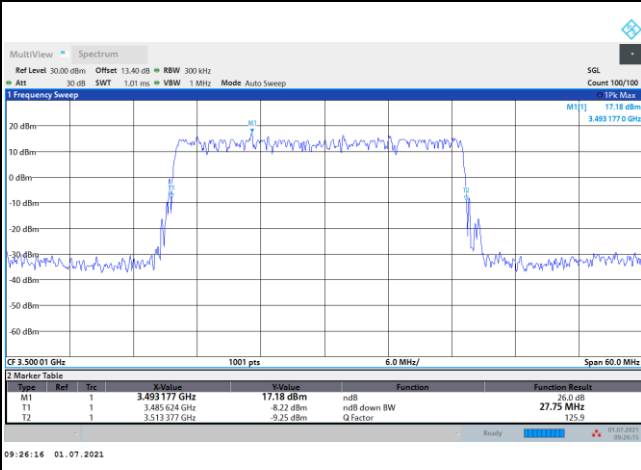

FR1 n77 / 30MHz / CP OFDM / Middle Channel / Full RB

QPSK

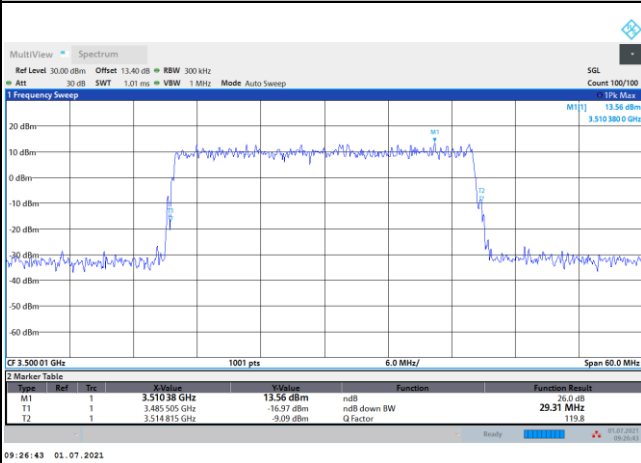

16QAM

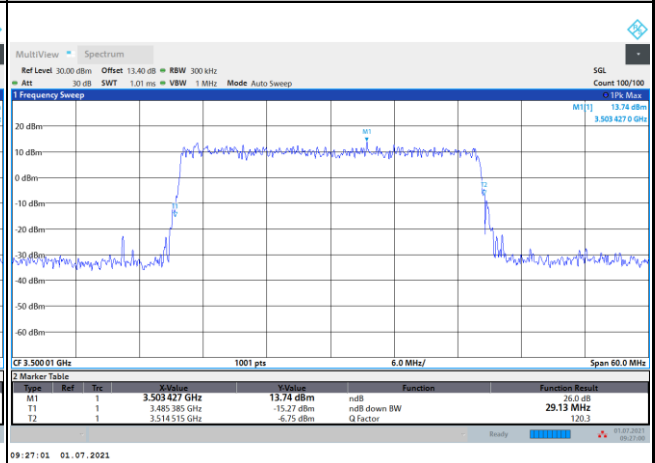

64QAM

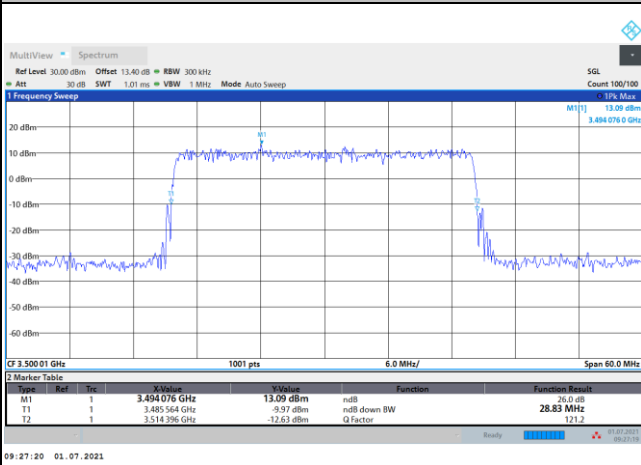

256QAM

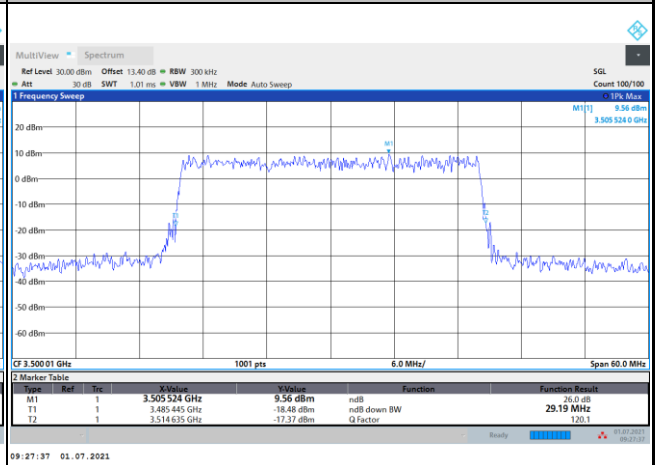



FR1 n77 / 40MHz / DFT-S OFDM / Middle Channel / Full RB

PI/2 BPSK



FR1 n77 / 40MHz / CP OFDM / Middle Channel / Full RB

QPSK

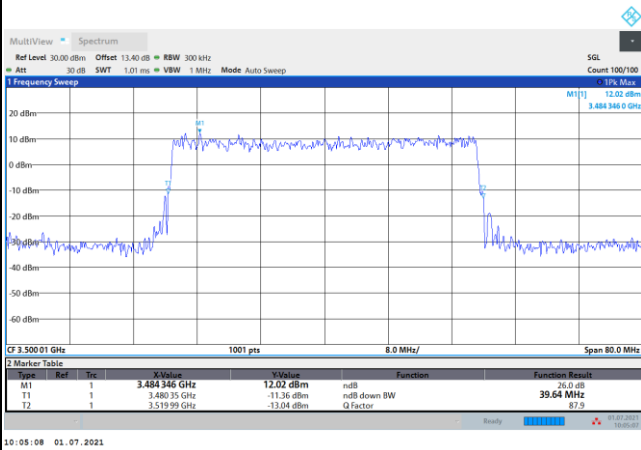

16QAM

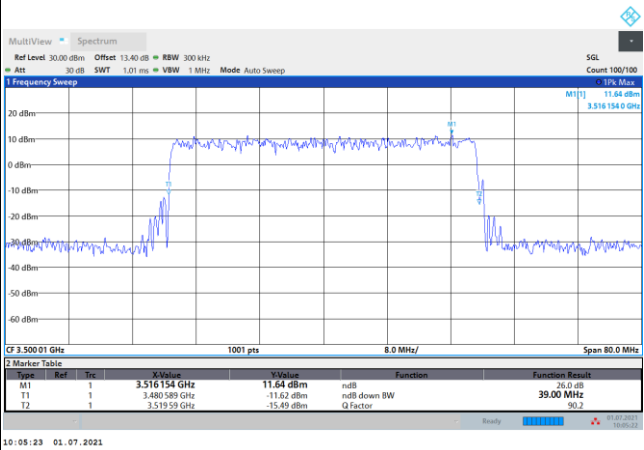

64QAM

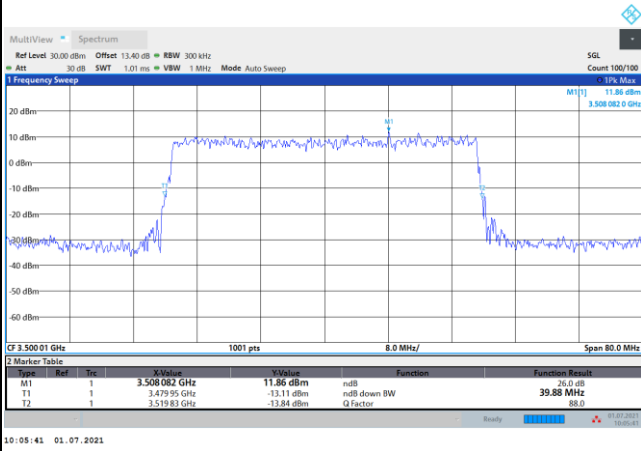

256QAM

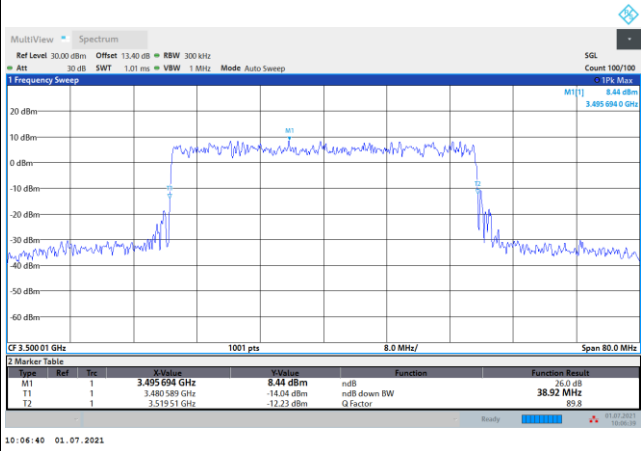



FR1 n77 / 50MHz / DFT-S OFDM / Middle Channel / Full RB

PI/2 BPSK

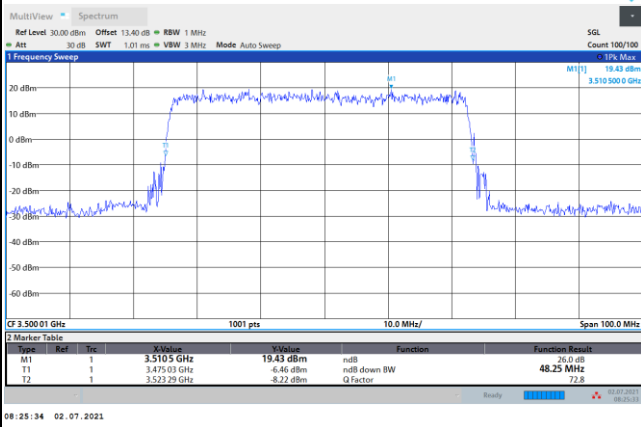

FR1 n77 / 50MHz / CP OFDM / Middle Channel / Full RB

QPSK

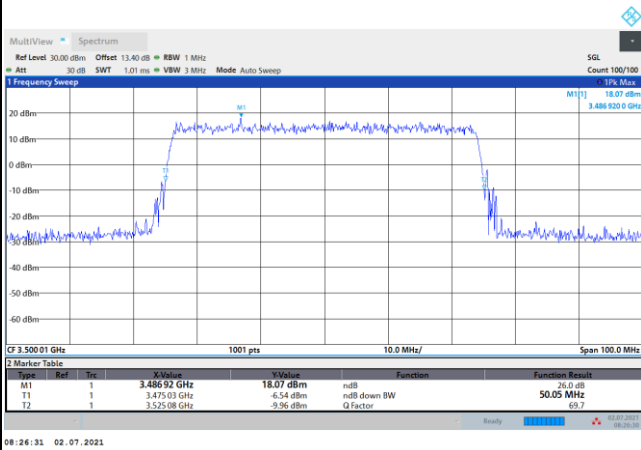

16QAM

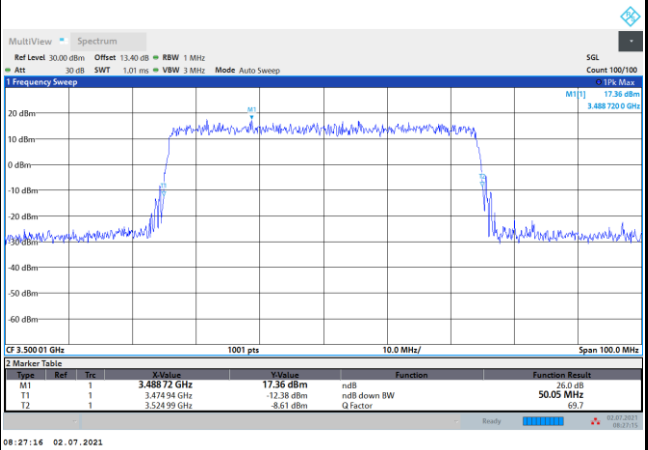

64QAM

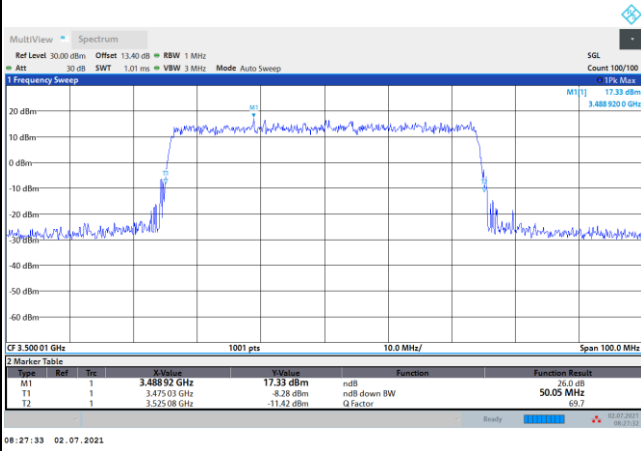

256QAM

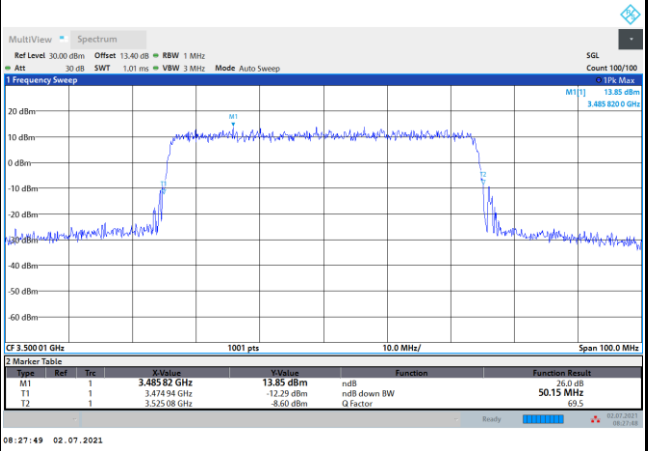



FR1 n77 / 60MHz / DFT-S OFDM / Middle Channel / Full RB

PI/2 BPSK

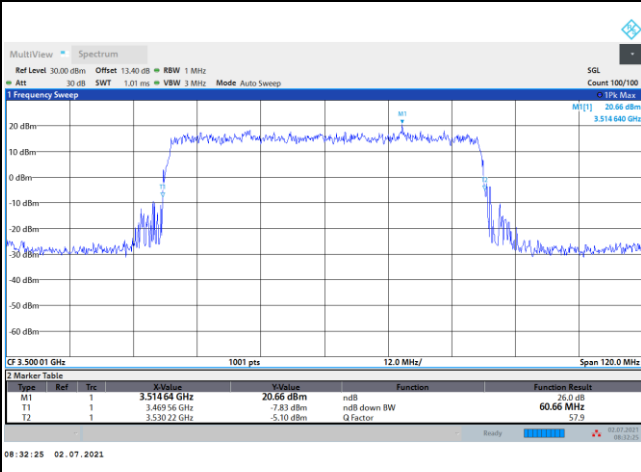

FR1 n77 / 60MHz / CP OFDM / Middle Channel / Full RB

QPSK

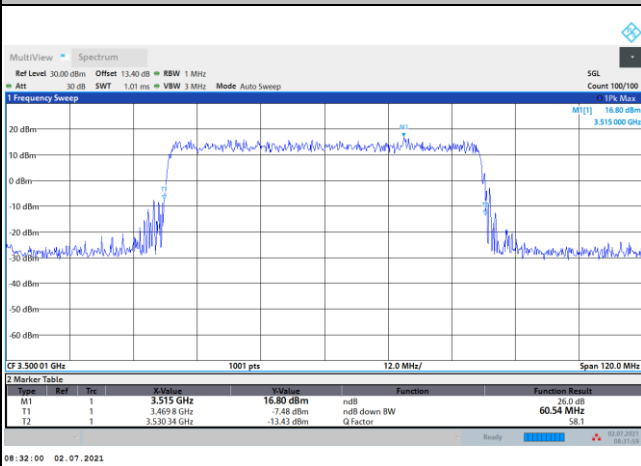

16QAM

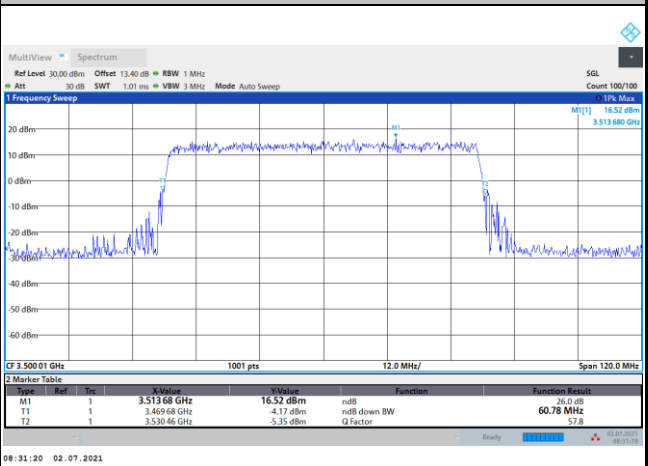

64QAM

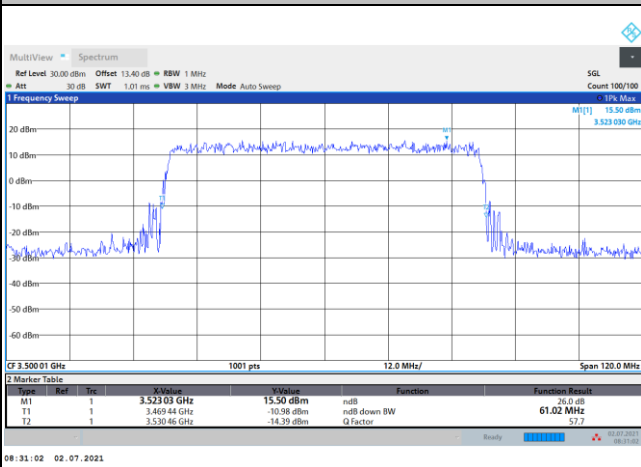

256QAM

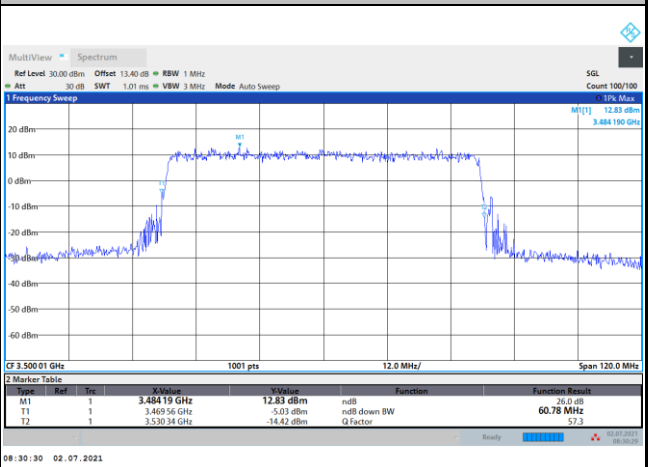



FR1 n77 / 70MHz / DFT-S OFDM / Middle Channel / Full RB

PI/2 BPSK

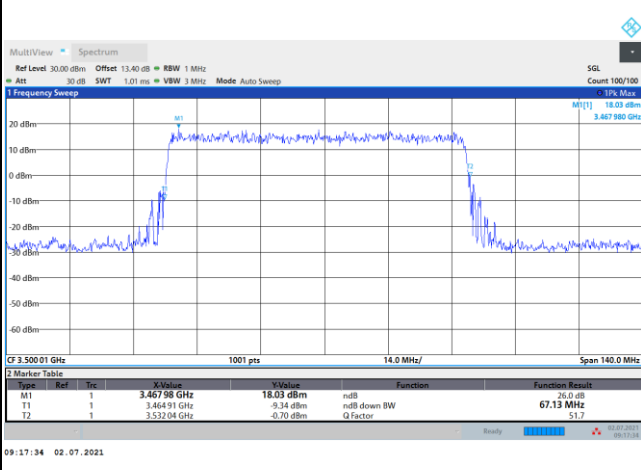

FR1 n77 / 70MHz / CP OFDM / Middle Channel / Full RB

QPSK

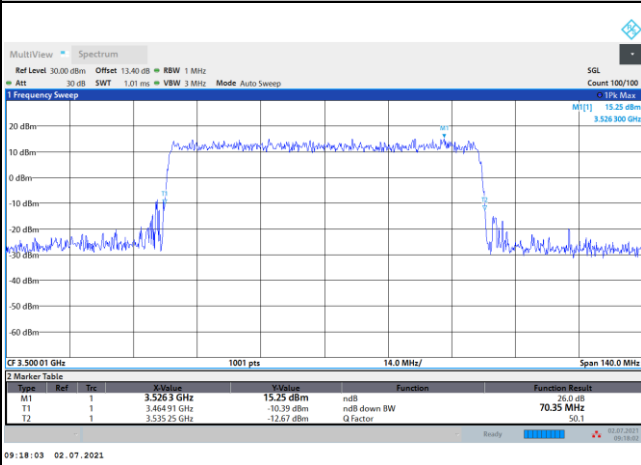

16QAM

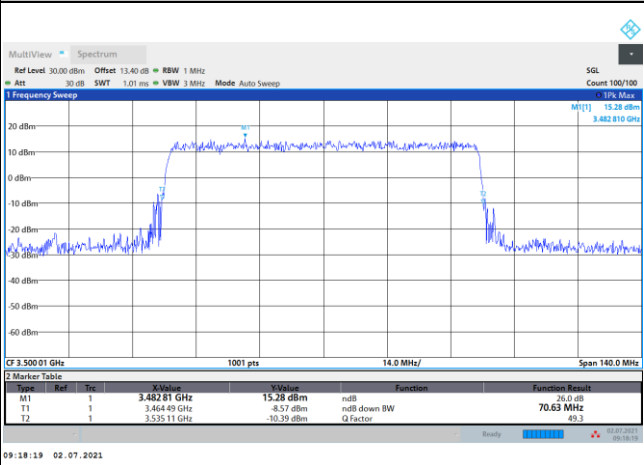

64QAM

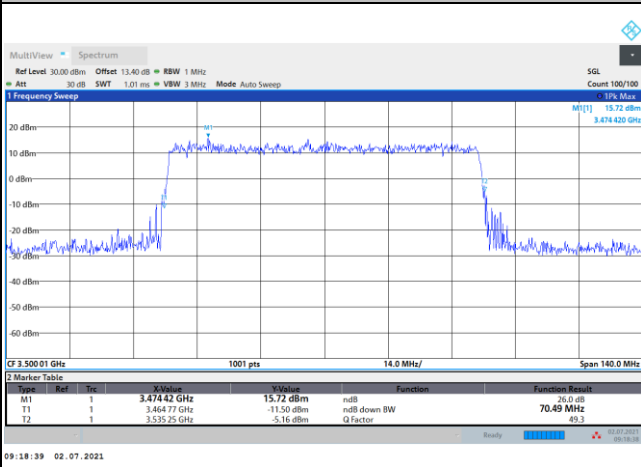

256QAM

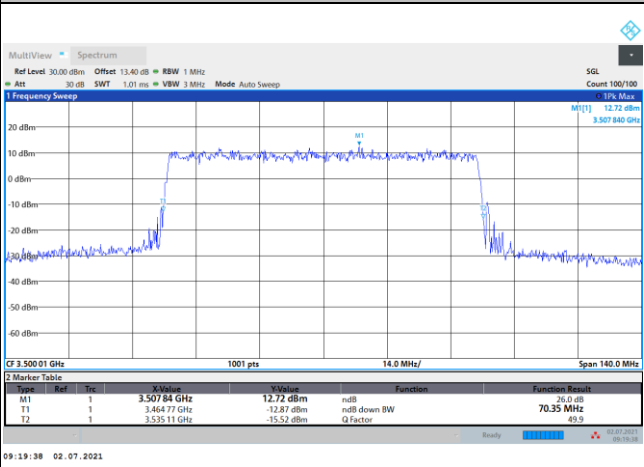



FR1 n77 / 80MHz / DFT-S OFDM / Middle Channel / Full RB

PI/2 BPSK

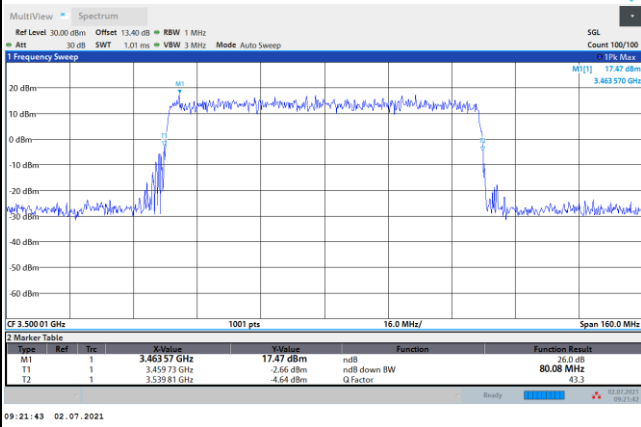

FR1 n77 / 80MHz / CP OFDM / Middle Channel / Full RB

QPSK

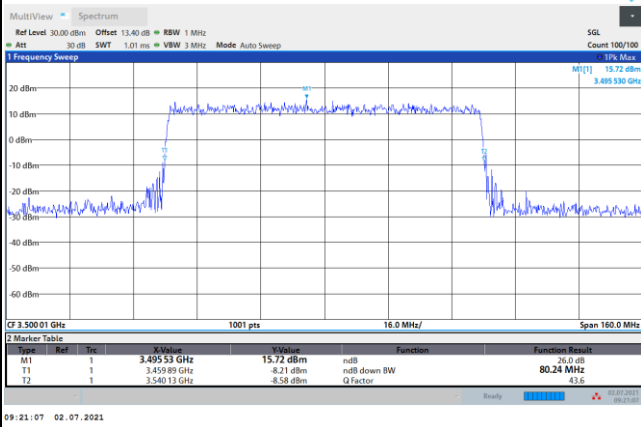

16QAM

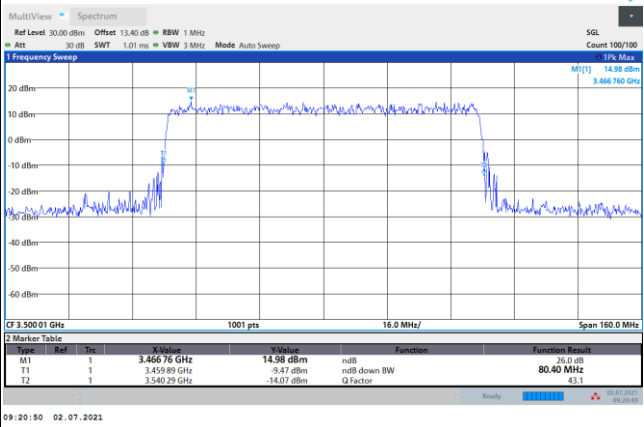

64QAM

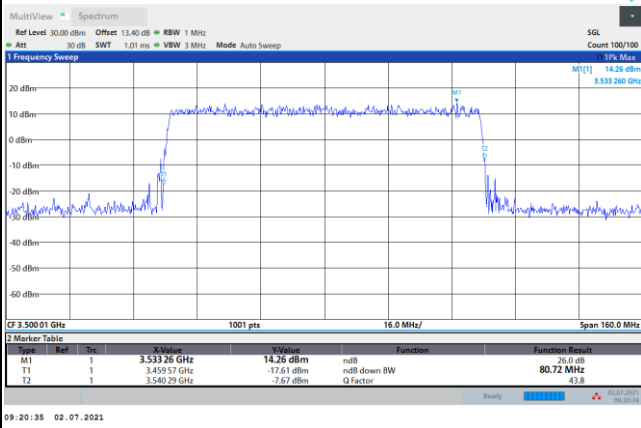

256QAM

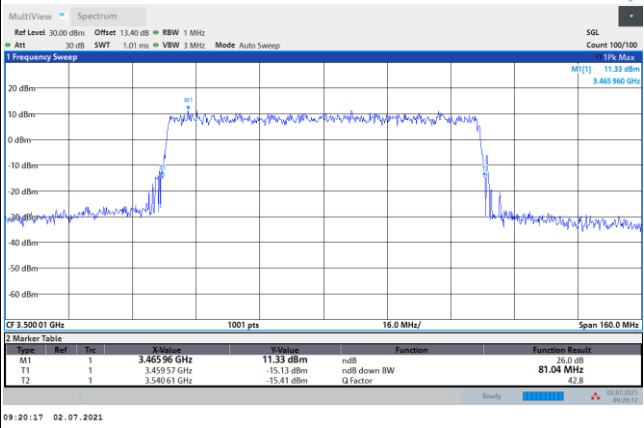



FR1 n77 / 90MHz / DFT-S OFDM / Middle Channel / Full RB

PI/2 BPSK

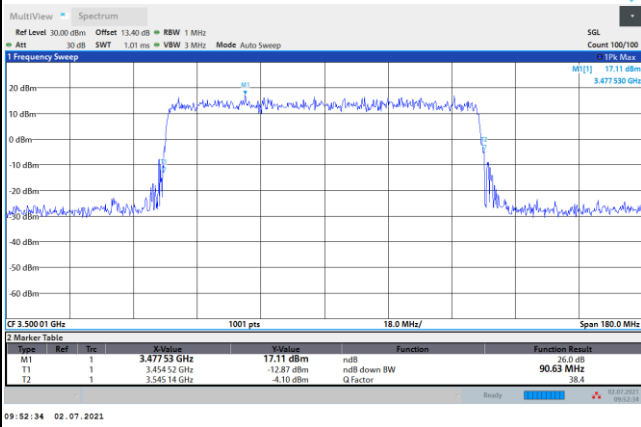

FR1 n77 / 90MHz / CP OFDM / Middle Channel / Full RB

QPSK

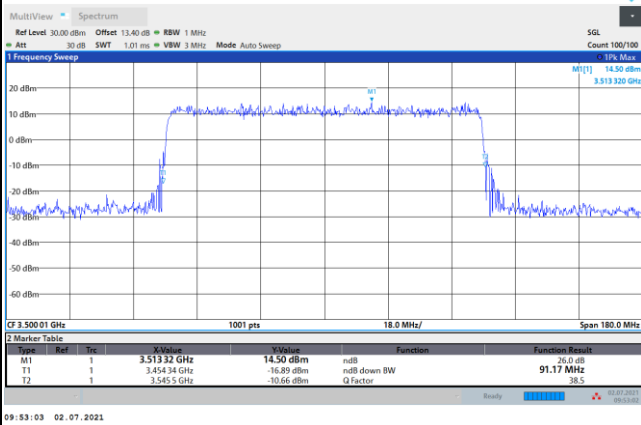

16QAM

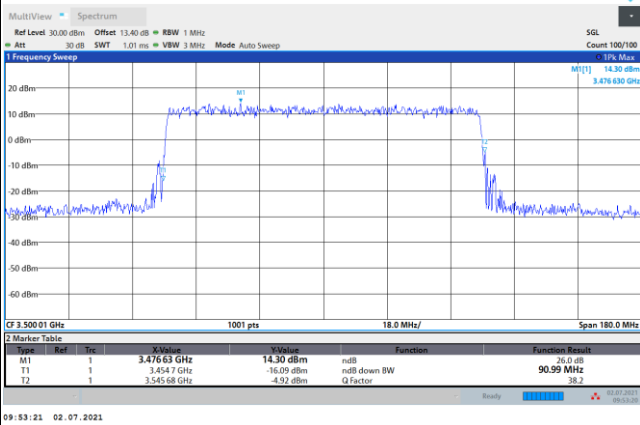

64QAM

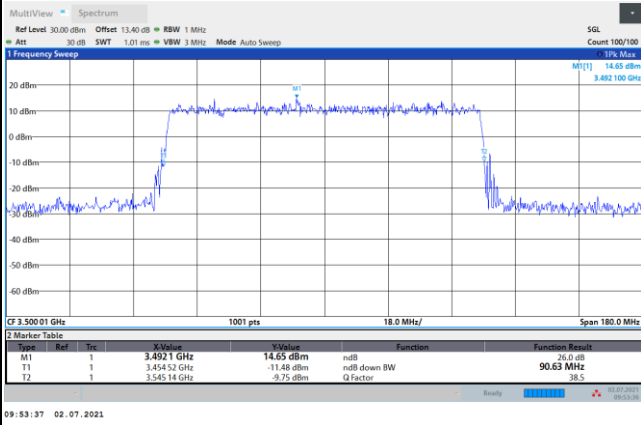

256QAM

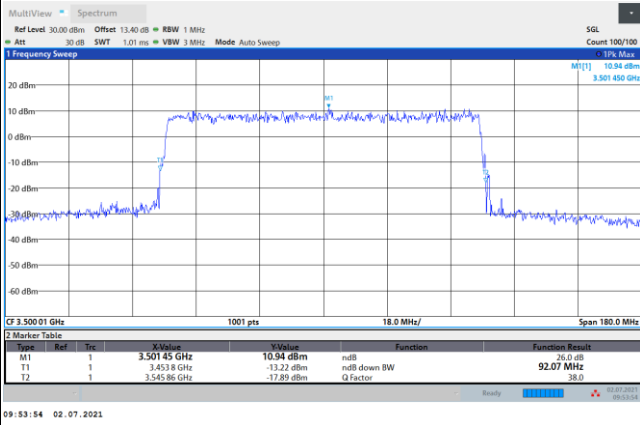



FR1 n77 / 100MHz / DFT-S OFDM / Middle Channel / Full RB

PI/2 BPSK

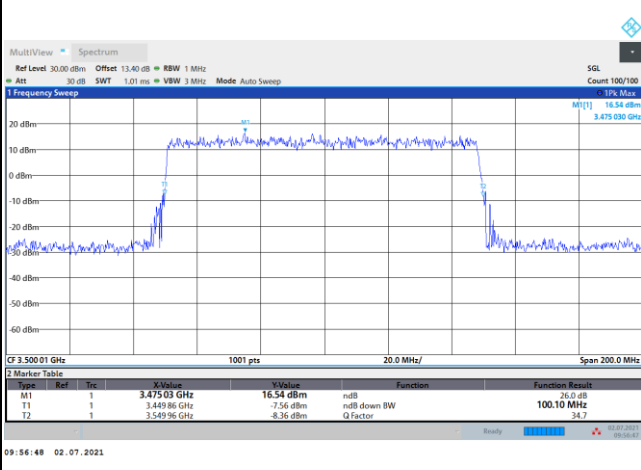

FR1 n77 / 100MHz / CP OFDM / Middle Channel / Full RB

QPSK

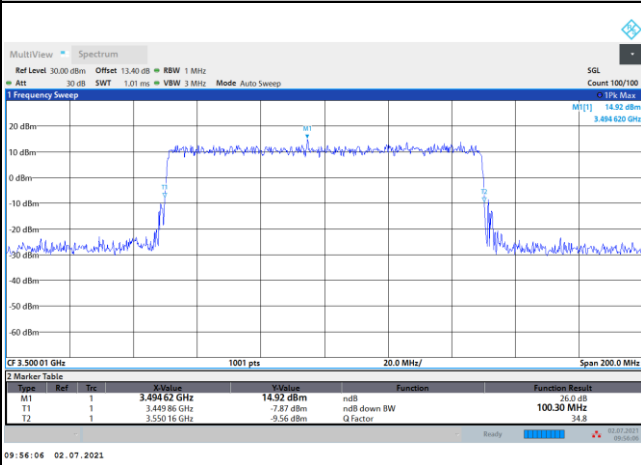

16QAM

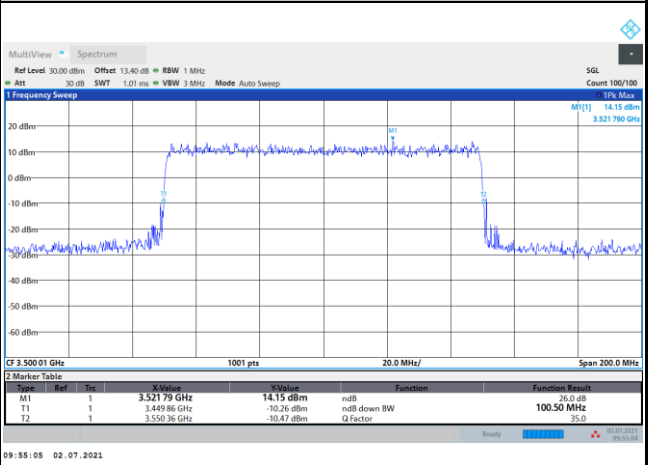

64QAM

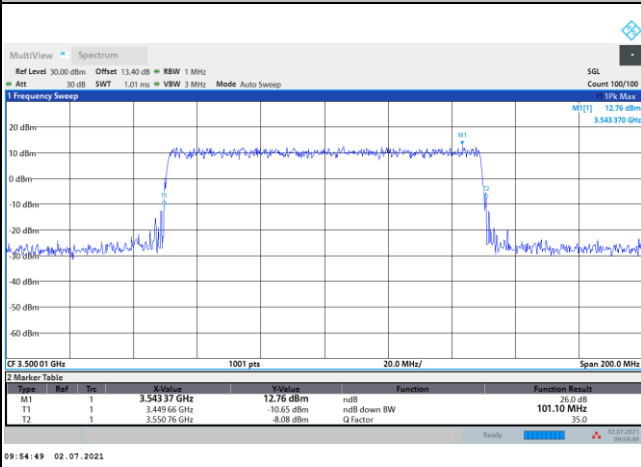

256QAM

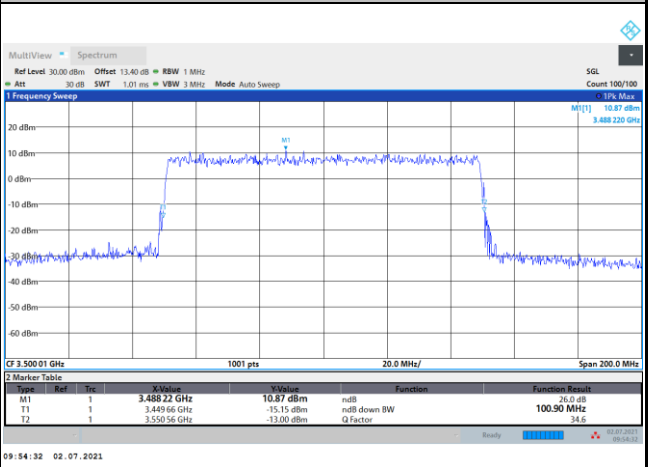



Occupied Bandwidth

Mode	FR1 n77 : OB BW(MHz) / DFT-S OFDM							
BW	10MHz	15MHz	20MHz	25MHz	30MHz	40MHz	50MHz	60MHz
Mod.	PI/2 BPSK	PI/2 BPSK	PI/2 BPSK	PI/2 BPSK	PI/2 BPSK	PI/2 BPSK	PI/2 BPSK	PI/2 BPSK
Middle CH	8.61	12.95	17.86	-	26.90	35.65	45.92	57.74
BW	70MHz	80MHz	90MHz	100MHz				
Mod.	PI/2 BPSK	PI/2 BPSK	PI/2 BPSK	PI/2 BPSK				
Middle CH	64.32	77.04	86.66	96.17				

Mode	FR1 n77 : OB BW(MHz) / CP OFDM							
BW	10MHz		15MHz		20MHz		25MHz	
Mod.	QPSK	16QAM	QPSK	16QAM	QPSK	16QAM	QPSK	16QAM
Middle CH	8.61	8.58	13.60	13.59	18.24	18.19	-	-
Mod.	64QAM	256QAM	64QAM	256QAM	64QAM	256QAM	64QAM	256QAM
Middle CH	8.58	8.59	13.63	13.58	18.24	18.23	-	-
BW	30MHz		40MHz		50MHz		60MHz	
Mod.	QPSK	16QAM	QPSK	16QAM	QPSK	16QAM	QPSK	16QAM
Middle CH	27.87	27.89	37.97	37.90	47.51	47.61	58.06	57.88
Mod.	64QAM	256QAM	64QAM	256QAM	64QAM	256QAM	64QAM	256QAM
Middle CH	27.84	27.92	37.86	37.64	47.51	47.43	57.82	57.93
BW	70MHz		80MHz		90MHz		100MHz	
Mod.	QPSK	16QAM	QPSK	16QAM	QPSK	16QAM	QPSK	16QAM
Middle CH	67.42	67.65	77.47	77.56	87.40	87.34	97.29	97.26
Mod.	64QAM	256QAM	64QAM	256QAM	64QAM	256QAM	64QAM	256QAM
Middle CH	67.72	67.54	77.19	77.31	87.41	87.45	97.19	97.36



FR1 n77 / 10MHz / DFT-S OFDM / Middle Channel / Full RB

PI/2 BPSK

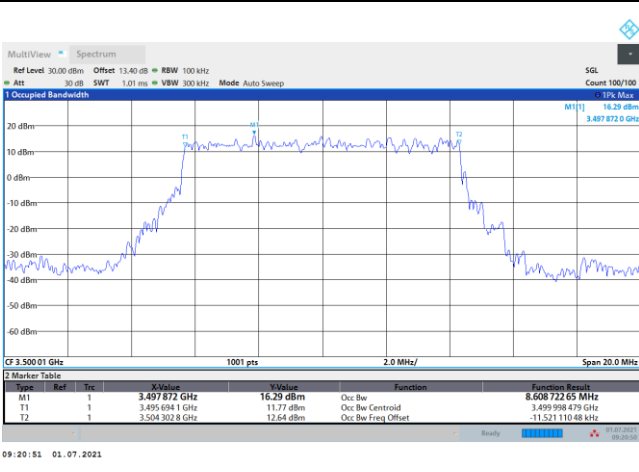

FR1 n77 / 10MHz / CP OFDM / Middle Channel / Full RB

QPSK

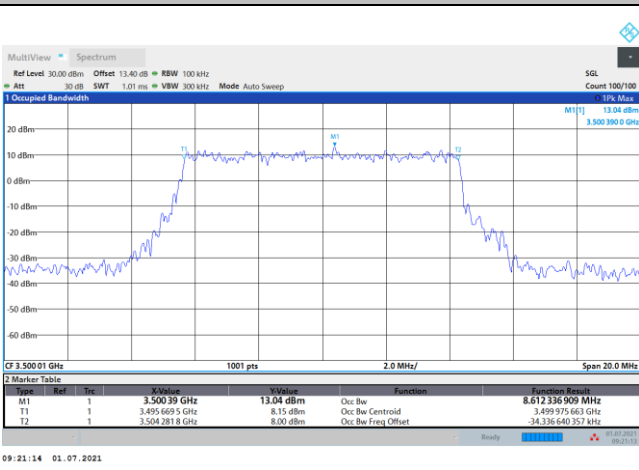

16QAM

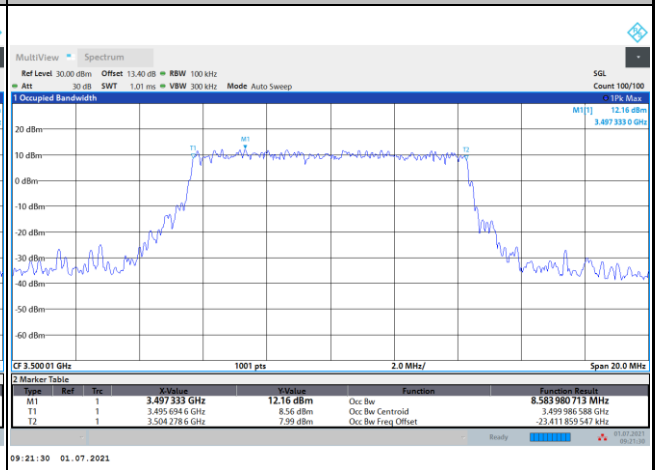

64QAM

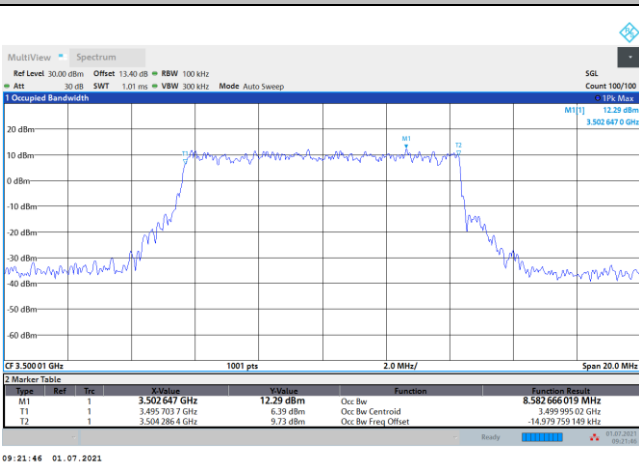

256QAM

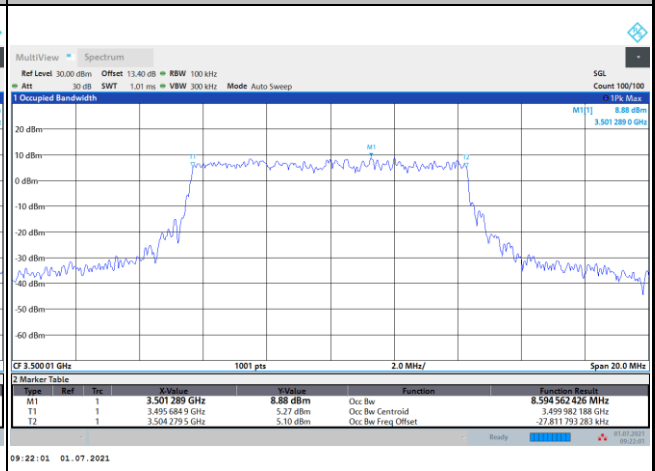



FR1 n77 / 15MHz / DFT-S OFDM / Middle Channel / Full RB

PI/2 BPSK

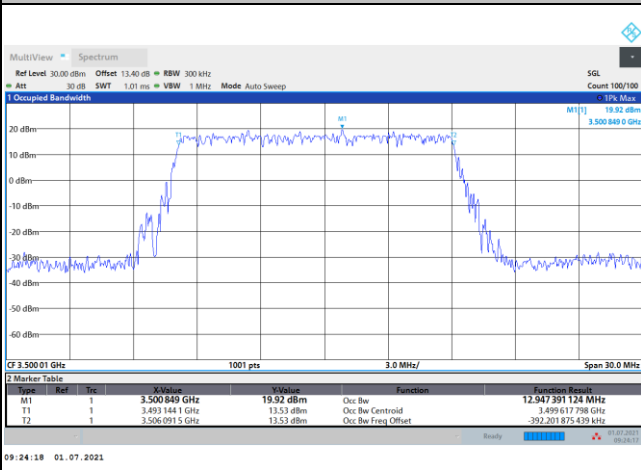

FR1 n77 / 15MHz / CP OFDM / Middle Channel / Full RB

QPSK

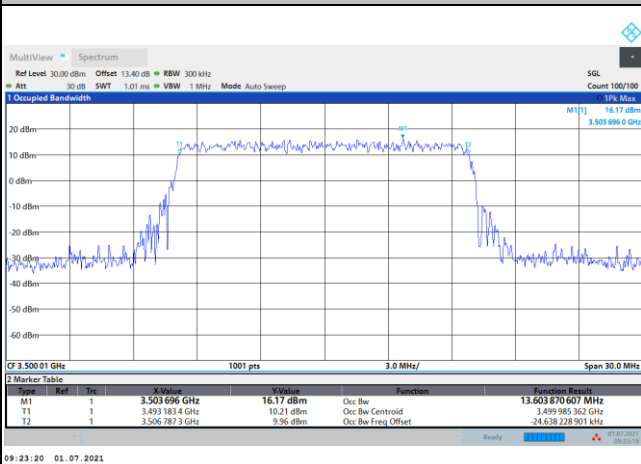

16QAM

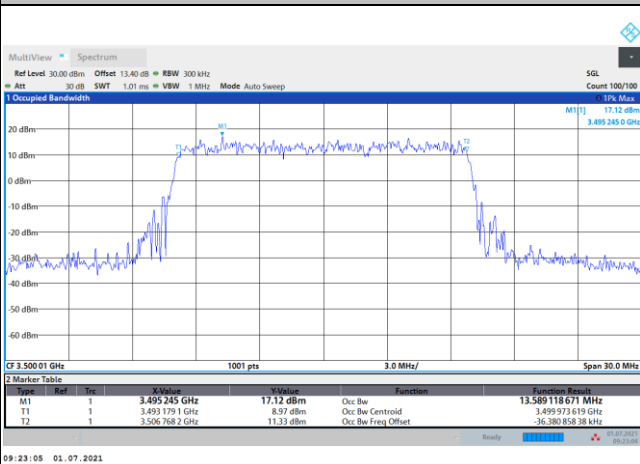

64QAM

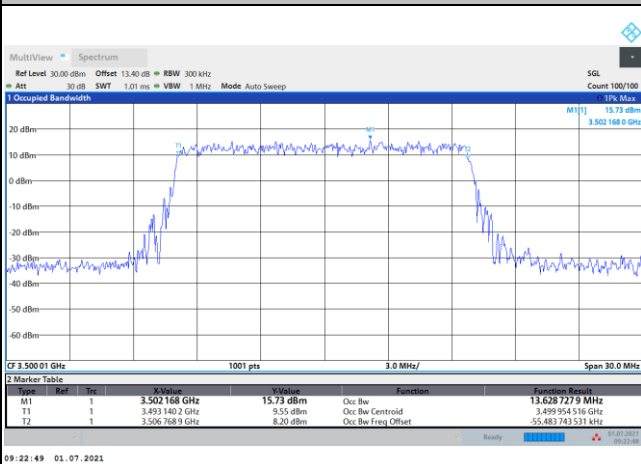

256QAM

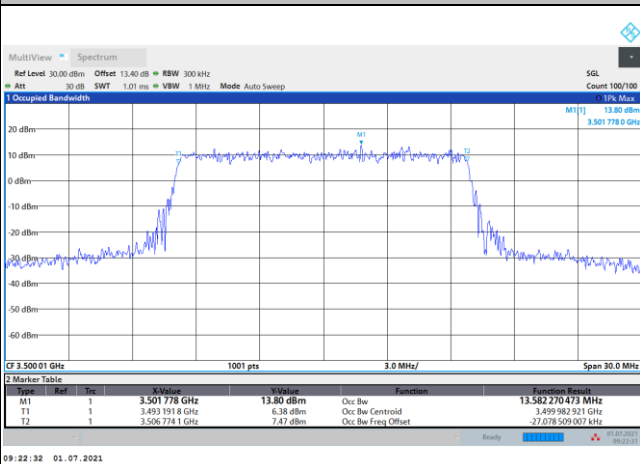



FR1 n77 / 20MHz / DFT-S OFDM / Middle Channel / Full RB

PI/2 BPSK

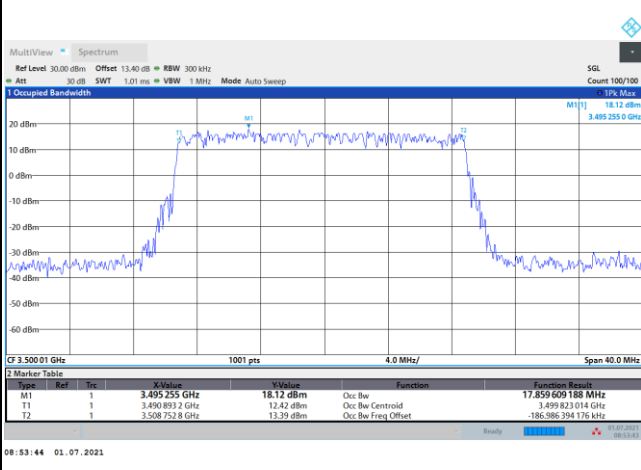

FR1 n77 / 20MHz / CP OFDM / Middle Channel / Full RB

QPSK

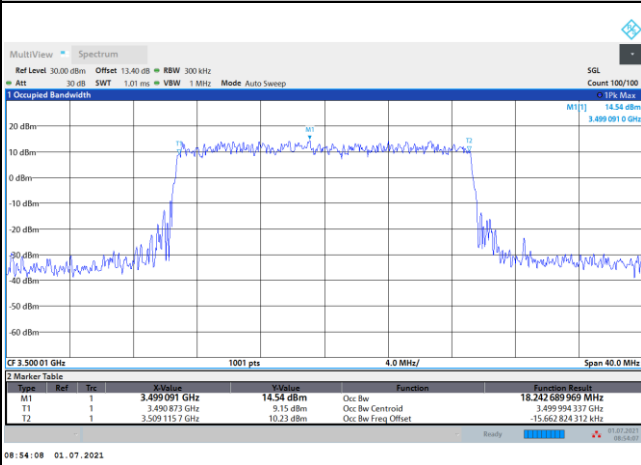

16QAM

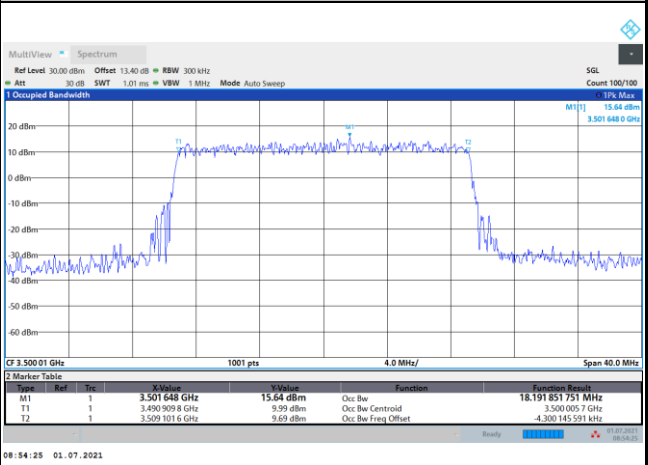

64QAM

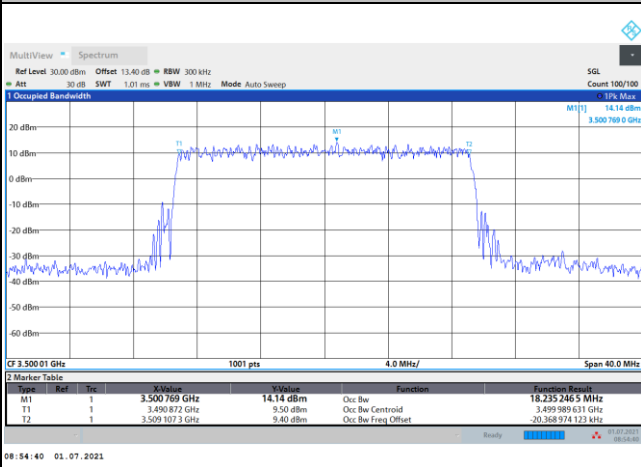

256QAM

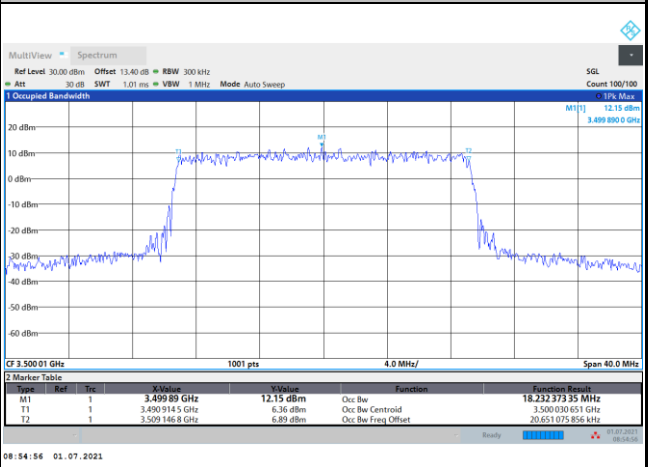



FR1 n77 / 30MHz / DFT-S OFDM / Middle Channel / Full RB

PI/2 BPSK

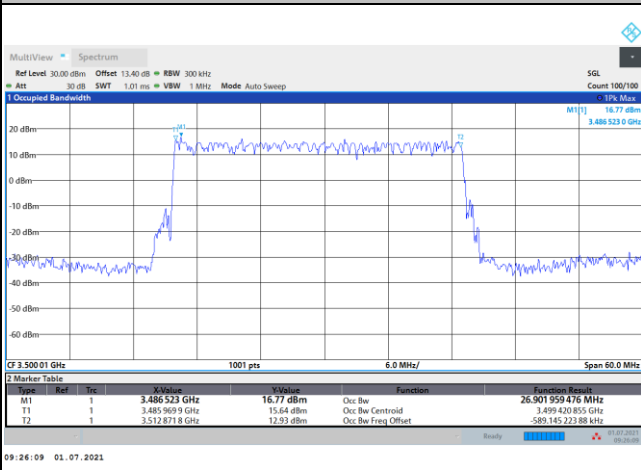

FR1 n77 / 30MHz / CP OFDM / Middle Channel / Full RB

QPSK

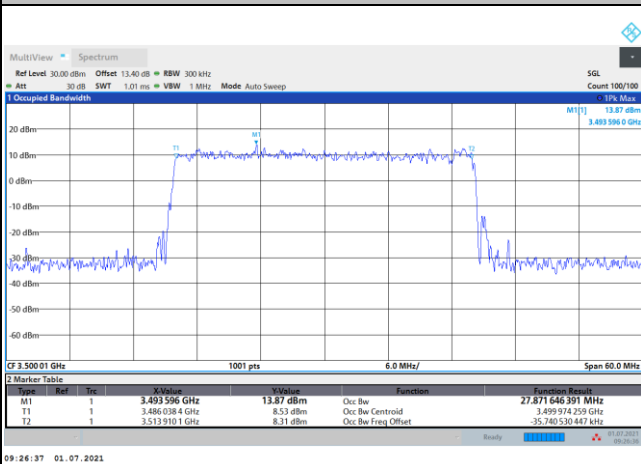

16QAM

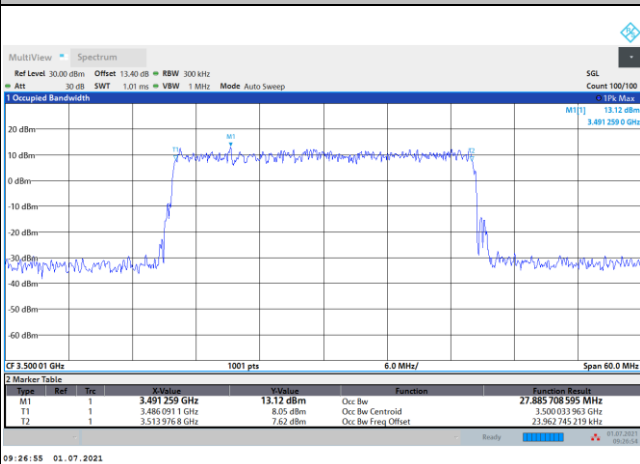

64QAM

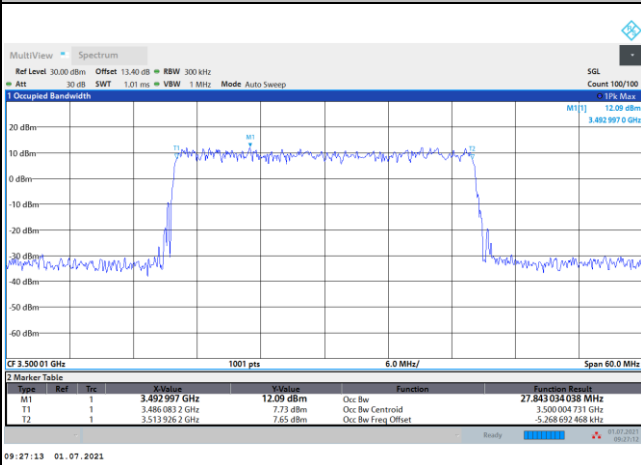

256QAM

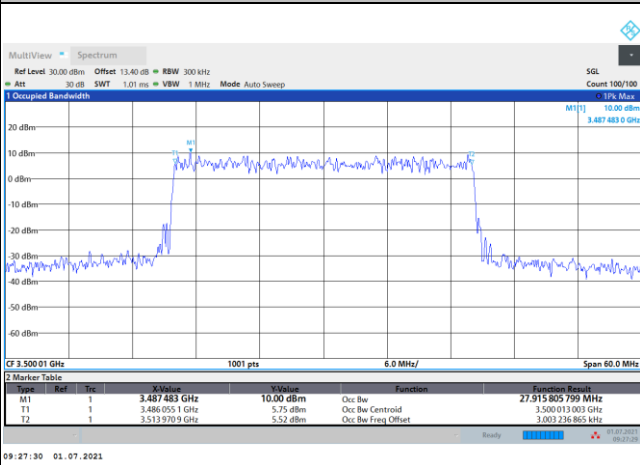



FR1 n77 / 40MHz / DFT-S OFDM / Middle Channel / Full RB

PI/2 BPSK

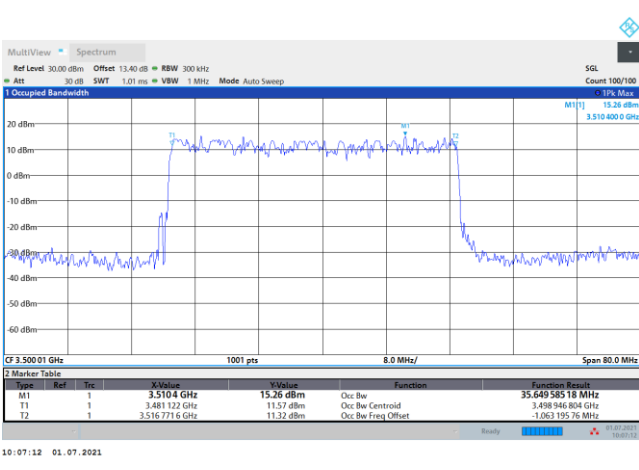

FR1 n77 / 40MHz / CP OFDM / Middle Channel / Full RB

QPSK

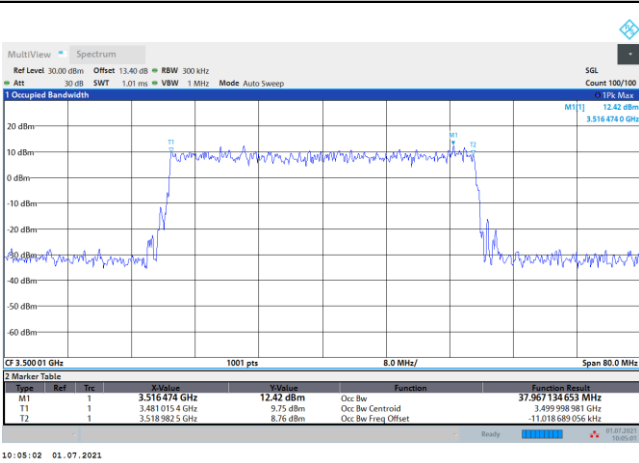

16QAM

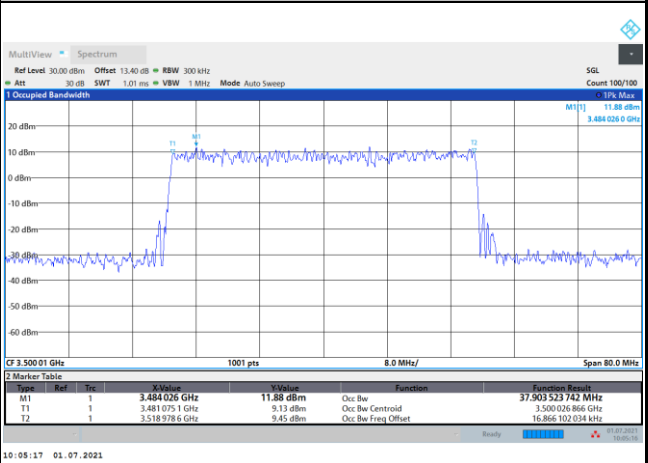

64QAM

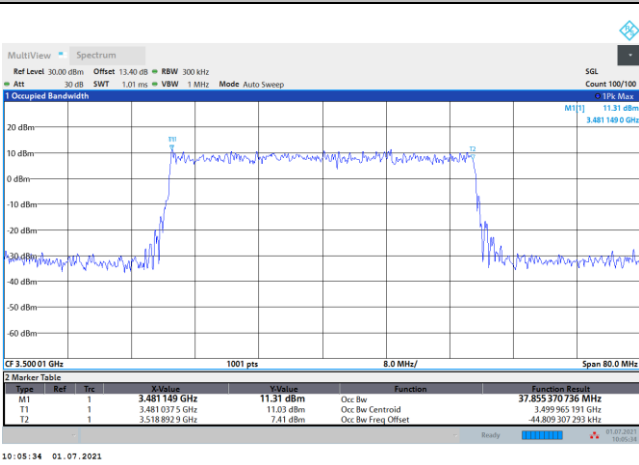

256QAM

