



FCC RADIO TEST REPORT

FCC ID : A4RGB62Z
Equipment : Phone
Model Name : GB62Z
Applicant : Google LLC
1600 Amphitheatre Parkway,
Mountain View, California, 94043 USA
Standard : FCC Part 15 Subpart E §15.407

The product was received on Nov. 11, 2021 and testing was performed from Nov. 12, 2021 to Feb. 16, 2022. We, Sporton International Inc. EMC & Wireless Communications Laboratory, would like to declare that the tested sample has been evaluated in accordance with the test procedures and has been in compliance with the applicable technical standards.

The test results in this report apply exclusively to the tested model / sample. Without written approval from Sporton International Inc. EMC & Wireless Communications Laboratory, the test report shall not be reproduced except in full.

Louis Wu

Approved by: Louis Wu

Sporton International Inc. EMC & Wireless Communications Laboratory

No. 52, Huaya 1st Rd., Guishan Dist., Taoyuan City 333, Taiwan (R.O.C.)



Table of Contents

History of this test report..... 3

Summary of Test Result..... 4

1 General Description 5

 1.1 Product Feature of Equipment Under Test..... 5

 1.2 Product Specification of Equipment Under Test..... 6

 1.3 Modification of EUT 7

 1.4 Testing Location 8

 1.5 Applicable Standards..... 8

2 Test Configuration of Equipment Under Test 9

 2.1 Carrier Frequency and Channel 9

 2.2 Test Mode..... 11

 2.3 Connection Diagram of Test System 14

 2.4 Support Unit used in test configuration and system 15

 2.5 EUT Operation Test Setup 15

 2.6 Measurement Results Explanation Example..... 15

3 Test Result 16

 3.1 26dB & 99% Occupied Bandwidth Measurement 16

 3.2 Maximum conducted Output Power and Fundamental Maximum EIRP Measurement 21

 3.3 Fundamental Power Spectral Density Measurement 22

 3.4 In-Band Emissions (Channel Mask) 28

 3.5 Contention Based Protocol 80

 3.6 Unwanted Emissions Measurement 103

 3.7 AC Conducted Emission Measurement..... 108

 3.8 Antenna Requirements 110

4 List of Measuring Equipment..... 112

5 Uncertainty of Evaluation 114

Appendix A. Conducted Test Results

Appendix B. AC Conducted Emission Test Result

Appendix C. Radiated Spurious Emission

Appendix D. Radiated Spurious Emission Plots

Appendix E. Duty Cycle Plots



History of this test report

Report No.	Version	Description	Issue Date
FR161608-03H	01	Initial issue of report	Jan. 25, 2022
FR161608-03H	02	<ol style="list-style-type: none"> 1. Revise Connection Diagram of Test System, List of Measuring Equipment 2. Revise description for Antenna Requirements 3. Revise description in section 3.3.3 4. Revise Test Summary of Contention Based Protocol Test 5. Revise data in appendix A 6. Revise List of Measuring Equipment 	Mar. 03, 2022
FR161608-03H	03	<ol style="list-style-type: none"> 1. Add CBP test information 	Mar. 07, 2022



Summary of Test Result

Report Clause	Ref Std. Clause	Test Items	Result (PASS/FAIL)	Remark
3.1	15.403(i) 15.407(a)(10)	26dB Emission Bandwidth	Pass	-
3.1	2.1049	99% Occupied Bandwidth	Reporting only	-
3.2	15.407(a)(8)	Maximum Conducted Output Power	Reporting only	-
3.2	15.407(a)(8)	Fundamental Maximum EIRP	Pass	-
3.3	15.407(a)(8)	Fundamental Power Spectral Density	Pass	-
3.4	15.407(b)(6)	In-Band Emissions (Channel Mask)	Pass	-
3.5	15.407(d)(6)	Contention Based Protocol	Pass	-
3.6	15.407(b)	Unwanted Emissions	Pass	3.31 dB under the limit at 19995.000 MHz
3.7	15.207	AC Conducted Emission	Pass	10.62 dB under the limit at 0.152 MHz
3.8	15.203 15.407(a)	Antenna Requirement	Pass	-

Declaration of Conformity:

The test results with all measurement uncertainty excluded are presented in accordance with the regulation limits or requirements declared by manufacturers.

Comments and Explanations:

The product specifications of the EUT presented in the report are declared by the manufacturer who shall take full responsibility for the authenticity.

Reviewed by: William Chen

Report Producer: Ruby Zou



1 General Description

1.1 Product Feature of Equipment Under Test

Product Feature	
Equipment	Phone
Model Name	GB62Z
FCC ID	A4RGB62Z
EUT supports Radios application	GSM/EGPRS/WCDMA/HSPA/LTE/5G NR/NFC/GNSS WLAN 11b/g/n HT20 WLAN 11a/n HT20/HT40 WLAN 11ac VHT20/VHT40/VHT80/VHT160 WLAN 11ax HE20/HE40/HE80/HE160 Bluetooth BR/EDR/LE

Remark: The above EUT's information was declared by manufacturer.

EUT Information List	
S/N	Performed Test Item
1A261FQGR00043	Conducted Measurement
1B011FQGR00008	Radiated Spurious Emission
1B011FQGR00006	Conducted Emission
1A261FQGR00046	Contention Based Protocol



1.2 Product Specification of Equipment Under Test

Product Specification is subject to this standard	
Tx/Rx Frequency Range	5925 MHz ~ 6425 MHz 6425 MHz ~ 6525 MHz 6525 MHz ~ 6875 MHz 6875 MHz ~ 7125 MHz
Maximum Output Power	<p><5925 MHz ~ 6425 MHz> MIMO <Ant. 4+3> 802.11ax HE20: 10.76 dBm / 0.0119 W 802.11ax HE40: 13.71 dBm / 0.0235 W 802.11ax HE80: 16.47 dBm / 0.0444 W 802.11ax HE160: 19.41 dBm / 0.0873 W</p> <p><6425 MHz ~ 6525 MHz> MIMO <Ant. 4+3> 802.11ax HE20: 11.47 dBm / 0.0140 W 802.11ax HE40: 14.46 dBm / 0.0279 W 802.11ax HE80: 17.06 dBm / 0.0508 W 802.11ax HE160: 19.71 dBm / 0.0935 W</p> <p><6525 MHz ~ 6875 MHz> MIMO <Ant. 4+3> 802.11ax HE20: 14.41 dBm / 0.0276 W 802.11ax HE40: 16.46 dBm / 0.0443 W 802.11ax HE80: 19.78 dBm / 0.0951 W 802.11ax HE160: 21.91 dBm / 0.1552 W</p> <p><6875 MHz ~ 7125 MHz> MIMO <Ant. 4+3> 802.11ax HE20: 15.07 dBm / 0.0321 W 802.11ax HE40: 17.51 dBm / 0.0564 W 802.11ax HE80: 20.05 dBm / 0.1012 W 802.11ax HE160: 21.58 dBm / 0.1439 W</p>
99% Occupied Bandwidth	<p>MIMO <Ant. 4> 802.11ax HE20: 19.23 MHz 802.11ax HE40: 37.86 MHz 802.11ax HE80: 77.32 MHz 802.11ax HE160: 157.52 MHz</p> <p>MIMO <Ant. 3> 802.11ax HE20: 19.18 MHz 802.11ax HE40: 37.86 MHz 802.11ax HE80: 77.20 MHz 802.11ax HE160: 157.52 MHz</p>
Antenna Type	<p><5925 MHz ~ 6425 MHz> <Ant. 4>: IFA Antenna <Ant. 3>: IFA Antenna</p> <p><6425 MHz ~ 6525 MHz> <Ant. 4>: IFA Antenna <Ant. 3>: IFA Antenna</p> <p><6525 MHz ~ 6875 MHz> <Ant. 4>: IFA Antenna <Ant. 3>: IFA Antenna</p> <p><6875 MHz ~ 7125 MHz> <Ant. 4>: IFA Antenna <Ant. 3>: IFA Antenna</p>

Product Specification is subject to this standard			
Antenna Gain	<5925 MHz ~ 6425 MHz> <Ant. 4>: -2.9 dBi <Ant. 3>: -2.1 dBi		
	<6425 MHz ~ 6525 MHz> <Ant. 4>: -3.6 dBi <Ant. 3>: -2.5 dBi		
Antenna Function Description	<6525 MHz ~ 6875 MHz> <Ant. 4>: -5.6 dBi <Ant. 3>: -5.7 dBi		
	<6875 MHz ~ 7125 MHz> <Ant. 4>: -6.2 dBi <Ant. 3>: -6.5 dBi		
Antenna Function Description		Ant. 4	Ant. 3
	802.11ax MIMO	V	V
Type of Modulation	802.11ax : OFDMA (BPSK/QPSK/16QAM/64QAM/256QAM/1024QAM)		

Remark:

1. MIMO Ant. 4+3 Directional Gain is a calculated result from MIMO Ant. 4 and MIMO Ant. 3. The formula used in calculation is documented in section 3.8.
Power of MIMO Ant. 4 + Ant. 3 is a calculated result from sum of the power MIMO Ant. 4 and MIMO Ant. 3.
2. The above EUT's information is declared by manufacturer. Please refer to Comments and Explanations in report summary.

1.3 Modification of EUT

No modifications made to the EUT during the testing.



1.4 Testing Location

Test Site	Sporton International Inc. EMC & Wireless Communications Laboratory
Test Site Location	No.52, Huaya 1st Rd., Guishan Dist., Taoyuan City 333, Taiwan (R.O.C.) TEL: +886-3-327-3456 FAX: +886-3-328-4978
Test Site No.	Sporton Site No. CO05-HY, DF02-HY

Note: The test site complies with ANSI C63.4 2014 requirement.

Test Site	Sporton International Inc. Wensan Laboratory
Test Site Location	No.58, Aly. 75, Ln. 564, Wenhua 3rd, Rd., Guishan Dist., Taoyuan City 333010, Taiwan (R.O.C.) TEL: +886-3-327-0868 FAX: +886-3-327-0855
Test Site No.	Sporton Site No. TH05-HY, 03CH16-HY (TAF Code: 3786)
Remark	The Conducted and Radiated Spurious Emissions test item subcontracted to Sporton International Inc. Wensan Laboratory.

Note: The test site complies with ANSI C63.4 2014 requirement.

FCC designation No.: TW1190 and TW3786

1.5 Applicable Standards

According to the specifications declared by the manufacturer, the EUT must comply with the requirements of the following standards:

- ♦ FCC Part 15 Subpart E
- ♦ FCC KDB 789033 D02 General UNII Test Procedures New Rules v02r01.
- ♦ FCC KDB 987594 D02 U-NII 6 GHz EMC Measurement v01
- ♦ FCC KDB 414788 D01 Radiated Test Site v01r01.
- ♦ FCC KDB 662911 D01 Multiple Transmitter Output v02r01.
- ♦ ANSI C63.10-2013

Remark:

1. All the test items were validated and recorded in accordance with the standards without any modification during the testing.
2. The TAF code is not including all the FCC KDB listed without accreditation.
3. This EUT has also been tested and complied with the requirements of FCC Part 15, Subpart B, recorded in a separate test report.



2 Test Configuration of Equipment Under Test

- a. The EUT has been associated with peripherals and configuration operated in a manner tended to maximize its emission characteristics in a typical application. Frequency range investigated: conduction emission (150 kHz to 30 MHz), radiation emission (9 kHz to the 10th harmonic of the highest fundamental frequency or to 40 GHz, whichever is lower). For radiated measurement, , the measured emission level of the EUT was maximized by rotating the EUT on a turntable, adjusting the orientation of the EUT and EUT antenna in three orthogonal axis (X: flat, Y: portrait, Z: landscape) and accessory (Adapter or Earphone), and adjusting the measurement antenna orientation, following C63.10 exploratory test procedures and find Y plane with Adapter as worst plane.
- b. AC power line Conducted Emission was tested under maximum output power.

2.1 Carrier Frequency and Channel

BW 20M	Channel	1	5	9	13	17	21	25	29
	Freq. (MHz)	5955	5975	5995	6015	6035	6055	6075	6095
BW 40M	Channel	3		11		19		27	
	Freq. (MHz)	5965		6005		6045		6085	
BW 80M	Channel	7				23			
	Freq. (MHz)	5985				6065			
BW 160M	Channel	15							
	Freq. (MHz)	6025							

BW 20M	Channel	33	37	41	45	49	53	57	61
	Freq. (MHz)	6115	6135	6155	6175	6195	6215	6235	6255
BW 40M	Channel	35		43		51		59	
	Freq. (MHz)	6125		6165		6205		6245	
BW 80M	Channel	39				55			
	Freq. (MHz)	6145				6225			
BW 160M	Channel	47							
	Freq. (MHz)	6185							



BW 20M	Channel	65	69	73	77	81	85	89	93
	Freq. (MHz)	6275	6295	6315	6335	6355	6375	6395	6415
BW 40M	Channel	67		75		83		91	
	Freq. (MHz)	6285		6325		6365		6405	
BW 80M	Channel	71				87			
	Freq. (MHz)	6305				6385			
BW 160M	Channel	79							
	Freq. (MHz)	6345							

BW 20M	Channel	97	101	105	109	113	117	121	125
	Freq. (MHz)	6435	6455	6475	6495	6515	6535	6555	6575
BW 40M	Channel	99		107		115		123	
	Freq. (MHz)	6445		6485		6525		6565	
BW 80M	Channel	103				119			
	Freq. (MHz)	6465				6545			
BW 160M	Channel	111							
	Freq. (MHz)	6505							

BW 20M	Channel	129	133	137	141	145	149	153	157
	Freq. (MHz)	6595	6615	6635	6655	6675	6695	6715	6735
BW 40M	Channel	131		139		147		155	
	Freq. (MHz)	6605		6645		6685		6725	
BW 80M	Channel	135				151			
	Freq. (MHz)	6625				6705			
BW 160M	Channel	143							
	Freq. (MHz)	6665							

BW 20M	Channel	161	165	169	173	177	181	185	189
	Freq. (MHz)	6755	6775	6795	6815	6835	6855	6875	6895
BW 40M	Channel	163		171		179		187	
	Freq. (MHz)	6765		6805		6845		6885	
BW 80M	Channel	167				183			
	Freq. (MHz)	6785				6865			
BW 160M	Channel	175							
	Freq. (MHz)	6825							



BW 20M	Channel	193	197	201	205	209	213	217	221
	Freq. (MHz)	6915	6935	6955	6975	6995	7015	7035	7055
BW 40M	Channel	195		203		211		219	
	Freq. (MHz)	6925		6965		7005		7045	
BW 80M	Channel	199				215			
	Freq. (MHz)	6945				7025			
BW 160M	Channel	207							
	Freq. (MHz)	6985							
BW 20M	Channel	225				229			
	Freq. (MHz)	7075				7095			
BW 40M	Channel	227							
	Freq. (MHz)	7085							

2.2 Test Mode

This device support 26/52/106/242/484/996-tone RU but does not support 2x996-tone RU on 160MHz channel.

The PSD of partial RU is reduced to be smaller than full RU according to TCB workshop interim guidance.

The final test modes consider the modulation and the worst data rates as shown in the table below.

MIMO Mode

Modulation	Data Rate
802.11ax HE20	MCS0
802.11ax HE40	MCS0
802.11ax HE80	MCS0
802.11ax HE160	MCS0

Test Cases	
AC Conducted Emission	Mode 1 : GSM850 Idle + WLAN (6GHz) Link + Bluetooth Link + USB Cable 2 (Charging from AC Adapter 1)
Remark: For Radiated Test Cases, the tests were performed with Adapter 1 and USB Cable 2.	



Based on ANSI C63.10 clause 5.6.2.2, b) spurious emissions,

Measure the mode with the highest output power and the mode with highest output power spectral density for each modulation family.

		5.6.2.2 (b) Spurious Emissions
UNII-5	20MHz	Covered by 160MHz
	40MHz	Covered by 160MHz
	80MHz	Covered by 160MHz
	160MHz	Test
UNII-6	20MHz	Covered by 160MHz
	40MHz	Covered by 160MHz
	80MHz	Covered by 160MHz
	160MHz	Test
UNII-7	20MHz	Covered by 160MHz
	40MHz	Covered by 160MHz
	80MHz	Covered by 160MHz
	160MHz	Test
UNII-8	20MHz	Covered by 160MHz
	40MHz	Covered by 160MHz
	80MHz	Covered by 160MHz
	160MHz	Test



Ch. #		UNII-5 (5925-6425 MHz)	UNII-6 (6425-6525 MHz)	UNII-7 (6525-6875 MHz)	UNII-8 (6875-7125 MHz)
		802.11ax HE20	802.11ax HE20	802.11ax HE20	802.11ax HE20
L	Low	001	-	-	-
M	Middle	-	-	-	-
H	High	-	-	-	229
Straddle		-	-	-	-

Ch. #		UNII-5 (5925-6425 MHz)	UNII-6 (6425-6525 MHz)	UNII-7 (6525-6875 MHz)	UNII-8 (6875-7125 MHz)
		802.11ax HE40	802.11ax HE40	802.11ax HE40	802.11ax HE40
L	Low	003	-	-	-
M	Middle	-	-	-	-
H	High	-	-	-	227
Straddle		-	-	-	-

Ch. #		UNII-5 (5925-6425 MHz)	UNII-6 (6425-6525 MHz)	UNII-7 (6525-6875 MHz)	UNII-8 (6875-7125 MHz)
		802.11ax HE80	802.11ax HE80	802.11ax HE80	802.11ax HE80
L	Low	007	-	-	-
M	Middle	-	-	-	-
H	High	-	-	-	215
Straddle		-	-	-	-

Ch. #		UNII-5 (5925-6425 MHz)	UNII-6 (6425-6525 MHz)	UNII-7 (6525-6875 MHz)	UNII-8 (6875-7125 MHz)
		802.11ax HE160	802.11ax HE160	802.11ax HE160	802.11ax HE160
L	Low	015	-	143	207
M	Middle	047	-		
H	High	079	-		
Straddle		-	111	175	-

Remark: For radiation spurious emission, the modulation and the data rate picked for testing are determined by the Max. RF conducted power.

2.3 Connection Diagram of Test System

<AC Conducted Emission Mode>

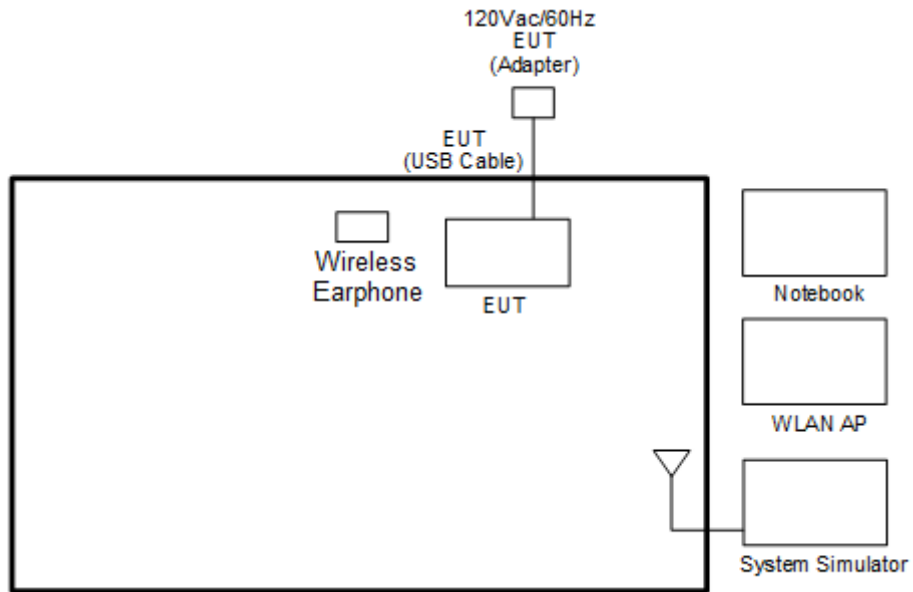

<WLAN Tx Mode>

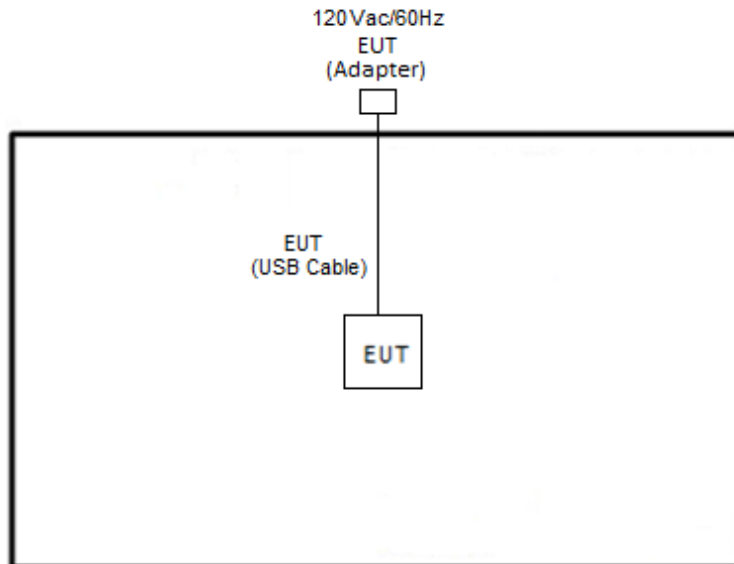



2.4 Support Unit used in test configuration and system

Item	Equipment	Brand Name	Model Name	FCC ID	Data Cable	Power Cord
1.	System Simulator	Anritsu	MT8820C	N/A	N/A	Unshielded, 1.8 m
2.	Wireless Earphone	Google	G1007/G1008	A4RG1007/ A4RG1008	N/A	N/A
3.	WLAN AP	NETGEAR64	RAXE500	N/A	N/A	Unshielded,1.8m
4.	Notebook	Dell	Latitude 3400	FCC DoC	N/A	AC I/P: Unshielded, 1.2 m DC O/P: Shielded, 1.8 m

2.5 EUT Operation Test Setup

The RF test items, utility “Command v10.0.17134.134” was installed in Notebook which was programmed in order to make the EUT get into the engineering modes to provide channel selection, power level, data rate and the application type and for continuous transmitting signals.

2.6 Measurement Results Explanation Example

For all conducted test items:

The offset level is set in the spectrum analyzer to compensate the RF cable loss and attenuator factor between EUT conducted output port and spectrum analyzer. With the offset compensation, the spectrum analyzer reading level is exactly the EUT RF output level.

Example :

The spectrum analyzer offset is derived from RF cable loss and attenuator factor.

Offset = RF cable loss + attenuator factor.

Following shows an offset computation example with cable loss 4.2 dB and 10dB attenuator.

$$\begin{aligned} \text{Offset(dB)} &= \text{RF cable loss(dB)} + \text{attenuator factor(dB)}. \\ &= 4.2 + 10 = 14.2 \text{ (dB)} \end{aligned}$$

3 Test Result

3.1 26dB & 99% Occupied Bandwidth Measurement

3.1.1 Limit of 26dB & 99% Occupied Bandwidth

<FCC 14-30 CFR 15.407>

(a)(10) The maximum transmitter channel bandwidth for U-NII devices in the 5.925-7.125 GHz band is 320 megahertz.

3.1.2 Measuring Instruments

Please refer to the measuring equipment list in this test report.

3.1.3 Test Procedures

1. The testing follows FCC KDB 789033 D02 General UNII Test Procedures New Rules v02r01. Section C) Emission bandwidth
2. Set RBW = approximately 1% of the emission bandwidth (1MHz for all supported bandwidth).
3. Set the VBW > RBW.
4. Detector = Peak.
5. Trace mode = max hold
6. Measure the maximum width of the emission that is 26 dB down from the peak of the emission. Compare this with the RBW setting of the analyzer. Readjust RBW and repeat measurement as needed until the RBW/EBW ratio is approximately 1%.
7. For 99% Bandwidth Measurement, the spectrum analyzer's resolution bandwidth (RBW) is set 1-5% of the emission bandwidth and set the Video bandwidth (VBW) $\geq 3 * RBW$.
8. Measure and record the results in the test report.

3.1.4 Test Setup

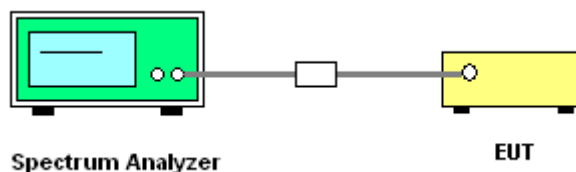

3.1.5 Test Result of 26dB & 99% Occupied Bandwidth

Please refer to Appendix A.



<802.11ax HE20 Mode>

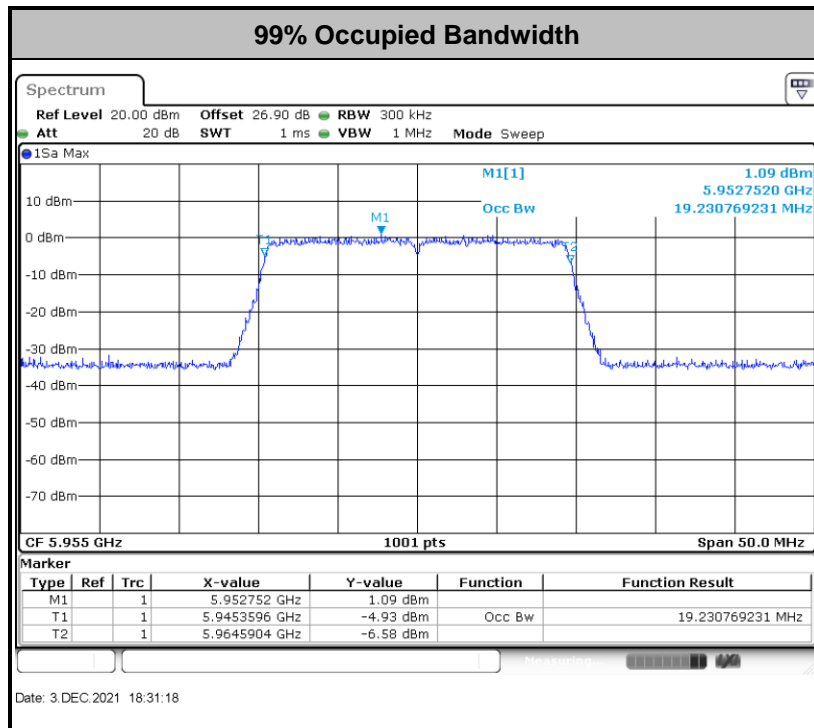
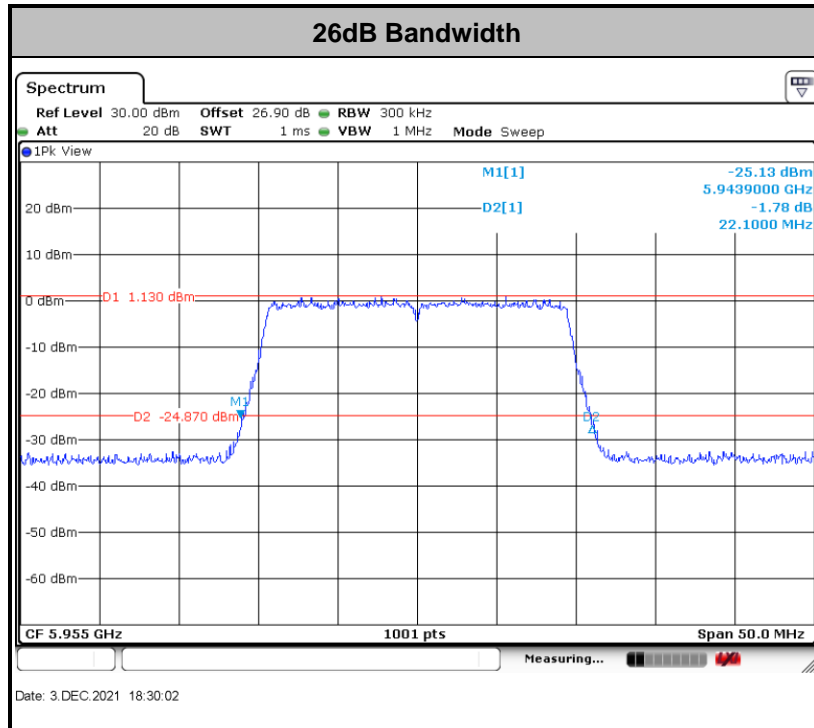

Note: The occupied channel bandwidth is maintained within the band of operation for all of the modulations.



<802.11ax HE40 Mode>

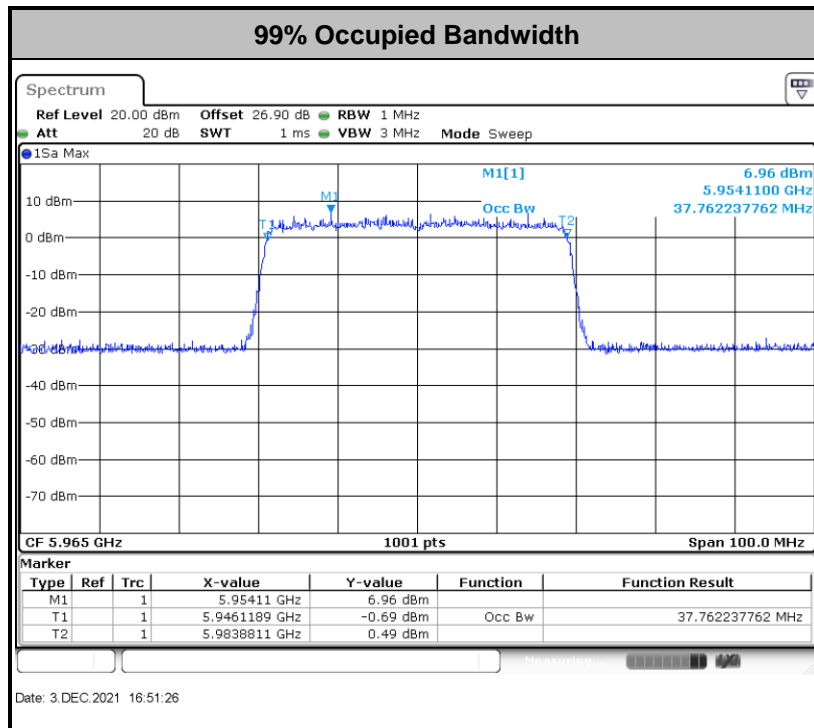
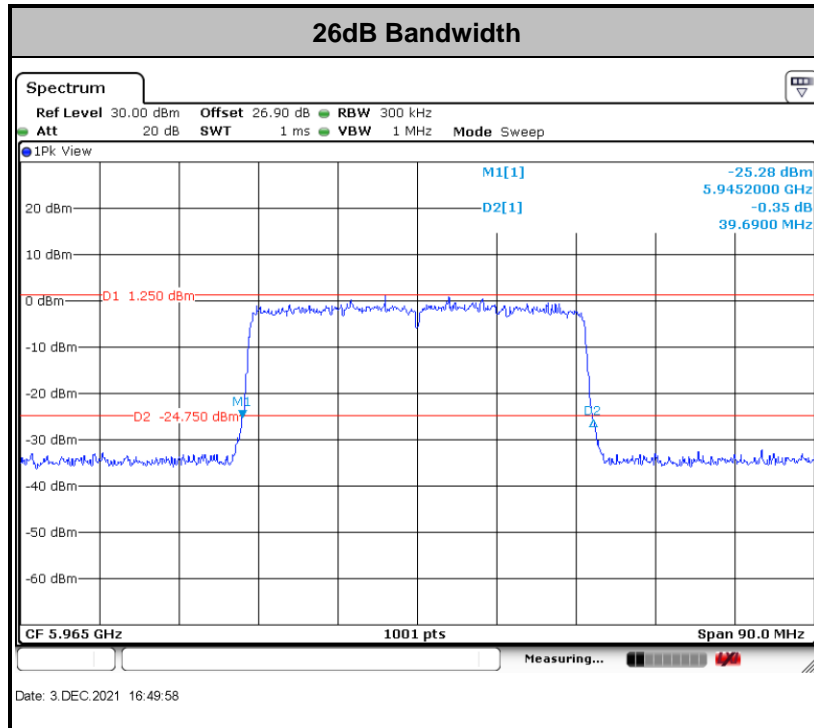

Note: The occupied channel bandwidth is maintained within the band of operation for all of the modulations.



<802.11ax HE80 Mode>

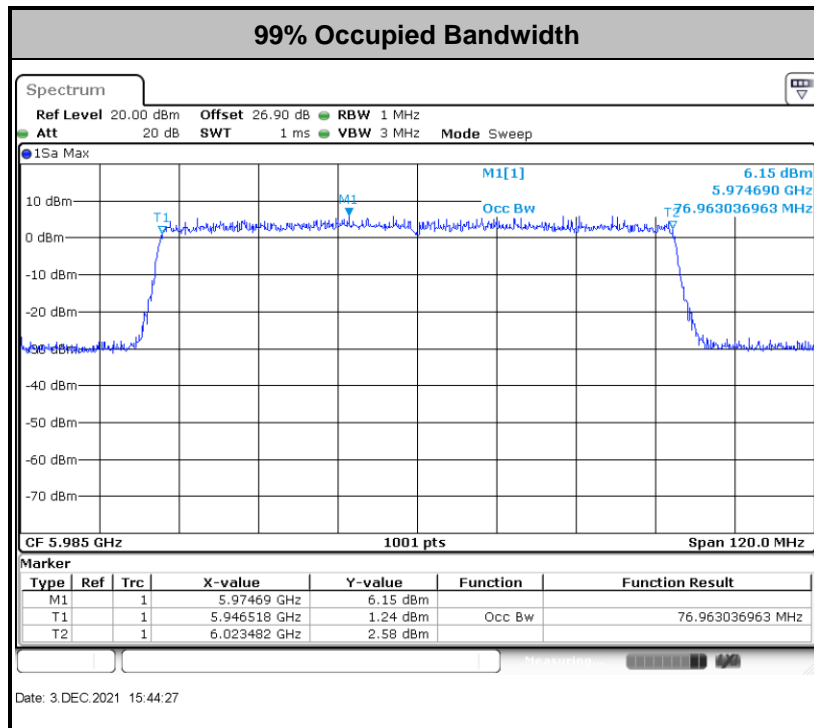
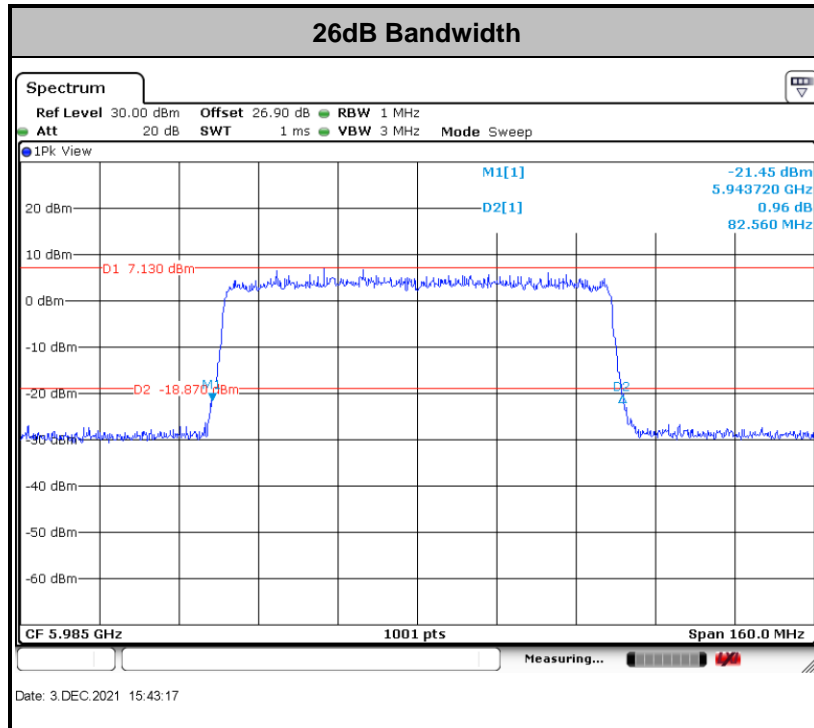

Note: The occupied channel bandwidth is maintained within the band of operation for all of the modulations.



<802.11ax HE160 Mode>

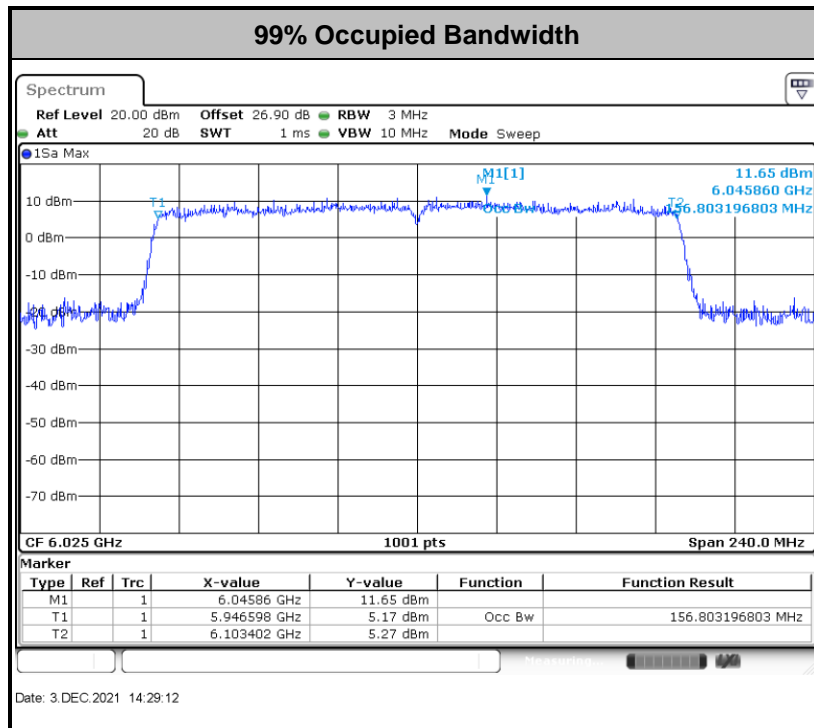
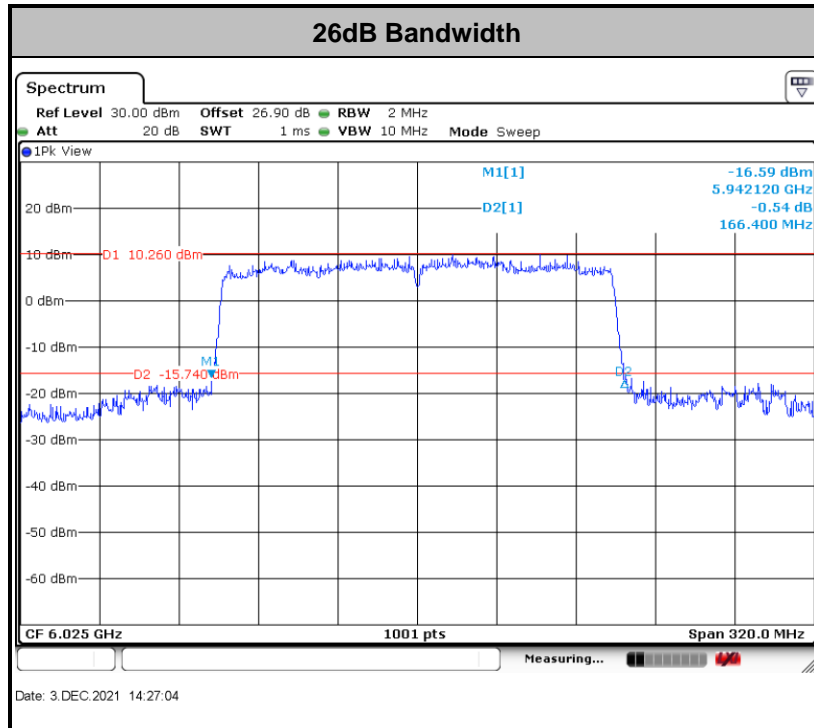

Note: The occupied channel bandwidth is maintained within the band of operation for all of the modulations.

3.2 Maximum conducted Output Power and Fundamental Maximum EIRP Measurement

3.2.1 Limit of Fundamental Maximum EIRP

<FCC 14-30 CFR 15.407>

(a)(8) For client devices operating under the control of an indoor access point in the 5.925-7.125 GHz bands, the maximum e.i.r.p. over the frequency band of operation must not exceed 24 dBm.

3.2.2 Measuring Instruments

Please refer to the measuring equipment list in this test report.

3.2.3 Test Procedures

The testing follows Method PM-G of FCC KDB 789033 D02 General UNII Test Procedures New Rules v02r01.

Method PM-G (Measurement using a gated RF average power meter):

1. Measurement is performed using a wideband RF power meter.
2. The EUT is configured to transmit at its maximum power control level.
3. Measure the average power of the transmitter.
4. Since the measurement is made only during the ON time of the transmitter, no duty cycle correction factor is required.
5. For MIMO mode, calculation method follows FCC KDB 662911 D01 Multiple Transmitter Output v02r01.

3.2.4 Test Setup

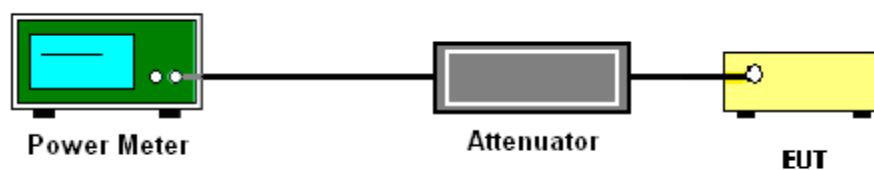

3.2.5 Test Result of Fundamental Maximum EIRP

Please refer to Appendix A.



3.3 Fundamental Power Spectral Density Measurement

3.3.1 Limit of Fundamental Power Spectral Density

<FCC 14-30 CFR 15.407>

(a)(8) For client devices operating under the control of an indoor access point in the 5.925-7.125 GHz bands, the maximum power spectral density must not exceed -1 dBm e.i.r.p. in any 1-megahertz band.

3.3.2 Measuring Instruments

Please refer to the measuring equipment list in this test report.

3.3.3 Test Procedures

The testing follows FCC KDB 789033 D02 General UNII Test Procedures New Rules v02r01.

Section F) Maximum power spectral density.

Method SA-2

(trace averaging across on and off times of the EUT transmissions, followed by duty cycle correction).

- Measure the duty cycle.
 - Set span to encompass the entire emission bandwidth (EBW) of the signal.
 - Set RBW = 1 MHz.
 - Set VBW \geq 3 MHz.
 - Number of points in sweep \geq 2 Span / RBW.
 - Sweep time = auto.
 - Detector = RMS
 - Trace average at least 100 traces in power averaging mode.
 - Add $10 \log(1/x)$, where x is the duty cycle, to the measured power in order to compute the average power during the actual transmission times. For example, add $10 \log(1/0.25) = 6$ dB if the duty cycle is 25 percent.
1. The RF output of EUT was connected to the spectrum analyzer by a low loss cable.
 2. Each plot has already offset with cable loss, and attenuator loss. Measure the PPSD and record it.
 3. For MIMO mode, calculation method follows FCC KDB 662911 D01 Multiple Transmitter Output v02r01.

Method (a): Measure and sum the spectra across the outputs.

The total final Power Spectral Density is from a device with 2 transmitter outputs. The spectrum measurements of the individual outputs are all performed with the same span and number of points; the spectrum value in the first spectral bin of output 1 is summed with that in the first spectral bin of output 2 to obtain the value for the first frequency bin of the summed spectrum.

3.3.4 Test Setup

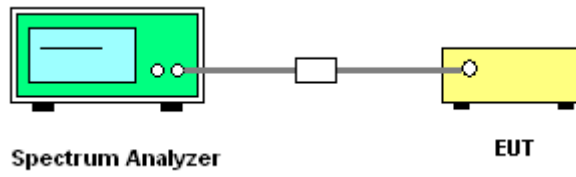

3.3.5 Test Result of Power Spectral Density

Please refer to Appendix A.



<802.11ax HE20 Mode>

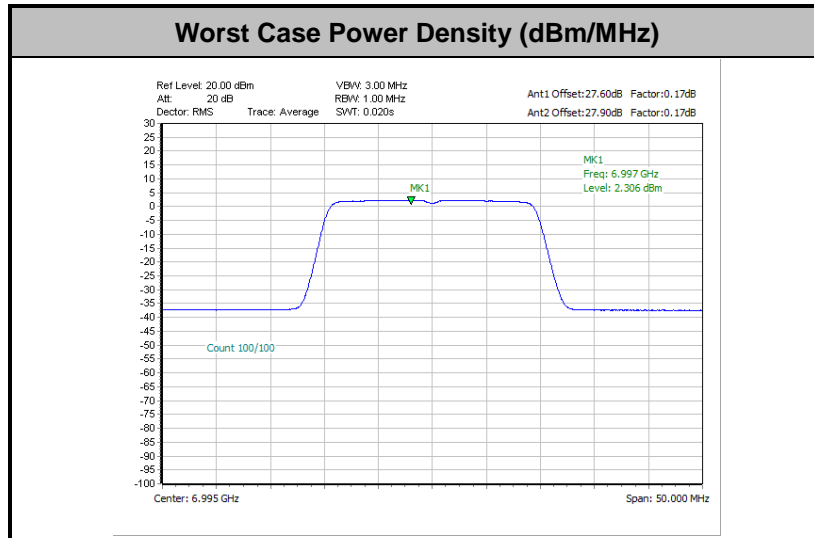

Remark: The test plot is showing a bin by bin combined result mathematically adds two traces.

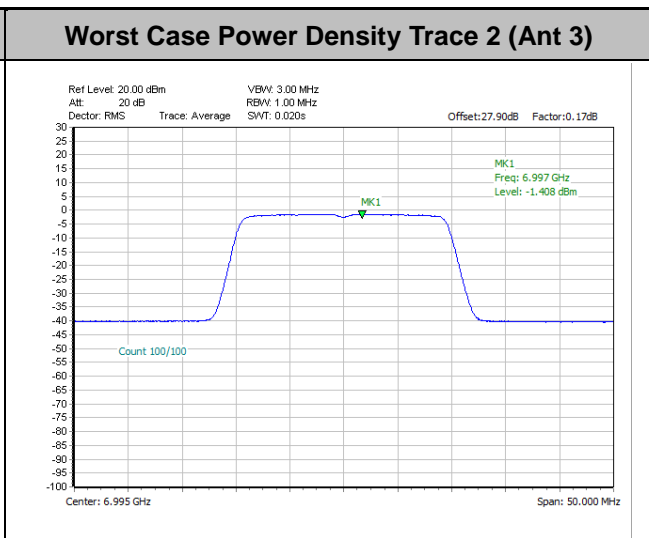
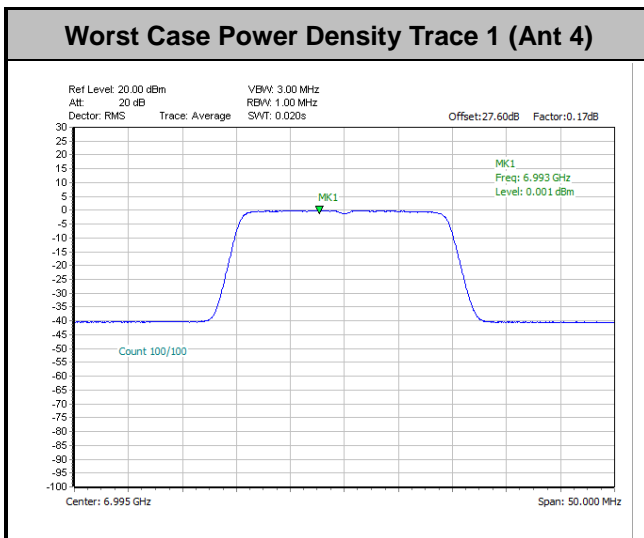



<802.11ax HE40 Mode>

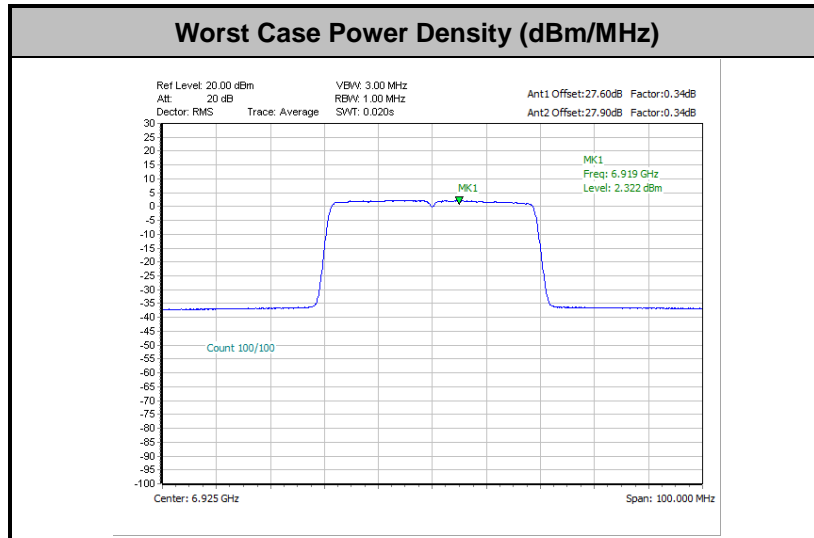

Remark: The test plot is showing a bin by bin combined result mathematically adds two traces.

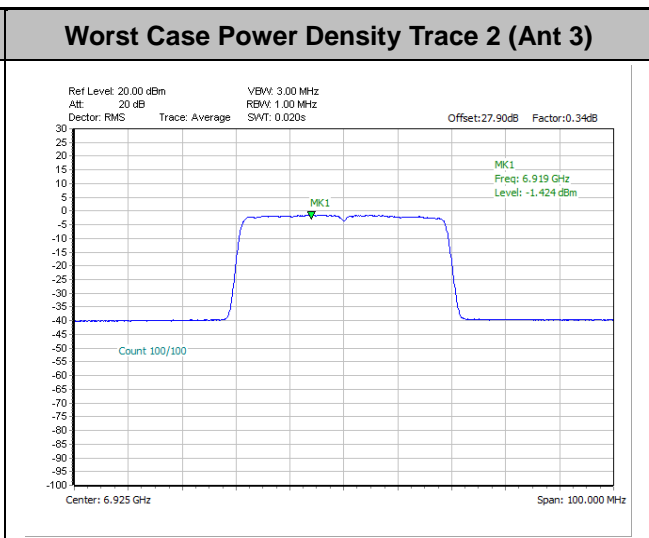
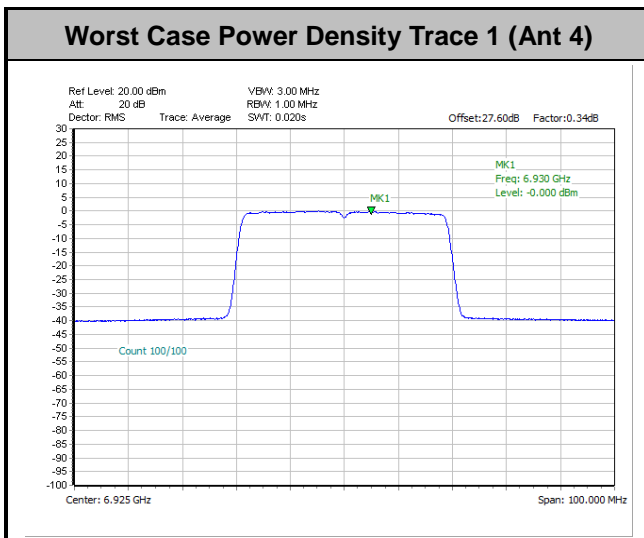



<802.11ax HE80 Mode>

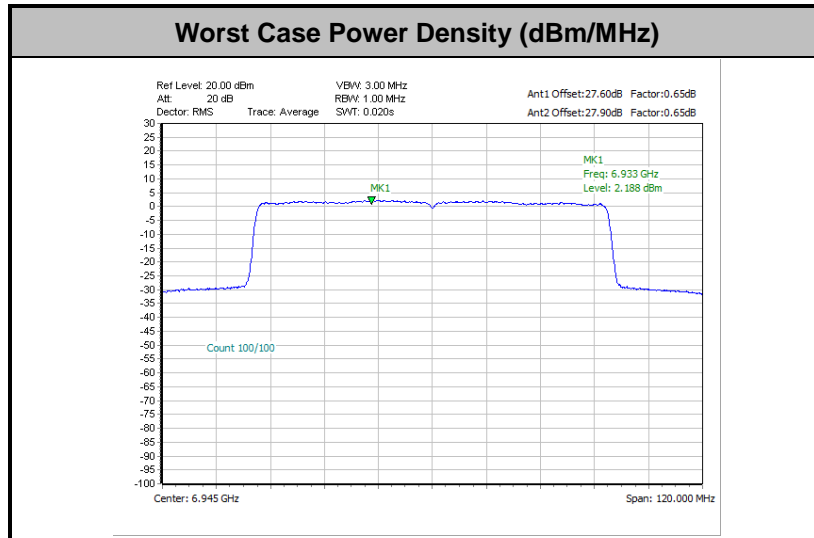

Remark: The test plot is showing a bin by bin combined result mathematically adds two traces.

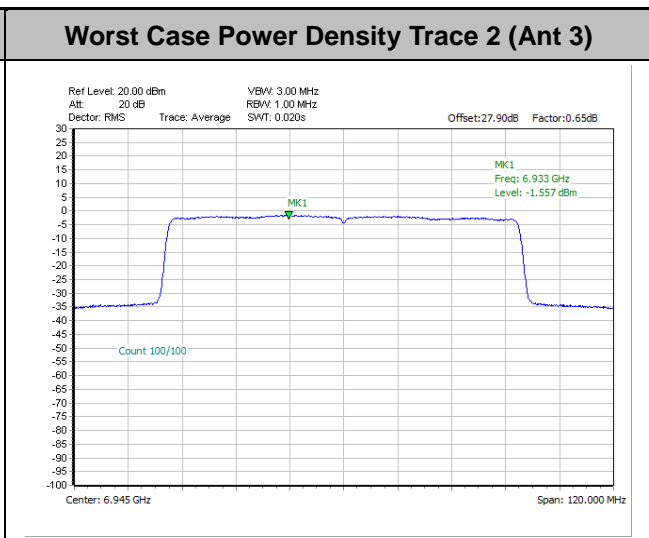
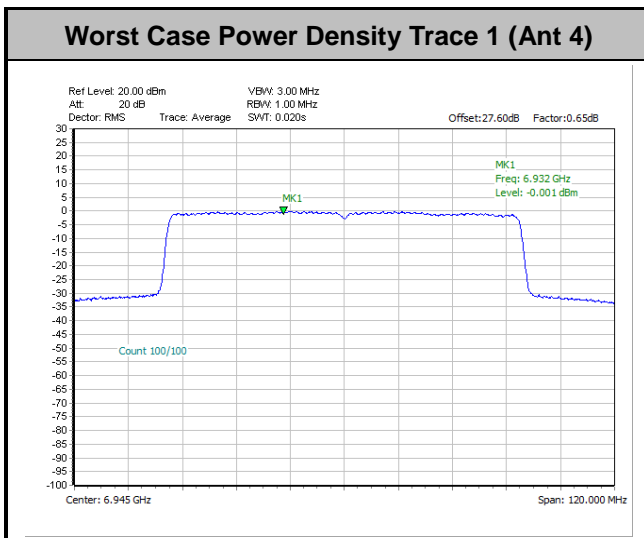



<802.11ax HE160 Mode>

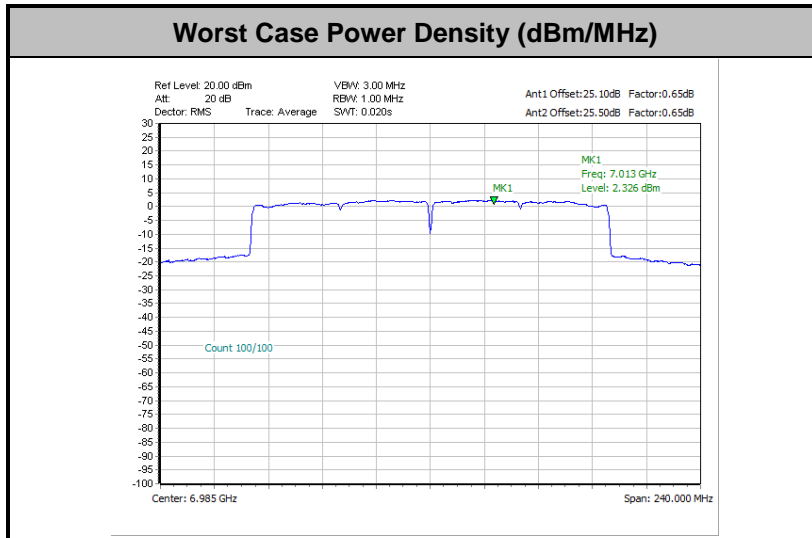

Remark: The test plot is showing a bin by bin combined result mathematically adds two traces.

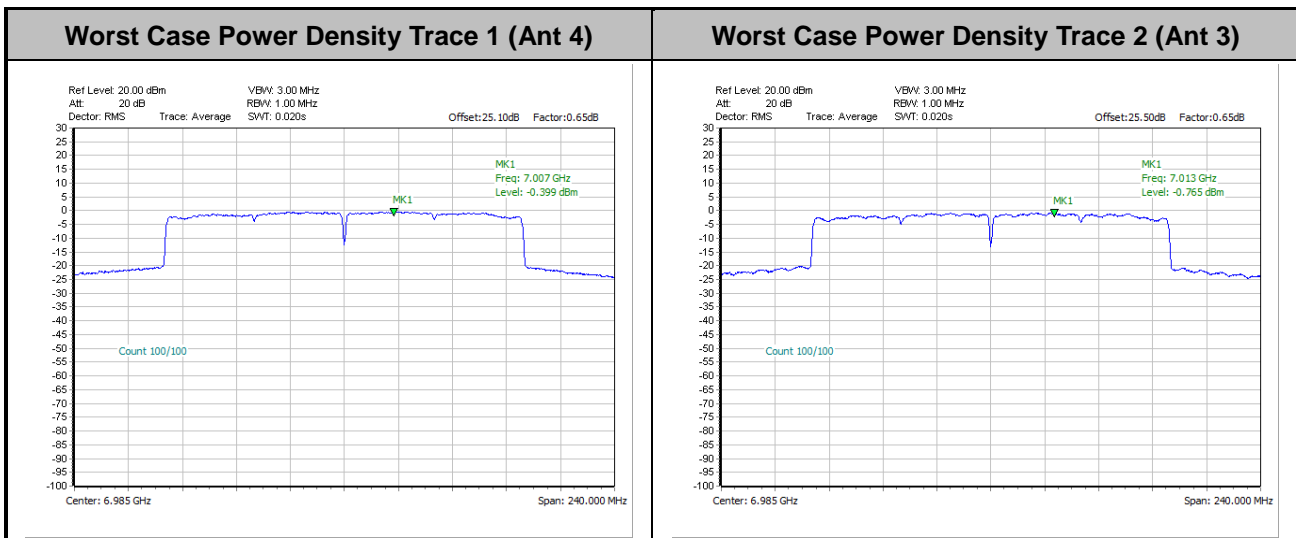



3.4 In-Band Emissions (Channel Mask)

3.4.1 Limit of Unwanted Emissions

<FCC 14-30 CFR 15.407>

(a)(6) For transmitters operating within the 5.925-7.125 GHz bands: Power spectral density must be suppressed by 20 dB at 1 MHz outside of channel edge, by 28 dB at one channel bandwidth from the channel center, and by 40 dB at one- and one-half times the channel bandwidth away from channel center. At frequencies between one megahertz outside an unlicensed device's channel edge and one channel bandwidth from the center of the channel, the limits must be linearly interpolated between 20 dB and 28 dB suppression, and at frequencies between one and one- and one-half times an unlicensed device's channel bandwidth, the limits must be linearly interpolated between 28 dB and 40 dB suppression. Emissions removed from the channel center by more than one- and one-half times the channel bandwidth must be suppressed by at least 40 dB.

3.4.2 Measuring Instruments

Please refer to the measuring equipment list in this test report.

3.4.3 Test Procedures

The testing follows FCC KDB 987594 D02 U-NII 6GHz EMC Measurement v01.

Section J) In-Band Emissions.

1. Take nominal bandwidth as reference channel bandwidth provided that 26 dB emission bandwidth is always larger than nominal bandwidth
2. Measure the power spectral density (which will be used for emissions mask reference) using the following procedure:
 - a) Set the span to encompass the entire 26 dB EBW of the signal.
 - b) Set RBW = same RBW used for 26 dB EBW measurement (1MHz for all supported bandwidth).
 - c) Set VBW $\geq 3 \times$ RBW
 - d) Number of points in sweep $\geq [2 \times \text{span} / \text{RBW}]$.
 - e) Sweep time = auto.
 - f) Detector = RMS (i.e., power averaging)
 - g) Trace average at least 100 traces in power averaging (rms) mode.
 - h) Use the peak search function on the instrument to find the peak of the spectrum.
3. Using the measuring equipment limit line function, develop the emissions mask based on the following requirements. The emissions power spectral density must be reduced below the peak power spectral density (in dB) as follows:
 - a. Suppressed by 20 dB at 1 MHz outside of the channel edge.
 - b. Suppressed by 28 dB at one channel bandwidth from the channel center.
 - c. Suppressed by 40 dB at one- and one-half times the channel bandwidth from the channel center.
4. Adjust the span to encompass the entire mask as necessary.
5. Clear trace.
6. Trace average at least 100 traces in power averaging (rms) mode.
7. Adjust the reference level as necessary so that the crest of the channel touches the top of the emission mask.

3.4.4 Test Setup

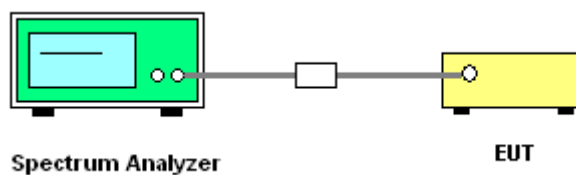



3.4.5 Test Result

MIMO <Ant. 4+3(4)>

EUT Mode : 802.11ax HE20 Full RU

Plot on Channel 5955MHz

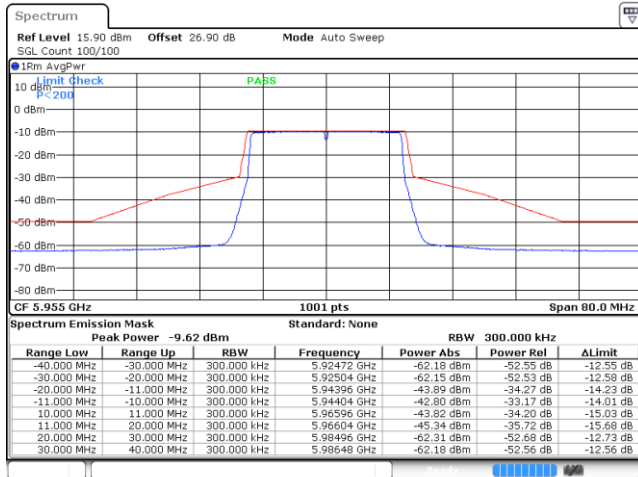

Date: 3.DEC.2021 18:31:56

Plot on Channel 6195MHz

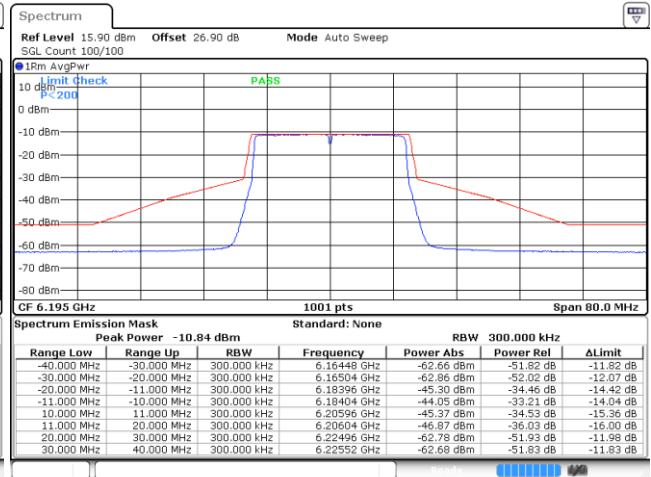

Date: 3.DEC.2021 18:38:07

Plot on Channel 6415MHz

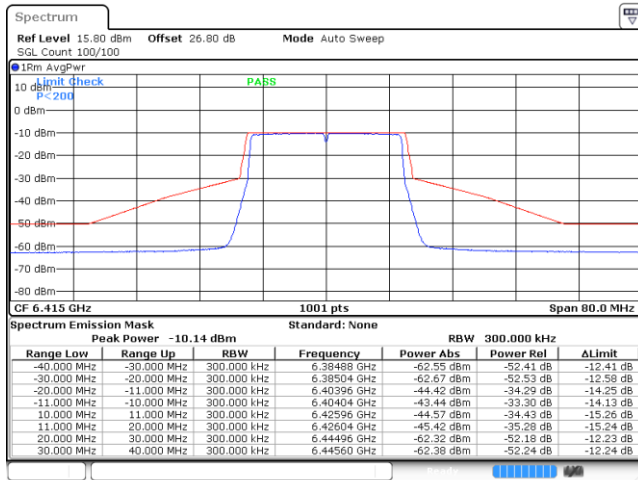

Date: 3.DEC.2021 18:44:53

Plot on Channel 6435MHz

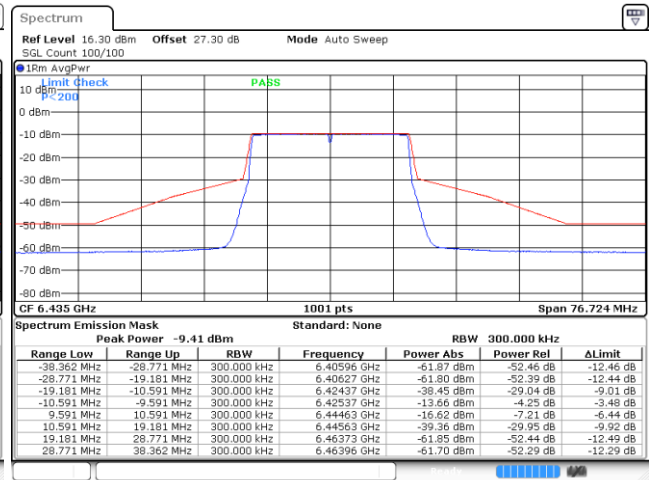

Date: 15.JAN.2022 17:50:04



Plot on Channel 6475MHz

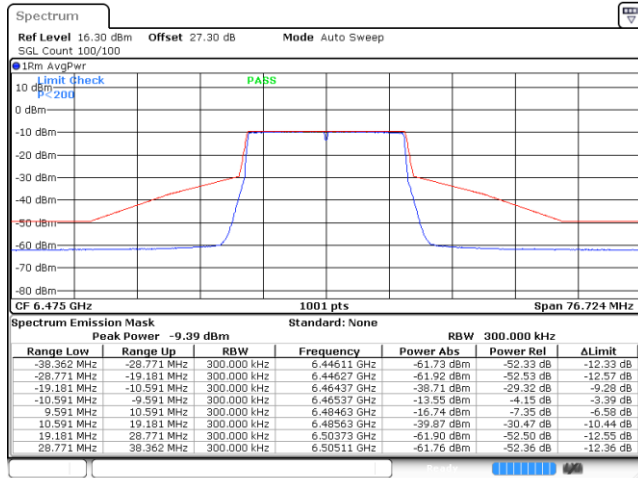

Date: 15 JAN 2022 17:52:56

Plot on Channel 6515MHz

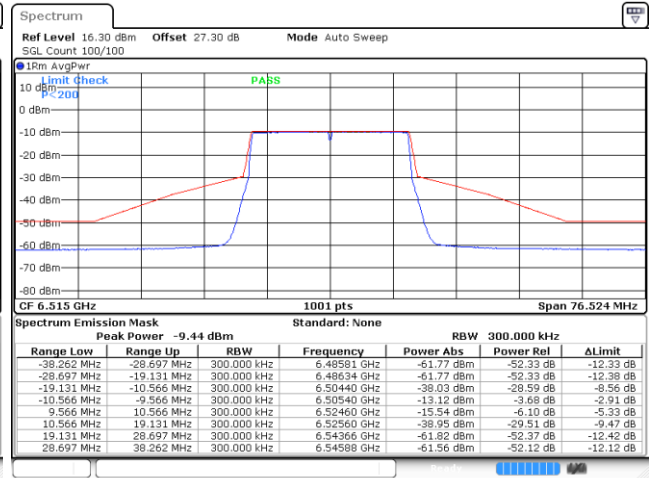

Date: 15 JAN 2022 17:55:42

Plot on Channel 6535MHz

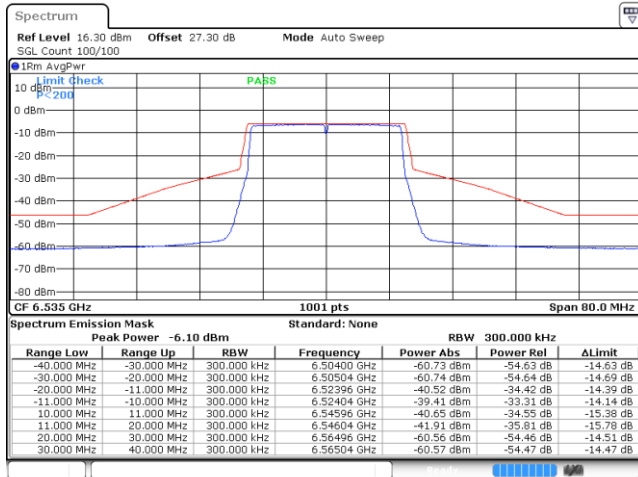

Date: 3 DEC 2021 19:13:31

Plot on Channel 6695MHz

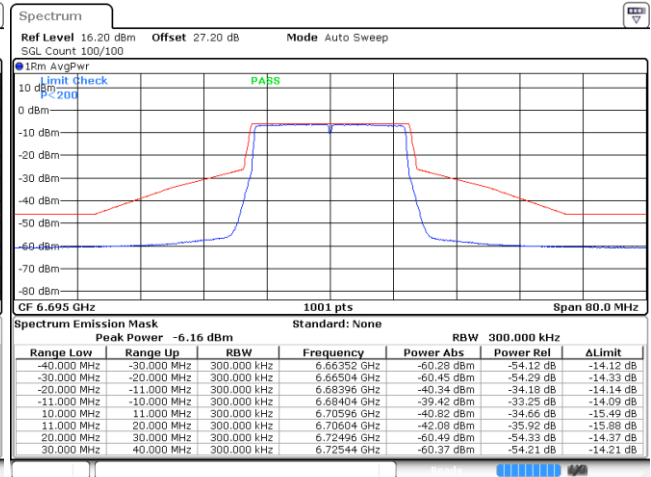

Date: 3 DEC 2021 19:18:18



Plot on Channel 6855MHz

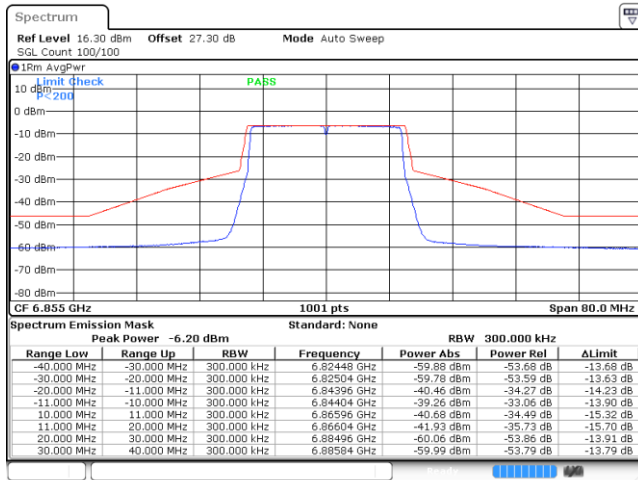

Date: 3 DEC 2021 19:23:49

Plot on Channel 6875MHz

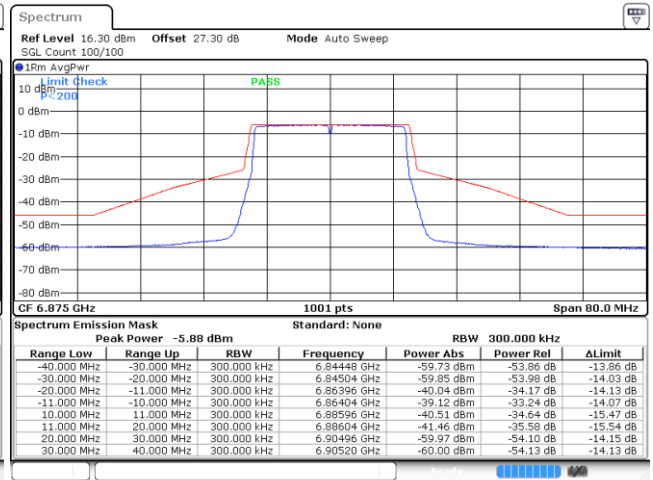

Date: 3 DEC 2021 19:27:34

Plot on Channel 6895MHz

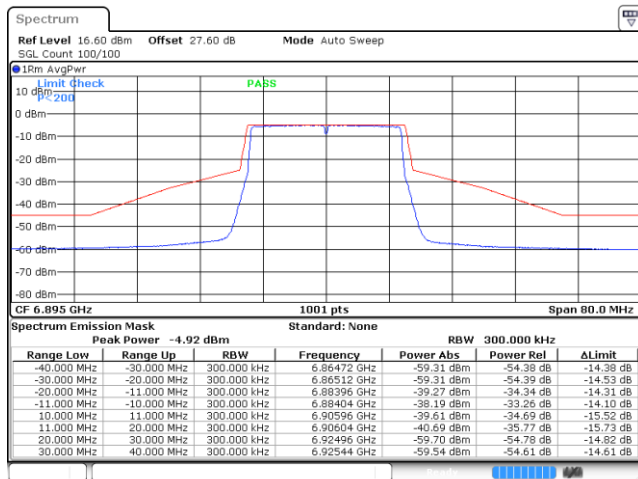

Date: 3 DEC 2021 19:32:45

Plot on Channel 6995MHz

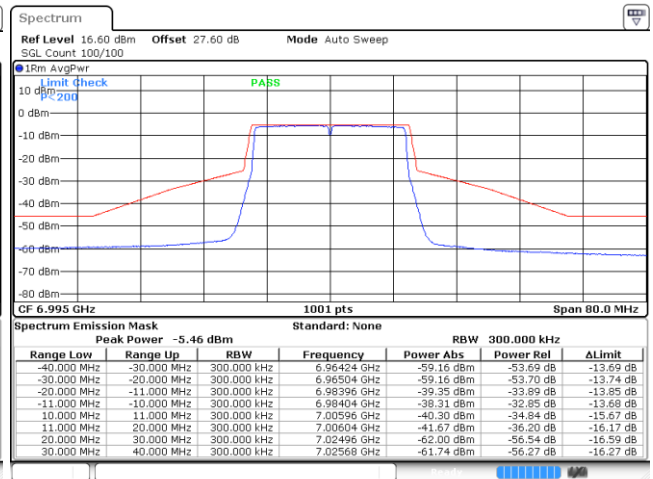

Date: 3 DEC 2021 19:37:25



Plot on Channel 7095MHz

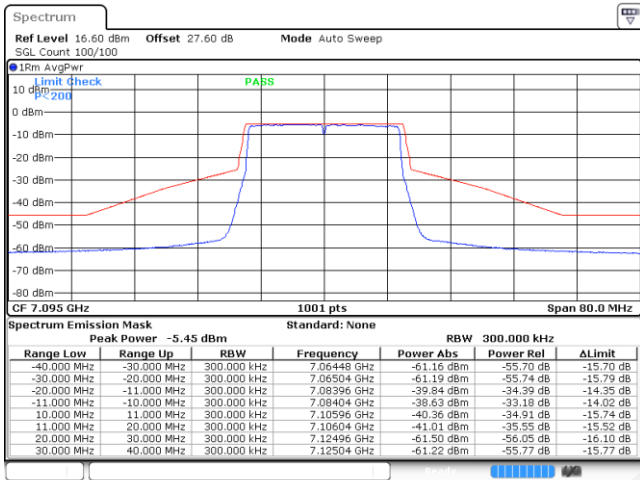

Date: 3 DEC 2021 19:42:24



EUT Mode : 802.11ax HE20 26RU

Plot on Channel 5955MHz

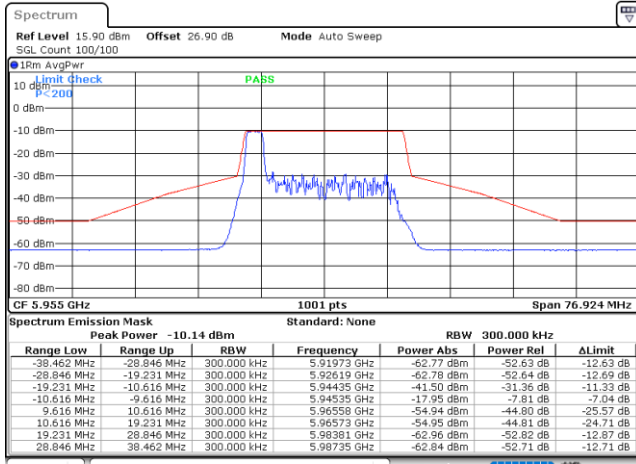

Date: 15.JAN.2022 10:57:27

Plot on Channel 6195MHz

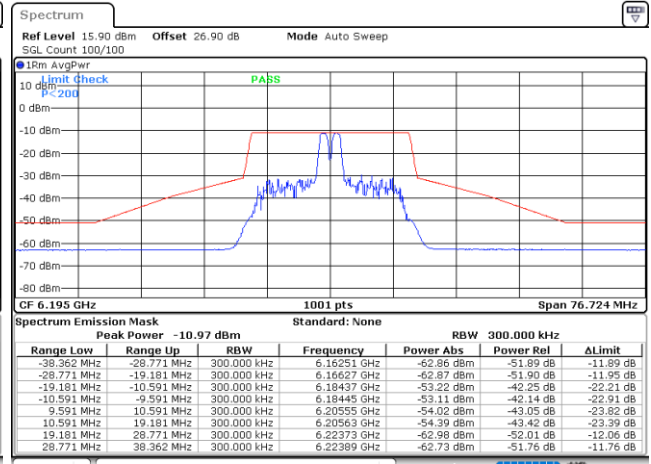

Date: 15.JAN.2022 11:12:26

Plot on Channel 6415MHz

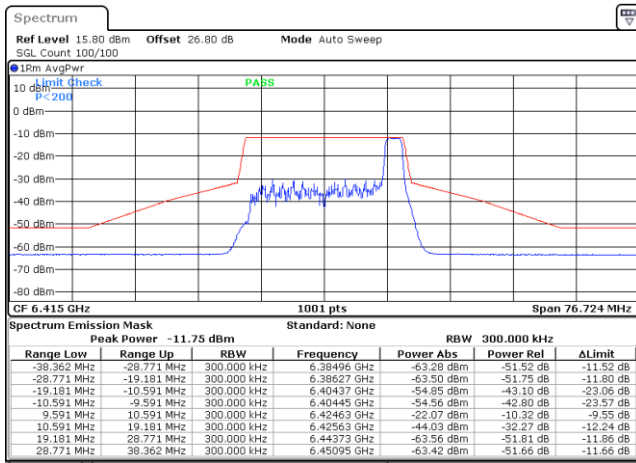

Date: 15.JAN.2022 11:22:21

Plot on Channel 6435MHz

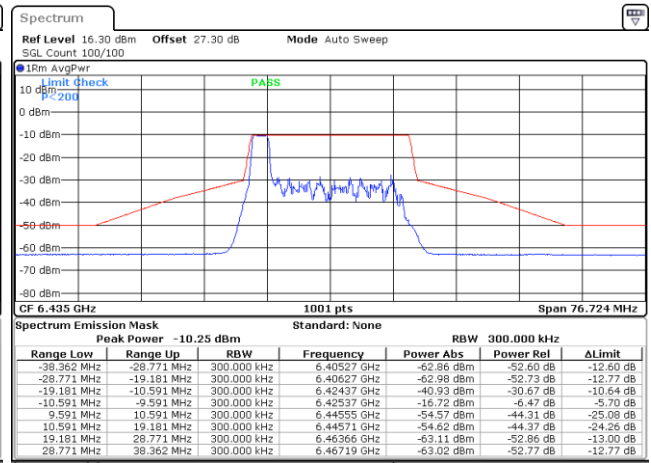

Date: 15.JAN.2022 11:29:36



Plot on Channel 6475MHz

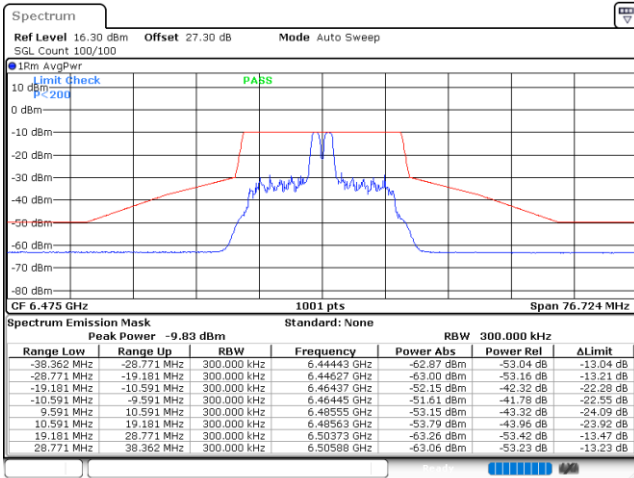

Date: 15.JAN.2022 11:38:51

Plot on Channel 6515MHz

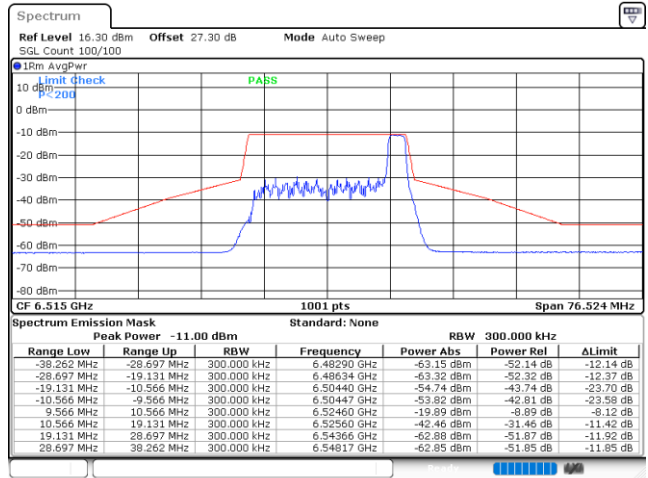

Date: 15.JAN.2022 12:43:04

Plot on Channel 6535MHz

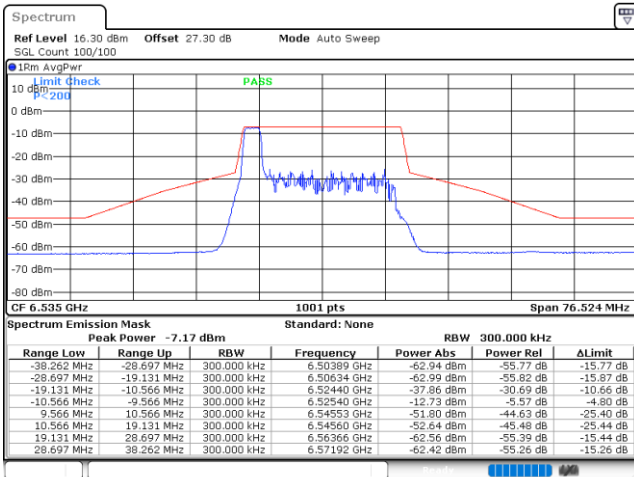

Date: 15.JAN.2022 12:54:49

Plot on Channel 6695MHz

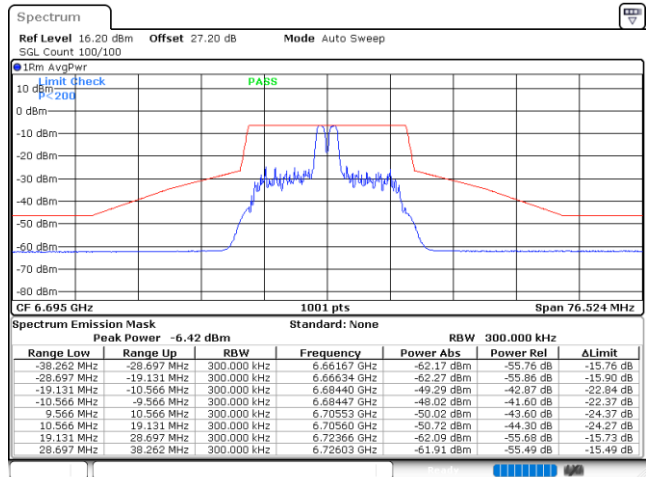

Date: 15.JAN.2022 13:04:55



Plot on Channel 6855MHz

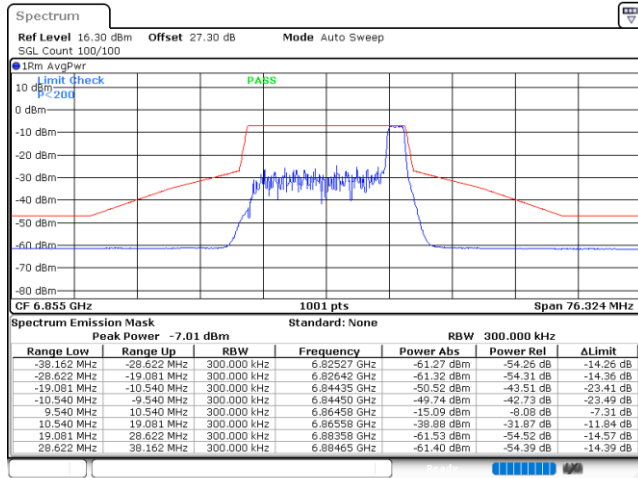

Date: 15.JAN.2022 13:14:07

Plot on Channel 6875MHz

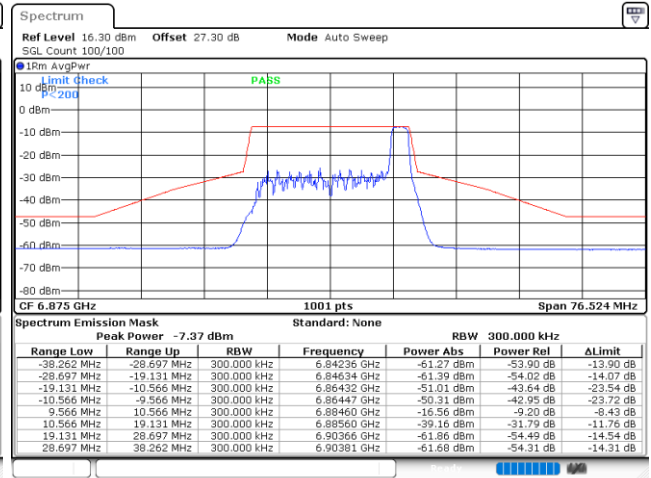

Date: 15.JAN.2022 13:29:35

Plot on Channel 6895MHz

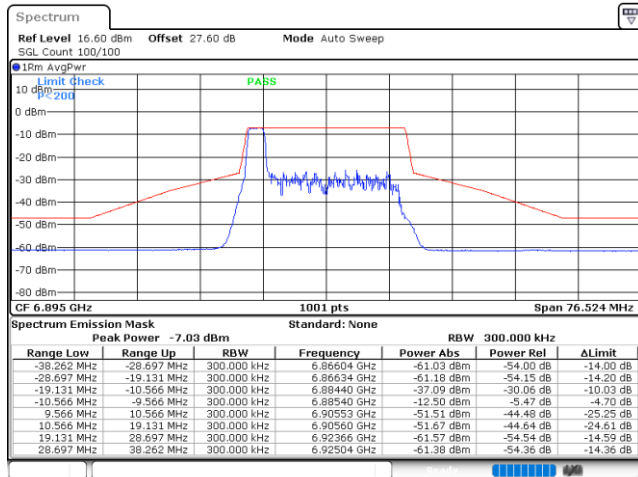

Date: 15.JAN.2022 13:35:24

Plot on Channel 6995MHz

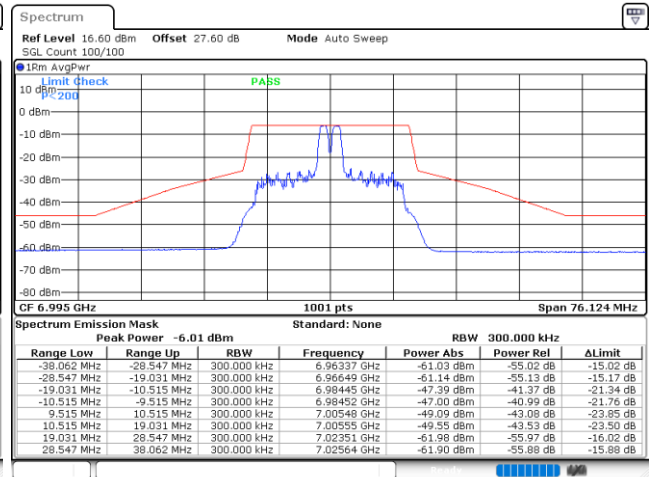

Date: 15.JAN.2022 13:48:21



Plot on Channel 7095MHz

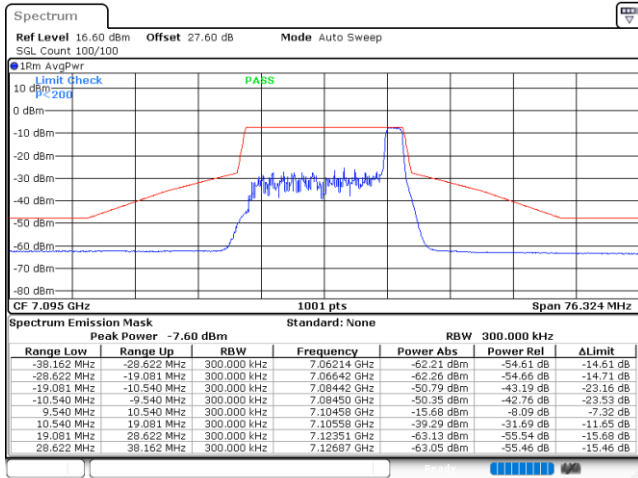

Date: 15.JAN.2022 14:05:18



EUT Mode : 802.11ax HE20 52RU

Plot on Channel 5955MHz

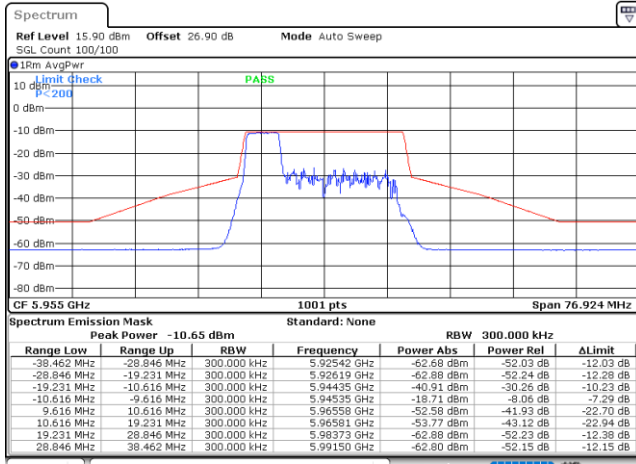

Date: 15.JAN.2022 11:02:24

Plot on Channel 6195MHz

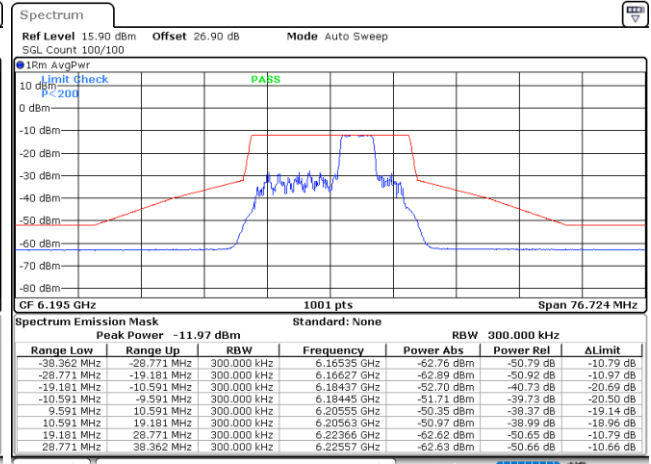

Date: 15.JAN.2022 11:15:51

Plot on Channel 6415MHz

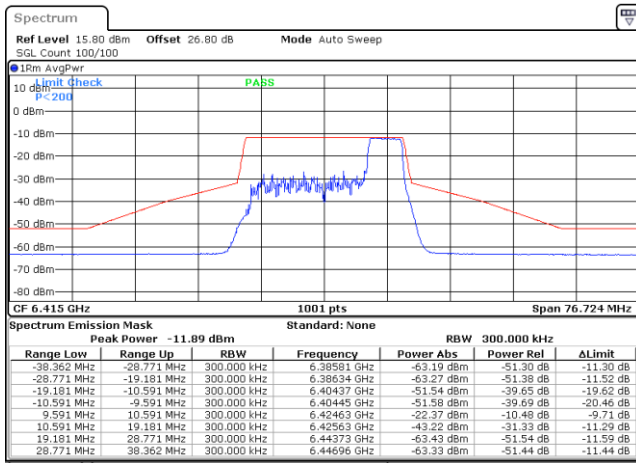

Date: 15.JAN.2022 11:24:31

Plot on Channel 6435MHz

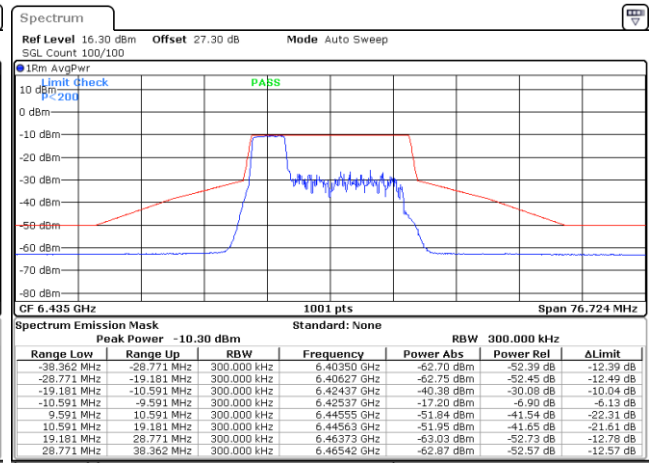

Date: 15.JAN.2022 11:31:42



Plot on Channel 6475MHz

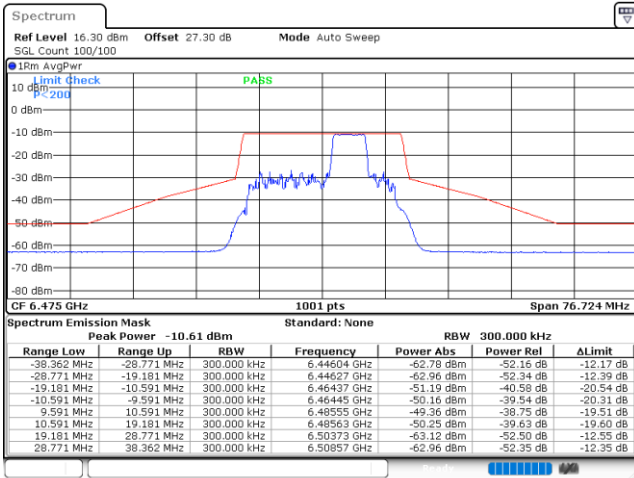

Date: 15.JAN.2022 11:44:39

Plot on Channel 6515MHz

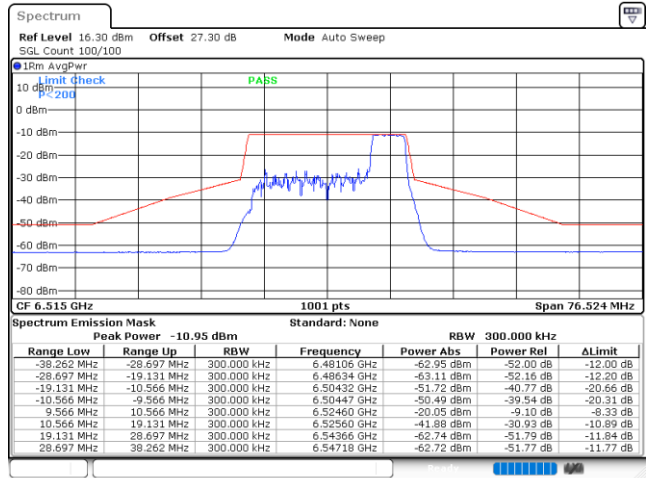

Date: 15.JAN.2022 12:48:08

Plot on Channel 6535MHz

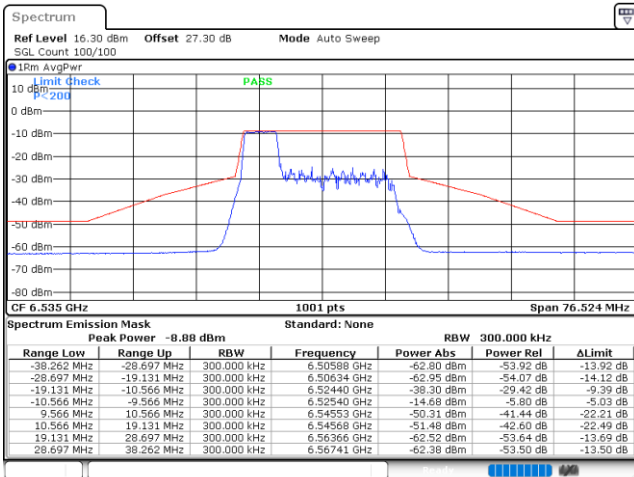

Date: 15.JAN.2022 12:59:17

Plot on Channel 6695MHz

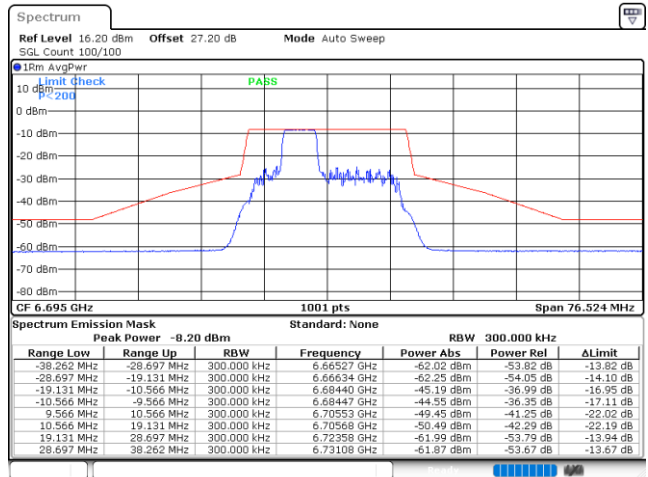

Date: 15.JAN.2022 13:06:34



Plot on Channel 6855MHz

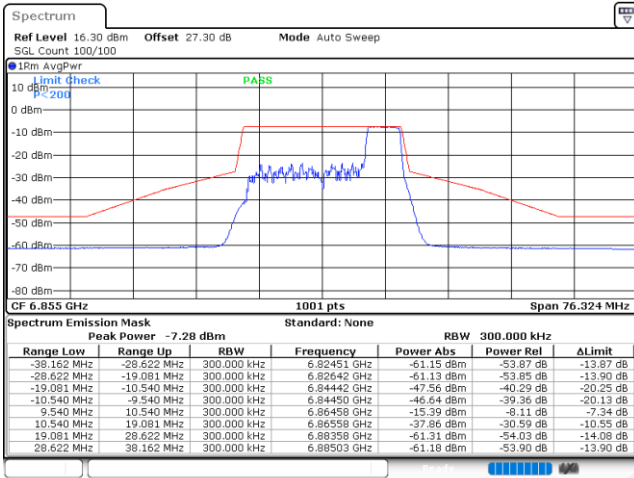

Date: 15.JAN.2022 13:17:54

Plot on Channel 6875MHz

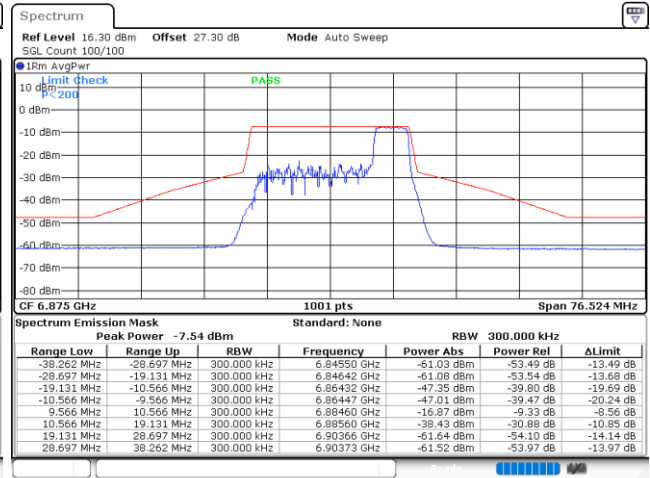

Date: 15.JAN.2022 13:31:40

Plot on Channel 6895MHz

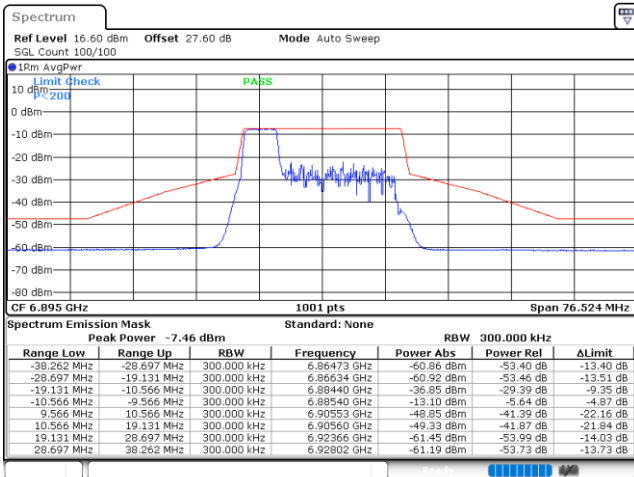

Date: 15.JAN.2022 13:39:56

Plot on Channel 6995MHz

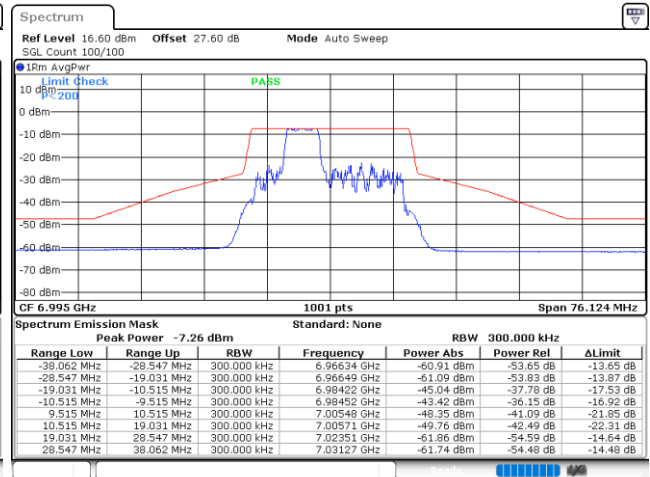

Date: 15.JAN.2022 13:52:44



Plot on Channel 7095MHz

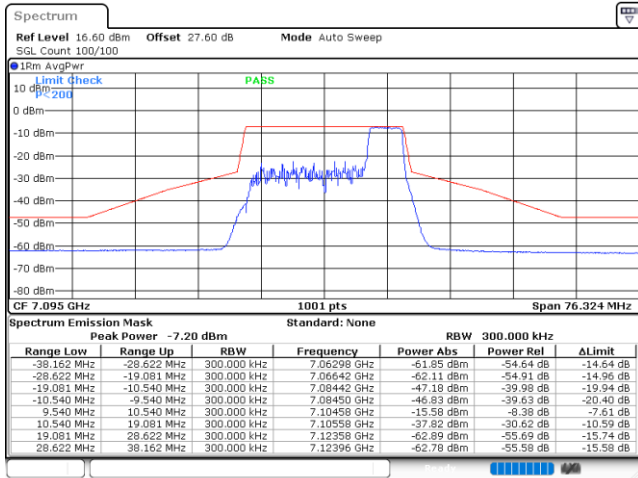

Date: 15.JAN.2022 14:08:30



EUT Mode : 802.11ax HE20 106RU

Plot on Channel 5955MHz

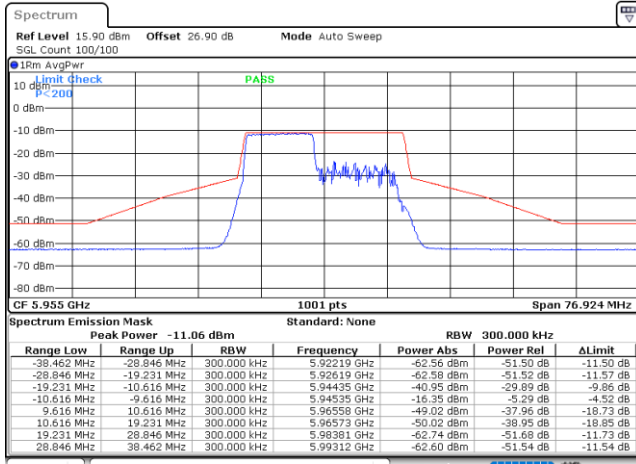

Date: 15.JAN.2022 11:03:38

Plot on Channel 6195MHz

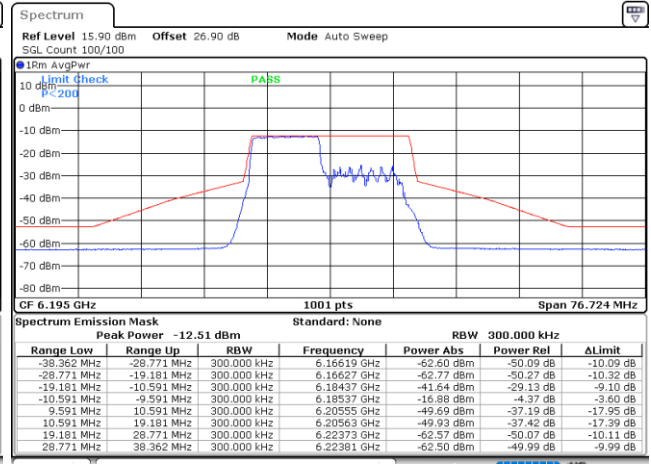

Date: 15.JAN.2022 11:18:29

Plot on Channel 6415MHz

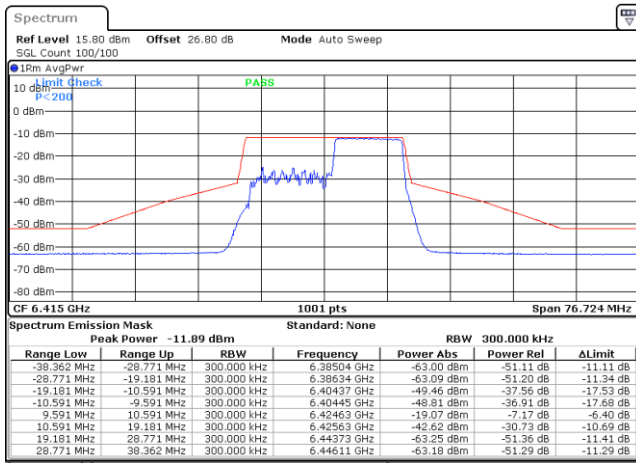

Date: 15.JAN.2022 11:26:24

Plot on Channel 6435MHz

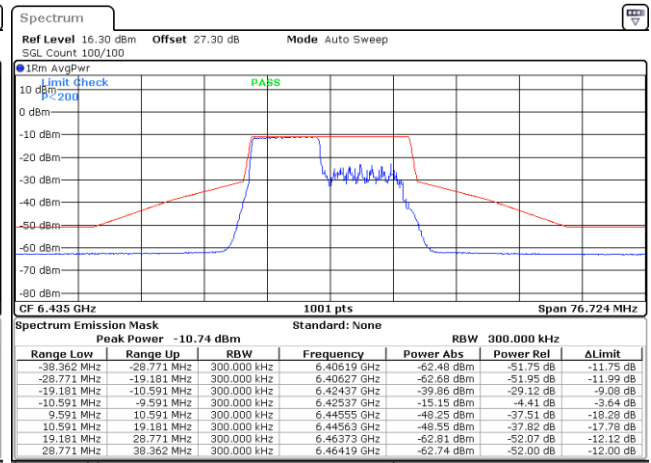

Date: 15.JAN.2022 11:34:04



Plot on Channel 6475MHz

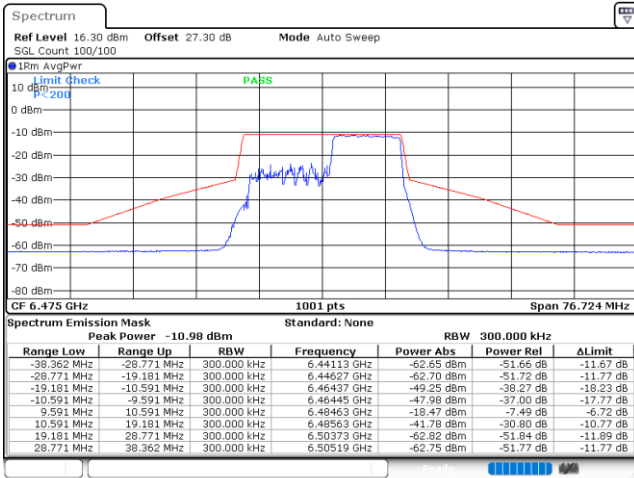

Date: 15.JAN.2022 11:47:41

Plot on Channel 6515MHz

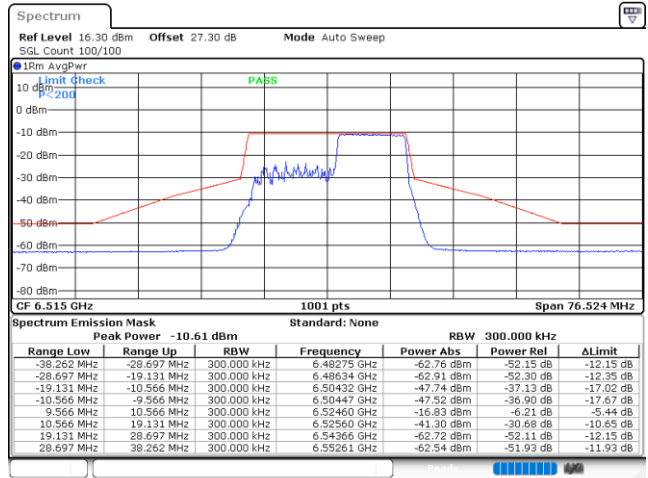

Date: 15.JAN.2022 12:51:09

Plot on Channel 6535MHz

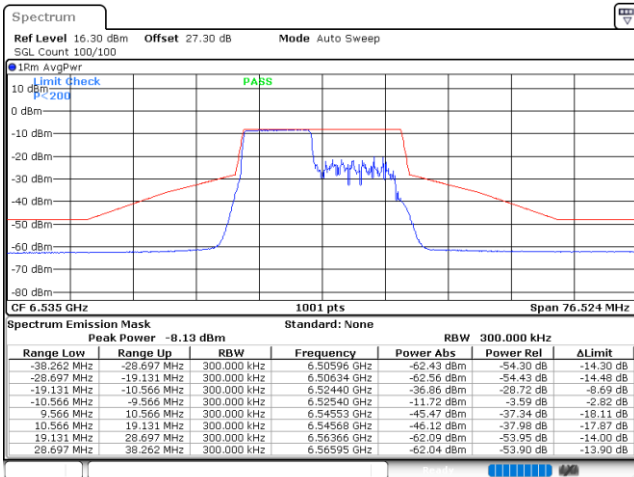

Date: 15.JAN.2022 13:01:02

Plot on Channel 6695MHz

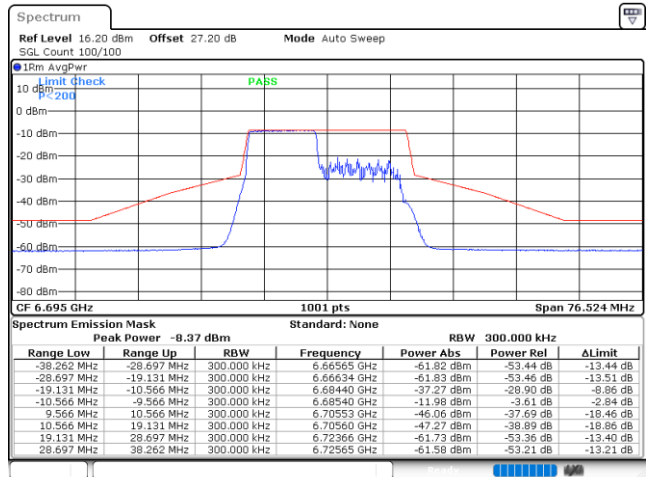

Date: 15.JAN.2022 13:11:04



Plot on Channel 6855MHz

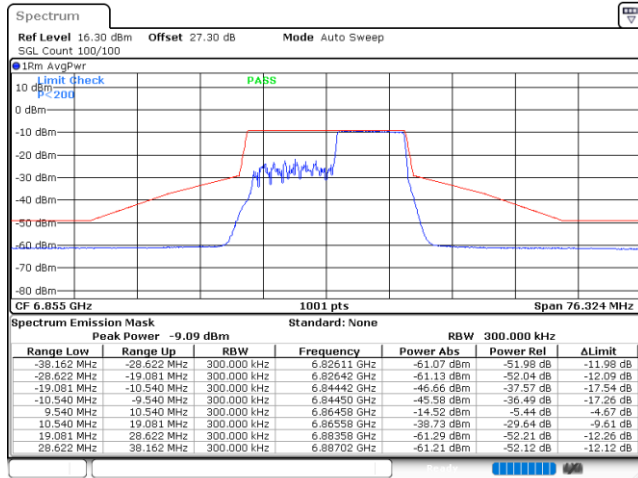

Date: 15.JAN.2022 13:20:52

Plot on Channel 6875MHz

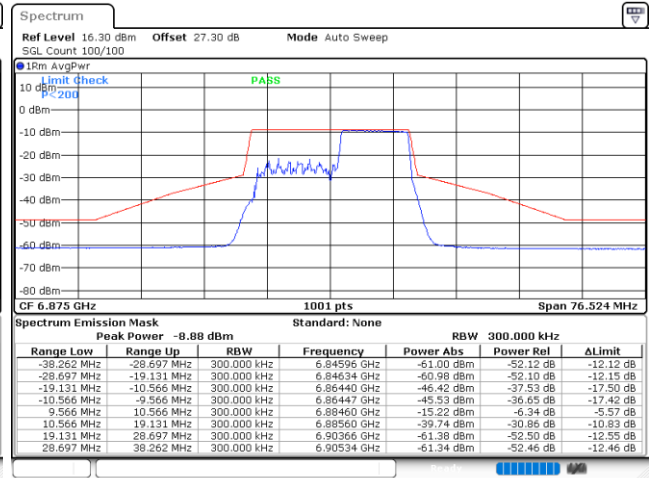

Date: 15.JAN.2022 13:32:35

Plot on Channel 6895MHz

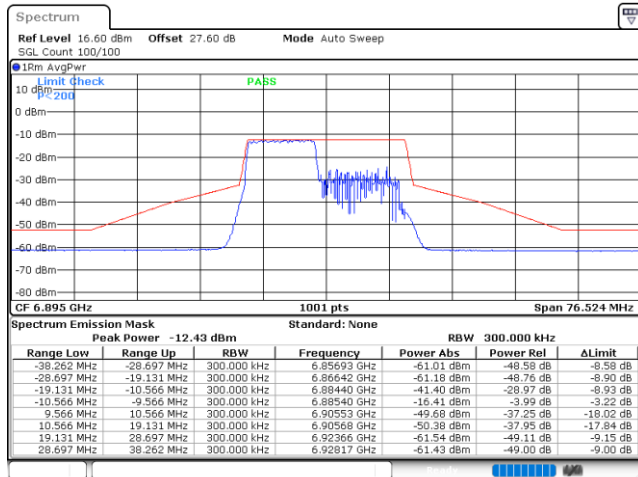

Date: 15.JAN.2022 13:44:47

Plot on Channel 6995MHz

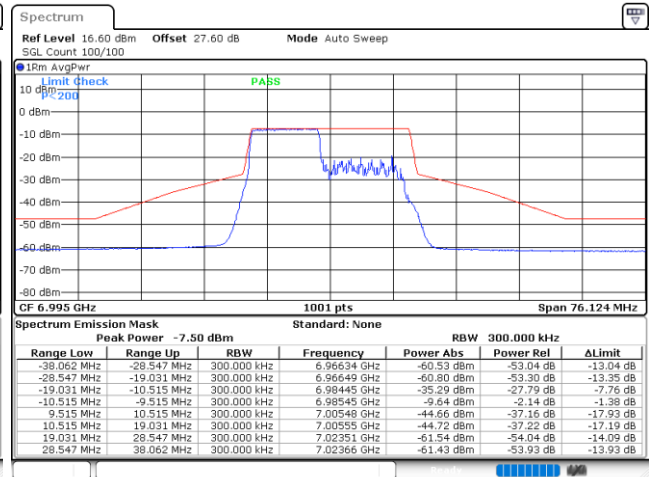

Date: 15.JAN.2022 13:54:58



Plot on Channel 7095MHz

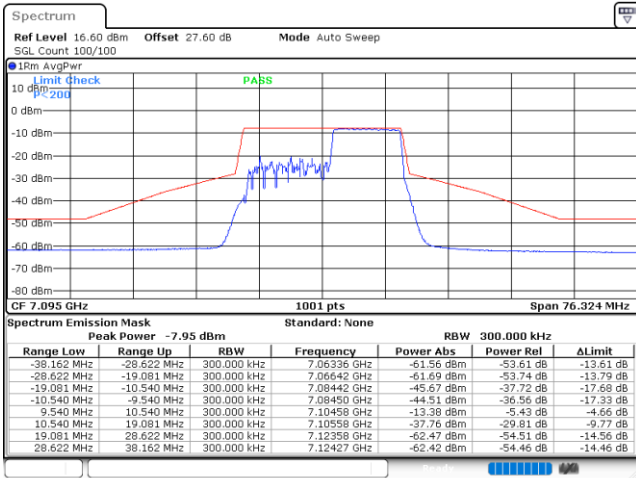

Date: 15.JAN.2022 14:10:37



EUT Mode : 802.11ax HE40

Plot on Channel 5965MHz

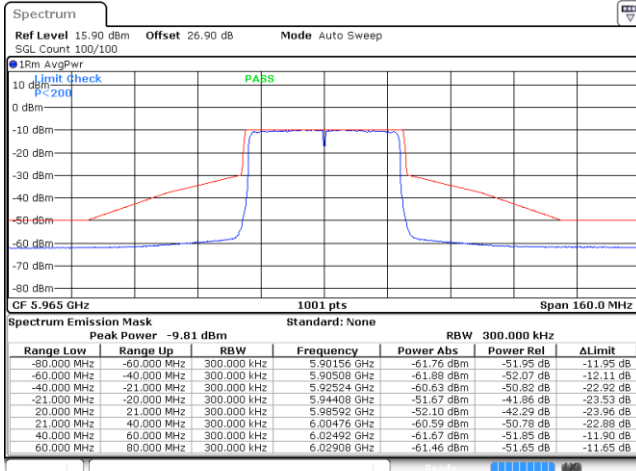

Date: 3 DEC 2021 16:51:57

Plot on Channel 6205MHz

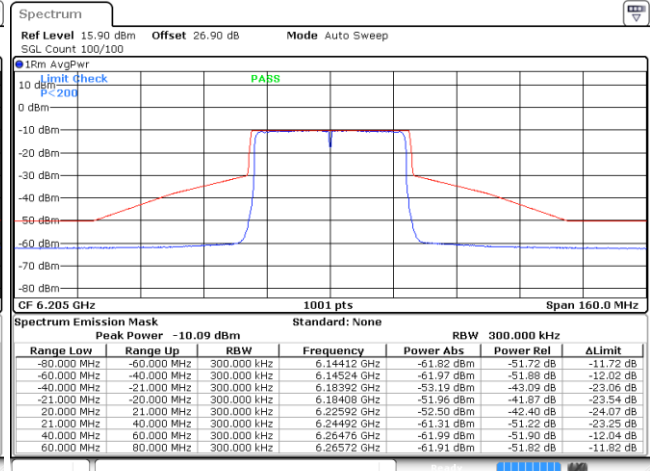

Date: 3 DEC 2021 16:56:37

Plot on Channel 6405MHz

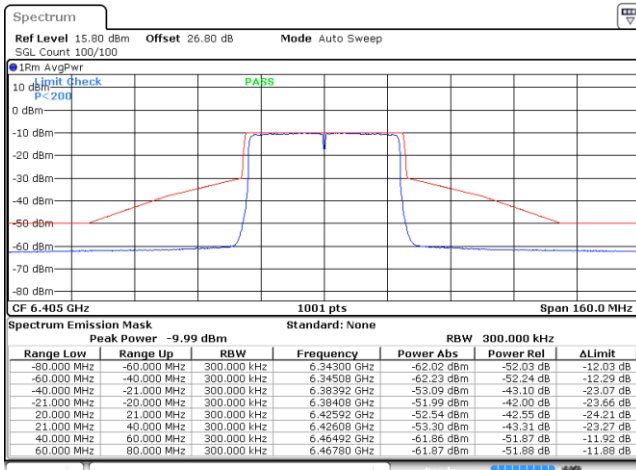

Date: 3 DEC 2021 17:03:57

Plot on Channel 6445MHz

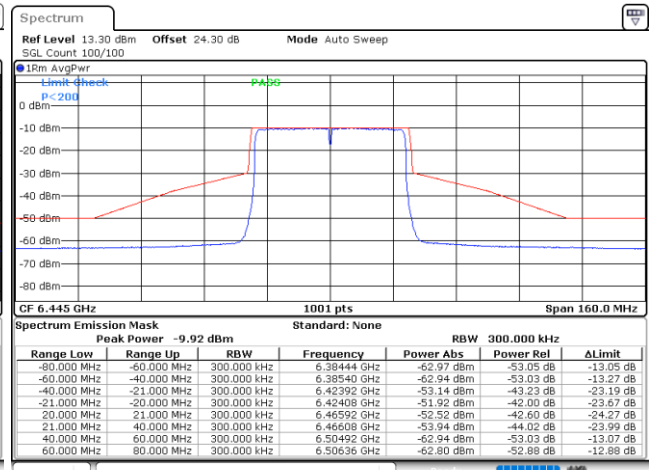

Date: 16 FEB 2022 10:48:49



Plot on Channel 6485MHz

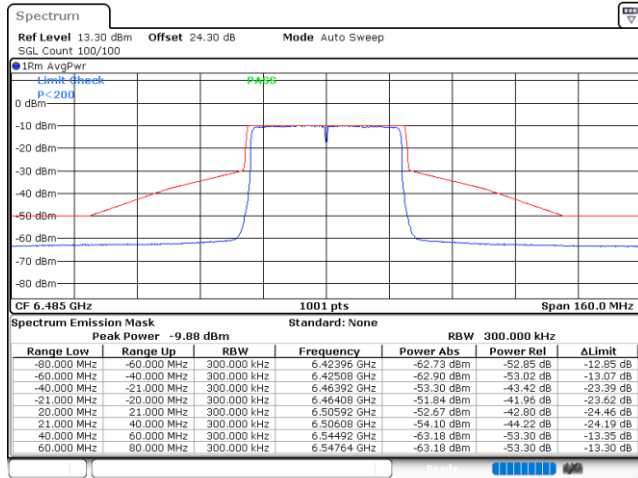

Date: 16.FEB.2022 10:51:39

Plot on Channel 6525MHz

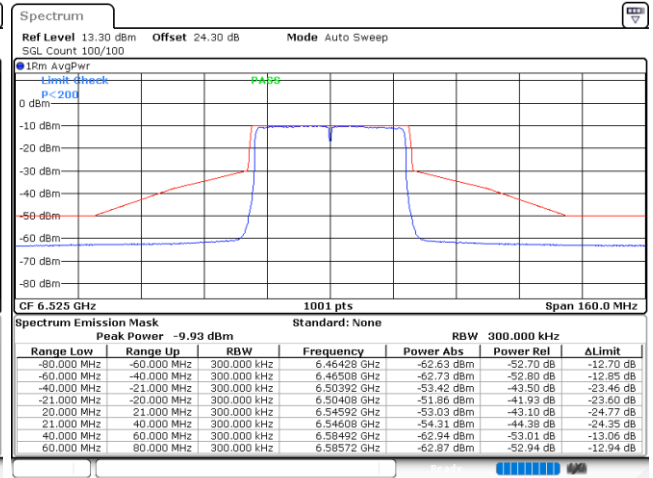

Date: 16.FEB.2022 10:52:38

Plot on Channel 6565MHz

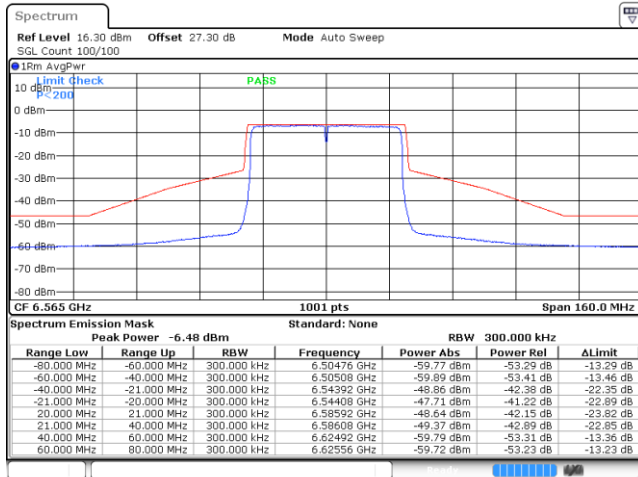

Date: 3.DEC.2021 17:33:53

Plot on Channel 6685MHz

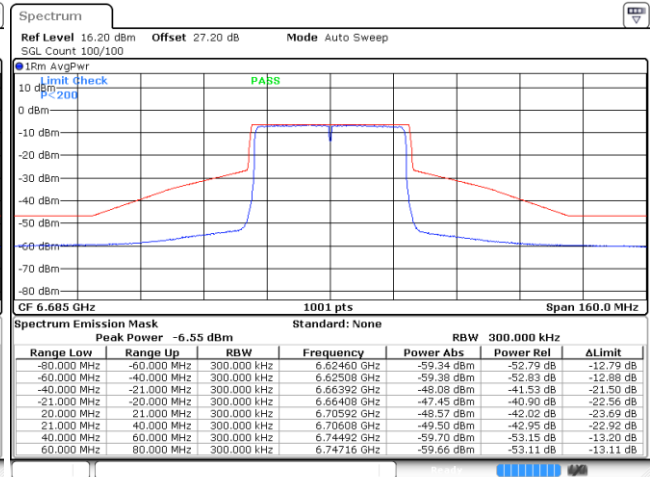

Date: 3.DEC.2021 17:42:26



Plot on Channel 6845MHz

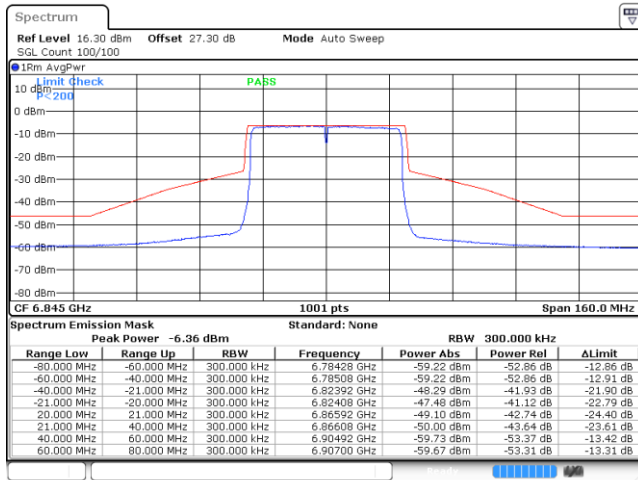

Date: 3 DEC 2021 17:47:46

Plot on Channel 6885MHz

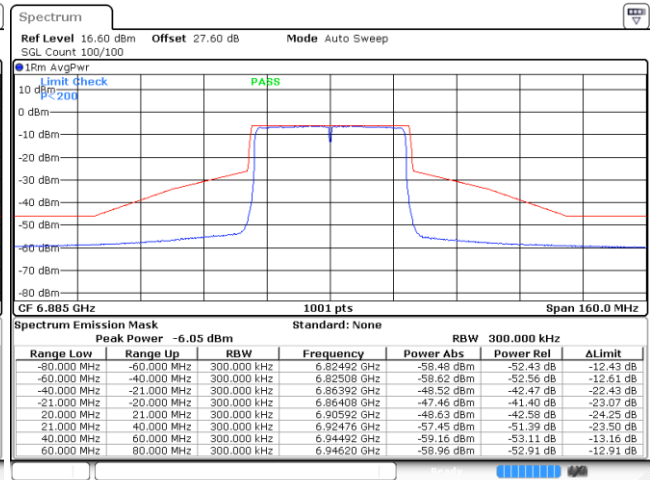

Date: 3 DEC 2021 17:54:01

Plot on Channel 6925MHz

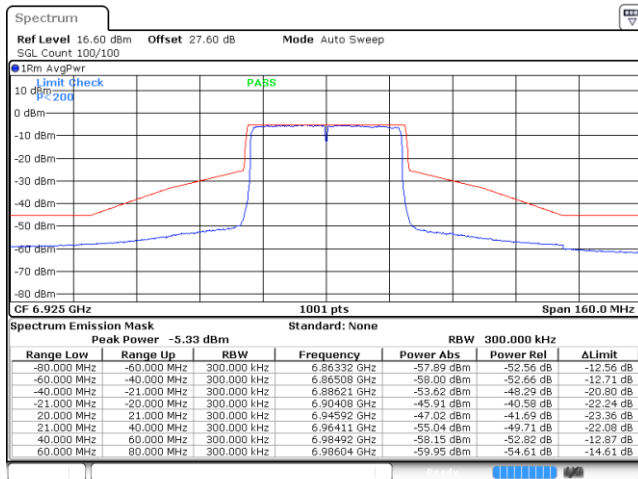

Date: 3 DEC 2021 18:00:16

Plot on Channel 7005MHz

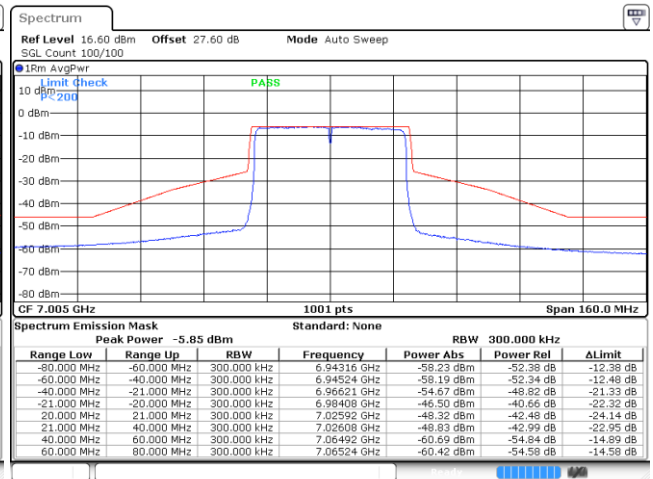

Date: 3 DEC 2021 18:06:59



Plot on Channel 7085MHz

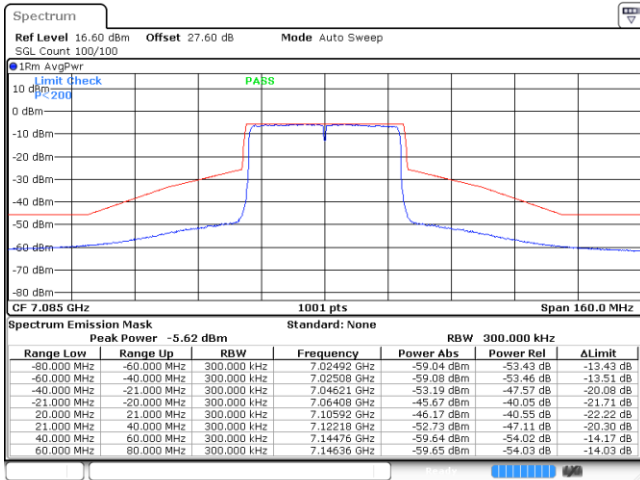

Date: 3 DEC 2021 18:13:55