



FCC RADIO TEST REPORT

FCC ID : A4RGB62Z
Equipment : Phone
Model Name : GB62Z
Applicant : Google LLC
1600 Amphitheatre Parkway,
Mountain View, California, 94043 USA
Standard : FCC 47 CFR Part 2, 22(H), 24(E), 27

The product was received on Oct. 06, 2021 and testing was performed from Oct. 08, 2021 and completed on Jan. 14, 2022. We, Sporton International Inc. EMC & Wireless Communications Laboratory, would like to declare that the tested sample has been evaluated in accordance with the test procedures given in ANSI / TIA-603-E and has been in compliance with the applicable technical standards.

The test results in this report apply exclusively to the tested model / sample. Without written approval of Sporton International Inc. EMC & Wireless Communications Laboratory, the test report shall not be reproduced except in full.

Louis Wu

Approved by: Louis Wu

Sporton International Inc. EMC & Wireless Communications Laboratory

No. 52, Huaya 1st Rd., Guishan Dist., Taoyuan City 333, Taiwan (R.O.C.)



Table of Contents

History of this test report.....	3
Summary of Test Result.....	4
1 General Description	6
1.1 Product Feature of Equipment Under Test.....	6
1.2 Product Specification of Equipment Under Test.....	7
1.3 Modification of EUT	8
1.4 Testing Location	9
1.5 Applicable Standards.....	9
2 Test Configuration of Equipment Under Test	10
2.1 Test Mode.....	10
2.2 Connection Diagram of Test System.....	13
2.3 Support Unit used in test configuration and system	13
2.4 Measurement Results Explanation Example.....	13
2.5 Frequency List of Low/Middle/High Channels	14
3 Conducted Test Items.....	17
3.1 Measuring Instruments	17
3.2 Conducted Output Power and ERP/EIRP	18
3.3 Peak-to-Average Ratio	19
3.4 Occupied Bandwidth.....	20
3.5 Conducted Band Edge	21
3.6 Conducted Spurious Emission	23
3.7 Frequency Stability	24
4 Radiated Test Items	25
4.1 Measuring Instruments	25
4.2 Radiated Spurious Emission Measurement	27
5 List of Measuring Equipment.....	28
6 Uncertainty of Evaluation.....	30
Appendix A. Test Results of Conducted Test	
Appendix B. Test Results of Radiated Test	



Summary of Test Result

Report Clause	Ref Std. Clause	Test Items	Result (PASS/FAIL)	Remark
3.2	§2.1046	Conducted Output Power	Reporting only	-
	§22.913 (a)(2)	Effective Radiated Power (n5)	Pass	
	§27.50 (c)(10)	Effective Radiated Power (n12) (n71)		
	§24.232 (c) §27.50 (h)(2)	Equivalent Isotropic Radiated Power (n2) (n25) (n7)		
	§27.50 (d)(4)	Equivalent Isotropic Radiated Power (n66)		
3.3	§24.232 (d) §27.50 (d)(5)	Peak-to-Average Ratio	Pass	-
3.4	§2.1049	Occupied Bandwidth	Reporting only	-
3.5	§2.1051 §22.917 (a) §24.238 (a) §27.53 (g) §27.53 (h)	Conducted Band Edge Measurement (n2) (n5) (n12) (n25) (n66) (n71)	Pass	-
	§2.1051 §27.53 (m)(4)	Conducted Band Edge Measurement (n7)		
3.6	§2.1051 §22.917 (a) §24.238 (a) §27.53 (g) §27.53 (h)	Conducted Spurious Emission (n2) (n5) (n12) (n25) (n66) (n71)	Pass	-
	§2.1051 §27.53 (m)(4)	Conducted Spurious Emission (n7)		
3.7	§2.1055 §22.355 §24.235 §27.54	Frequency Stability Temperature & Voltage	Pass	-



Report Clause	Ref Std. Clause	Test Items	Result (PASS/FAIL)	Remark
4.2	§2.1053 §22.917 (a) §24.238 (a) §27.53 (g) §27.53 (h)	Radiated Spurious Emission (n2) (n5) (n12) (n25) (n66) (n71)	Pass	Under limit 16.22 dB at 10107.000 MHz for Primary Antenna
	§2.1051 §27.53 (m)(4)	Radiated Spurious Emission (n7)		Under limit 16.16 dB at 10105.000 MHz for ASDIV Antenna

Declaration of Conformity:

The test results with all measurement uncertainty excluded are presented in accordance with the regulation limits or requirements declared by manufacturers.

Comments and Explanations:

The declared of product specification for EUT presented in the report are provided by the manufacturer, and the manufacturer takes all the responsibilities for the accuracy of product specification.

Reviewed by: William Chen

Report Producer: Tina Chuang



1 General Description

1.1 Product Feature of Equipment Under Test

Product Feature	
Equipment	Phone
Model Name	GB62Z
FCC ID	A4RGB62Z
EUT supports Radios application	GSM/EGPRS/WCDMA/HSPA/LTE/5G NR/NFC/GNSS WLAN 11b/g/n HT20 WLAN 11a/n HT20/HT40 WLAN 11ac VHT20/VHT40/VHT80/VHT160 WLAN 11ax HE20/HE40/HE80/HE160 Bluetooth BR/EDR/LE

Remark: The above EUT's information was declared by manufacturer.

EUT Information List	
S/N	Performed Test Item
1A261FQGR00048	Conducted Measurement
19151FQGR00025	ERP/EIRP
1B161FQGR00001	Radiated Spurious Emission



1.2 Product Specification of Equipment Under Test

Standards-related Product Specification	
Tx Frequency	5G NR n2: 1852.5 MHz ~ 1907.5 MHz 5G NR n5: 826.5 MHz ~ 846.5 MHz 5G NR n7: 2502.5 MHz ~ 2567.5 MHz 5G NR n12: 701.5 MHz ~ 713.5 MHz 5G NR n25: 1852.5 MHz ~ 1912.5 MHz 5G NR n66: 1712.5 MHz ~ 1777.5 MHz 5G NR n71: 665.5 MHz ~ 695.5 MHz
Rx Frequency	5G NR n2: 1932.5 MHz ~ 1987.5 MHz 5G NR n5: 871.5 MHz ~ 891.5 MHz 5G NR n7: 2622.5 MHz ~ 2687.5 MHz 5G NR n12: 731.5 MHz ~ 743.5 MHz 5G NR n25: 1932.5 MHz ~ 1992.5 MHz 5G NR n66: 2112.5 MHz ~ 2197.5 MHz 5G NR n71: 619.5 MHz ~ 649.5 MHz
Bandwidth	5G NR n2: 5MHz / 10MHz / 15MHz / 20MHz 5G NR n5: 5MHz / 10MHz / 15MHz / 20MHz 5G NR n7: 5MHz / 10MHz / 15MHz / 20MHz 5G NR n12: 5MHz / 10MHz / 15MHz 5G NR n25: 5MHz / 10MHz / 15MHz / 20MHz 5G NR n66: 5MHz / 10MHz / 15MHz / 20MHz / 30MHz / 40MHz 5G NR n71: 5MHz / 10MHz / 15MHz / 20MHz
Maximum Output Power to Antenna	<Primary Antenna> <Ant. 0> 5G NR n5 : 24.96 dBm 5G NR n12 : 24.98 dBm 5G NR n71 : 24.89 dBm <Ant. 2> 5G NR n2 : 25.69 dBm 5G NR n7 : 25.09 dBm 5G NR n25 : 25.69 dBm 5G NR n66 : 25.19 dBm <ASDIV Antenna> <Ant. 0> 5G NR n2 : 25.68 dBm 5G NR n7 : 24.68 dBm 5G NR n25 : 25.68 dBm 5G NR n66 : 25.68 dBm <Ant. 1> 5G NR n5 : 24.95 dBm 5G NR n12 : 24.96 dBm 5G NR n71 : 24.86 dBm
Antenna Type	<Primary Antenna> <Ant. 0> : ILA Antenna <Ant. 2> : ILA Antenna <ASDIV Antenna> <Ant. 0> : ILA Antenna <Ant. 1> : ILA Antenna
Type of Modulation	PI/2 BPSK / QPSK / 16QAM / 64QAM / 256QAM



<Primary Antenna>

Radio Tech	Band Number	Antenna name	Gain
5G NR	n2	ANT2	-0.9
5G NR	n5	ANT0	-2.9
5G NR	n7	ANT2	0.6
5G NR	n12	ANT0	-4.6
5G NR	n25	ANT2	-0.9
5G NR	n66	ANT2	-0.3
5G NR	n71	ANT0	-5.9

<ASDIV Antenna>

Radio Tech	Band Number	Antenna name	Gain
5G NR	n2	ANT0	-0.8
5G NR	n5	ANT1	-6.9
5G NR	n7	ANT0	-0.4
5G NR	n12	ANT1	-7.9
5G NR	n25	ANT0	-0.8
5G NR	n66	ANT0	-0.4
5G NR	n71	ANT1	-7.8

Remark: The above EUT's information was declared by manufacturer. Please refer to Comments and Explanations in report summary.

1.3 Modification of EUT

No modifications are made to the EUT during all test items.



1.4 Testing Location

Test Site	Sporton International Inc. EMC & Wireless Communications Laboratory
Test Site Location	No.52, Huaya 1st Rd., Guishan Dist., Taoyuan City 333, Taiwan (R.O.C.) TEL: +886-3-327-3456 FAX: +886-3-328-4978
Test Site No.	Sporton Site No.
	TH03-HY
Test Engineer	Luffy Lin
Temperature (°C)	23.4~24.6
Relative Humidity (%)	47.7~55.4

Test Site	Sporton International Inc. Wensan Laboratory
Test Site Location	No.58, Aly. 75, Ln. 564, Wenhua 3rd, Rd., Guishan Dist., Taoyuan City 333010, Taiwan (R.O.C.) TEL: +886-3-327-0868 FAX: +886-3-327-0855
Test Site No.	Sporton Site No.
	03CH12-HY (TAF Code: 3786)
Test Engineer	Jack Cheng, Lance Chiang and Chuan Chu
Temperature (°C)	22.2~26.8
Relative Humidity (%)	56.6~68.2
Remark	The Radiated Spurious Emission test item subcontracted to Sporton International Inc. Wensan Laboratory.

Note: The test site complies with ANSI C63.4 2014 requirement.

FCC Designation No.: TW1190 and TW3786

1.5 Applicable Standards

According to the specifications of the manufacturer, the EUT must comply with the requirements of the following standards:

- ♦ ANSI C63.26-2015
- ♦ ANSI / TIA-603-E
- ♦ FCC 47 CFR Part 2, 22(H), 24(E), 27
- ♦ FCC KDB 971168 D01 Power Meas. License Digital Systems v03r01
- ♦ FCC KDB 412172 D01 Determining ERP and EIRP v01r01
- ♦ FCC KDB 414788 D01 Radiated Test Site v01r01.

Remark:

1. All test items were verified and recorded according to the standards and without any deviation during the test.
2. This EUT has also been tested and complied with the requirements of FCC Part 15, Subpart B, recorded in a separate test report.
3. The TAF code is not including all the FCC KDB listed without accreditation.



2 Test Configuration of Equipment Under Test

2.1 Test Mode

Antenna port conducted and radiated test items listed below are performed according to KDB 971168 D01 Power Meas. License Digital Systems v03r01 with maximum output power.

For radiated measurement, the measured emission level of the EUT was maximized by rotating the EUT on a turntable, adjusting the orientation of the EUT and EUT antenna in three orthogonal axis (X: flat, Y: portrait, Z: landscape), and adjusting the measurement antenna orientation, following C63.26 exploratory test procedures and find **<Primary Antenna>**: X Plane with Adapter for EN-DC 2A_n12A, EN-DC 2A_n71A; Y Plane with Adapter for EN-DC 7A_n5A, EN-DC 14A_n2A; Z Plane with Adapter for EN-DC 26A_n25A, EN-DC 71A_n66A, EN-DC 28A_n7A; **<ASDIV Antenna>**: Y Plane with Adapter for EN-DC 7A_n5A, EN-DC 14A_n2A, EN-DC 26A_n25A; Z Plane with Adapter for EN-DC 2A_n12A, EN-DC 71A_n66A, EN-DC 28A_n7A and EN-DC 2A_n71A as worst plane.

Test Items	NR Band	Bandwidth (MHz)							Modulation					RB #			Test Channel		
		5	10	15	20	30	40	50	PI/2 BPSK	QPSK	16QAM	64QAM	256QAM	1	Half	Full	L	M	H
Max. Output Power	n2	v	v	v	v	-	-	-	v	v	v	v	v	v	v	v	v	v	v
	n5	v	v	v	v	-	-	-	v	v	v	v	v	v	v	v	v	v	v
	n7	v	v	v	v	-	-	-	v	v	v	v	v	v	v	v	v	v	v
	n12	v	v	v	-	-	-	-	v	v	v	v	v	v	v	v	v	v	v
	n25	v	v	v	v	-	-	-	v	v	v	v	v	v	v	v	v	v	v
	n66	v	v	v	v	v	v	-	v	v	v	v	v	v	v	v	v	v	v
	n71	v	v	v	v	-	-	-	v	v	v	v	v	v	v	v	v	v	v
Peak-to-Ave rage Ratio	n2				v	-	-	-	v	v	v	v	v			v		v	
	n5				v	-	-	-	v	v	v	v	v			v		v	
	n7				v	-	-	-	v	v	v	v	v			v		v	
	n12			v	-	-	-	-	v	v	v	v	v			v		v	
	n25				v	-	-	-	v	v	v	v	v			v		v	
	n38	-			v	-	-	-	v	v	v	v	v			v		v	
	n71				v	-	-	-	v	v	v	v	v			v		v	
26dB and 99% Bandwidth	n2	v	v	v	v	-	-	-	v	v	v	v	v			v		v	
	n5	v	v	v	v	-	-	-	v	v	v	v	v			v		v	
	n7	v	v	v	v	-	-	-	v	v	v	v	v			v		v	
	n12	v	v	v	-	-	-	-	v	v	v	v	v			v		v	
	n25	v	v	v	v	-	-	-	v	v	v	v	v			v		v	
	n66	v	v	v	v	v	v	-	v	v	v	v	v			v		v	
	n71	v	v	v	v	-	-	-	v	v	v	v	v			v		v	



Test Items	NR Band	Bandwidth (MHz)							Modulation					RB #			Test Channel		
		5	10	15	20	30	40	50	PI/2 BPSK	QPSK	16QAM	64QAM	256QAM	1	Half	Full	L	M	H
Conducted Band Edge	n2	v	v	v	v	-	-	-	v	v	v	v	v	v		v	v		v
	n5	v	v	v	v	-	-	-	v	v	v	v	v	v		v	v		v
	n7	v	v	v	v	-	-	-	v	v	v	v	v	v		v	v		v
	n12	v	v	v	-	-	-	-	v	v	v	v	v	v		v	v		v
	n25	v	v	v	v	-	-	-	v	v	v	v	v	v		v	v		v
	n66	v	v	v	v	v	v	-	v	v	v	v	v	v		v	v		v
	n71	v	v	v	v	-	-	-	v	v	v	v	v	v		v	v		v
Conducted Spurious Emission	n2	v				-	-	-		v				v			v	v	v
	n5	v				-	-	-		v				v			v	v	v
	n7	v				-	-	-		v				v			v	v	v
	n12	v			-	-	-	-		v				v			v	v	v
	n25	v				-	-	-		v				v			v	v	v
	n66	v						-		v				v			v	v	v
	n71	v				-	-	-		v				v			v	v	v
Frequency Stability	n2				v	-	-	-	v							v		v	
	n5				v	-	-	-	v							v		v	
	n7				v	-	-	-	v							v		v	
	n12			v	-	-	-	-	v							v		v	
	n25				v	-	-	-	v							v		v	
	n66				v			-	v							v		v	
	n71				v	-	-	-	v							v		v	
E.R.P / E.I.R.P	n2	v	v	v	v	-	-	-	v	v	v	v	v	Max. Power					
	n5	v	v	v	v	-	-	-	v	v	v	v	v						
	n7	v	v	v	v	-	-	-	v	v	v	v	v						
	n12	v	v	v	-	-	-	-	v	v	v	v	v						
	n25	v	v	v	v	-	-	-	v	v	v	v	v						
	n66	v	v	v	v	v	v	-	v	v	v	v	v						
	n71	v	v	v	v	-	-	-	v	v	v	v	v						



Test Items	NR Band	Bandwidth (MHz)							Modulation					RB #			Test Channel		
		5	10	15	20	30	40	50	PI/2 BPSK	QPSK	16QAM	64QAM	256QAM	1	Half	Full	L	M	H
Radiated Spurious Emission	n2	Worst Case														v	v	v	
	n5	Worst Case														v	v	v	
	n7	Worst Case														v	v	v	
	n12	Worst Case														v	v	v	
	n25	Worst Case														v	v	v	
	n66	Worst Case														v	v	v	
	n71	Worst Case														v	v	v	
Remark	<ol style="list-style-type: none"> The mark "v " means that this configuration is chosen for testing The mark "- " means that this bandwidth is not supported. The device is investigated from 30MHz to 10 times of fundamental signal for radiated spurious emission test under different RB size/offset and modulations in exploratory test. Subsequently, only the worst case emissions are reported. Test combination is EN-DC 7A-n5A, EN-DC 14A-n2A, EN-DC 26A-n25A, EN-DC 2A-n12A, EN-DC 71A-n66A, EN-DC 2A-n71A, EN-DC 28A-n7A, EN-DC 12A-n2A, EN-DC 12A-n25A For radiated measurement, pre-scanned in two modes, DFT-s OFDM and CP OFDM. The worst cases (DFT-s OFDM) were recorded in this report, the worst modes of FR1 and LTE for simultaneous transmission were verified and compliant. All the NR SA/NSA modes are evaluated conducted power to determine the worst case mode for conducted items to be reported, for RSE, the NSA mode is selected to be performed instead of SA mode based on the NR output power is similar. All the radiated test cases were performed with Adapter 1 and USB Cable 2. 																		

2.2 Connection Diagram of Test System

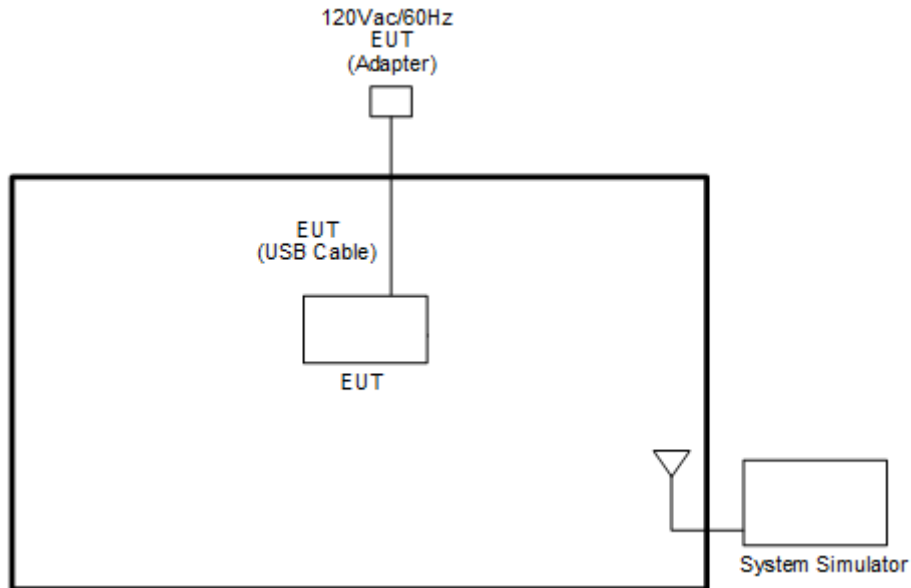

2.3 Support Unit used in test configuration and system

Item	Equipment	Trade Name	Model No.	FCC ID	Data Cable	Power Cord
1.	System Simulator	Anritsu	MT8820C	N/A	N/A	Unshielded, 1.8 m
2.	System Simulator	Anritsu	MT8821C	N/A	N/A	Unshielded, 1.8 m

2.4 Measurement Results Explanation Example

For all conducted test items:

The offset level is set in the spectrum analyzer to compensate the RF cable loss and attenuator factor between EUT conducted output port and spectrum analyzer. With the offset compensation, the spectrum analyzer reading level is exactly the EUT RF output level.

The spectrum analyzer offset is derived from RF cable loss and attenuator factor.

Offset = RF cable loss + attenuator factor.

Following shows an offset computation example with cable loss 4.2 dB and 10dB attenuator.

Example :

Offset(dB) = RF cable loss(dB) + attenuator factor(dB).

$$= 4.2 + 10 = 14.2 \text{ (dB)}$$



2.5 Frequency List of Low/Middle/High Channels

5G NR Band n2 Channel and Frequency List				
BW [MHz]	Channel/Frequency(MHz)	Lowest	Middle	Highest
20	Channel	372000	376000	380000
	Frequency	1860	1880	1900
15	Channel	371500	376000	380500
	Frequency	1857.5	1880	1902.5
10	Channel	371000	376000	381000
	Frequency	1855	1880	1905
5	Channel	370500	376000	381500
	Frequency	1852.5	1880	1907.5

5G NR Band n5 Channel and Frequency List				
BW [MHz]	Channel/Frequency(MHz)	Lowest	Middle	Highest
20	Channel	166800	167300	167800
	Frequency	834	836.5	839
15	Channel	166300	167300	168300
	Frequency	831.5	836.5	841.5
10	Channel	165800	167300	168800
	Frequency	829	836.5	844
5	Channel	165300	167300	169300
	Frequency	826.5	836.5	846.5

5G NR Band n7 Channel and Frequency List				
BW [MHz]	Channel/Frequency(MHz)	Lowest	Middle	Highest
20	Channel	502000	507000	512000
	Frequency	2510	2535	2560
15	Channel	501500	507000	512500
	Frequency	2507.5	2535	2562.5
10	Channel	501000	507000	513000
	Frequency	2505	2535	2565
5	Channel	500500	507000	513500
	Frequency	2502.5	2535	2567.5



5G NR Band n12 Channel and Frequency List				
BW [MHz]	Channel/Frequency(MHz)	Lowest	Middle	Highest
15	Channel	141300	141500	141700
	Frequency	706.5	707.5	708.5
10	Channel	140800	141500	142200
	Frequency	704	707.5	711
5	Channel	140300	141500	142700
	Frequency	701.5	707.5	713.5

5G NR Band n25 Channel and Frequency List				
BW [MHz]	Channel/Frequency(MHz)	Lowest	Middle	Highest
20	Channel	372000	376500	381000
	Frequency	1860	1882.5	1905
15	Channel	371500	376500	381500
	Frequency	1857.5	1882.5	1907.5
10	Channel	371000	376500	382000
	Frequency	1855	1882.5	1910
5	Channel	370500	376500	382500
	Frequency	1852.5	1882.5	1912.5

5G NR Band n66 Channel and Frequency List				
BW [MHz]	Channel/Frequency(MHz)	Lowest	Middle	Highest
40	Channel	346000	349000	352000
	Frequency	1730	1745	1760
30	Channel	345000	349000	353000
	Frequency	1725	1745	1765
20	Channel	344000	349000	354000
	Frequency	1720	1745	1770
15	Channel	343500	349000	354500
	Frequency	1717.5	1745	1772.5
10	Channel	343000	349000	355000
	Frequency	1715	1745	1775
5	Channel	342500	349000	355500
	Frequency	1712.5	1745	1777.5



5G NR Band n71 Channel and Frequency List				
BW [MHz]	Channel/Frequency(MHz)	Lowest	Middle	Highest
20	Channel	134600	136100	137600
	Frequency	673	680.5	688
15	Channel	134100	136100	138100
	Frequency	670.5	680.5	690.5
10	Channel	133600	136100	138600
	Frequency	668	680.5	693
5	Channel	133100	136100	139100
	Frequency	665.5	680.5	695.5

3 Conducted Test Items

3.1 Measuring Instruments

See list of measuring instruments of this test report.

3.1.1 Test Setup

3.1.2 Conducted Output Power



3.1.3 Peak-to-Average Ratio, Occupied Bandwidth ,Conducted Band-Edge and Conducted Spurious Emission

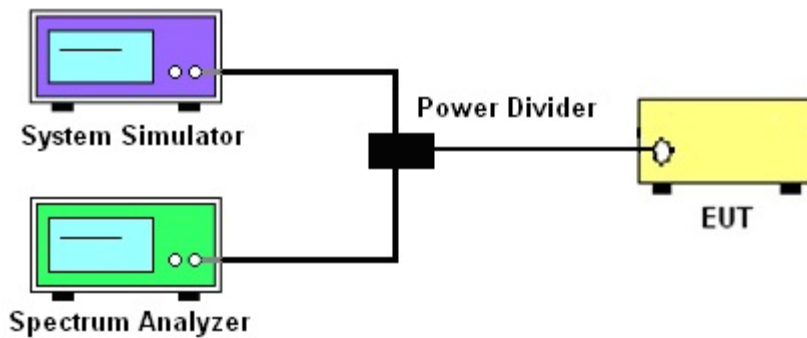

3.1.4 Frequency Stability

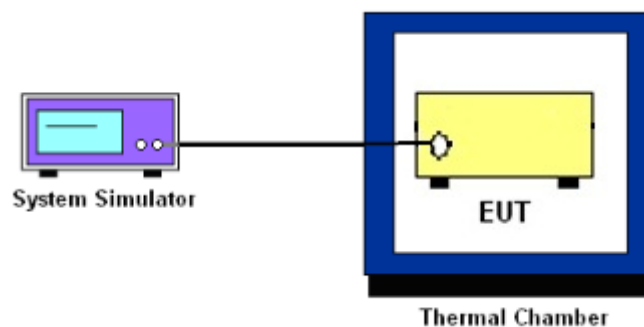

3.1.5 Test Result of Conducted Test

Please refer to Appendix A.



3.2 Conducted Output Power and ERP/EIRP

3.2.1 Description of the Conducted Output Power Measurement and ERP/EIRP Measurement

A system simulator was used to establish communication with the EUT. Its parameters were set to force the EUT transmitting at maximum output power. The measured power in the radio frequency on the transmitter output terminals shall be reported.

The ERP of mobile transmitters must not exceed 7 Watts for 5G NR n5

The ERP of mobile transmitters must not exceed 3 Watts for 5G NR n12 and n71

The EIRP of mobile transmitters must not exceed 2 Watts for 5G NR n2 and n25 and n7

The EIRP of mobile transmitters must not exceed 1 Watts for 5G NR n66

According to KDB 412172 D01 Power Approach,

$EIRP = P_T + G_T - L_C$, $ERP = EIRP - 2.15$, where

P_T = transmitter output power in dBm

G_T = gain of the transmitting antenna in dBi

L_C = signal attenuation in the connecting cable between the transmitter and antenna in dB

3.2.2 Test Procedures

1. The transmitter output port was connected to the system simulator.
2. Set EUT at maximum power through the system simulator.
3. Select lowest, middle, and highest channels for each band and different modulation.
4. Measure and record the power level from the system simulator.



3.3 Peak-to-Average Ratio

3.3.1 Description of the PAR Measurement

Power Complementary Cumulative Distribution Function (CCDF) curves provide a means for characterizing the power peaks of a digitally modulated signal on a statistical basis. A CCDF curve depicts the probability of the peak signal amplitude exceeding the average power level. Most contemporary measurement instrumentation include the capability to produce CCDF curves for an input signal provided that the instrument's resolution bandwidth can be set wide enough to accommodate the entire input signal bandwidth. In measuring transmissions in this band using an average power technique, the peak-to-average ratio (PAR) of the transmission may not exceed 13 dB.

3.3.2 Test Procedures

The testing follows ANSI C63.26-2015 Section 5.2.6

1. The EUT was connected to spectrum and system simulator via a power divider.
2. Set the CCDF (Complementary Cumulative Distribution Function) option in spectrum analyzer.
3. The highest RF powers were measured and recorded the maximum PAPR level associated with a probability of 0.1 %.
4. Record the deviation as Peak to Average Ratio.



3.4 Occupied Bandwidth

3.4.1 Description of Occupied Bandwidth Measurement

The occupied bandwidth is the width of a frequency band such that, below the lower and above the upper frequency limits, the mean powers emitted are each equal to a specified percentage 0.5% of the total mean transmitted power.

The 26 dB emission bandwidth is defined as the frequency range between two points, one above and one below the carrier frequency, at which the spectral density of the emission is attenuated 26 dB below the maximum in-band spectral density of the modulated signal. Spectral density (power per unit bandwidth) is to be measured with a detector of resolution bandwidth equal to approximately 1.0% of the emission bandwidth.

3.4.2 Test Procedures

The testing follows ANSI C63.26-2015 Section 5.4.3 (26dB) and Section 5.4.4 (99OB)

1. The EUT was connected to spectrum analyzer and system simulator via a power divider.
2. The spectrum analyzer center frequency is set to the nominal EUT channel center frequency. The span range for the spectrum analyzer shall be between two and five times the anticipated OBW.
3. The nominal resolution bandwidth (RBW) shall be in the range of 1 to 5 % of the anticipated OBW, and the VBW shall be at least 3 times the RBW.
4. Set the detection mode to peak, and the trace mode to max hold.
5. Determine the reference value: Set the EUT to transmit a modulated signal. Allow the trace to stabilize. Set the spectrum analyzer marker to the highest level of the displayed trace.
(this is the reference value)
6. Determine the “-26 dB down amplitude” as equal to (Reference Value – X).
7. Place two markers, one at the lowest and the other at the highest frequency of the envelope of the spectral display such that each marker is at or slightly below the “-X dB down amplitude” determined in step 6. If a marker is below this “-X dB down amplitude” value it shall be placed as close as possible to this value. The OBW is the positive frequency difference between the two markers.
8. Use the 99 % power bandwidth function of the spectrum analyzer and report the measured bandwidth.



3.5 Conducted Band Edge

3.5.1 Description of Conducted Band Edge Measurement

22.917(a)

For operations in the 824 – 849 MHz band, the FCC limit is $43 + 10\log_{10}(P[\text{Watts}])$ dB below the transmitter power $P(\text{Watts})$ in a 100kHz bandwidth. However, in the 1MHz bands immediately outside and adjacent to the licensee's frequency block, a resolution bandwidth of at least one percent of the emission bandwidth of the fundamental emission of the transmitter may be employed.

24.238 (a)

For operations in the 1850-1910 and 1930-1990 MHz band, the FCC limit is $43 + 10\log_{10}(P[\text{Watts}])$ dB below the transmitter power $P(\text{Watts})$ in a 1MHz bandwidth. However, in the 1 MHz bands immediately outside and adjacent to the frequency block a resolution bandwidth of at least one percent of the emission bandwidth of the fundamental emission of the transmitter may be employed.

27.53 (g)

For operations in the 600MHz band and 698-746 MHz band, the FCC limit is $43 + 10\log_{10}(P[\text{Watts}])$ dB below the transmitter power $P(\text{Watts})$ in a 100 kHz bandwidth. However, in the 100 kilohertz bands immediately outside and adjacent to a licensee's frequency block, a resolution bandwidth of at least 30 kHz may be employed.

27.53 (h)

For operations in the 1710 – 1755 MHz band, 1755-1780 MHz, the FCC limit is $43 + 10\log_{10}(P[\text{Watts}])$ dB below the transmitter power $P(\text{Watts})$ in a 1 MHz bandwidth. However, in the 1MHz bands immediately outside and adjacent to the licensee's frequency block, a resolution bandwidth of at least one percent of the emission bandwidth of the fundamental emission of the transmitter may be employed.

**27.53(m)(4)**

For mobile digital stations, the attenuation factor shall be not less than $40 + 10 \log (P)$ dB on all frequencies between the channel edge and 5 megahertz from the channel edge, $43 + 10 \log (P)$ dB on all frequencies between 5 megahertz and X megahertz from the channel edge, and $55 + 10 \log (P)$ dB on all frequencies more than X megahertz from the channel edge, where X is the greater of 6 megahertz or the actual emission bandwidth as defined in paragraph (m)(6) of this section. In addition, the attenuation factor shall not be less that $43 + 10 \log (P)$ dB on all frequencies between 2490.5 MHz and 2496 MHz and $55 + 10 \log (P)$ dB at or below 2490.5 MHz. Mobile Satellite Service licensees operating on frequencies below 2495 MHz may also submit a documented interference complaint against BRS licensees operating on channel BRS Channel 1 on the same terms and conditions as adjacent channel BRS or EBS licensees.

3.5.2 Test Procedures

The testing follows FCC KDB 971168 D01 v03r01 Section 6.1.

1. The EUT was connected to spectrum analyzer and system simulator via a power divider.
2. The band edges of low and high channels for the highest RF powers were measured.
3. Set RBW \geq 1% EBW in the 1MHz band immediately outside and adjacent to the band edge.
4. Beyond the 1 MHz band from the band edge, RBW=1MHz was used.
5. Set spectrum analyzer with RMS detector.
6. The RF fundamental frequency should be excluded against the limit line in the operating frequency band.
7. Checked that all the results comply with the emission limit line.

The limit line is derived from $43 + 10\log(P)$ dB below the transmitter power P(Watts)

For 5G NR n7

The other 40 dB, and 55 dB have additionally applied same calculation above.



3.6 Conducted Spurious Emission

3.6.1 Description of Conducted Spurious Emission Measurement

The power of any emission outside of the authorized operating frequency ranges must be lower than the transmitter power (P) by a factor of at least $43 + 10 \log (P)$ dB.

For 5G NR n7

The power of any emission outside of the authorized operating frequency ranges must be lower than the transmitter power (P) by a factor of at least $55 + 10 \log (P)$ dB.

It is measured by means of a calibrated spectrum analyzer and scanned from 30 MHz up to a frequency including its 10th harmonic.

3.6.2 Test Procedures

The testing follows FCC KDB 971168 D01 v03r01 Section 6.1.

1. The EUT was connected to spectrum analyzer and system simulator via a power divider.
2. The RF output of EUT was connected to the spectrum analyzer by RF cable and attenuator.
The path loss was compensated to the results for each measurement.
3. The middle channel for the highest RF power within the transmitting frequency was measured.
4. The conducted spurious emission for the whole frequency range was taken.
5. Make the measurement with the spectrum analyzer's RBW = 1MHz, VBW = 3MHz.
6. Set spectrum analyzer with RMS detector.
7. Taking the record of maximum spurious emission.
8. The RF fundamental frequency should be excluded against the limit line in the operating frequency band.
9. The limit line is derived from $43 + 10\log(P)$ dB below the transmitter power P(Watts)
For 5G NR n7
The limit line is derived from $55 + 10\log(P)$ dB below the transmitter power P(Watts)



3.7 Frequency Stability

3.7.1 Description of Frequency Stability Measurement

22.355

The frequency stability shall be measured by variation of ambient temperature and variation of primary supply voltage to ensure that the fundamental emission stays within the authorized frequency block. The frequency stability of the transmitter shall be maintained within $\pm 0.00025\%$ ($\pm 2.5\text{ppm}$) of the center frequency.

24.235 & 27.54

The frequency stability shall be sufficient to ensure that the fundamental emission stays within the authorized frequency block.

3.7.2 Test Procedures for Temperature Variation

The testing follows FCC KDB 971168 D01 v03r01 Section 9.0.

1. The EUT was set up in the thermal chamber and connected with the system simulator.
2. With power OFF, the temperature was decreased to -30°C and the EUT was stabilized before testing. Power was applied and the maximum change in frequency was recorded within one minute.
3. With power OFF, the temperature was raised in 10°C step up to 50°C . The EUT was stabilized at each step for at least half an hour. Power was applied and the maximum frequency change was recorded within one minute.

3.7.3 Test Procedures for Voltage Variation

The testing follows FCC KDB 971168 D01 v03r01 Section 9.0.

1. The EUT was placed in a temperature chamber at $20\pm 5^{\circ}\text{C}$ and connected with the system simulator.
2. The power supply voltage to the EUT was varied from 85% to 115% of the nominal value measured at the input to the EUT.
3. The variation in frequency was measured for the worst case.

4 Radiated Test Items

4.1 Measuring Instruments

See list of measuring instruments of this test report.

4.1.1 Test Setup

For radiated emissions below 30MHz

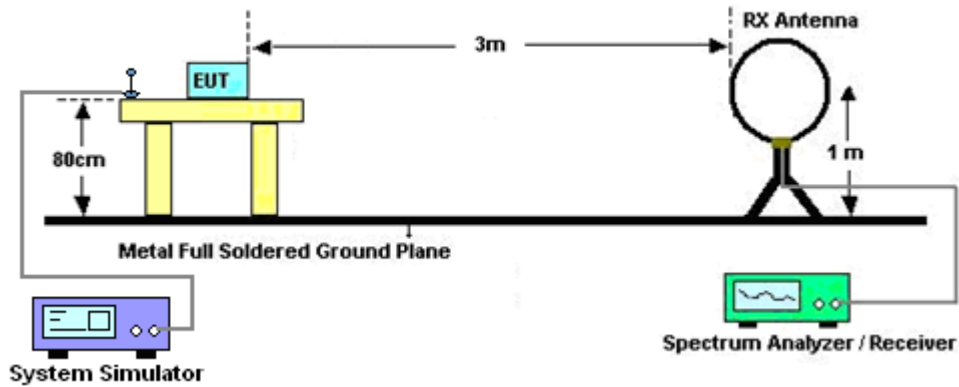

For radiated test from 30MHz to 1GHz

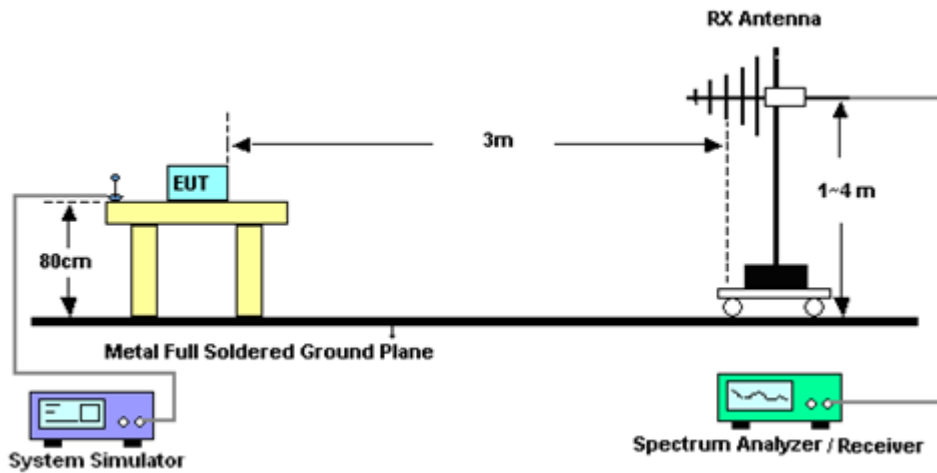

For radiated test from 1GHz to 18GHz

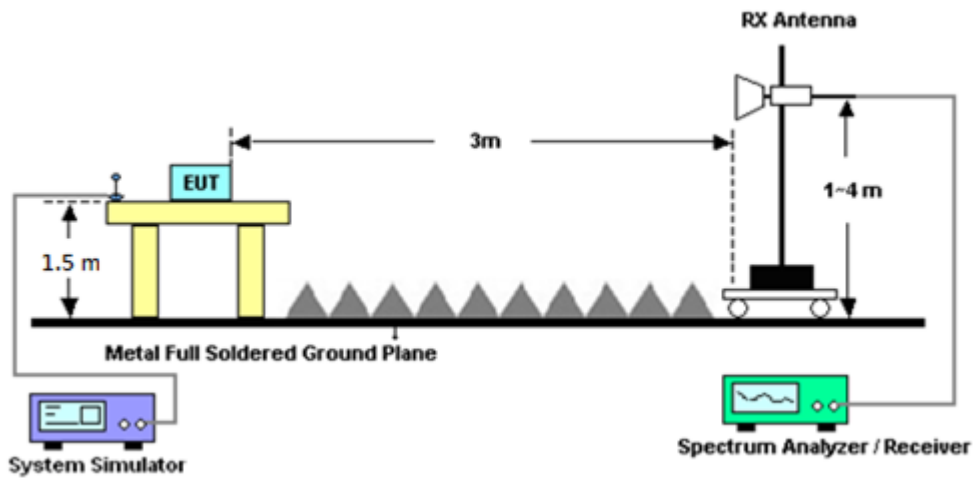

For radiated test above 18GHz

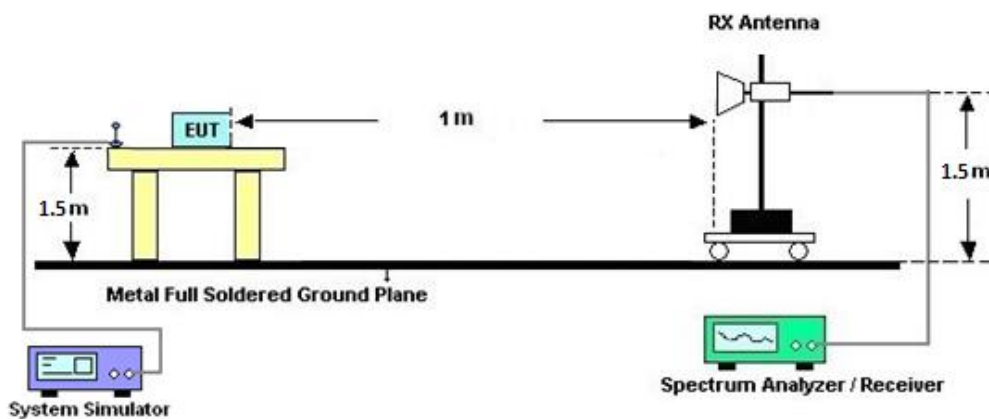

4.1.2 Test Result of Radiated Test

Please refer to Appendix B.

Note:

The low frequency, which started from 9 kHz to 30MHz, was pre-scanned and the result which was 20dB lower than the limit line was not reported.

There is adequate comparison measurement of both open-field test site and alternative test site - semi-Anechoic chamber according to 414788 D01 Radiated Test Site v01r01, and the result came out very similar.



4.2 Radiated Spurious Emission Measurement

4.2.1 Description of Radiated Spurious Emission Measurement

The radiated spurious emission was measured by substitution method according to ANSI / TIA-603-E. The power of any emission outside of the authorized operating frequency ranges must be attenuated below the transmitter power (P) by a factor of at least $43 + 10 \log (P)$ dB.

For 5G NR n7

The power of any emission outside of the authorized operating frequency ranges must be attenuated below the transmitter power (P) by a factor of at least $55 + 10 \log (P)$ dB.

The spectrum is scanned from 30 MHz up to a frequency including its 10th harmonic.

4.2.2 Test Procedures

The testing follows FCC KDB 971168 D01 v03r01 Section 7 and ANSI / TIA-603-E Section 2.2.12.

1. The EUT was placed on a turntable with 0.8 meter for frequency below 1GHz and 1.5 meter for frequency above 1GHz respectively above ground.
2. The EUT was set 3 meters from the receiving antenna, which was mounted on the antenna tower.
3. The table was rotated 360 degrees to determine the position of the highest spurious emission.
4. The height of the receiving antenna is varied between one meter and four meters to search the maximum spurious emission for both horizontal and vertical polarizations.
5. Make the measurement with the spectrum analyzer's RBW = 1MHz, VBW = 3MHz, taking the record of maximum spurious emission.
6. A horn antenna was substituted in place of the EUT and was driven by a signal generator.
7. Tune the output power of signal generator to the same emission level with EUT maximum spurious emission.
8. Taking the record of output power at antenna port.
9. Repeat step 7 to step 8 for another polarization.
10. The RF fundamental frequency should be excluded against the limit line in the operating frequency band.

The limit line is derived from $43 + 10\log(P)$ dB below the transmitter power P(Watts)

For 5G NR n7

The limit line is derived from $55 + 10\log(P)$ dB below the transmitter power P(Watts)

$EIRP \text{ (dBm)} = S.G. \text{ Power} - Tx \text{ Cable Loss} + Tx \text{ Antenna Gain}$

$ERP \text{ (dBm)} = EIRP - 2.15$



5 List of Measuring Equipment

Instrument	Brand Name	Model No.	Serial No.	Characteristics	Calibration Date	Test Date	Due Date	Remark
Loop Antenna	Rohde & Schwarz	HFH2-Z2	100315	9 kHz~30 MHz	Jan. 04, 2021	Nov. 23, 2021~ Dec. 13, 2021	Jan. 03, 2022	Radiation (03CH12-HY)
Bilog Antenna	TESEQ	CBL 6111D & 00800N1D01N -06	37059 & 01	30MHz~1GHz	Oct. 09, 2021	Nov. 23, 2021~ Dec. 13, 2021	Oct. 08, 2022	Radiation (03CH12-HY)
Bilog Antenna	TESEQ	CBL 6111D & N-6-06	35414 & AT-N0602	30MHz~1GHz	Oct. 09, 2021	Nov. 23, 2021~ Dec. 13, 2021	Oct. 08, 2022	Radiation (03CH12-HY)
Horn Antenna	SCHWARZBE CK	BBHA 9120 D	9120D-1326	1GHz~18GHz	Oct. 25, 2021	Nov. 23, 2021~ Dec. 13, 2021	Oct. 24, 2022	Radiation (03CH12-HY)
Horn Antenna	SCHWARZBE CK	BBHA 9120 D	9120D-1212	1GHz~18GHz	May 18, 2021	Nov. 23, 2021~ Dec. 13, 2021	May 17, 2022	Radiation (03CH12-HY)
SHF-EHF Horn Antenna	SCHWARZBE CK	BBHA9170	BBHA91709 80	18GHz~40GHz	Jan. 11, 2021	Nov. 23, 2021~ Dec. 13, 2021	Jan. 10, 2022	Radiation (03CH12-HY)
SHF-EHF Horn Antenna	SCHWARZBE CK	BBHA 9170	BBHA91705 76	18GHz~40GHz	May 21, 2021	Nov. 23, 2021~ Dec. 13, 2021	May 20, 2022	Radiation (03CH12-HY)
Preamplifier	COM-POWER	PA-103	161075	10MHz~1GHz	Mar. 24, 2021	Nov. 23, 2021~ Dec. 13, 2021	Mar. 23, 2022	Radiation (03CH12-HY)
Preamplifier	Aglient	8449B	3008A02375	1GHz~26.5GHz	May 25, 2021	Nov. 23, 2021~ Dec. 13, 2021	May 24, 2022	Radiation (03CH12-HY)
Preamplifier	Jet-Power	JPA0118-55-30 3K	1710001800 054002	1GHz~18GHz	Jun. 16, 2021	Nov. 23, 2021~ Dec. 13, 2021	Jun. 15, 2022	Radiation (03CH12-HY)
Preamplifier	EMEC	EM18G40G	060715	18GHz~40GHz	Dec. 11, 2020	Nov. 23, 2021~ Dec. 09, 2021	Dec. 10, 2021	Radiation (03CH12-HY)
Preamplifier	EMEC	EM18G40G	060715	18GHz~40GHz	Dec. 10, 2021	Dec. 10, 2021~ Dec. 13, 2021	Dec. 09, 2022	Radiation (03CH12-HY)
Preamplifier	EMEC	EM18G40G	060801	18GHz~40GHz	Jun. 22, 2021	Nov. 23, 2021~ Dec. 13, 2021	Jun. 21, 2022	Radiation (03CH12-HY)
Spectrum Analyzer	Agilent	N9010A	MY53470118	10Hz~44GHz	Jan. 15, 2021	Nov. 23, 2021~ Dec. 13, 2021	Jan. 14, 2022	Radiation (03CH12-HY)
RF Cable	HUBER + SUHNER	SUCOFLEX 126E	0058/126E	30MHz~18GHz	Dec. 11, 2020	Nov. 23, 2021~ Dec. 09, 2021	Dec. 10, 2021	Radiation (03CH12-HY)
RF Cable	HUBER + SUHNER	SUCOFLEX 126E	0058/126E	30MHz~18GHz	Dec. 10, 2021	Dec. 10, 2021~ Dec. 13, 2021	Dec. 09, 2022	Radiation (03CH12-HY)
RF Cable	HUBER + SUHNER	SUCOFLEX 126E	0058/126E	30MHz~18GHz	Dec. 10, 2021	Nov. 23, 2021~ Dec. 13, 2021	Dec. 09, 2022	Radiation (03CH12-HY)
RF Cable	HUBER + SUHNER	SUCOFLEX 102	505134/2	30MHz~40GHz	Feb. 22, 2021	Nov. 23, 2021~ Dec. 13, 2021	Feb. 21, 2022	Radiation (03CH12-HY)
RF Cable	HUBER + SUHNER	SUCOFLEX 102	800740/2	30MHz~40GHz	Feb. 22, 2021	Nov. 23, 2021~ Dec. 13, 2021	Feb. 21, 2022	Radiation (03CH12-HY)
Filter	Wainwright	WLKS1200-12 SS	SN2	1.2GHz Low Pass Filter	Mar. 17, 2021	Nov. 23, 2021~ Dec. 13, 2021	Mar. 16, 2022	Radiation (03CH12-HY)
Filter	Wainwright	WHKX12-1080 -1200-15000-6 0SS	SN1	1.2GHz High Pass Filter	Mar. 17, 2021	Nov. 23, 2021~ Dec. 13, 2021	Mar. 16, 2022	Radiation (03CH12-HY)
Filter	Wainwright	WHKX12-2700 -3000-18000-6 0ST	SN2	3GHz High Pass Filter	Jul. 12, 2021	Nov. 23, 2021~ Dec. 13, 2021	Jul. 11, 2022	Radiation (03CH12-HY)
Filter	Wainwright	WHKX8-5872. 5-6750-18000- 40ST	SN2	6.75GHz High Pass Filter	Mar. 17, 2021	Nov. 23, 2021~ Dec. 13, 2021	Mar. 16, 2022	Radiation (03CH12-HY)



Instrument	Brand Name	Model No.	Serial No.	Characteristics	Calibration Date	Test Date	Due Date	Remark
Hygrometer	TECPEL	DTM-303B	TP140349	N/A	Sep. 30, 2021	Nov. 23, 2021~ Dec. 13, 2021	Sep. 29, 2022	Radiation (03CH12-HY)
Controller	EMEC	EM1000	N/A	Control Turn table & Ant Mast	N/A	Nov. 23, 2021~ Dec. 13, 2021	N/A	Radiation (03CH12-HY)
Antenna Mast	EMEC	AM-BS-4500- B	N/A	1m~4m	N/A	Nov. 23, 2021~ Dec. 13, 2021	N/A	Radiation (03CH12-HY)
Turn Table	EMEC	TT2000	N/A	0~360 Degree	N/A	Nov. 23, 2021~ Dec. 13, 2021	N/A	Radiation (03CH12-HY)
Software	Audix	E3 6.2009-8-24	RK-000989	N/A	N/A	Nov. 23, 2021~ Dec. 13, 2021	N/A	Radiation (03CH12-HY)
Programmable Power Supply	GW Instek	PSS-2005	EL890001	50Hz~60Hz	Oct. 06, 2021	Oct. 08, 2021~ Jan. 14, 2022	Oct. 05, 2022	Conducted (TH03-HY)
Signal Analyzer	Rohde & Schwarz	FSV3044	101048	10Hz~44GHz	Apr. 20, 2021	Oct. 08, 2021~ Jan. 14, 2022	Apr. 19, 2022	Conducted (TH03-HY)
Temperature Chamber	ESPEC	SU-241	92003713	-30°C ~95°C	May 21, 2021	Oct. 08, 2021~ Jan. 14, 2022	May 20, 2022	Conducted (TH03-HY)
Hygrometer	Testo	608-H11	3489324	NA	Jan. 18, 2021	Oct. 08, 2021~ Jan. 14, 2022	Jan. 17, 2022	Conducted (TH03-HY)
Base Station (Measure)	Anritsu	MT8821C	6261849015	LTE	Oct. 06, 2021	Oct. 08, 2021~ Jan. 14, 2022	Oct. 05, 2022	Conducted (TH03-HY)
Base Station (Measure)	Anritsu	MT8000A	6262012917	FR1	Jan. 07, 2021	Oct. 08, 2021~ Jan. 05, 2022	Jan. 06, 2022	Conducted (TH03-HY)
Base Station (Measure)	Anritsu	MT8000A	6262134933	FR1	Apr. 27, 2021	Jan. 06, 2022~ Jan. 14, 2022	Apr. 16, 2022	Conducted (TH03-HY)



6 Uncertainty of Evaluation

Uncertainty of Radiated Emission Measurement (30 MHz ~ 1000 MHz)

Measuring Uncertainty for a Level of Confidence of 95% ($U = 2Uc(y)$)	3.10 dB
---	---------

Uncertainty of Radiated Emission Measurement (1 GHz ~ 18 GHz)

Measuring Uncertainty for a Level of Confidence of 95% ($U = 2Uc(y)$)	3.39 dB
---	---------

Uncertainty of Radiated Emission Measurement (18 GHz ~ 40 GHz)

Measuring Uncertainty for a Level of Confidence of 95% ($U = 2Uc(y)$)	4.34 dB
---	---------



Appendix A. Test Results of Conducted Test

Conducted Output Power(Average power) and ERP/EIRP

<Primary Antenna>

NR n2 Maximum Average Power [dBm] (GT - LC = -0.9 dB)								
BW [MHz]	RB Size	RB Offset	Mod	Lowest	Middle	Highest	EIRP (dBm)	EIRP(W)
5	1	1	PI/2 BPSK	25.62	25.65	25.61	24.78	0.3006
5	1	23		25.65	25.62	25.56		
5	12	6		25.67	25.63	25.55		
5	1	0		25.26	25.32	25.31		
5	1	24		25.28	25.36	25.32		
5	25	0		25.26	25.35	25.38		
5	1	1	QPSK	25.64	25.62	25.63		
5	1	23		25.68	25.65	25.62		
5	12	6		25.64	25.66	25.65		
5	1	0		24.80	24.82	24.93		
5	1	24		24.83	24.86	24.96		
5	25	0		24.79	24.85	24.92		
5	1	1	16-QAM	24.72	24.74	24.95	24.05	0.2541
5	1	1	64-QAM	23.32	23.35	23.47		
5	1	1	256-QAM	20.43	20.95	20.79		
Limit	EIRP < 2W			Result			Pass	

NR n2 Maximum Average Power [dBm] (GT - LC = -0.9 dB)								
BW [MHz]	RB Size	RB Offset	Mod	Lowest	Middle	Highest	EIRP (dBm)	EIRP(W)
10	1	1	PI/2 BPSK	25.65	25.63	25.67	24.79	0.3013
10	1	50		25.67	25.65	25.63		
10	25	12		25.66	25.66	25.68		
10	1	0		25.33	25.35	25.53		
10	1	51		25.41	25.37	25.50		
10	50	0		25.38	25.36	25.52		
10	1	1	QPSK	25.63	25.65	25.66		
10	1	50		25.64	25.63	25.69		
10	25	12		25.67	25.62	25.65		
10	1	0		24.78	24.86	25.01		
10	1	51		24.85	24.87	24.94		
10	50	0		24.81	24.89	24.93		
10	1	1	16-QAM	24.94	24.76	24.96	24.06	0.2547
10	1	1	64-QAM	23.24	23.45	23.56		
10	1	1	256-QAM	19.87	20.98	21.28		
Limit	EIRP < 2W			Result			Pass	



NR n2 Maximum Average Power [dBm] (GT - LC = -0.9 dB)										
BW [MHz]	RB Size	RB Offset	Mod	Lowest	Middle	Highest	EIRP (dBm)	EIRP(W)		
15	1	1	PI/2 BPSK	25.67	25.63	25.58	24.77	0.2999		
15	1	77		25.63	25.67	25.62				
15	36	18		25.64	25.64	25.65				
15	1	0		25.30	25.31	25.23				
15	1	78		25.37	25.42	25.24				
15	75	0		25.38	25.46	25.38				
15	1	1	QPSK	25.61	25.64	25.62			23.99	0.2506
15	1	77		25.63	25.65	25.64				
15	36	18		25.63	25.62	25.67				
15	1	0		24.77	24.85	24.83				
15	1	78		24.86	24.89	24.83				
15	75	0		24.89	24.93	24.88				
15	1	1	16-QAM	24.79	24.83	24.89	23.99	0.2506		
15	1	1	64-QAM	23.39	23.41	23.54				
15	1	1	256-QAM	19.54	20.38	20.32				
Limit	EIRP < 2W			Result			Pass			

NR n2 Maximum Average Power [dBm] (GT - LC = -0.9 dB)										
BW [MHz]	RB Size	RB Offset	Mod	Lowest	Middle	Highest	EIRP (dBm)	EIRP(W)		
20	1	1	PI/2 BPSK	25.59	25.68	25.59	24.78	0.3006		
20	1	104		25.63	25.59	25.57				
20	50	25		25.64	25.61	25.65				
20	1	0		25.18	25.22	25.25				
20	1	105		25.34	25.34	25.29				
20	100	0		25.38	25.35	25.45				
20	1	1	QPSK	25.62	25.53	25.52			23.84	0.2421
20	1	104		25.61	25.59	25.58				
20	50	25		25.65	25.62	25.67				
20	1	0		24.75	24.74	24.81				
20	1	105		24.82	24.87	24.82				
20	100	0		24.86	24.93	24.94				
20	1	1	16-QAM	24.58	24.74	24.71	23.84	0.2421		
20	1	1	64-QAM	23.27	23.32	23.34				
20	1	1	256-QAM	19.18	20.76	20.53				
Limit	EIRP < 2W			Result			Pass			



NR n5 Maximum Average Power [dBm] (GT - LC = -2.9 dB)										
BW [MHz]	RB Size	RB Offset	Mod	Lowest	Middle	Highest	ERP (dBm)	ERP(W)		
5	1	1	PI/2 BPSK	24.88	24.90	24.75	19.91	0.0979		
5	1	23		24.86	24.93	24.73				
5	12	6		24.81	24.89	24.76				
5	1	0		24.33	24.36	24.24				
5	1	24		24.35	24.40	24.26				
5	25	0		24.39	24.41	24.29				
5	1	1	QPSK	24.82	24.96	24.73			18.93	0.0782
5	1	23		24.76	24.92	24.67				
5	12	6		24.90	24.89	24.81				
5	1	0		23.88	23.91	23.80				
5	1	24		23.85	23.95	23.73				
5	25	0		23.79	23.92	23.81				
5	1	1	16-QAM	23.84	23.98	23.77	18.93	0.0782		
5	1	1	64-QAM	22.46	22.64	22.49				
5	1	1	256-QAM	20.36	20.48	20.90				
Limit	ERP < 7W			Result			Pass			

NR n5 Maximum Average Power [dBm] (GT - LC = -2.9 dB)										
BW [MHz]	RB Size	RB Offset	Mod	Lowest	Middle	Highest	ERP (dBm)	ERP(W)		
10	1	1	PI/2 BPSK	24.88	24.89	24.86	19.84	0.0964		
10	1	50		24.79	24.83	24.85				
10	25	12		24.29	24.32	24.29				
10	1	0		24.25	24.30	24.28				
10	1	51		24.36	24.34	24.39				
10	50	0		24.29	24.33	24.29				
10	1	1	QPSK	24.86	24.85	24.89			18.82	0.0762
10	1	50		24.79	24.87	24.79				
10	25	12		23.88	23.86	23.76				
10	1	0		23.76	23.88	23.85				
10	1	51		23.98	23.95	23.99				
10	50	0		23.96	23.92	23.95				
10	1	1	16-QAM	23.86	23.76	23.87	18.82	0.0762		
10	1	1	64-QAM	22.35	22.46	22.53				
10	1	1	256-QAM	20.28	20.38	20.44				
Limit	ERP < 7W			Result			Pass			



NR n5 Maximum Average Power [dBm] (GT - LC = -2.9 dB)										
BW [MHz]	RB Size	RB Offset	Mod	Lowest	Middle	Highest	ERP (dBm)	ERP(W)		
15	1	1	PI/2 BPSK	24.73	24.79	24.85	19.80	0.0955		
15	1	77		24.69	24.74	24.74				
15	36	18		24.79	24.84	24.75				
15	1	0		24.16	24.28	24.33				
15	1	78		24.11	24.22	24.22				
15	75	0		24.28	24.36	24.26				
15	1	1	QPSK	24.79	24.74	24.72			18.77	0.0753
15	1	77		24.66	24.79	24.83				
15	36	18		24.81	24.83	23.81				
15	1	0		23.89	23.83	23.79				
15	1	78		23.79	23.76	23.82				
15	75	0		23.84	23.90	23.95				
15	1	1	16-QAM	23.79	23.82	23.75	18.77	0.0753		
15	1	1	64-QAM	22.40	22.15	22.39				
15	1	1	256-QAM	20.29	20.19	20.35				
Limit	ERP < 7W			Result			Pass			

NR n5 Maximum Average Power [dBm] (GT - LC = -2.9 dB)										
BW [MHz]	RB Size	RB Offset	Mod	Lowest	Middle	Highest	ERP (dBm)	ERP(W)		
20	1	1	PI/2 BPSK	24.62	24.74	24.68	19.83	0.0962		
20	1	104		24.65	24.78	24.82				
20	50	25		24.83	24.86	24.88				
20	1	0		24.22	24.24	24.33				
20	1	105		24.26	24.24	24.32				
20	100	0		23.33	24.31	24.36				
20	1	1	QPSK	24.62	24.82	24.66			18.80	0.0759
20	1	104		24.55	24.75	24.85				
20	50	25		24.86	24.84	24.79				
20	1	0		23.69	23.72	23.79				
20	1	105		23.72	23.78	23.85				
20	100	0		23.79	23.84	23.75				
20	1	1	16-QAM	23.72	23.80	23.85	18.80	0.0759		
20	1	1	64-QAM	22.32	22.38	22.44				
20	1	1	256-QAM	20.19	20.23	20.38				
Limit	ERP < 7W			Result			Pass			



NR n7 Maximum Average Power [dBm] (GT - LC = 0.6 dB)								
BW [MHz]	RB Size	RB Offset	Mod	Lowest	Middle	Highest	EIRP (dBm)	EIRP(W)
5	1	1	PI/2 BPSK	25.03	24.95	24.72	25.69	0.3707
5	1	23		24.99	24.86	24.71		
5	12	6		25.01	24.88	24.81		
5	1	0		24.54	24.40	24.24		
5	1	24		24.49	24.45	24.20		
5	25	0		24.52	24.43	24.22		
5	1	1	QPSK	25.09	24.94	24.70		
5	1	23		25.02	24.81	24.78		
5	12	6		24.99	24.83	24.78		
5	1	0		24.04	23.98	23.74		
5	1	24		24.06	23.96	23.81		
5	25	0		24.05	23.89	23.79		
5	1	1	16-QAM	24.08	23.96	23.81	24.68	0.2938
5	1	1	64-QAM	22.59	22.35	22.38		
5	1	1	256-QAM	20.45	20.29	20.32		
Limit	EIRP < 2W			Result			Pass	

NR n7 Maximum Average Power [dBm] (GT - LC = 0.6 dB)								
BW [MHz]	RB Size	RB Offset	Mod	Lowest	Middle	Highest	EIRP (dBm)	EIRP(W)
10	1	1	PI/2 BPSK	24.96	24.92	24.76	25.56	0.3597
10	1	50		24.90	24.91	24.71		
10	25	12		24.87	24.92	24.72		
10	1	0		24.38	24.53	24.23		
10	1	51		24.41	24.48	24.19		
10	50	0		24.39	24.37	24.21		
10	1	1	QPSK	24.96	24.91	24.78		
10	1	50		24.93	24.89	24.73		
10	25	12		24.89	24.87	24.74		
10	1	0		23.88	23.89	23.74		
10	1	51		23.93	23.92	23.72		
10	50	0		23.86	23.91	23.69		
10	1	1	16-QAM	24.02	23.89	23.84	24.62	0.2897
10	1	1	64-QAM	22.48	22.41	22.39		
10	1	1	256-QAM	20.27	20.39	20.22		
Limit	EIRP < 2W			Result			Pass	



NR n7 Maximum Average Power [dBm] (GT - LC = 0.6 dB)								
BW [MHz]	RB Size	RB Offset	Mod	Lowest	Middle	Highest	EIRP (dBm)	EIRP(W)
15	1	1	PI/2 BPSK	24.86	24.84	24.87	25.58	0.3614
15	1	77		24.88	24.81	24.79		
15	36	18		24.91	24.84	24.86		
15	1	0		24.37	24.41	24.37		
15	1	78		24.39	24.38	24.28		
15	75	0		24.42	24.48	24.41		
15	1	1	QPSK	24.96	24.81	24.82		
15	1	77		24.98	24.80	24.82		
15	36	18		24.96	24.90	24.86		
15	1	0		24.02	23.84	23.88		
15	1	78		23.99	23.82	23.87		
15	75	0		22.98	23.87	23.89		
15	1	1	16-QAM	24.02	23.90	23.85	24.62	0.2897
15	1	1	64-QAM	22.53	22.50	22.32		
15	1	1	256-QAM	20.15	20.29	20.31		
Limit	EIRP < 2W			Result			Pass	

NR n7 Maximum Average Power [dBm] (GT - LC = 0.6 dB)								
BW [MHz]	RB Size	RB Offset	Mod	Lowest	Middle	Highest	EIRP (dBm)	EIRP(W)
20	1	1	PI/2 BPSK	24.95	24.79	24.75	25.59	0.3622
20	1	104		24.90	24.78	24.65		
20	50	25		24.99	24.87	24.76		
20	1	0		24.42	24.33	24.22		
20	1	105		24.43	24.27	24.16		
20	100	0		24.52	24.28	24.32		
20	1	1	QPSK	24.88	24.81	24.75		
20	1	104		24.97	24.78	24.64		
20	50	25		24.96	24.84	24.78		
20	1	0		23.97	23.86	23.75		
20	1	105		23.94	23.84	23.71		
20	100	0		24.01	23.85	23.75		
20	1	1	16-QAM	23.75	23.76	23.97	24.57	0.2864
20	1	1	64-QAM	22.39	22.48	22.45		
20	1	1	256-QAM	19.85	20.35	20.12		
Limit	EIRP < 2W			Result			Pass	



NR n12 Maximum Average Power [dBm] (GT - LC = -4.6 dB)										
BW [MHz]	RB Size	RB Offset	Mod	Lowest	Middle	Highest	ERP (dBm)	ERP(W)		
5	1	1	PI/2 BPSK	24.82	24.98	24.73	18.23	0.0665		
5	1	23		24.86	24.97	24.78				
5	12	6		24.83	24.92	24.76				
5	1	0		24.29	24.44	24.28				
5	1	24		24.30	24.51	24.23				
5	25	0		24.35	24.49	24.28				
5	1	1	QPSK	24.86	24.83	24.79			17.27	0.0533
5	1	23		24.81	24.93	24.76				
5	12	6		24.86	24.88	24.79				
5	1	0		23.79	23.93	23.79				
5	1	24		23.83	23.95	23.74				
5	25	0		23.84	23.88	23.78				
5	1	1	16-QAM	24.02	23.84	23.62	17.27	0.0533		
5	1	1	64-QAM	22.65	22.48	22.45				
5	1	1	256-QAM	20.45	20.32	20.38				
Limit	ERP < 3W			Result			Pass			

NR n12 Maximum Average Power [dBm] (GT - LC = -4.6 dB)										
BW [MHz]	RB Size	RB Offset	Mod	Lowest	Middle	Highest	ERP (dBm)	ERP(W)		
10	1	1	PI/2 BPSK	24.70	24.71	24.69	18.08	0.0643		
10	1	50		24.74	24.81	24.77				
10	25	12		24.72	24.77	24.83				
10	1	0		24.16	24.22	24.06				
10	1	51		24.23	24.32	24.03				
10	50	0		24.16	24.28	24.16				
10	1	1	QPSK	24.65	24.76	24.83			17.21	0.0526
10	1	50		24.69	24.75	24.63				
10	25	12		24.72	24.76	24.83				
10	1	0		23.68	23.75	23.69				
10	1	51		23.77	23.82	23.79				
10	50	0		23.69	23.78	23.72				
10	1	1	16-QAM	23.89	23.96	23.85	17.21	0.0526		
10	1	1	64-QAM	22.34	22.46	22.53				
10	1	1	256-QAM	20.19	20.21	20.33				
Limit	ERP < 3W			Result			Pass			



NR n12 Maximum Average Power [dBm] (GT - LC = -4.6 dB)								
BW [MHz]	RB Size	RB Offset	Mod	Lowest	Middle	Highest	ERP (dBm)	ERP(W)
15	1	1	PI/2 BPSK	24.65	24.72	24.61	18.03	0.0635
15	1	77		24.77	24.78	24.74		
15	36	18		24.73	24.77	24.73		
15	1	0		24.16	24.15	24.11		
15	1	78		24.22	24.26	24.19		
15	75	0		24.26	24.26	24.27		
15	1	1	QPSK	24.68	24.65	24.57	17.10	0.0513
15	1	77		24.73	24.75	24.74		
15	36	18		24.75	24.71	24.72		
15	1	0		23.63	23.69	23.62		
15	1	78		23.76	23.77	23.74		
15	75	0		23.74	23.73	23.84		
15	1	1	16-QAM	23.85	23.65	23.45	17.10	0.0513
15	1	1	64-QAM	22.31	22.29	22.15		
15	1	1	256-QAM	20.21	20.13	20.16		
Limit	ERP < 3W			Result			Pass	



NR n25 Maximum Average Power [dBm] (GT - LC = -0.9 dB)								
BW [MHz]	RB Size	RB Offset	Mod	Lowest	Middle	Highest	EIRP (dBm)	EIRP(W)
5	1	1	PI/2 BPSK	25.56	25.63	25.60	24.77	0.2999
5	1	23		25.61	25.67	25.55		
5	12	6		25.60	25.65	25.60		
5	1	0		25.25	25.34	25.32		
5	1	24		25.43	25.36	25.27		
5	25	0		25.32	25.35	25.29		
5	1	1	QPSK	25.54	25.64	25.66		
5	1	23		25.63	25.67	25.62		
5	12	6		25.60	25.62	25.60		
5	1	0		24.78	24.86	24.86		
5	1	24		24.82	24.92	24.83		
5	25	0		24.83	24.85	24.84		
5	1	1	16-QAM	24.65	24.88	24.76	23.98	0.2500
5	1	1	64-QAM	23.35	23.46	23.57		
5	1	1	256-QAM	20.86	21.28	21.21		
Limit	EIRP < 2W			Result			Pass	

NR n25 Maximum Average Power [dBm] (GT - LC = -0.9 dB)								
BW [MHz]	RB Size	RB Offset	Mod	Lowest	Middle	Highest	EIRP (dBm)	EIRP(W)
10	1	1	PI/2 BPSK	25.51	25.66	25.65	24.79	0.3013
10	1	50		25.67	25.64	25.63		
10	25	12		25.52	25.65	25.67		
10	1	0		25.28	25.38	25.45		
10	1	51		25.46	25.43	25.46		
10	50	0		25.39	25.43	25.51		
10	1	1	QPSK	25.56	25.60	25.69		
10	1	50		25.65	25.65	25.66		
10	25	12		25.61	25.62	25.67		
10	1	0		24.85	24.87	24.97		
10	1	51		24.94	24.93	24.94		
10	50	0		24.98	24.94	24.98		
10	1	1	16-QAM	24.95	24.76	24.95	24.05	0.2541
10	1	1	64-QAM	23.46	23.51	23.65		
10	1	1	256-QAM	20.94	21.25	21.32		
Limit	EIRP < 2W			Result			Pass	



NR n25 Maximum Average Power [dBm] (GT - LC = -0.9 dB)								
BW [MHz]	RB Size	RB Offset	Mod	Lowest	Middle	Highest	EIRP (dBm)	EIRP(W)
15	1	1	PI/2 BPSK	25.62	25.63	25.68	24.78	0.3006
15	1	77		25.65	25.61	25.49		
15	36	18		25.68	25.65	25.67		
15	1	0		25.33	25.32	25.48		
15	1	78		25.39	25.42	25.38		
15	75	0		25.42	25.42	25.51		
15	1	1	QPSK	25.65	25.59	25.67		
15	1	77		25.68	25.61	25.60		
15	36	18		25.64	25.65	25.68		
15	1	0		24.84	24.85	24.95		
15	1	78		24.91	24.95	24.89		
15	75	0		24.94	24.93	25.02		
15	1	1	16-QAM	24.87	24.79	24.83	23.97	0.2495
15	1	1	64-QAM	23.47	23.45	23.63		
15	1	1	256-QAM	20.11	21.26	21.06		
Limit	EIRP < 2W			Result			Pass	

NR n25 Maximum Average Power [dBm] (GT - LC = -0.9 dB)								
BW [MHz]	RB Size	RB Offset	Mod	Lowest	Middle	Highest	EIRP (dBm)	EIRP(W)
20	1	1	PI/2 BPSK	25.59	25.68	25.64	24.78	0.3006
20	1	104		25.63	25.65	25.63		
20	50	25		25.68	25.64	25.65		
20	1	0		25.19	25.26	25.37		
20	1	105		25.34	25.38	25.33		
20	100	0		25.37	25.41	25.49		
20	1	1	QPSK	25.54	25.58	25.61		
20	1	104		25.65	25.63	25.66		
20	50	25		25.65	25.62	25.68		
20	1	0		24.74	24.68	24.85		
20	1	105		24.84	24.78	24.89		
20	100	0		24.86	24.98	25.05		
20	1	1	16-QAM	24.71	24.78	24.82	23.92	0.2466
20	1	1	64-QAM	23.36	23.11	23.48		
20	1	1	256-QAM	20.17	20.98	21.08		
Limit	EIRP < 2W			Result			Pass	



NR n66 Maximum Average Power [dBm] (GT - LC = -0.3 dB)										
BW [MHz]	RB Size	RB Offset	Mod	Lowest	Middle	Highest	EIRP (dBm)	EIRP(W)		
5	1	1	PI/2 BPSK	25.11	25.03	24.88	24.84	0.3048		
5	1	23		25.12	25.01	24.78				
5	12	6		25.11	25.04	24.79				
5	1	0		24.63	24.54	24.41				
5	1	24		24.61	24.54	24.47				
5	25	0		24.61	24.53	24.44				
5	1	1	QPSK	25.13	25.05	24.86			24.84	0.3048
5	1	23		25.14	25.04	24.92				
5	12	6		25.11	25.03	22.86				
5	1	0		24.17	24.06	23.88				
5	1	24		24.15	24.05	23.94				
5	25	0		24.12	24.04	23.89				
5	1	1	16-QAM	24.22	24.06	23.88	23.92	0.2466		
5	1	1	64-QAM	22.69	22.52	22.51				
5	1	1	256-QAM	20.55	20.42	20.28				
Limit	EIRP < 1W			Result			Pass			

NR n66 Maximum Average Power [dBm] (GT - LC = -0.3 dB)										
BW [MHz]	RB Size	RB Offset	Mod	Lowest	Middle	Highest	EIRP (dBm)	EIRP(W)		
10	1	1	PI/2 BPSK	25.16	24.97	25.01	24.89	0.3083		
10	1	50		25.17	24.93	25.05				
10	25	12		25.19	25.01	25.07				
10	1	0		24.73	24.52	24.54				
10	1	51		24.63	24.48	24.53				
10	50	0		24.66	24.51	24.52				
10	1	1	QPSK	25.17	24.93	25.07			24.89	0.3083
10	1	50		25.15	25.01	25.06				
10	25	12		25.11	25.04	25.01				
10	1	0		24.25	24.03	23.94				
10	1	51		24.26	24.01	24.00				
10	50	0		24.24	24.03	23.96				
10	1	1	16-QAM	24.12	24.01	23.97	23.82	0.2410		
10	1	1	64-QAM	22.79	22.56	22.52				
10	1	1	256-QAM	20.52	20.48	20.29				
Limit	EIRP < 1W			Result			Pass			



NR n66 Maximum Average Power [dBm] (GT - LC = -0.3 dB)										
BW [MHz]	RB Size	RB Offset	Mod	Lowest	Middle	Highest	EIRP (dBm)	EIRP(W)		
15	1	1	PI/2 BPSK	25.08	24.97	24.77	24.87	0.3069		
15	1	77		25.15	24.92	24.84				
15	36	18		25.16	24.94	24.88				
15	1	0		24.60	24.41	24.31				
15	1	78		24.60	24.39	24.37				
15	75	0		24.69	24.47	24.42				
15	1	1	QPSK	25.02	24.94	24.77			23.73	0.2360
15	1	77		25.12	24.90	24.87				
15	36	18		25.17	24.99	24.88				
15	1	0		24.06	23.96	23.83				
15	1	78		24.15	23.91	23.90				
15	75	0		24.17	23.96	23.90				
15	1	1	16-QAM	23.97	24.03	23.88	23.73	0.2360		
15	1	1	64-QAM	22.75	22.59	22.48				
15	1	1	256-QAM	20.53	20.34	20.19				
Limit	EIRP < 1W			Result			Pass			

NR n66 Maximum Average Power [dBm] (GT - LC = -0.3 dB)										
BW [MHz]	RB Size	RB Offset	Mod	Lowest	Middle	Highest	EIRP (dBm)	EIRP(W)		
20	1	1	PI/2 BPSK	25.03	24.93	24.89	24.88	0.3076		
20	1	104		24.91	24.89	24.96				
20	50	25		24.92	25.02	25.18				
20	1	0		24.36	24.45	24.50				
20	1	105		24.39	24.42	24.49				
20	100	0		24.56	24.51	24.56				
20	1	1	QPSK	24.83	24.91	25.03			23.68	0.2333
20	1	104		24.82	24.87	24.94				
20	50	25		25.16	25.00	24.88				
20	1	0		23.89	23.92	24.05				
20	1	105		23.93	23.88	23.91				
20	100	0		24.02	23.99	24.02				
20	1	1	16-QAM	23.98	23.96	23.89	23.68	0.2333		
20	1	1	64-QAM	22.66	22.42	22.56				
20	1	1	256-QAM	20.34	20.36	20.22				
Limit	EIRP < 1W			Result			Pass			



NR n66 Maximum Average Power [dBm] (GT - LC = -0.3 dB)								
BW [MHz]	RB Size	RB Offset	Mod	Lowest	Middle	Highest	EIRP (dBm)	EIRP(W)
30	1	1	PI/2 BPSK	24.82	24.71	24.80	24.69	0.2944
30	1	158		24.66	24.70	24.63		
30	80	40		24.99	24.93	24.89		
30	1	0		24.27	24.23	24.36		
30	1	159		24.30	24.21	24.31		
30	160	0		24.43	24.37	24.29		
30	1	1	QPSK	24.76	24.71	24.68	23.42	0.2198
30	1	158		24.68	24.75	24.66		
30	80	40		24.89	24.94	24.83		
30	1	0		23.76	23.74	24.86		
30	1	159		23.79	23.74	23.66		
30	160	0		23.94	23.85	23.93		
30	1	1	16-QAM	23.52	23.63	23.72	23.42	0.2198
30	1	1	64-QAM	22.43	22.32	22.29		
30	1	1	256-QAM	20.08	20.02	19.99		
Limit	EIRP < 1W			Result			Pass	



NR n66 Maximum Average Power [dBm] (GT - LC = -0.3 dB)										
BW [MHz]	RB Size	RB Offset	Mod	Lowest	Middle	Highest	EIRP (dBm)	EIRP(W)		
40	1	1	PI/2 BPSK	24.45	24.53	24.48	24.67	0.2931		
40	1	214		24.51	24.58	24.51				
40	108	54		24.83	24.97	24.89				
40	1	0		24.12	24.05	23.98				
40	1	215		24.13	24.09	24.02				
40	216	0		23.68	23.75	23.76				
40	1	1	QPSK	24.45	24.42	24.36			23.11	0.2046
40	1	214		24.39	24.49	24.45				
40	108	54		24.78	24.89	24.86				
40	1	0		23.39	23.46	23.51				
40	1	215		23.51	23.53	23.48				
40	216	0		23.63	23.76	23.83				
40	1	1	16-QAM	23.41	23.35	23.31	23.11	0.2046		
40	1	1	64-QAM	22.07	22.11	22.08				
40	1	1	256-QAM	19.88	19.85	19.75				
Limit	EIRP < 1W			Result			Pass			



NR n71 Maximum Average Power [dBm] (GT - LC = -5.9 dB)								
BW [MHz]	RB Size	RB Offset	Mod	Lowest	Middle	Highest	ERP (dBm)	ERP(W)
5	1	1	PI/2 BPSK	24.55	24.63	24.65	16.72	0.047
5	1	23		24.56	24.61	24.62		
5	12	6		24.51	24.56	24.65		
5	1	0		24.01	24.09	24.02		
5	1	24		23.98	24.01	24.15		
5	25	0		24.08	24.06	24.14		
5	1	1	QPSK	24.57	24.77	24.72		
5	1	23		24.58	24.62	24.65		
5	12	6		24.44	24.55	24.62		
5	1	0		23.58	23.56	23.68		
5	1	24		23.58	23.62	23.63		
5	25	0		23.49	23.56	24.67		
5	1	1	16-QAM	23.52	23.57	23.64	15.59	0.0362
5	1	1	64-QAM	22.32	22.38	22.35		
5	1	1	256-QAM	20.12	20.08	20.12		
Limit	ERP < 3W			Result			Pass	

NR n71 Maximum Average Power [dBm] (GT - LC = -5.9 dB)								
BW [MHz]	RB Size	RB Offset	Mod	Lowest	Middle	Highest	ERP (dBm)	ERP(W)
10	1	1	PI/2 BPSK	24.56	24.57	24.50	16.57	0.0454
10	1	50		24.54	24.62	24.59		
10	25	12		24.42	24.58	24.52		
10	1	0		23.99	23.98	23.92		
10	1	51		24.04	24.11	24.09		
10	50	0		24.03	24.07	24.12		
10	1	1	QPSK	24.57	24.42	24.49		
10	1	50		24.49	24.52	24.44		
10	25	12		24.53	24.56	24.52		
10	1	0		23.52	23.53	23.55		
10	1	51		23.56	23.64	23.65		
10	50	0		23.55	23.58	23.51		
10	1	1	16-QAM	23.58	23.51	23.48	15.53	0.0357
10	1	1	64-QAM	22.26	22.12	22.06		
10	1	1	256-QAM	20.26	20.19	20.06		
Limit	ERP < 3W			Result			Pass	



NR n71 Maximum Average Power [dBm] (GT - LC = -5.9 dB)								
BW [MHz]	RB Size	RB Offset	Mod	Lowest	Middle	Highest	ERP (dBm)	ERP(W)
15	1	1	PI/2 BPSK	24.38	24.47	24.44	16.51	0.0448
15	1	77		24.52	24.56	24.54		
15	36	18		24.39	24.45	24.46		
15	1	0		23.93	23.88	23.86		
15	1	78		24.01	24.04	24.13		
15	75	0		23.98	24.01	24.06		
15	1	1	QPSK	24.41	24.51	24.38		
15	1	77		24.52	24.49	24.39		
15	36	18		24.52	24.53	24.48		
15	1	0		23.33	23.38	23.41		
15	1	78		23.46	23.50	23.48		
15	75	0		23.52	23.56	23.46		
15	1	1	16-QAM	23.36	23.46	23.36	15.41	0.0347
15	1	1	64-QAM	21.92	22.15	22.12		
15	1	1	256-QAM	19.88	19.86	19.86		
Limit	ERP < 3W			Result			Pass	

NR n71 Maximum Average Power [dBm] (GT - LC = -5.9 dB)								
BW [MHz]	RB Size	RB Offset	Mod	Lowest	Middle	Highest	ERP (dBm)	ERP(W)
20	1	1	PI/2 BPSK	24.86	24.89	24.53	16.84	0.0483
20	1	104		24.46	24.68	24.49		
20	50	25		24.51	24.63	24.51		
20	1	0		23.82	23.95	23.82		
20	1	105		23.94	24.29	24.01		
20	100	0		23.95	24.16	24.01		
20	1	1	QPSK	24.45	24.37	24.37		
20	1	104		24.46	24.57	24.59		
20	50	25		24.50	24.65	24.57		
20	1	0		23.35	24.42	23.36		
20	1	105		23.50	23.61	23.58		
20	100	0		23.49	23.61	23.57		
20	1	1	16-QAM	23.62	23.32	23.32	15.57	0.0361
20	1	1	64-QAM	22.06	21.95	21.98		
20	1	1	256-QAM	20.02	19.92	19.86		
Limit	ERP < 3W			Result			Pass	



<ASDIV Antenna>

NR n2 Maximum Average Power [dBm] (GT - LC = -0.8 dB)								
BW [MHz]	RB Size	RB Offset	Mod	Lowest	Middle	Highest	EIRP (dBm)	EIRP(W)
5	1	1	PI/2 BPSK	25.52	25.55	25.66	24.86	0.3062
5	1	23		25.57	25.62	25.65		
5	12	6		25.54	25.58	25.62		
5	1	0		25.06	25.25	25.41		
5	1	24		25.08	25.32	25.39		
5	25	0		25.06	25.28	25.40		
5	1	1	QPSK	25.54	25.58	25.56		
5	1	23		25.58	25.64	25.62		
5	12	6		25.54	25.59	25.65		
5	1	0		24.52	24.76	24.84		
5	1	24		24.55	24.85	24.91		
5	25	0		24.51	24.76	24.92		
5	1	1	16-QAM	24.43	24.85	24.95	24.15	0.2600
5	1	1	64-QAM	23.24	23.34	23.41		
5	1	1	256-QAM	20.98	21.03	21.23		
Limit	EIRP < 2W			Result			Pass	

NR n2 Maximum Average Power [dBm] (GT - LC = -0.8 dB)								
BW [MHz]	RB Size	RB Offset	Mod	Lowest	Middle	Highest	EIRP (dBm)	EIRP(W)
10	1	1	PI/2 BPSK	25.56	25.43	25.63	24.86	0.3062
10	1	50		25.52	25.51	25.62		
10	25	12		25.56	25.56	25.64		
10	1	0		25.18	25.19	25.43		
10	1	51		25.32	25.28	25.44		
10	50	0		25.16	25.26	25.43		
10	1	1	QPSK	25.65	25.62	25.66		
10	1	50		25.64	25.65	25.58		
10	25	12		25.66	25.62	25.63		
10	1	0		24.68	24.65	24.35		
10	1	51		24.77	24.77	24.72		
10	50	0		24.79	24.72	24.68		
10	1	1	16-QAM	24.56	24.83	24.88	24.08	0.2559
10	1	1	64-QAM	23.07	23.13	23.54		
10	1	1	256-QAM	20.93	21.04	21.02		
Limit	EIRP < 2W			Result			Pass	



NR n2 Maximum Average Power [dBm] (GT - LC = -0.8 dB)								
BW [MHz]	RB Size	RB Offset	Mod	Lowest	Middle	Highest	EIRP (dBm)	EIRP(W)
15	1	1	PI/2 BPSK	25.55	25.65	25.62	24.88	0.3076
15	1	77		25.65	25.62	25.68		
15	36	18		25.59	25.64	25.57		
15	1	0		25.11	25.15	25.06		
15	1	78		25.38	25.42	25.32		
15	75	0		25.11	25.26	25.16		
15	1	1	QPSK	25.53	25.51	25.61		
15	1	77		25.59	25.67	25.66		
15	36	18		25.65	25.63	25.65		
15	1	0		24.54	24.68	24.63		
15	1	78		24.62	24.87	24.79		
15	75	0		24.61	24.68	24.58		
15	1	1	16-QAM	24.75	24.77	24.68	23.97	0.2495
15	1	1	64-QAM	22.98	22.99	22.95		
15	1	1	256-QAM	21.03	21.13	21.08		
Limit	EIRP < 2W			Result			Pass	

NR n2 Maximum Average Power [dBm] (GT - LC = -0.8 dB)								
BW [MHz]	RB Size	RB Offset	Mod	Lowest	Middle	Highest	EIRP (dBm)	EIRP(W)
20	1	1	PI/2 BPSK	25.48	25.51	25.42	24.86	0.3062
20	1	104		25.66	25.62	25.66		
20	50	25		25.58	25.59	25.65		
20	1	0		25.01	25.05	25.11		
20	1	105		25.26	25.28	25.12		
20	100	0		25.33	25.24	25.17		
20	1	1	QPSK	25.43	25.51	25.42		
20	1	104		25.58	25.61	25.57		
20	50	25		25.59	25.58	25.51		
20	1	0		24.48	24.51	24.46		
20	1	105		24.52	24.68	24.65		
20	100	0		24.66	24.76	24.65		
20	1	1	16-QAM	24.32	24.34	24.32	23.54	0.2259
20	1	1	64-QAM	22.70	23.01	22.95		
20	1	1	256-QAM	20.95	21.02	20.96		
Limit	EIRP < 2W			Result			Pass	



NR n5 Maximum Average Power [dBm] (GT - LC = -6.9 dB)										
BW [MHz]	RB Size	RB Offset	Mod	Lowest	Middle	Highest	ERP (dBm)	ERP(W)		
5	1	1	PI/2 BPSK	24.92	24.95	24.94	15.90	0.0389		
5	1	23		24.88	24.92	24.88				
5	12	6		24.89	24.93	24.93				
5	1	0		24.53	24.56	24.56				
5	1	24		24.60	24.54	24.61				
5	25	0		24.57	24.52	24.60				
5	1	1	QPSK	24.92	24.95	24.94			15.38	0.0345
5	1	23		24.91	24.91	24.91				
5	12	6		24.88	24.88	24.94				
5	1	0		24.59	24.59	24.60				
5	1	24		24.59	24.64	24.63				
5	25	0		24.53	24.60	24.56				
5	1	1	16-QAM	24.38	24.40	24.43	15.38	0.0345		
5	1	1	64-QAM	22.86	22.90	22.85				
5	1	1	256-QAM	20.36	20.37	20.41				
Limit	ERP < 7W			Result			Pass			

NR n5 Maximum Average Power [dBm] (GT - LC = -6.9 dB)										
BW [MHz]	RB Size	RB Offset	Mod	Lowest	Middle	Highest	ERP (dBm)	ERP(W)		
10	1	1	PI/2 BPSK	24.88	24.91	24.92	15.88	0.0387		
10	1	50		24.86	24.88	24.84				
10	25	12		24.83	24.93	24.89				
10	1	0		24.49	24.45	24.54				
10	1	51		24.50	24.52	24.56				
10	50	0		24.48	24.51	24.52				
10	1	1	QPSK	24.86	24.87	24.84			15.34	0.0342
10	1	50		24.85	24.87	24.87				
10	25	12		24.83	24.90	24.89				
10	1	0		24.57	24.54	24.58				
10	1	51		24.55	24.52	24.55				
10	50	0		24.52	24.60	24.62				
10	1	1	16-QAM	24.32	24.32	24.39	15.34	0.0342		
10	1	1	64-QAM	22.87	22.82	22.84				
10	1	1	256-QAM	20.33	20.32	20.39				
Limit	ERP < 7W			Result			Pass			



NR n5 Maximum Average Power [dBm] (GT - LC = -6.9 dB)								
BW [MHz]	RB Size	RB Offset	Mod	Lowest	Middle	Highest	ERP (dBm)	ERP(W)
15	1	1	PI/2 BPSK	24.94	24.88	24.89	15.89	0.0388
15	1	77		24.91	24.94	24.82		
15	36	18		24.84	24.93	24.85		
15	1	0		24.57	24.51	24.58		
15	1	78		24.61	24.53	24.54		
15	75	0		24.55	24.55	24.51		
15	1	1	QPSK	24.87	24.85	24.87		
15	1	77		24.86	24.85	24.87		
15	36	18		24.90	24.83	24.86		
15	1	0		24.54	24.49	24.51		
15	1	78		24.60	24.57	24.58		
15	75	0		24.56	24.53	24.58		
15	1	1	16-QAM	24.39	24.32	24.32	15.34	0.0342
15	1	1	64-QAM	22.88	22.79	22.82		
15	1	1	256-QAM	20.37	20.32	20.30		
Limit	ERP < 7W			Result			Pass	

NR n5 Maximum Average Power [dBm] (GT - LC = -6.9 dB)								
BW [MHz]	RB Size	RB Offset	Mod	Lowest	Middle	Highest	ERP (dBm)	ERP(W)
20	1	1	PI/2 BPSK	24.87	24.83	24.85	15.88	0.0387
20	1	104		24.80	24.82	24.84		
20	50	25		24.81	24.93	24.78		
20	1	0		24.55	24.45	24.49		
20	1	105		24.53	24.47	24.51		
20	100	0		24.50	24.51	24.49		
20	1	1	QPSK	24.77	24.75	24.76		
20	1	104		24.85	24.80	24.78		
20	50	25		24.84	24.77	24.80		
20	1	0		24.52	24.46	24.46		
20	1	105		24.52	24.46	24.51		
20	100	0		24.53	24.52	24.53		
20	1	1	16-QAM	24.30	24.28	24.29	15.25	0.0335
20	1	1	64-QAM	22.77	22.80	22.84		
20	1	1	256-QAM	20.36	20.26	20.28		
Limit	ERP < 7W			Result			Pass	



NR n7 Maximum Average Power [dBm] (GT - LC = -0.4 dB)								
BW [MHz]	RB Size	RB Offset	Mod	Lowest	Middle	Highest	EIRP (dBm)	EIRP(W)
5	1	1	PI/2 BPSK	24.68	24.59	24.25	24.28	0.2679
5	1	23		24.61	24.52	24.21		
5	12	6		24.65	24.55	24.20		
5	1	0		24.30	24.01	23.90		
5	1	24		24.36	23.68	23.86		
5	25	0		24.30	23.68	23.87		
5	1	1	QPSK	24.67	24.59	24.17		
5	1	23		24.60	24.57	24.19		
5	12	6		24.68	24.53	24.20		
5	1	0		24.28	24.20	23.89		
5	1	24		24.37	24.28	23.86		
5	25	0		24.30	24.21	23.86		
5	1	1	16-QAM	24.14	24.01	23.72	23.74	0.2366
5	1	1	64-QAM	22.66	22.56	22.16		
5	1	1	256-QAM	20.12	20.00	19.71		
Limit	EIRP < 2W			Result			Pass	

NR n7 Maximum Average Power [dBm] (GT - LC = -0.4 dB)								
BW [MHz]	RB Size	RB Offset	Mod	Lowest	Middle	Highest	EIRP (dBm)	EIRP(W)
10	1	1	PI/2 BPSK	24.46	24.45	24.43	24.08	0.2559
10	1	50		24.44	24.36	24.34		
10	25	12		24.40	24.48	24.41		
10	1	0		24.13	23.89	24.10		
10	1	51		24.16	23.86	24.11		
10	50	0		24.10	23.72	24.13		
10	1	1	QPSK	24.36	24.43	24.42		
10	1	50		24.36	24.44	24.42		
10	25	12		24.40	24.35	24.40		
10	1	0		24.11	24.12	24.08		
10	1	51		24.10	24.13	24.10		
10	50	0		24.11	24.08	24.12		
10	1	1	16-QAM	23.96	23.88	23.92	23.56	0.227
10	1	1	64-QAM	22.38	22.40	22.38		
10	1	1	256-QAM	19.92	19.94	19.87		
Limit	EIRP < 2W			Result			Pass	



NR n7 Maximum Average Power [dBm] (GT - LC = -0.4 dB)								
BW [MHz]	RB Size	RB Offset	Mod	Lowest	Middle	Highest	EIRP (dBm)	EIRP(W)
15	1	1	PI/2 BPSK	24.34	24.35	24.47	24.07	0.2553
15	1	77		24.28	24.35	24.45		
15	36	18		24.29	24.42	24.40		
15	1	0		24.00	23.85	24.16		
15	1	78		24.03	23.78	24.13		
15	75	0		23.95	23.84	24.11		
15	1	1	QPSK	24.31	24.33	24.45		
15	1	77		24.30	24.30	24.46		
15	36	18		24.24	24.32	24.40		
15	1	0		24.03	24.02	24.16		
15	1	78		24.01	23.98	24.14		
15	75	0		23.96	24.00	24.14		
15	1	1	16-QAM	23.79	23.79	23.92	23.52	0.2249
15	1	1	64-QAM	22.29	22.32	22.44		
15	1	1	256-QAM	19.77	19.81	19.94		
Limit	EIRP < 2W			Result			Pass	

NR n7 Maximum Average Power [dBm] (GT - LC = -0.4 dB)								
BW [MHz]	RB Size	RB Offset	Mod	Lowest	Middle	Highest	EIRP (dBm)	EIRP(W)
20	1	1	PI/2 BPSK	24.41	24.42	24.38	24.02	0.2523
20	1	104		24.39	24.40	24.38		
20	50	25		24.34	24.38	24.38		
20	1	0		24.05	23.88	23.98		
20	1	105		24.09	23.78	24.04		
20	100	0		24.03	23.82	24.07		
20	1	1	QPSK	24.41	24.41	24.34		
20	1	104		24.39	24.35	24.38		
20	50	25		24.36	24.41	24.28		
20	1	0		24.11	24.02	24.01		
20	1	105		24.03	24.11	24.07		
20	100	0		24.06	24.06	24.01		
20	1	1	16-QAM	23.83	23.84	23.85	23.45	0.2213
20	1	1	64-QAM	22.38	22.37	22.37		
20	1	1	256-QAM	19.84	19.82	19.86		
Limit	EIRP < 2W			Result			Pass	



NR n12 Maximum Average Power [dBm] (GT - LC = -7.9 dB)										
BW [MHz]	RB Size	RB Offset	Mod	Lowest	Middle	Highest	ERP (dBm)	ERP(W)		
5	1	1	PI/2 BPSK	24.88	24.95	24.88	14.91	0.0310		
5	1	23		24.84	24.94	24.85				
5	12	6		24.88	24.96	24.79				
5	1	0		24.50	24.49	24.58				
5	1	24		24.51	24.45	24.54				
5	25	0		24.56	24.45	24.51				
5	1	1	QPSK	24.81	24.89	24.81			14.30	0.0269
5	1	23		24.78	24.90	24.81				
5	12	6		24.79	24.93	24.83				
5	1	0		24.53	24.63	24.48				
5	1	24		24.55	24.58	24.50				
5	25	0		24.51	24.56	24.53				
5	1	1	16-QAM	24.35	24.35	24.32	14.30	0.0269		
5	1	1	64-QAM	22.79	22.90	22.86				
5	1	1	256-QAM	20.30	20.40	20.31				
Limit	ERP < 3W			Result			Pass			

NR n12 Maximum Average Power [dBm] (GT - LC = -7.9 dB)										
BW [MHz]	RB Size	RB Offset	Mod	Lowest	Middle	Highest	ERP (dBm)	ERP(W)		
10	1	1	PI/2 BPSK	24.93	24.43	24.88	14.90	0.0309		
10	1	50		24.83	24.86	24.79				
10	25	12		24.91	24.95	24.85				
10	1	0		24.59	24.44	24.54				
10	1	51		24.58	24.45	24.50				
10	50	0		24.55	24.47	24.55				
10	1	1	QPSK	24.93	24.35	24.87			14.36	0.0273
10	1	50		24.88	24.40	24.86				
10	25	12		24.92	24.38	24.86				
10	1	0		24.60	24.04	24.51				
10	1	51		24.57	24.10	24.57				
10	50	0		24.54	24.13	24.50				
10	1	1	16-QAM	24.41	23.93	24.31	14.36	0.0273		
10	1	1	64-QAM	22.87	22.36	22.87				
10	1	1	256-QAM	20.40	19.86	20.30				
Limit	ERP < 3W			Result			Pass			



NR n12 Maximum Average Power [dBm] (GT - LC = -7.9 dB)								
BW [MHz]	RB Size	RB Offset	Mod	Lowest	Middle	Highest	ERP (dBm)	ERP(W)
15	1	1	PI/2 BPSK	24.90	24.88	24.81	14.87	0.0307
15	1	77		24.84	24.91	24.76		
15	36	18		24.81	24.92	24.72		
15	1	0		24.57	24.36	24.43		
15	1	78		24.53	24.45	24.46		
15	75	0		24.59	24.48	24.42		
15	1	1	QPSK	24.89	24.85	24.80	14.31	0.0270
15	1	77		24.85	24.79	24.74		
15	36	18		24.85	24.84	24.76		
15	1	0		24.56	24.54	24.47		
15	1	78		24.50	24.51	24.49		
15	75	0		24.52	24.52	24.45		
15	1	1	16-QAM	24.36	24.29	24.31	14.31	0.0270
15	1	1	64-QAM	22.87	22.80	22.78		
15	1	1	256-QAM	20.40	20.33	20.21		
Limit	ERP < 3W			Result			Pass	



NR n25 Maximum Average Power [dBm] (GT - LC = -0.8 dB)								
BW [MHz]	RB Size	RB Offset	Mod	Lowest	Middle	Highest	EIRP (dBm)	EIRP(W)
5	1	1	PI/2 BPSK	25.54	25.63	25.67	24.88	0.3076
5	1	23		25.44	25.68	25.61		
5	12	6		25.50	25.65	25.66		
5	1	0		25.19	25.17	25.34		
5	1	24		25.21	25.22	25.30		
5	25	0		25.19	25.29	25.35		
5	1	1	QPSK	25.52	25.53	25.64		
5	1	23		25.47	25.60	25.60		
5	12	6		25.53	25.63	25.57		
5	1	0		25.19	25.23	25.30		
5	1	24		25.16	25.23	25.27		
5	25	0		25.24	25.25	25.28		
5	1	1	16-QAM	25.04	25.04	25.11	24.31	0.2698
5	1	1	64-QAM	23.49	23.60	23.60		
5	1	1	256-QAM	21.02	21.07	21.08		
Limit	EIRP < 2W			Result			Pass	

NR n25 Maximum Average Power [dBm] (GT - LC = -0.8 dB)								
BW [MHz]	RB Size	RB Offset	Mod	Lowest	Middle	Highest	EIRP (dBm)	EIRP(W)
10	1	1	PI/2 BPSK	25.64	25.65	25.68	24.88	0.3076
10	1	50		25.55	25.67	25.64		
10	25	12		25.64	25.63	25.61		
10	1	0		25.25	25.25	25.37		
10	1	51		25.31	25.35	25.30		
10	50	0		25.24	25.31	25.29		
10	1	1	QPSK	25.57	25.62	25.66		
10	1	50		25.62	25.62	25.68		
10	25	12		25.62	25.60	25.60		
10	1	0		25.32	25.34	25.34		
10	1	51		25.33	25.33	25.29		
10	50	0		25.26	25.32	25.34		
10	1	1	16-QAM	25.06	25.07	25.15	24.35	0.2723
10	1	1	64-QAM	23.55	23.56	23.68		
10	1	1	256-QAM	21.11	21.13	21.11		
Limit	EIRP < 2W			Result			Pass	



NR n25 Maximum Average Power [dBm] (GT - LC = -0.8 dB)								
BW [MHz]	RB Size	RB Offset	Mod	Lowest	Middle	Highest	EIRP (dBm)	EIRP(W)
15	1	1	PI/2 BPSK	25.54	25.65	25.68	24.88	0.3076
15	1	77		25.49	25.59	25.59		
15	36	18		25.48	25.67	25.58		
15	1	0		25.21	25.18	25.37		
15	1	78		25.21	25.32	25.29		
15	75	0		25.23	25.29	25.34		
15	1	1	QPSK	25.54	25.57	25.65		
15	1	77		25.49	25.63	25.58		
15	36	18		25.46	25.59	25.60		
15	1	0		25.15	25.35	25.33		
15	1	78		25.16	25.33	25.33		
15	75	0		25.18	25.26	25.31		
15	1	1	16-QAM	24.97	25.06	25.13	24.33	0.271
15	1	1	64-QAM	23.47	23.61	23.58		
15	1	1	256-QAM	20.96	21.12	21.16		
Limit	EIRP < 2W			Result			Pass	

NR n25 Maximum Average Power [dBm] (GT - LC = -0.8 dB)								
BW [MHz]	RB Size	RB Offset	Mod	Lowest	Middle	Highest	EIRP (dBm)	EIRP(W)
20	1	1	PI/2 BPSK	25.50	25.57	25.57	24.86	0.3062
20	1	104		25.47	25.66	25.54		
20	50	25		25.41	25.65	25.53		
20	1	0		25.14	25.09	25.22		
20	1	105		25.19	25.31	25.23		
20	100	0		25.15	25.29	25.21		
20	1	1	QPSK	25.40	25.50	25.51		
20	1	104		25.44	25.50	25.55		
20	50	25		25.50	25.49	25.51		
20	1	0		25.17	25.24	25.25		
20	1	105		25.18	25.21	25.24		
20	100	0		25.12	25.25	25.20		
20	1	1	16-QAM	24.91	25.01	24.97	24.21	0.2636
20	1	1	64-QAM	23.44	23.55	23.49		
20	1	1	256-QAM	20.90	21.03	21.00		
Limit	EIRP < 2W			Result			Pass	



NR n66 Maximum Average Power [dBm] (GT - LC = -0.4 dB)								
BW [MHz]	RB Size	RB Offset	Mod	Lowest	Middle	Highest	EIRP (dBm)	EIRP(W)
5	1	1	PI/2 BPSK	25.58	25.66	25.44	25.26	0.3357
5	1	23		25.53	25.66	25.36		
5	12	6		25.54	25.66	25.36		
5	1	0		25.24	25.27	25.08		
5	1	24		25.27	25.28	25.07		
5	25	0		25.18	25.26	25.09		
5	1	1	QPSK	25.53	25.64	25.39		
5	1	23		25.51	25.64	25.41		
5	12	6		25.50	25.61	25.41		
5	1	0		25.19	25.29	25.11		
5	1	24		25.23	25.30	25.08		
5	25	0		25.26	25.31	25.13		
5	1	1	16-QAM	25.05	25.07	24.86	24.67	0.2931
5	1	1	64-QAM	23.49	23.64	23.42		
5	1	1	256-QAM	21.02	21.08	20.88		
Limit	EIRP < 1W			Result			Pass	

NR n66 Maximum Average Power [dBm] (GT - LC = -0.4 dB)								
BW [MHz]	RB Size	RB Offset	Mod	Lowest	Middle	Highest	EIRP (dBm)	EIRP(W)
10	1	1	PI/2 BPSK	25.68	25.66	25.63	25.28	0.3373
10	1	50		25.64	25.67	25.57		
10	25	12		25.67	25.65	25.57		
10	1	0		25.29	25.21	25.28		
10	1	51		25.36	25.29	25.31		
10	50	0		25.30	25.28	25.28		
10	1	1	QPSK	25.64	25.63	25.59		
10	1	50		25.60	25.61	25.58		
10	25	12		25.65	25.61	25.54		
10	1	0		25.36	25.32	25.26		
10	1	51		25.37	25.31	25.24		
10	50	0		25.32	25.30	25.25		
10	1	1	16-QAM	25.11	25.07	25.11	24.71	0.2958
10	1	1	64-QAM	23.59	23.61	23.57		
10	1	1	256-QAM	21.12	21.07	21.05		
Limit	EIRP < 1W			Result			Pass	



NR n66 Maximum Average Power [dBm] (GT - LC = -0.4 dB)								
BW [MHz]	RB Size	RB Offset	Mod	Lowest	Middle	Highest	EIRP (dBm)	EIRP(W)
15	1	1	PI/2 BPSK	25.66	25.66	25.60	25.27	0.3365
15	1	77		25.58	25.67	25.51		
15	36	18		25.62	25.63	25.51		
15	1	0		25.32	25.20	25.25		
15	1	78		25.26	25.30	25.24		
15	75	0		25.28	25.25	25.27		
15	1	1	QPSK	25.63	25.63	25.58		
15	1	77		25.61	25.65	25.52		
15	36	18		25.65	25.63	25.53		
15	1	0		25.32	25.34	25.24		
15	1	78		25.31	25.30	25.20		
15	75	0		25.34	25.34	25.29		
15	1	1	16-QAM	25.06	25.07	25.09	24.69	0.2944
15	1	1	64-QAM	23.58	23.66	23.58		
15	1	1	256-QAM	21.11	21.09	21.03		
Limit	EIRP < 1W			Result			Pass	

NR n66 Maximum Average Power [dBm] (GT - LC = -0.4 dB)								
BW [MHz]	RB Size	RB Offset	Mod	Lowest	Middle	Highest	EIRP (dBm)	EIRP(W)
20	1	1	PI/2 BPSK	25.62	25.66	25.62	25.26	0.3357
20	1	104		25.61	25.62	25.58		
20	50	25		25.58	25.65	25.55		
20	1	0		25.31	25.17	25.25		
20	1	105		25.23	25.26	25.26		
20	100	0		25.30	25.28	25.24		
20	1	1	QPSK	25.58	25.56	25.57		
20	1	104		25.61	25.61	25.61		
20	50	25		25.59	25.61	25.56		
20	1	0		25.26	25.35	25.26		
20	1	105		25.30	25.30	25.30		
20	100	0		25.28	25.34	25.26		
20	1	1	16-QAM	25.11	25.12	25.08	24.72	0.2965
20	1	1	64-QAM	23.62	23.57	23.55		
20	1	1	256-QAM	21.03	21.15	21.12		
Limit	EIRP < 1W			Result			Pass	



NR n66 Maximum Average Power [dBm] (GT - LC = -0.4 dB)								
BW [MHz]	RB Size	RB Offset	Mod	Lowest	Middle	Highest	EIRP (dBm)	EIRP(W)
30	1	1	PI/2 BPSK	25.46	25.49	24.52	25.27	0.3365
30	1	158		25.46	25.62	24.43		
30	80	40		25.44	25.67	24.45		
30	1	0		25.09	24.95	24.18		
30	1	159		25.07	25.12	24.22		
30	160	0		25.08	25.17	24.20		
30	1	1	QPSK	25.42	25.46	24.48	24.56	0.2858
30	1	158		25.36	25.46	24.51		
30	80	40		25.45	25.49	24.43		
30	1	0		25.12	25.13	24.18		
30	1	159		25.11	25.13	24.20		
30	160	0		25.11	25.15	24.22		
30	1	1	16-QAM	24.92	24.96	23.93	24.56	0.2858
30	1	1	64-QAM	23.38	23.47	22.42		
30	1	1	256-QAM	20.86	20.95	19.93		
Limit	EIRP < 1W			Result			Pass	



NR n66 Maximum Average Power [dBm] (GT - LC = -0.4 dB)								
BW [MHz]	RB Size	RB Offset	Mod	Lowest	Middle	Highest	EIRP (dBm)	EIRP(W)
40	1	1	PI/2 BPSK	25.12	25.21	25.15	25.26	0.3357
40	1	214		25.03	25.45	25.07		
40	108	54		25.04	25.66	25.08		
40	1	0		24.82	24.72	24.76		
40	1	215		24.76	24.99	24.84		
40	216	0		24.75	25.14	24.84		
40	1	1	QPSK	25.03	25.14	25.06		
40	1	214		25.08	25.19	25.05		
40	108	54		25.06	25.18	25.08		
40	1	0		24.74	24.90	24.82		
40	1	215		24.78	24.84	24.82		
40	216	0		24.73	24.84	24.83		
40	1	1	16-QAM	24.59	24.71	24.59	24.31	0.2698
40	1	1	64-QAM	23.03	23.18	23.11		
40	1	1	256-QAM	20.60	20.68	20.61		
Limit	EIRP < 1W			Result			Pass	



NR n71 Maximum Average Power [dBm] (GT - LC = -7.8 dB)								
BW [MHz]	RB Size	RB Offset	Mod	Lowest	Middle	Highest	ERP (dBm)	ERP(W)
5	1	1	PI/2 BPSK	24.83	24.79	24.75	14.90	0.0309
5	1	23		24.77	24.82	24.71		
5	12	6		24.79	24.85	24.75		
5	1	0		24.44	24.30	24.41		
5	1	24		24.45	24.41	24.36		
5	25	0		24.52	24.35	24.45		
5	1	1	QPSK	24.79	24.75	24.65		
5	1	23		24.81	24.77	24.68		
5	12	6		24.74	24.77	24.71		
5	1	0		24.51	24.40	24.42		
5	1	24		24.52	24.47	24.43		
5	25	0		24.47	24.40	24.41		
5	1	1	16-QAM	24.27	24.23	24.24	14.32	0.027
5	1	1	64-QAM	22.79	22.71	22.73		
5	1	1	256-QAM	20.29	20.28	20.16		
Limit	ERP < 3W			Result			Pass	

NR n71 Maximum Average Power [dBm] (GT - LC = -7.8 dB)								
BW [MHz]	RB Size	RB Offset	Mod	Lowest	Middle	Highest	ERP (dBm)	ERP(W)
10	1	1	PI/2 BPSK	24.82	24.78	24.75	14.89	0.0308
10	1	50		24.72	24.84	24.72		
10	25	12		24.78	24.83	24.69		
10	1	0		24.45	24.28	24.42		
10	1	51		24.49	24.36	24.44		
10	50	0		24.50	24.38	24.35		
10	1	1	QPSK	24.75	24.68	24.66		
10	1	50		24.77	24.69	24.72		
10	25	12		24.77	24.70	24.69		
10	1	0		24.46	24.46	24.40		
10	1	51		24.45	24.43	24.37		
10	50	0		24.47	24.47	24.41		
10	1	1	16-QAM	24.23	24.27	24.16	14.32	0.0270
10	1	1	64-QAM	22.74	22.74	22.70		
10	1	1	256-QAM	20.28	20.26	20.16		
Limit	ERP < 3W			Result			Pass	



NR n71 Maximum Average Power [dBm] (GT - LC = -7.8 dB)								
BW [MHz]	RB Size	RB Offset	Mod	Lowest	Middle	Highest	ERP (dBm)	ERP(W)
15	1	1	PI/2 BPSK	24.75	24.81	24.76	14.91	0.0310
15	1	77		24.73	24.86	24.73		
15	36	18		24.68	24.85	24.75		
15	1	0		24.41	24.24	24.43		
15	1	78		24.42	24.32	24.42		
15	75	0		24.40	24.36	24.44		
15	1	1	QPSK	24.67	24.79	24.76		
15	1	77		24.71	24.74	24.74		
15	36	18		24.72	24.74	24.75		
15	1	0		24.37	24.49	24.44		
15	1	78		24.38	24.43	24.45		
15	75	0		24.39	24.45	24.39		
15	1	1	16-QAM	24.21	24.31	24.17	14.36	0.0273
15	1	1	64-QAM	22.74	22.73	22.69		
15	1	1	256-QAM	20.16	20.24	20.18		
Limit	ERP < 3W			Result			Pass	

NR n71 Maximum Average Power [dBm] (GT - LC = -7.8 dB)								
BW [MHz]	RB Size	RB Offset	Mod	Lowest	Middle	Highest	ERP (dBm)	ERP(W)
20	1	1	PI/2 BPSK	24.65	24.74	24.77	14.90	0.0309
20	1	104		24.65	24.78	24.76		
20	50	25		24.60	24.85	24.70		
20	1	0		24.31	24.26	24.39		
20	1	105		24.28	24.26	24.39		
20	100	0		24.34	24.34	24.42		
20	1	1	QPSK	24.60	24.71	24.75		
20	1	104		24.63	24.73	24.70		
20	50	25		24.57	24.74	24.70		
20	1	0		24.33	24.38	24.39		
20	1	105		24.29	24.36	24.44		
20	100	0		24.26	24.39	24.44		
20	1	1	16-QAM	24.07	24.24	24.22	14.29	0.0269
20	1	1	64-QAM	22.63	22.65	22.73		
20	1	1	256-QAM	20.08	20.23	20.19		
Limit	ERP < 3W			Result			Pass	



FR1 n2

Peak-to-Average Ratio

Mode	FR1 n2 / 20MHz / DFT-S OFDM				
Mod.	PI/2 BPSK	QPSK	16QAM	64QAM	Limit: 13dB
RB Size	Full RB	Full RB	Full RB	Full RB	Result
Middle CH	4.08	4.96	5.80	6.04	PASS
Mode	FR1 n2 / 20MHz / DFT-S OFDM				
Mod.	256QAM				Limit: 13dB
RB Size	Full RB				Result
Middle CH	6.50				PASS



FR1 n2 / 20MHz / DFT-S OFDM / Middle Channel / Full RB

PI/2 BPSK

QPSK

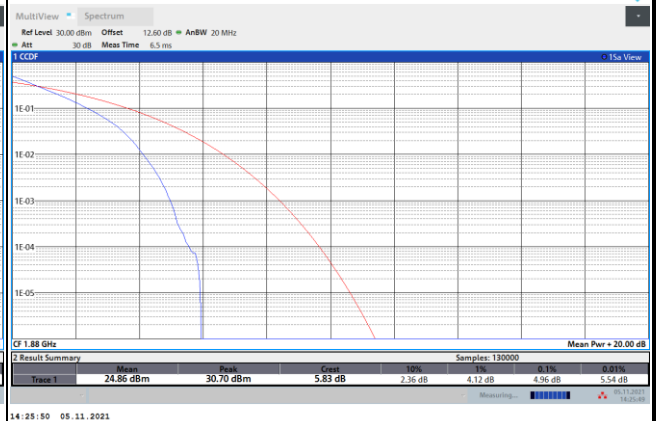
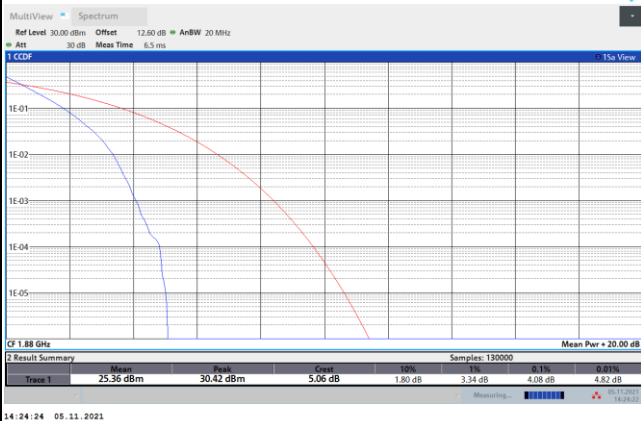

16QAM

64QAM

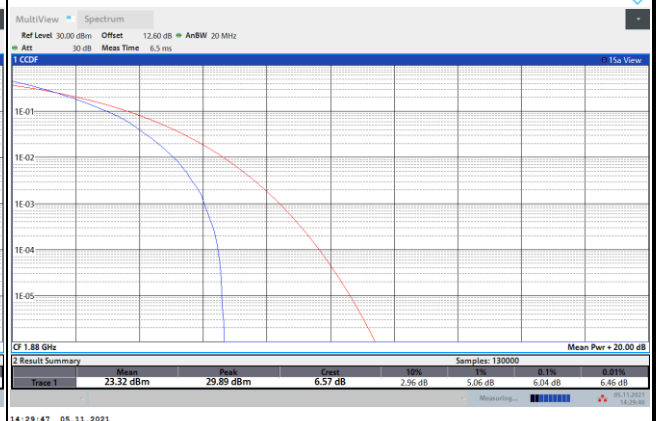
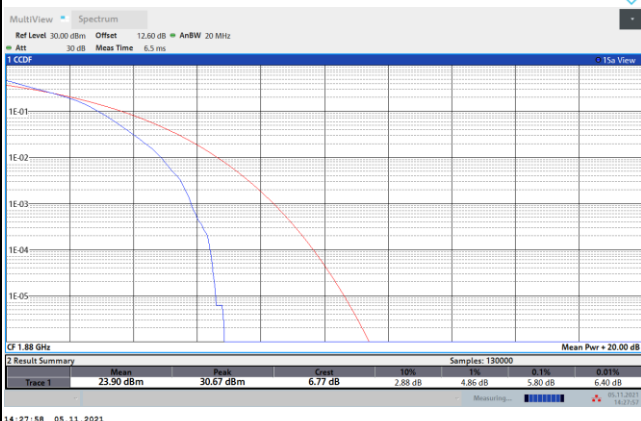

256QAM

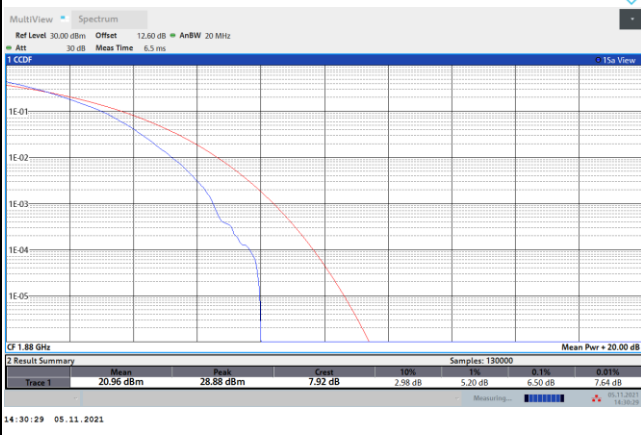



26dB Bandwidth

Mode	FR1 n2 : 26dB BW(MHz) / DFT-S OFDM							
BW	5MHz		10MHz		15MHz		20MHz	
Mod.	PI/2 BPSK		PI/2 BPSK		PI/2 BPSK		PI/2 BPSK	
Middle CH	5.14		9.53		14.33		18.82	

Mode	FR1 n2 : 26dB BW(MHz) / CP OFDM							
BW	5MHz		10MHz		15MHz		20MHz	
Mod.	QPSK	16QAM	QPSK	16QAM	QPSK	16QAM	QPSK	16QAM
Middle CH	5.26	5.19	9.79	9.93	15.11	15.14	20.06	20.22
Mod.	64QAM	256QAM	64QAM	256QAM	64QAM	256QAM	64QAM	256QAM
Middle CH	5.30	5.09	9.81	9.81	14.93	15.05	20.10	20.34



FR1 n2 / 5MHz / DFT-S OFDM / Middle Channel / Full RB

PI/2 BPSK

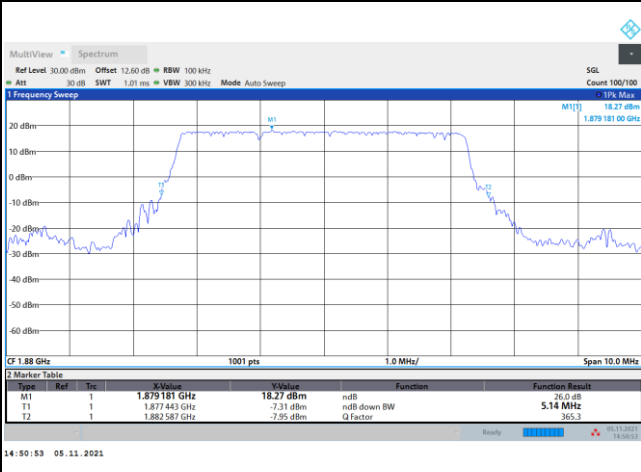

FR1 n2 / 5MHz / CP OFDM / Middle Channel / Full RB

QPSK

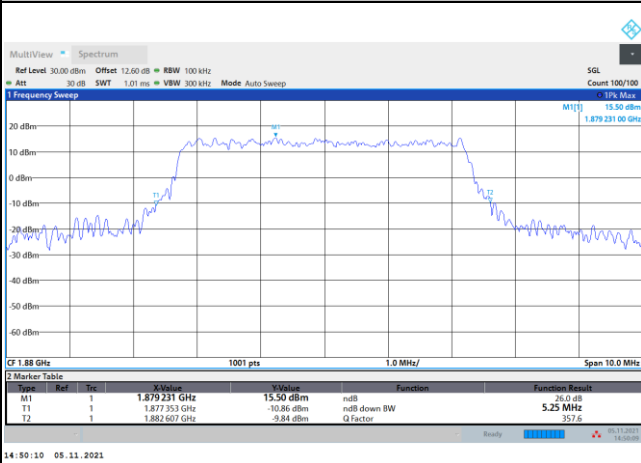

16QAM

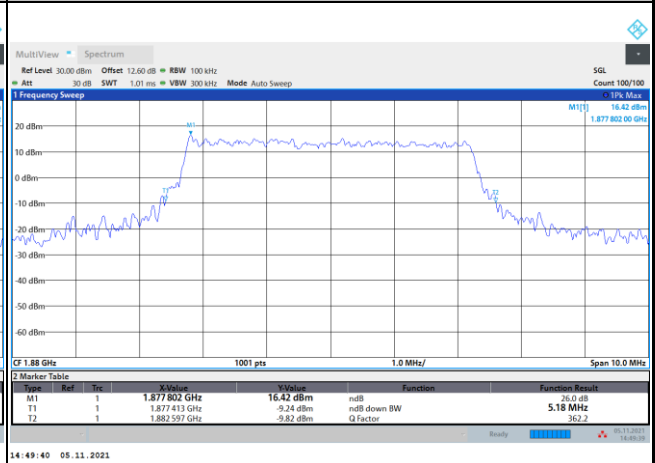

64QAM

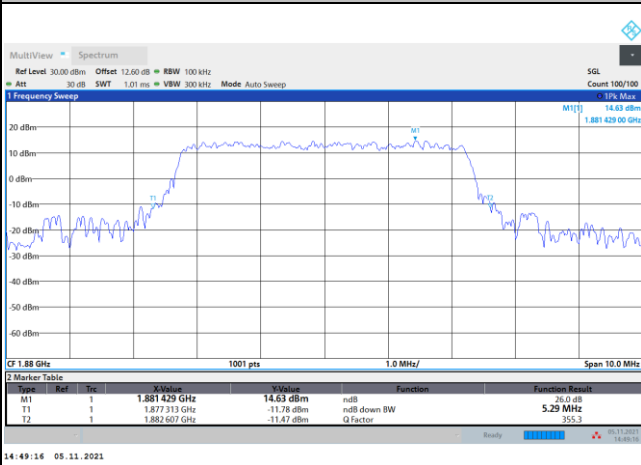

256QAM

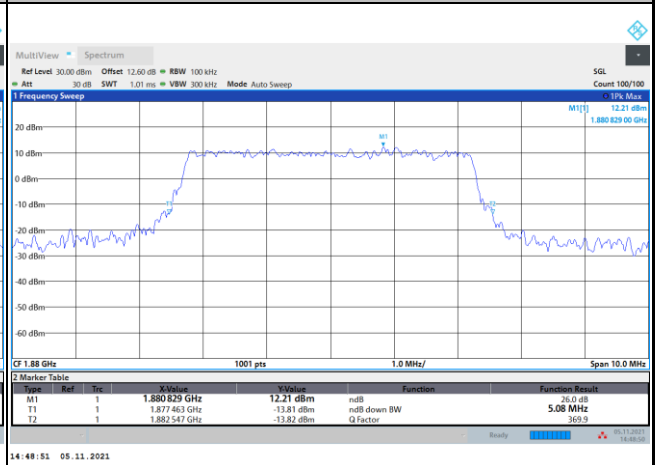



FR1 n2 / 10MHz / DFT-S OFDM / Middle Channel / Full RB

PI/2 BPSK

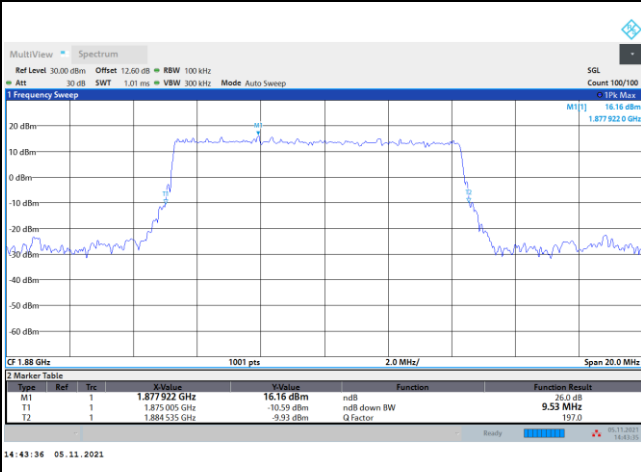

FR1 n2 / 10MHz / CP OFDM / Middle Channel / Full RB

QPSK

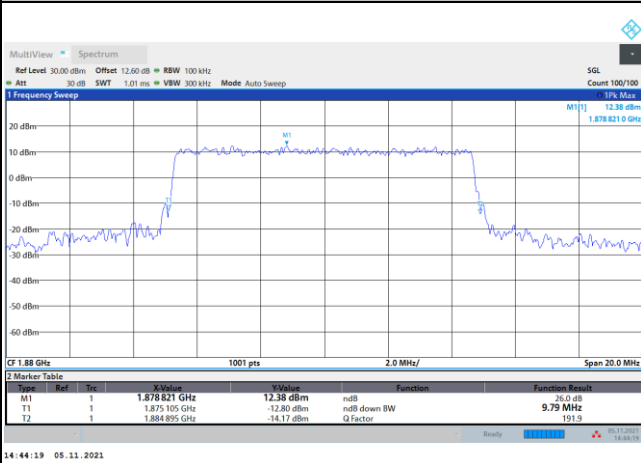

16QAM

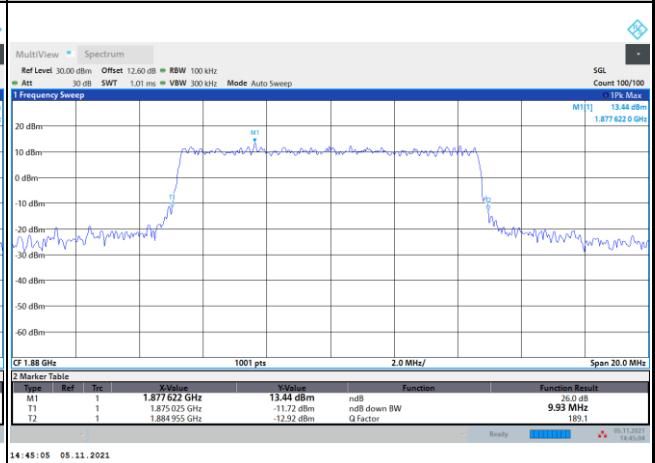

64QAM

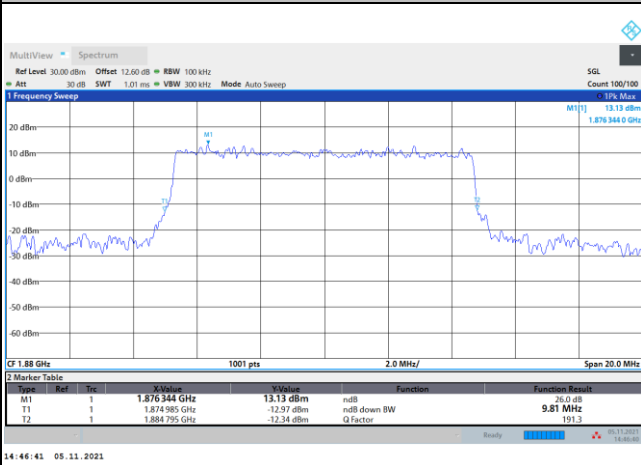

256QAM

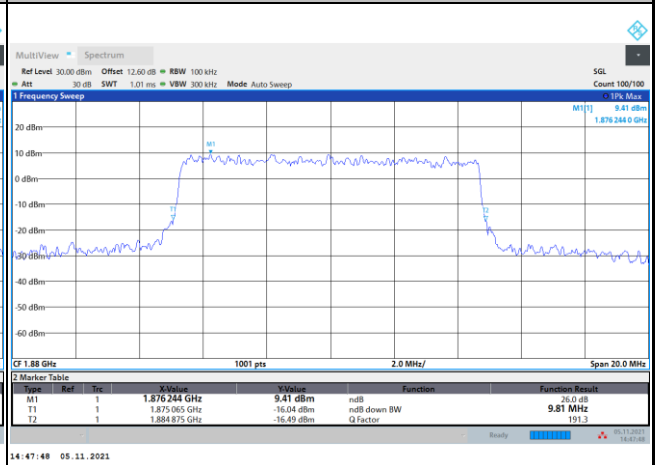



FR1 n2 / 15MHz / DFT-S OFDM / Middle Channel / Full RB

PI/2 BPSK

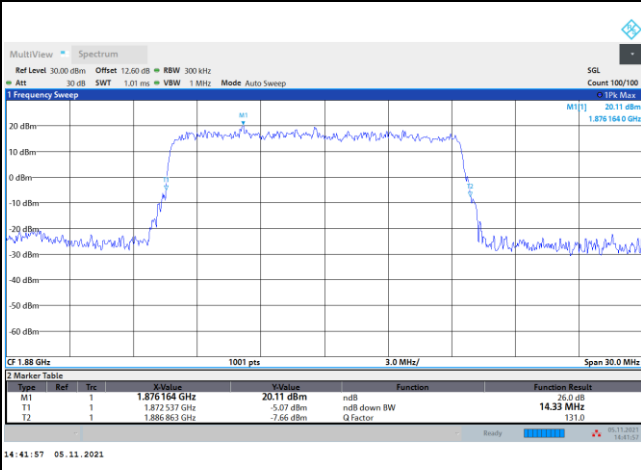

FR1 n2 / 15MHz / CP OFDM / Middle Channel / Full RB

QPSK

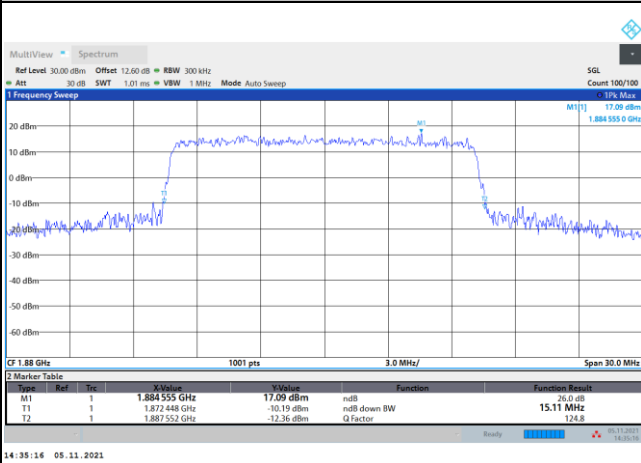

16QAM

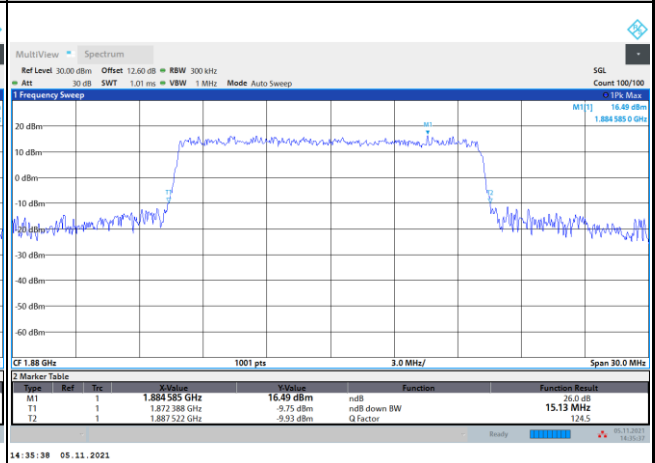

64QAM

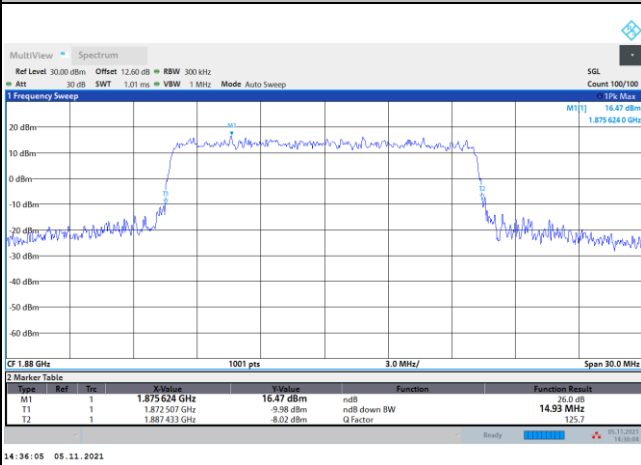

256QAM

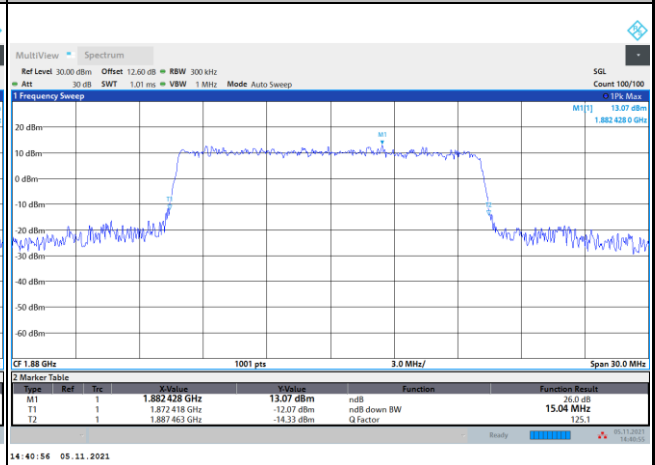



FR1 n2 / 20MHz / DFT-S OFDM / Middle Channel / Full RB

PI/2 BPSK

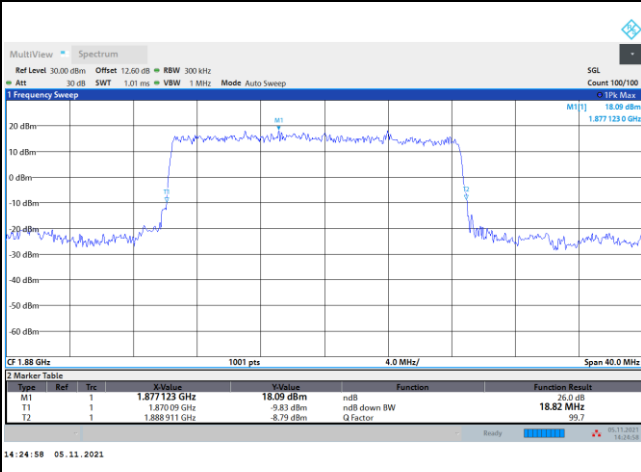

FR1 n2 / 20MHz / CP OFDM / Middle Channel / Full RB

QPSK

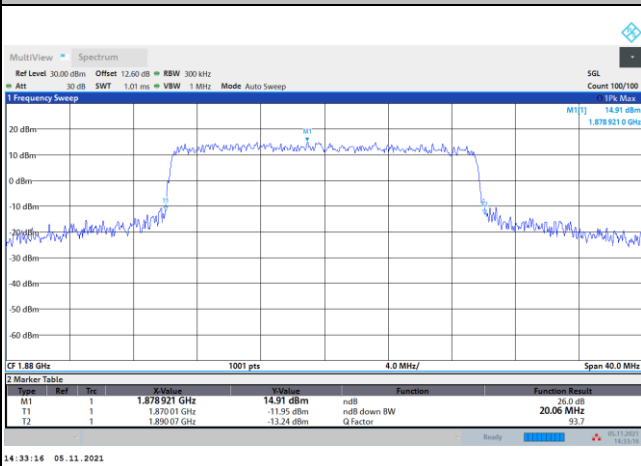

16QAM

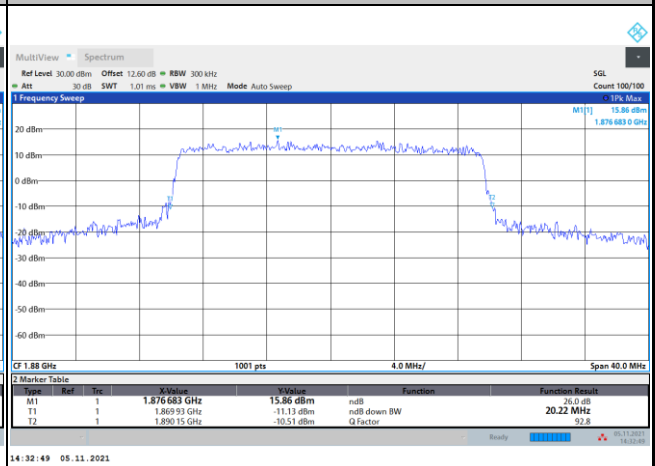

64QAM

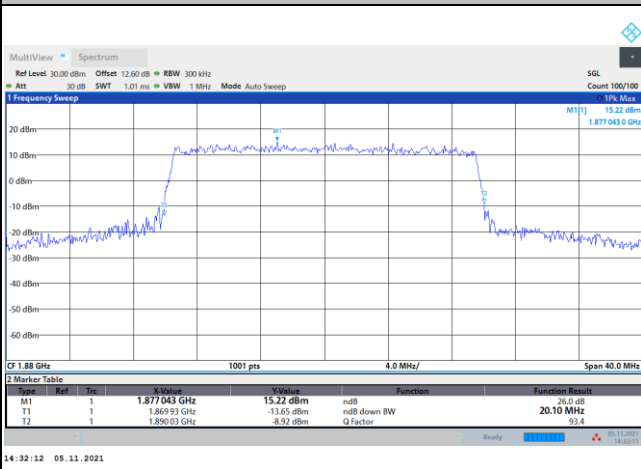

256QAM





Occupied Bandwidth

Mode	FR1 n2 : 99%OBW(MHz) / DFT-S OFDM							
BW	5MHz		10MHz		15MHz		20MHz	
Mod.	PI/2 BPSK		PI/2 BPSK		PI/2 BPSK		PI/2 BPSK	
Middle CH	4.51		8.96		13.46		17.86	

Mode	FR1 n2 : 99%OBW (MHz) / CP OFDM							
BW	5MHz		10MHz		15MHz		20MHz	
Mod.	QPSK	16QAM	QPSK	16QAM	QPSK	16QAM	QPSK	16QAM
Middle CH	4.51	4.52	9.28	9.31	14.15	14.16	18.90	18.88
Mod.	64QAM	256QAM	64QAM	256QAM	64QAM	256QAM	64QAM	256QAM
Middle CH	4.51	4.51	9.29	9.31	14.18	14.18	18.88	18.91



FR1 n2 / 5MHz / DFT-S OFDM / Middle Channel / Full RB

PI/2 BPSK

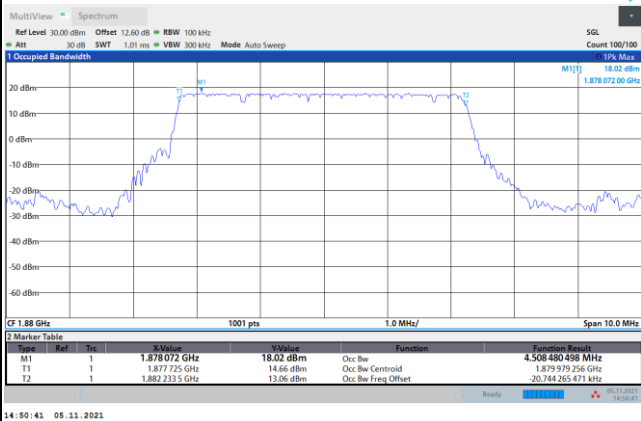

FR1 n2 / 5MHz / CP OFDM / Middle Channel / Full RB

QPSK

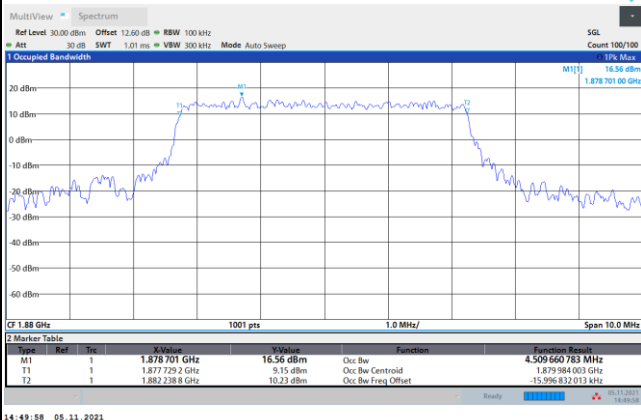

16QAM

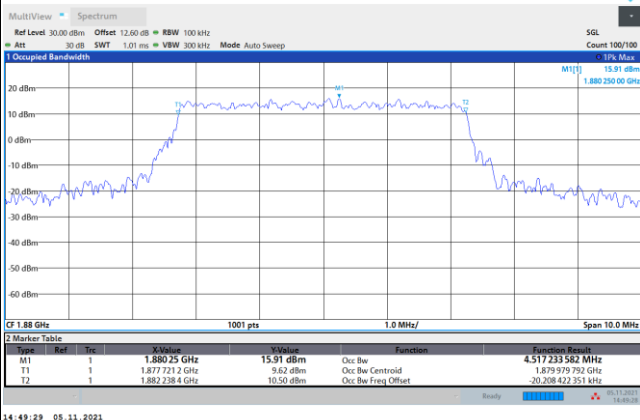

64QAM

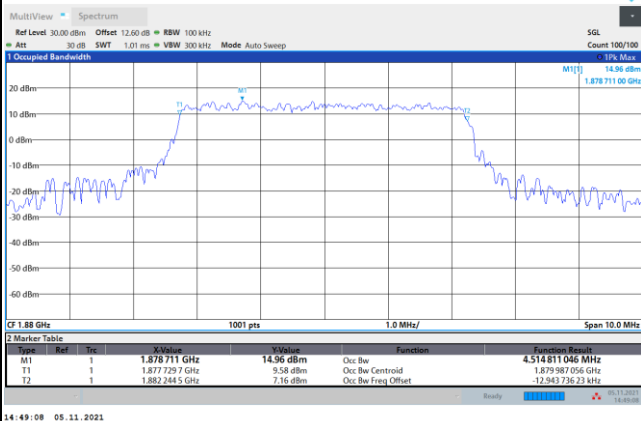

256QAM

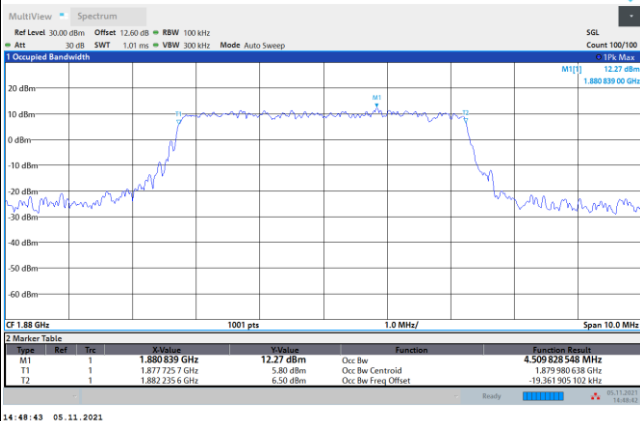



FR1 n2 / 10MHz / DFT-S OFDM / Middle Channel / Full RB

PI/2 BPSK

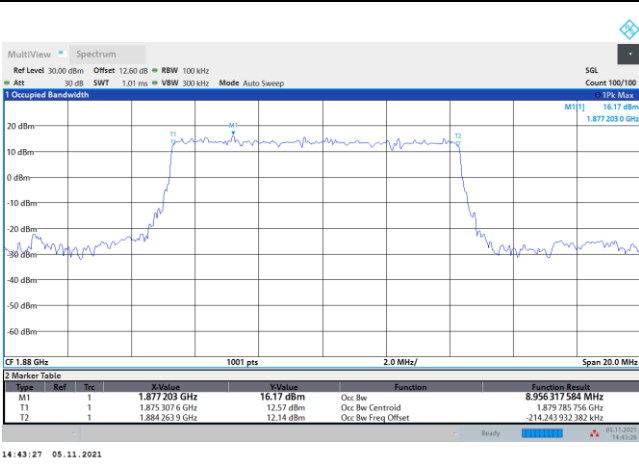

FR1 n2 / 10MHz / CP OFDM / Middle Channel / Full RB

QPSK

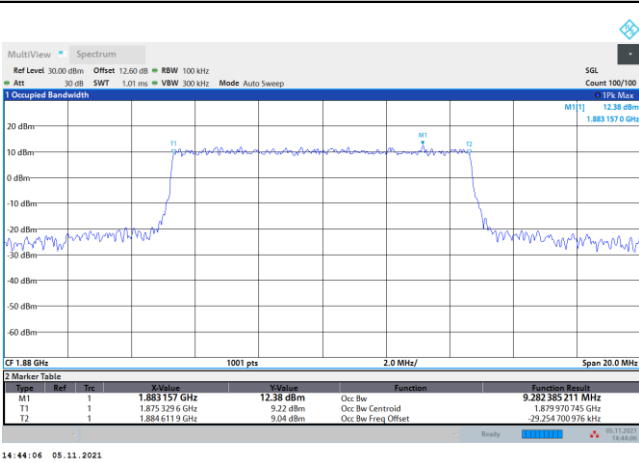

16QAM

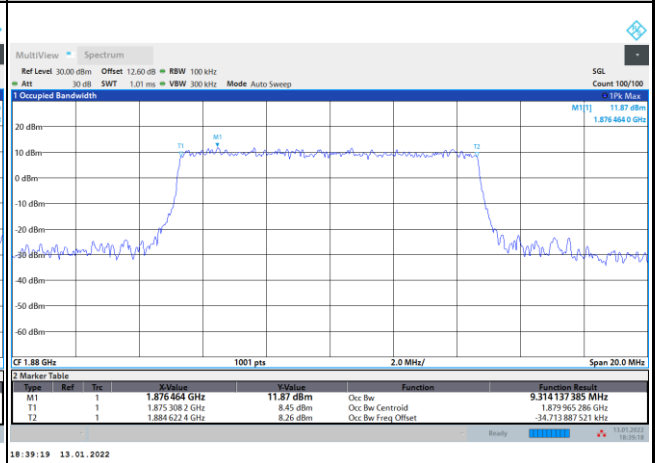

64QAM

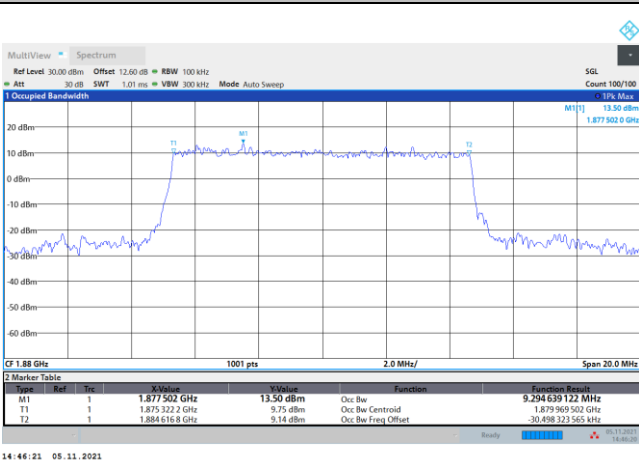

256QAM

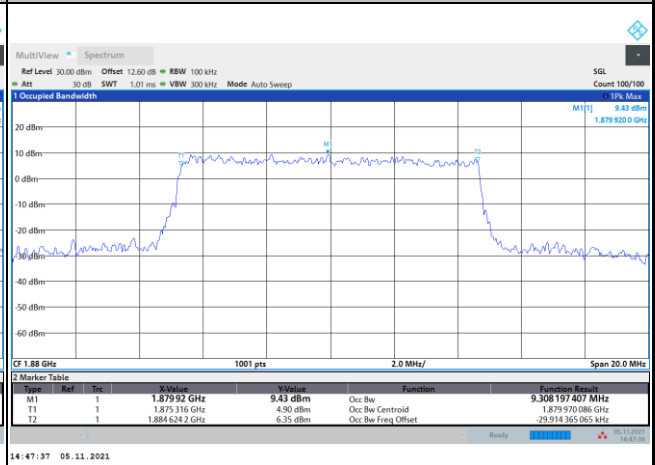



FR1 n2 / 15MHz / DFT-S OFDM / Middle Channel / Full RB

PI/2 BPSK

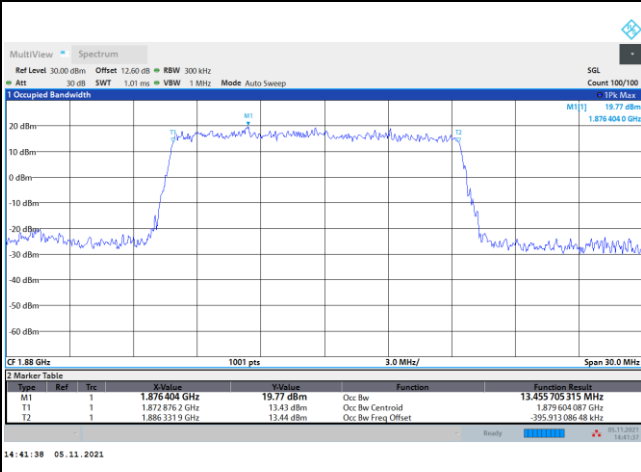

FR1 n2 / 15MHz / CP OFDM / Middle Channel / Full RB

QPSK

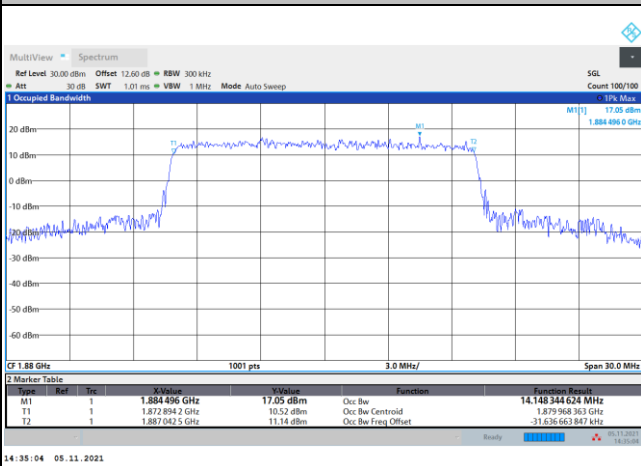

16QAM

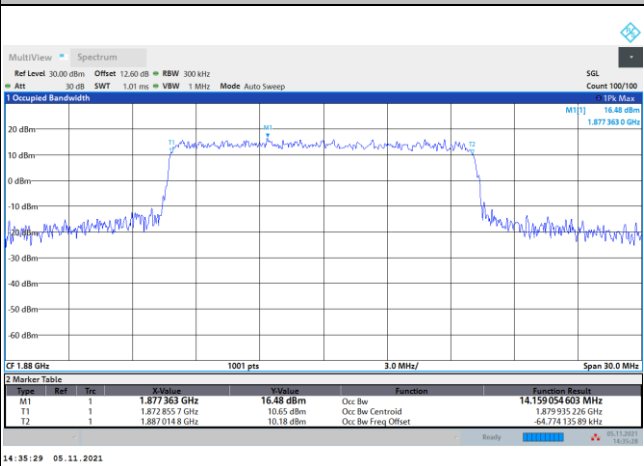

64QAM

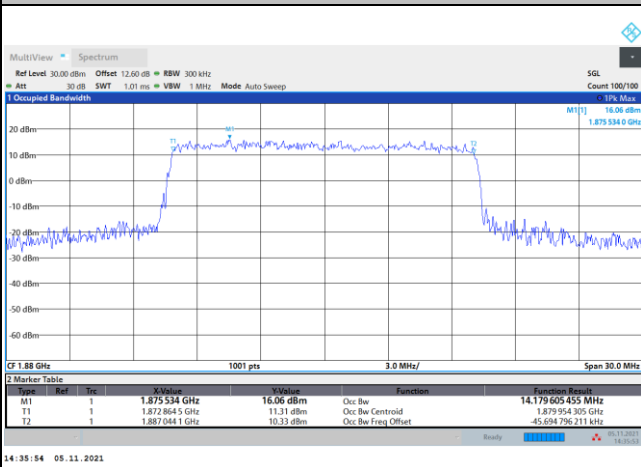

256QAM

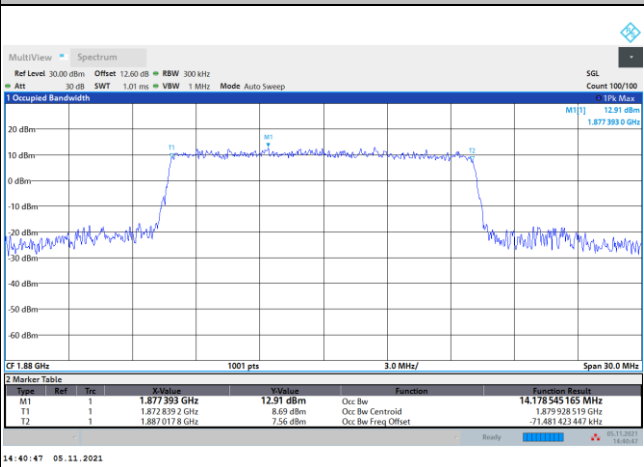



FR1 n2 / 20MHz / DFT-S OFDM / Middle Channel / Full RB

PI/2 BPSK

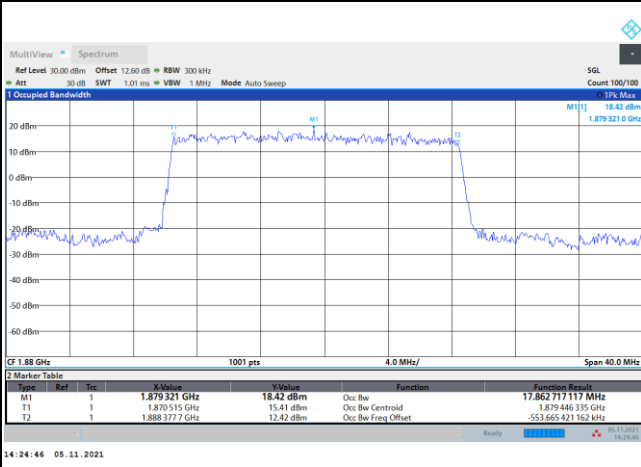

FR1 n2 / 20MHz / CP OFDM / Middle Channel / Full RB

QPSK

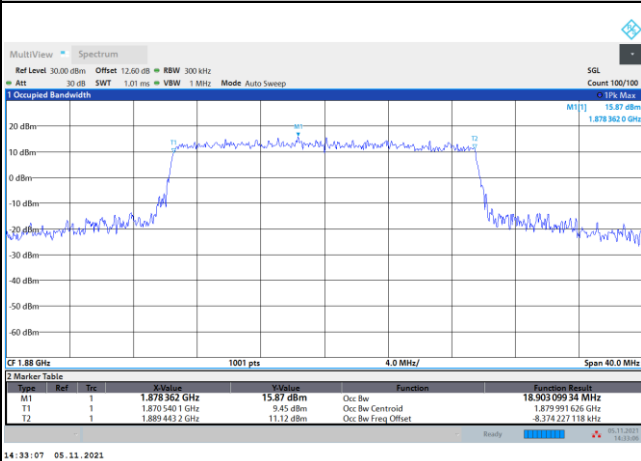

16QAM

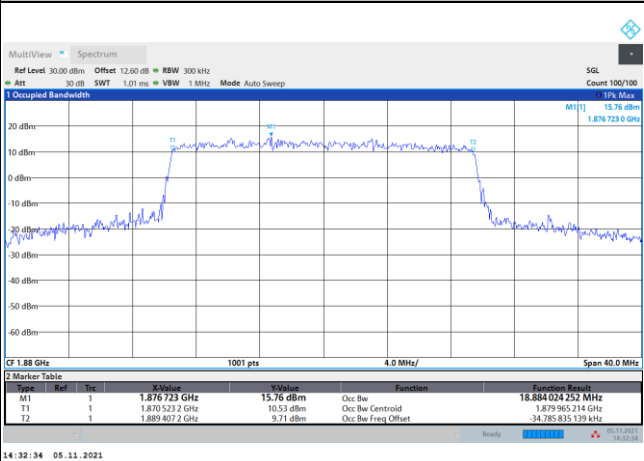

64QAM

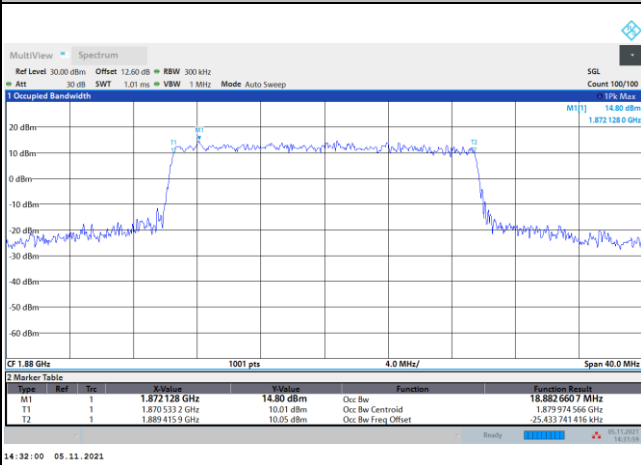

256QAM

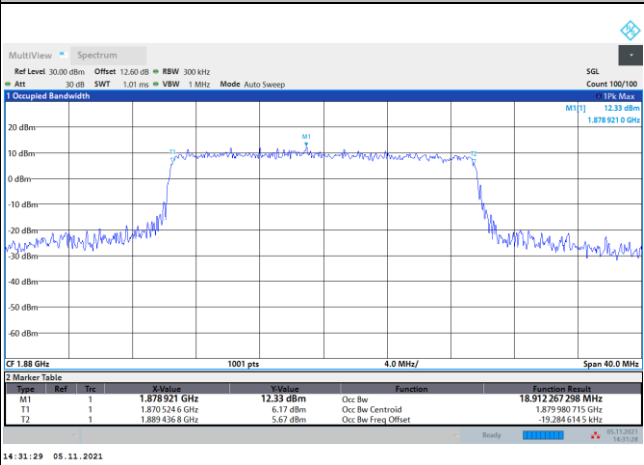



Conducted Band Edge

FR1 n2 / 5MHz / DFT-S OFDM / PI/2 BPSK

Lowest Band Edge / 1RB0

Highest Band Edge / 1RBmax

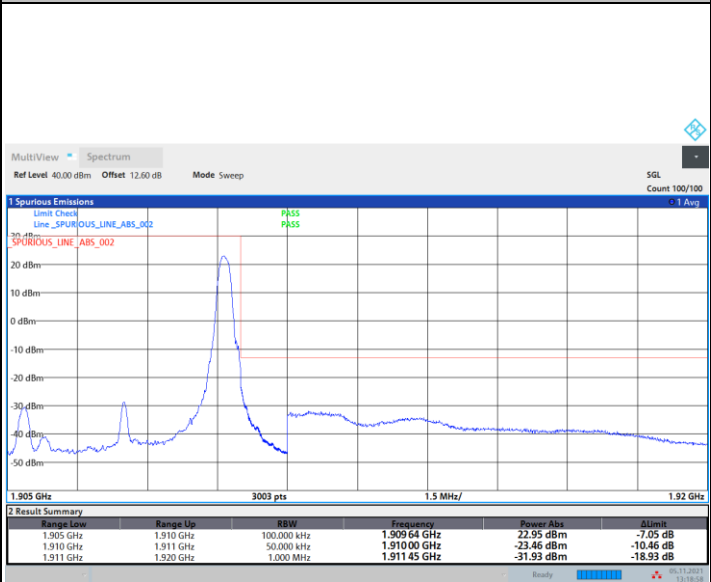
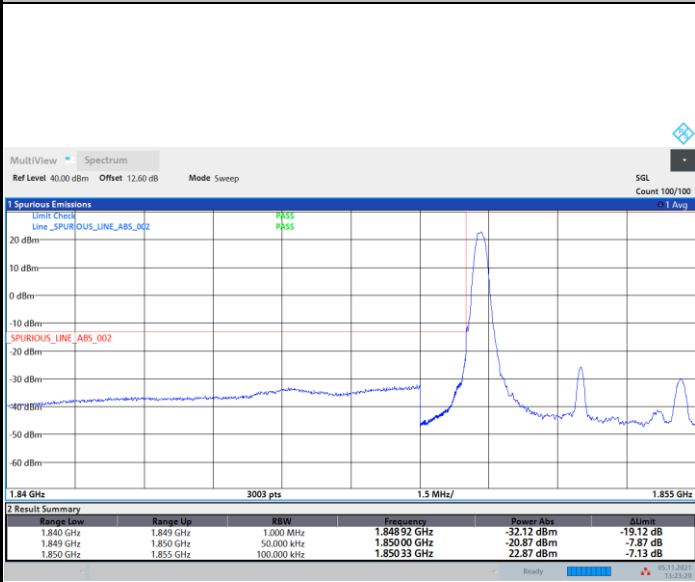

13:23:29 05.11.2021

13:18:59 05.11.2021

Lowest Band Edge / Full RB

Highest Band Edge / Full RB

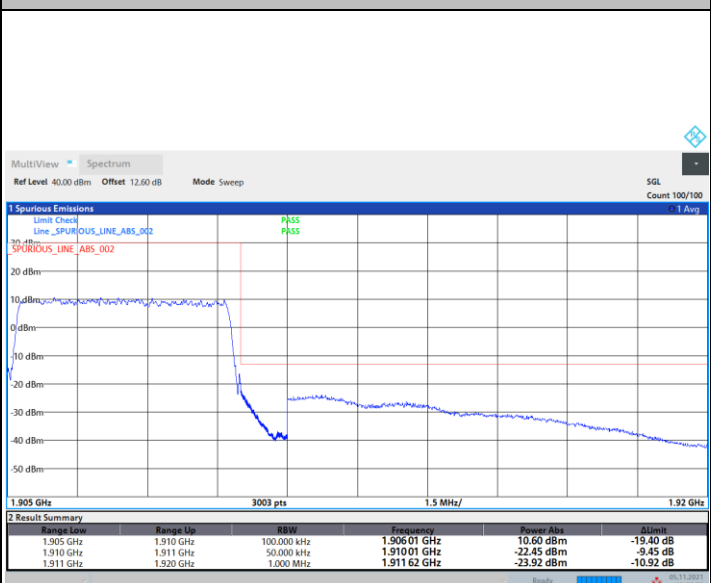
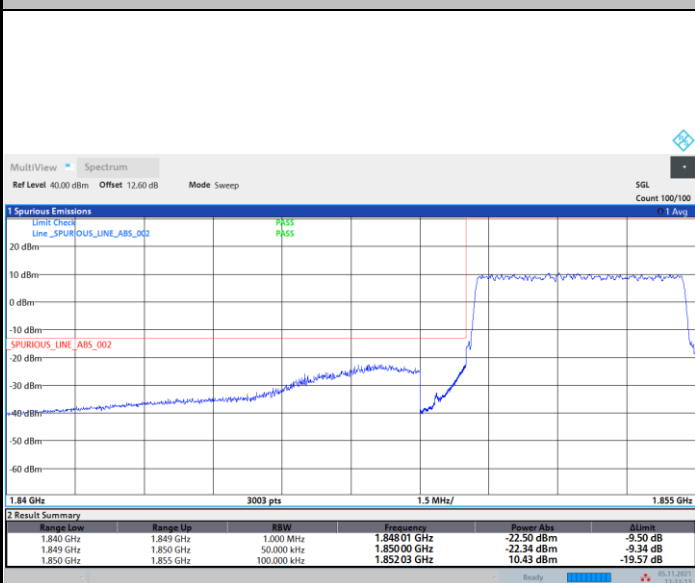

13:33:13 05.11.2021

13:06:56 05.11.2021



FR1 n2 / 5MHz / DFT-S OFDM / QPSK

Lowest Band Edge / 1RB0

Highest Band Edge / 1RBmax

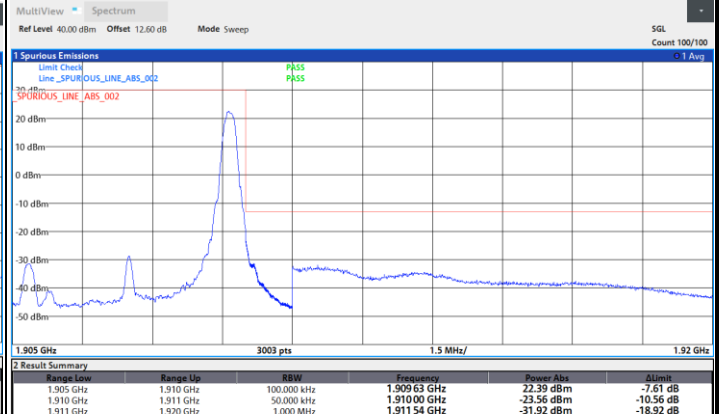
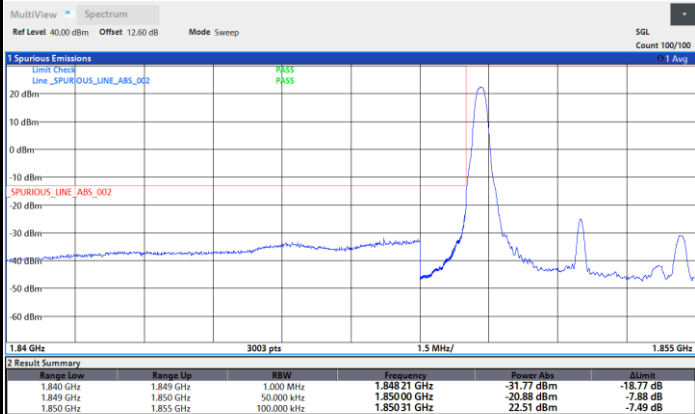

Lowest Band Edge / Full RB

Highest Band Edge / Full RB

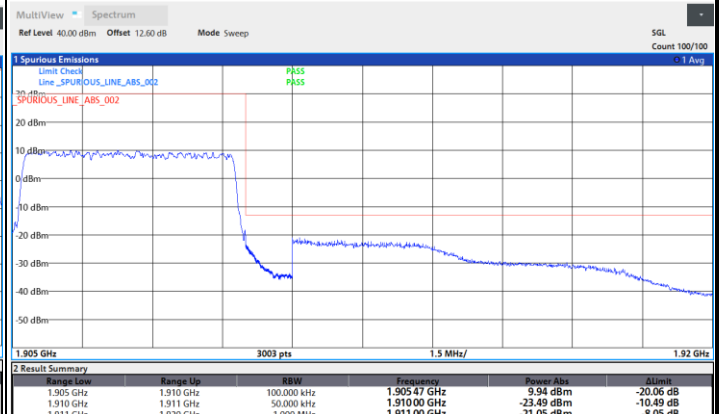
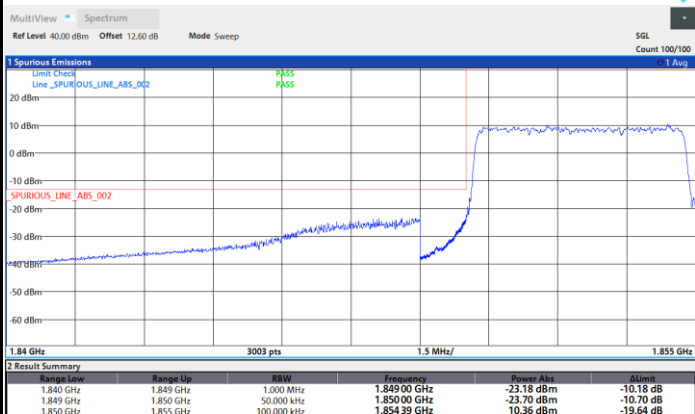



FR1 n2 / 5MHz / DFT-S OFDM / 16QAM

Lowest Band Edge / 1RB0

Highest Band Edge / 1RBmax

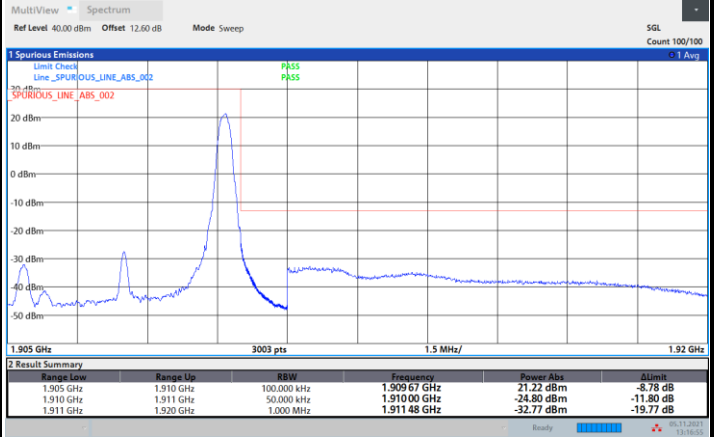
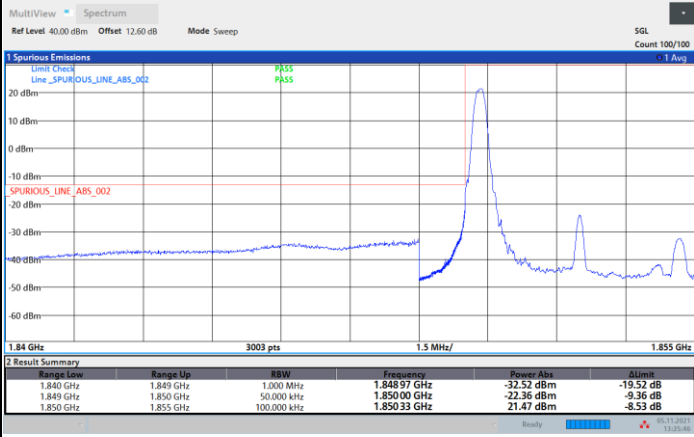

Lowest Band Edge / Full RB

Highest Band Edge / Full RB

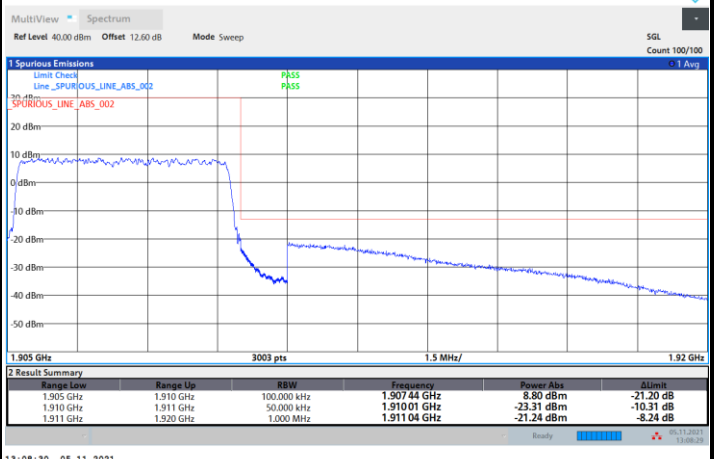
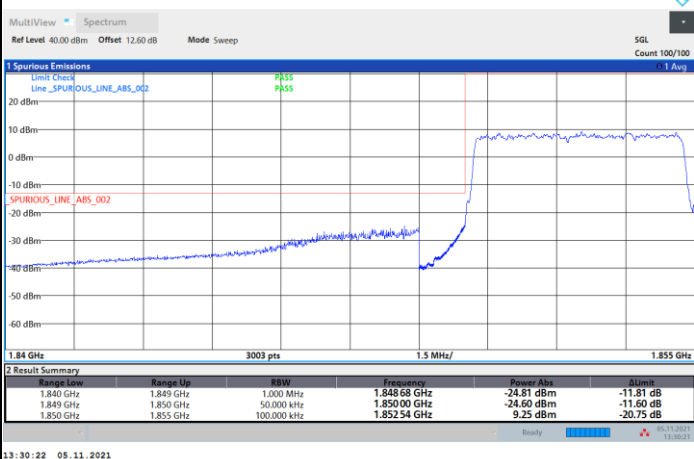



FR1 n2 / 5MHz / DFT-S OFDM / 64QAM

Lowest Band Edge / 1RB0

Highest Band Edge / 1RBmax

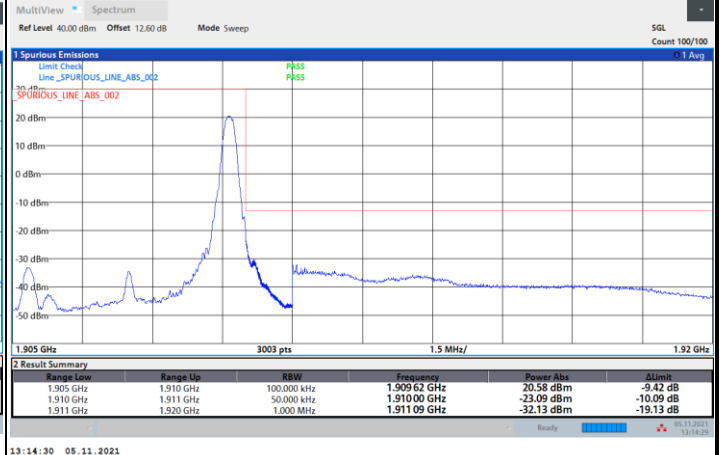
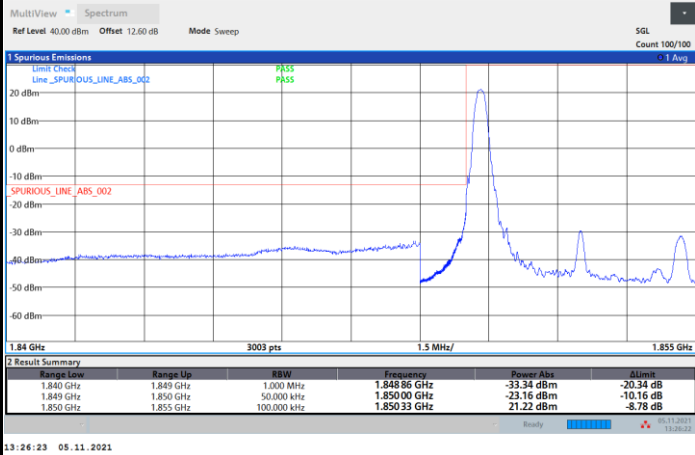

Lowest Band Edge / Full RB

Highest Band Edge / Full RB

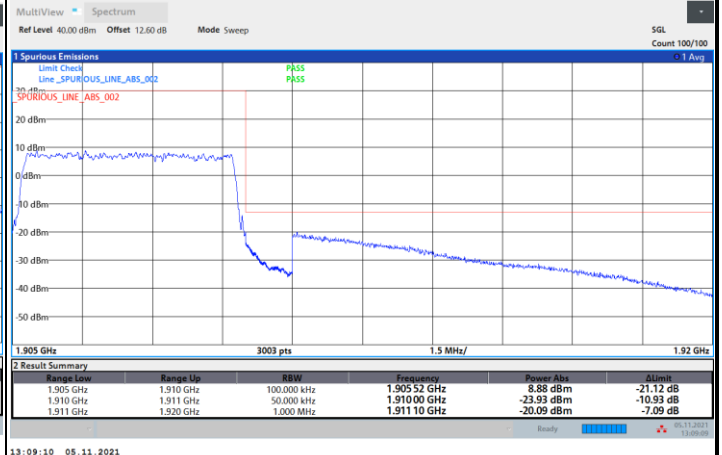
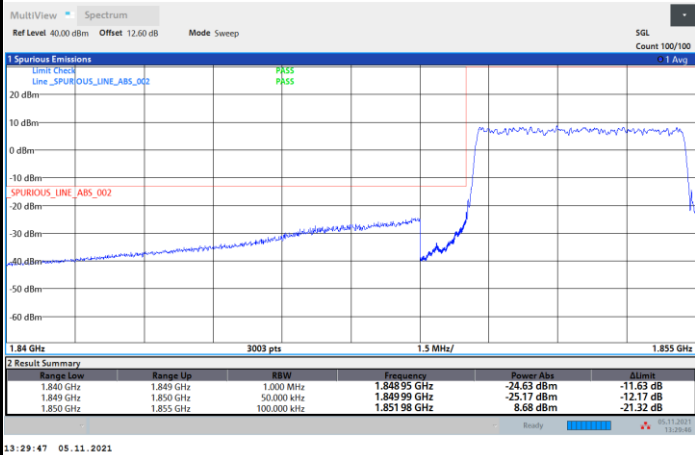



FR1 n2 / 5MHz / DFT-S OFDM / 256QAM

Lowest Band Edge / 1RB0

Highest Band Edge / 1RBmax

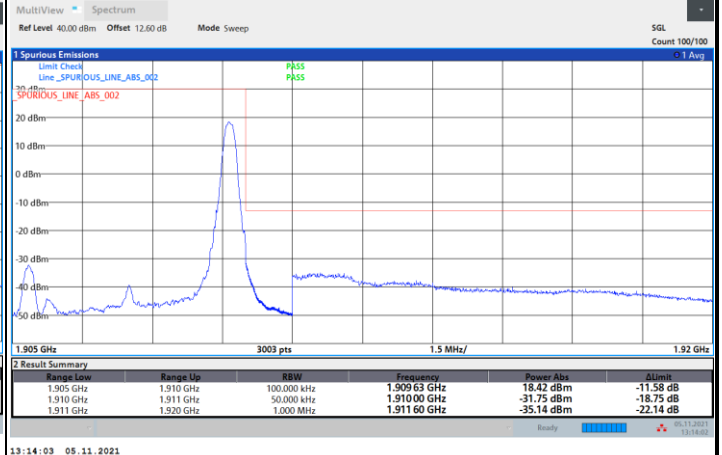
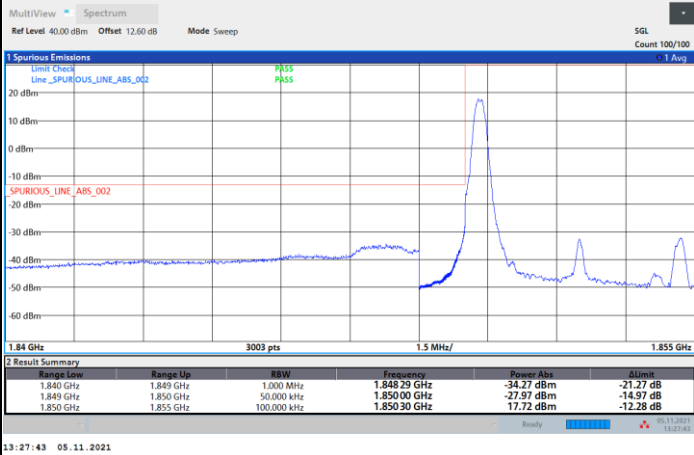

Lowest Band Edge / Full RB

Highest Band Edge / Full RB

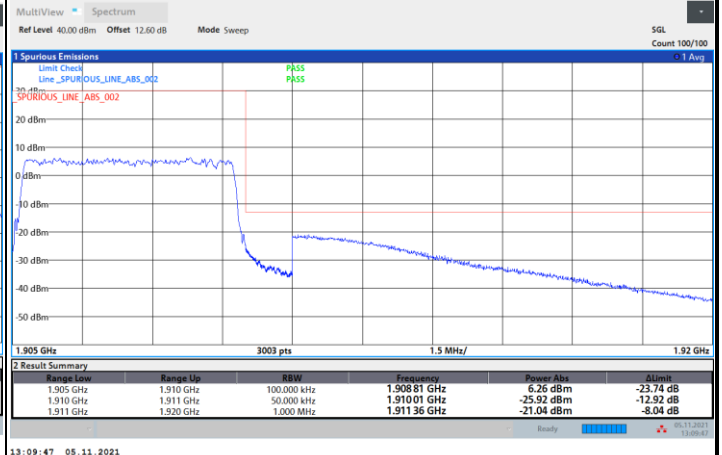
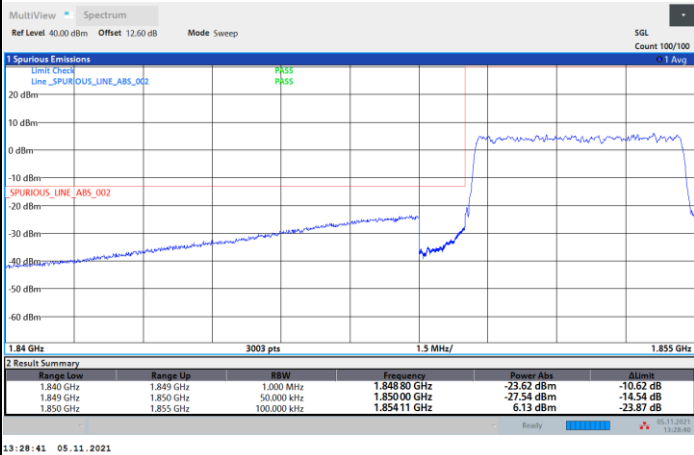



FR1 n2 / 5MHz / CP OFDM / QPSK / Full RB

Lowest Band Edge

Highest Band Edge

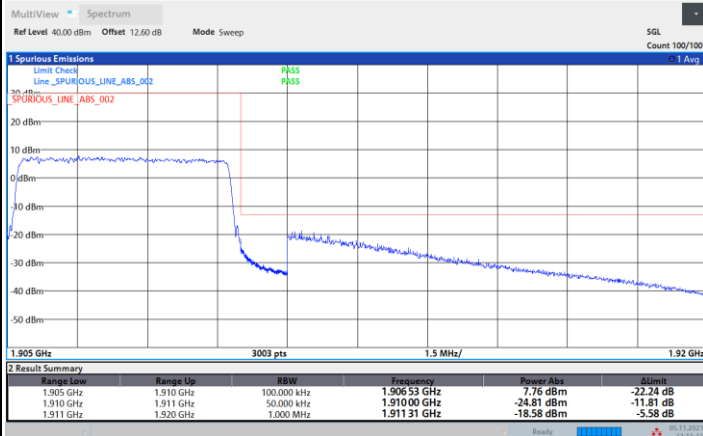
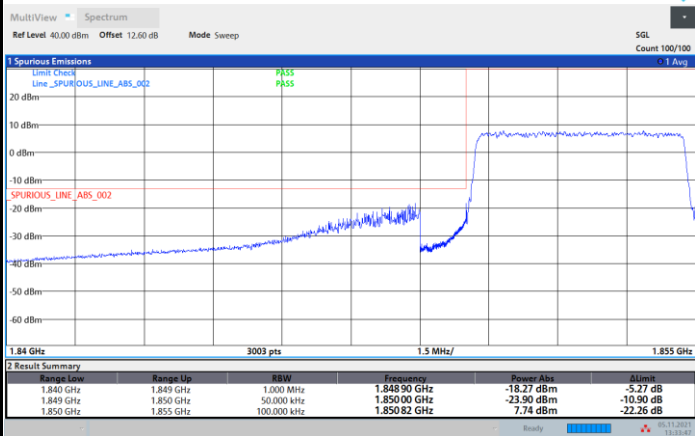

13:33:47 05.11.2021

13:11:14 05.11.2021



FR1 n2 / 10MHz / DFT-s-OFDM / PI/2 BPSK / Full RB

Lowest Band Edge

Highest Band Edge

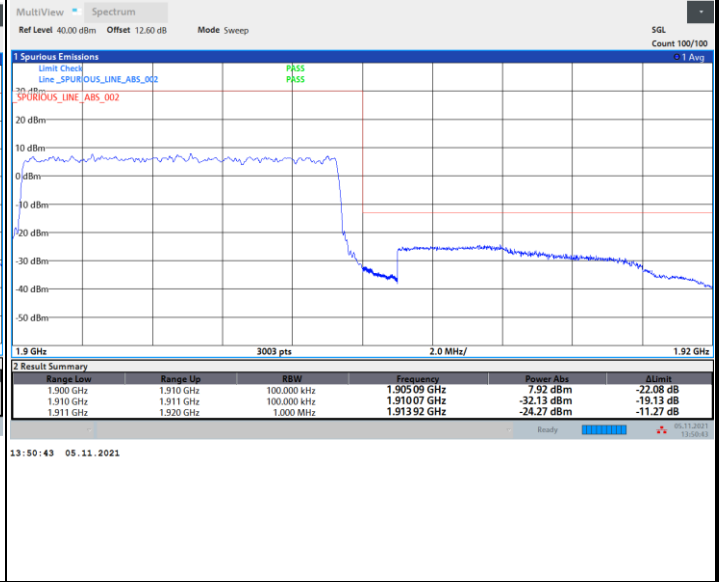
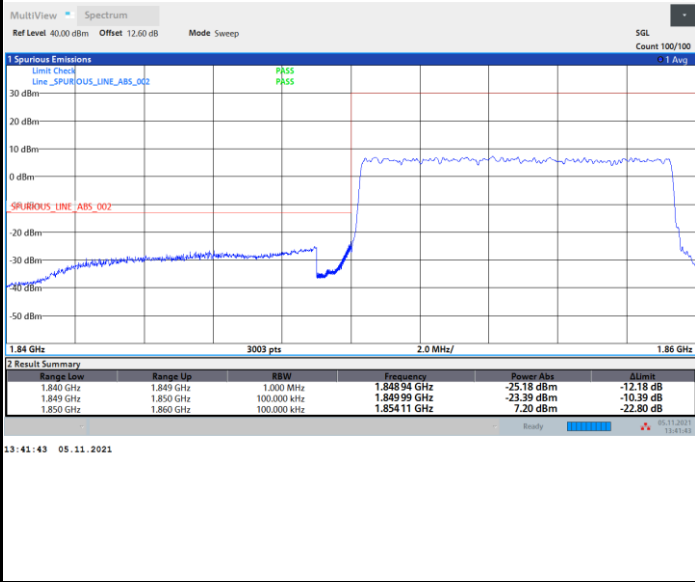



FR1 n2 / 10MHz / DFT-s-OFDM / QPSK / Full RB

Lowest Band Edge

Highest Band Edge

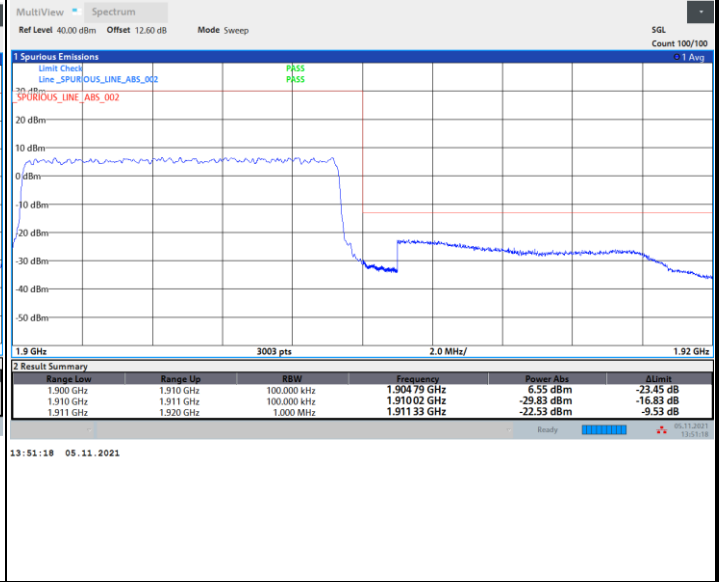
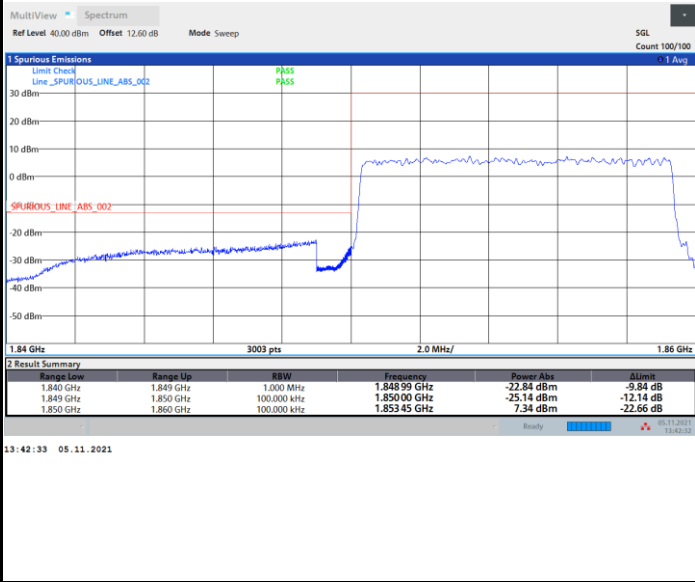

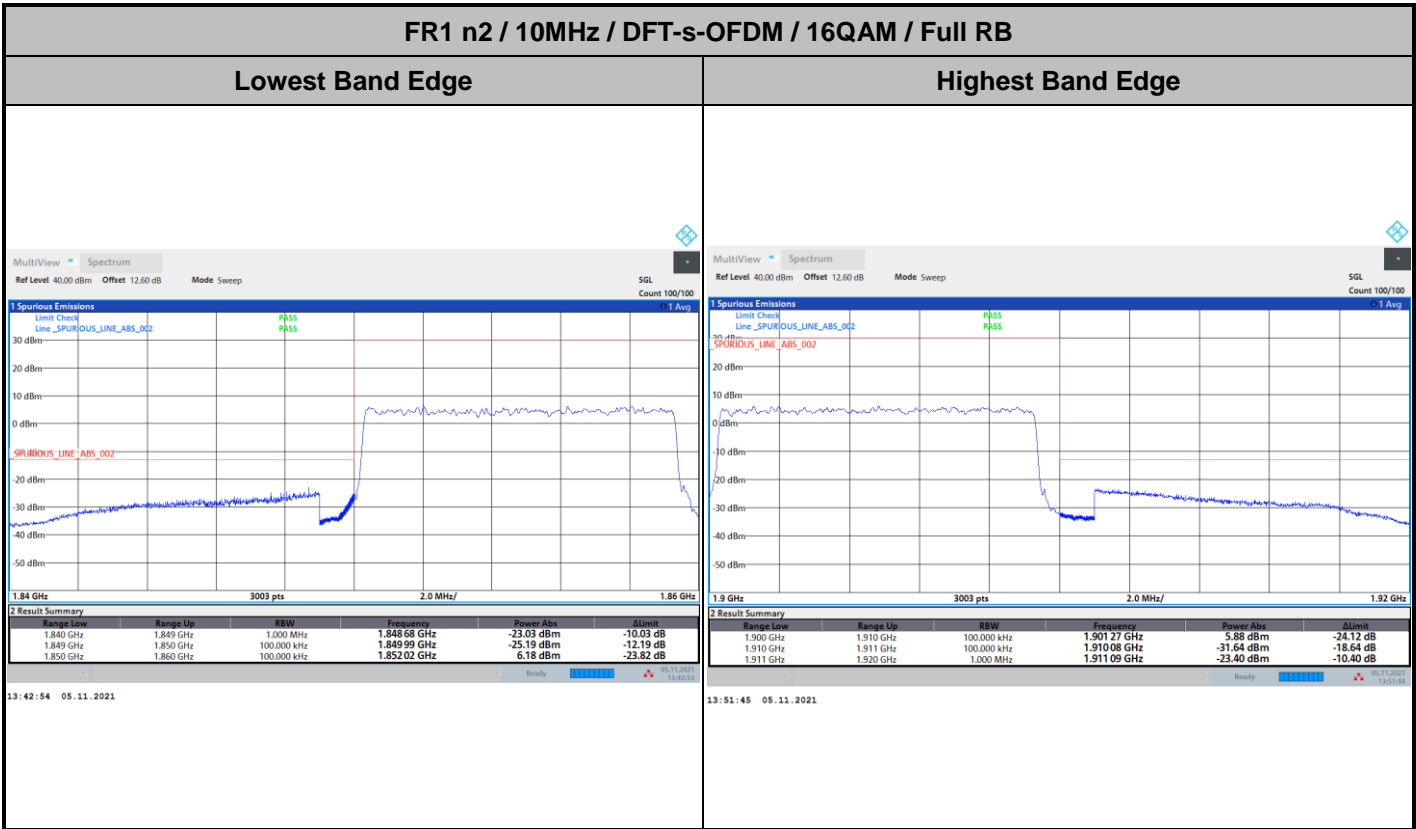



FR1 n2 / 10MHz / DFT-s-OFDM / 64QAM / Full RB

Lowest Band Edge

Highest Band Edge

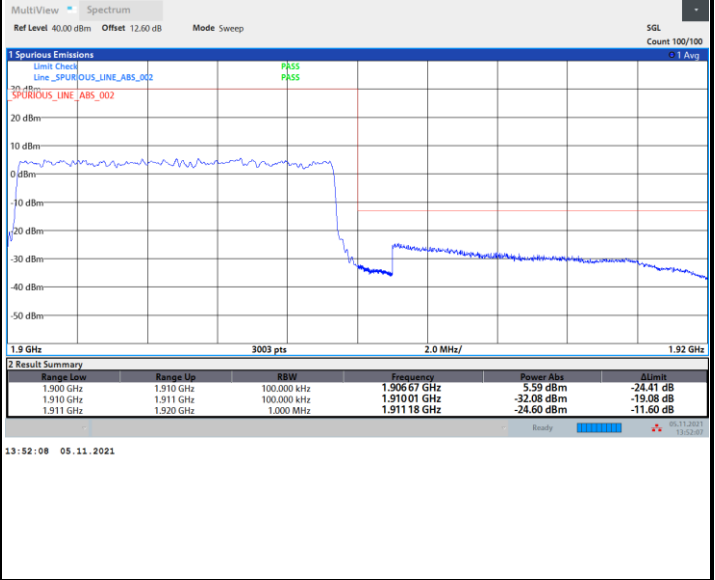
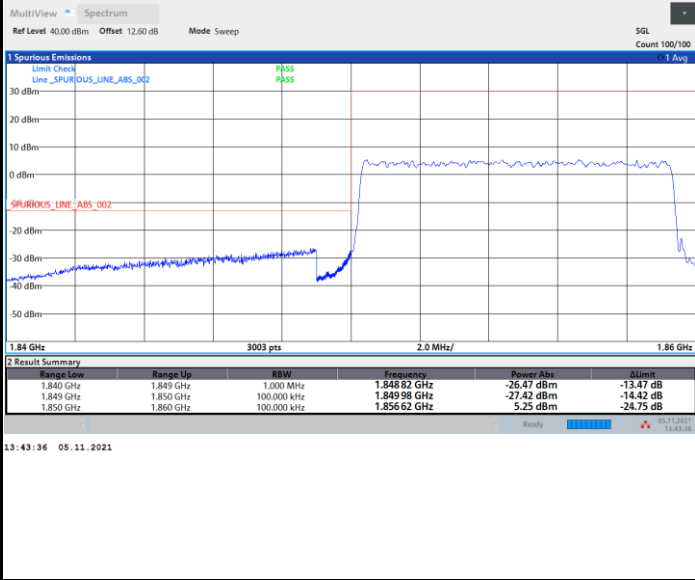



FR1 n2 / 10MHz / DFT-s-OFDM / 256QAM / Full RB

Lowest Band Edge

Highest Band Edge

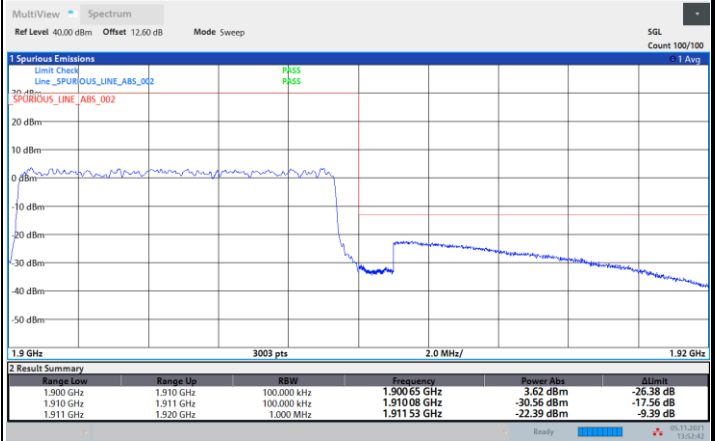
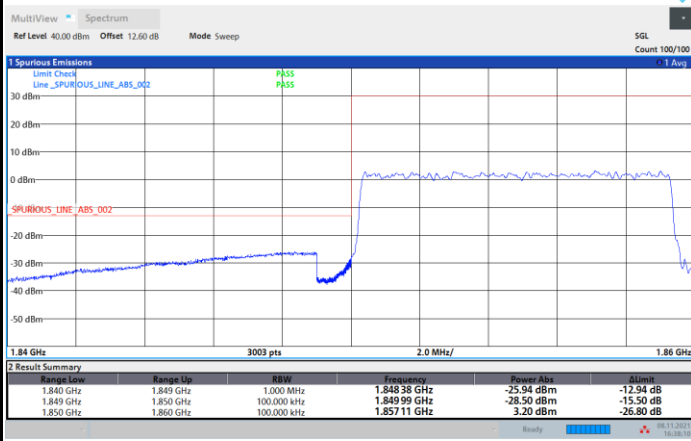



FR1 n2 / 10MHz / CP OFDM / QPSK / Full RB

Lowest Band Edge

Highest Band Edge

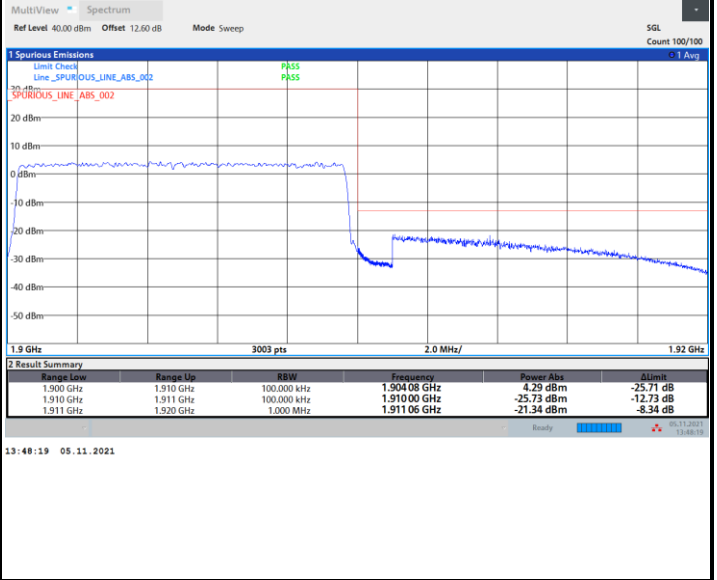
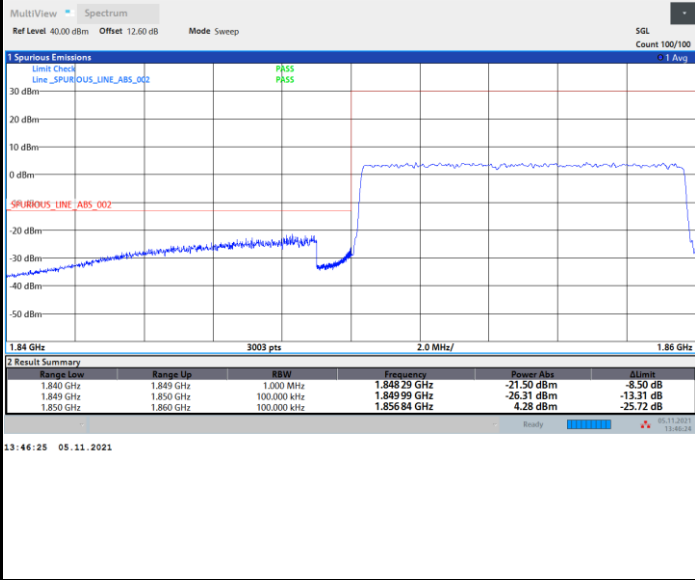



FR1 n2 / 15MHz / DFT-s-OFDM / PI/2 BPSK / Full RB

Lowest Band Edge

Highest Band Edge

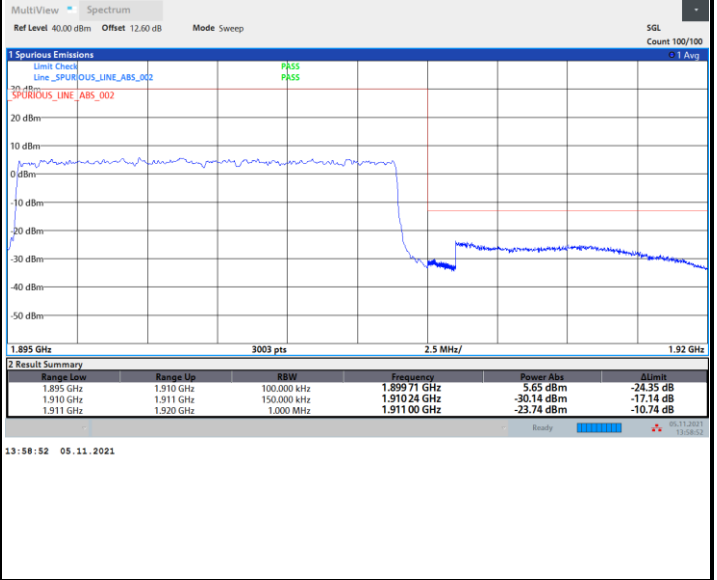
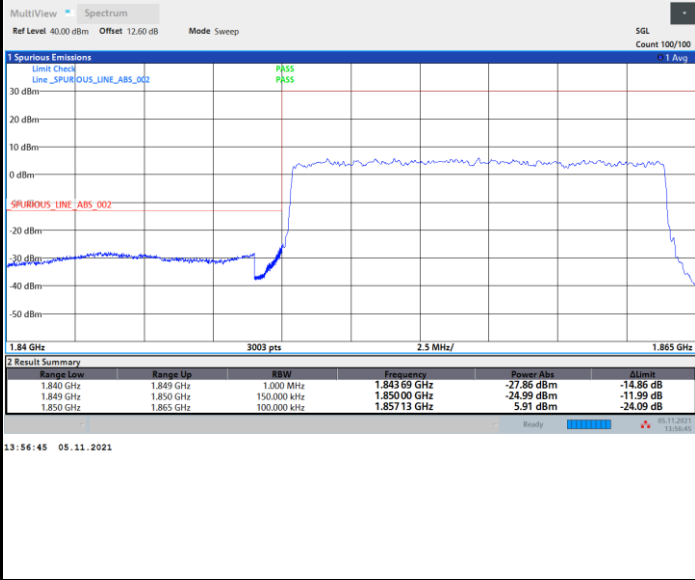



FR1 n2 / 15MHz / DFT-s-OFDM / QPSK / Full RB

Lowest Band Edge

Highest Band Edge

