



FCC RADIO TEST REPORT

FCC ID : A4RGB62Z
Equipment : Phone
Model Name : GB62Z
Applicant : Google LLC
1600 Amphitheatre Parkway,
Mountain View, California, 94043 USA
Standard : FCC 47 CFR Part 2, and 90(S)

The product was received on Oct. 06, 2021 and testing was performed from Nov. 06, 2021 to Dec. 30, 2021. We, Sporton International Inc. EMC & Wireless Communications Laboratory, would like to declare that the tested sample has been evaluated in accordance with the test procedures given in ANSI / TIA-603-E and has been in compliance with the applicable technical standards.

The test results in this report apply exclusively to the tested model / sample. Without written approval of Sporton International Inc. EMC & Wireless Communications Laboratory, the test report shall not be reproduced except in full.

Louis Wu

Approved by: Louis Wu

Sporton International Inc. EMC & Wireless Communications Laboratory

No. 52, Huaya 1st Rd., Guishan Dist., Taoyuan City 333, Taiwan (R.O.C.)



Table of Contents

History of this test report..... 3

Summary of Test Result..... 4

1 General Description 5

 1.1 Feature of Equipment Under Test..... 5

 1.2 Product Specification of Equipment Under Test 6

 1.3 Modification of EUT 6

 1.4 Testing Site..... 7

 1.5 Applied Standards 8

2 Test Configuration of Equipment Under Test 9

 2.1 Test Mode..... 9

 2.2 Connection Diagram of Test System 10

 2.3 Support Unit used in test configuration and system..... 10

 2.4 Measurement Results Explanation Example 10

 2.5 Frequency List of Low/Middle/High Channels..... 11

3 Conducted Test Items..... 12

 3.1 Measuring Instruments..... 12

 3.2 Conducted Output Power Measurement and ERP Measurement 13

 3.3 Peak-to-Average Ratio 14

 3.4 99% Occupied Bandwidth and 26dB Bandwidth Measurement..... 15

 3.5 Emissions Mask Measurement 16

 3.6 Emissions Mask – Out Of Band Emissions Measurement..... 17

 3.7 Frequency Stability Measurement..... 18

 3.8 Field Strength of Spurious Radiation Measurement 19

4 List of Measuring Equipment..... 22

5 Uncertainty of Evaluation 24

Appendix A. Test Results of Conducted Test

Appendix B. Test Results of Radiated Test



Summary of Test Result

Report Clause	Ref Std. Clause	Test Items	Result (PASS/FAIL)	Remark
3.2	§2.1046 §90.635	Conducted Output Power and Effective Radiated Power	Pass	-
3.3	-	Peak-to-Average Ratio	Reporting only	-
3.4	§2.1049 §90.209	Occupied Bandwidth and 26dB Bandwidth	Reporting only	-
3.5	§2.1051 §90.691	Emission masks – In-band emissions	Pass	-
3.6	§2.1051 §90.691	Emission masks – Out of band emissions	Pass	-
3.7	§2.1055 §90.213	Frequency Stability for Temperature & Voltage	Pass	-
3.8	§2.1053 §90.691	Field Strength of Spurious Radiation	Pass	Under limit 36.02 dB at 2450.000 MHz for Primary Antenna Under limit 25.01 dB at 2448.000 MHz for ASDIV Antenna

Declaration of Conformity:
The test results with all measurement uncertainty excluded are presented in accordance with the regulation limits or requirements declared by manufacturers.
Comments and Explanations:
The product specifications of the EUT presented in the report are declared by the manufacturer who shall take full responsibility for the authenticity.

Reviewed by: William Chen
Report Producer: Ruby Zou



1 General Description

1.1 Feature of Equipment Under Test

Product Feature	
Equipment	Phone
Model Name	GB62Z
FCC ID	A4RGB62Z
EUT supports Radios application	GSM/EGPRS/WCDMA/HSPA/LTE/5G NR/NFC/GNSS WLAN 11b/g/n HT20 WLAN 11a/n HT20/HT40 WLAN 11ac VHT20/VHT40/VHT80/VHT160 WLAN 11ax HE20/HE40/HE80/HE160 Bluetooth BR/EDR/LE

Remark: The above EUT's information was declared by manufacturer.

EUT Information List	
S/N	Performed Test Item
19151FQGR00026	Conducted Measurement ERP
1B161FQGR00002	Radiated Spurious Emission



1.2 Product Specification of Equipment Under Test

Product Specification is subject to this standard	
Tx Frequency	814.7 ~ 823.3 MHz
Rx Frequency	859.7 ~ 868.3 MHz
Bandwidth	1.4MHz / 3MHz / 5MHz / 10MHz / 15MHz
Maximum Output Power to Antenna	<Primary Antenna> <Ant. 0>: 24.61 dBm <ASDIV Antenna> <Ant. 1>: 24.45 dBm
Antenna Type	<Primary Antenna> <Ant. 0>: ILA Antenna type <ASDIV Antenna> <Ant. 1>: ILA Antenna type
Type of Modulation	QPSK / 16QAM / 64QAM / 256QAM

<Primary Antenna>

Radio Tech	Band Number	Antenna name	Gain
LTE	B26	Ant. 0	-3.0

<ASDIV Antenna>

Radio Tech	Band Number	Antenna name	Gain
LTE	B26	Ant. 1	-6.9

Remark: The above EUT's information was declared by manufacturer. Please refer to Comments and Explanations in report summary.

1.3 Modification of EUT

No modifications are made to the EUT during all test items.



1.4 Testing Site

Test Site	Sporton International Inc. EMC & Wireless Communications Laboratory
Test Site Location	No.52, Huaya 1st Rd., Guishan Dist., Taoyuan City 333, Taiwan (R.O.C.) TEL: +886-3-327-3456 FAX: +886-3-328-4978
Test Site No.	Sporton Site No.
	TH03-HY
Test Engineer	Benjamin Lin
Temperature (°C)	23.8~25.1
Relative Humidity (%)	48.9~52.6

Test Site	Sporton International Inc. Wensan Laboratory
Test Site Location	No.58, Aly. 75, Ln. 564, Wenhua 3rd, Rd., Guishan Dist., Taoyuan City 333010, Taiwan (R.O.C.) TEL: +886-3-327-0868 FAX: +886-3-327-0855
Test Site No.	Sporton Site No.
	03CH13-HY (TAF Code: 3786)
Test Engineer	Yuan Lee, Jacky Hong and Wilson Wu
Temperature (°C)	20~25
Relative Humidity (%)	50~60
Remark	The Radiated Spurious Emission test item subcontracted to Sporton International Inc. Wensan Laboratory

Note: The test site complies with ANSI C63.4 2014 requirement.

FCC Designation No.: TW1190 and TW3786



1.5 Applied Standards

According to the specifications of the manufacturer, the EUT must comply with the requirements of the following standards:

- ♦ FCC 47 CFR Part 2, 90
- ♦ ANSI / TIA-603-E
- ♦ ANSI C63.26-2015
- ♦ FCC KDB 971168 D01 Power Meas. License Digital Systems v03r01
- ♦ FCC KDB 412172 D01 Determining ERP and EIRP v01r01
- ♦ FCC KDB 414788 D01 Radiated Test Site v01r01
- ♦ Interim Guidance for Equipment Authorization of Devices with Channel Bandwidths Combined Across Two Contiguous Service Rule Allocations OET/Lab/EACB, June 6, 2013

Remark:

1. All test items were verified and recorded according to the standards and without any deviation during the test.
2. This EUT has also been tested and complied with the requirements of FCC Part 15, Subpart B, recorded in a separate test report.
3. The TAF code is not including all the FCC KDB listed without accreditation.



2 Test Configuration of Equipment Under Test

2.1 Test Mode

During all testing, EUT is in link mode with base station emulator at maximum power level.

For radiated measurement, the measured emission level of the EUT was maximized by rotating the EUT on a turntable, adjusting the orientation of the EUT and EUT antenna in three orthogonal axis (X: flat, Y: portrait, Z: landscape), and adjusting the measurement antenna orientation, following C63.26 exploratory test procedures and find Z plane as worst plane.

Frequency range investigated for radiated emission is 30 MHz to 9000 MHz.

Conducted Test Cases	Band	Bandwidth (MHz)						Modulation				RB #			Test Channel		
		1.4	3	5	10	15	20	QPSK	16QAM	64QAM	256QAM	1	Half	Full	L	M	H
Max. Output Power	26	v	v	v	v	v	-	v	v	v	v	v	v	v	v	v	v
Peak-to-Average Ratio	26				v		-	v	v	v	v			v		v	
26dB and 99% Bandwidth	26	v	v	v	v	v	-	v	v	v	v			v	v	v	
Emission masks In-band emissions	26	v	v	v	v	v	-	v	v	v	v	v		v	v		v
Emission masks – Out of band emissions	26	v	v	v	v	v	-	v					v			v	v
Frequency Stability	26				v	v	-	v						v	v	v	
E.R.P.	26	v	v	v	v	v	-	v	v	v	v	Max. Power					
Radiated Spurious Emission	26	Worst Case												v	v	v	
Remark	<ol style="list-style-type: none"> The mark "v" means that this configuration is chosen for testing The mark "-" means that this bandwidth is not supported. LTE Band26 transmit frequency for part22 rule is 824MHz-849MHz, for part90 rule is 814MHz-824MHz. ERP over 15MHz bandwidth complies the ERP limit line of part22 rule, therefore ERP of the partial frequency spectrum which falls within part 22 also complies. All the radiated test cases were performed with Adapter 1 and USB Cable 2. 																

2.2 Connection Diagram of Test System

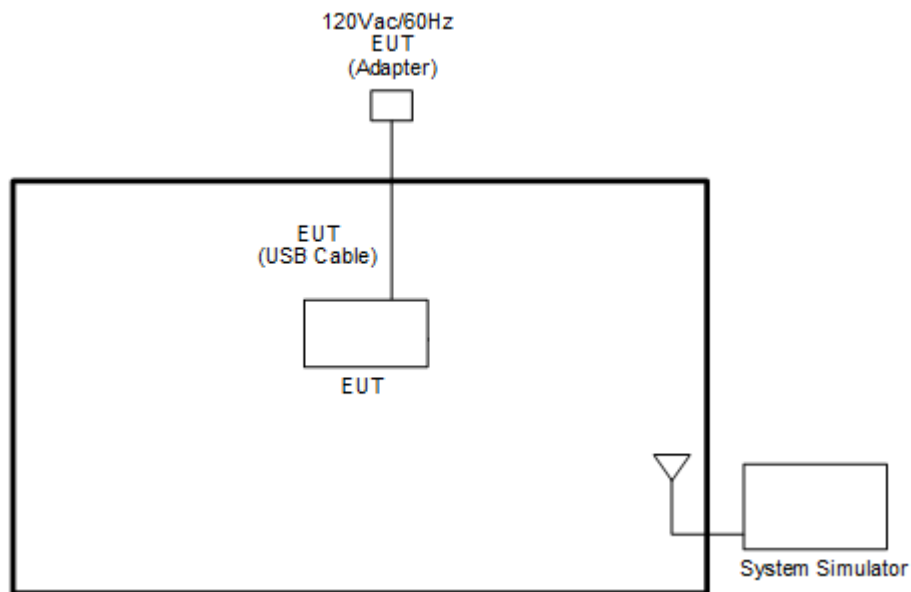

2.3 Support Unit used in test configuration and system

Item	Equipment	Brand Name	Model No.	FCC ID	Data Cable	Power Cord
1.	System Simulator	Anritsu	MT8820C	N/A	N/A	Unshielded, 1.8 m
2.	System Simulator	Anritsu	MT8821C	N/A	N/A	Unshielded, 1.8 m

2.4 Measurement Results Explanation Example

For all conducted test items:

The offset level is set in the spectrum analyzer to compensate the RF cable loss and attenuator factor between RF conducted output port and spectrum analyzer. With the offset compensation, the spectrum analyzer reading level will be exactly the RF output level.

The spectrum analyzer offset is derived from RF cable loss and attenuator factor.

Offset = RF cable loss + attenuator factor.

The following shows an offset computation example with RF cable loss 4.2 dB and a 10dB attenuator.

Example :

$$\begin{aligned} \text{Offset(dB)} &= \text{RF cable loss(dB)} + \text{attenuator factor(dB)} \\ &= 4.2 + 10 = 14.2 \text{ (dB)} \end{aligned}$$



2.5 Frequency List of Low/Middle/High Channels

LTE Band 26 Channel and Frequency List				
BW [MHz]	Channel/Frequency(MHz)	Lowest	Middle	Highest
15	Channel	26765	-	-
	Frequency	821.5	-	-
10	Channel	-	26740	-
	Frequency	-	819	-
5	Channel	26715	26740	26765
	Frequency	816.5	819	821.5
3	Channel	26705	26740	26775
	Frequency	815.5	819	822.5
1.4	Channel	26697	26740	26783
	Frequency	814.7	819	823.3

LTE Band 26 Channel and Frequency List				
BW [MHz]	Channel/Frequency(MHz)	-	cross-rule channels	-
15	Channel	-	26790	-
	Frequency	-	824	-
10	Channel	-	26790	-
	Frequency	-	824	-
5	Channel	-	26790	-
	Frequency	-	824	-
3	Channel	-	26790	-
	Frequency	-	824	-
1.4	Channel	-	26790	-
	Frequency	-	824	-

3 Conducted Test Items

3.1 Measuring Instruments

See list of measuring instruments of this test report.

3.1.1 Test Setup

3.1.2 Conducted Output Power

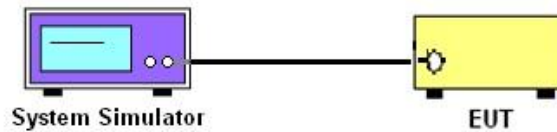

3.1.3 Peak-to-Average Ratio, Occupied Bandwidth, Conducted Band-Edge, Emission Mask, Emissions Mask – Out Of Band Emissions, and Conducted Spurious Emission

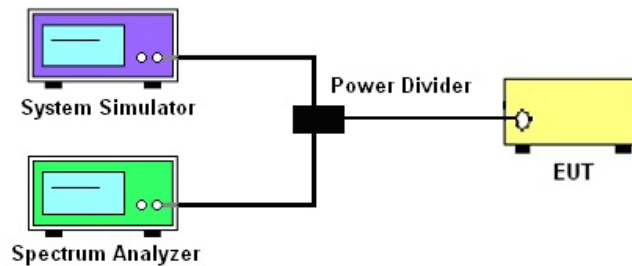

3.1.4 Frequency Stability

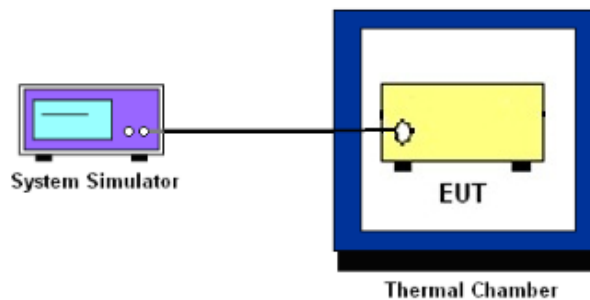

3.1.5 Test Result of Conducted Test

Please refer to Appendix A.



3.2 Conducted Output Power Measurement and ERP Measurement

3.2.1 Description of the Conducted Output Power Measurement and ERP Measurement

A system simulator was used to establish communication with the EUT. Its parameters were set to enforce EUT transmitting at the maximum power. The measured power in the radio frequency on the transmitter output terminals shall be reported.

The conducted output power of mobile transmitters must not exceed 100 Watts for LTE Band 26.

According to KDB 412172 D01 Power Approach,

$EIRP = P_T + G_T - L_C$, where

P_T = transmitter output power in dBm

G_T = gain of the transmitting antenna in dBi

L_C = signal attenuation in the connecting cable between the transmitter and antenna in dB

3.2.2 Test Procedures

1. The transmitter output port was connected to the system simulator.
2. Set EUT at maximum power through system simulator.
3. Select lowest, middle, and highest channels for each band and different modulation.
4. Measure and record the power level from the system simulator.



3.3 Peak-to-Average Ratio

3.3.1 Description of the PAR Measurement

Reporting only

3.3.2 Test Procedures

1. The EUT was connected to spectrum and system simulator via a power divider.
2. Set the CCDF (Complementary Cumulative Distribution Function) option in spectrum analyzer.
3. The highest RF powers were measured and recorded the maximum PAPR level associated with a probability of 0.1 %.
4. Record the deviation as Peak to Average Ratio.



3.4 99% Occupied Bandwidth and 26dB Bandwidth Measurement

3.4.1 Description of (Occupied) Bandwidth Limitations Measurement

The 99% occupied bandwidth is the width of a frequency band such that, below the lower and above the upper frequency limits, the mean powers emitted are each equal to a specified percentage 0.5% of the total mean transmitted power.

The emission bandwidth is defined as the width of the signal between two points, located at the 2 sides of the carrier frequency, outside of which all emissions are attenuated at least 26 dB below the transmitter power.

3.4.2 Test Procedures

1. The EUT was connected to spectrum analyzer and system simulator via a power divider.
2. The 26dB and 99% occupied bandwidth (BW) of the middle channel for the highest RF power with full RB sizes were measured.



3.5 Emissions Mask Measurement

3.5.1 Description of Emissions Mask Measurement

Equipment used in this licensed to EA or non-EA systems shall comply with the emission mask provisions of FCC Part 90.691.(a)

(a) Out-of-band emission requirement shall apply only to the “outer” channels included in an EA license and to spectrum adjacent to interior channels used by incumbent licensees. The emission limits are as follows:

(1) For any frequency removed from the EA licensee's frequency block by up to and including 37.5 kHz, the power of any emission shall be attenuated below the transmitter power (P) in watts by at least $116 \text{Log}_{10}(f/6.1)$ decibels or $50 + 10 \text{Log}_{10}(P)$ decibels or 80 decibels, whichever is the lesser attenuation, where f is the frequency removed from the center of the outer channel in the block in kilohertz and where f is greater than 12.5 kHz.

(2) For any frequency removed from the EA licensee's frequency block greater than 37.5 kHz, the power of any emission shall be attenuated below the transmitter power (P) in watts by at least $43 + 10\text{Log}_{10}(P)$ decibels or 80 decibels, whichever is the lesser attenuation, where f is the frequency removed from the center of the outer channel in the block in kilohertz and where f is greater than 37.5 kHz.

3.5.2 Test Procedures

1. The EUT was connected to spectrum analyzer and base station via power divider.
2. The emissions mask of low and high channels for the highest RF powers were measured.
3. Set RBW and VBW 3 times of RBW to make the measurement with the spectrum analyzer's, and according to KDB 971168 D02 Misc Rev Approve License Devices v02r01 standards, set RBW = 300 Hz to make offsets less than 37.5 kHz from a channel edge , RBW = 100 kHz to make offsets greater than 37.5 kHz, that is allowed.
4. The test results were shown below plots with a correction offset factor including cable loss, insertion loss of power divider.



3.6 Emissions Mask – Out Of Band Emissions Measurement

3.6.1 Description of Conducted Emissions Out of band emissions measurement

The power of any emission FCC Part 90.691 (a)(2) on any frequency removed from the assigned frequency by out of the authorized bandwidth at least $43 + 10 \log (P)$ dB. It is measured by means of a calibrated spectrum analyzer and scanned from 30 MHz up to a frequency including its 10th harmonic.

3.6.2 Test Procedures

1. The EUT was connected to spectrum analyzer and system simulator via a power divider.
2. The RF output of EUT was connected to the spectrum analyzer by RF cable and attenuator. The path loss was compensated to the results for each measurement.
3. The middle channel for the highest RF power within the transmitting frequency was measured.
4. The conducted spurious emission for the whole frequency range was taken.
5. For testing below 1GHz, make the measurement with the spectrum analyzer's RBW = 100 kHz, VBW = 3MHz, taking the record of maximum spurious emission.
6. For testing above 1GHz, make the measurement with the spectrum analyzer's RBW = 1MHz, VBW = 3MHz, taking the record of maximum spurious emission.
7. The RF fundamental frequency should be excluded against the limit line in the operating frequency band.
8. The limit line is derived from $43 + 10\log(P)$ dB below the transmitter power P(Watts)



3.7 Frequency Stability Measurement

3.7.1 Description of Frequency Stability Measurement

The frequency stability shall be sufficient to ensure that the fundamental emission stays within the authorized frequency block.

3.7.2 Measuring Instruments

The measuring equipment is listed in the section 4 of this test report.

3.7.3 Test Procedures for Temperature Variation

1. The EUT was set up in the thermal chamber and connected with the base station.
2. With power OFF, the temperature was decreased to -30°C and the EUT was stabilized for three hours. Power was applied and the maximum change in frequency was recorded within one minute.
3. With power OFF, the temperature was raised in 10°C step up to 50°C. The EUT was stabilized at each step for at least half an hour. Power was applied and the maximum frequency change was recorded within one minute.

3.7.4 Test Procedures for Voltage Variation

1. The EUT was placed in a temperature chamber at 20±5° C and connected with the base station.
2. The power supply voltage to the EUT was varied from BEP to 115% of the nominal value measured at the input to the EUT.
3. The variation in frequency was measured for the worst case.



3.8 Field Strength of Spurious Radiation Measurement

3.8.1 Description of Field Strength of Spurious Radiated Measurement

The radiated spurious emission was measured by substitution method according to ANSI / TIA-603-E. The power of any emission FCC Part 90.691 on any frequency removed from the assigned frequency by more than 250 percent of the authorized bandwidth at least $43 + 10 \log (P)$ dB. The spectrum is scanned from 30 MHz up to a frequency including its 10th harmonic.

The power of any emission outside of the authorized operating frequency ranges must be attenuated below the transmitter power (P) by a factor of at least $43+10\log_{10}(P[\text{Watts}])$ dB. The spectrum is scanned from 30 MHz up to a frequency including its 10th harmonic.

3.8.2 Test Procedures

1. The EUT was placed on a turntable with 0.8 meter for frequency below 1GHz and 1.5 meter for frequency above 1GHz respectively above ground.
2. The EUT was set 3 meters from the receiving antenna, which was mounted on the antenna tower.
3. The table was rotated 360 degrees to determine the position of the highest spurious emission.
4. The height of the receiving antenna is varied between one meter and four meters to search the maximum spurious emission for both horizontal and vertical polarizations.
5. For testing below 1GHz, make the measurement with the spectrum analyzer's RBW = 100 kHz, VBW = 3MHz, Sweep = 500ms, Taking the record of maximum spurious emission.
6. For testing above 1GHz, make the measurement with the spectrum analyzer's RBW = 1MHz, VBW = 3MHz, Sweep = 500ms, Taking the record of maximum spurious emission.
7. A horn antenna was substituted in place of the EUT and was driven by a signal generator.
8. Tune the output power of signal generator to the same emission level with EUT maximum spurious emission.
9. Taking the record of output power at antenna port.
10. Repeat step 7 to step 8 for another polarization.
11. $\text{EIRP (dBm)} = \text{S.G. Power} - \text{Tx Cable Loss} + \text{Tx Antenna Gain}$
12. $\text{ERP (dBm)} = \text{EIRP} - 2.15$
13. The RF fundamental frequency should be excluded against the limit line in the operating frequency band.
14. The limit line is derived from $43 + 10\log(P)$ dB below the transmitter power P(Watts)

3.8.3 Test Setup

For radiated test below 30MHz

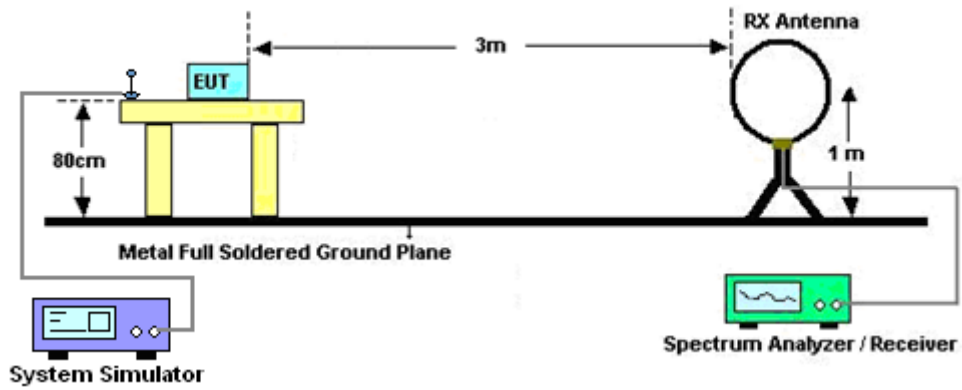

For radiated test from 30MHz to 1GHz

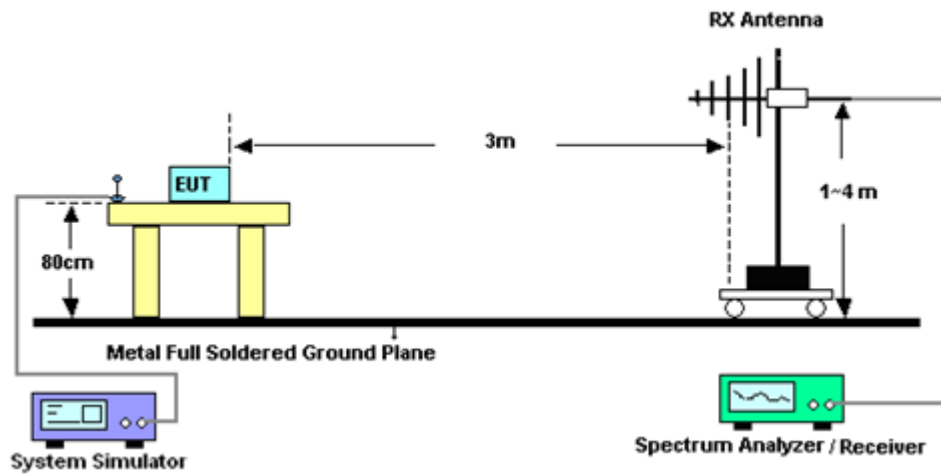

For radiated test above 1GHz

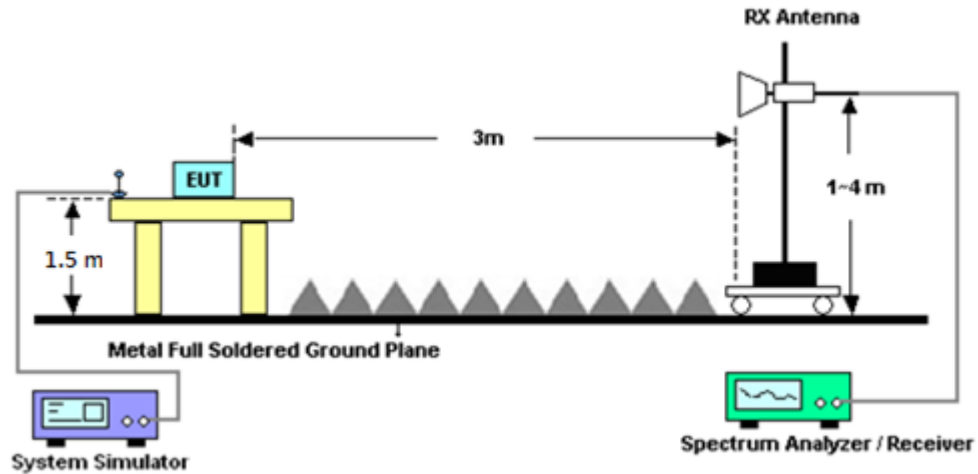

3.8.4 Test Result of Field Strength of Spurious Radiated

Please refer to Appendix B.

Note:

The low frequency, which started from 9 kHz to 30MHz, was pre-scanned and the result which was 20dB lower than the limit line was not reported.

There is adequate comparison measurement of both open-field test site and alternative test site - semi-Anechoic chamber according to 414788 D01 Radiated Test Site v01r01, and the result came out very similar.



4 List of Measuring Equipment

Instrument	Brand Name	Model No.	Serial No.	Characteristics	Calibration Date	Test Date	Due Date	Remark
Amplifier	Sonoma-Instrument	310 N	187282	9KHz~1GHz	Dec. 16, 2020	Nov. 27, 2021~Dec. 14, 2021	Dec. 15, 2021	Radiation (03CH13-HY)
Amplifier	Sonoma-Instrument	310 N	187282	9KHz~1GHz	Dec. 15, 2021	Dec. 15, 2021~Dec. 30, 2021	Dec. 14, 2022	Radiation (03CH13-HY)
Bilog Antenna	TESEQ	CBL 6111D&00800 N1D01N-06	40103 & 07	30MHz to 1GHz	Apr. 28, 2021	Nov. 27, 2021~Dec. 30, 2021	Apr. 27, 2022	Radiation (03CH13-HY)
Bilog Antenna	TESEQ	CBL 6111D&00800 N1D01N-06	41912 & 05	30MHz to 1GHz	Feb. 08, 2021	Nov. 27, 2021~Dec. 30, 2021	Feb. 07, 2022	Radiation (03CH13-HY)
Horn Antenna	SCHWARZBECK	BBHA 9120 D	9120D-121 2	1GHz ~ 18GHz	May 18, 2021	Nov. 27, 2021~Dec. 30, 2021	May 17, 2022	Radiation (03CH13-HY)
Horn Antenna	SCHWARZBECK	BBHA 9120 D	9120D-124 1	1GHz ~ 18GHz	Jul. 13, 2021	Nov. 27, 2021~Dec. 30, 2021	Jul. 12, 2022	Radiation (03CH13-HY)
Loop Antenna	Rohde & Schwarz	HFH2-Z2	100488	9 kHz~30 MHz	Sep. 07, 2021	Nov. 27, 2021~Dec. 30, 2021	Sep. 06, 2022	Radiation (03CH13-HY)
Preamplifier	MITEQ	AMF-7D-00101 800-30-10P	1590074	1GHz~18GHz	May 18, 2021	Nov. 27, 2021~Dec. 30, 2021	May 17, 2022	Radiation (03CH13-HY)
Preamplifier	Keysight	83017A	MY532701 47	1GHz~26.5GHz	Oct. 26, 2021	Nov. 27, 2021~Dec. 30, 2021	Oct. 25, 2022	Radiation (03CH13-HY)
Signal Generator	Anritsu	MG3694C	163401	0.1Hz~40GHz	Jan. 31, 2021	Nov. 27, 2021~Dec. 30, 2021	Jan. 30, 2022	Radiation (03CH13-HY)
Spectrum Analyzer	Keysight	N9010A	MY553705 26	10Hz~44GHz	Mar. 18, 2021	Nov. 27, 2021~Dec. 30, 2021	Mar. 17, 2022	Radiation (03CH13-HY)
Controller	EMEC	EM1000	N/A	Control Turn table & Ant Mast	N/A	Nov. 27, 2021~Dec. 30, 2021	N/A	Radiation (03CH13-HY)
Antenna Mast	EMEC	AM-BS-4500-B	N/A	1m~4m	N/A	Nov. 27, 2021~Dec. 30, 2021	N/A	Radiation (03CH13-HY)
Turn Table	EMEC	TT2000	N/A	0~360 Degree	N/A	Nov. 27, 2021~Dec. 30, 2021	N/A	Radiation (03CH13-HY)
Software	Audix	E3 6.2009-8-24	RK-00099 2	N/A	N/A	Nov. 27, 2021~Dec. 30, 2021	N/A	Radiation (03CH13-HY)
Preamplifier	EMEC	EM18G40G	060801	18GHz ~ 40GHz	Jun. 22, 2021	Nov. 27, 2021~Dec. 30, 2021	Jun. 21, 2022	Radiation (03CH13-HY)
RF Cable	HUBER + SUHNER	SUCOFLEX 126E	0030/126E	30M-18G	Feb. 10, 2021	Nov. 27, 2021~Dec. 30, 2021	Feb. 09, 2022	Radiation (03CH13-HY)
RF Cable	HUBER + SUHNER	SUCOFLEX 104	804793/4	30M-18G	Feb. 10, 2021	Nov. 27, 2021~Dec. 30, 2021	Feb. 09, 2022	Radiation (03CH13-HY)
RF Cable	HUBER + SUHNER	SUCOFLEX 102	505134/2	30M~40GHz	Feb. 22, 2021	Nov. 27, 2021~Dec. 30, 2021	Feb. 21, 2022	Radiation (03CH13-HY)
RF Cable	HUBER + SUHNER	SUCOFLEX 102	MY4274/2	30MHz~40GHz	Mar. 11, 2021	Nov. 27, 2021~Dec. 30, 2021	Mar. 10, 2022	Radiation (03CH13-HY)
RF Cable	HUBER + SUHNER	SUCOFLEX 104	MY24961/ 4	30M-18G	Feb. 10, 2021	Nov. 27, 2021~Dec. 30, 2021	Feb. 09, 2022	Radiation (03CH13-HY)
RF Cable	HUBER + SUHNER	SUCOFLEX 104	MY9837/4 PE	9kHz~30MHz	Mar. 11, 2021	Nov. 27, 2021~Dec. 30, 2021	Mar. 10, 2022	Radiation (03CH13-HY)
SHF-EHF Horn Antenna	SCHWARZBECK	BBHA 9170	BBHA9170 576	18GHz- 40GHz	May 21, 2021	Nov. 27, 2021~Dec. 30, 2021	May 20, 2022	Radiation (03CH13-HY)
SHF-EHF Horn Antenna	SCHWARZBECK	BBHA 9170	BBHA9170 980	18GHz- 40GHz	Jan. 11, 2021	Nov. 27, 2021~Dec. 30, 2021	Jan. 10, 2022	Radiation (03CH13-HY)
Filter	Wainwright	WHKX12-2700 -3000-18000-6 0SS	SN2	3GHz High Pass Filter	Jul. 12, 2021	Nov. 27, 2021~Dec. 30, 2021	Jul. 11, 2022	Radiation (03CH13-HY)
Filter	Wainwright	WHKX12-1080 -1200-15000-6 0SS	SN3	1.2GHz High Pass Filter	Jul. 01, 2021	Nov. 27, 2021~Dec. 30, 2021	Jun. 30, 2022	Radiation (03CH13-HY)
Hygrometer	TECPEL	DTM-303B	TP161243	N/A	Sep. 02, 2021	Nov. 27, 2021~Dec. 30, 2021	Sep. 01, 2022	Radiation (03CH13-HY)



Instrument	Brand Name	Model No.	Serial No.	Characteristics	Calibration Date	Test Date	Due Date	Remark
Radio Communication Analyzer	Anritsu	MT8821C	620166475 5	2/3/4G/LTE FDD/TDD with44)/LTE-3C C DLCA/2CC ULCA, CatM1/NB1/NB2	Jul. 21, 2021	Nov. 06, 2021~ Dec. 08, 2021	Jul. 20, 2022	Conducted (TH03-HY)
Spectrum Analyzer	Rohde & Schwarz	FSV40	101909	10Hz~40GHz	Aug. 13, 2021	Nov. 06, 2021~ Dec. 08, 2021	Aug. 12, 2022	Conducted (TH03-HY)
Thermal Chamber	ESPEC	SH-641	92013720	-40°C ~-90°C	Sep. 09, 2021	Nov. 06, 2021~ Dec. 08, 2021	Sep. 08, 2022	Conducted (TH03-HY)
Programmable Power Supply	GW Instek	PSS-2005	EL890001	1V~20V 0.5A~5A	Oct. 06, 2021	Nov. 06, 2021~ Dec. 08, 2021	Oct. 05, 2022	Conducted (TH03-HY)
Coupler	Warison	20dB 25W SMA Directional Coupler	#B	1-18GHz	Jan. 09, 2021	Nov. 06, 2021~ Dec. 08, 2021	Jan. 08, 2022	Conducted (TH03-HY)



5 Uncertainty of Evaluation

Uncertainty of Radiated Emission Measurement (30 MHz ~ 1000 MHz)

Measuring Uncertainty for a Level of Confidence of 95% ($U = 2Uc(y)$)	3.45 dB
---	---------

Uncertainty of Radiated Emission Measurement (1 GHz ~ 18 GHz)

Measuring Uncertainty for a Level of Confidence of 95% ($U = 2Uc(y)$)	3.73 dB
---	---------



Appendix A. Test Results of Conducted Test

Conducted Output Power(Average power & ERP)

<Primary Antenna>

LTE Band 26 Maximum Average Power [dBm] (GT - LC = -3 dB)								
BW [MHz]	RB Size	RB Offset	Mod	Lowest	Middle	Highest	ERP (dBm)	ERP (W)
15	1	0	QPSK	24.61	-	-	19.46	0.0883
15	1	37		24.54	-	-		
15	1	74		24.51	-	-		
15	36	0		23.63	-	-		
15	36	20		23.60	-	-		
15	36	39		23.57	-	-		
15	75	0		23.58	-	-		
15	1	0	16-QAM	23.86	-	-	18.71	0.0743
15	1	37		23.82	-	-		
15	1	74		23.86	-	-		
15	36	0		22.60	-	-		
15	36	20		22.60	-	-		
15	36	39		22.60	-	-		
15	75	0		22.60	-	-		
15	1	0	64-QAM	22.68	-	-	17.65	0.0582
15	1	37		22.70	-	-		
15	1	74		22.80	-	-		
15	36	0		21.62	-	-		
15	36	20		21.63	-	-		
15	36	39		21.67	-	-		
15	75	0		21.64	-	-		
15	1	0	256-QAM	19.77	-	-	14.62	0.0290
15	1	37		19.72	-	-		
15	1	74		19.75	-	-		
15	36	0		19.73	-	-		
15	36	20		19.72	-	-		
15	36	39		19.71	-	-		
15	75	0		19.73	-	-		
Limit	Output Power < 100W			Result			Pass	



LTE Band 26 Maximum Average Power [dBm] (GT - LC = -3 dB)								
BW [MHz]	RB Size	RB Offset	Mod	Lowest	Middle	Highest	ERP (dBm)	ERP (W)
10	1	0	QPSK	-	24.56	-	19.41	0.0873
10	1	25		-	24.43	-		
10	1	49		-	24.51	-		
10	25	0		-	23.58	-		
10	25	12		-	23.57	-		
10	25	25		-	23.55	-		
10	50	0		-	23.58	-		
10	1	0	16-QAM	-	23.90	-	18.75	0.0750
10	1	25		-	23.83	-		
10	1	49		-	23.82	-		
10	25	0		-	22.58	-		
10	25	12		-	22.60	-		
10	25	25		-	22.56	-		
10	50	0		-	22.62	-		
10	1	0	64-QAM	-	22.83	-	17.68	0.0586
10	1	25		-	22.76	-		
10	1	49		-	22.78	-		
10	25	0		-	21.61	-		
10	25	12		-	21.60	-		
10	25	25		-	21.64	-		
10	50	0		-	21.68	-		
10	1	0	256-QAM	-	19.89	-	14.74	0.0298
10	1	25		-	19.83	-		
10	1	49		-	19.74	-		
10	25	0		-	19.78	-		
10	25	12		-	19.74	-		
10	25	25		-	19.74	-		
10	50	0		-	19.76	-		
Limit	Output Power < 100W			Result			Pass	



LTE Band 26 Maximum Average Power [dBm] (GT - LC = -3 dB)								
BW [MHz]	RB Size	RB Offset	Mod	Lowest	Middle	Highest	ERP (dBm)	ERP (W)
5	1	0	QPSK	24.52	24.54	24.50	19.42	0.0875
5	1	12		24.48	24.57	24.44		
5	1	24		24.48	24.53	24.35		
5	12	0		23.53	23.59	23.51		
5	12	7		23.56	23.61	23.52		
5	12	13		23.52	23.58	23.48		
5	25	0		23.52	23.57	23.46		
5	1	0	16-QAM	23.83	23.95	23.86	18.80	0.0759
5	1	12		23.92	23.92	23.82		
5	1	24		23.84	23.84	23.67		
5	12	0		22.59	22.60	22.59		
5	12	7		22.60	22.66	22.56		
5	12	13		22.61	22.64	22.54		
5	25	0		22.54	22.57	22.50		
5	1	0	64-QAM	22.71	22.76	22.72	17.61	0.0577
5	1	12		22.72	22.63	22.53		
5	1	24		22.71	22.70	22.61		
5	12	0		21.58	21.65	21.62		
5	12	7		21.64	21.68	21.61		
5	12	13		21.64	21.67	21.56		
5	25	0		21.58	21.62	21.52		
5	1	0	256-QAM	19.73	19.89	19.87	14.74	0.0298
5	1	12		19.69	19.85	19.88		
5	1	24		19.65	19.81	19.67		
5	12	0		19.70	19.78	19.80		
5	12	7		19.65	19.68	19.70		
5	12	13		19.69	19.68	19.70		
5	25	0		19.69	19.77	19.83		
Limit	Output Power < 100W			Result			Pass	



LTE Band 26 Maximum Average Power [dBm] (GT - LC = -3 dB)								
BW [MHz]	RB Size	RB Offset	Mod	Lowest	Middle	Highest	ERP (dBm)	ERP (W)
3	1	0	QPSK	24.50	24.51	24.41	19.36	0.0863
3	1	8		24.46	24.44	24.31		
3	1	14		24.44	24.48	24.24		
3	8	0		23.48	23.53	23.41		
3	8	4		23.48	23.52	23.40		
3	8	7		23.52	23.52	23.39		
3	15	0		23.49	23.53	23.41		
3	1	0	16-QAM	23.82	23.81	23.74	18.68	0.0738
3	1	8		23.83	23.78	23.62		
3	1	14		23.81	23.77	23.57		
3	8	0		22.54	22.60	22.49		
3	8	4		22.55	22.62	22.45		
3	8	7		22.59	22.65	22.51		
3	15	0		22.53	22.59	22.48		
3	1	0	64-QAM	22.67	22.74	22.64	17.59	0.0574
3	1	8		22.68	22.68	22.53		
3	1	14		22.69	22.71	22.59		
3	8	0		21.59	21.60	21.52		
3	8	4		21.57	21.62	21.52		
3	8	7		21.59	21.62	21.49		
3	15	0		21.56	21.59	21.48		
3	1	0	256-QAM	19.70	19.87	19.87	14.72	0.0296
3	1	8		19.64	19.81	19.80		
3	1	14		19.67	19.76	19.66		
3	8	0		19.73	19.82	19.80		
3	8	4		19.65	19.72	19.71		
3	8	7		19.62	19.67	19.67		
3	15	0		19.67	19.73	19.82		
Limit	Output Power < 100W			Result			Pass	



LTE Band 26 Maximum Average Power [dBm] (GT - LC = -3 dB)								
BW [MHz]	RB Size	RB Offset	Mod	Lowest	Middle	Highest	ERP (dBm)	ERP (W)
1.4	1	0	QPSK	24.51	24.50	24.34	19.43	0.0877
1.4	1	3		24.42	24.41	24.24		
1.4	1	5		24.50	24.50	24.25		
1.4	3	0		24.50	24.46	24.32		
1.4	3	1		24.58	24.52	24.33		
1.4	3	3		24.43	24.46	24.24		
1.4	6	0		23.47	23.46	23.30		
1.4	1	0	16-QAM	23.78	23.73	23.51	18.63	0.0729
1.4	1	3		23.70	23.62	23.43		
1.4	1	5		23.77	23.74	23.55		
1.4	3	0		23.61	23.58	23.45		
1.4	3	1		23.63	23.68	23.45		
1.4	3	3		23.59	23.56	23.42		
1.4	6	0		22.53	22.54	22.41		
1.4	1	0	64-QAM	22.66	22.70	22.52	17.55	0.0569
1.4	1	3		22.57	22.63	22.45		
1.4	1	5		22.66	22.64	22.54		
1.4	3	0		22.54	22.57	22.42		
1.4	3	1		22.57	22.62	22.48		
1.4	3	3		22.62	22.60	22.52		
1.4	6	0		21.55	21.58	21.42		
1.4	1	0	256-QAM	19.77	19.93	19.89	14.78	0.0301
1.4	1	3		19.71	19.81	19.88		
1.4	1	5		19.67	19.78	19.67		
1.4	3	0		19.67	19.84	19.75		
1.4	3	1		19.72	19.70	19.80		
1.4	3	3		19.63	19.68	19.74		
1.4	6	0		19.70	19.77	19.78		
Limit	Output Power < 100W			Result			Pass	



<ASDIV Antenna>

LTE Band 26 Maximum Average Power [dBm] (GT - LC = -6.9 dB)								
BW [MHz]	RB Size	RB Offset	Mod	Lowest	Middle	Highest	ERP (dBm)	ERP (W)
15	1	0	QPSK	24.42	-	-	15.37	0.0344
15	1	37		23.97	-	-		
15	1	74		24.09	-	-		
15	36	0		23.19	-	-		
15	36	20		23.18	-	-		
15	36	39		23.15	-	-		
15	75	0		23.16	-	-		
15	1	0	16-QAM	23.45	-	-	14.51	0.0282
15	1	37		23.48	-	-		
15	1	74		23.56	-	-		
15	36	0		22.18	-	-		
15	36	20		22.18	-	-		
15	36	39		22.18	-	-		
15	75	0		22.15	-	-		
15	1	0	64-QAM	22.28	-	-	13.32	0.0215
15	1	37		22.36	-	-		
15	1	74		22.37	-	-		
15	36	0		21.18	-	-		
15	36	20		21.19	-	-		
15	36	39		21.20	-	-		
15	75	0		21.15	-	-		
15	1	0	256-QAM	18.71	-	-	10.64	0.0116
15	1	37		19.68	-	-		
15	1	74		19.64	-	-		
15	36	0		19.64	-	-		
15	36	20		19.60	-	-		
15	36	39		19.63	-	-		
15	75	0		19.69	-	-		
Limit	Output Power < 100W			Result			Pass	



LTE Band 26 Maximum Average Power [dBm] (GT - LC = -6.9 dB)								
BW [MHz]	RB Size	RB Offset	Mod	Lowest	Middle	Highest	ERP (dBm)	ERP (W)
10	1	0	QPSK	-	24.45	-	15.40	0.0347
10	1	25		-	24.27	-		
10	1	49		-	24.34	-		
10	25	0		-	23.42	-		
10	25	12		-	23.40	-		
10	25	25		-	23.41	-		
10	50	0		-	23.45	-		
10	1	0	16-QAM	-	23.75	-	14.70	0.0295
10	1	25		-	23.68	-		
10	1	49		-	23.70	-		
10	25	0		-	22.45	-		
10	25	12		-	22.46	-		
10	25	25		-	22.47	-		
10	50	0		-	22.51	-		
10	1	0	64-QAM	-	22.63	-	13.58	0.0228
10	1	25		-	22.59	-		
10	1	49		-	22.63	-		
10	25	0		-	21.48	-		
10	25	12		-	21.48	-		
10	25	25		-	21.47	-		
10	50	0		-	21.55	-		
10	1	0	256-QAM	-	19.71	-	10.67	0.0117
10	1	25		-	19.71	-		
10	1	49		-	19.52	-		
10	25	0		-	19.72	-		
10	25	12		-	19.56	-		
10	25	25		-	19.55	-		
10	50	0		-	19.72	-		
Limit	Output Power < 100W			Result			Pass	



LTE Band 26 Maximum Average Power [dBm] (GT - LC = -6.9 dB)								
BW [MHz]	RB Size	RB Offset	Mod	Lowest	Middle	Highest	ERP (dBm)	ERP (W)
5	1	0	QPSK	24.30	24.44	24.39	15.39	0.0346
5	1	12		24.36	24.44	24.39		
5	1	24		24.26	24.40	24.24		
5	12	0		23.33	23.49	23.41		
5	12	7		23.35	23.48	23.42		
5	12	13		23.33	23.48	23.39		
5	25	0		23.29	23.46	23.38		
5	1	0	16-QAM	23.56	23.74	23.71	14.74	0.0298
5	1	12		23.74	23.79	23.72		
5	1	24		23.66	23.71	23.54		
5	12	0		22.37	22.50	22.48		
5	12	7		22.42	22.50	22.49		
5	12	13		22.41	22.50	22.45		
5	25	0		22.34	22.48	22.44		
5	1	0	64-QAM	22.45	22.61	22.62	13.59	0.0229
5	1	12		22.58	22.52	22.42		
5	1	24		22.62	22.64	22.56		
5	12	0		21.41	21.54	21.51		
5	12	7		21.45	21.52	21.47		
5	12	13		21.45	21.51	21.47		
5	25	0		21.38	21.51	21.45		
5	1	0	256-QAM	18.61	19.71	19.60	10.66	0.0116
5	1	12		19.61	19.66	19.45		
5	1	24		19.60	19.54	19.61		
5	12	0		19.56	19.71	19.68		
5	12	7		19.54	19.57	19.48		
5	12	13		19.61	19.57	19.44		
5	25	0		19.65	19.68	19.63		
Limit	Output Power < 100W			Result			Pass	



LTE Band 26 Maximum Average Power [dBm] (GT - LC = -6.9 dB)								
BW [MHz]	RB Size	RB Offset	Mod	Lowest	Middle	Highest	ERP (dBm)	ERP (W)
3	1	0	QPSK	24.40	24.45	24.41	15.40	0.0347
3	1	8		24.33	24.41	24.32		
3	1	14		24.36	24.45	24.28		
3	8	0		23.41	23.47	23.41		
3	8	4		23.41	23.48	23.41		
3	8	7		23.42	23.50	23.41		
3	15	0		23.40	23.48	23.40		
3	1	0	16-QAM	23.66	23.77	23.72	14.72	0.0296
3	1	8		23.65	23.73	23.61		
3	1	14		23.69	23.75	23.63		
3	8	0		22.41	22.51	22.48		
3	8	4		22.46	22.56	22.47		
3	8	7		22.51	22.61	22.55		
3	15	0		22.43	22.55	22.52		
3	1	0	64-QAM	22.60	22.72	22.67	13.67	0.0233
3	1	8		22.56	22.66	22.60		
3	1	14		22.61	22.69	22.64		
3	8	0		21.44	21.56	21.51		
3	8	4		21.49	21.57	21.51		
3	8	7		21.54	21.57	21.53		
3	15	0		21.48	21.57	21.54		
3	1	0	256-QAM	18.67	19.72	19.66	10.73	0.0118
3	1	8		19.65	19.73	19.46		
3	1	14		19.62	19.55	19.61		
3	8	0		19.60	19.78	19.67		
3	8	4		19.50	19.54	19.50		
3	8	7		19.61	19.55	19.45		
3	15	0		19.64	19.73	19.67		
Limit	Output Power < 100W			Result			Pass	



LTE Band 26 Maximum Average Power [dBm] (GT - LC = -6.9 dB)								
BW [MHz]	RB Size	RB Offset	Mod	Lowest	Middle	Highest	ERP (dBm)	ERP (W)
1.4	1	0	QPSK	24.37	24.44	24.35	15.40	0.0347
1.4	1	3		24.33	24.38	24.24		
1.4	1	5		24.35	24.45	24.25		
1.4	3	0		24.34	24.44	24.31		
1.4	3	1		24.43	24.45	24.35		
1.4	3	3		24.34	24.38	24.25		
1.4	6	0		23.33	23.45	23.29		
1.4	1	0	16-QAM	23.60	23.75	23.60	14.70	0.0295
1.4	1	3		23.51	23.63	23.43		
1.4	1	5		23.60	23.71	23.54		
1.4	3	0		23.48	23.59	23.48		
1.4	3	1		23.51	23.61	23.51		
1.4	3	3		23.46	23.54	23.43		
1.4	6	0		22.37	22.50	22.45		
1.4	1	0	64-QAM	22.51	22.65	22.54	13.61	0.0230
1.4	1	3		22.42	22.52	22.45		
1.4	1	5		22.56	22.66	22.55		
1.4	3	0		22.47	22.59	22.50		
1.4	3	1		22.46	22.57	22.54		
1.4	3	3		22.48	22.59	22.55		
1.4	6	0		21.37	21.49	21.43		
1.4	1	0	256-QAM	18.61	19.74	19.65	10.70	0.0117
1.4	1	3		19.58	19.69	19.47		
1.4	1	5		19.58	19.58	19.57		
1.4	3	0		19.58	19.75	19.66		
1.4	3	1		19.51	19.54	19.46		
1.4	3	3		19.60	19.59	19.45		
1.4	6	0		19.60	19.66	19.61		
Limit	Output Power < 100W			Result			Pass	



LTE Band 26

Peak-to-Average Ratio

Mode	LTE Band 26 / 10MHz				
Mod.	QPSK	16QAM	64QAM	256QAM	Limit: 13dB
RB Size	Full RB	Full RB	Full RB	Full RB	Result
Middle CH	5.45	5.83	5.97	6.03	PASS

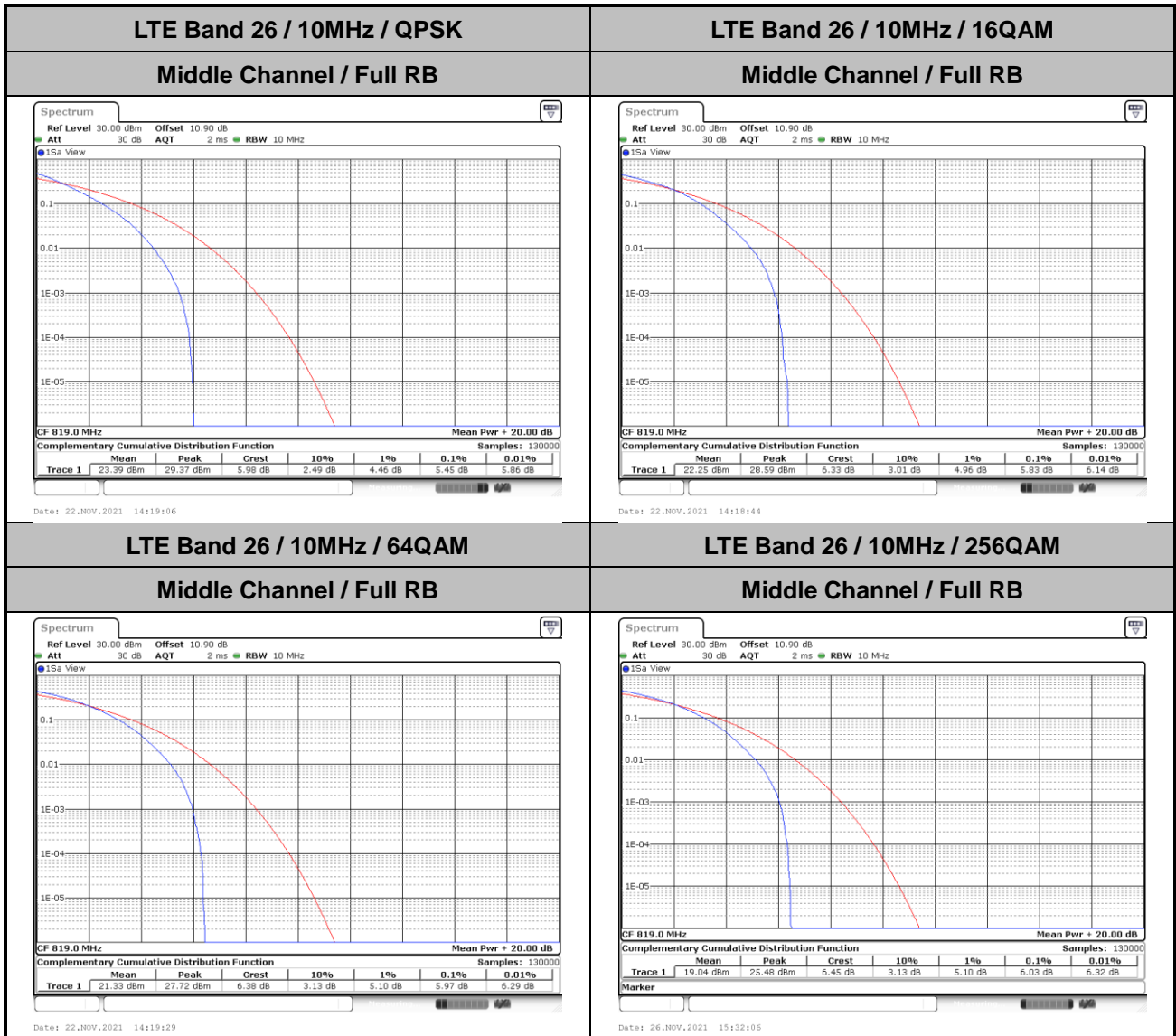



26dB Bandwidth

Mode	LTE Band 26 : 26dB BW(MHz)											
BW	1.4MHz		3MHz		5MHz		10MHz		15MHz		20MHz	
Mod.	QPSK	16QAM	QPSK	16QAM	QPSK	16QAM	QPSK	16QAM	QPSK	16QAM	QPSK	16QAM
Low CH	-	-	-	-	-	-	-	-	14.57	14.45	-	-
Middle CH	1.31	1.29	3.16	3.09	4.92	5.03	9.67	10.53	-	-	-	-
Mode	LTE Band 26 : 26dB BW(MHz)											
BW	1.4MHz		3MHz		5MHz		10MHz		15MHz		20MHz	
Mod.	64QAM	256 QAM	64QAM	256 QAM	64QAM	256 QAM	64QAM	256 QAM	64QAM	256 QAM	64QAM	256 QAM
Low CH	-	-	-	-	-	-	-	-	14.39	14.66	-	-
Middle CH	1.31	1.30	3.03	3.10	5.20	5.30	10.03	9.97	-	-	-	-



LTE Band 26

Middle Channel / 1.4MHz / QPSK

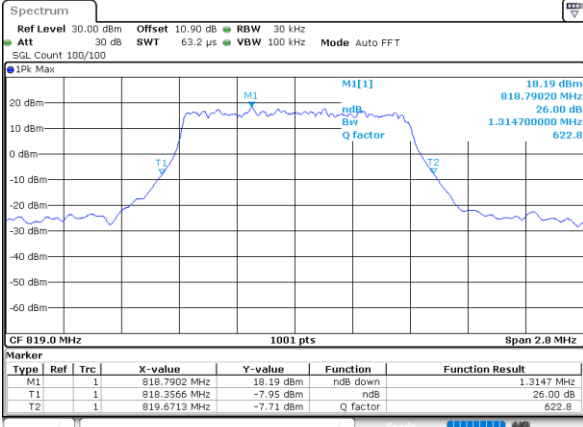

Date: 22.NOV.2021 13:35:19

Middle Channel / 1.4MHz / 16QAM

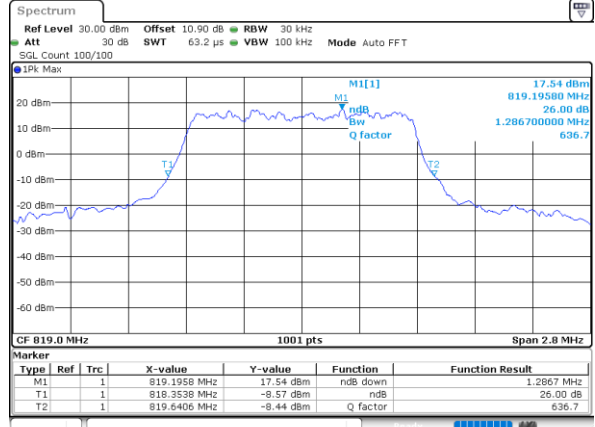

Date: 22.NOV.2021 13:36:10

Middle Channel / 3MHz / QPSK

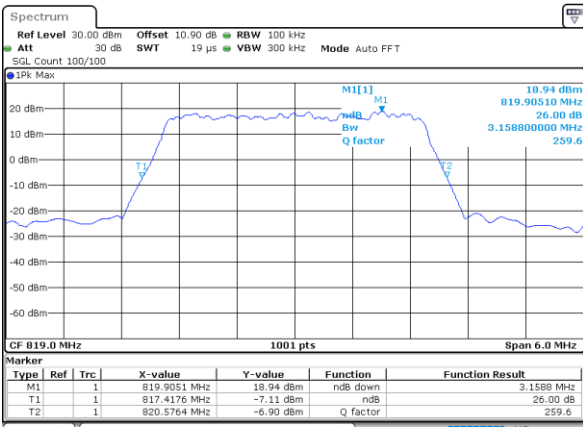

Date: 22.NOV.2021 13:48:04

Middle Channel / 3MHz / 16QAM

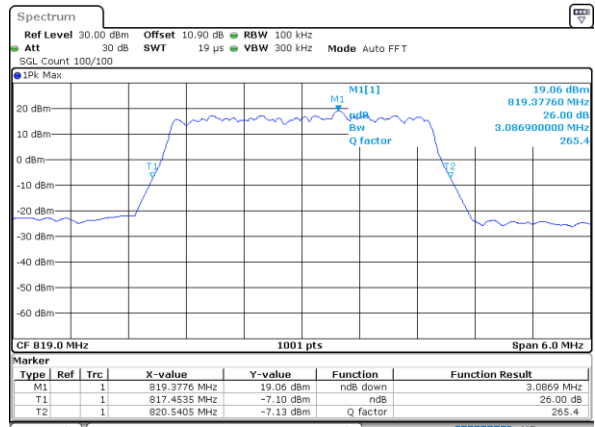

Date: 22.NOV.2021 13:48:26

Middle Channel / 5MHz / QPSK

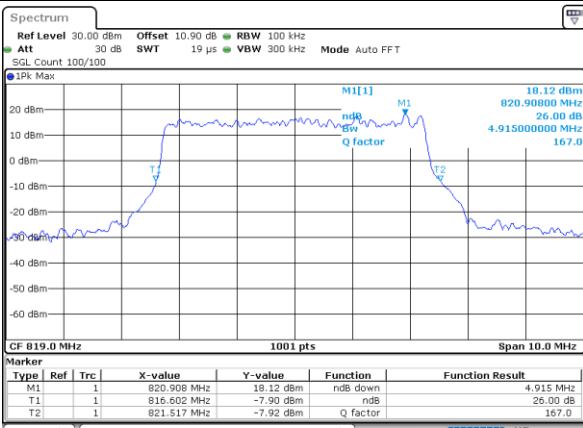

Date: 22.NOV.2021 13:57:46

Middle Channel / 5MHz / 16QAM

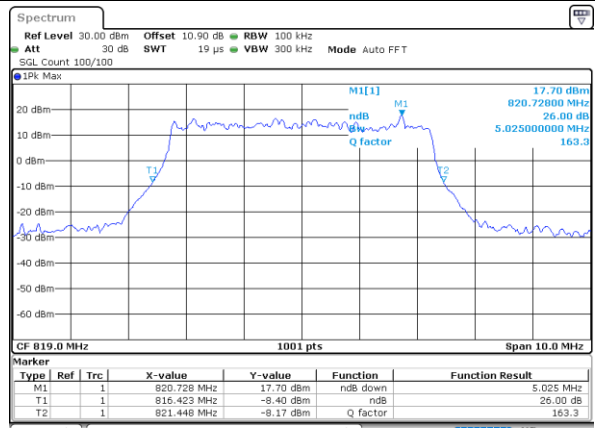

Date: 22.NOV.2021 13:58:07



LTE Band 26

Middle Channel / 10MHz / QPSK

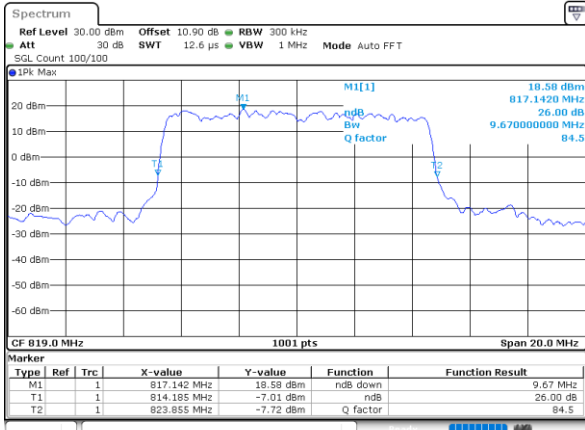

Date: 22.NOV.2021 14:17:22

Middle Channel / 10MHz / 16QAM

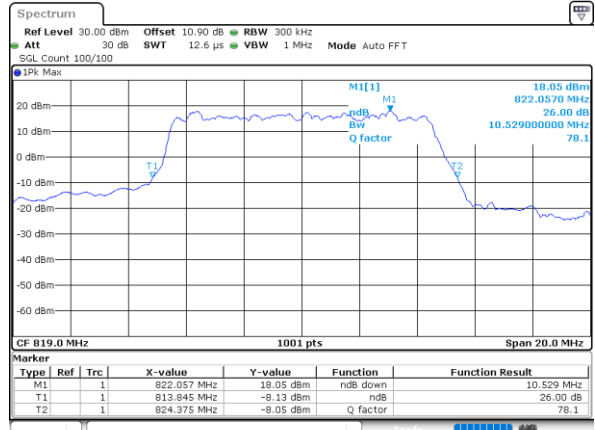

Date: 22.NOV.2021 14:17:44

Low Channel / 15MHz / QPSK

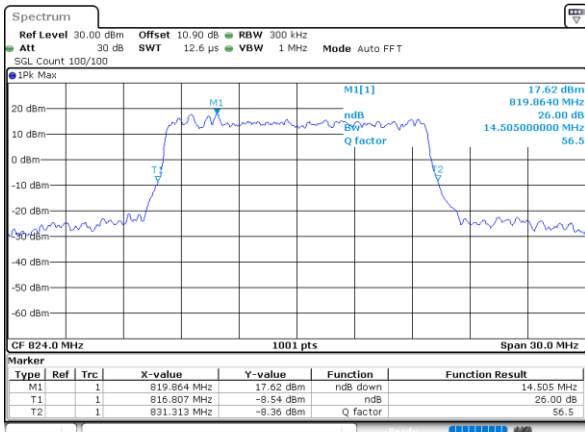

Date: 22.NOV.2021 11:42:14

Low Channel / 15MHz / 16QAM

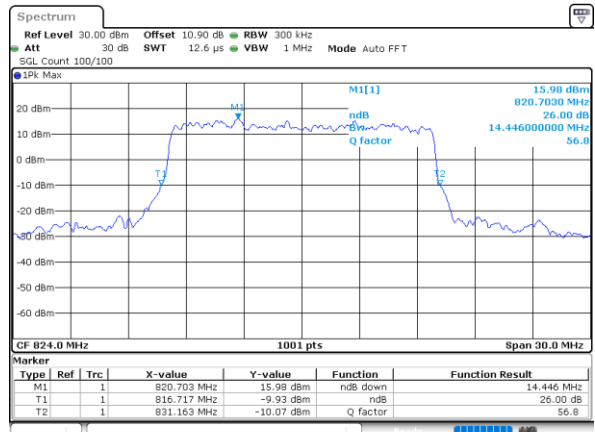

Date: 22.NOV.2021 11:42:35



LTE Band 26

Middle Channel / 1.4MHz / 64QAM

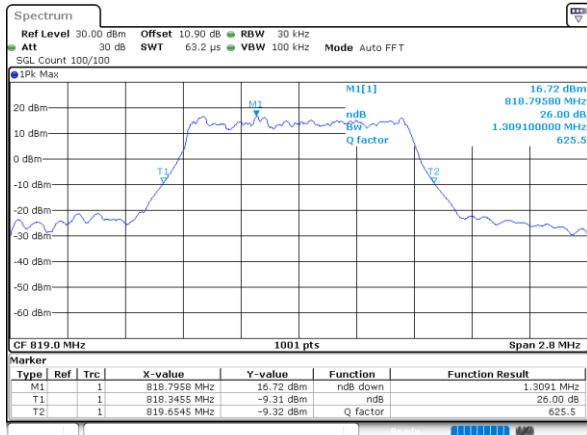

Date: 22.NOV.2021 13:33:57

Middle Channel / 3MHz / 64QAM

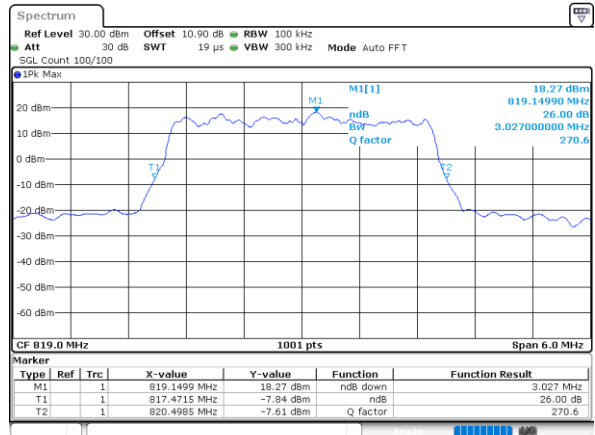

Date: 22.NOV.2021 13:46:59

Middle Channel / 5MHz / 64QAM

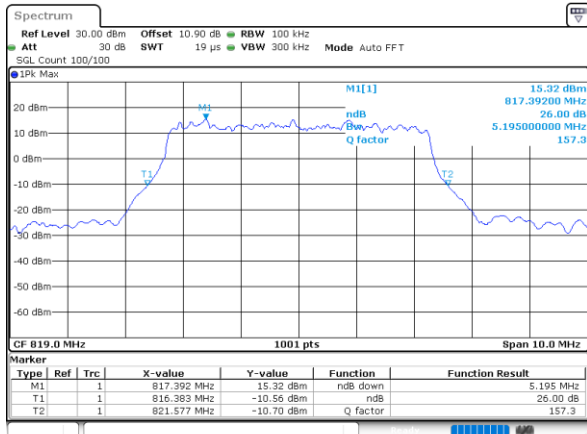

Date: 22.NOV.2021 13:56:04

Middle Channel / 10MHz / 64QAM

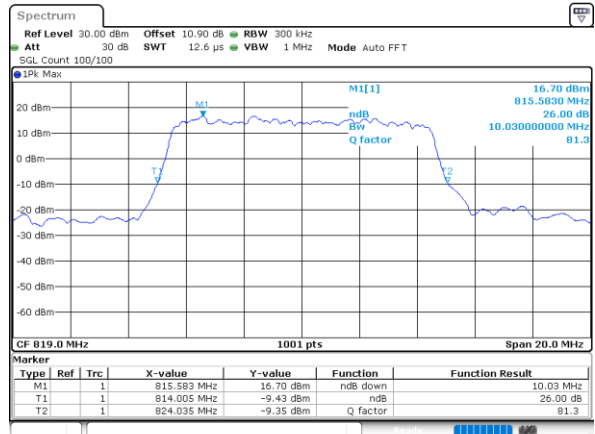

Date: 22.NOV.2021 14:16:18

Low Channel / 15MHz / 64QAM

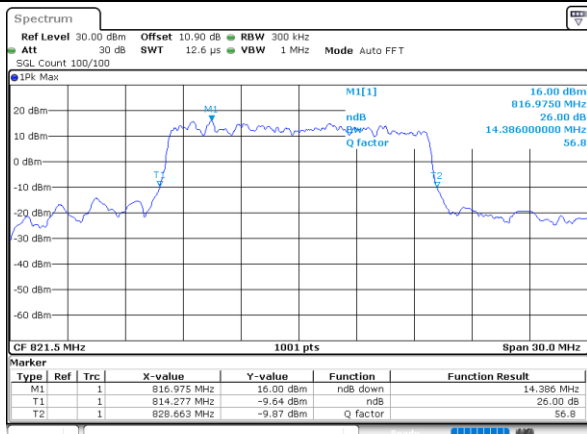

Date: 22.NOV.2021 14:40:57



LTE Band 26

Middle Channel / 1.4MHz / 256QAM

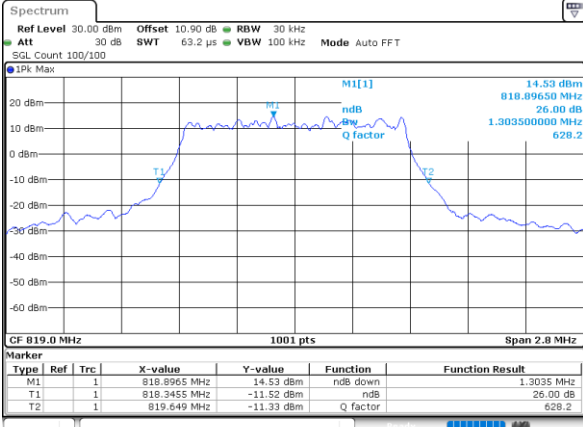

Date: 26.NOV.2021 14:27:50

Middle Channel / 3MHz / 256QAM

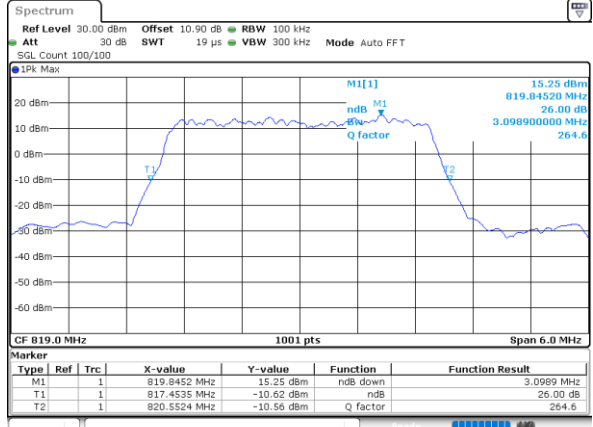

Date: 26.NOV.2021 14:31:04

Middle Channel / 5MHz / 256QAM

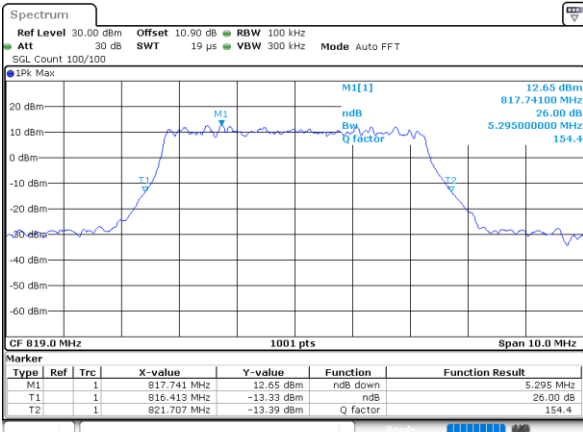

Date: 26.NOV.2021 14:35:05

Middle Channel / 10MHz / 256QAM

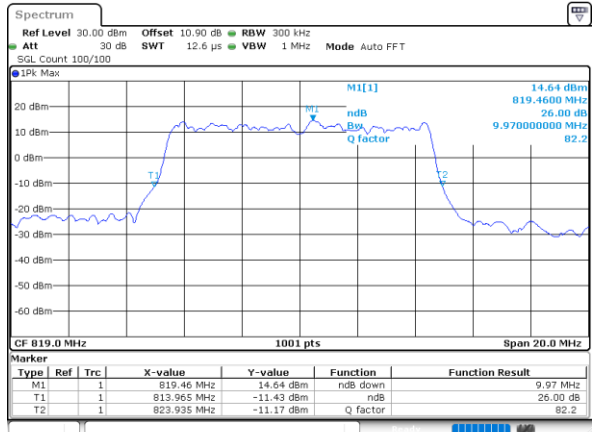

Date: 26.NOV.2021 15:31:37

Low Channel / 5MHz / 256QAM

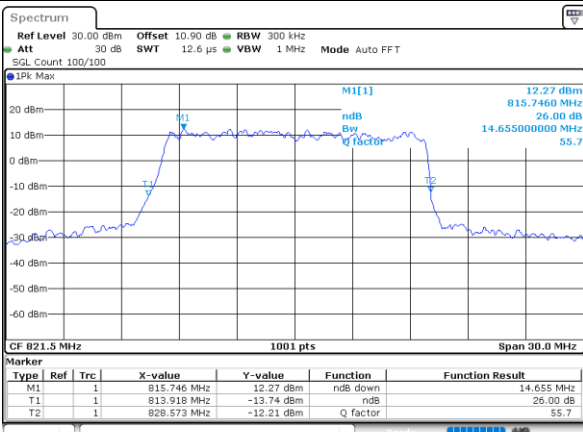

Date: 26.NOV.2021 15:36:23



Occupied Bandwidth

Mode	LTE Band 26 : 99%OBW(MHz)											
BW	1.4MHz		3MHz		5MHz		10MHz		15MHz		20MHz	
Mod.	QPSK	16QAM	QPSK	16QAM	QPSK	16QAM	QPSK	16QAM	QPSK	16QAM	QPSK	16QAM
Low CH	-	-	-	-	-	-	-	-	13.43	13.46	-	-
Middle CH	1.09	1.09	2.73	2.76	4.50	4.53	9.05	9.03	-	-	-	-
Mode	LTE Band 26 : 99%OBW(MHz)											
BW	1.4MHz		3MHz		5MHz		10MHz		15MHz		20MHz	
Mod.	64QAM	256 QAM	64QAM	256 QAM	64QAM	256 QAM	64QAM	256 QAM	64QAM	256 QAM	64QAM	256 QAM
Low CH	-	-	-	-	-	-	-	-	13.37	13.46	-	-
Middle CH	1.09	1.09	2.75	2.72	4.51	4.51	9.03	9.03	-	-	-	-



LTE Band 26

Middle Channel / 1.4MHz / QPSK

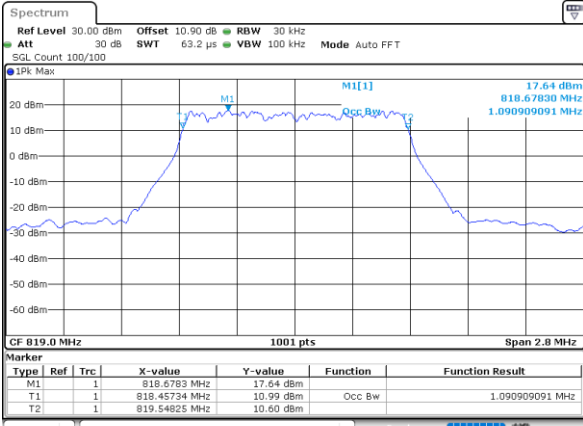

Date: 22.NOV.2021 13:34:56

Middle Channel / 1.4MHz / 16QAM

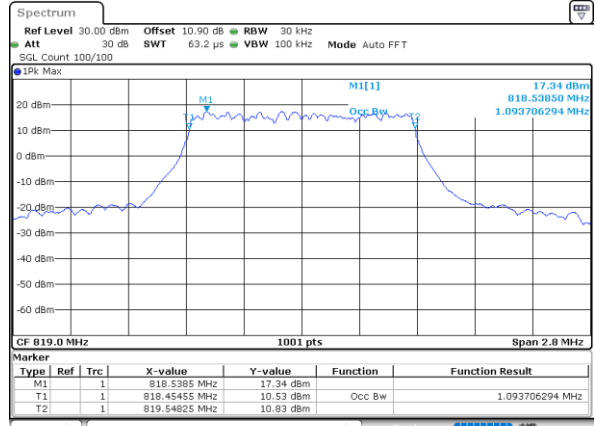

Date: 22.NOV.2021 13:35:17

Middle Channel / 3MHz / QPSK

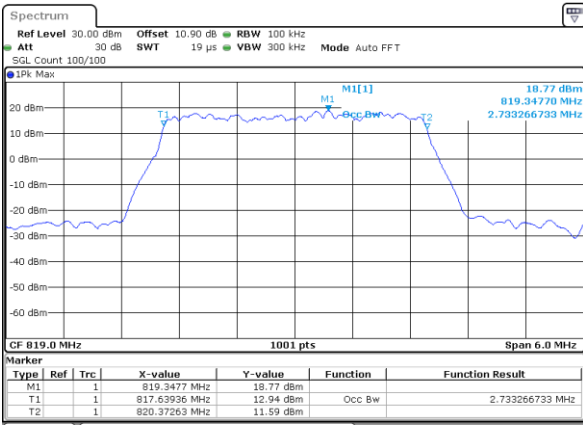

Date: 22.NOV.2021 13:47:21

Middle Channel / 3MHz / 16QAM

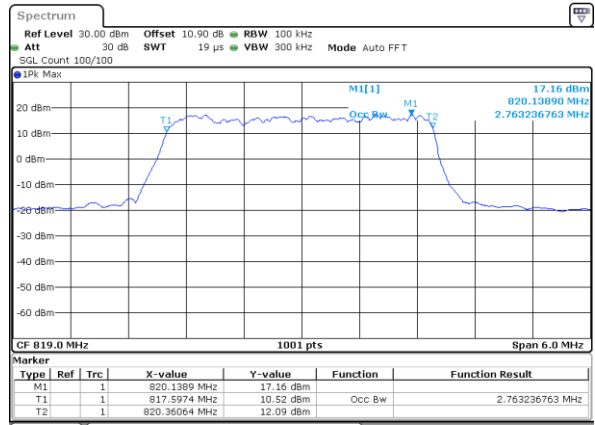

Date: 22.NOV.2021 13:47:42

Middle Channel / 5MHz / QPSK

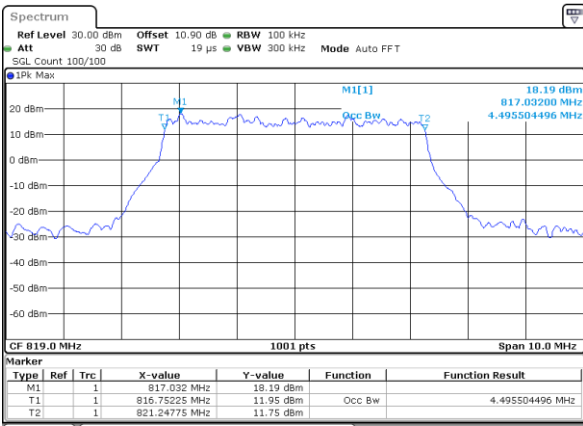

Date: 22.NOV.2021 13:57:03

Middle Channel / 5MHz / 16QAM

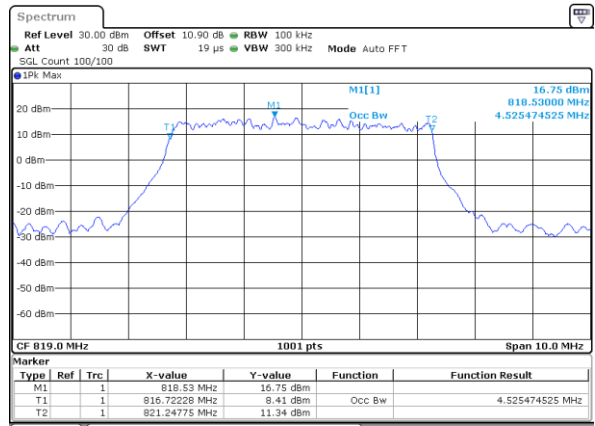

Date: 22.NOV.2021 13:57:24



LTE Band 26

Middle Channel / 10MHz / QPSK

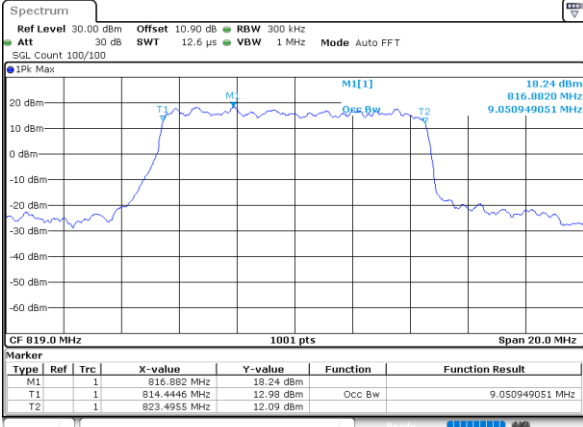

Date: 22.NOV.2021 14:16:39

Middle Channel / 10MHz / 16QAM

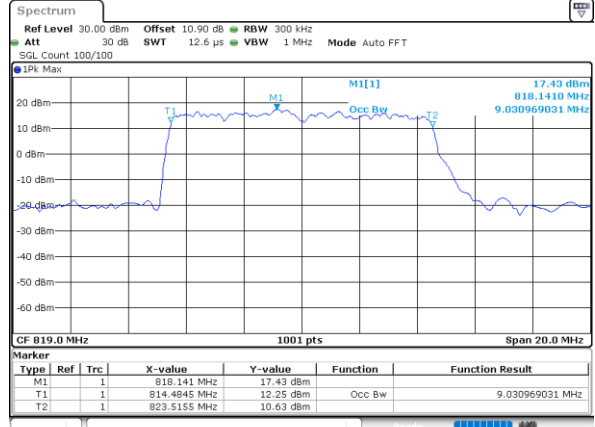

Date: 22.NOV.2021 14:17:01

Low Channel / 15MHz / QPSK

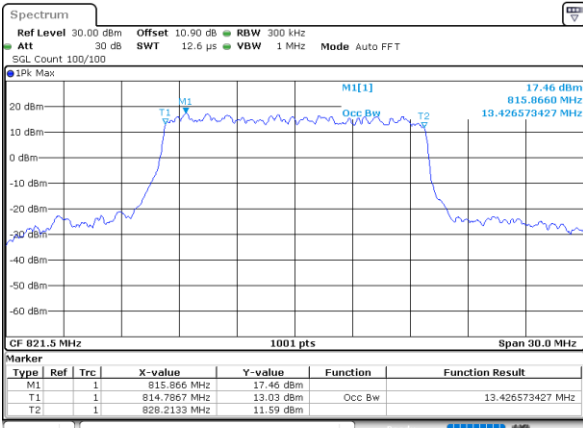

Date: 22.NOV.2021 14:42:02

Low Channel / 15MHz / 16QAM

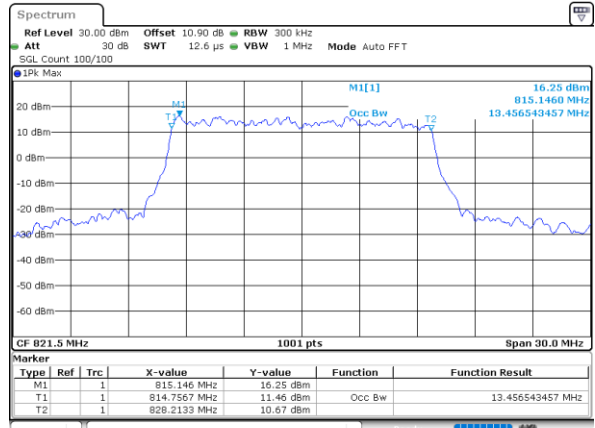

Date: 22.NOV.2021 14:41:19



LTE Band 26

Middle Channel / 1.4MHz / 64QAM

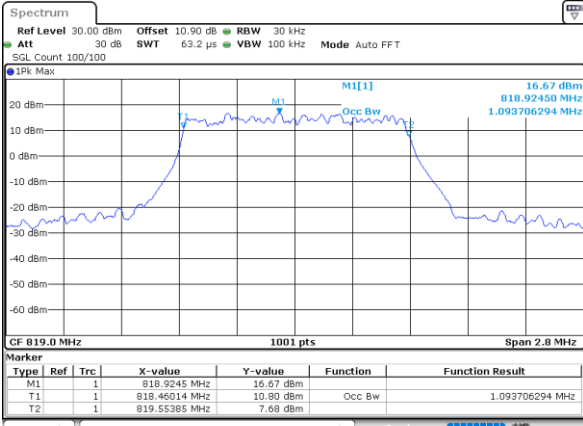

Middle Channel / 3MHz / 64QAM

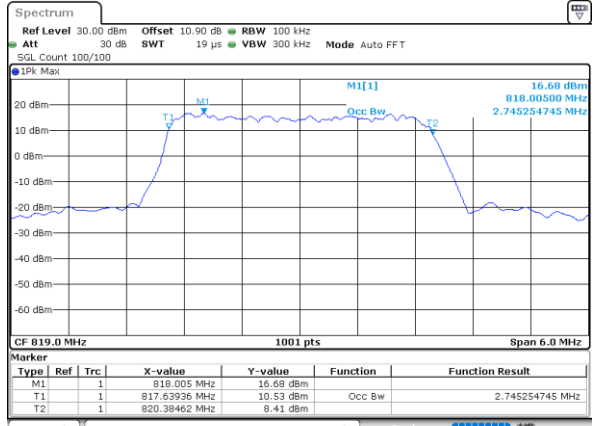

Middle Channel / 5MHz / 64QAM

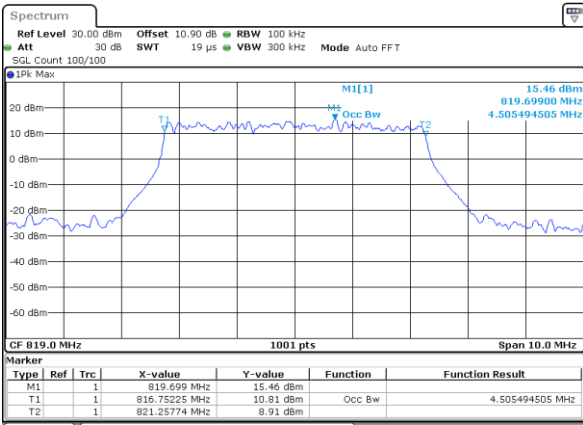

Middle Channel / 10MHz / 64QAM

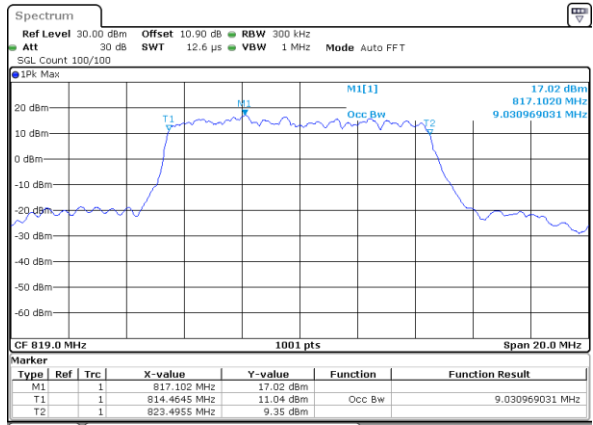

Low Channel / 5MHz / 64QAM

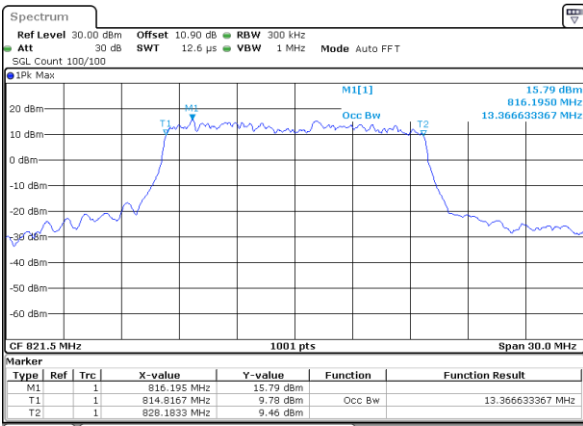



LTE Band 26

Middle Channel / 1.4MHz / 256QAM

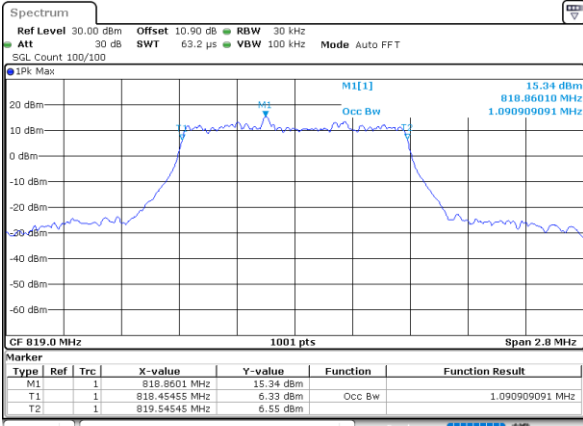

Middle Channel / 3MHz / 256QAM

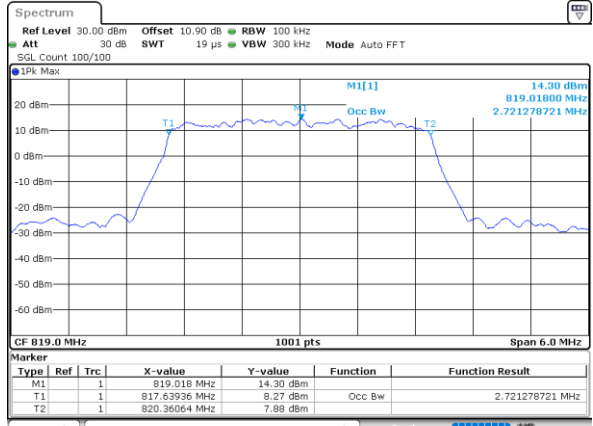

Middle Channel / 5MHz / 256QAM

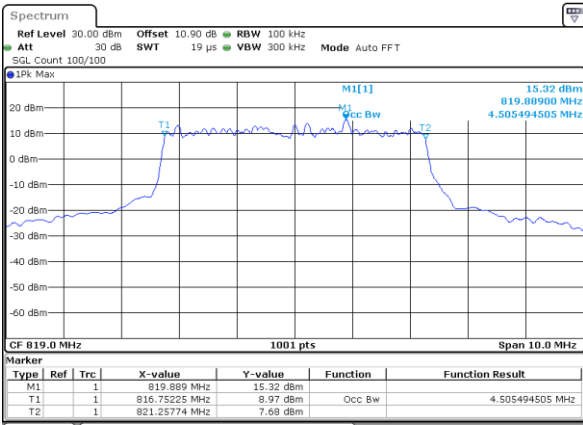

Middle Channel / 10MHz / 256QAM

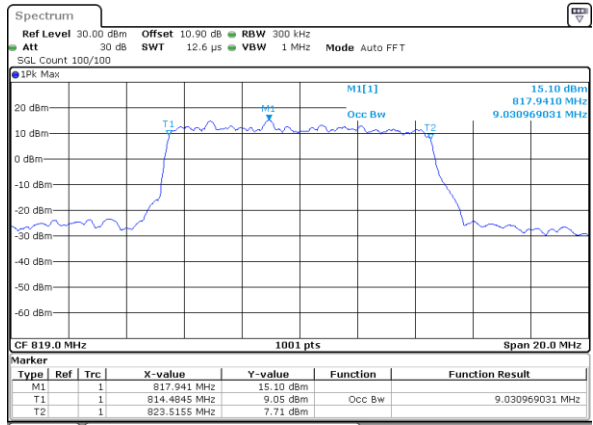

Low Channel / 15MHz / 256QAM

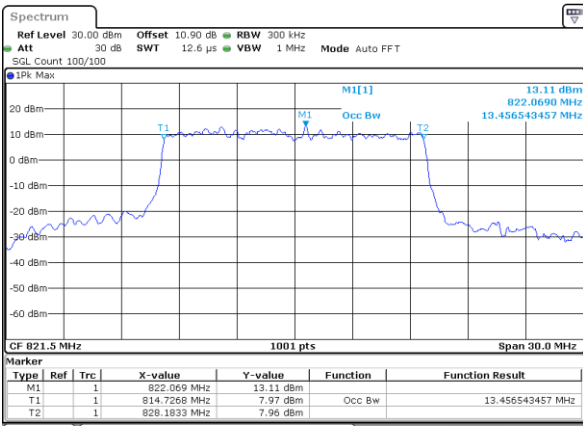



Emission masks – In-band emissions

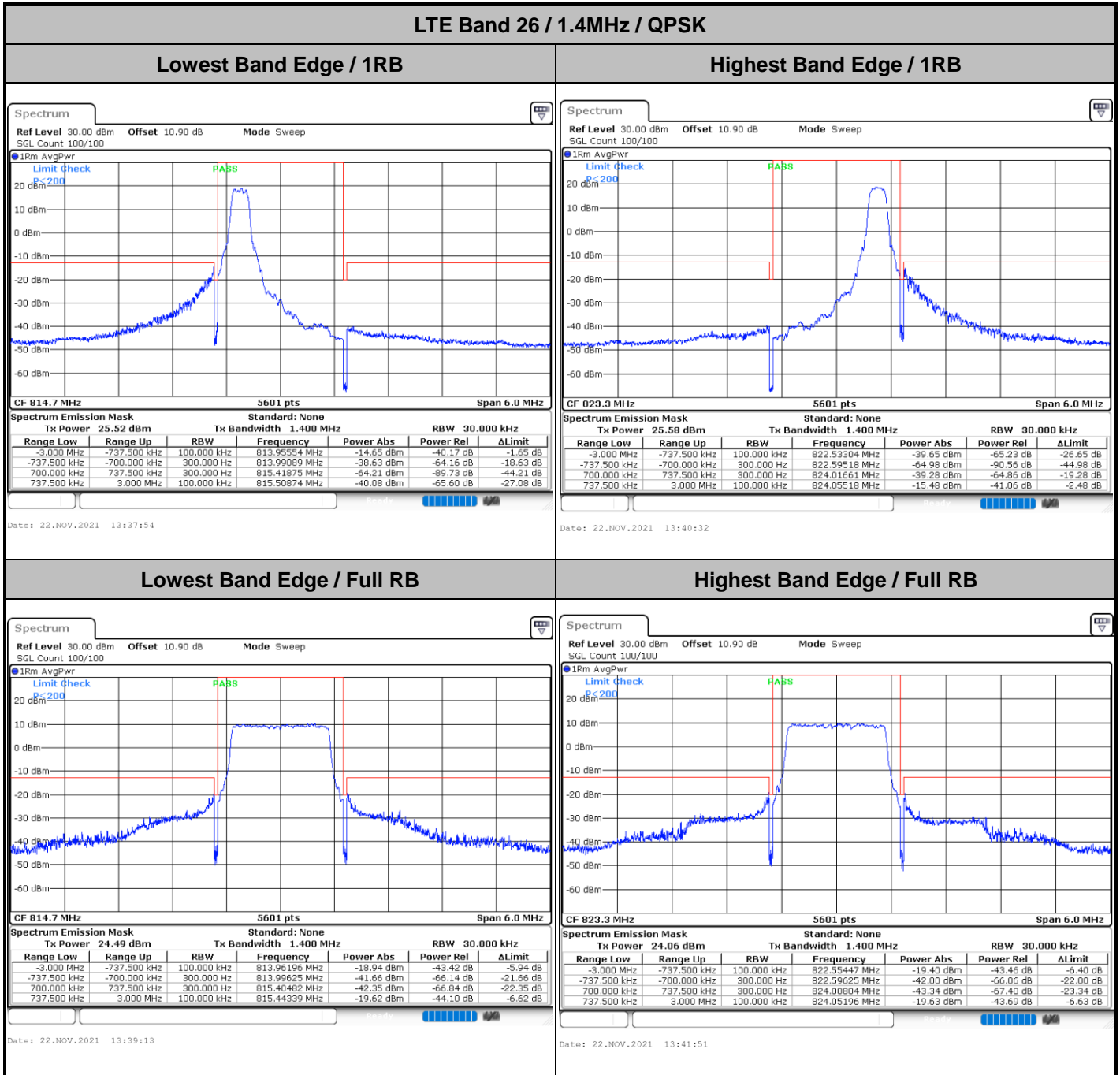



LTE Band 26 / 1.4MHz / 16QAM

Lowest Band Edge / 1 RB

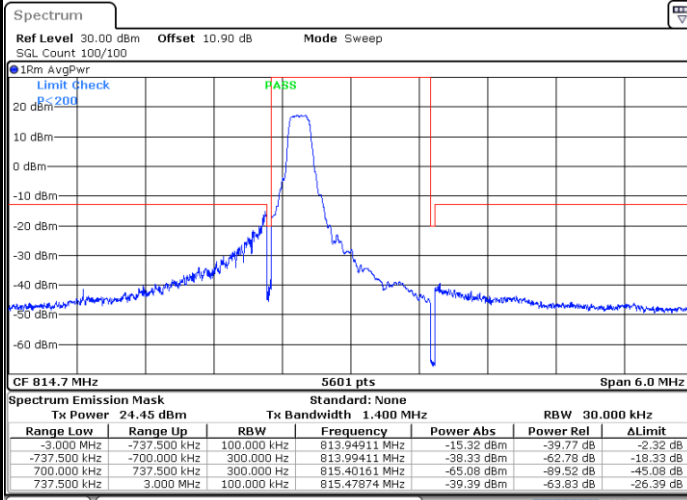

Date: 22.NOV.2021 13:38:33

Highest Band Edge / 1 RB

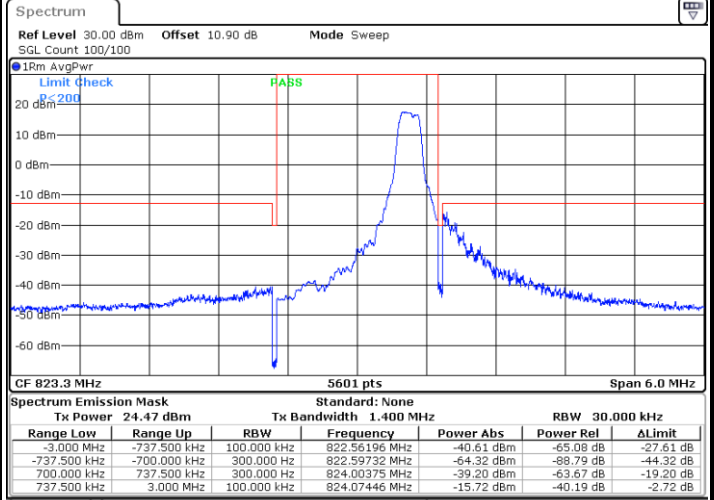

Date: 22.NOV.2021 13:41:11

Lowest Band Edge / Full RB

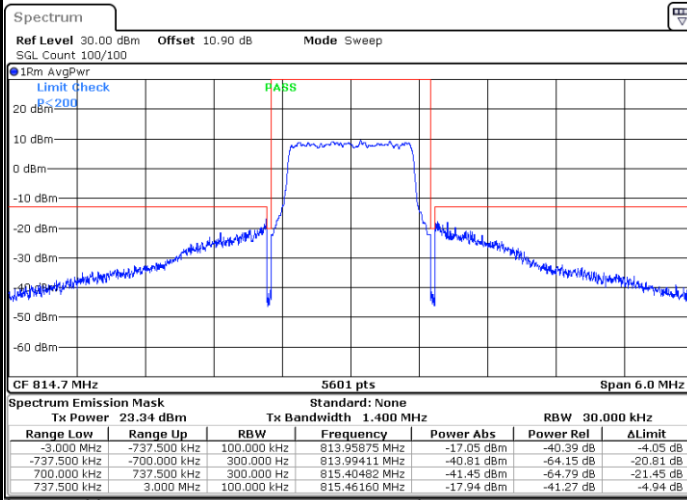

Date: 22.NOV.2021 13:39:52

Highest Band Edge / Full RB

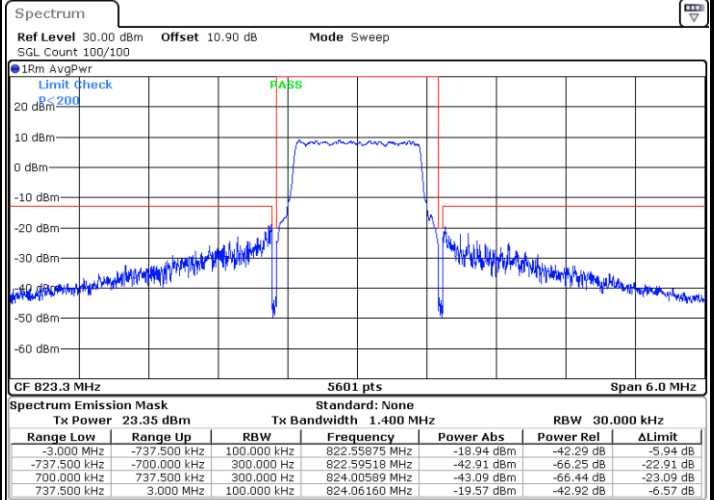

Date: 22.NOV.2021 13:42:30



LTE Band 26 / 1.4MHz / 64QAM

Lowest Band Edge / 1 RB

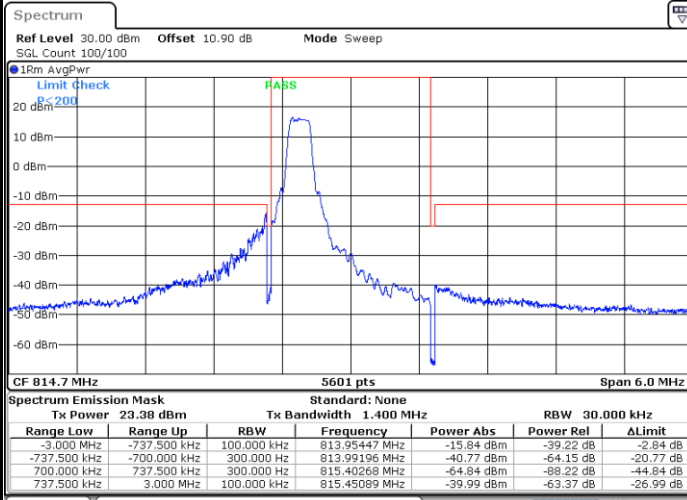

Date: 22.NOV.2021 13:43:10

Highest Band Edge / 1 RB

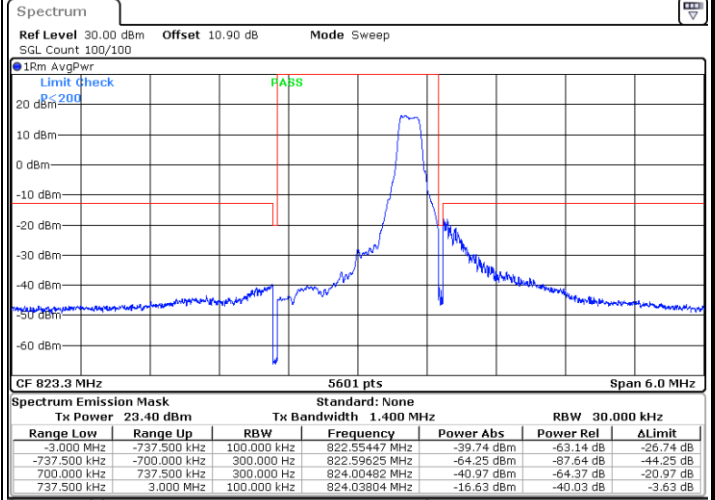

Date: 22.NOV.2021 13:44:29

Lowest Band Edge / Full RB

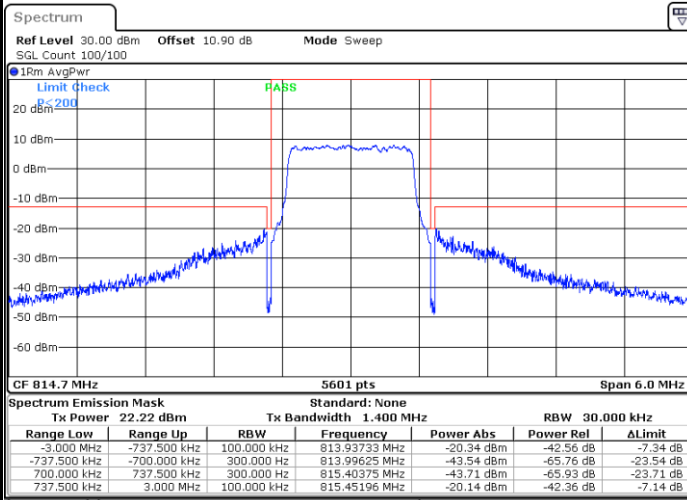

Date: 22.NOV.2021 13:43:49

Highest Band Edge / Full RB

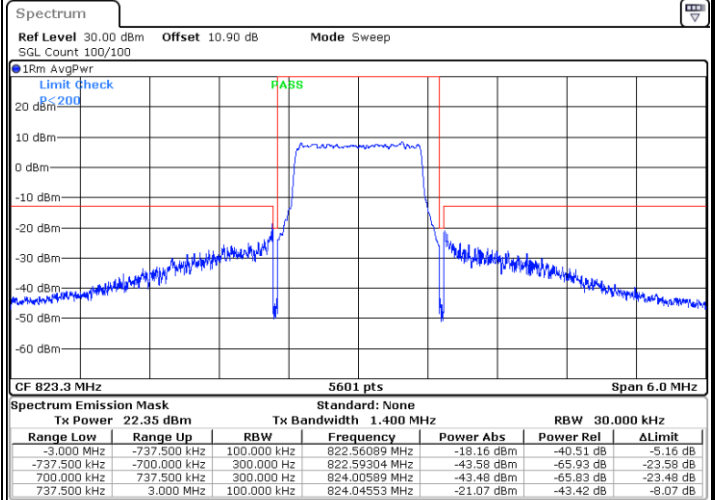

Date: 22.NOV.2021 13:45:08



LTE Band 26 / 1.4MHz / 256QAM

Lowest Band Edge / 1 RB

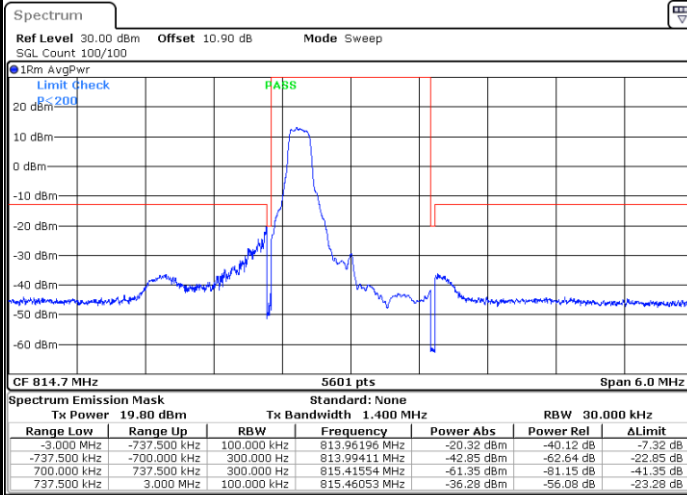

Date: 26.NOV.2021 14:29:05

Highest Band Edge / 1 RB

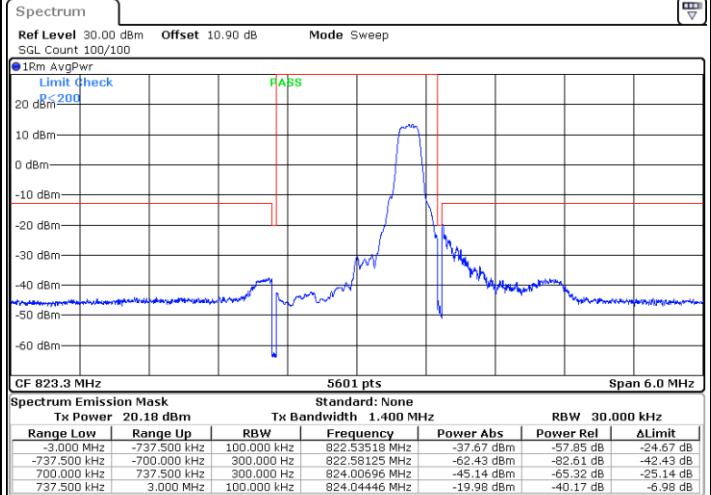

Date: 26.NOV.2021 14:29:45

Lowest Band Edge / Full RB

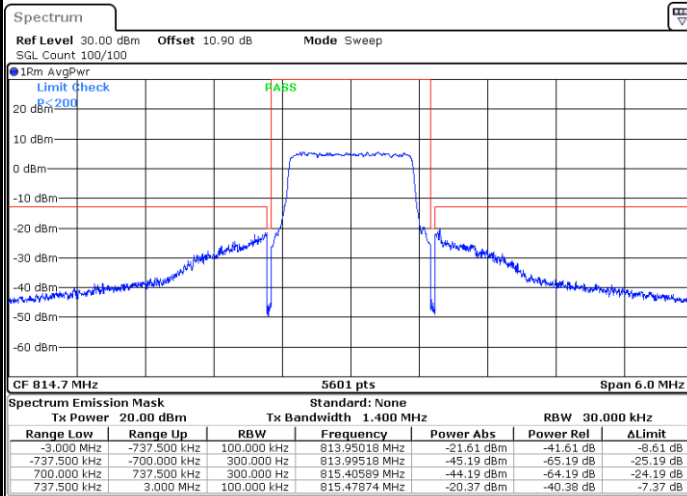

Date: 26.NOV.2021 14:28:36

Highest Band Edge / Full RB

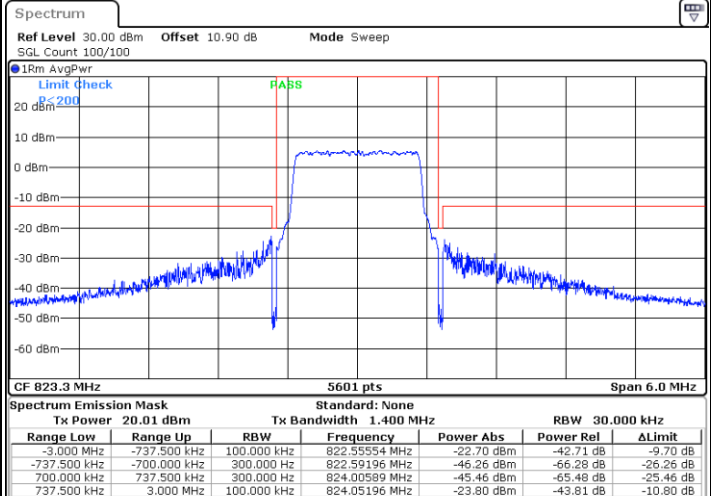

Date: 26.NOV.2021 14:30:24



LTE Band 26 / 3MHz / QPSK

Lowest Band Edge / 1RB

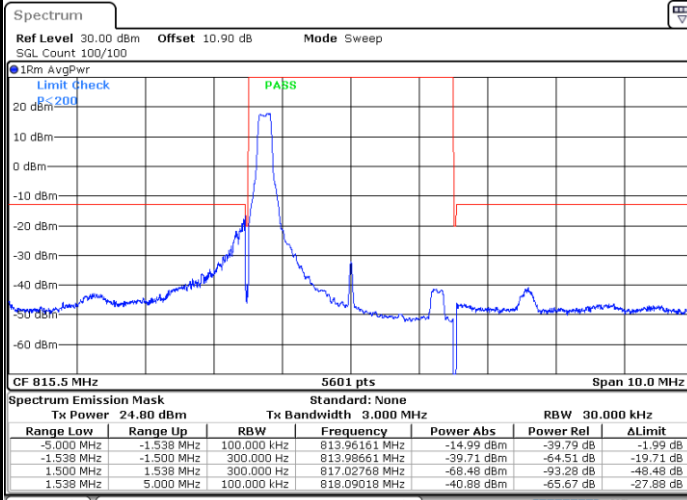

Date: 22.NOV.2021 15:16:05

Highest Band Edge / 1 RB

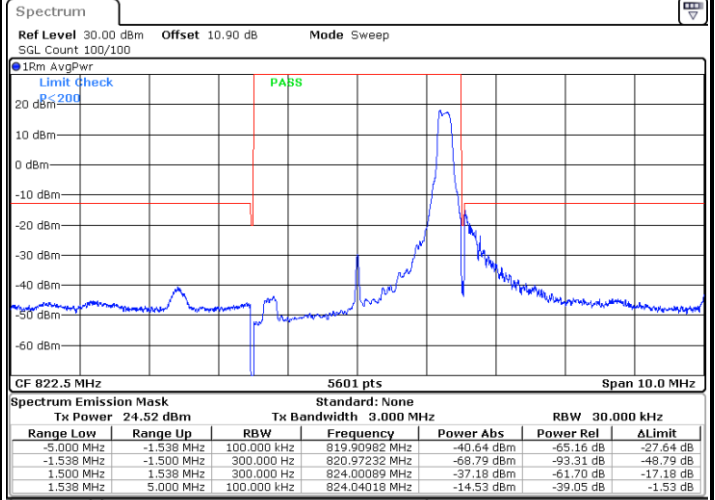

Date: 22.NOV.2021 15:29:13

Lowest Band Edge / Full RB

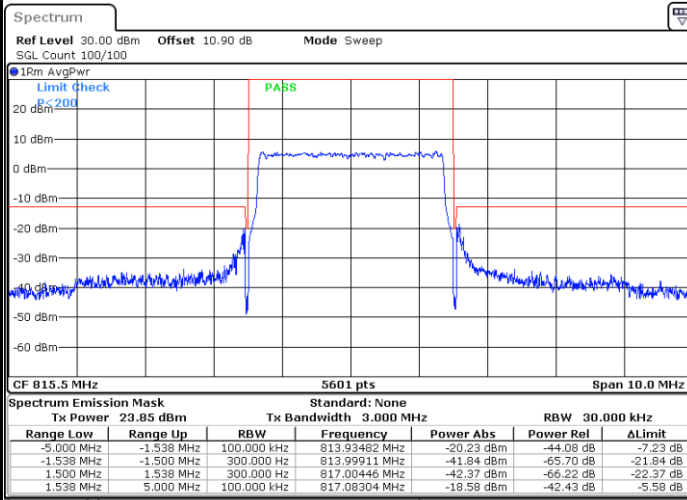

Date: 22.NOV.2021 13:51:39

Highest Band Edge / Full RB

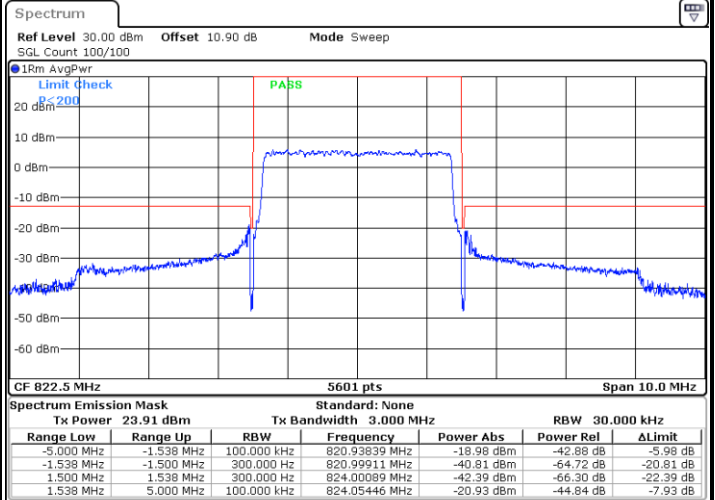

Date: 22.NOV.2021 13:54:18



LTE Band 26 / 3MHz / 16QAM

Lowest Band Edge / 1 RB

Highest Band Edge / 1 RB

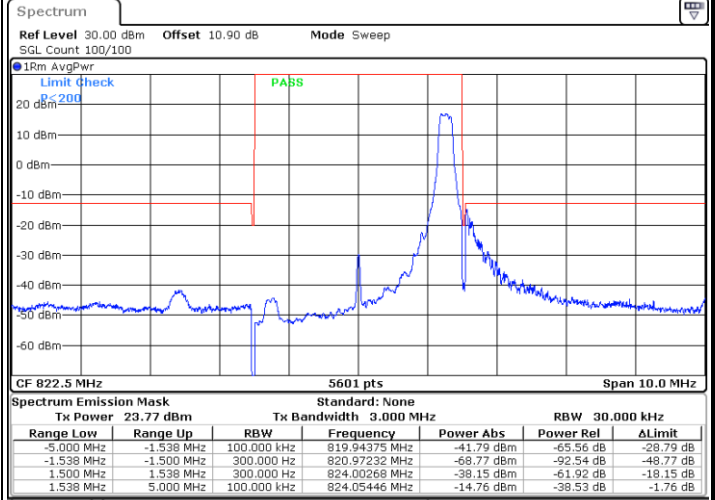
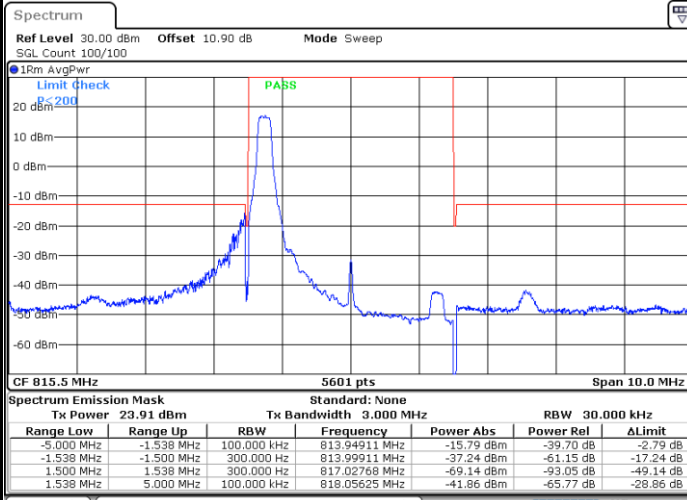

Date: 22.NOV.2021 15:14:29

Date: 22.NOV.2021 15:29:58

Lowest Band Edge / Full RB

Highest Band Edge / Full RB

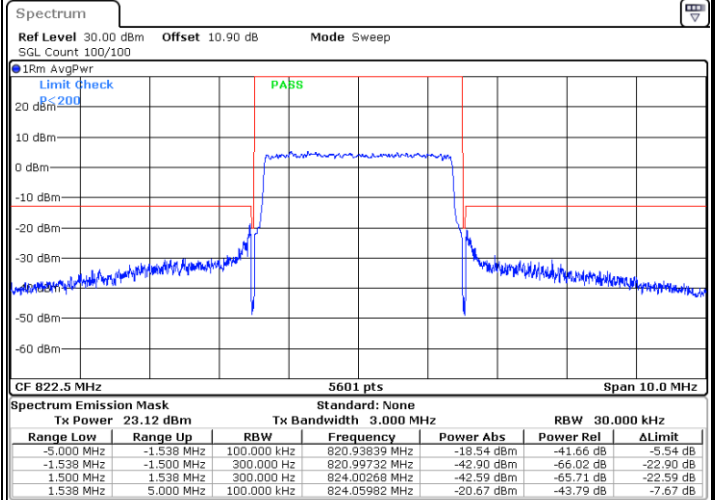
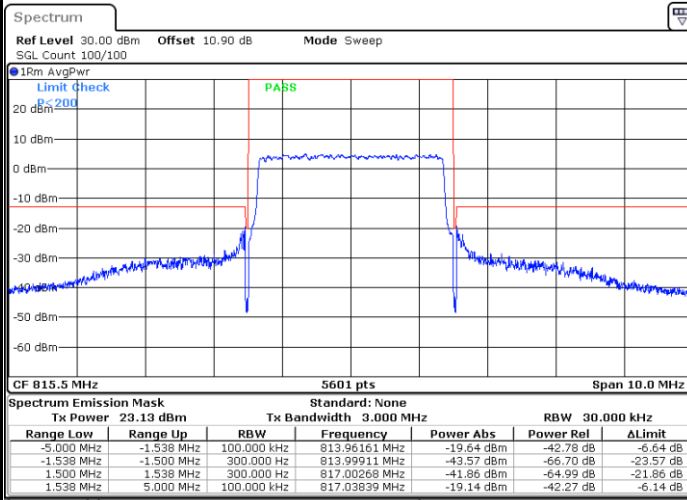

Date: 22.NOV.2021 13:52:19

Date: 22.NOV.2021 13:54:58



LTE Band 26 / 3MHz / 64QAM

Lowest Band Edge / 1 RB

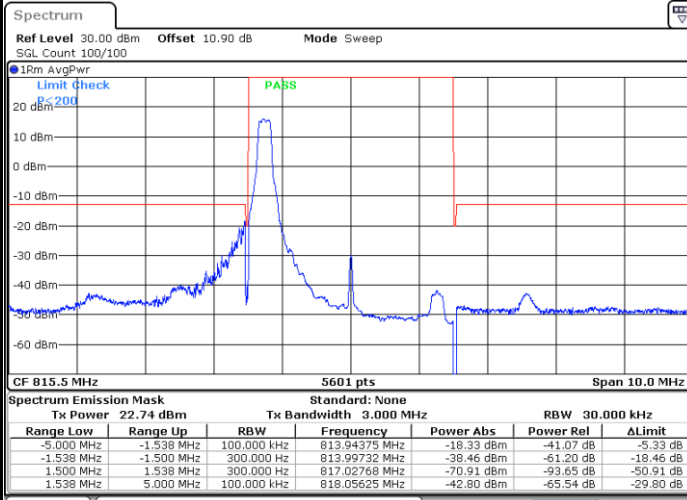

Highest Band Edge / 1 RB

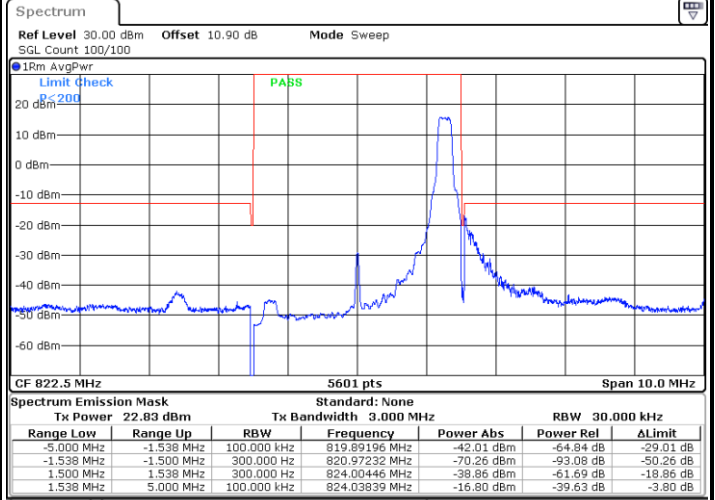

Lowest Band Edge / Full RB

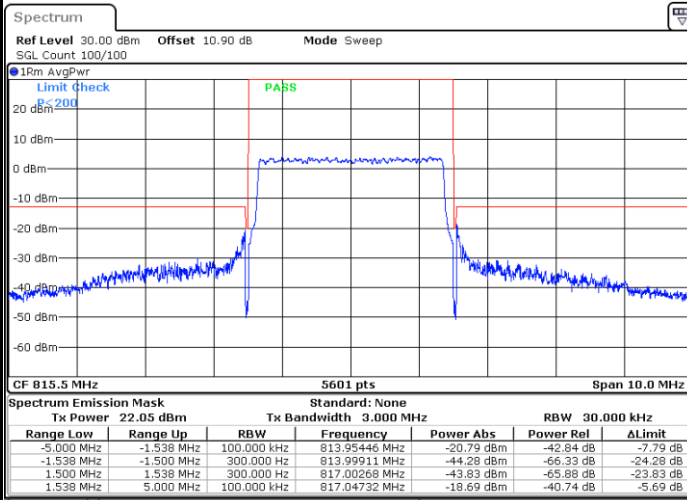

Highest Band Edge / Full RB

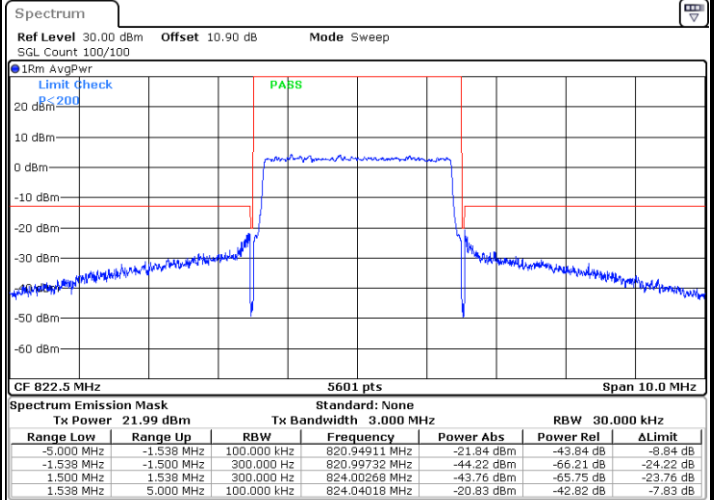



LTE Band 26 / 3MHz / 256QAM

Lowest Band Edge / 1 RB

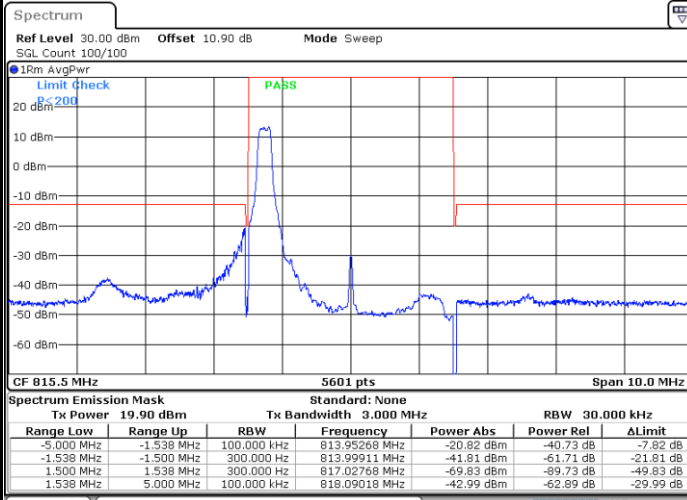

Date: 26.NOV.2021 14:32:46

Highest Band Edge / 1 RB

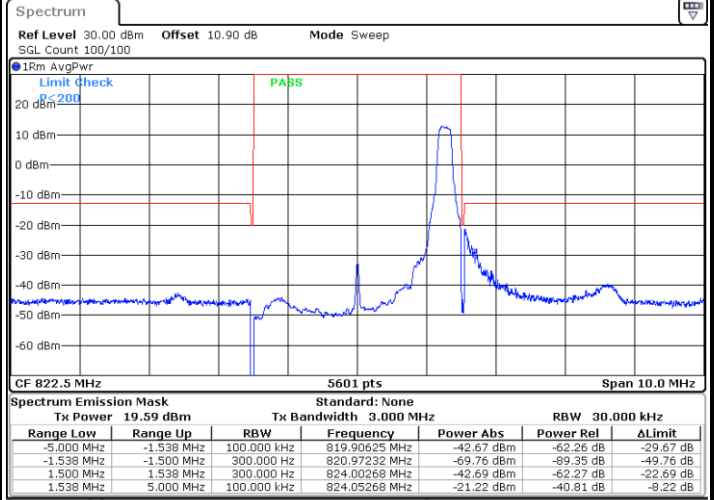

Date: 26.NOV.2021 14:33:22

Lowest Band Edge / Full RB

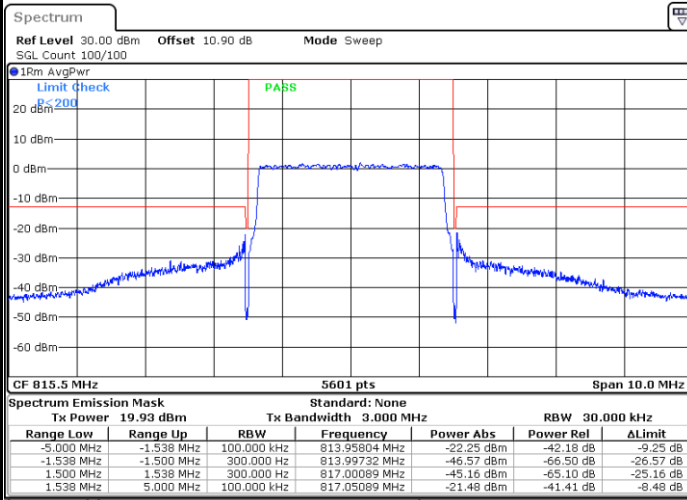

Date: 26.NOV.2021 14:32:15

Highest Band Edge / Full RB

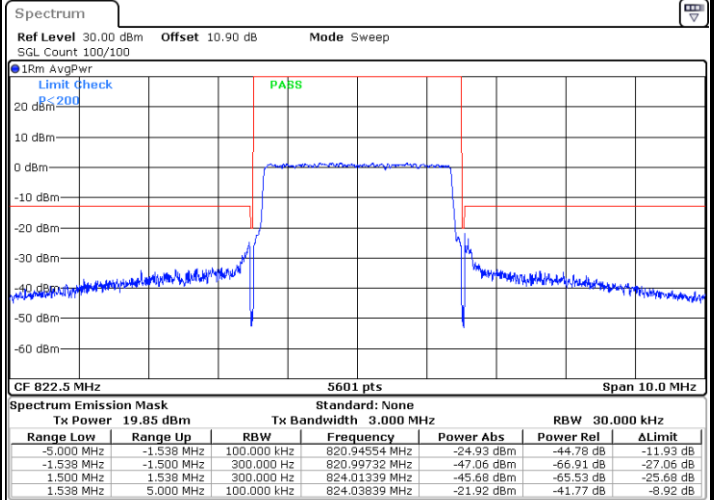

Date: 26.NOV.2021 14:34:14



LTE Band 26 / 5MHz / QPSK

Lowest Band Edge / 1 RB

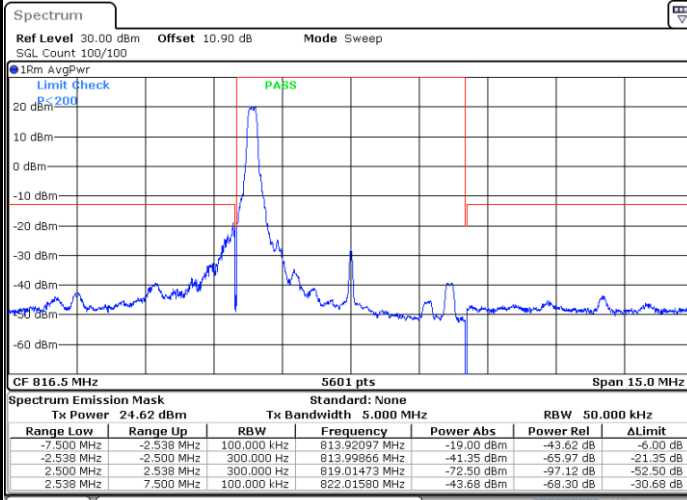

Date: 22.NOV.2021 14:00:01

Highest Band Edge / 1 RB

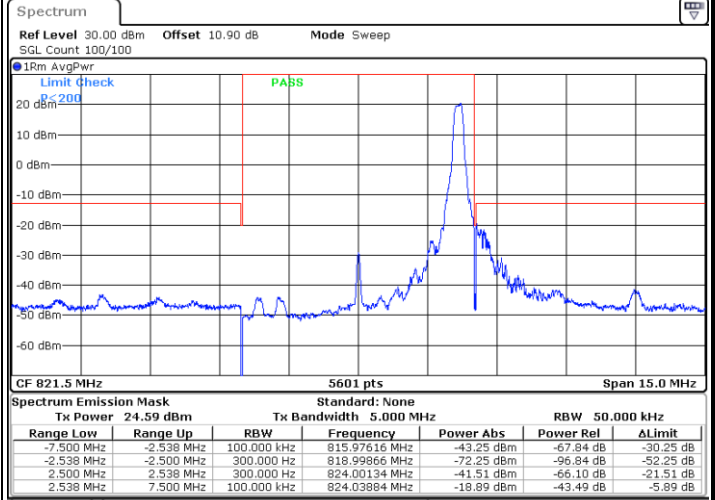

Date: 22.NOV.2021 14:02:39

Lowest Band Edge / Full RB

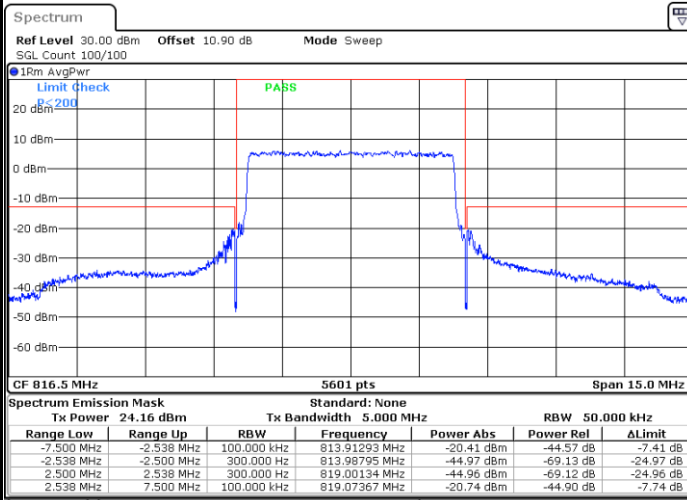

Date: 22.NOV.2021 14:01:20

Highest Band Edge / Full RB

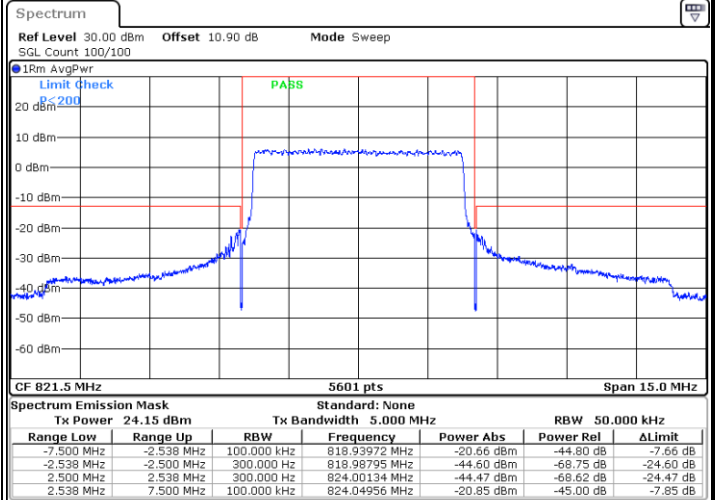

Date: 22.NOV.2021 14:03:58



LTE Band 26 / 5MHz / 16QAM

Lowest Band Edge / 1RB

Highest Band Edge / 1 RB

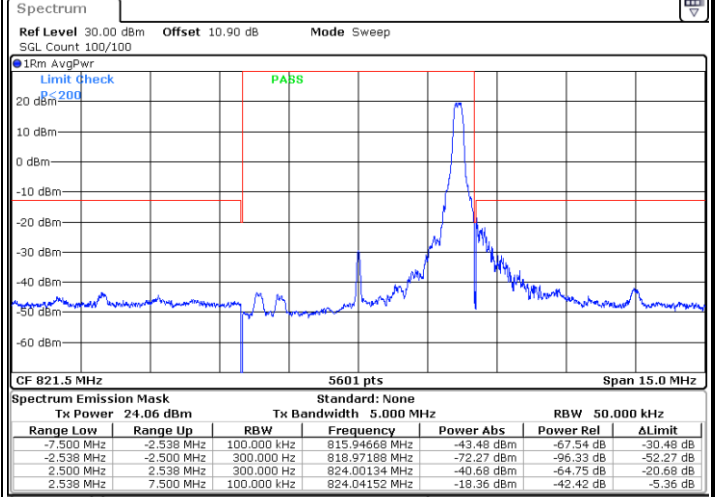
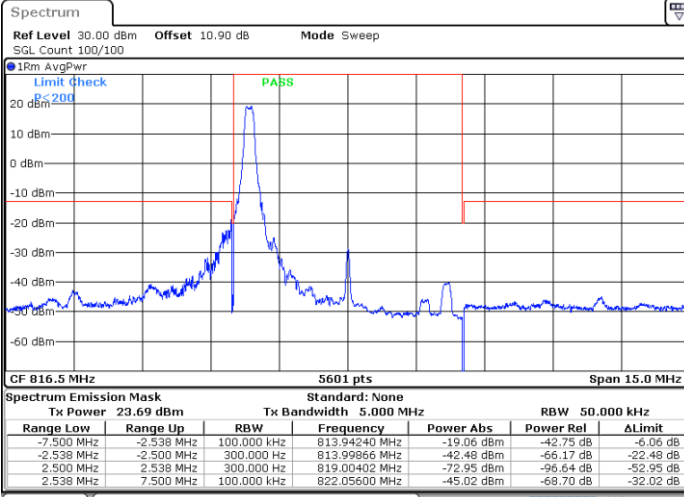

Date: 22.NOV.2021 14:00:40

Date: 22.NOV.2021 14:03:18

Lowest Band Edge / Full RB

Highest Band Edge / Full RB

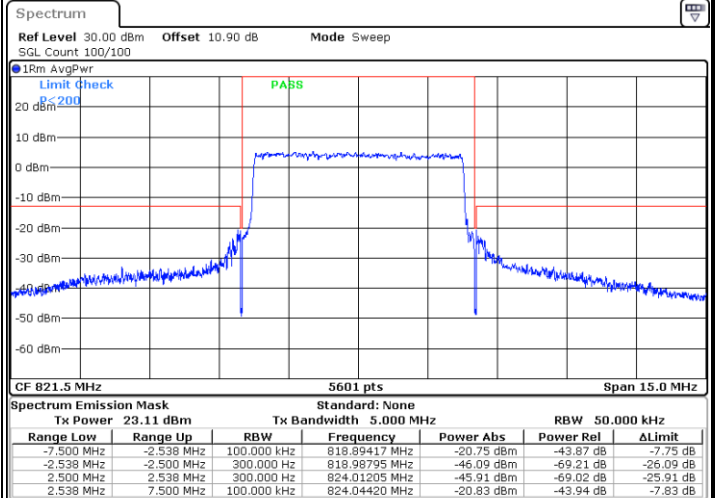
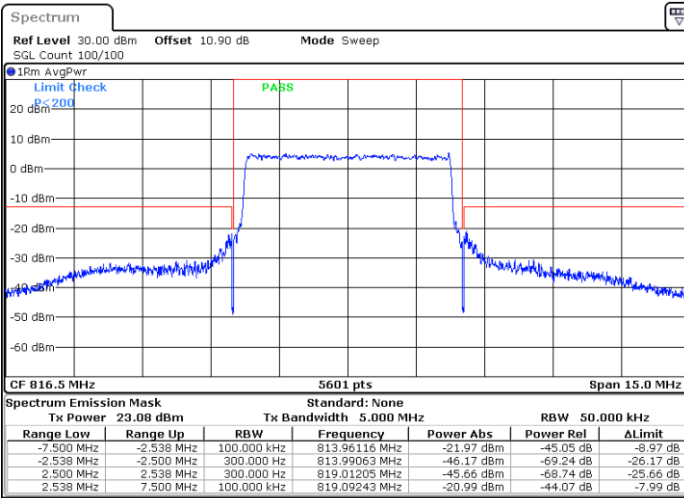

Date: 22.NOV.2021 14:01:59

Date: 22.NOV.2021 14:04:37



LTE Band 26 / 5MHz / 64QAM

Lowest Band Edge / 1RB

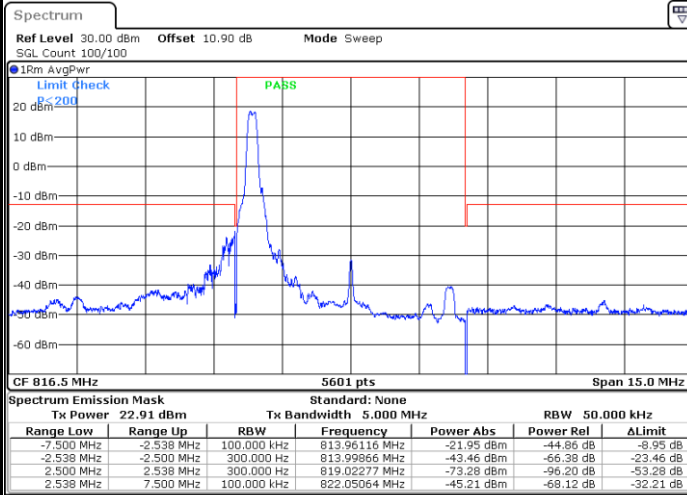

Date: 22.NOV.2021 14:33:47

Highest Band Edge / 1 RB

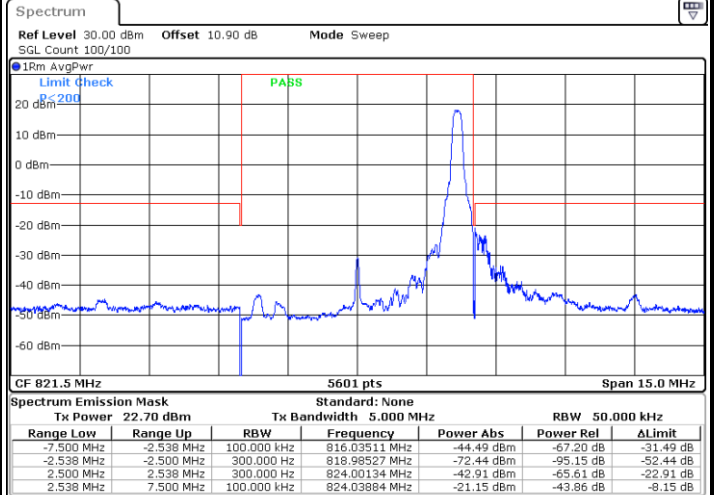

Date: 22.NOV.2021 14:35:06

Lowest Band Edge / Full RB

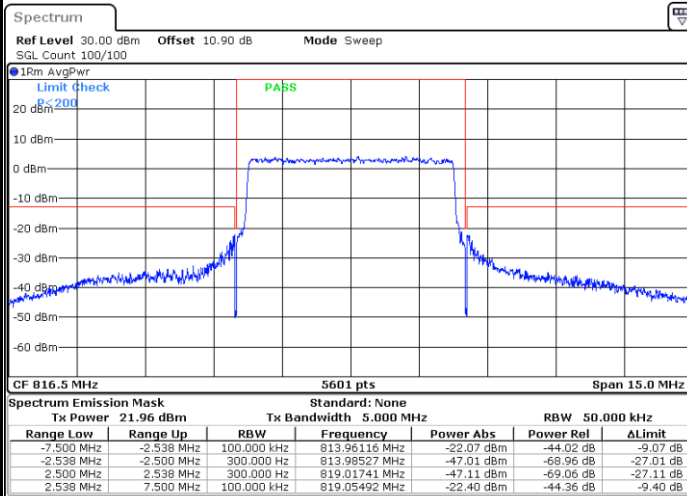

Date: 22.NOV.2021 14:34:27

Highest Band Edge / Full RB

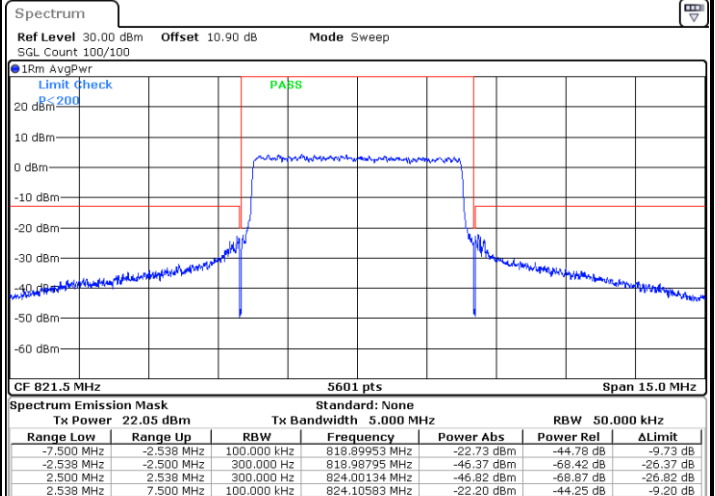

Date: 22.NOV.2021 14:35:46