



FCC RADIO TEST REPORT

FCC ID : A4RG9S9B
Equipment : Phone
Model Name : G9S9B
Applicant : Google LLC
1600 Amphitheatre Parkway,
Mountain View, California, 94043 USA
Standard : FCC Part 15 Subpart C §15.225

The product was received on Jun. 08, 2021 and testing was started from Jun. 09, 2021 and completed on Jul. 02, 2021. We, Sporton International Inc. EMC & Wireless Communications Laboratory, would like to declare that the tested sample has been evaluated in accordance with the test procedures and has been in compliance with the applicable technical standards.

The test results in this report apply exclusively to the tested model / sample. Without written approval of Sporton International Inc. EMC & Wireless Communications Laboratory, the test report shall not be reproduced except in full.

Louis Wu

Reviewed by: Louis Wu

Sporton International Inc. EMC & Wireless Communications Laboratory
No. 52, Huaya 1st Rd., Guishan Dist., Taoyuan City 333, Taiwan (R.O.C.)



Table of Contents

History of this test report.....	3
Summary of Test Result.....	4
1. General Description	5
1.1 Product Feature of Equipment Under Test	5
1.2 Product Specification of Equipment Under Test	5
1.3 Modification of EUT	5
1.4 Testing Location	6
1.5 Applicable Standards.....	6
2. Test Configuration of Equipment Under Test.....	7
2.1 Descriptions of Test Mode	7
2.2 Connection Diagram of Test System	8
2.3 Table for Supporting Units	9
2.4 EUT Operation Test Setup	9
3. Test Results	10
3.1 AC Power Line Conducted Emissions Measurement	10
3.2 20dB and 99% OBW Spectrum Bandwidth Measurement.....	12
3.3 Frequency Stability Measurement	13
3.4 Field Strength of Fundamental Emissions and Mask Measurement.....	14
3.5 Radiated Emissions Measurement	16
3.6 Antenna Requirements.....	19
4. List of Measuring Equipment	20
5. Uncertainty of Evaluation	22
Appendix A. Test Results of Conducted Emission Test	
Appendix B. Test Results of Conducted Test Items	
B1. Test Result of 20dB Spectrum Bandwidth	
B2. Test Result of Frequency Stability	
Appendix C. Test Results of Radiated Test Items	
C1. Test Result of Field Strength of Fundamental Emissions	
C2. Results of Radiated Emissions (9 kHz~30MHz)	
C3. Results of Radiated Emissions (30MHz~1GHz)	



History of this test report

Report No.	Version	Description	Issued Date
FR0D2942-04D	01	Initial issue of report	Aug. 06, 2021



Summary of Test Result

Report Clause	Ref Std. Clause	Test Items	Result (PASS/FAIL)	Remark
3.1	15.207	AC Power Line Conducted Emissions	Pass	Under limit 4.02 dB at 13.560MHz
3.2	15.215(c)	20dB Spectrum Bandwidth	Pass	-
	2.1049	99% OBW Spectrum Bandwidth	Reporting only	-
3.3	15.225(e)	Frequency Stability	Pass	-
3.4	15.225(a)(b)(c)	Field Strength of Fundamental Emissions	Pass	Max level 23.01 dB μ V/m at 13.560 MHz
3.5	15.225(d) 15.209	Radiated Spurious Emissions	Pass	Under limit 3.63 dB at 40.670MHz
3.6	15.203	Antenna Requirements	Pass	-

Declaration of Conformity:

The test results with all measurement uncertainty excluded are presented in accordance with the regulation limits or requirements declared by manufacturers.

Comments and Explanations:

The declared of product specification for EUT presented in the report are provided by the manufacturer, and the manufacturer takes all the responsibilities for the accuracy of product specification.

Reviewed by: William Chen

Report Producer: Amy Chen



1. General Description

1.1 Product Feature of Equipment Under Test

Product Feature	
Equipment	Phone
Model Name	G9S9B
FCC ID	A4RG9S9B
EUT supports Radios application	GSM/EGPRS/WCDMA/HSPA/LTE/5G NR/NFC/ GNSS/WPC/WPT WLAN 11b/g/n HT20 WLAN 11a/n HT20/HT40 WLAN 11ac VHT20/VHT40/VHT80/VHT160 WLAN 11ax HE20/HE40/HE80/HE160 Bluetooth BR/EDR/LE

Remark: The above EUT's information was declared by manufacturer.

EUT Information List	
S/N	Performed Test Item
15201FDF60009S	Conducted Emission
15211FDF60004S	Radiated Spurious Emission
15201FDF60006K	RF Measurement

1.2 Product Specification of Equipment Under Test

Standards-related Product Specification	
Tx/Rx Frequency	13.553 ~ 13.567MHz
Channel Number	1
Antenna Type	Loop Antenna
Type of Modulation	ASK

Remark: The above EUT's information was declared by manufacturer. Please refer to Comments and Explanations in report summary.

1.3 Modification of EUT

No modifications are made to the EUT during all test items.



1.4 Testing Location

Test Site	Sporton International Inc. EMC & Wireless Communications Laboratory	
Test Site Location	No.52, Huaya 1st Rd., Guishan Dist., Taoyuan City 333, Taiwan (R.O.C.) TEL: +886-3-327-3456 FAX: +886-3-328-4978	
Test Site No.	Sporton Site No.	
	TH03-HY	CO05-HY
Test Engineer	Oscar Chi	Tom Lee
Temperature	22~24°C	23~26 °C
Relative Humidity	53~55%	40~50 %

Note: The test site complies with ANSI C63.4 2014 requirement.

Test Site	Sporton International Inc. Wensan Laboratory	
Test Site Location	No.58, Aly. 75, Ln. 564, Wenhua 3rd, Rd., Guishan Dist., Taoyuan City 333010, Taiwan (R.O.C.) TEL: +886-3-327-0868 FAX: +886-3-327-0855	
Test Site No.	Sporton Site No.	
	03CH11-HY (TAF Code: 3786)	
Test Engineer	Harvey Guo	
Temperature	18.3~24.5°C	
Relative Humidity	53.4~69.3%	
Remark	The Radiated Spurious Emission test item subcontracted to Sporton International Inc. Wensan Laboratory.	

Note: The test site complies with ANSI C63.4 2014 requirement.

FCC designation No.: TW1190 and TW3786

1.5 Applicable Standards

According to the specifications of the manufacturer, the EUT must comply with the requirements of the following standards:

- ♦ FCC Part 15 Subpart C §15.225
- ♦ FCC KDB 414788 D01 Radiated Test Site v01r01
- ♦ ANSI C63.10-2013

Remark:

1. All test items were verified and recorded according to the standards and without any deviation during the test.
2. The TAF code is not including all the FCC KDB listed without accreditation.



2. Test Configuration of Equipment Under Test

2.1 Descriptions of Test Mode

Investigation has been done on all the possible configurations.

The following table is a list of the test modes shown in this test report.

Test Items	
AC Power Line Conducted Emissions	Field Strength of Fundamental Emissions
20dB Spectrum Bandwidth	Frequency Stability
Radiated Emissions 9kHz~30MHz	Radiated Emissions 30MHz~1GHz

The NFC test is performed with app “NXP” installed in the mobile phone. It can enable continuous transmission with type A/B/F/V tag respectively.

The EUT pre-scanned in reader mode with NFC tag (four NFC type A, B, F, V) and without reading tag. Based on the highest field strength of fundamental and spurious emissions, the worst case type (type F) was recorded in this report.

The measured emission level of the EUT was maximized by rotating the EUT on a turntable, adjusting the orientation of the EUT and EUT antenna in three orthogonal axis (X: flat, Y: portrait, Z: landscape), and adjusting the measurement antenna orientation, following C63.10 exploratory test procedures and find Z plane as worst plane.

Test Cases	
AC Conducted Emission	Mode 1 : WLAN Idle + Bluetooth Idle + NFC Read + USB Cable 1 (Charging from Adapter 2)
Remark: For Radiated Test Cases, the tests were performed with Adapter 2 and USB Cable 1.	

2.2 Connection Diagram of Test System

<AC Conducted Emission Mode>

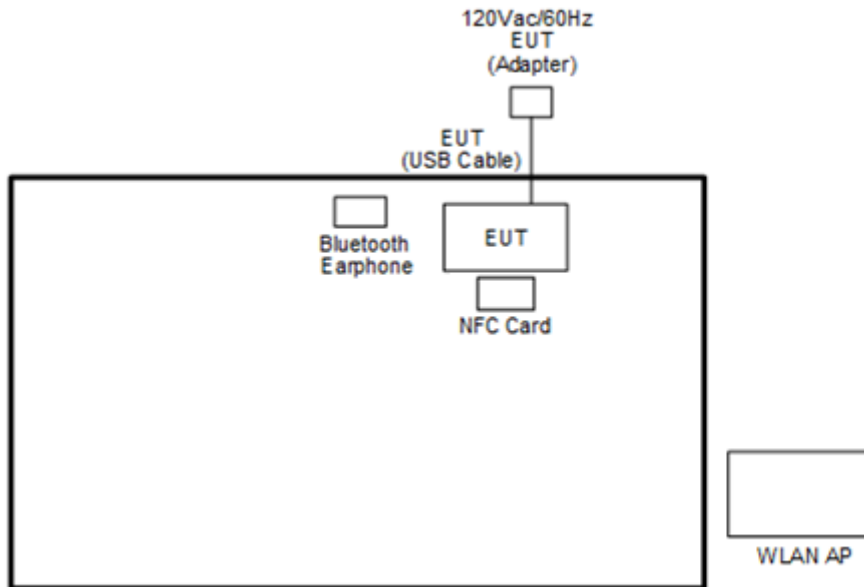

<NFC Tx with Adapter Mode>

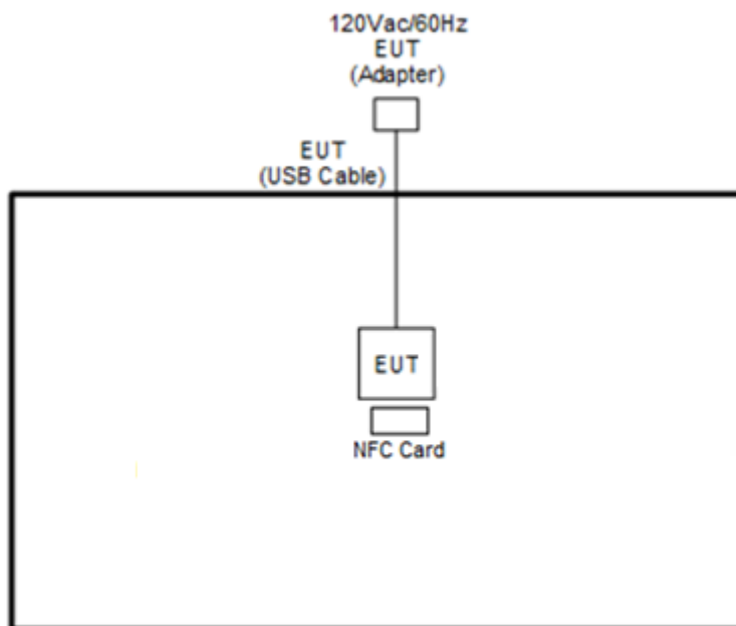

<NFC Tx with Earphone Mode>

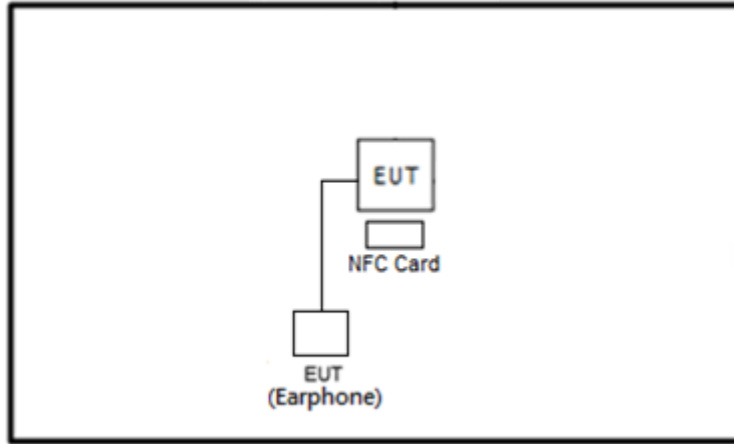

2.3 Table for Supporting Units

Item	Equipment	Brand Name	Model Name	FCC ID	Data Cable	Power Cord
1.	Bluetooth Earphone	Google	G1013	N/A	N/A	N/A
2.	WLAN AP	ASUS	RT-AC66U	MSQ-RTAC66U	N/A	Unshielded, 1.8 m
3.	Notebook	Dell	Latitude 3400	FCC DoC	N/A	AC I/P: Unshielded, 1.2 m DC O/P: Shielded, 1.8 m
4.	NFC Card	N/A	N/A	N/A	N/A	N/A

2.4 EUT Operation Test Setup

The EUT was programmed to be in continuously transmitting mode.

The ancillary equipment, NFC card, is used to make the EUT (NFC) continuously transmitting signal (Power Level: Default) at 13.56MHz and is placed around 1 cm gap to the EUT.

The RF test items, utility “NXP” was installed in Notebook which was programmed in order to make the EUT get into the engineering modes to provide channel selection, power level, data rate and the application type and for continuous transmitting signals.



3. Test Results

3.1 AC Power Line Conducted Emissions Measurement

3.1.1 Limit of AC Conducted Emission

For equipment that is designed to be connected to the public utility (AC) power line, the radio frequency voltage that is conducted back onto the AC power line on any frequency or frequencies within the band 150 kHz to 30 MHz shall not exceed the limits in the following table.

Frequency of Emission (MHz)	Conducted Limit (dB μ V)	
	Quasi-Peak	Average
0.15-0.5	66 to 56*	56 to 46*
0.5-5	56	46
5-30	60	50

*Decreases with the logarithm of the frequency.

3.1.2 Measuring Instruments

See list of measuring equipment of this test report.

3.1.3 Test Procedures

1. The EUT was placed 0.4 meter from the conducting wall of the shielding room, and it was kept at least 80 centimeters from any other grounded conducting surface.
2. Connect EUT to the power mains through a line impedance stabilization network (LISN).
3. All the support units are connecting to the other LISN.
4. The LISN provides 50 ohm coupling impedance for the measuring instrument.
5. The FCC states that a 50 ohm, 50 microhenry LISN shall be used.
6. Both sides of AC line were checked for maximum conducted interference.
7. The frequency range from 150 kHz to 30 MHz was searched.
8. Set the test-receiver system to Peak Detect Function and specified bandwidth (IF Bandwidth = 9kHz) with Maximum Hold Mode. Then measurement is also conducted by Average Detector and Quasi-Peak Detector Function respectively.

3.1.4 Test setup

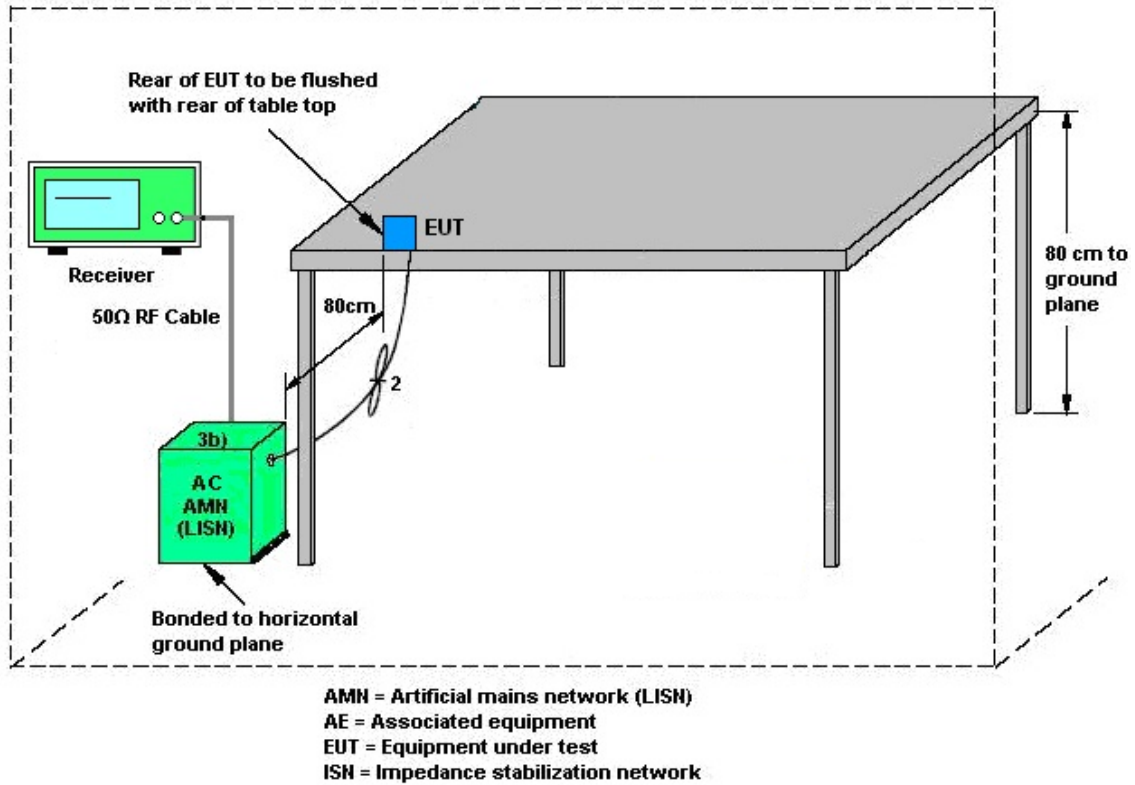

3.1.5 Test Result of AC Conducted Emission

Please refer to Appendix A.

3.2 20dB and 99% OBW Spectrum Bandwidth Measurement

3.2.1 Limit

Intentional radiators must be designed to ensure that the 20 dB and 99% emission bandwidth in the specific band 13.553~13.567 MHz.

3.2.2 Measuring Instruments

See list of measuring instruments of this test report.

3.2.3 Test Procedures

1. The spectrum analyzer connected via a receive antenna placed near the EUT in peak Max Hold Mode.
2. The resolution bandwidth of 1 kHz and the video bandwidth of 3 kHz were used.
3. Measured the spectrum width with power higher than 20 dB below carrier.
4. Measured the 99% OBW.

3.2.4 Test Setup

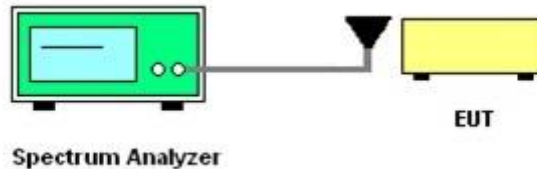

3.2.5 Test Result of Conducted Test Items

Please refer to Appendix B.

3.3 Frequency Stability Measurement

3.3.1 Limit

The frequency tolerance of the carrier signal shall be maintained within +/- 0.01% (100ppm) of the operating frequency over a temperature variation of -20 degrees to +50 degrees C at normal supply voltage, and for a variation in the primary supply voltage from 85% to 115% of the rated supply voltage at a temperature of 20 degrees C. For battery operated equipment, the equipment tests shall be performed by using a new battery.

3.3.2 Measuring Instruments

See list of measuring instruments of this test report.

3.3.3 Test Procedures

1. The spectrum analyzer connected via a receive antenna placed near the EUT.
2. EUT has transmitted signal and fixed channelize.
3. Set the spectrum analyzer span to view the entire emissions bandwidth.
4. Set RBW = 1 kHz, VBW = 3 kHz with peak detector and maxhold settings.
5. The f_c is declaring of channel frequency. Then the frequency error formula is $(f_c - f) / f_c \times 10^6$ ppm and the limit is less than ± 100 ppm.
6. Extreme temperature rule is -20°C~50°C.

3.3.4 Test Setup



3.3.5 Test Result of Conducted Test Items

Please refer to Appendix B.



3.4 Field Strength of Fundamental Emissions and Mask Measurement

3.4.1 Limit

Rules and specifications	FCC CFR 47 Part 15 section 15.225			
Description	Compliance with the spectrum mask is tested with RBW set to 9kHz.			
Freq. of Emission (MHz)	Field Strength (μV/m) at 30m	Field Strength (dBμV/m) at 30m	Field Strength (dBμV/m) at 10m	Field Strength (dBμV/m) at 3m
1.705~13.110	30	29.5	48.58	69.5
13.110~13.410	106	40.5	59.58	80.5
13.410~13.553	334	50.5	69.58	90.5
13.553~13.567	15848	84.0	103.08	124.0
13.567~13.710	334	50.5	69.58	90.5
13.710~14.010	106	40.5	59.58	80.5
14.010~30.000	30	29.5	48.58	69.5

Remark:

1. The field strength test result is in 3m test distance, follow test rules the test data use distance extrapolation factor and reported in this report at 30m test result.
2. Distance extrapolation factor = $40 \log(\text{specific distance} / \text{test distance})$ (dB)

3.4.2 Measuring Instruments

See list of measuring instruments of this test report.

3.4.3 Test Procedures

1. Configure the EUT according to ANSI C63.10. The EUT was placed on the top of the turntable 0.8 meter above ground. The phase center of the loop receiving antenna mounted antenna tower was placed 3 meters far away from the turntable.
 2. Power on the EUT and all the supporting units. The turntable was rotated by 360 degrees to determine the position of the highest radiation.
 3. The height of the receiving antenna was fixed at one meter above ground to find the maximum emissions field strength.
 4. For Fundamental emissions, use the receiver to measure QP reading.
 5. When the radiated emissions limits are expressed in terms of the average value of the emissions, and pulsed operation is employed, the measurement field strength shall be determined by averaging over one complete pulse train, including blanking intervals, as long as the pulse train does not exceed 0.1 seconds. As an alternative (provided the transmitter operates for longer than 0.1 seconds) or in cases where the pulse train exceeds 0.1 seconds, the measured field strength shall be determined from the average absolute voltage during a 0.1 second interval during which the field strength is at its maximum value.
 6. Compliance with the spectrum mask is tested with RBW set to 9 kHz.
- Note: Emission level (dB μ V/m) = 20 log Emission level (μ V/m).

3.4.4 Test Setup

For radiated test below 30MHz



3.4.5 Test Result of Field Strength of Fundamental Emissions and Mask

Please refer to Appendix C.



3.5 Radiated Emissions Measurement

3.5.1 Limit

The field strength of any emissions which appear outside of 13.110 ~14.010MHz band shall not exceed the general radiated emissions limits.

Frequencies (MHz)	Field Strength (μV/m)	Measurement Distance (meters)
0.009~0.490	2400/F(kHz)	300
0.490~1.705	24000/F(kHz)	30
1.705~30.0	30	30
30~88	100	3
88~216	150	3
216~960	200	3
Above 960	500	3

3.5.2 Measuring Instruments

See list of measuring instruments of this test report.

3.5.3 Measuring Instrument Setting

The following table is the setting of receiver:

Receiver Parameter	Setting
Attenuation	Auto
Frequency Range: 9kHz~150kHz	RBW 200Hz for QP
Frequency Range: 150kHz~30MHz	RBW 9kHz for QP
Frequency Range: 30MHz~1000MHz	RBW 120kHz for Peak

Note: The emission limits shown in the above table are based on measurements employing a CISPR quasi-peak detector except for the frequency bands 9-90 kHz and 110-490 kHz. Radiated emission limits in these two bands are based on measurements employing an average detector.



3.5.4 Test Procedures

1. Configure the EUT according to ANSI C63.10. The EUT was placed on the top of the turntable 0.8 meter above ground. The phase center of the receiving antenna mounted on the top of a height-variable antenna tower was placed 3 meters far away from the turntable.
2. Power on the EUT and all the supporting units. The turntable was rotated by 360 degrees to determine the position of the highest radiation.
3. The height of the broadband receiving antenna was varied between one meter and four meters above ground to find the maximum emissions field strength of both horizontal and vertical polarization.
4. For each suspected emissions, the antenna tower was scan (from 1 M to 4 M) and then the turntable was rotated (from 0 degree to 360 degrees) to find the maximum reading.
5. Set the test-receiver system to Peak or CISPR quasi-peak Detect Function with specified bandwidth under Maximum Hold Mode.
6. When the radiated emissions limits are expressed in terms of the average value of the emissions, and pulsed operation is employed, the measurement field strength shall be determined by averaging over one complete pulse train, including blanking intervals, as long as the pulse train does not exceed 0.1 seconds. As an alternative (provided the transmitter operates for longer than 0.1 seconds) or in cases where the pulse train exceeds 0.1 seconds, the measured field strength shall be determined from the average absolute voltage during a 0.1 second interval during which the field strength is at its maximum value.
7. In case the emission is lower than 30 MHz, loop antenna has to be used for measurement and the recorded data shall be QP measured by receiver.

3.5.5 Test Setup

For radiated test below 30MHz

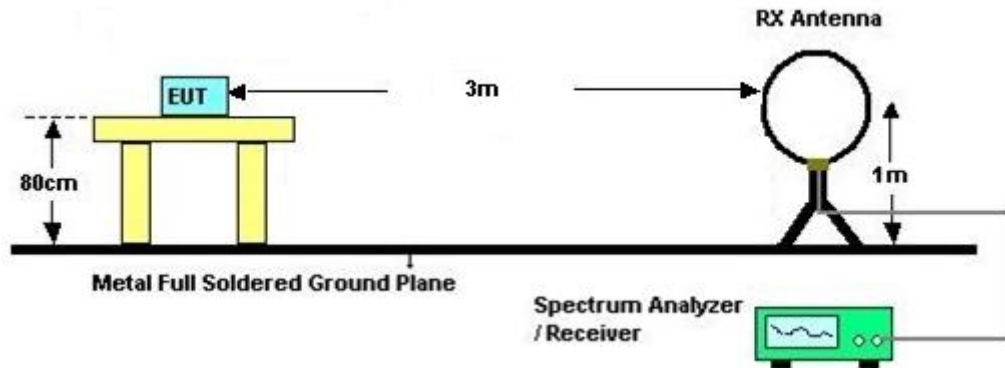

For radiated test above 30MHz

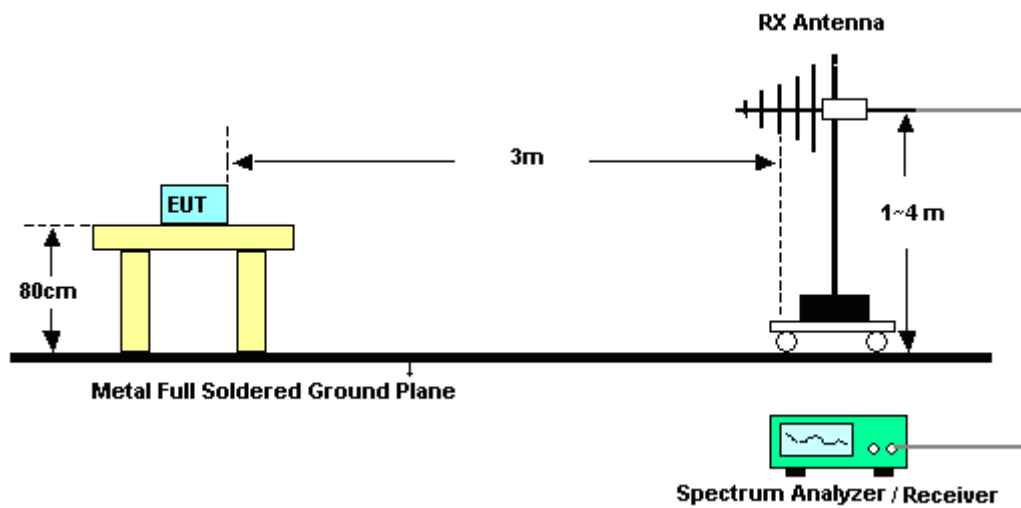

3.5.6 Test Result of Radiated Emissions Measurement

Please refer to Appendix C.

Remark: There is adequate comparison measurement of both open-field test site and alternative test site - semi-Anechoic chamber according to 414788 D01 Radiated Test Site v01r01, and the result came out very similar.



3.6 Antenna Requirements

3.6.1 Standard Applicable

Except for special regulations, the Low-power Radio-frequency Devices must not be equipped with any jacket for installing an antenna with extension cable. An intentional radiator shall be designed to ensure that no antenna other than that furnished by the responsible party shall be used with the device. The use of a permanently attached antenna or of an antenna that uses a unique coupling to the intentional radiator shall be considered sufficient to comply with the provisions of this Section. The manufacturer may design the unit so that the user can replace a broken antenna, but the use of a standard antenna jack or electrical connector is prohibited.

The use of a permanently attached antenna or of an antenna that uses a unique coupling to the intentional radiator shall be considered sufficient to comply with the rule.

3.6.2 Antenna Anti-Replacement Construction

An embedded-in antenna design is used.



4. List of Measuring Equipment

Instrument	Brand Name	Model No.	Serial No.	Characteristics	Calibration Date	Test Date	Due Date	Remark
Software	Audix	E3 6.2009-8-24	RK-001053	N/A	N/A	Jun. 09, 2021~ Jun. 22, 2021	N/A	Radiation (03CH11-HY)
Amplifier	SONOMA	310N	187312	9kHz~1GHz	Dec. 02, 2020	Jun. 09, 2021~ Jun. 22, 2021	Dec. 01, 2021	Radiation (03CH11-HY)
Bilog Antenna	TESEQ	CBL 6111D & N-6-06	35414 & AT-N0602	30MHz~1GHz	Oct. 11, 2020	Jun. 09, 2021~ Jun. 22, 2021	Oct. 10, 2021	Radiation (03CH11-HY)
Loop Antenna	Rohde & Schwarz	HFH2-Z2	100315	9 kHz~30 MHz	Jan. 04, 2021	Jun. 09, 2021~ Jun. 22, 2021	Jan. 03, 2022	Radiation (03CH11-HY)
Controller	EMEC	EM 1000	N/A	Control Turn table & Ant Mast	N/A	Jun. 09, 2021~ Jun. 22, 2021	N/A	Radiation (03CH11-HY)
Antenna Mast	EMEC	AM-BS-4500-B	N/A	1~4m	N/A	Jun. 09, 2021~ Jun. 22, 2021	N/A	Radiation (03CH11-HY)
Turn Table	EMEC	TT 2000	N/A	0~360 Degree	N/A	Jun. 09, 2021~ Jun. 22, 2021	N/A	Radiation (03CH11-HY)
Spectrum Analyzer	Keysight	N9010A	MY54200486	10Hz~44GHz	Oct. 23, 2020	Jun. 09, 2021~ Jun. 22, 2021	Oct. 22, 2021	Radiation (03CH11-HY)
EMI Test Receiver	Keysight	N9038A(MXE)	MY57290111	20MHz~8.4GHz	Dec. 11, 2020	Jun. 09, 2021~ Jun. 22, 2021	Dec. 10, 2021	Radiation (03CH11-HY)
Filter	Wainwright	WHK20/1000C 7/40SS	SN2	20M High Pass	Sep. 14, 2020	Jun. 09, 2021~ Jun. 22, 2021	Sep. 13, 2021	Radiation (03CH11-HY)
RF Cable	HUBER + SUHNER	SUCOFLEX 104	MY9837/4PE	9kHz-30MHz	Mar. 11, 2021	Jun. 09, 2021~ Jun. 22, 2021	Mar. 10, 2022	Radiation (03CH11-HY)
RF Cable	HUBER + SUHNER	SUCOFLEX 104	MY9837/4PE	30M-18G	Mar. 11, 2021	Jun. 09, 2021~ Jun. 22, 2021	Mar. 10, 2022	Radiation (03CH11-HY)
RF Cable	HUBER + SUHNER	SUCOFLEX 102	MY2859/2	30MHz-40GHz	Mar. 11, 2021	Jun. 09, 2021~ Jun. 22, 2021	Mar. 10, 2022	Radiation (03CH11-HY)
RF Cable	HUBER + SUHNER	SUCOFLEX 102	MY4274/2	30MHz-40GHz	Mar. 11, 2021	Jun. 09, 2021~ Jun. 22, 2021	Mar. 10, 2022	Radiation (03CH11-HY)
Hygrometer	TECPEL	DTN-303B	TP200880	QA-3-031	Oct. 22, 2020	Jun. 09, 2021~ Jun. 22, 2021	Oct. 21, 2021	Radiation (03CH11-HY)
Hygrometer	TECPEL	DTN-303B	TP140325	N/A	Nov. 18, 2020	Jun. 09, 2021~ Jun. 22, 2021	Nov. 17, 2021	Radiation (03CH11-HY)
AC Power Source	ChainTek	APC-1000W	N/A	N/A	N/A	Jun. 09, 2021	N/A	Conducted (TH03-HY)
Hygrometer	Testo	608-H1	34893241	N/A	Mar. 03, 2021	Jun. 09, 2021	Mar. 02, 2022	Conducted (TH03-HY)
Spectrum Analyzer	Rohde & Schwarz	FSP30	101329	9kHz~30GHz	Sep. 03, 2020	Jun. 09, 2021	Sep. 02, 2021	Conducted (TH03-HY)
Temperature Chamber	ESPEC	SH-641	92013720	-40°C ~90°C	Sep. 14, 2020	Jun. 09, 2021	Sep. 13, 2021	Conducted (TH03-HY)



Instrument	Brand Name	Model No.	Serial No.	Characteristics	Calibration Date	Test Date	Due Date	Remark
AC Power Source	ChainTek	APC-1000W	N/A	N/A	N/A	Jul. 02, 2021	N/A	Conduction (CO05-HY)
EMI Test Receiver	Rohde & Schwarz	ESR3	102388	9kHz~3.6GHz	Nov. 30, 2020	Jul. 02, 2021	Nov. 29, 2021	Conduction (CO05-HY)
Hygrometer	Testo	608-H1	34913912	N/A	Nov. 18, 2020	Jul. 02, 2021	Nov. 17, 2021	Conduction (CO05-HY)
LISN	Rohde & Schwarz	ENV216	100081	9kHz~30MHz	Nov. 16, 2020	Jul. 02, 2021	Nov. 15, 2021	Conduction (CO05-HY)
Software	Rohde & Schwarz	EMC32 V10.30	N/A	N/A	N/A	Jul. 02, 2021	N/A	Conduction (CO05-HY)
Pulse Limiter	Rohde & Schwarz	ESH3-Z2	100851	N/A	Feb. 25, 2021	Jul. 02, 2021	Feb. 24, 2022	Conduction (CO05-HY)
LISN Cable	MVE	RG-400	260260	N/A	Dec. 31, 2020	Jul. 02, 2021	Dec. 30, 2021	Conduction (CO05-HY)



5. Uncertainty of Evaluation

Uncertainty of Conducted Emission Measurement (150 kHz ~ 30 MHz)

Measuring Uncertainty for a Level of Confidence of 95% ($U = 2Uc(y)$)	2.30 dB
-------------------------------------------------------------------------	---------

Uncertainty of Radiated Emission Measurement (9 kHz ~ 30 MHz)

Measuring Uncertainty for a Level of Confidence of 95% ($U = 2Uc(y)$)	2.68 dB
-------------------------------------------------------------------------	---------

Uncertainty of Radiated Emission Measurement (30 MHz ~ 1000 MHz)

Measuring Uncertainty for a Level of Confidence of 95% ($U = 2Uc(y)$)	4.70 dB
-------------------------------------------------------------------------	---------



Appendix A. Test Results of Conducted Emission Test

Test Engineer : Tom Lee	Temperature :	23~26°C
	Relative Humidity :	40~50%

EUT Information

Report NO : 0D2942-04
 Test Mode : Mode 1
 Test Voltage : 120Vac/60Hz
 Phase : Line

Full Spectrum

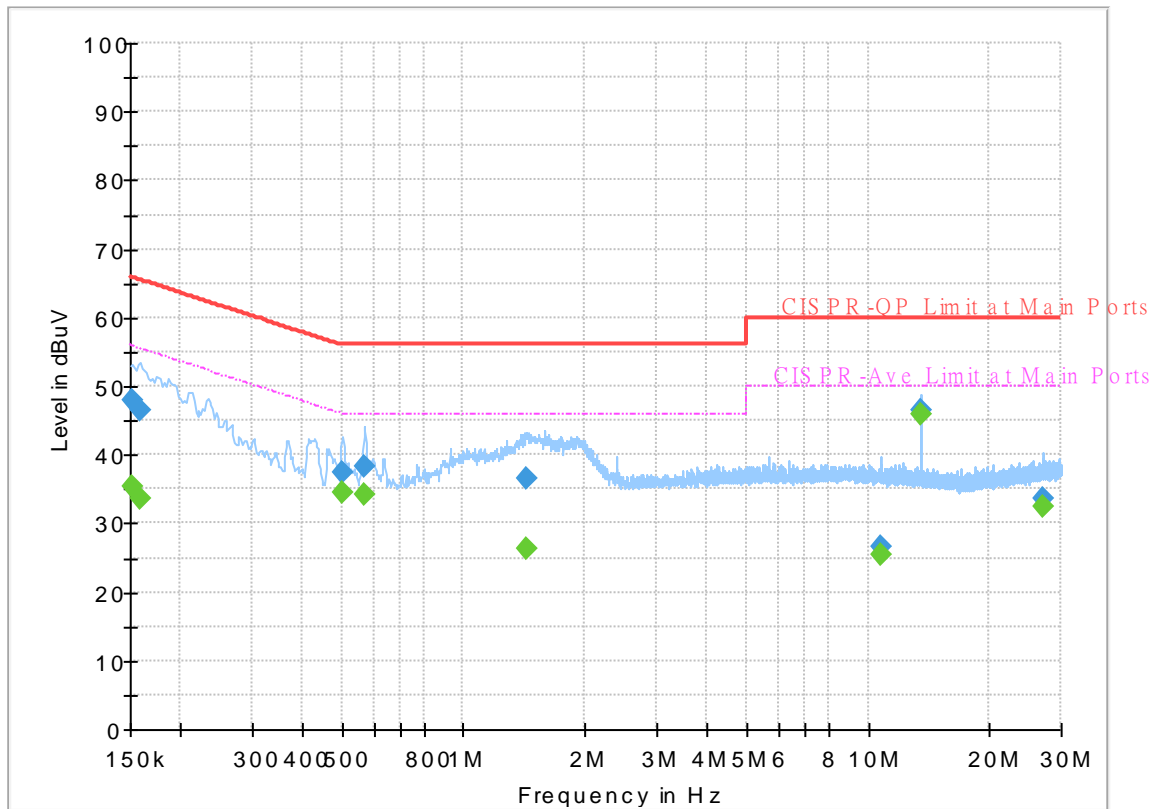

Final_Result

Frequency (MHz)	QuasiPeak (dBuV)	CAverage (dBuV)	Limit (dBuV)	Margin (dB)	Line	Filter	Corr. (dB)
0.152250	---	35.26	55.88	20.62	L1	OFF	19.5
0.152250	48.03	---	65.88	17.85	L1	OFF	19.5
0.159000	---	33.69	55.52	21.83	L1	OFF	19.5
0.159000	46.39	---	65.52	19.13	L1	OFF	19.5
0.503250	---	34.52	46.00	11.48	L1	OFF	19.7
0.503250	37.50	---	56.00	18.50	L1	OFF	19.7
0.568500	---	34.32	46.00	11.68	L1	OFF	19.7
0.568500	38.40	---	56.00	17.60	L1	OFF	19.7
1.434750	---	26.17	46.00	19.83	L1	OFF	20.0
1.434750	36.42	---	56.00	19.58	L1	OFF	20.0
10.707000	---	25.31	50.00	24.69	L1	OFF	20.0
10.707000	26.70	---	60.00	33.30	L1	OFF	20.0
13.560000	---	45.98	50.00	4.02	L1	OFF	20.1
13.560000	46.53	---	60.00	13.47	L1	OFF	20.1
27.120000	---	32.34	50.00	17.66	L1	OFF	20.6
27.120000	33.57	---	60.00	26.43	L1	OFF	20.6

EUT Information

Report NO : 0D2942-04
 Test Mode : Mode 1
 Test Voltage : 120Vac/60Hz
 Phase : Neutral

Full Spectrum

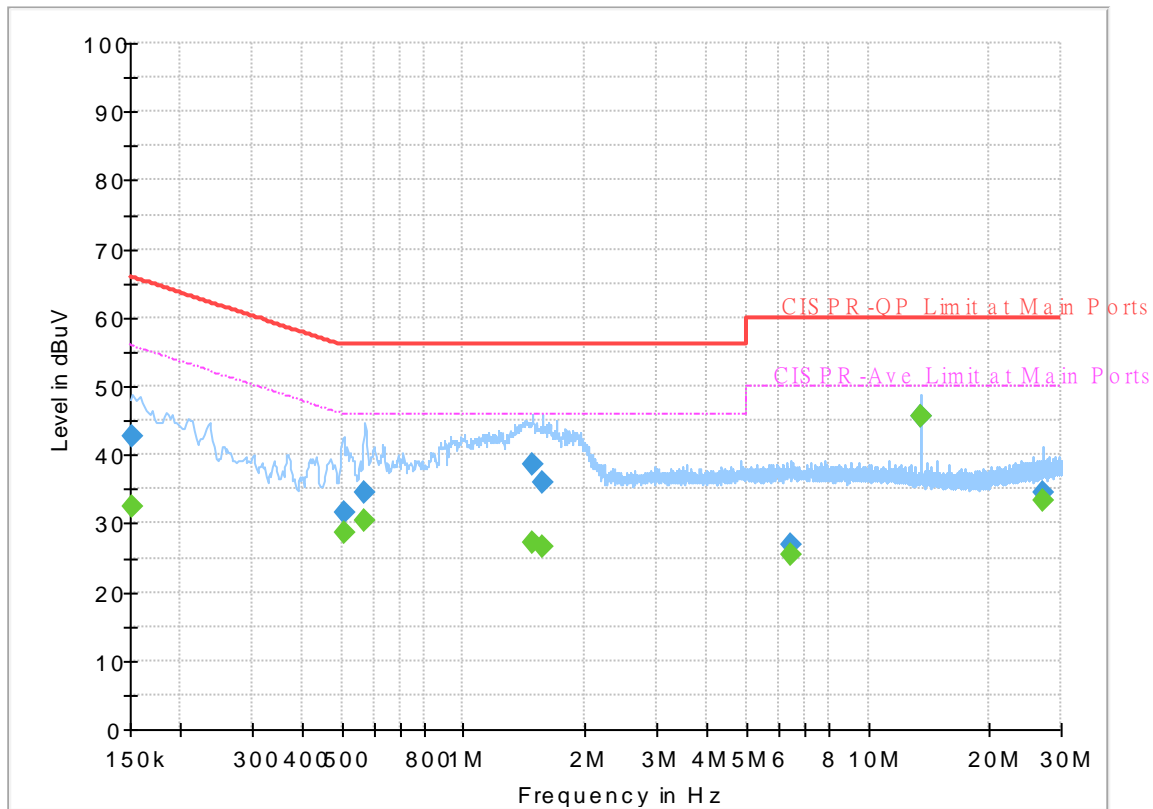

Final_Result

Frequency (MHz)	QuasiPeak (dBuV)	CAverage (dBuV)	Limit (dBuV)	Margin (dB)	Line	Filter	Corr. (dB)
0.152250	---	32.41	55.88	23.47	N	OFF	19.5
0.152250	42.64	---	65.88	23.24	N	OFF	19.5
0.505500	---	28.61	46.00	17.39	N	OFF	19.7
0.505500	31.54	---	56.00	24.46	N	OFF	19.7
0.570750	---	30.35	46.00	15.65	N	OFF	19.8
0.570750	34.50	---	56.00	21.50	N	OFF	19.8
1.486500	---	27.29	46.00	18.71	N	OFF	20.0
1.486500	38.57	---	56.00	17.43	N	OFF	20.0
1.567500	---	26.62	46.00	19.38	N	OFF	20.0
1.567500	35.92	---	56.00	20.08	N	OFF	20.0
6.459000	---	25.48	50.00	24.52	N	OFF	20.0
6.459000	26.94	---	60.00	33.06	N	OFF	20.0
13.560000	---	45.58	50.00	4.42	N	OFF	20.2
13.560000	45.59	---	60.00	14.41	N	OFF	20.2
27.120000	---	33.25	50.00	16.75	N	OFF	20.8
27.120000	34.49	---	60.00	25.51	N	OFF	20.8



Appendix B. Test Results of Conducted Test Items

B1. Test Result of 20dB Spectrum Bandwidth

Test mode	NFC Tx	Test Frequency (MHz)	13.56
20dB Bandwidth (kHz)	2.640	99% OccupiedBW(kHz)	2.240
Frequency range (MHz)	$f_L > 13.553$	13.55890	Test Result
	$f_H < 13.567$	13.56154	Complies

Remark: Because the measured signal is CW adjusting the RBW per C63.10 would not be practical since measured bandwidth will always follow the RBW and the result will be approximately twice the RBW.



B2. Test Result of Frequency Stability

Voltage vs. Frequency Stability		Temperature vs. Frequency Stability		
Voltage (Vac)	Measurement Frequency (MHz)	Temperature (°C)	Time	Measurement Frequency (MHz)
120	13.560220	-20	0	13.560260
102	13.560220		2	13.560260
138	13.560220		5	13.560260
			10	13.560260
		-10	0	13.560260
			2	13.560260
			5	13.560260
			10	13.560260
		0	0	13.560240
			2	13.560240
			5	13.560240
			10	13.560240
		10	0	13.560220
			2	13.560230
			5	13.560220
			10	13.560240
		20	0	13.560220
			2	13.560220
			5	13.560220
			10	13.560220
		30	0	13.560260
			2	13.560250
			5	13.560260
			10	13.560250
		40	0	13.560240
			2	13.560240
			5	13.560240
			10	13.560230



Voltage vs. Frequency Stability		Temperature vs. Frequency Stability		
Voltage (Vac)	Measurement Frequency (MHz)	Temperature (°C)	Time	Measurement Frequency (MHz)
		50	0	13.560220
			2	13.560210
			5	13.560220
			10	13.560200
Max.Deviation (MHz)	0.000220	Max.Deviation (MHz)		0.000260
Max.Deviation (ppm)	16.2242	Max.Deviation (ppm)		19.1740
Limit	FS < ±100 ppm	Limit		FS < ±100 ppm
Test Result	PASS	Test Result		PASS



Appendix C. Test Results of Radiated Test Items

C1. Test Result of Field Strength of Fundamental Emissions

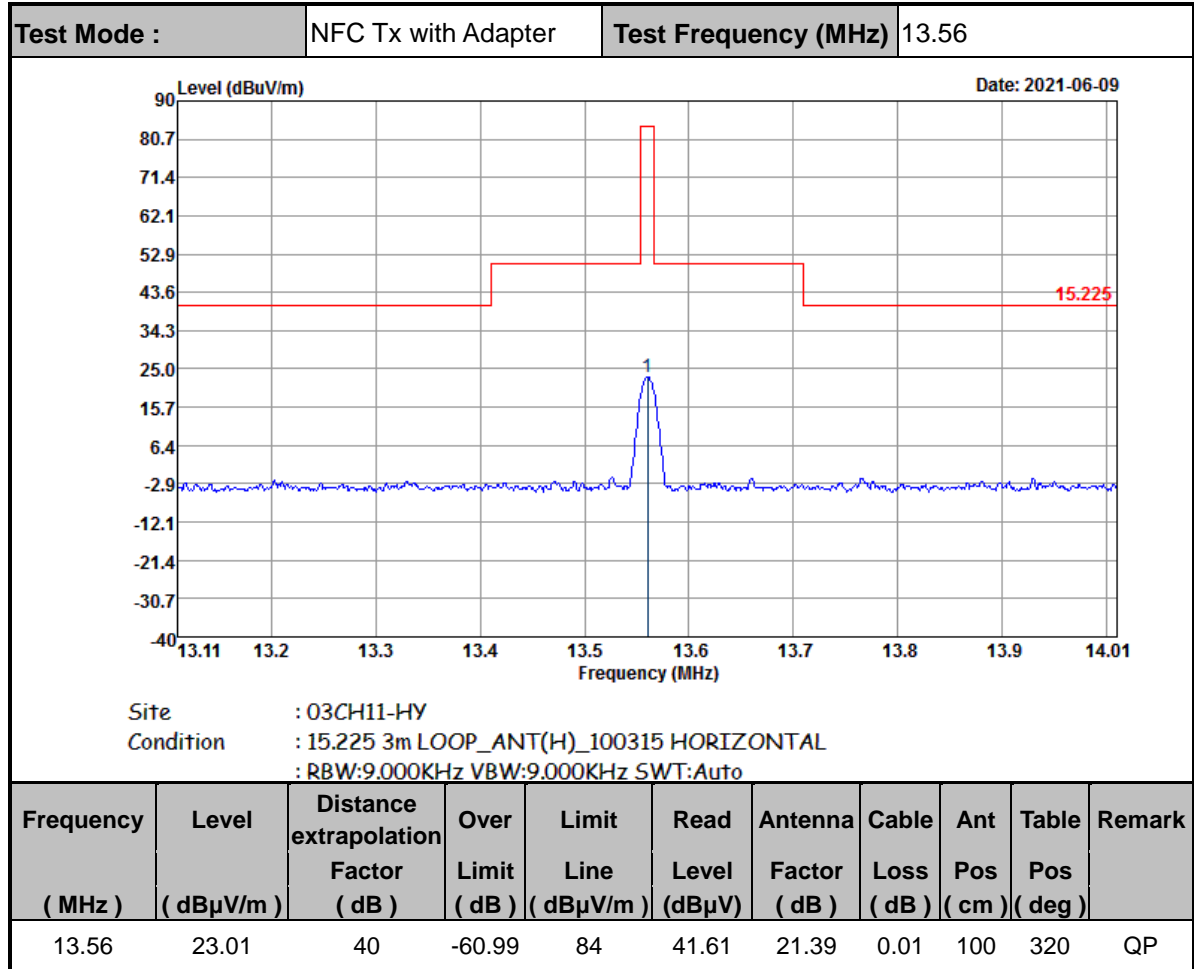

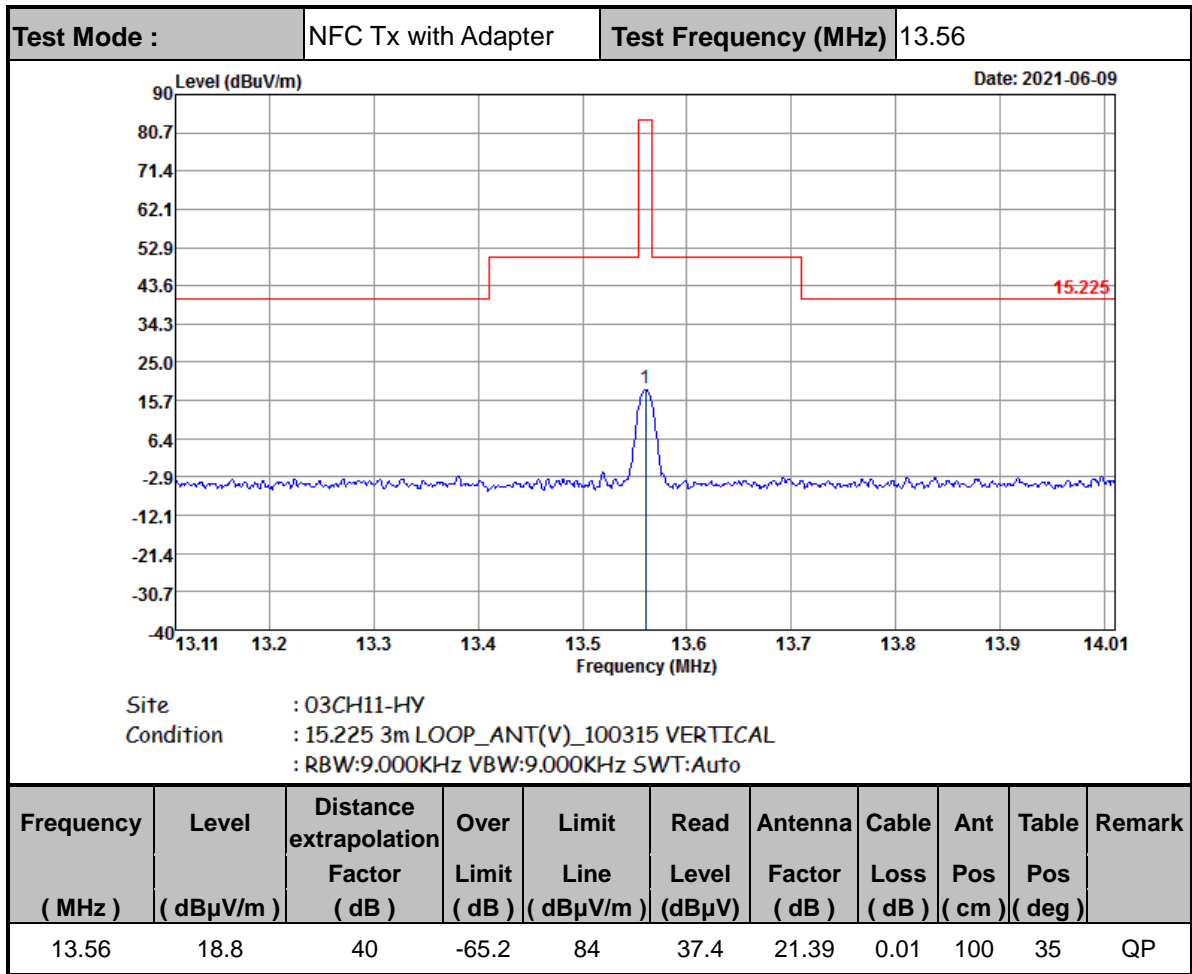

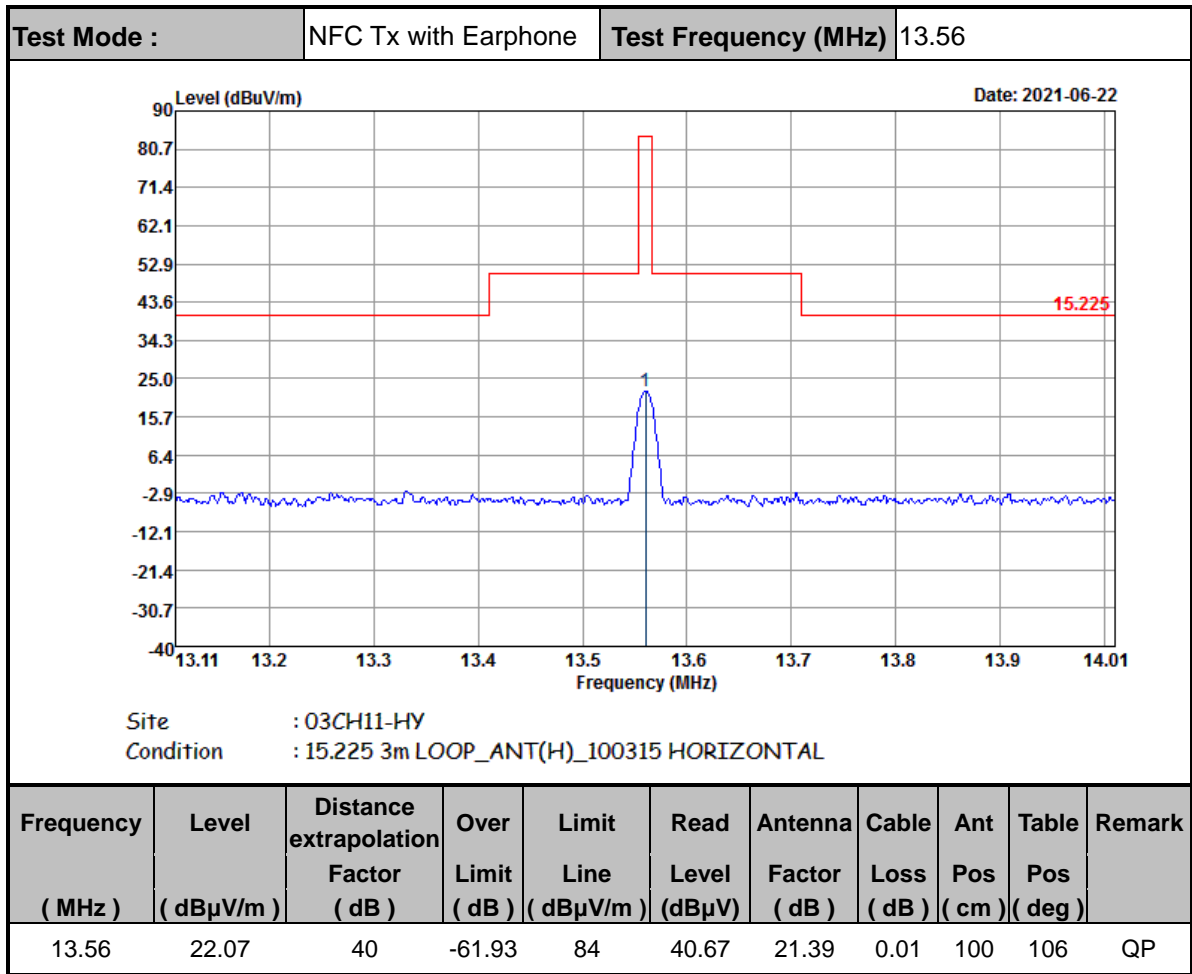

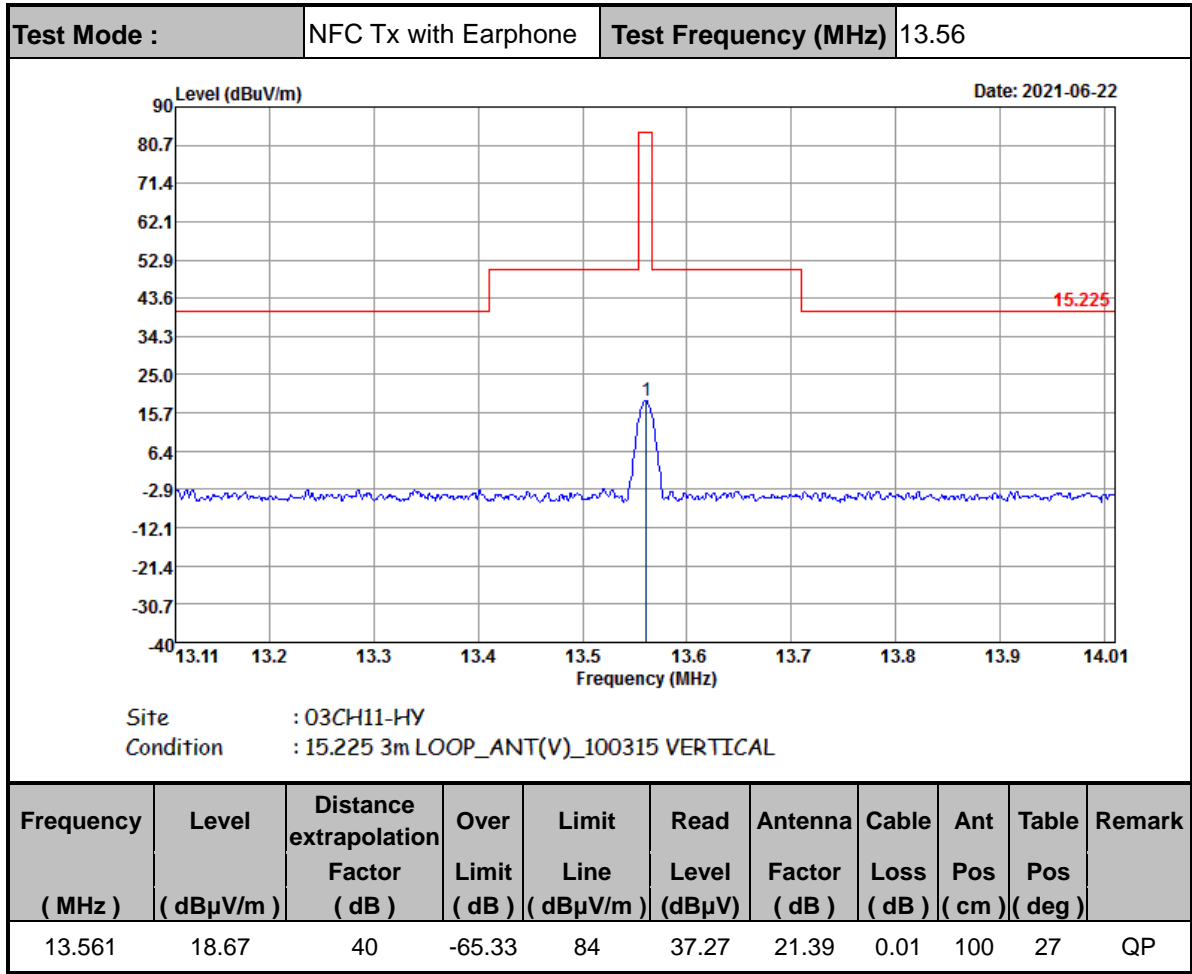



C2. Results of Radiated Spurious Emissions (9 kHz~30MHz)

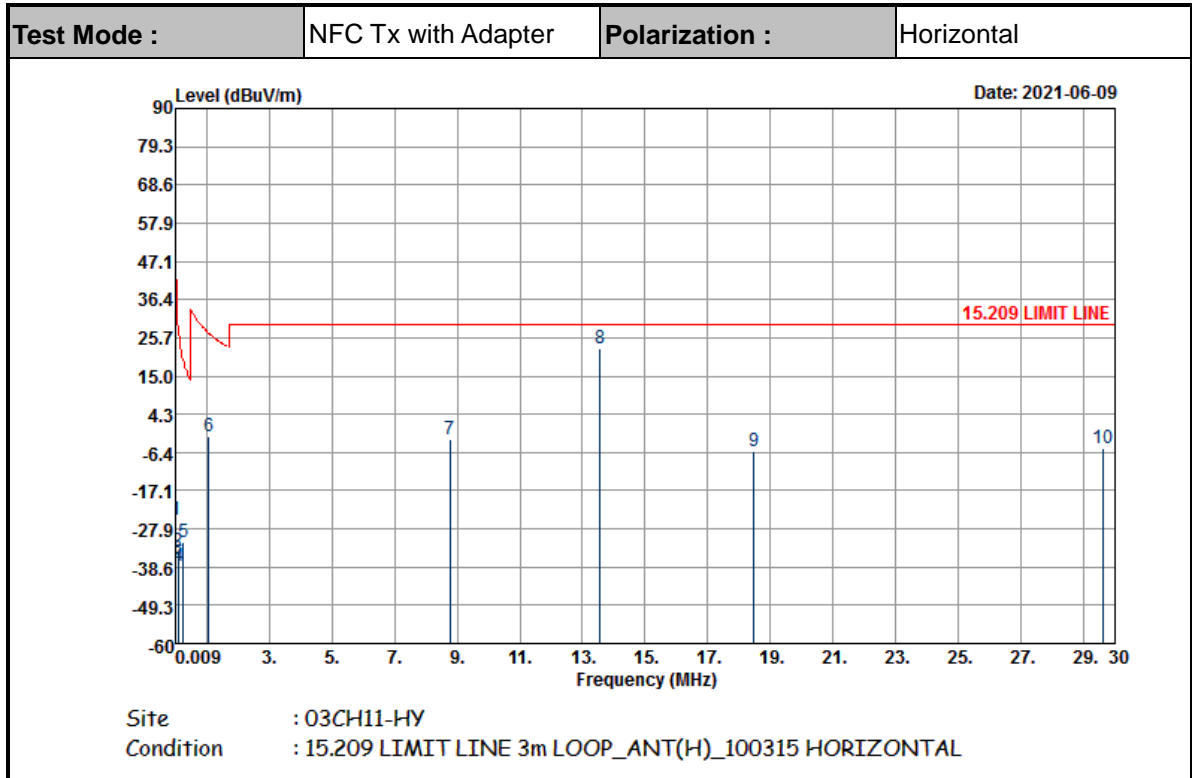

Frequency (MHz)	Level (dBμV/m)	Distance extrapolation Factor (dB)	Over Limit (dB)	Limit Line (dBμV/m)	Read Level (dBμV)	Antenna Factor (dB)	Cable Loss (dB)	Ant Pos (cm)	Table Pos (deg)	Remark
0.0192	-25.52	80	-67.46	41.94	35.55	18.91	0.02	-	-	Average
0.08712	-34.22	80	-63.02	28.8	27.33	18.43	0.02	-	-	Average
0.09016	-36.31	80	-64.81	28.5	25.31	18.36	0.02	-	-	QP
0.11004	-38.39	80	-65.16	26.77	23.44	18.15	0.02	-	-	Average
0.25608	-31.51	80	-50.95	19.44	29.67	18.8	0.02	-	-	Average
1.061	-2.09	40	-29.18	27.09	18.79	19.1	0.02	100	0	QP
8.76	-2.95	40	-32.45	29.5	16.43	20.6	0.02	-	-	QP
13.56	22.65	40	-6.85	29.5	41.25	21.39	0.01	-	-	QP
18.475	-6.01	40	-35.51	29.5	12.02	21.93	0.04	-	-	QP
29.605	-5.06	40	-34.56	29.5	12.2	22.48	0.26	-	-	QP



Test Mode :	NFC Tx with Adapter	Polarization :	Vertical
-------------	---------------------	----------------	----------

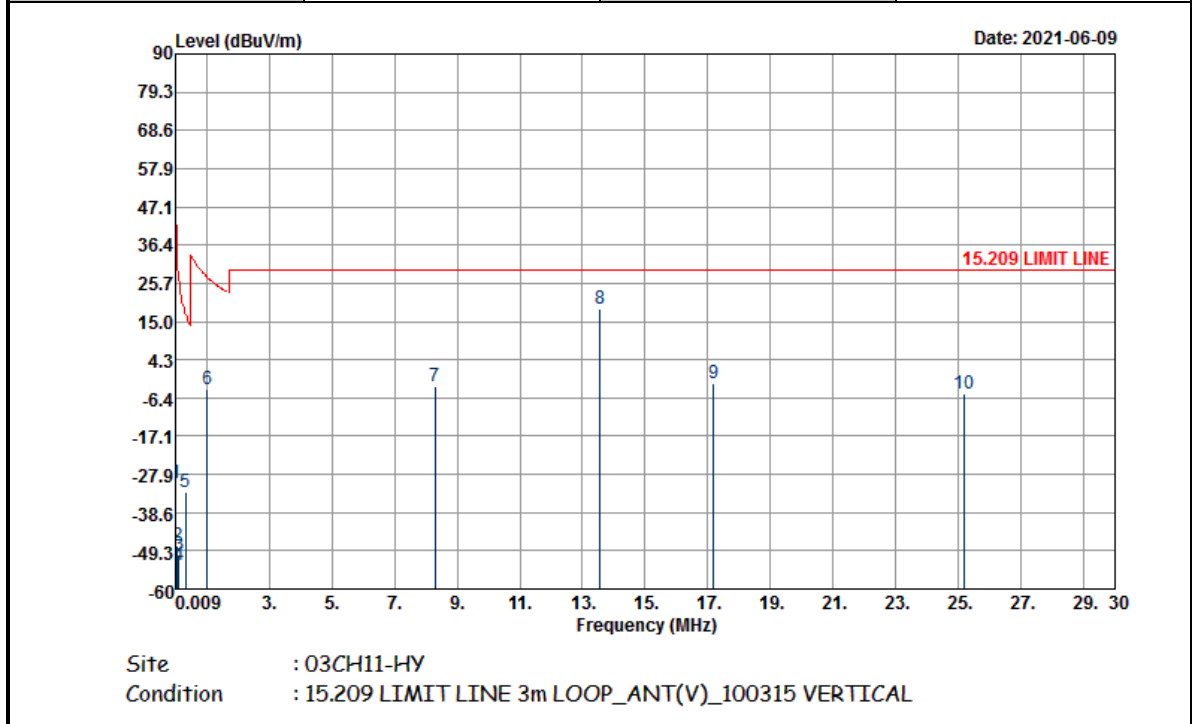

Frequency (MHz)	Level (dBμV/m)	Distance extrapolation Factor (dB)	Over Limit (dB)	Limit Line (dBμV/m)	Read Level (dBμV)	Antenna Factor (dB)	Cable Loss (dB)	Ant Pos (cm)	Table Pos (deg)	Remark
0.0192	-30.18	80	-72.12	41.94	30.89	18.91	0.02	-	-	Average
0.06918	-48.03	80	-78.83	30.8	13.05	18.9	0.02	-	-	Average
0.11	-50.57	80	-77.35	26.78	11.26	18.15	0.02	-	-	QP
0.11988	-53.15	80	-79.18	26.03	8.64	18.19	0.02	-	-	Average
0.33496	-32.89	80	-49.99	17.1	28.11	18.98	0.02	-	-	Average
1.031	-4.22	40	-31.56	27.34	16.66	19.1	0.02	100	0	QP
8.288	-3.26	40	-32.76	29.5	16.27	20.45	0.02	-	-	QP
13.56	18.59	40	-10.91	29.5	37.19	21.39	0.01	-	-	QP
17.188	-2.27	40	-31.77	29.5	15.91	21.79	0.03	-	-	QP
25.2	-5.33	40	-34.83	29.5	12.26	22.31	0.1	-	-	QP



Test Mode : NFC Tx with Earphone Polarization : Horizontal

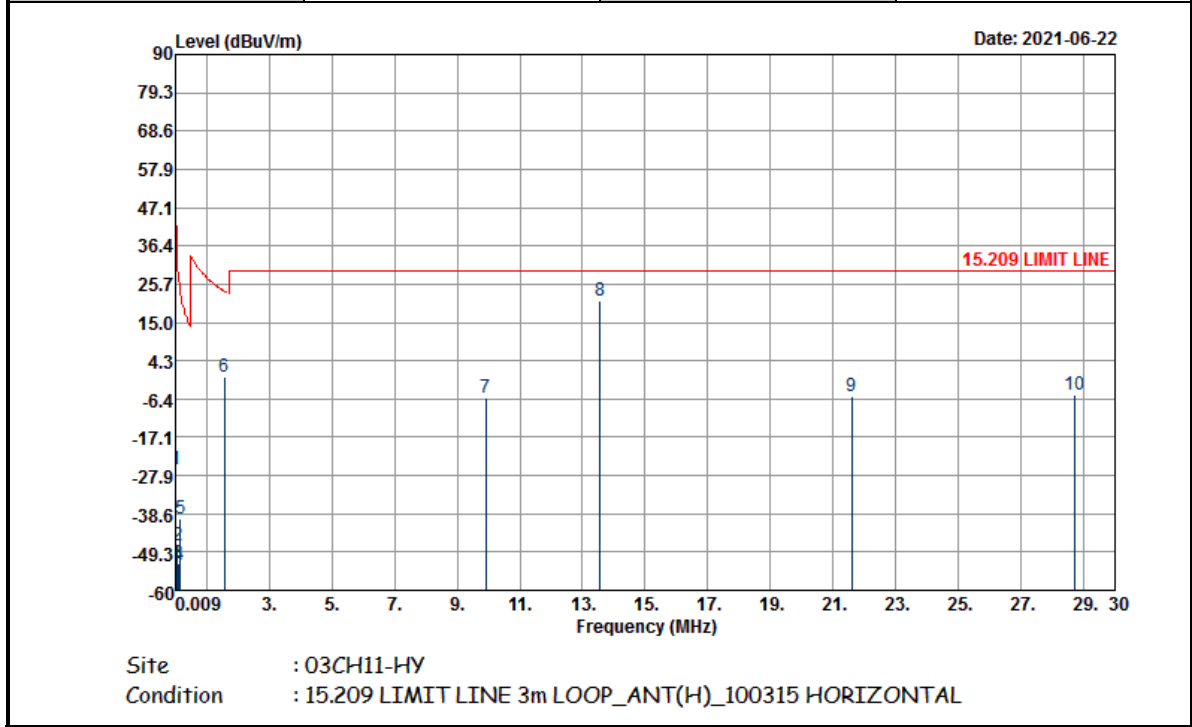

Frequency (MHz)	Level (dBμV/m)	Distance extrapolation Factor (dB)	Over Limit (dB)	Limit Line (dBμV/m)	Read Level (dBμV)	Antenna Factor (dB)	Cable Loss (dB)	Ant Pos (cm)	Table Pos (deg)	Remark
0.0192	-26.18	80	-68.12	41.94	34.89	18.91	0.02	-	-	Average
0.06912	-47.37	80	-78.18	30.81	13.71	18.9	0.02	-	-	Average
0.09404	-52.65	80	-80.79	28.14	9.08	18.25	0.02	-	-	QP
0.12048	-52.76	80	-78.75	25.99	9.03	18.19	0.02	-	-	Average
0.15714	-40.05	80	-63.73	23.68	21.57	18.36	0.02	-	-	Average
1.579	-0.3	40	-23.94	23.64	20.58	19.1	0.02	100	0	QP
9.904	-6.13	40	-35.63	29.5	12.88	20.97	0.02	-	-	QP
13.56	21.25	40	-8.25	29.5	39.85	21.39	0.01	-	-	QP
21.589	-5.64	40	-35.14	29.5	12.14	22.16	0.06	-	-	QP
28.72	-5.25	40	-34.75	29.5	12.07	22.45	0.23	-	-	QP



Test Mode :	NFC Tx with Earphone	Polarization :	Vertical
-------------	----------------------	----------------	----------

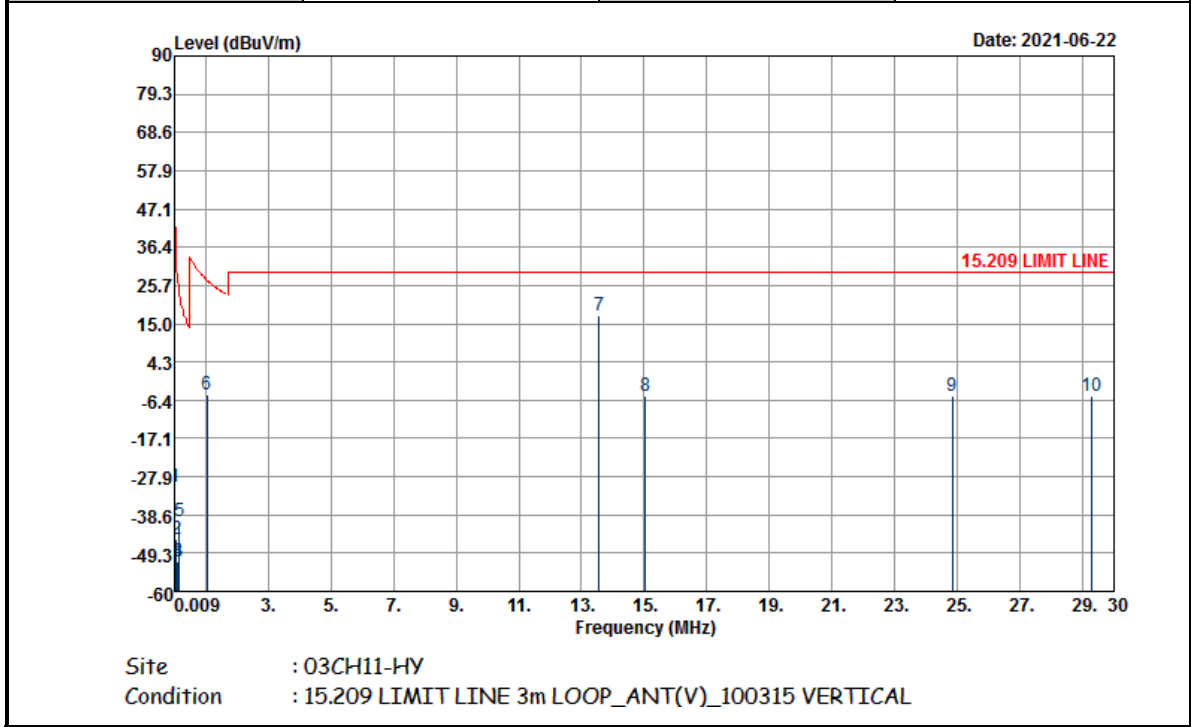

Frequency (MHz)	Level (dBμV/m)	Distance extrapolation Factor (dB)	Over Limit (dB)	Limit Line (dBμV/m)	Read Level (dBμV)	Antenna Factor (dB)	Cable Loss (dB)	Ant Pos (cm)	Table Pos (deg)	Remark
0.01925	-30.59	80	-72.51	41.92	30.48	18.91	0.02	-	-	Average
0.06912	-45.25	80	-76.06	30.81	15.83	18.9	0.02	-	-	Average
0.10996	-51.81	80	-78.59	26.78	10.03	18.14	0.02	-	-	QP
0.11	-51.64	80	-78.42	26.78	10.19	18.15	0.02	-	-	Average
0.15578	-40.44	80	-64.19	23.75	21.19	18.35	0.02	-	-	Average
1.046	-4.71	40	-31.93	27.22	16.17	19.1	0.02	100	0	QP
13.56	17.26	40	-12.24	29.5	35.86	21.39	0.01	-	-	QP
15.04	-5.41	40	-34.91	29.5	13.03	21.55	0.01	-	-	QP
24.829	-5.1	40	-34.6	29.5	12.52	22.29	0.09	-	-	QP
29.285	-5.37	40	-34.87	29.5	11.91	22.47	0.25	-	-	QP

Note:

1. The amplitude of spurious emissions which are attenuated by more than 20dB below the permissible value has no need to be reported.
2. Distance extrapolation factor = 40 log (specific distance / test distance) (dB)
3. Limit line = specific limits (dBμV) + distance extrapolation factor
4. 13.56 MHz is fundamental signal which can be ignored



C3. Results of Radiated Spurious Emissions (30MHz~1GHz)

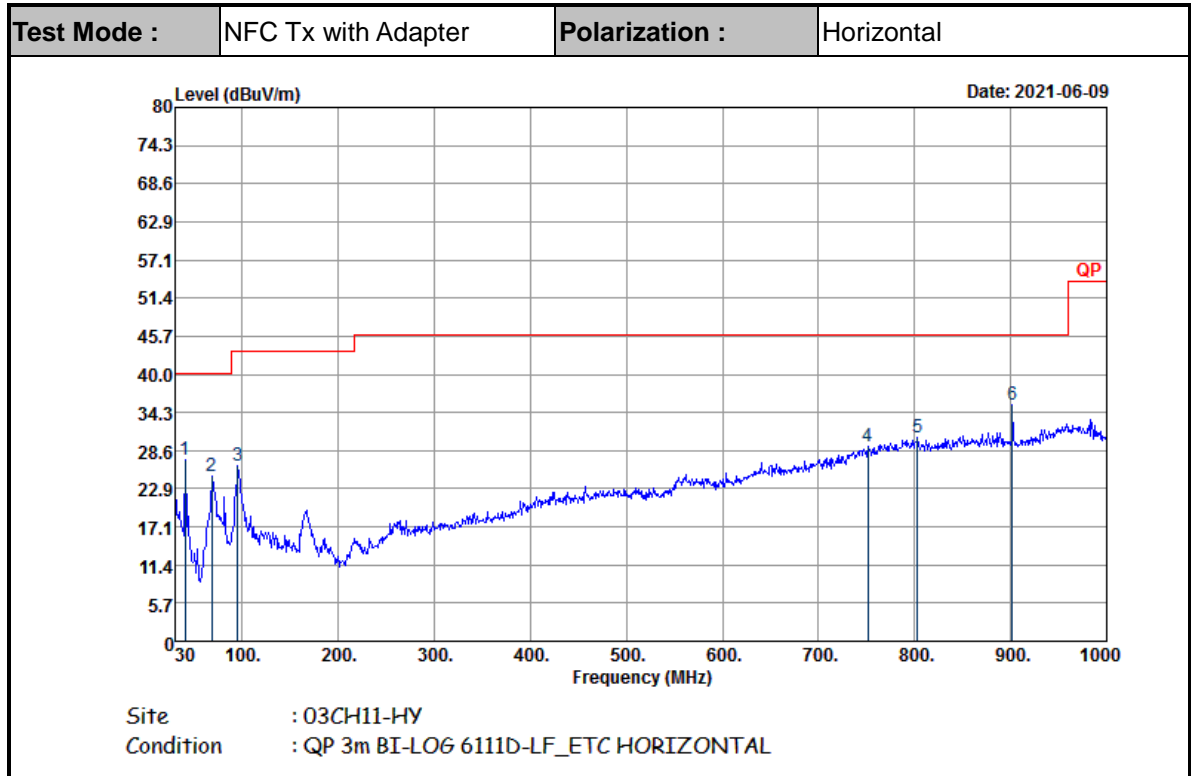

Frequency (MHz)	Level (dBμV/m)	Over Limit (dB)	Limit Line (dBμV/m)	Read Level (dBμV)	Antenna Factor (dB)	Cable Loss (dB)	Preamp Factor (dB)	Ant Pos (cm)	Table Pos (deg)	Remark
40.67	27.18	-12.82	40	39.69	18.91	1.19	32.5	-	-	Peak
67.83	24.75	-15.25	40	43.92	12.04	1.43	32.53	-	-	Peak
94.99	26.32	-17.18	43.5	42.1	15.14	1.74	32.51	-	-	Peak
751.68	29.22	-16.78	46	28.56	28.03	5.26	31.98	-	-	Peak
803.09	30.53	-15.47	46	28.37	28.28	6.84	31.59	-	-	Peak
902.03	35.43	-10.57	46	32.08	29.13	6.46	31.19	100	0	Peak



Test Mode :	NFC Tx with Adapter	Polarization :	Vertical
-------------	---------------------	----------------	----------

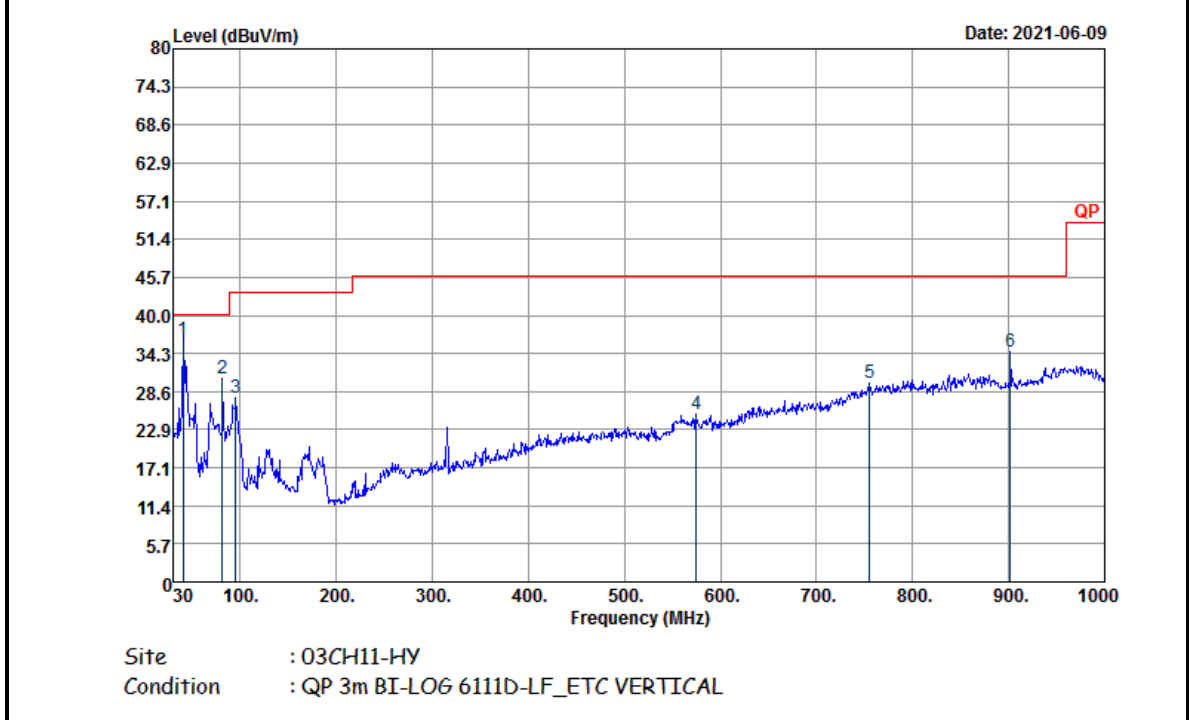

Frequency (MHz)	Level (dBμV/m)	Over Limit (dB)	Limit Line (dBμV/m)	Read Level (dBμV)	Antenna Factor (dB)	Cable Loss (dB)	Preamp Factor (dB)	Ant Pos (cm)	Table Pos (deg)	Remark
40.67	36.37	-3.63	40	48.88	18.91	1.19	32.5	100	165	QP
81.41	30.48	-9.52	40	48.06	13.47	1.62	32.52	-	-	Peak
94.99	27.55	-15.95	43.5	43.33	15.14	1.74	32.51	-	-	Peak
575.14	25.18	-20.82	46	28.2	25.92	4.09	32.72	-	-	Peak
755.56	29.81	-16.19	46	29.03	28.06	5.37	31.95	-	-	Peak
902.03	34.49	-11.51	46	31.14	29.13	6.46	31.19	-	-	Peak



Test Mode :	NFC Tx with Earphone	Polarization :	Horizontal
-------------	----------------------	----------------	------------

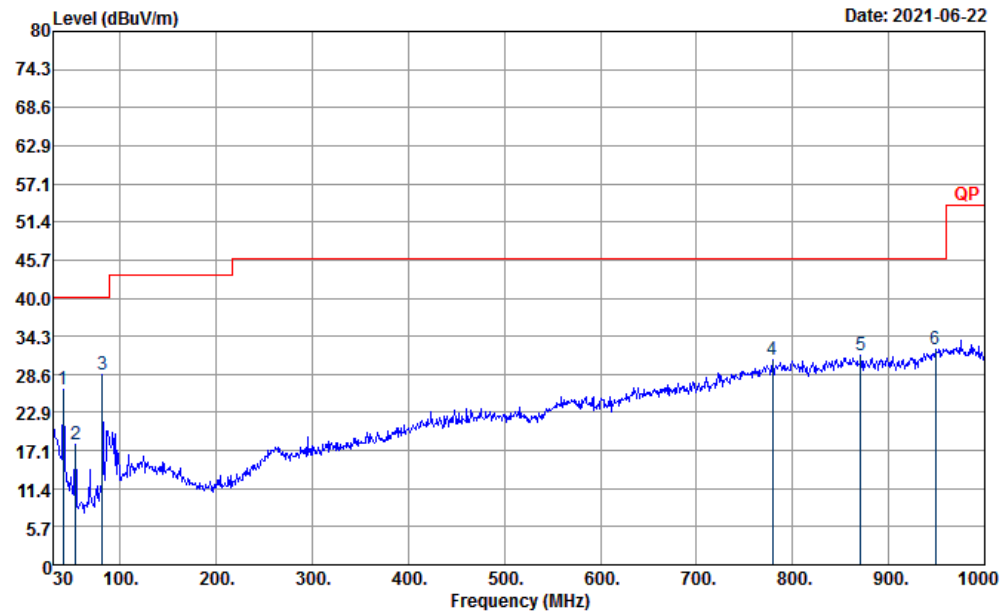

Site : 03CH11-HY
 Condition : QP 3m BI-LOG 6111D-LF_ETC HORIZONTAL

Frequency (MHz)	Level (dB μ V/m)	Over Limit (dB)	Limit Line (dB μ V/m)	Read Level (dB μ V)	Antenna Factor (dB)	Cable Loss (dB)	Preamp Factor (dB)	Ant Pos (cm)	Table Pos (deg)	Remark
40.67	26.26	-13.74	40	38.77	18.91	1.08	32.5	-	-	Peak
53.28	18.09	-21.91	40	36.8	12.65	1.19	32.55	-	-	Peak
81.41	28.61	-11.39	40	46.19	13.47	1.47	32.52	100	0	Peak
778.84	30.72	-15.28	46	29.28	28.12	5.09	31.77	-	-	Peak
870.99	31.46	-14.54	46	28.05	29.3	5.43	31.32	-	-	Peak
948.59	32.39	-13.61	46	27.17	30.6	5.5	30.88	-	-	Peak



Test Mode :	NFC Tx with Earphone	Polarization :	Vertical
-------------	----------------------	----------------	----------

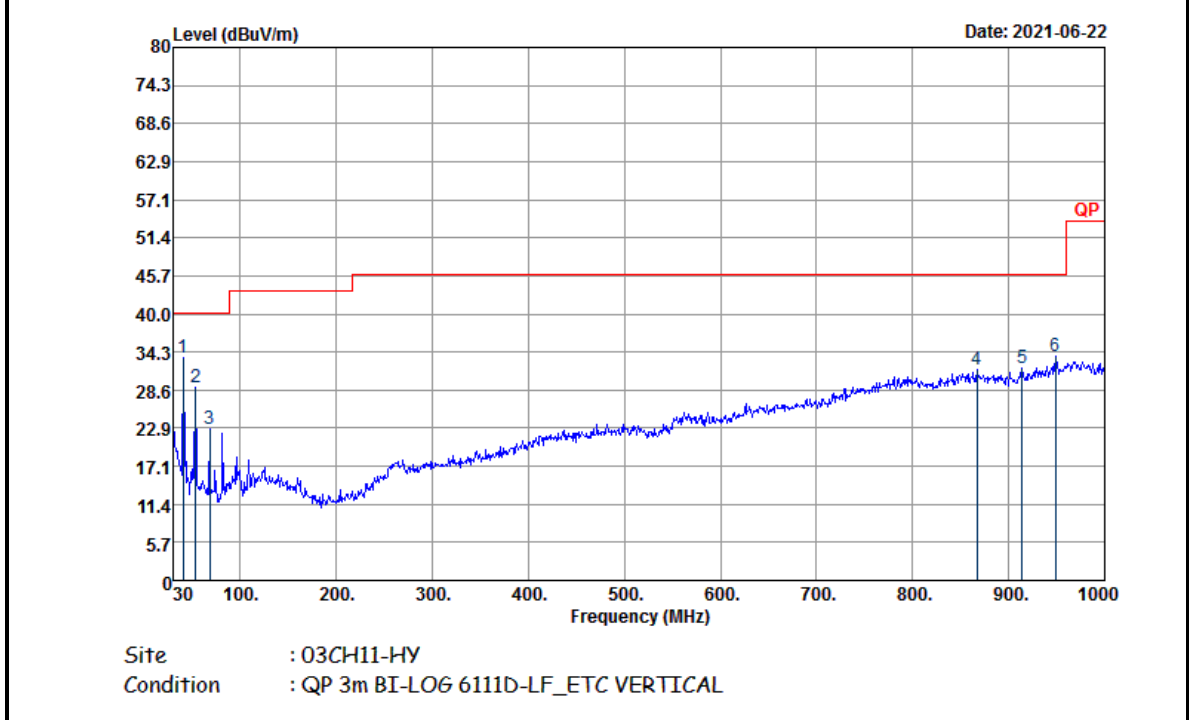

Frequency (MHz)	Level (dBμV/m)	Over Limit (dB)	Limit Line (dBμV/m)	Read Level (dBμV)	Antenna Factor (dB)	Cable Loss (dB)	Preamp Factor (dB)	Ant Pos (cm)	Table Pos (deg)	Remark
40.67	33.33	-6.67	40	45.84	18.91	1.08	32.5	100	0	Peak
53.28	29	-11	40	47.71	12.65	1.19	32.55	-	-	Peak
67.83	22.72	-17.28	40	41.89	12.04	1.32	32.53	-	-	Peak
867.11	31.59	-14.41	46	28.21	29.28	5.43	31.33	-	-	Peak
913.67	31.78	-14.22	46	28.25	29.21	5.43	31.11	-	-	Peak
948.59	33.58	-12.42	46	28.36	30.6	5.5	30.88	-	-	Peak

Note:

1. The amplitude of spurious emissions which are attenuated by more than 20dB below the permissible value has no need to be reported.
2. Emission level (dBμV/m) = 20 log Emission level (μV/m).
3. Corrected Reading: Antenna Factor + Cable Loss + Read Level - Preamp Factor= Level.

————THE END————