



# FCC RADIO TEST REPORT

**FCC ID** : A4RG9BQD  
**Equipment** : Phone  
**Model Name** : G9BQD  
**Applicant** : Google LLC  
1600 Amphitheatre Parkway, Mountain View, California, 94043 USA  
**Standard** : FCC Part 15 Subpart C §15.247

The product was received on Feb. 06, 2023 and testing was performed from Feb. 22, 2023 to May 26, 2023. We, Sporton International Inc. Wensan Laboratory, would like to declare that the tested sample has been evaluated in accordance with the test procedures and has been in compliance with the applicable technical standards.

The test results in this report apply exclusively to the tested model / sample. Without written approval from Sporton International Inc. Wensan Laboratory, the test report shall not be reproduced except in full.

*Louis Wu*

Approved by: Louis Wu

**Sporton International Inc. Wensan Laboratory**

No.58, Aly. 75, Ln. 564, Wenhua 3rd, Rd., Guishan Dist., Taoyuan City 333010, Taiwan (R.O.C.)



# Table of Contents

**History of this test report..... 3**

**Summary of Test Result..... 4**

**1 General Description ..... 5**

    1.1 Product Feature of Equipment Under Test..... 5

    1.2 Product Specification of Equipment Under Test..... 6

    1.3 Modification of EUT ..... 8

    1.4 Testing Location ..... 8

    1.5 Applicable Standards..... 8

**2 Test Configuration of Equipment Under Test ..... 9**

    2.1 Carrier Frequency and Channel ..... 9

    2.2 Test Mode..... 10

    2.3 Connection Diagram of Test System..... 12

    2.4 Support Unit used in test configuration and system ..... 13

    2.5 EUT Operation Test Setup ..... 13

    2.6 Measurement Results Explanation Example..... 13

**3 Test Result ..... 14**

    3.1 6dB and 99% Bandwidth Measurement ..... 14

    3.2 Output Power Measurement..... 15

    3.3 Power Spectral Density Measurement ..... 16

    3.4 Conducted Band Edges and Spurious Emission Measurement ..... 17

    3.5 Radiated Band Edges and Spurious Emission Measurement ..... 18

    3.6 AC Conducted Emission Measurement..... 22

    3.7 Antenna Requirements ..... 24

**4 List of Measuring Equipment..... 25**

**5 Measurement Uncertainty ..... 26**

**Appendix A. Conducted Test Results**

**Appendix B. AC Conducted Emission Test Result**

**Appendix C. Radiated Spurious Emission**

**Appendix D. Radiated Spurious Emission Plots**

**Appendix E. Duty Cycle Plots**

**Appendix F. Setup Photographs**



### History of this test report

Report No.	Version	Description	Issue Date
FR2D0208-07C	01	Initial issue of report	Jun. 29, 2023
FR2D0208-07C	02	Revise Appendix A This report is an updated version, replacing the report issued on Jun. 29, 2023.	Jul. 06, 2023



### Summary of Test Result

Report Clause	Ref Std. Clause	Test Items	Result (PASS/FAIL)	Remark
3.1	15.247(a)(2)	6dB Bandwidth	Pass	-
3.1	2.1049	99% Occupied Bandwidth	Reporting only	-
3.2	15.247(b)	Power Output Measurement	Pass	-
3.3	15.247(e)	Power Spectral Density	Pass	-
3.4	15.247(d)	Conducted Band Edges	Pass	-
		Conducted Spurious Emission	Pass	-
3.5	15.247(d)	Radiated Band Edges and Radiated Spurious Emission	Pass	1.81 dB under the limit at 2483.52 MHz
3.6	15.207	AC Conducted Emission	Pass	14.38 dB under the limit at 1.39 MHz
3.7	15.203	Antenna Requirement	Pass	-

Note: FR2D0208-07C Report reuses conduction test data from FR2D0208-03C report.

Conformity Assessment Condition:
1. The test results (PASS/FAIL) with all measurement uncertainty excluded are presented against the regulation limits or in accordance with the requirements stipulated by the applicant/manufacturer who shall bear all the risks of non-compliance that may potentially occur if measurement uncertainty is taken into account.
2. The measurement uncertainty please refer to each test result in the section "Measurement Uncertainty".
Disclaimer:
The product specifications of the EUT presented in the test report that may affect the test assessments are declared by the manufacturer who shall take full responsibility for the authenticity.

Reviewed by: William Chen  
Report Producer: Lea Yu



# 1 General Description

## 1.1 Product Feature of Equipment Under Test

Product Feature	
Equipment	Phone
Model Name	G9BQD
FCC ID	A4RG9BQD
EUT supports Radios application	GSM/EGPRS/WCDMA/HSPA/LTE/5G NR/NFC/GNSS/WPT WLAN 11b/g/n HT20 WLAN 11a/n HT20/HT40 WLAN 11ac VHT20/VHT40/VHT80/VHT160 WLAN 11ax HE20/HE40/HE80/HE160 WLAN 11be EHT20/EHT40/EHT80/EHT160 Bluetooth BR/EDR/LE/HR

Antenna information		
2400 MHz ~ 2483.5 MHz	Peak Gain (dBi)	Ant. 3: -2.2 Ant. 4: -0.6

Remark: The EUT's information above is declared by manufacturer.

EUT Information List	
S/N	Performed Test Item
31051FDJH0006A 33251FDJH00035	RF Conducted Measurement
33241FDJH0004A	Radiated Spurious Emission
33201FDJH000KU	Conducted Emission

## 1.2 Product Specification of Equipment Under Test

Product Specification is subject to this standard			
<b>Tx/Rx Channel Frequency Range</b>	2412 MHz ~ 2472 MHz		
<b>Maximum (Average) Output Power to antenna</b>	<p><b>&lt;Ant. 3&gt;:</b> 802.11b: 22.45 dBm / 0.1758 W</p> <p><b>&lt;Ant. 4&gt;:</b> 802.11b: 22.45 dBm / 0.1758 W</p> <p><b>MIMO &lt;Ant. 3+4&gt;</b> 802.11g: 24.96 dBm (0.3133W) 802.11n HT20: 23.66 dBm (0.2323W) 802.11ac VHT20: 23.66 dBm (0.2323W) 802.11ax HE20: 23.66 dBm (0.2323W) 802.11be EHT20: 23.76 dbm (0.2377W)</p>		
<b>99% Occupied Bandwidth</b>	<p><b>&lt;Ant. 3&gt;</b> 802.11b: 11.19 MHz</p> <p><b>&lt;Ant. 4&gt;</b> 802.11b: 11.09 MHz</p> <p><b>MIMO &lt;Ant. 3&gt;</b> 802.11g: 19.13 MHz</p> <p>802.11be EHT20: 19.93 MHz</p> <p><b>MIMO &lt;Ant. 4&gt;</b> 802.11g: 18.78 MHz</p> <p>802.11be EHT20: 19.93 MHz</p>		
<b>Antenna Gain</b>	<p><b>&lt;Ant. 3&gt;:</b> Loop Antenna with gain -2.20 dBi</p> <p><b>&lt;Ant. 4&gt;:</b> Monopole Antenna with gain -0.60 dBi</p>		
<b>Type of Modulation</b>	<p>802.11b: DSSS (DBPSK / DQPSK / CCK)</p> <p>802.11g/n: OFDM (BPSK / QPSK / 16QAM / 64QAM)</p> <p>802.11ac: OFDM (BPSK / QPSK / 16QAM / 64QAM / 256QAM)</p> <p>802.11ax: OFDMA (BPSK / QPSK / 16QAM / 64QAM / 256QAM / 1024QAM)</p> <p>802.11be : OFDMA (BPSK / QPSK / 16QAM / 64QAM / 256QAM / 1024QAM/4096QAM)</p>		
<b>Antenna Function for Transmitter</b>		Ant. 3	Ant. 4
	802.11b	V	V
	802.11g/n/ac/ax/be MIMO	V	V

**Remark:**

1. MIMO Ant. 3+4 Directional Gain is a calculated result from MIMO Ant. 3 and MIMO Ant. 4. The formula used in calculation is documented in section 1.2.1.
2. Power of MIMO Ant. 3 + Ant. 4 is a calculated result from sum of the power MIMO Ant. 3 and MIMO Ant. 4.
3. The EUT's information above is declared by manufacturer. Please refer to Disclaimer in report summary.

### 1.2.1 Antenna Directional Gain

**<For CDD Mode>**

Follows FCC KDB 662911 D01 Multiple Transmitter Output v02r01 F2)f)ii)

Directional gain =  $G_{ANT}$  + Array Gain, where Array Gain is as follows:

For power measurements on IEEE 802.11 devices,

Array Gain = 0 dB (i.e., no array gain) for  $N_{ANT} \leq 4$ .

$G_{ANT}$  is set equal to the gain of the antenna having the highest gain.

For PSD measurements, the directional gain calculation.

$$DirectionalGain = 10 \cdot \log \left[ \frac{\sum_{j=1}^{N_{SS}} \left\{ \sum_{k=1}^{N_{ANT}} g_{j,k} \right\}^2}{N_{ANT}} \right]$$

where

Each antenna is driven by no more than one spatial stream;

$N_{SS}$  = the number of independent spatial streams of data;

$N_{ANT}$  = the total number of antennas

$g_{j,k} = 10^{G_k/20}$  if the  $k$ th antenna is being fed by spatial stream  $j$ , or zero if it is not;  
 $G_k$  is the gain in dBi of the  $k$ th antenna.

As minimum  $N_{SS}=1$  is supported by EUT, the formula can be simplified as:

$$Directional\ gain = 10 \cdot \log \left[ \left( 10^{G_1/20} + 10^{G_2/20} + \dots + 10^{G_N/20} \right)^2 / N_{ANT} \right] \text{ dBi}$$

Where  $G_1, G_2, \dots, G_N$  denote single antenna gain.

The directional gain "DG" is calculated as following table.

			<b>DG</b>	<b>DG</b>	<b>Power</b>	<b>PSD</b>
			<b>for</b>	<b>for</b>	<b>Limit</b>	<b>Limit</b>
	<b>Ant 3</b>	<b>Ant 4</b>	<b>Power</b>	<b>PSD</b>	<b>Reduction</b>	<b>Reduction</b>
	<b>(dBi)</b>	<b>(dBi)</b>	<b>(dBi)</b>	<b>(dBi)</b>	<b>(dB)</b>	<b>(dB)</b>
<b>2.4GHz</b>	-2.20	-0.60	-0.60	1.65	0.00	0.00

Calculation example:

If a device has two antenna,  $G_{ANT3} = -2.20\text{dBi}$ ;  $G_{ANT4} = -0.60\text{dBi}$

Directional gain of power measurement =  $\max(-2.20, -0.60) + 0 = -0.60 \text{ dBi}$

Directional gain of PSD derived from formula which is

$$10 \times \log \left\{ \left[ \left( 10^{(-2.20 \text{ dBi} / 20)} + 10^{(-0.60 \text{ dBi} / 20)} \right)^2 \right] / 2 \right\}$$

$$= 1.65 \text{ dBi}$$

Power and PSD limit reduction = Composite gain – 6dBi, ( min = 0 )



### 1.3 Modification of EUT

No modifications made to the EUT during the testing.

### 1.4 Testing Location

<b>Test Site</b>	Sporton International Inc. EMC & Wireless Communications Laboratory
<b>Test Site Location</b>	No.52, Huaya 1st Rd., Guishan Dist., Taoyuan City 333, Taiwan (R.O.C.) TEL: +886-3-327-3456 FAX: +886-3-328-4978
<b>Test Site No.</b>	<b>Sporton Site No.</b> CO05-HY (TAF Code: 1190)
<b>Remark</b>	The AC Conducted Emission test item subcontracted to Sporton International Inc. EMC & Wireless Communications Laboratory

**Note:** The test site complies with ANSI C63.4 2014 requirement.

<b>Test Site</b>	Sporton International Inc. Wensan Laboratory
<b>Test Site Location</b>	No.58, Aly. 75, Ln. 564, Wenhua 3rd, Rd., Guishan Dist., Taoyuan City 333010, Taiwan (R.O.C.) TEL: +886-3-327-0868 FAX: +886-3-327-0855
<b>Test Site No.</b>	<b>Sporton Site No.</b> TH05-HY, 03CH16-HY

**Note:** The test site complies with ANSI C63.4 2014 requirement.

FCC designation No.: TW1190 and TW3786

### 1.5 Applicable Standards

According to the specifications declared by the manufacturer, the EUT must comply with the requirements of the following standards:

- ♦ FCC Part 15 Subpart C §15.247
- ♦ FCC KDB Publication No. 558074 D01 15.247 Meas Guidance v05r02
- ♦ FCC KDB 414788 D01 Radiated Test Site v01r01.
- ♦ FCC KDB 662911 D01 Multiple Transmitter Output v02r01.
- ♦ ANSI C63.10-2013

**Remark:**

1. All the test items were validated and recorded in accordance with the standards without any modification during the testing.
2. The TAF code is not including all the FCC KDB listed without accreditation.





## 2 Test Configuration of Equipment Under Test

- a. The EUT has been associated with peripherals and configuration operated in a manner tended to maximize its emission characteristics in a typical application. Frequency range investigated: conduction emission (150 kHz to 30 MHz), radiation emission (9 kHz to the 10th harmonic of the highest fundamental frequency or to 40 GHz, whichever is lower). For radiated measurement, the measured emission level of the EUT was maximized by rotating the EUT on a turntable, adjusting the orientation of the EUT and EUT antenna in three orthogonal axis (X: flat, Y: portrait, Z: landscape), and accessory (Adapter or Earphone), and adjusting the measurement antenna orientation, following C63.10 exploratory test procedures and only the worst case emissions were reported in this report.
  
- b. AC power line Conducted Emission was tested under maximum output power.

### 2.1 Carrier Frequency and Channel

Frequency Band	Channel	Freq. (MHz)	Channel	Freq. (MHz)
2400-2483.5 MHz	1	2412	8	2447
	2	2417	9	2452
	3	2422	10	2457
	4	2427	11	2462
	5	2432	12	2467
	6	2437	13	2472
	7	2442		



## 2.2 Test Mode

This device supports WiFi 802.11be 20MHz bandwidth for 2.4GHz.

This device supports 26/52/106/242 single tone RU modes for 802.11ax/be modes and the 242-tone RU modes are covered by 20MHz channels.

The PSD of partial RU modes are reduced to be smaller than full RU according to TCB workshop interim guidance Oct. 2018.

The 802.11ax/be modes are investigated among full RU and single RU modes for emission spot check and the 11ax modes are covered by 11be modes.

The PSD and power of partial RU are less than full RU configurations so the full RU is chosen as main test configuration.

The SISO mode conducted power is covered by MIMO mode per chain, so only the MIMO mode is chosen as main test configuration.

The power of 802.11n, 802.11ac and 802.11ax modes are less than 802.11be mode, so all conducted and radiated tests are covered by 802.11be mode.

**The final test modes include the worst data rates for each modulation shown in the table below.**

### Single Antenna

Modulation	Data Rate
802.11b	1 Mbps

### MIMO Antenna

Modulation	Data Rate
802.11g	6 Mbps
802.11n HT20 (Covered by EHT20)	MCS0
802.11ac VHT20 (Covered by EHT20)	MCS0
802.11ax HE20 (Covered by EHT20)	MCS0
802.11be EHT20	MCS0



Test Cases	
<b>AC Conducted Emission</b>	Mode 1 :GSM850 Idle + WLAN (2.4GHz) Link + Bluetooth Link + USB cable 1 (Charging from Adapter 2)
<b>Remark:</b>	
<ol style="list-style-type: none"> <li>For Radiated Test Cases, the tests were performed with Adapter 2, USB Cable 2.</li> <li>During the preliminary test, both charging modes (Adapter mode and WPT Charging mode) were verified. It is determined that the adaptor mode is the worst case for official test.</li> </ol>	

<Ant. 3>

Ch. #	2400-2483.5 MHz	
	802.11b	
Low	01	
Middle	06	
High	11	
	12	
	13	

<Ant. 4>

Ch. #	2400-2483.5 MHz	
	802.11b	
Low	01	
Middle	06	
High	11	
	12	
	13	

MIMO <Ant. 3+4>

Ch. #	2400-2483.5 MHz	
	802.11g	802.11ax HE20
Low	01	01
Middle	06	06
High	11	11
	12	12
	13	13

**Remark:** For radiation spurious emission, the modulation and the data rate picked for testing are determined by the Max. RF conducted power.

## 2.3 Connection Diagram of Test System

<AC Conducted Emission Mode>

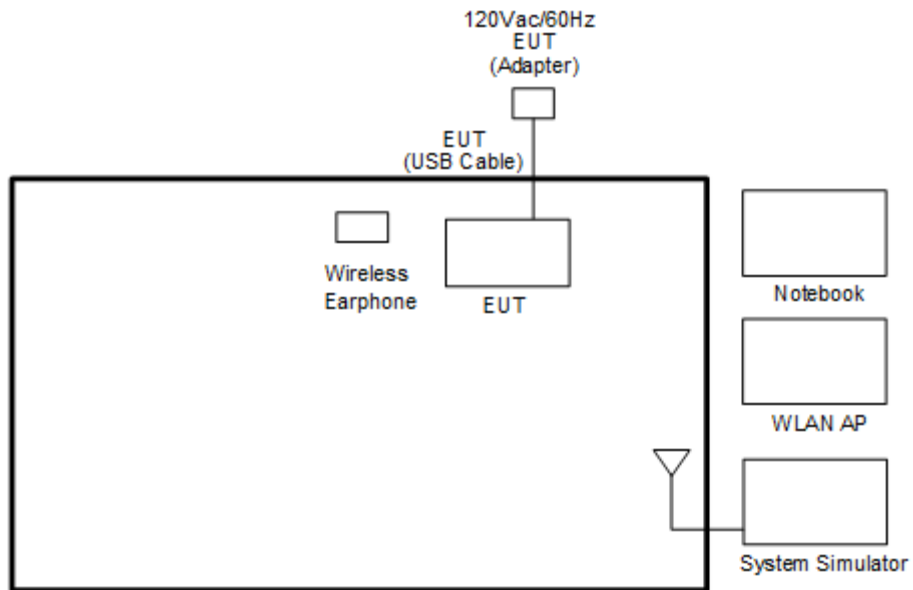

<WLAN Tx Mode>

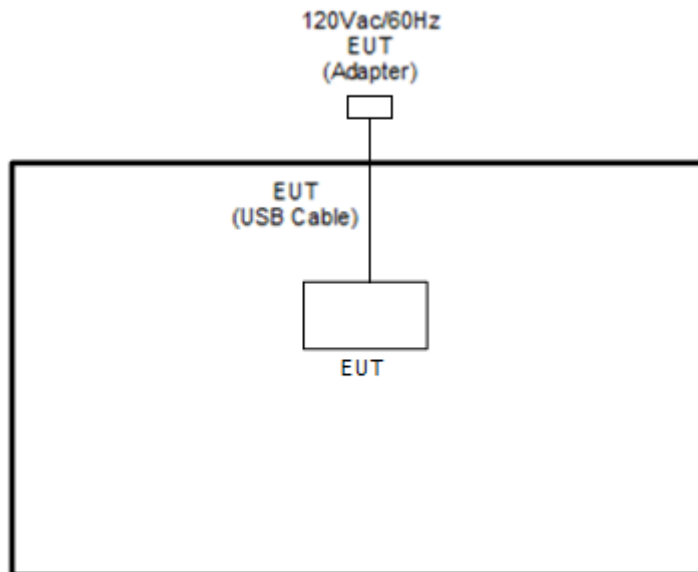



## 2.4 Support Unit used in test configuration and system

Item	Equipment	Brand Name	Model Name	FCC ID	Data Cable	Power Cord
1.	System Simulator	Anritsu	MT8820C	N/A	N/A	Unshielded, 1.8 m
2.	Wireless Earphone	Google	G1007/G1008	A4RG1007/ A4RG1008	N/A	N/A
3.	WLAN AP	ASUS	RT-AC66U	MSQ-RTAC66U	N/A	Unshielded, 1.8 m
4.	Notebook	DELL	Latitude 3420	FCC DoC	N/A	AC I/P: Unshielded, 1.2 m DC O/P: Shielded, 1.8 m

## 2.5 EUT Operation Test Setup

The RF test items, utility “CMD10.0.19045.2486” was installed in Notebook which was programmed in order to make the EUT get into the engineering modes to provide channel selection, power level, data rate and the application type and for continuous transmitting signals.

## 2.6 Measurement Results Explanation Example

For all conducted test items:

The offset level is set in the spectrum analyzer to compensate the RF cable loss and attenuator factor between EUT conducted output port and spectrum analyzer. With the offset compensation, the spectrum analyzer reading level is exactly the EUT RF output level.

Example:

The spectrum analyzer offset is derived from RF cable loss and attenuator factor.

*Offset = RF cable loss + attenuator factor.*

Following shows an offset computation example with cable loss 4.2 dB and 10 dB attenuator.

$$\begin{aligned} \text{Offset(dB)} &= \text{RF cable loss(dB)} + \text{attenuator factor(dB)}. \\ &= 4.2 + 10 = 14.2 \text{ (dB)} \end{aligned}$$

### 3 Test Result

#### 3.1 6dB and 99% Bandwidth Measurement

##### 3.1.1 Limit of 6dB and 99% Bandwidth

The minimum 6 dB bandwidth shall be at least 500 kHz.

##### 3.1.2 Measuring Instruments

Please refer to the measuring equipment list in this test report.

##### 3.1.3 Test Procedures

1. The testing follows the ANSI C63.10 Section 6.9.3 (OBW) and 11.8.1 (6dB BW).
2. The RF output of EUT is connected to the spectrum analyzer by RF cable and attenuator. The path loss is compensated to the results for each measurement.
3. Set the maximum power setting and enable the EUT to transmit continuously.
4. Make the measurement with the spectrum analyzer's resolution bandwidth (RBW) = 100 kHz. Set the Video bandwidth (VBW) = 300 kHz. In order to make an accurate measurement. The 6 dB bandwidth must be greater than 500 kHz.
5. For 99% Bandwidth Measurement, the spectrum analyzer's resolution bandwidth (RBW) is set 1-5% of the emission bandwidth and set the Video bandwidth (VBW)  $\geq 3 * RBW$ .
6. Measure and record the results in the test report.

##### 3.1.4 Test Setup



### 3.1.5 Test Result of 6dB and 99% Occupied Bandwidth

Please refer to Appendix A.

## 3.2 Output Power Measurement

### 3.2.1 Limit of Output Power

For systems using digital modulation in the 2400-2483.5 MHz, the limit for output power is 30 dBm. If transmitting antenna with directional gain greater than 6 dBi is used, the peak output power from the intentional radiator shall be reduced below the above stated value by the amount in dB that the directional gain of the antenna exceeds 6 dBi. In case of point-to-point operation, the limit has to be reduced by 1 dB for every 3 dB that the directional gain of the antenna exceeds 6 dBi.

### 3.2.2 Measuring Instruments

Please refer to the measuring equipment list in this test report.

### 3.2.3 Test Procedures

1. For Average Power, the testing follows ANSI C63.10 Section 11.9.2.3.2 Method AVGPM-G
2. The RF output of EUT is connected to the power meter by RF cable and attenuator. The path loss is compensated to the results for each measurement.
3. Set the maximum power setting and enable the EUT to transmit continuously.
4. Measure the conducted output power and record the results in the test report.
5. For MIMO mode, calculation method follows FCC KDB 662911 D01 Multiple Transmitter Output v02r01.

### 3.2.4 Test Setup

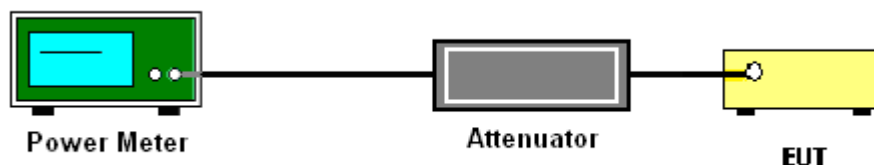

### 3.2.5 Test Result of Average Output Power

Please refer to Appendix A.

### 3.3 Power Spectral Density Measurement

#### 3.3.1 Limit of Power Spectral Density

The peak power spectral density shall not be greater than 8 dBm in any 3 kHz band at any time interval of continuous transmission.

#### 3.3.2 Measuring Instruments

Please refer to the measuring equipment list in this test report.

#### 3.3.3 Test Procedures

1. The testing follows the ANSI C63.10 Section 11.10.2 Method PKPSD.
2. The RF output of EUT is connected to the spectrum analyzer by RF cable and attenuator. The path loss is compensated to the results for each measurement.
3. Set the maximum power setting and enable the EUT to transmit continuously.
4. Make the measurement with the spectrum analyzer's resolution bandwidth (RBW) = 3 kHz. Video bandwidth VBW = 10 kHz In order to make an accurate measurement, set the span to 1.5 times DTS Channel Bandwidth. (6dB BW)
5. Detector = peak, Sweep time = auto couple, Trace mode = max hold, Allow trace to fully stabilize. Use the peak marker function to determine the maximum power level.
6. Measure and record the results in the test report.
7. For MIMO mode, calculation method follows FCC KDB 662911 D01 Multiple Transmitter Output v02r01.

Method (c): Measure and add  $10 \log(N_{ANT})$  dB.

With this technique, spectrum measurements are performed at each output of the device, but rather than summing the spectra or the spectral peaks across the outputs, the quantity  $10 \log(N_{ANT})$  dB is added to each spectrum value before comparing to the emission limit. The addition of  $10 \log(N_{ANT})$  dB serves to apportion the emission limit among the  $N_{ANT}$  outputs so that each output is permitted to contribute no more than  $1/N_{ANT}^{th}$  of the PSD limit .

#### 3.3.4 Test Setup

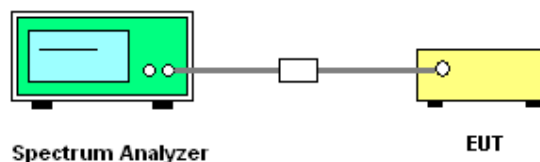

#### 3.3.5 Test Result of Power Spectral Density

Please refer to Appendix A.



## 3.4 Conducted Band Edges and Spurious Emission Measurement

### 3.4.1 Limit of Conducted Band Edges and Spurious Emission Measurement

In any 100 kHz bandwidth outside of the authorized frequency band, the emissions which fall in the non-restricted bands shall be attenuated at least 20 dB / 30dB relative to the maximum PSD level in 100 kHz by RF conducted measurement.

### 3.4.2 Measuring Instruments

Please refer to the measuring equipment list in this test report.

### 3.4.3 Test Procedures

1. The testing follows the ANSI C63.10 Section 11.11.3 Emission level measurement.
2. The RF output of EUT is connected to the spectrum analyzer by RF cable and attenuator. The path loss is compensated to the results for each measurement.
3. Set the maximum power setting and enable the EUT to transmit continuously.
4. Set RBW = 100 kHz, VBW=300 kHz, Peak Detector. Unwanted Emissions measured in any 100 kHz bandwidth outside of the authorized frequency band shall be attenuated by at least 20 dB relative to the maximum in-band peak PSD level in 100 kHz when maximum peak conducted output power procedure is used. If the transmitter complies with the conducted power limits based on the use of RMS averaging over a time interval, the attenuation required under this paragraph shall be 30 dB instead of 20 dB per 15.247(d).
5. Measure and record the results in the test report.
6. The RF fundamental frequency should be excluded against the limit line in the operating frequency band.

### 3.4.4 Test Setup

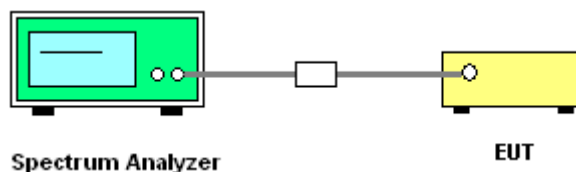

### 3.4.5 Test Result of Conducted Band Edges and Spurious Emission

Please refer to Appendix A.



### 3.5 Radiated Band Edges and Spurious Emission Measurement

#### 3.5.1 Limit of Radiated band edge and Spurious Emission Measurement

In any 100 kHz bandwidth outside the intentional radiator frequency band, all harmonics/spurious must be at least 20 dB below the highest emission level within the authorized band. If the output power of this device is measured by spectrum analyzer, the attenuation under this paragraph shall be 30 dB instead of 20 dB. In addition, radiated emissions which fall in the restricted bands must also comply with the limits as below.

Frequency (MHz)	Field Strength (microvolts/meter)	Measurement Distance (meters)
0.009 – 0.490	2400/F(kHz)	300
0.490 – 1.705	24000/F(kHz)	30
1.705 – 30.0	30	30
30 – 88	100	3
88 – 216	150	3
216 - 960	200	3
Above 960	500	3

#### 3.5.2 Measuring Instruments

Please refer to the measuring equipment list in this test report.

#### 3.5.3 Test Procedures

1. The testing follows the ANSI C63.10 Section 11.12.1 Radiated emission measurements.
2. The EUT is arranged to its worst case and then tune the antenna tower (from 1 m to 4 m) and turntable (from 0 degree to 360 degrees) to find the maximum reading. A pre-amp and a high pass filter are used for the test in order to get better signal level.
3. The EUT is placed on a turntable with 0.8 meter for frequency below 1 GHz and 1.5 meter for frequency above 1 GHz respectively above ground.
4. The EUT is set 3 meters away from the receiving antenna, which is mounted on the top of a variable height antenna tower.
5. Corrected Reading: Antenna Factor + Cable Loss + Read Level - Preamp Factor = Level
6. Radiated testing below 1 GHz is performed by adjusting the antenna tower from 1 m to 4 m and by rotating the turn table from 0 degree to 360 degrees to find the peak maximum hold reading. When there is no suspected emission found and the emission level is with at least 6 dB margin against QP limit line, the position is marked as “-“.

7. Radiated testing above 1 GHz is performed by adjusting the antenna tower from 1 m to 4 m and by rotating the turn table from 0 degree to 360 degrees to find the peak maximum hold reading for scanning all frequencies. When there is no suspected emission found and the harmonic emission level is with at least 6 dB margin against average limit line, the position is marked as “-“.
8. Use the following spectrum analyzer settings:
  - (1) Span shall wide enough to fully capture the emission being measured;
  - (2) Set RBW = 100 kHz for  $f < 1$  GHz; VBW  $\geq$  RBW; Sweep = auto; Detector function = peak; Trace = max hold;
  - (3) Set RBW = 1 MHz, VBW= 3 MHz for  $f \geq 1$  GHz for peak measurement.For average measurement:
  - VBW = 10 Hz, when duty cycle is no less than 98 percent.
  - VBW  $\geq 1/T$ , when duty cycle is less than 98 percent where T is the minimum transmission duration over which the transmitter is on and is transmitting at its maximum power control level for the tested mode of operation.

### 3.5.4 Test Setup

For radiated emissions below 30MHz

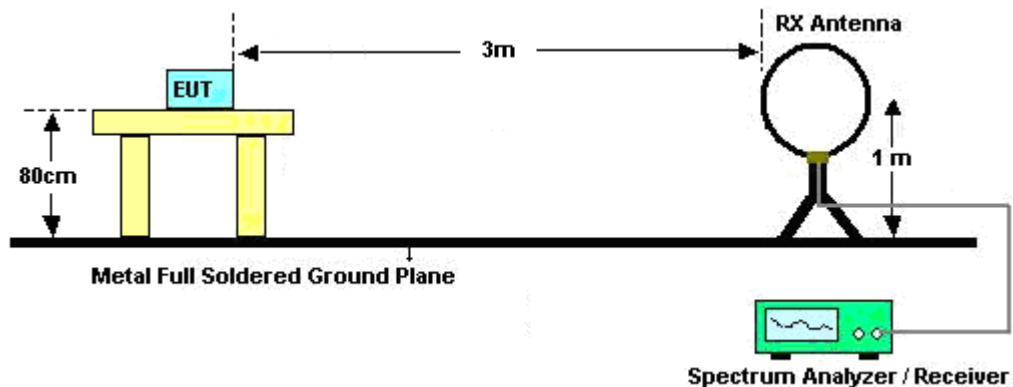

For radiated emissions from 30MHz to 1GHz

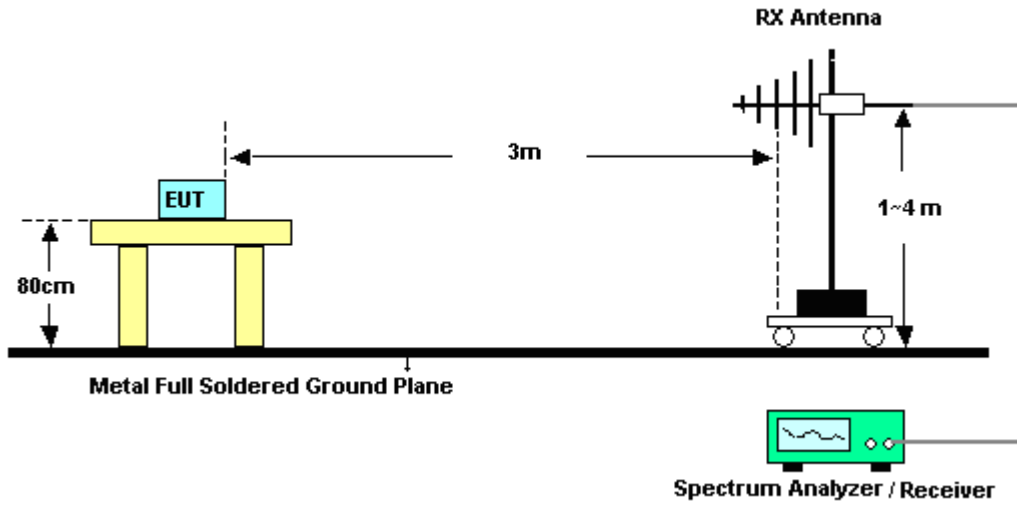

For radiated test from 1GHz to 18GHz

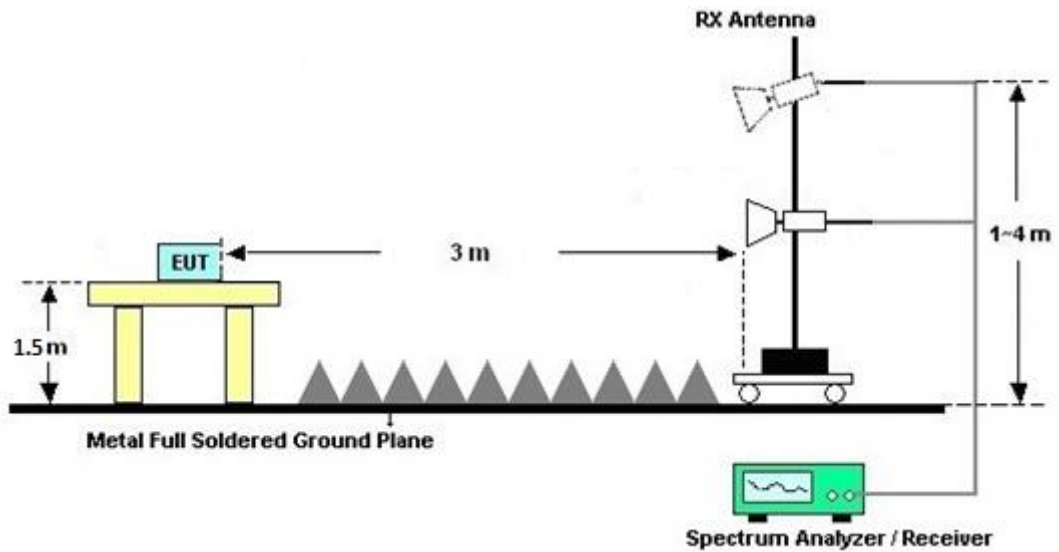

For radiated test above 18GHz

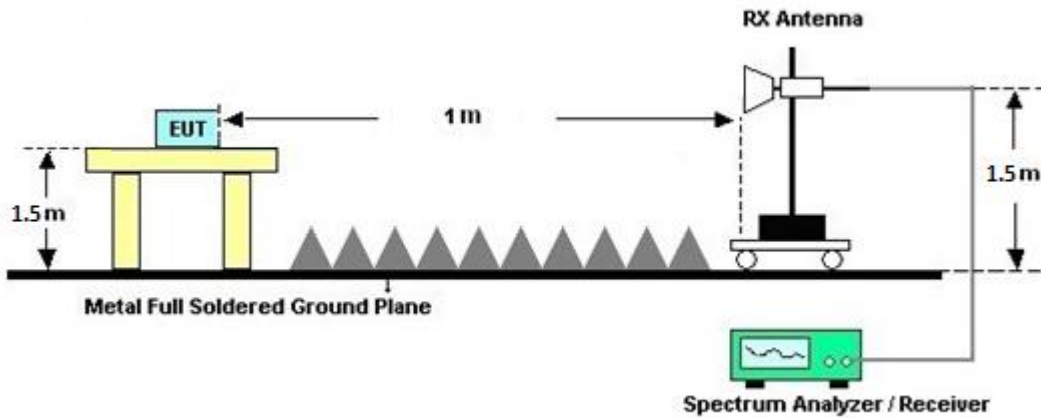

### 3.5.5 Test Results of Radiated Spurious Emissions (9kHz ~ 30MHz)

The low frequency, which starts from 9 kHz to 30 MHz, is pre-scanned and the result which is 20 dB lower than the limit line is not reported.

There is adequate comparison measurement of both open-field test site and alternative test site - semi-Anechoic chamber according to 414788 D01 Radiated Test Site v01r01, and the result comes out very similar.

### 3.5.6 Test Result of Radiated Spurious at Band Edges

Please refer to Appendix C and D.

### 3.5.7 Duty Cycle

Please refer to Appendix E.

### 3.5.8 Test Result of Radiated Spurious Emission (30MHz ~ 10<sup>th</sup> Harmonic)

Please refer to Appendix C and D.



### 3.6 AC Conducted Emission Measurement

#### 3.6.1 Limit of AC Conducted Emission

For equipment that is designed to be connected to the public utility (AC) power line, the radio frequency voltage that is conducted back onto the AC power line on any frequency or frequencies within the band 150 kHz to 30 MHz shall not exceed the limits in the following table.

Frequency of Emission (MHz)	Conducted Limit (dBµV)	
	Quasi-Peak	Average
0.15-0.5	66 to 56*	56 to 46*
0.5-5	56	46
5-30	60	50

\*Decreases with the logarithm of the frequency.

#### 3.6.2 Measuring Instruments

Please refer to the measuring equipment list in this test report.

#### 3.6.3 Test Procedures

1. The EUT is placed 0.4 meter away from the conducting wall of the shielding room, and is kept at least 80 centimeters from any other grounded conducting surface.
2. Connect EUT to the power mains through a line impedance stabilization network (LISN).
3. All the support units are connecting to the other LISN.
4. The LISN provides 50 ohm coupling impedance for the measuring instrument.
5. The FCC states that a 50 ohm, 50 microhenry LISN shall be used.
6. Both Line and Neutral shall be tested in order to find out the maximum conducted emission.
7. The frequency range from 150 kHz to 30 MHz is scanned.
8. Set the test-receiver system to Peak Detect Function and specified bandwidth (IF bandwidth = 9kHz) with Maximum Hold Mode.

### 3.6.4 Test Setup

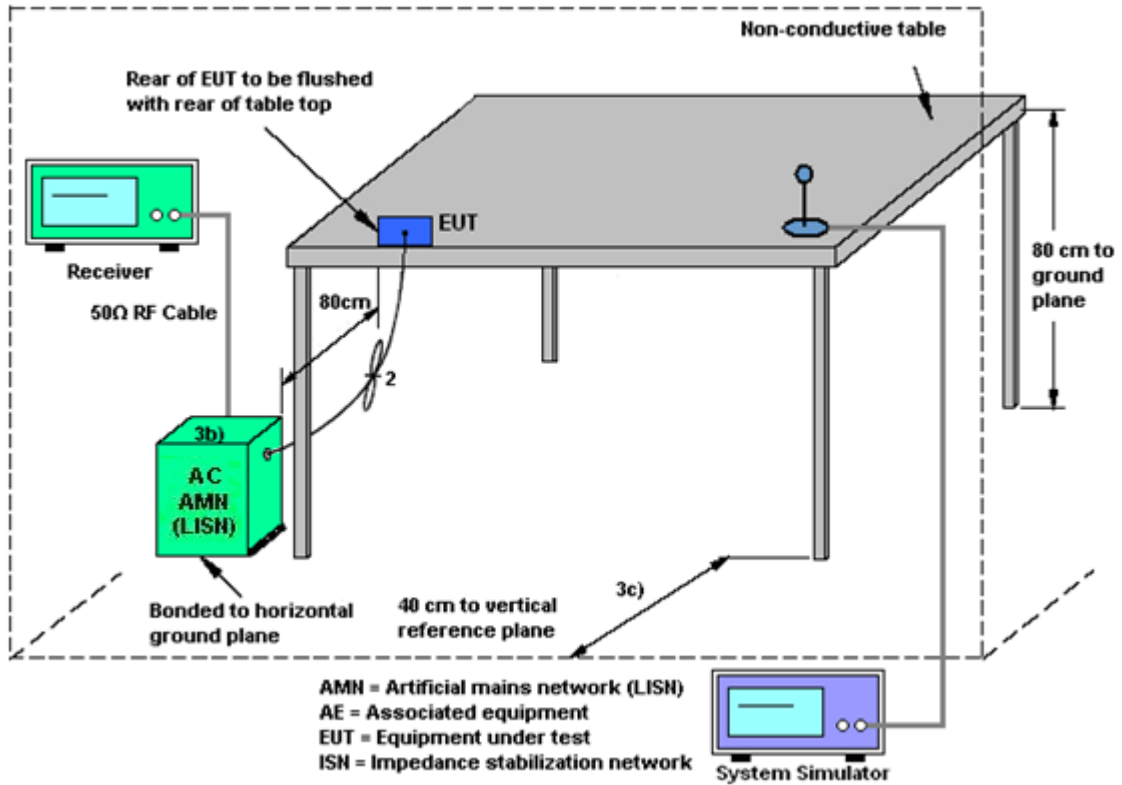

### 3.6.5 Test Result of AC Conducted Emission

Please refer to Appendix B.



## **3.7 Antenna Requirements**

### **3.7.1 Standard Applicable**

The use of a permanently attached antenna or of an antenna that uses a unique coupling to the intentional radiator shall be considered sufficient to comply with the rule.

### **3.7.2 Antenna Anti-Replacement Construction**

An embedded-in antenna design is used.





## 4 List of Measuring Equipment

Instrument	Brand Name	Model No.	Serial No.	Characteristics	Calibration Date	Test Date	Due Date	Remark
Horn Antenna	SCHWARZBECK	BBHA 9120 D	9120D-1522	1GHz~18GHz	Mar. 23, 2023	Apr. 11, 2023~ May 05, 2023	Mar. 22, 2024	Radiation (03CH16-HY)
SHF-EHF Horn Antenna	SCHWARZBECK	BBHA9170	00993	18GHz~40GHz	Nov. 24, 2022	Apr. 11, 2023~ May 05, 2023	Nov. 23, 2023	Radiation (03CH16-HY)
Bilog Antenna	TESEQ	CBL 6111D & 00802N1D01N-06	47020 & 06	30MHz~1GHz	Oct. 08, 2022	Apr. 11, 2023~ May 05, 2023	Oct. 07, 2023	Radiation (03CH16-HY)
Loop Antenna	Rohde & Schwarz	HFH2-Z2	100488	9 kHz~30 MHz	Sep. 20, 2022	Apr. 11, 2023~ May 05, 2023	Sep. 19, 2023	Radiation (03CH16-HY)
Preamplifier	EMEC	EM18G40G	060801	18GHz~40GHz	Jun. 28, 2022	Apr. 11, 2023~ May 05, 2023	Jun. 27, 2023	Radiation (03CH16-HY)
Preamplifier	EMEC	EM1G18G	060812	1GHz~18GHz	Dec. 26, 2022	Apr. 11, 2023~ May 05, 2023	Dec. 25, 2023	Radiation (03CH16-HY)
Preamplifier	Keysight	83017A	MY53270264	1GHz~26.5GHz	Dec. 09, 2022	Apr. 11, 2023~ May 05, 2023	Dec. 08, 2023	Radiation (03CH16-HY)
Amplifier	SONOMA	310N	371607	9kHz~1GHz	Jul. 04, 2022	Apr. 11, 2023~ May 05, 2023	Jul. 03, 2023	Radiation (03CH16-HY)
EMI Test Receiver	Keysight	N9038A(MXE)	MY57290111	3Hz~26.5GHz	Dec. 15, 2022	Apr. 11, 2023~ May 05, 2023	Dec. 14, 2023	Radiation (03CH16-HY)
RF Cable	HUBER + SUHNER	SUCOFLEX 104	805935/4	N/A	Aug. 09, 2022	Apr. 11, 2023~ May 05, 2023	Aug. 08, 2023	Radiation (03CH16-HY)
RF Cable	HUBER + SUHNER	SUCOFLEX 104	802434/4	N/A	Aug. 09, 2022	Apr. 11, 2023~ May 05, 2023	Aug. 08, 2023	Radiation (03CH16-HY)
RF Cable	HUBER + SUHNER	SUCOFLEX 102	EC-A5-300-5757	N/A	Aug. 09, 2022	Apr. 11, 2023~ May 05, 2023	Aug. 08, 2023	Radiation (03CH16-HY)
Software	Audix	E3 6.2009-8-24	RK-001136	N/A	N/A	Apr. 11, 2023~ May 05, 2023	N/A	Radiation (03CH16-HY)
Controller	ChainTek	3000-1	N/A	Control Turn table & Ant Mast	N/A	Apr. 11, 2023~ May 05, 2023	N/A	Radiation (03CH16-HY)
Antenna Mast	ChainTek	MBS-520-1	N/A	1m~4m	N/A	Apr. 11, 2023~ May 05, 2023	N/A	Radiation (03CH16-HY)
Turn Table	ChainTek	T-200-S-1	N/A	0~360 Degree	N/A	Apr. 11, 2023~ May 05, 2023	N/A	Radiation (03CH16-HY)
Hygrometer	TECPEL	DTM-303A	TP201996	N/A	Nov. 17, 2022	Feb. 22, 2023~ May. 26, 2023	Nov. 16, 2023	Conducted (TH05-HY)
Power Sensor	DARE	RPR3006W	16I00054SNO12 (NO:113)	10MHz~6GHz	Dec. 13, 2022	Feb. 22, 2023~ May. 26, 2023	Dec. 12, 2023	Conducted (TH05-HY)
Signal Analyzer	Rohde & Schwarz	FSV40	101905	10Hz - 40GHz(amp)	Aug. 03, 2022	Feb. 22, 2023~ May. 26, 2023	Aug. 02, 2023	Conducted (TH05-HY)
AC Power Source	ChainTek	APC-1000W	N/A	N/A	N/A	Apr. 19, 2023	N/A	Conduction (CO05-HY)
EMI Test Receiver	Rohde & Schwarz	ESR3	102388	9kHz~3.6GHz	Dec. 01, 2022	Apr. 19, 2023	Nov. 30, 2023	Conduction (CO05-HY)
Hygrometer	Testo	608-H1	34913912	N/A	Nov. 17, 2022	Apr. 19, 2023	Nov. 16, 2023	Conduction (CO05-HY)
LISN	Rohde & Schwarz	ENV216	100081	9kHz~30MHz	Nov. 17, 2022	Apr. 19, 2023	Nov. 16, 2023	Conduction (CO05-HY)
Software	Rohde & Schwarz	EMC32	N/A	N/A	N/A	Apr. 19, 2023	N/A	Conduction (CO05-HY)
Pulse Limiter	SCHWARZBECK	VTSD 9561-FN	00691	N/A	Aug. 01, 2022	Apr. 19, 2023	Jul. 31, 2023	Conduction (CO05-HY)
LISN Cable	MVE	RG-400	260260	N/A	Dec. 29, 2022	Apr. 19, 2023	Dec. 28, 2023	Conduction (CO05-HY)



## 5 Measurement Uncertainty

### Uncertainty of Conducted Emission Measurement (150kHz ~ 30MHz)

Measuring Uncertainty for a Level of Confidence of 95% ( $U = 2Uc(y)$ )	3.5 dB
---	--------

### Uncertainty of Radiated Emission Measurement (30 MHz ~ 1000 MHz)

Measuring Uncertainty for a Level of Confidence of 95% ( $U = 2Uc(y)$ )	6.5 dB
---	--------

### Uncertainty of Radiated Emission Measurement (1000 MHz ~ 6000 MHz)

Measuring Uncertainty for a Level of Confidence of 95% ( $U = 2Uc(y)$ )	4.6 dB
---	--------

### Uncertainty of Radiated Emission Measurement (6000 MHz ~ 18000 MHz)

Measuring Uncertainty for a Level of Confidence of 95% ( $U = 2Uc(y)$ )	4.5 dB
---	--------

### Uncertainty of Radiated Emission Measurement (18000 MHz ~ 40000 MHz)

Measuring Uncertainty for a Level of Confidence of 95% ( $U = 2Uc(y)$ )	5.6 dB
---	--------

**Appendix A. Test Result of Conducted Test Items**

Test Engineer:	Ching Chen and Junyu Jhou	Temperature:	21~25	°C
Test Date:	2023/2/22-2023/5/26	Relative Humidity:	51~54	%

**TEST RESULTS DATA**  
**6dB and 99% Occupied Bandwidth**

2.4GHz Band Single Antenna										
Mod.	Data Rate	NTX	CH.	Freq. (MHz)	99% Occupied BW (MHz)		6dB BW (MHz)		6dB BW Limit (MHz)	Pass/Fail
					Ant3	Ant4	Ant3	Ant4		
11b	1Mbps	1	1	2412	11.09	11.09	8.10	8.10	0.50	Pass
11b	1Mbps	1	6	2437	11.04	11.09	8.12	8.12	0.50	Pass
11b	1Mbps	1	11	2462	11.19	11.04	8.12	8.10	0.50	Pass

2.4GHz Band MIMO										
Mod.	Data Rate	NTX	CH.	Freq. (MHz)	99% Occupied BW (MHz)		6dB BW (MHz)		6dB BW Limit (MHz)	Pass/Fail
					Ant3	Ant4	Ant3	Ant4		
11g	6Mbps	2	1	2412	18.48	18.43	16.38	16.38	0.50	Pass
11g	6Mbps	2	6	2437	19.13	18.78	16.38	16.40	0.50	Pass
11g	6Mbps	2	11	2462	18.58	18.33	16.36	16.38	0.50	Pass

**TEST RESULTS DATA**  
**Average Output Power**

2.4GHz Band Single Antenna																
Mod.	Data Rate	NTX	CH.	Freq. (MHz)	Average Conducted Power (dBm)			Conducted Power Limit (dBm)		DG (dBi)		EIRP Power (dBm)		EIRP Power Limit (dBm)		Pass /Fail
					Ant3	Ant4	SUM	Ant3	Ant4	Ant3	Ant4	Ant3	Ant4	Ant3	Ant4	
11b	1Mbps	1	1	2412	22.45	22.45		30.00	30.00	-2.20	-0.60	20.25	21.85	36.00	36.00	Pass
11b	1Mbps	1	6	2437	22.45	22.45		30.00	30.00	-2.20	-0.60	20.25	21.85	36.00	36.00	Pass
11b	1Mbps	1	11	2462	22.45	22.25		30.00	30.00	-2.20	-0.60	20.25	21.65	36.00	36.00	Pass
11b	1Mbps	1	12	2467	22.45	22.25		30.00	30.00	-2.20	-0.60	20.25	21.65	36.00	36.00	Pass
11b	1Mbps	1	13	2472	21.15	19.55		30.00	30.00	-2.20	-0.60	18.95	18.95	36.00	36.00	Pass

2.4GHz Band MIMO																
Mod.	Data Rate	NTX	CH.	Freq. (MHz)	Average Conducted Power (dBm)			Conducted Power Limit (dBm)		DG (dBi)		EIRP Power (dBm)		EIRP Power Limit (dBm)		Pass /Fail
					Ant3	Ant4	SUM	Ant3	Ant4	Ant3	Ant4	Ant3	Ant4	Ant3	Ant4	
11g	6Mbps	2	1	2412	21.25	21.15	24.21	30.00		-0.60		23.61		36.00		Pass
11g	6Mbps	2	6	2437	21.95	21.95	24.96	30.00		-0.60		24.36		36.00		Pass
11g	6Mbps	2	11	2462	19.65	19.65	22.66	30.00		-0.60		22.06		36.00		Pass
11g	6Mbps	2	12	2467	16.45	16.25	19.36	30.00		-0.60		18.76		36.00		Pass
11g	6Mbps	2	13	2472	12.95	12.25	15.62	30.00		-0.60		15.02		36.00		Pass
HT20	MCS0	2	1	2412	20.45	20.35	23.41	30.00		-0.60		22.81		36.00		Pass
HT20	MCS0	2	6	2437	20.65	20.65	23.66	30.00		-0.60		23.06		36.00		Pass
HT20	MCS0	2	11	2462	18.45	18.35	21.41	30.00		-0.60		20.81		36.00		Pass
HT20	MCS0	2	12	2467	15.65	15.55	18.61	30.00		-0.60		18.01		36.00		Pass
HT20	MCS0	2	13	2472	13.05	12.35	15.72	30.00		-0.60		15.12		36.00		Pass
VHT20	MCS0	2	1	2412	20.45	20.35	23.41	30.00		-0.60		22.81		36.00		Pass
VHT20	MCS0	2	6	2437	20.65	20.65	23.66	30.00		-0.60		23.06		36.00		Pass
VHT20	MCS0	2	11	2462	18.45	18.35	21.41	30.00		-0.60		20.81		36.00		Pass
VHT20	MCS0	2	12	2467	15.65	15.55	18.61	30.00		-0.60		18.01		36.00		Pass
VHT20	MCS0	2	13	2472	13.05	12.35	15.72	30.00		-0.60		15.12		36.00		Pass

Note: Measured power (dBm) has offset with cable loss.

**TEST RESULTS DATA**  
**Peak Power Spectral Density**

2.4GHz Band Single Antenna												
Mod.	Data Rate	NTX	CH.	Freq. (MHz)	Peak PSD (dBm/3kHz)			DG (dBi)		Peak PSD Limit (dBm/3kHz)		Pass/Fail
					Ant3	Ant4	Worse + 3.01	Ant3	Ant4	Ant3	Ant4	
11b	1Mbps	1	1	2412	1.30	0.17		-2.20	-0.60	8.00	8.00	Pass
11b	1Mbps	1	6	2437	1.62	0.39		-2.20	-0.60	8.00	8.00	Pass
11b	1Mbps	1	11	2462	1.17	0.20		-2.20	-0.60	8.00	8.00	Pass
11b	1Mbps	1	12	2467	0.77	0.95		-2.20	-0.60	8.00	8.00	Pass
11b	1Mbps	1	13	2472	0.05	-1.25		-2.20	-0.60	8.00	8.00	Pass

2.4GHz Band MIMO												
Mod.	Data Rate	NTX	CH.	Freq. (MHz)	Peak PSD (dBm/3kHz)			DG (dBi)		Peak PSD Limit (dBm/3kHz)		Pass/Fail
					Ant3	Ant4	Worse + 3.01	Ant3	Ant4	Ant3	Ant4	
11g	6Mbps	2	1	2412	-5.03	-4.62	-1.61	1.65		8.00		Pass
11g	6Mbps	2	6	2437	-4.04	-3.47	-0.46	1.65		8.00		Pass
11g	6Mbps	2	11	2462	-5.49	-5.80	-2.48	1.65		8.00		Pass
11g	6Mbps	2	12	2467	-9.50	-9.50	-6.49	1.65		8.00		Pass
11g	6Mbps	2	13	2472	-12.93	-13.56	-9.92	1.65		8.00		Pass

Measured power density (dBm) has offset with cable loss.

**TEST RESULTS DATA**  
**Average Output Power**

2.4GHz Band MIMO																	
Mod.	Data Rate	Ntx	CH.	Freq. (MHz)	RU Config	Average Conducted Power (dBm)			Conducted Power Limit (dBm)		DG (dBi)		EIRP Power (dBm)		EIRP Power Limit (dBm)		Pass /Fail
						Ant3	Ant4	SUM	Ant3	Ant4	Ant3	Ant4	Ant3	Ant4	Ant3	Ant4	
HE20	MCS0	2	1	2412	Full	20.45	20.35	23.41	30.00		-0.60		22.81		36.00	Pass	
HE20	MCS0	2	1	2412	26/0	13.55	13.05	16.32	30.00		-0.60		15.72		36.00	Pass	
HE20	MCS0	2	1	2412	52/37	15.45	15.05	18.26	30.00		-0.60		17.66		36.00	Pass	
HE20	MCS0	2	1	2412	106/53	18.25	18.05	21.16	30.00		-0.60		20.56		36.00	Pass	
HE20	MCS0	2	6	2437	Full	20.65	20.65	23.66	30.00		-0.60		23.06		36.00	Pass	
HE20	MCS0	2	6	2437	26/4	14.05	13.95	17.01	30.00		-0.60		16.41		36.00	Pass	
HE20	MCS0	2	6	2437	52/38	15.85	15.95	18.91	30.00		-0.60		18.31		36.00	Pass	
HE20	MCS0	2	6	2437	106/53	17.75	17.85	20.81	30.00		-0.60		20.21		36.00	Pass	
HE20	MCS0	2	11	2462	Full	18.45	18.35	21.41	30.00		-0.60		20.81		36.00	Pass	
HE20	MCS0	2	11	2462	26/8	11.05	10.55	13.82	30.00		-0.60		13.22		36.00	Pass	
HE20	MCS0	2	11	2462	52/40	13.95	13.55	16.76	30.00		-0.60		16.16		36.00	Pass	
HE20	MCS0	2	11	2462	106/54	15.95	16.05	19.01	30.00		-0.60		18.41		36.00	Pass	
HE20	MCS0	2	12	2467	Full	15.65	15.55	18.61	30.00		-0.60		18.01		36.00	Pass	
HE20	MCS0	2	12	2467	26/8	7.95	7.35	10.67	30.00		-0.60		10.07		36.00	Pass	
HE20	MCS0	2	12	2467	52/40	10.55	9.95	13.27	30.00		-0.60		12.67		36.00	Pass	
HE20	MCS0	2	12	2467	106/54	13.25	13.05	16.16	30.00		-0.60		15.56		36.00	Pass	
HE20	MCS0	2	13	2472	Full	13.05	12.35	15.72	30.00		-0.60		15.12		36.00	Pass	
HE20	MCS0	2	13	2472	26/8	5.05	4.25	7.68	30.00		-0.60		7.08		36.00	Pass	
HE20	MCS0	2	13	2472	52/40	7.65	6.65	10.19	30.00		-0.60		9.59		36.00	Pass	
HE20	MCS0	2	13	2472	106/54	9.85	9.35	12.62	30.00		-0.60		12.02		36.00	Pass	

Note: Measured power (dBm) has offset with cable loss.

**TEST RESULTS DATA**  
**6dB and 99% Occupied Bandwidth**

2.4GHz Band MIMO											
Mod.	Data Rate	N <sub>TX</sub>	CH.	Freq. (MHz)	RU Config	99% Occupied BW (MHz)		6dB BW (MHz)		6dB BW Limit (MHz)	Pass/Fail
						Ant3	Ant4	Ant3	Ant4		
EHT20	MCS0	2	1	2412	Full	19.73	19.73	18.95	18.78	0.50	Pass
EHT20	MCS0	2	6	2437	Full	19.93	19.93	19.03	19.03	0.50	Pass
EHT20	MCS0	2	11	2462	Full	19.78	19.73	18.85	18.53	0.50	Pass
EHT20	MCS0	2	12	2467	Full	19.93	19.73	18.78	18.73	0.50	Pass
EHT20	MCS0	2	13	2472	Full	19.63	19.53	18.98	18.98	0.50	Pass



**TEST RESULTS DATA**  
**Average Output Power**

2.4GHz Band MIMO																	
Mod.	Data Rate	N <sub>Tx</sub>	CH.	Freq. (MHz)	RU Config.	Average Conducted Power (dBm)			Conducted Power Limit (dBm)		DG (dBi)		EIRP Power (dBm)		EIRP Power Limit (dBm)		Pass /Fail
						Ant3	Ant4	SUM	Ant3	Ant4	Ant3	Ant4	Ant3	Ant4	Ant3	Ant4	
EHT20	MCS0	2	1	2412	Full	20.55	20.45	23.51	30.00		-0.60	22.91		36.00		Pass	
EHT20	MCS0	2	1	2412	26/0	13.65	13.15	16.42	30.00		-0.60	15.82		36.00		Pass	
EHT20	MCS0	2	1	2412	52/37	15.55	15.15	18.36	30.00		-0.60	17.76		36.00		Pass	
EHT20	MCS0	2	1	2412	106/53	18.35	18.15	21.26	30.00		-0.60	20.66		36.00		Pass	
EHT20	MCS0	2	1	2412	52T+26T/70	16.65	16.65	19.66	30.00		-0.60	19.06		36.00		Pass	
EHT20	MCS0	2	1	2412	106T+26T/82	18.55	18.45	21.51	30.00		-0.60	20.91		36.00		Pass	
EHT20	MCS0	2	6	2437	Full	20.75	20.75	23.76	30.00		-0.60	23.16		36.00		Pass	
EHT20	MCS0	2	6	2437	26/4	14.15	14.05	17.11	30.00		-0.60	16.51		36.00		Pass	
EHT20	MCS0	2	6	2437	52/38	15.95	16.05	19.01	30.00		-0.60	18.41		36.00		Pass	
EHT20	MCS0	2	6	2437	106/53	17.85	17.95	20.91	30.00		-0.60	20.31		36.00		Pass	
EHT20	MCS0	2	6	2437	52T+26T/71	16.85	17.25	20.06	30.00		-0.60	19.46		36.00		Pass	
EHT20	MCS0	2	6	2437	106T+26T/83	18.85	19.45	22.17	30.00		-0.60	21.57		36.00		Pass	
EHT20	MCS0	2	11	2462	Full	18.55	18.45	21.51	30.00		-0.60	20.91		36.00		Pass	
EHT20	MCS0	2	11	2462	26/8	11.15	10.65	13.92	30.00		-0.60	13.32		36.00		Pass	
EHT20	MCS0	2	11	2462	52/40	14.05	13.65	16.86	30.00		-0.60	16.26		36.00		Pass	
EHT20	MCS0	2	11	2462	106/54	16.05	16.15	19.11	30.00		-0.60	18.51		36.00		Pass	
EHT20	MCS0	2	11	2462	52T+26T/72	16.05	16.05	19.06	30.00		-0.60	18.46		36.00		Pass	
EHT20	MCS0	2	11	2462	106T+26T/83	17.35	17.35	20.36	30.00		-0.60	19.76		36.00		Pass	
EHT20	MCS0	2	12	2467	Full	15.75	15.65	18.71	30.00		-0.60	18.11		36.00		Pass	
EHT20	MCS0	2	12	2467	26/8	8.05	7.45	10.77	30.00		-0.60	10.17		36.00		Pass	
EHT20	MCS0	2	12	2467	52/40	10.65	10.05	13.37	30.00		-0.60	12.77		36.00		Pass	
EHT20	MCS0	2	12	2467	106/54	13.35	13.15	16.26	30.00		-0.60	15.66		36.00		Pass	
EHT20	MCS0	2	12	2467	52T+26T/72	12.95	12.65	15.81	30.00		-0.60	15.21		36.00		Pass	
EHT20	MCS0	2	12	2467	106T+26T/83	14.75	14.65	17.71	30.00		-0.60	17.11		36.00		Pass	
EHT20	MCS0	2	13	2472	Full	13.15	12.45	15.82	30.00		-0.60	15.22		36.00		Pass	
EHT20	MCS0	2	13	2472	26/8	5.15	4.35	7.78	30.00		-0.60	7.18		36.00		Pass	
EHT20	MCS0	2	13	2472	52/40	7.75	6.75	10.29	30.00		-0.60	9.69		36.00		Pass	
EHT20	MCS0	2	13	2472	106/54	9.95	9.45	12.72	30.00		-0.60	12.12		36.00		Pass	
EHT20	MCS0	2	13	2472	52T+26T/72	10.35	9.45	12.93	30.00		-0.60	12.33		36.00		Pass	
EHT20	MCS0	2	13	2472	106T+26T/83	12.35	11.95	15.16	30.00		-0.60	14.56		36.00		Pass	

Note: Measured power (dBm) has offset with cable loss.

**TEST RESULTS DATA**  
**Peak Power Spectral Density**

2.4GHz Band MIMO													
Mod.	Data Rate	NTx	CH.	Freq. (MHz)	RU Config.	Peak PSD (dBm/3kHz)			DG (dBi)		Peak PSD Limit (dBm/3kHz)		Pass/Fail
						Ant3	Ant4	Worse + 3.01	Ant3	Ant4	Ant3	Ant4	
EHT20	MCS0	2	1	2412	Full	-5.13	-4.65	-1.64	1.65		8.00		Pass
EHT20	MCS0	2	1	2412	26/0	-5.09	-4.92	-1.91	1.65		8.00		Pass
EHT20	MCS0	2	1	2412	52/37	-4.96	-5.24	-1.95	1.65		8.00		Pass
EHT20	MCS0	2	1	2412	106/53	-5.00	-5.15	-1.99	1.65		8.00		Pass
EHT20	MCS0	2	1	2412	52T+26T/70	-5.15	-4.97	-1.96	1.65		8.00		Pass
EHT20	MCS0	2	1	2412	106T+26T/82	-5.41	-4.66	-1.65	1.65		8.00		Pass
EHT20	MCS0	2	6	2437	Full	-4.63	-3.87	-0.86	1.65		8.00		Pass
EHT20	MCS0	2	6	2437	26/4	-4.14	-4.48	-1.13	1.65		8.00		Pass
EHT20	MCS0	2	6	2437	52/38	-4.75	-4.38	-1.37	1.65		8.00		Pass
EHT20	MCS0	2	6	2437	106/53	-5.04	-4.10	-1.09	1.65		8.00		Pass
EHT20	MCS0	2	6	2437	52T+26T/71	-4.84	-3.95	-0.94	1.65		8.00		Pass
EHT20	MCS0	2	6	2437	106T+26T/83	-4.81	-4.03	-1.02	1.65		8.00		Pass
EHT20	MCS0	2	11	2462	Full	-5.99	-5.32	-2.31	1.65		8.00		Pass
EHT20	MCS0	2	11	2462	26/8	-5.80	-6.27	-2.79	1.65		8.00		Pass
EHT20	MCS0	2	11	2462	52/40	-5.93	-6.36	-2.92	1.65		8.00		Pass
EHT20	MCS0	2	11	2462	106/54	-6.25	-5.38	-2.37	1.65		8.00		Pass
EHT20	MCS0	2	11	2462	52T+26T/72	-6.26	-5.88	-2.87	1.65		8.00		Pass
EHT20	MCS0	2	11	2462	106T+26T/83	-6.14	-5.60	-2.59	1.65		8.00		Pass
EHT20	MCS0	2	12	2467	Full	-8.82	-8.89	-5.81	1.65		8.00		Pass
EHT20	MCS0	2	12	2467	26/8	-9.03	-9.21	-6.02	1.65		8.00		Pass
EHT20	MCS0	2	12	2467	52/40	-9.19	-9.77	-6.18	1.65		8.00		Pass
EHT20	MCS0	2	12	2467	106/54	-9.16	-9.32	-6.15	1.65		8.00		Pass
EHT20	MCS0	2	12	2467	52T+26T/72	-8.97	-9.37	-5.96	1.65		8.00		Pass
EHT20	MCS0	2	12	2467	106T+26T/83	-8.97	-8.96	-5.95	1.65		8.00		Pass
EHT20	MCS0	2	13	2472	Full	-11.67	-12.25	-8.66	1.65		8.00		Pass
EHT20	MCS0	2	13	2472	26/8	-11.89	-12.59	-8.88	1.65		8.00		Pass
EHT20	MCS0	2	13	2472	52/40	-12.19	-12.85	-9.18	1.65		8.00		Pass
EHT20	MCS0	2	13	2472	106/54	-11.69	-12.48	-8.68	1.65		8.00		Pass
EHT20	MCS0	2	13	2472	52T+26T/72	-11.78	-12.08	-8.77	1.65		8.00		Pass
EHT20	MCS0	2	13	2472	106T+26T/83	-11.83	-12.60	-8.82	1.65		8.00		Pass

Measured power density (dBm) has offset with cable loss.



# 6dB and 99% Occupied Bandwidth

<Ant. 3>

<802.11b>

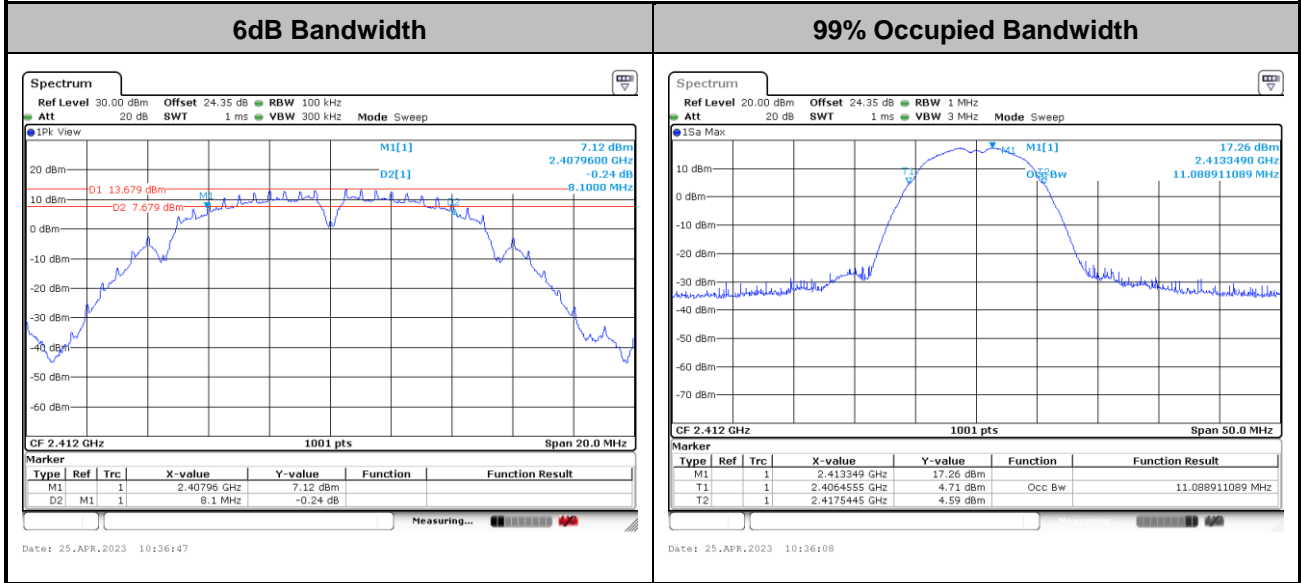

Note: The occupied channel bandwidth is maintained within the band of operation for all of the modulations.

<Ant. 4>

<802.11b>

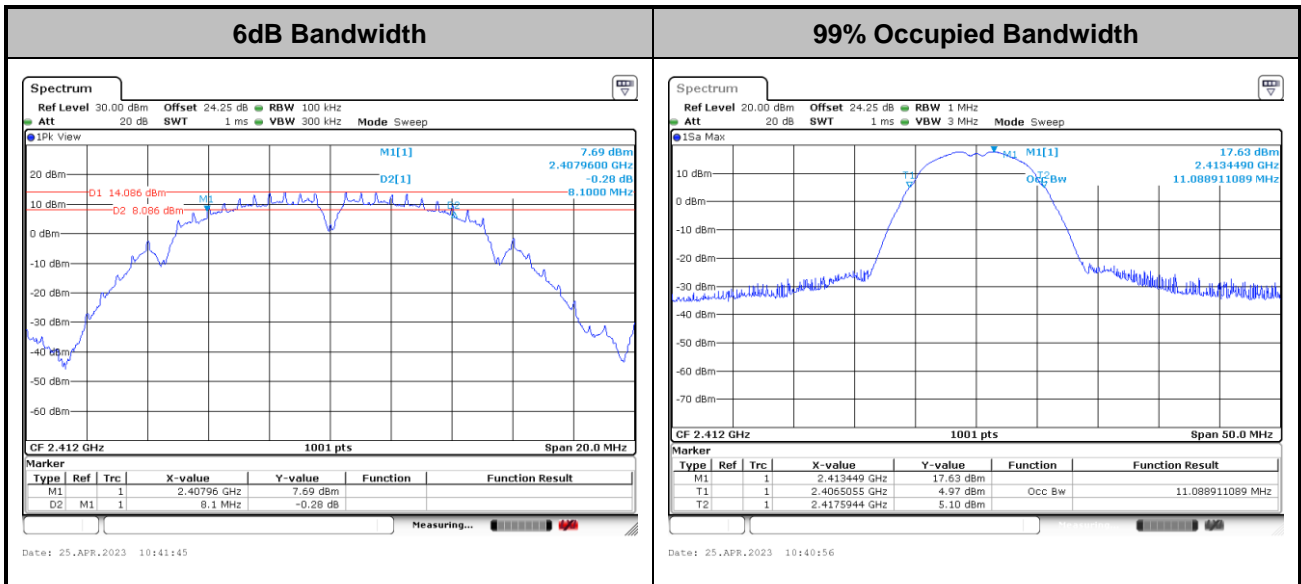

Note: The occupied channel bandwidth is maintained within the band of operation for all of the modulations.



MIMO <Ant. 3+4>

<802.11g>

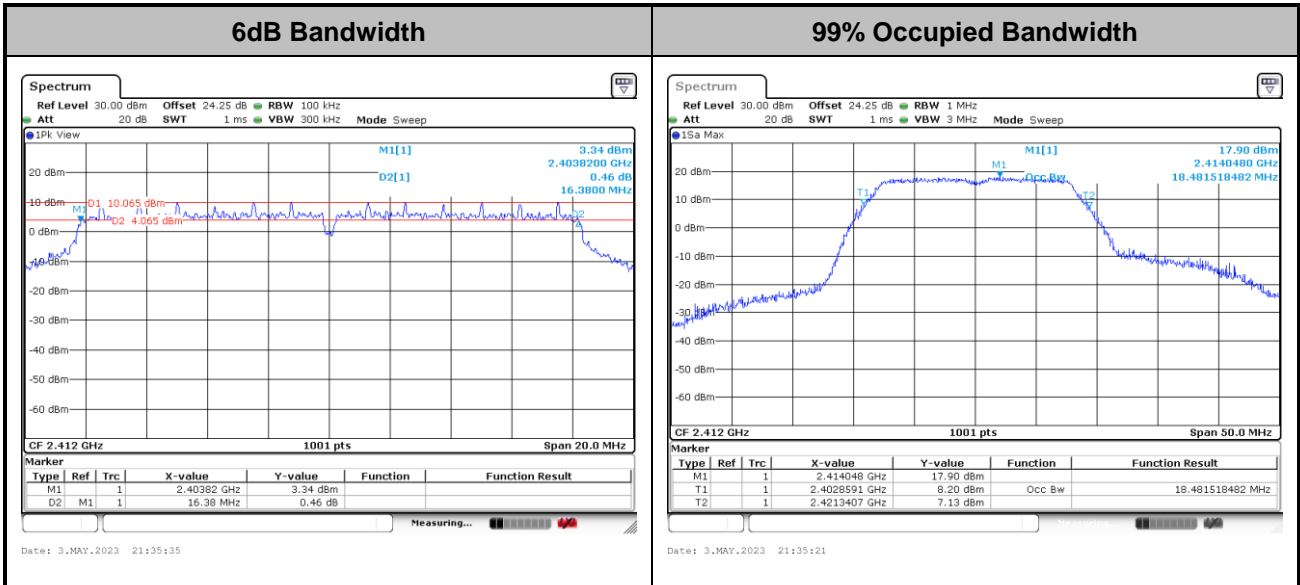

Note: The occupied channel bandwidth is maintained within the band of operation for all of the modulations.

<802.11be EHT20>

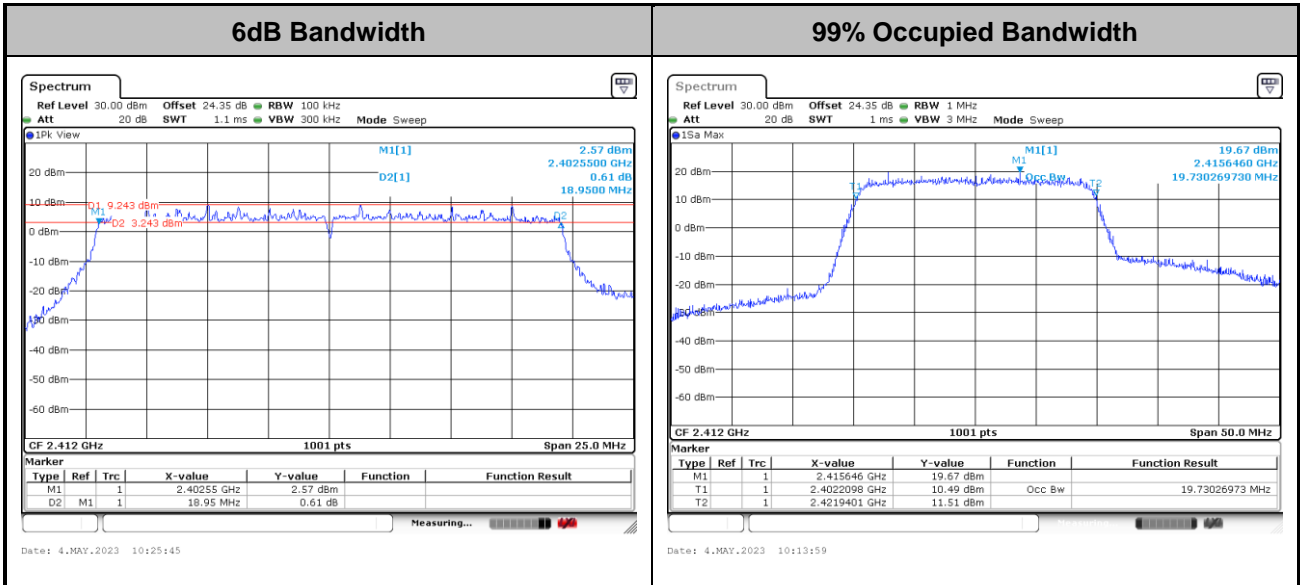

Note: The occupied channel bandwidth is maintained within the band of operation for all of the modulations.



### Power Spectral Density(dBm/3kHz)

<802.11b>

<Ant. 3>

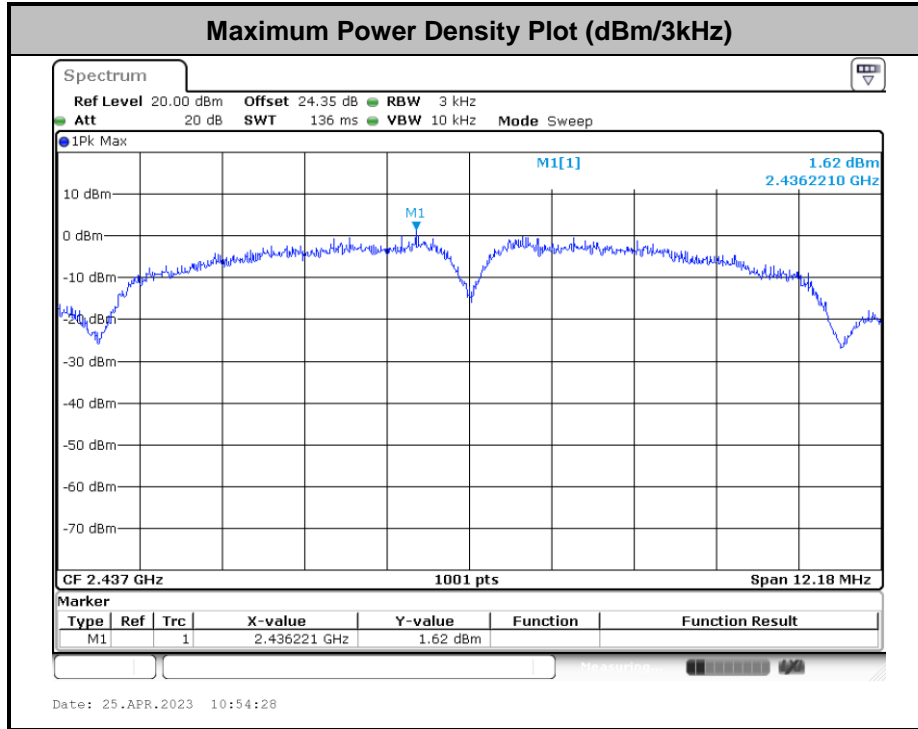

<Ant. 4>

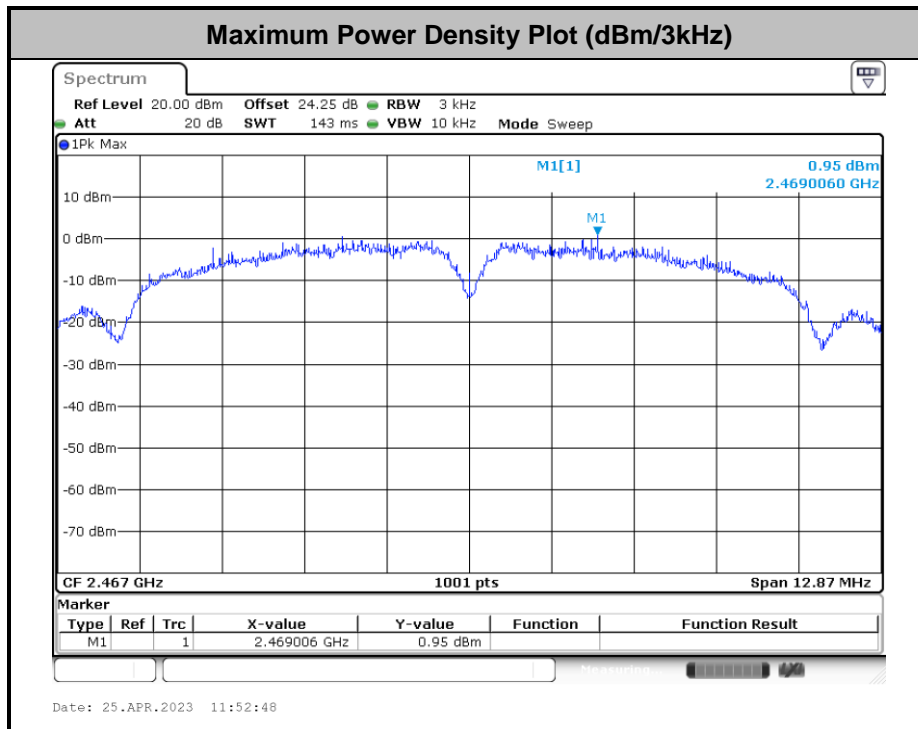



<802.11be EHT20>

Maximum Power Density Plot (dBm/3kHz)

MIMO Ant. 3

MIMO Ant. 4

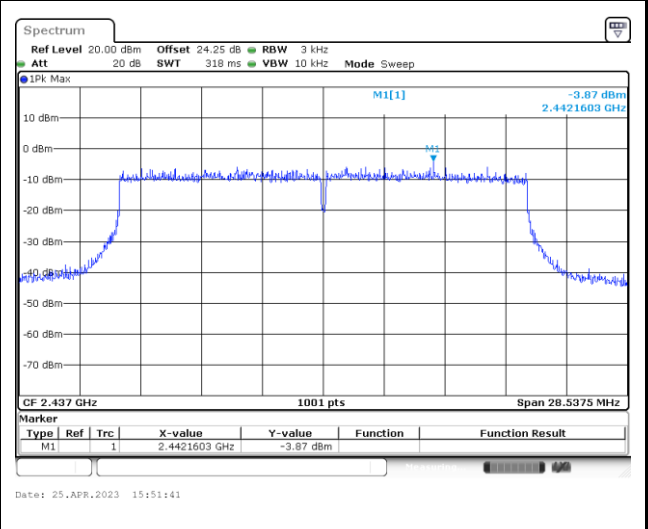
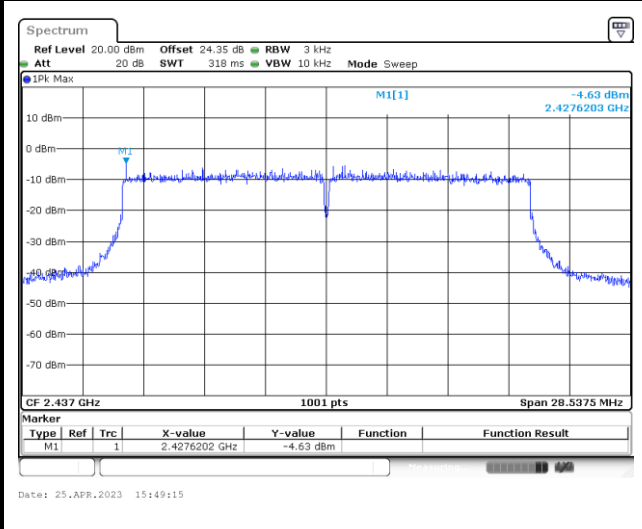



# Band Edges and Spurious Emission

Number of TX = 1, Ant. 3 (Measured)

Test Mode :	802.11b	Test Channel :	01
-------------	---------	----------------	----

<b>100kHz PSD reference Level</b>	<b>Low Channel Plot</b>
-----------------------------------	-------------------------

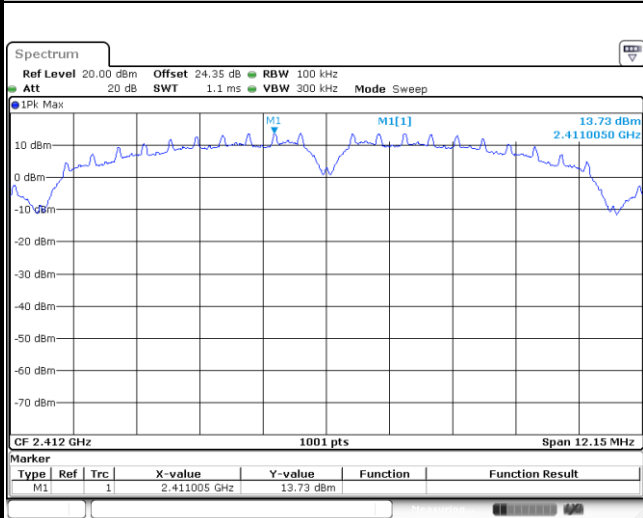

Date: 25.APR.2023 10:37:37

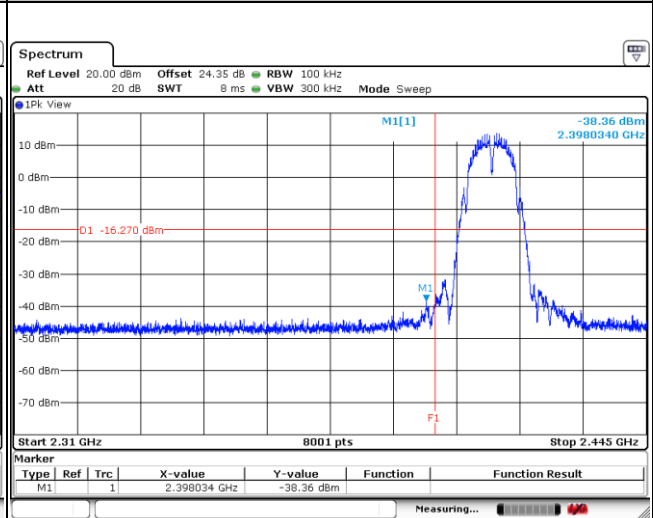

Date: 25.APR.2023 10:39:11

<b>Spurious Emission 30MHz~1GHz</b>	<b>Spurious Emission 1GHz~26.5GHz</b>
-------------------------------------	---------------------------------------

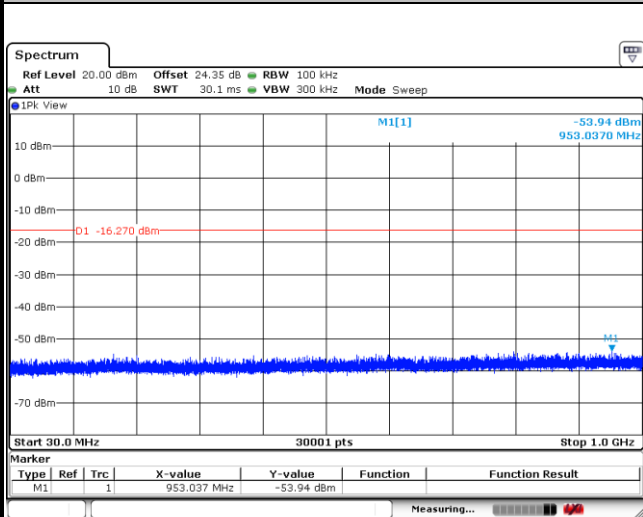

Date: 25.APR.2023 10:37:56

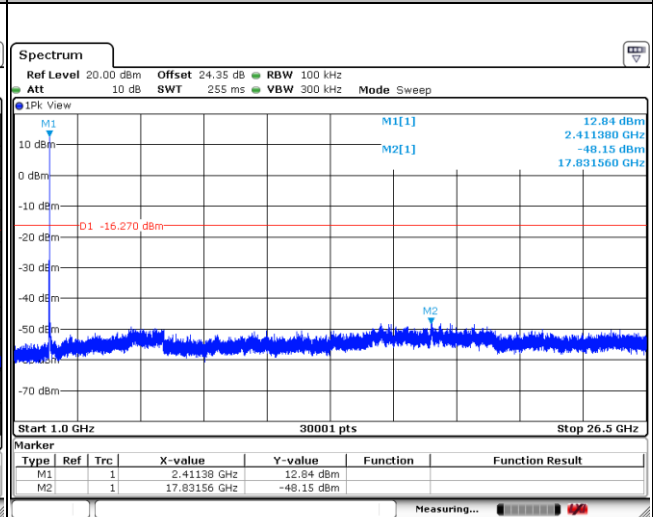

Date: 25.APR.2023 10:38:24



Test Mode :	802.11b	Test Channel :	06
-------------	---------	----------------	----

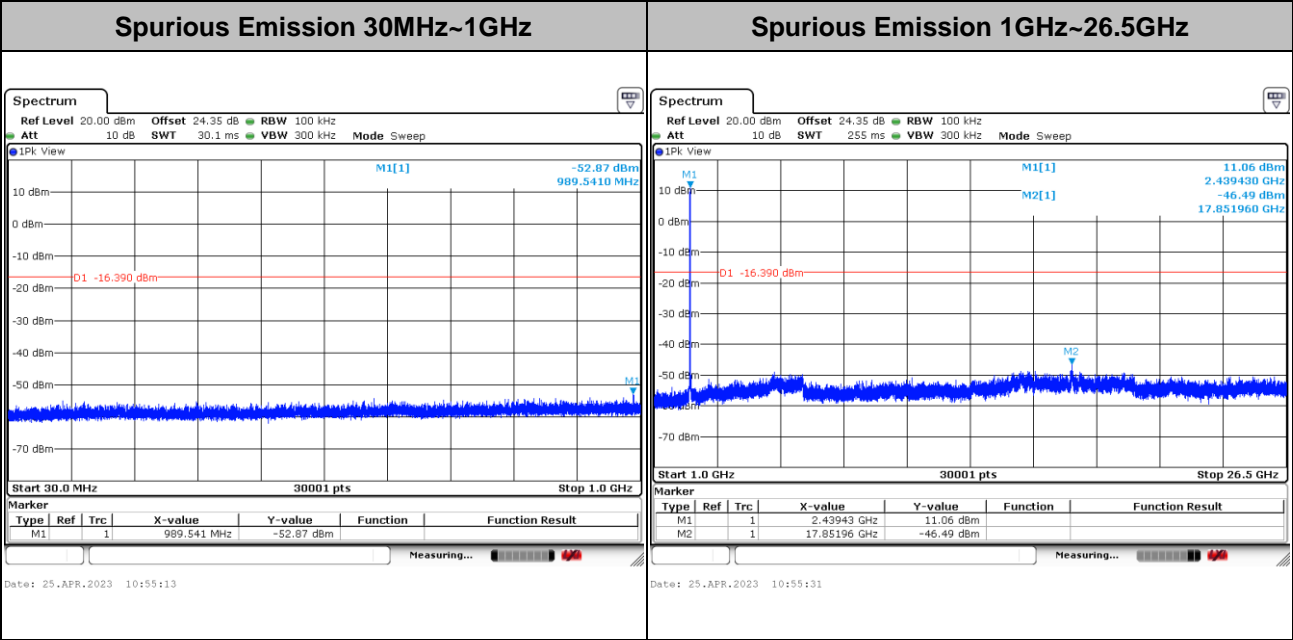
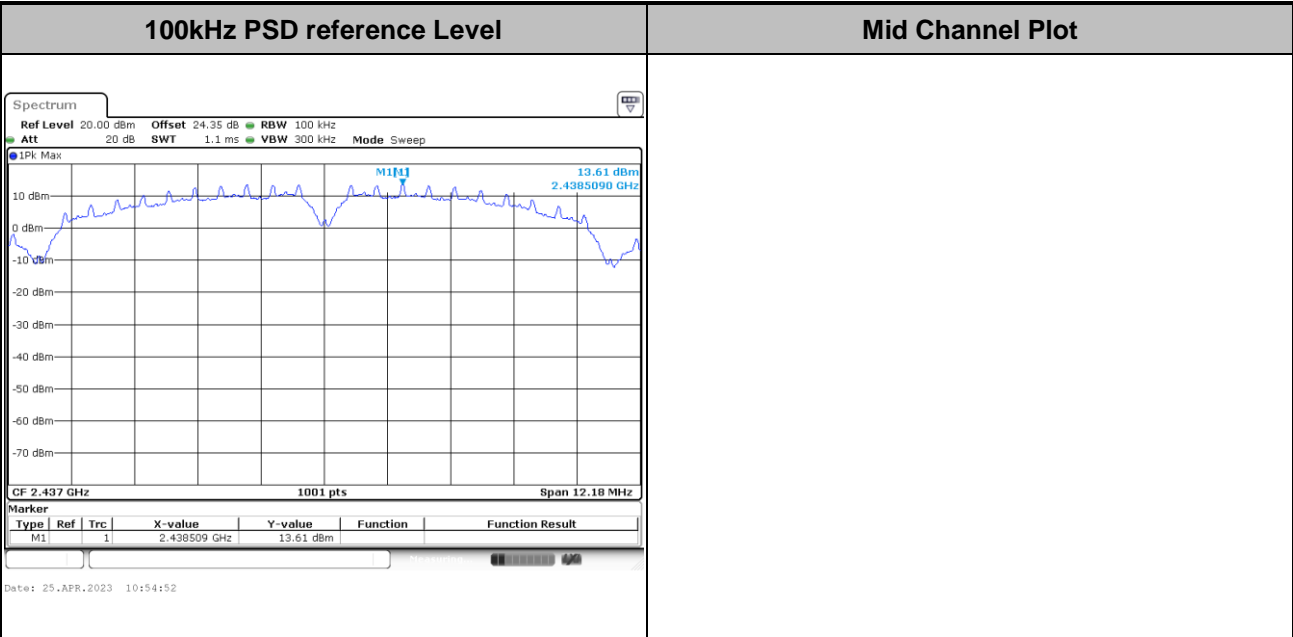





Test Mode :	802.11b	Test Channel :	11
-------------	---------	----------------	----

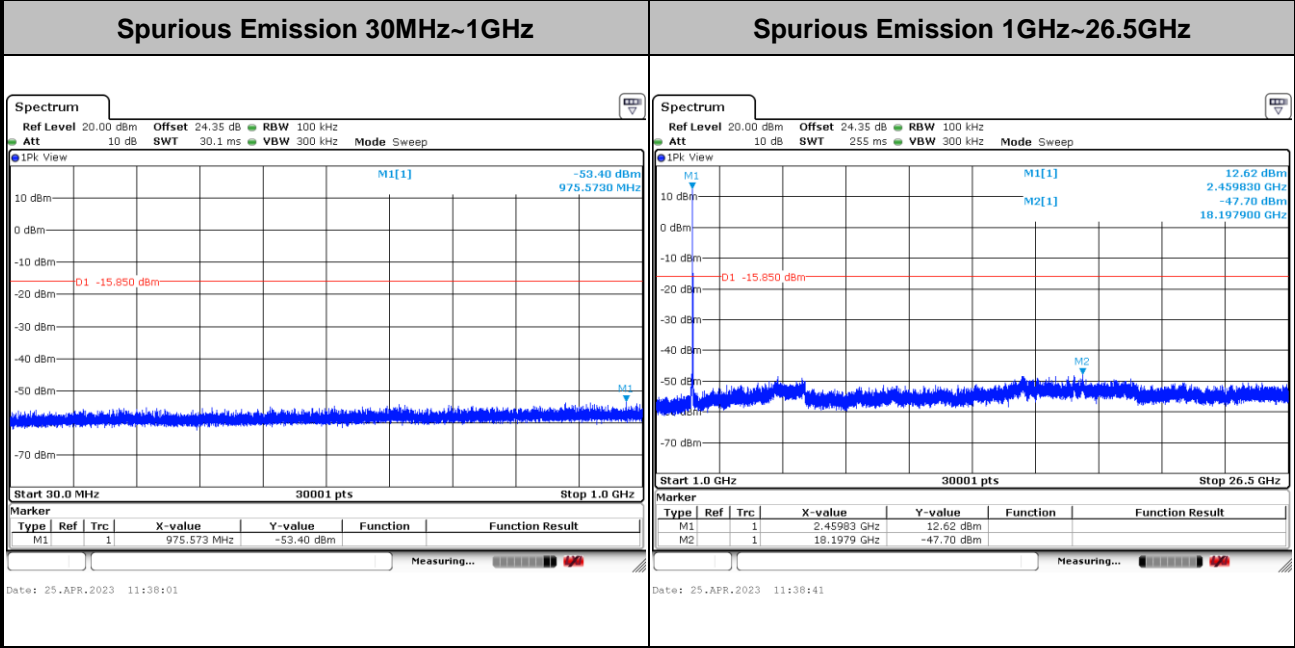
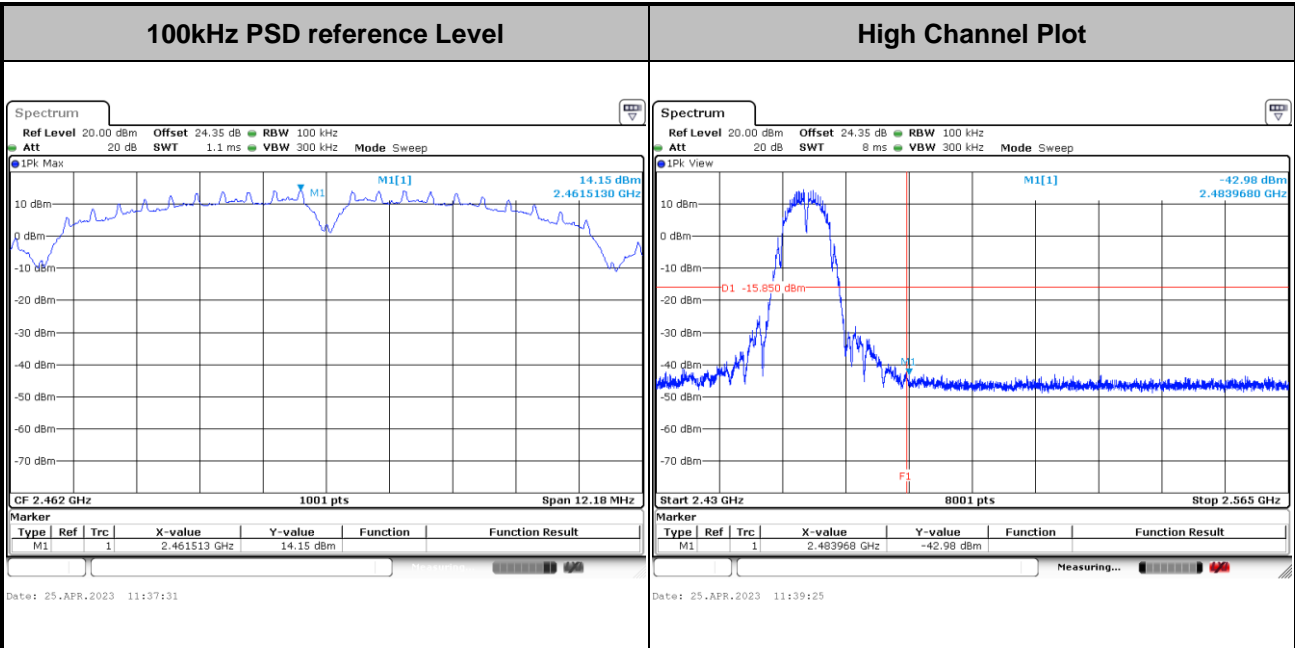



Test Mode :	802.11b	Test Channel :	12
-------------	---------	----------------	----

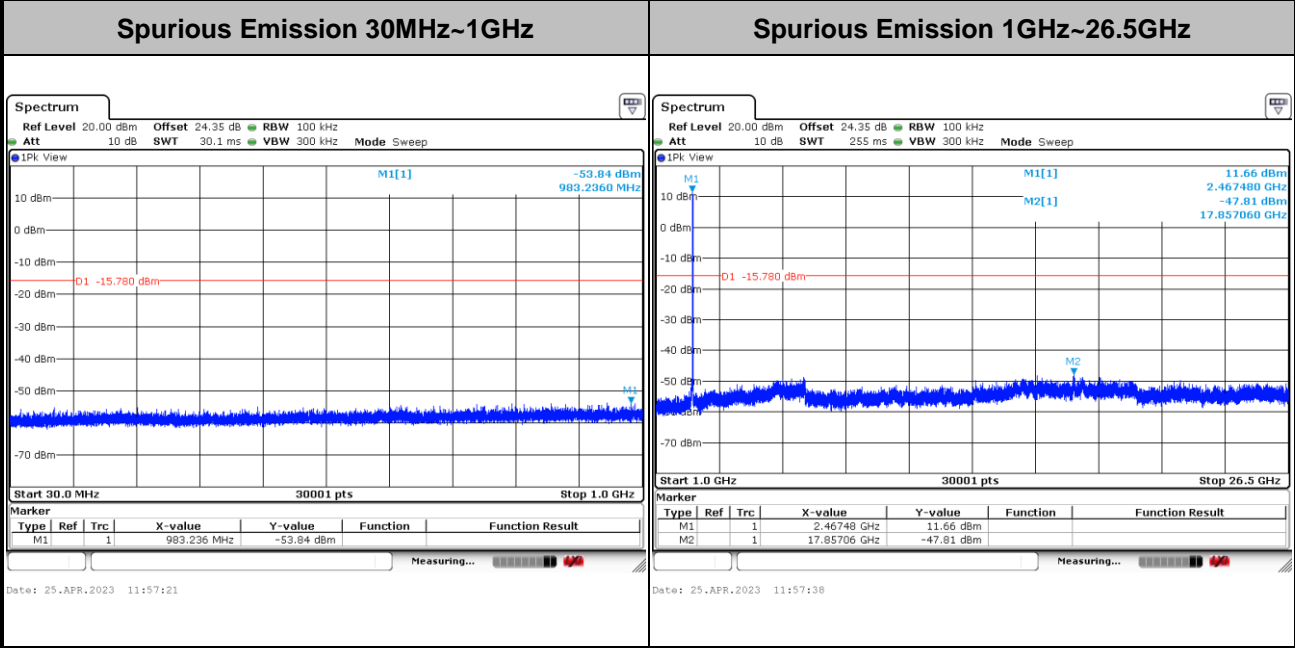
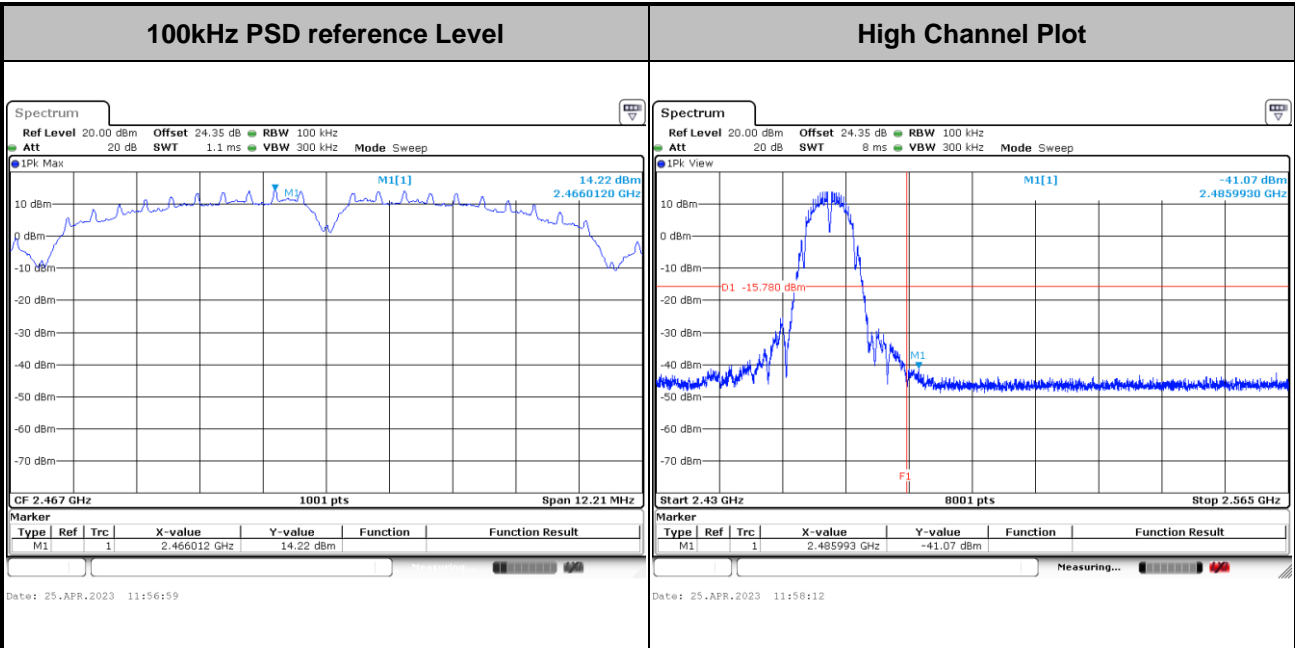



Test Mode :	802.11b	Test Channel :	13
-------------	---------	----------------	----

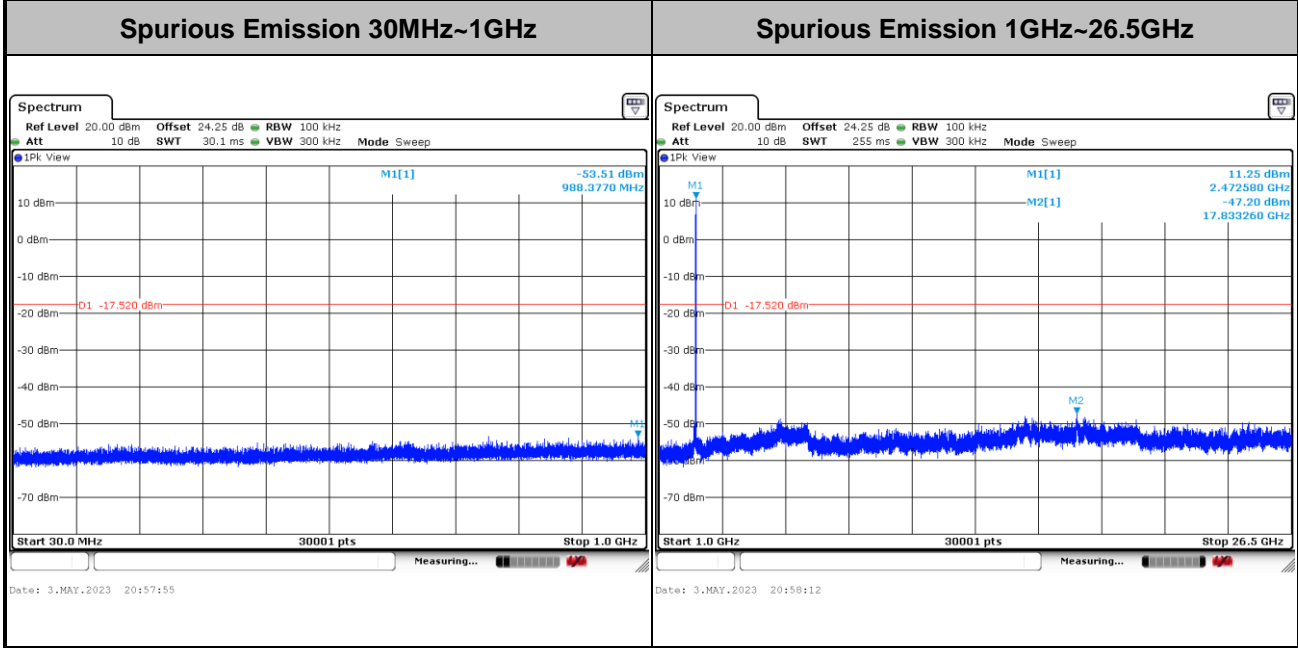
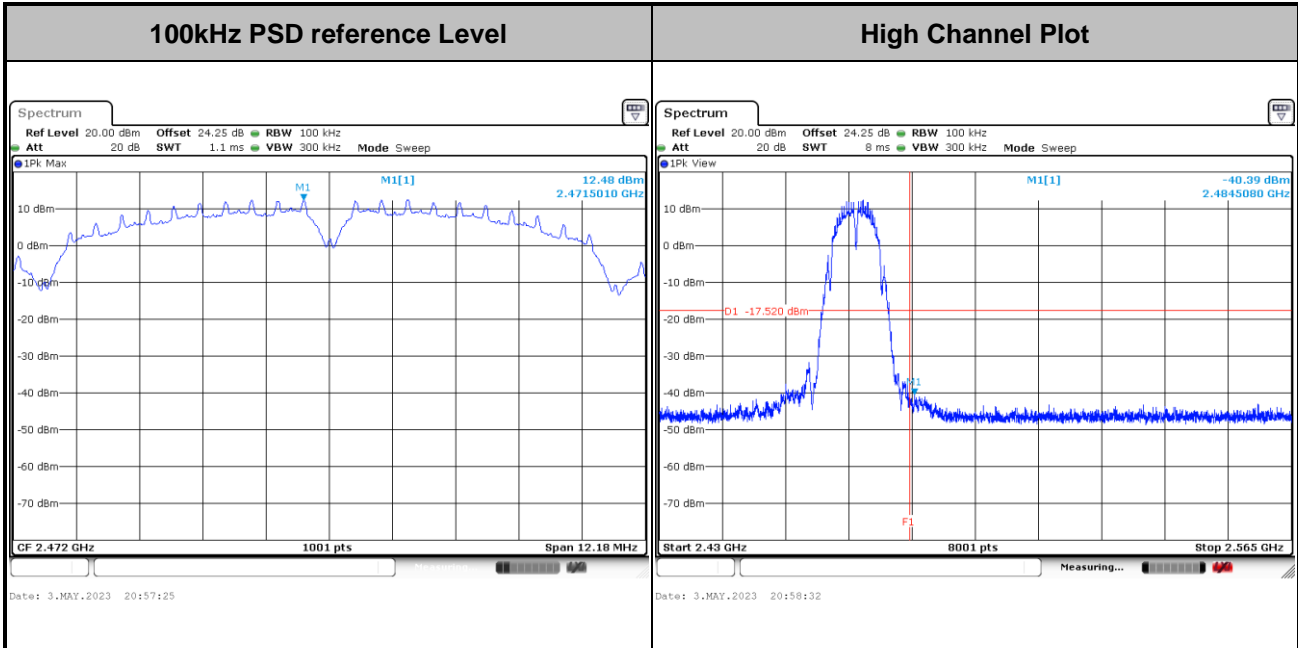



Number of TX = 1, Ant. 4 (Measured)

Test Mode :	802.11b	Test Channel :	01
-------------	---------	----------------	----

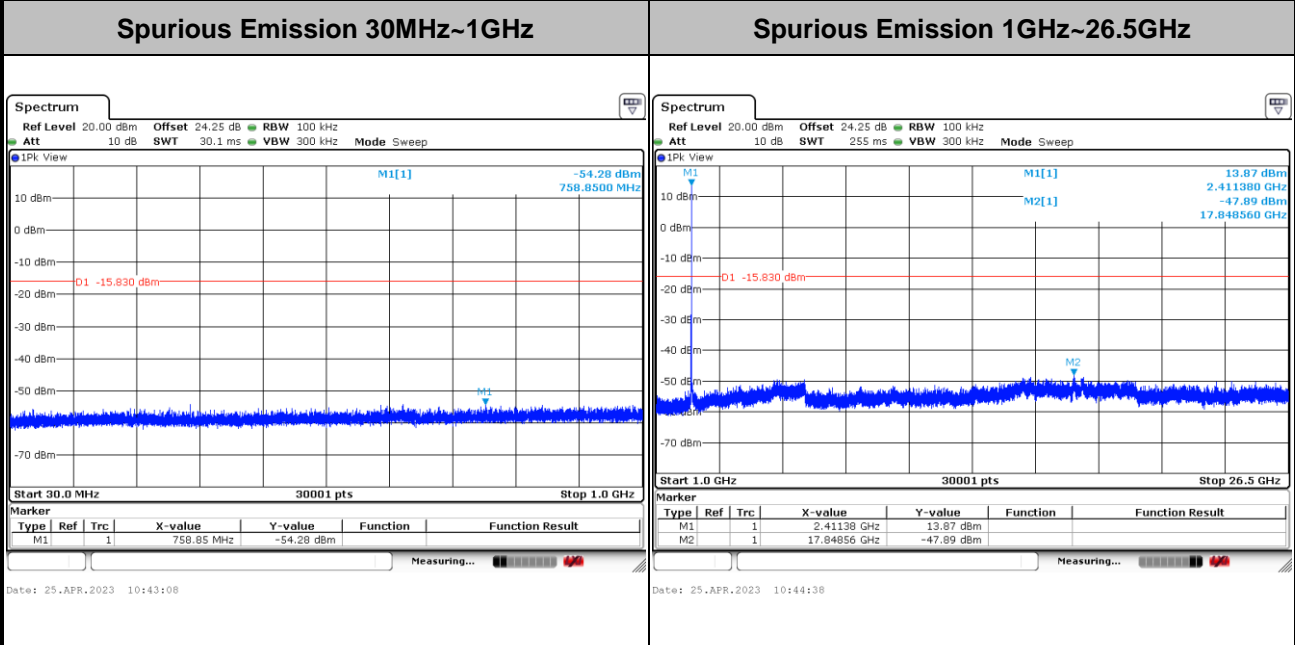
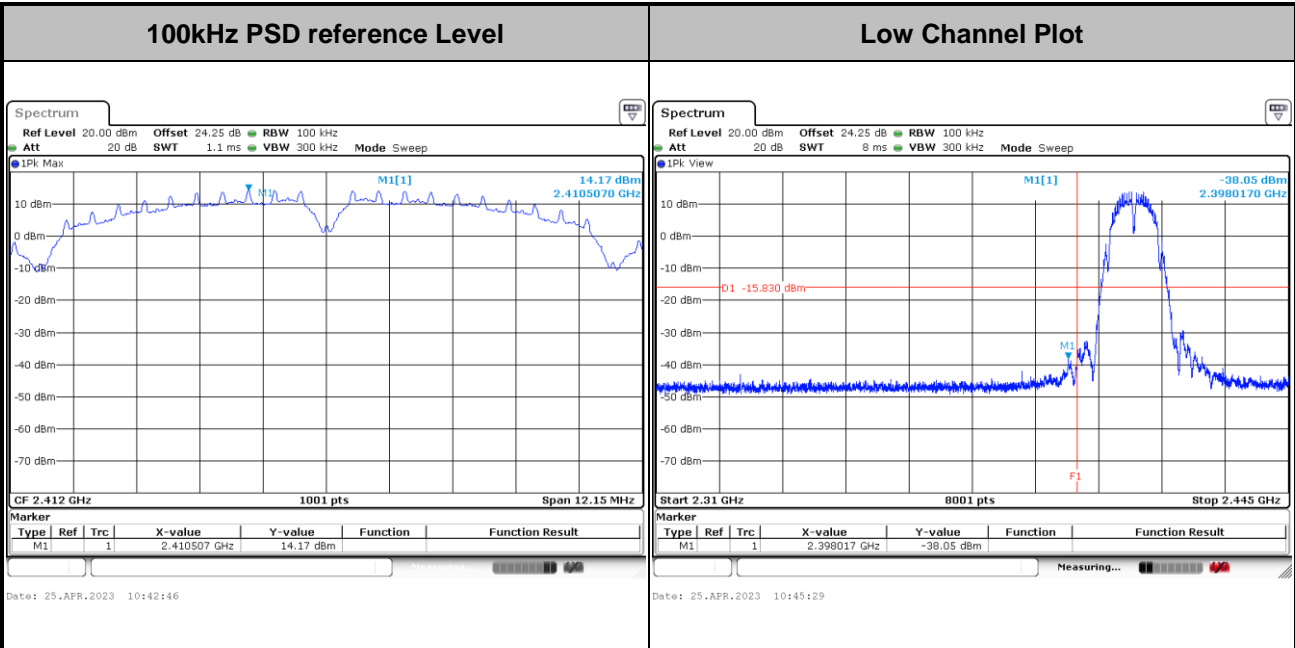



Test Mode :	802.11b	Test Channel :	06
-------------	---------	----------------	----

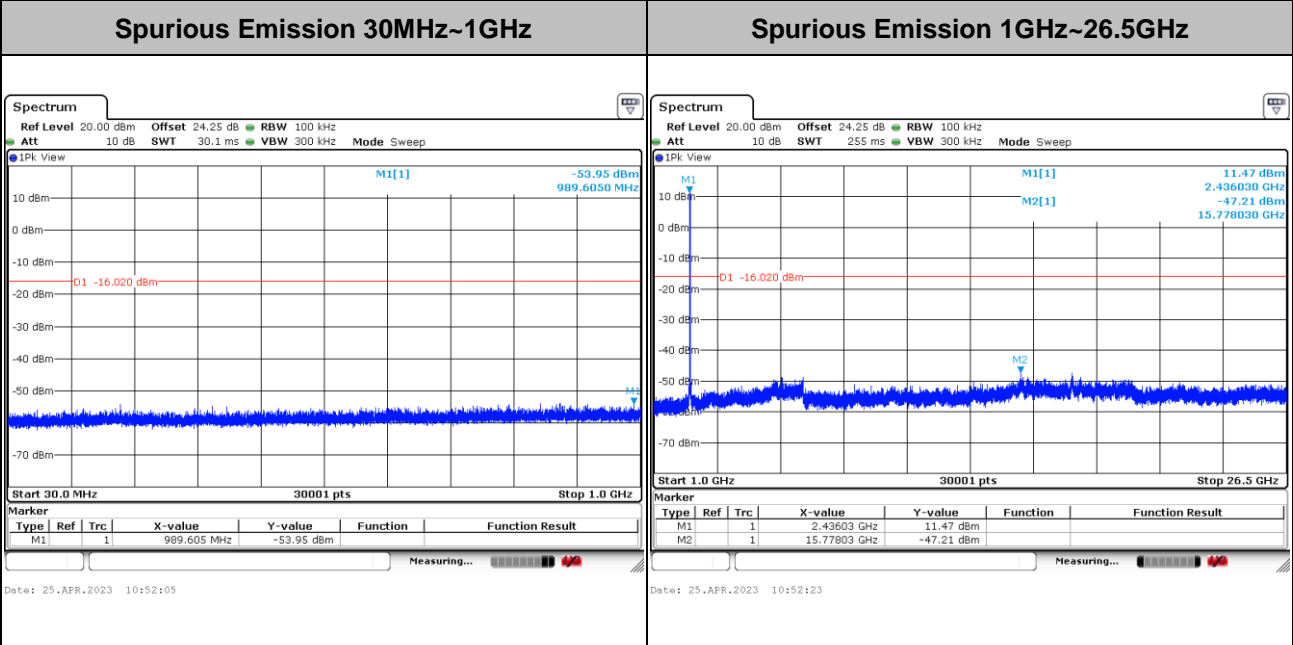
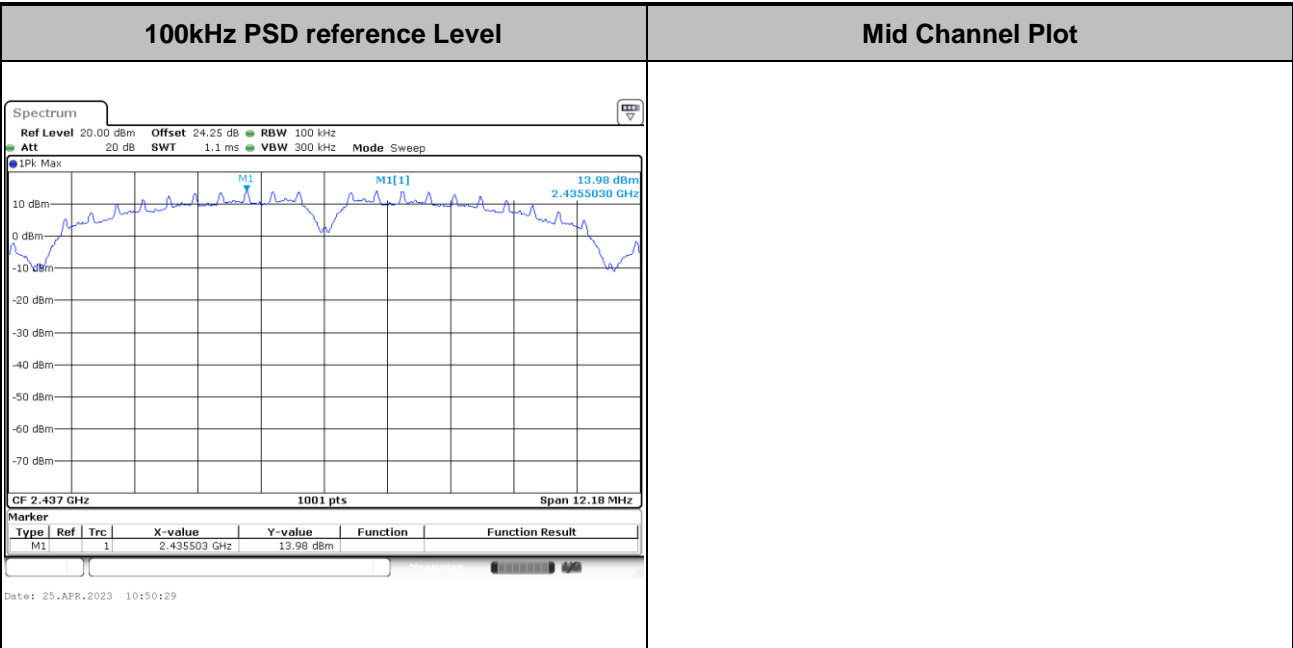



Test Mode :	802.11b	Test Channel :	11
-------------	---------	----------------	----

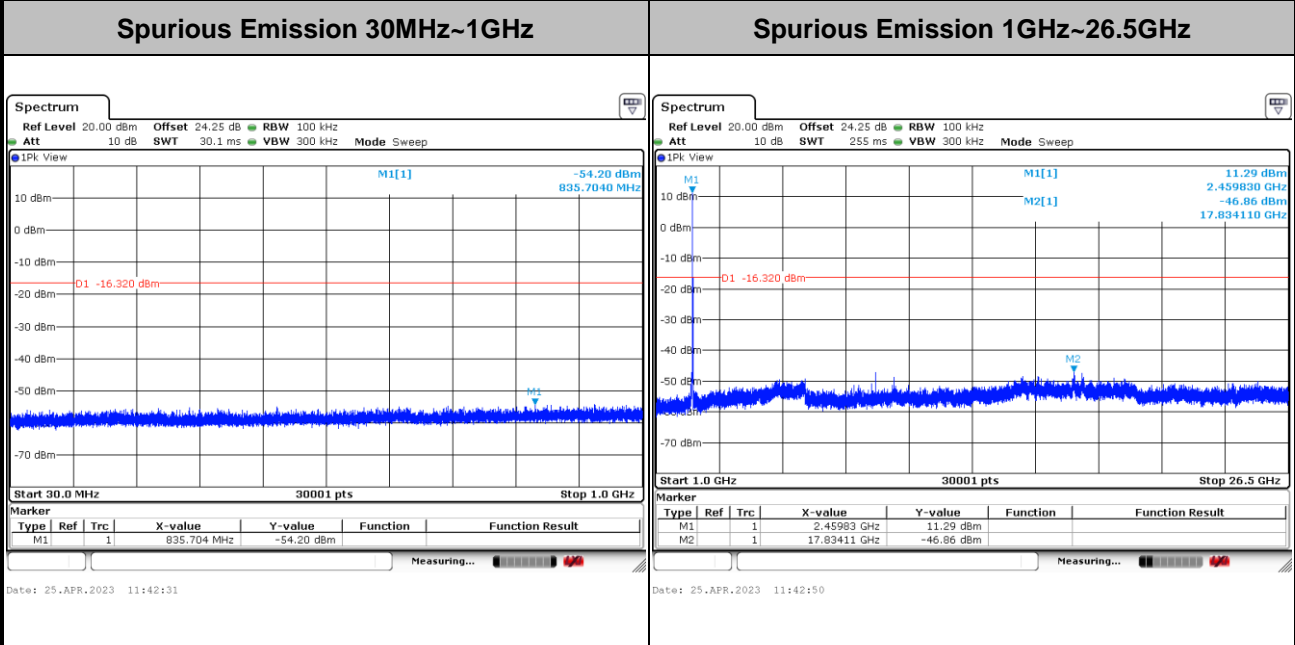
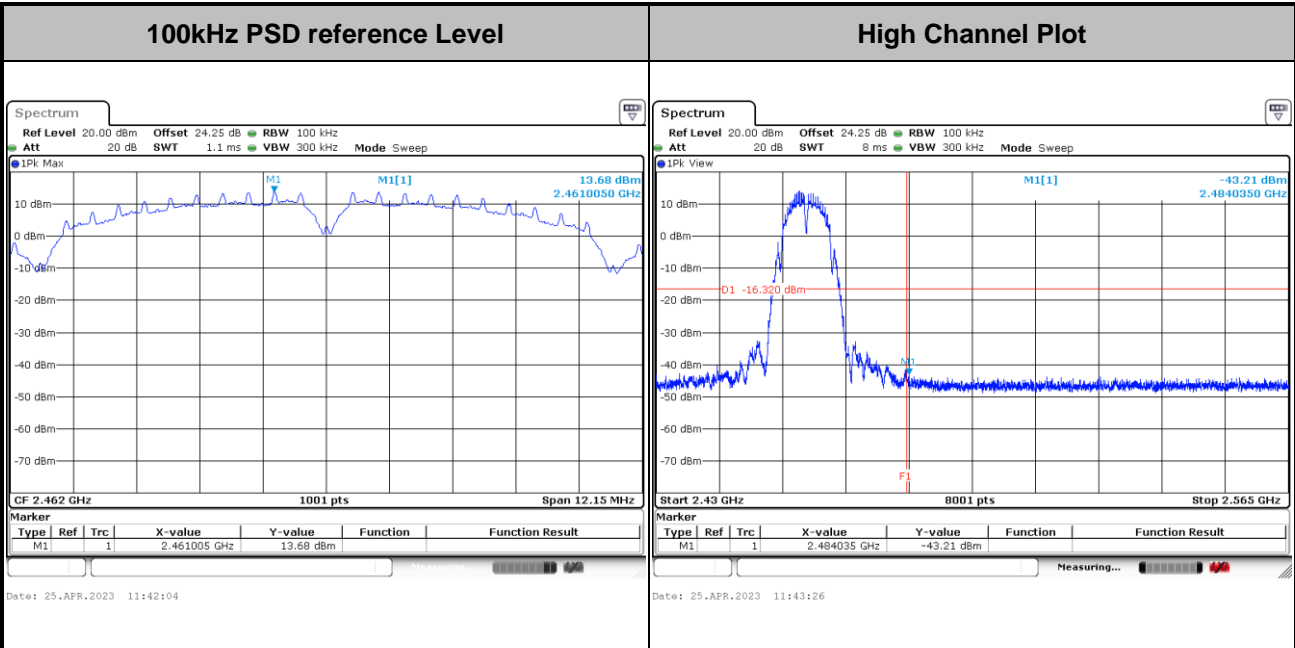



Test Mode :	802.11b	Test Channel :	12
-------------	---------	----------------	----

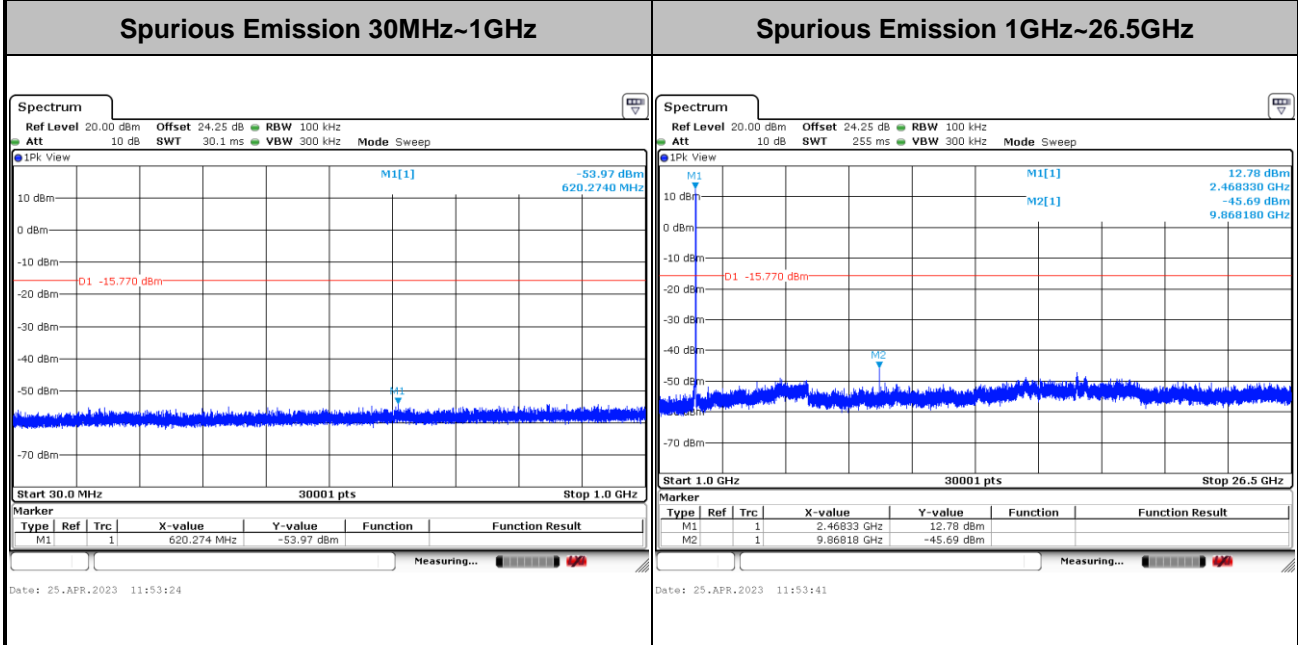
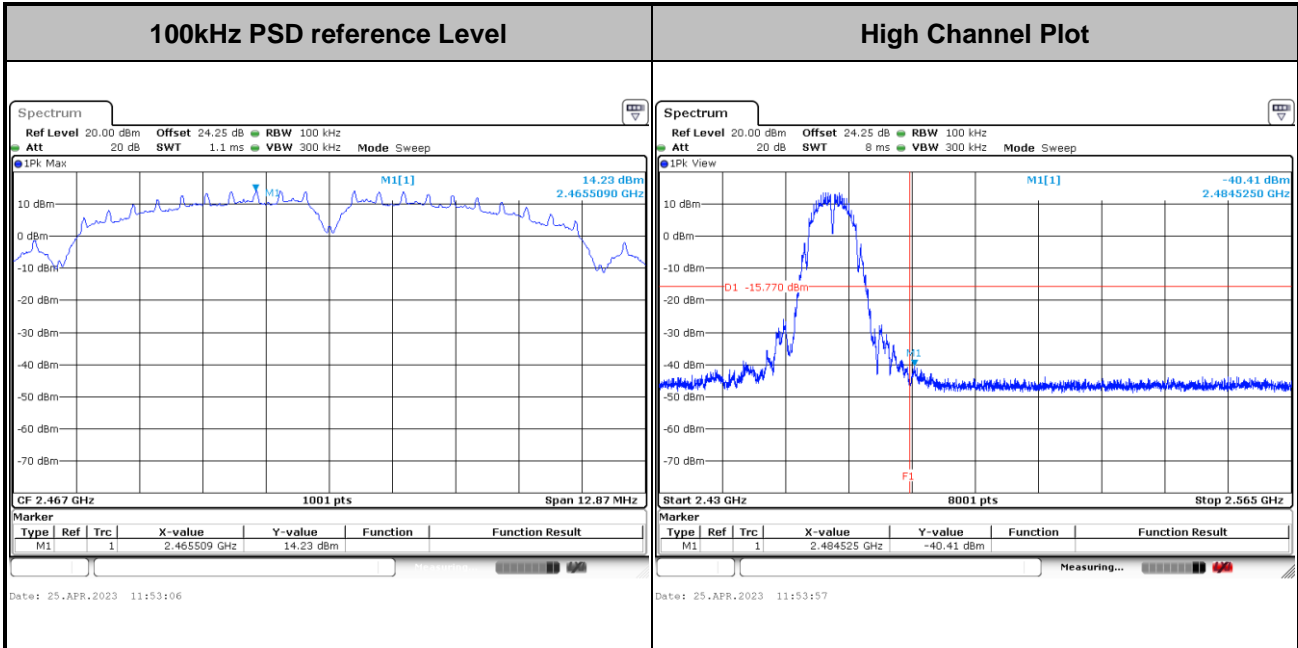



Test Mode :	802.11b	Test Channel :	13
-------------	---------	----------------	----

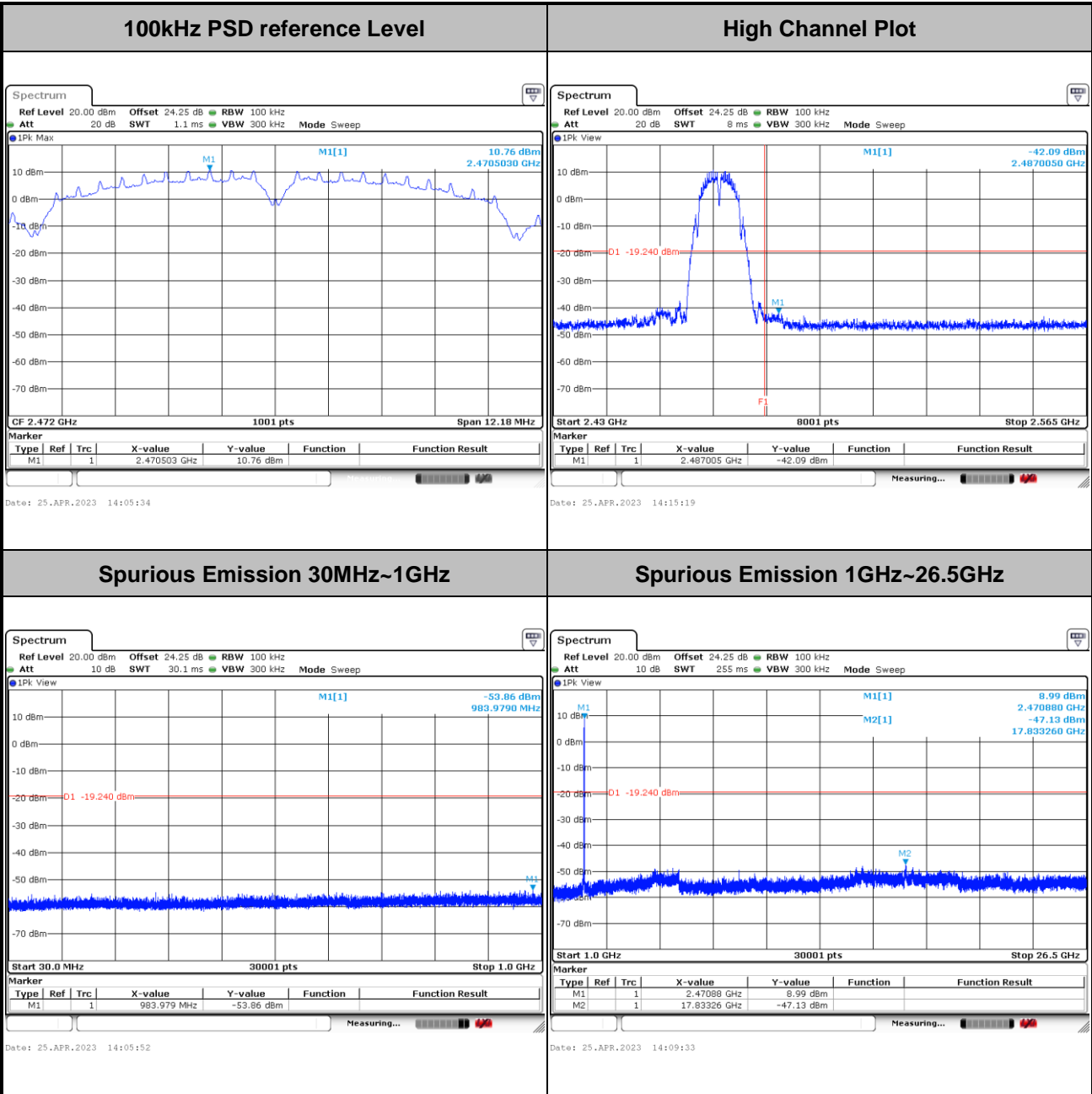





Number of TX = 2, Ant. 3 (Measured)

Test Mode :	802.11g	Test Channel :	01
-------------	---------	----------------	----

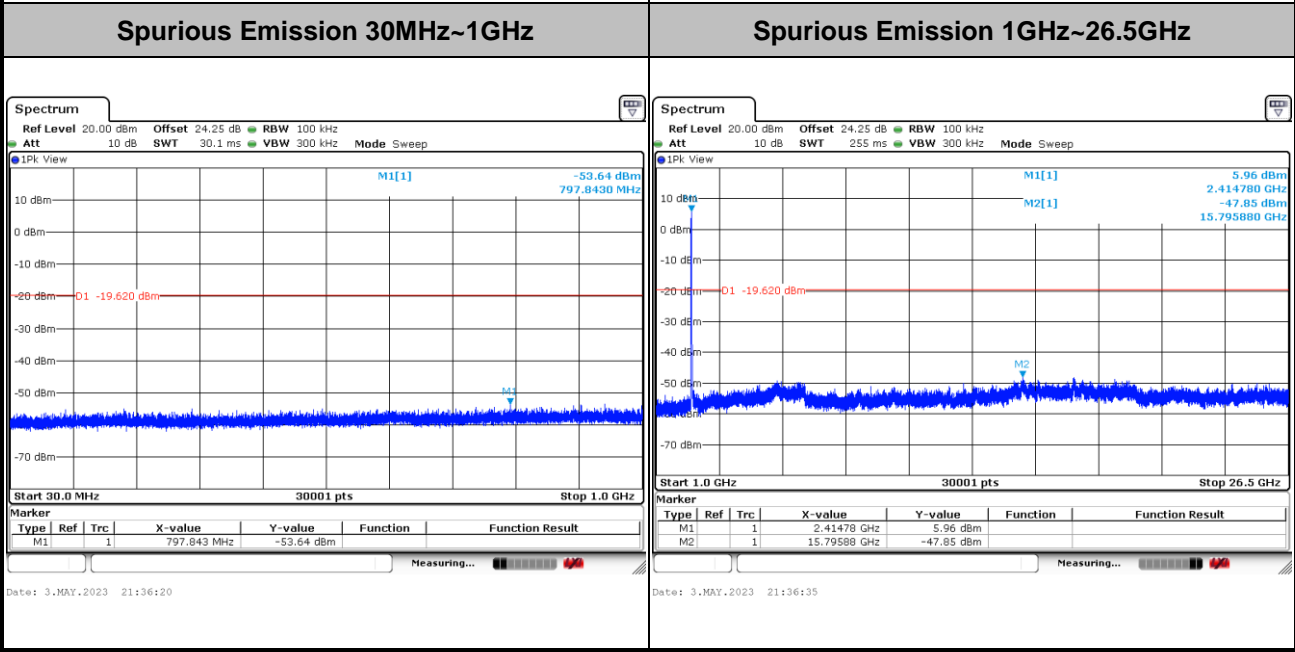
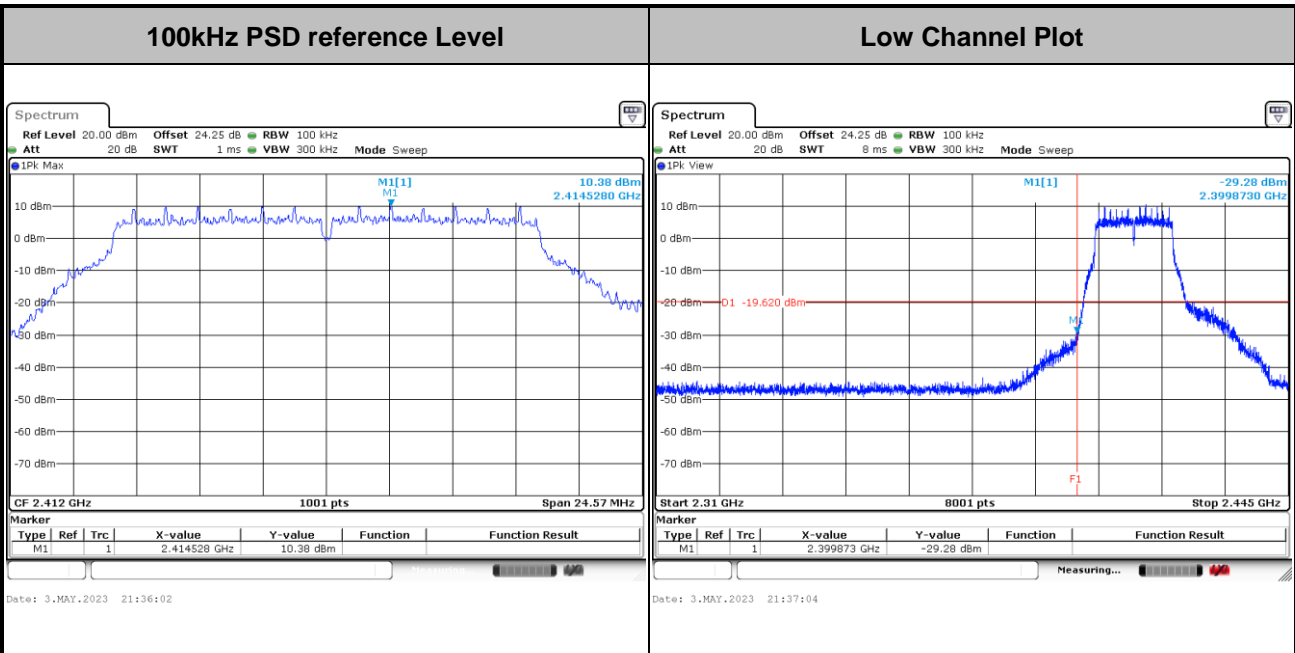



Test Mode :	802.11g	Test Channel :	06
-------------	---------	----------------	----

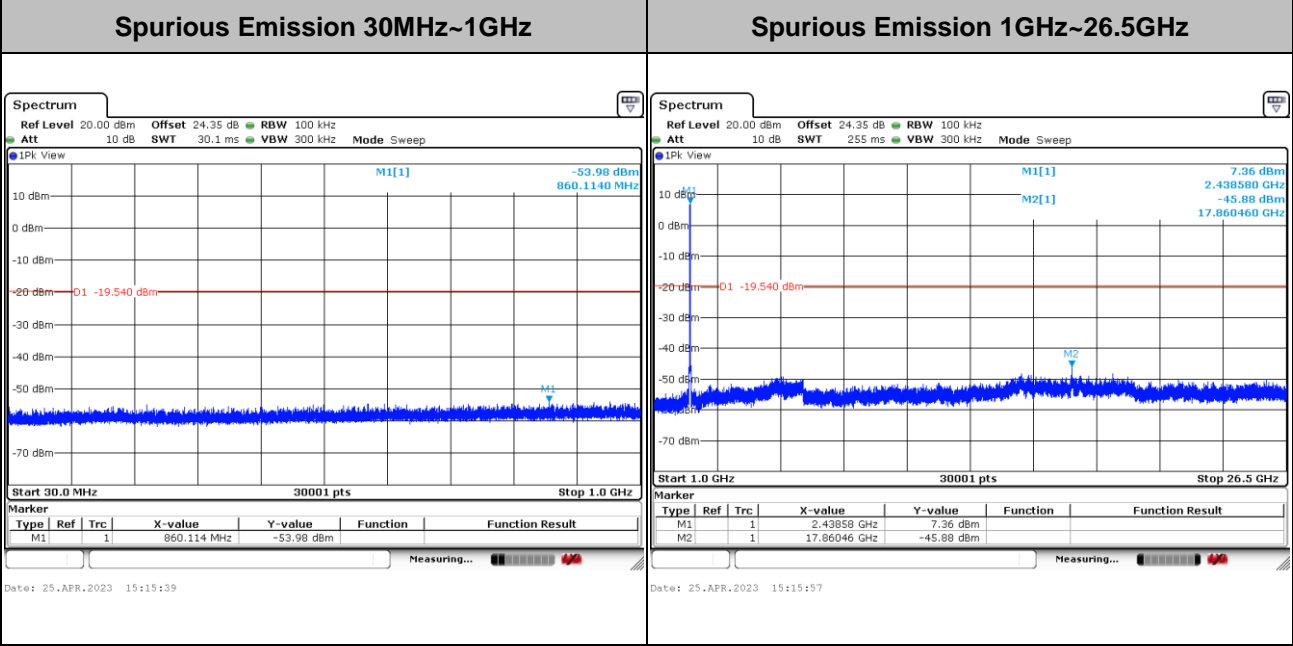
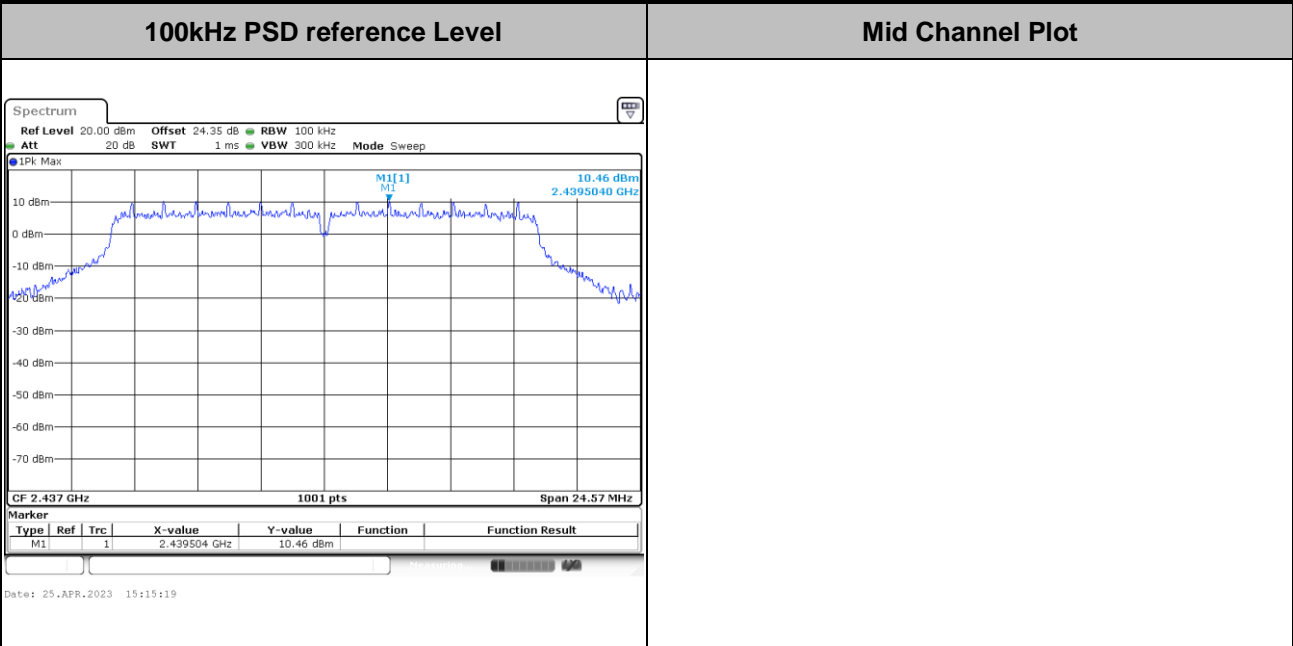



Test Mode :	802.11g	Test Channel :	11
-------------	---------	----------------	----

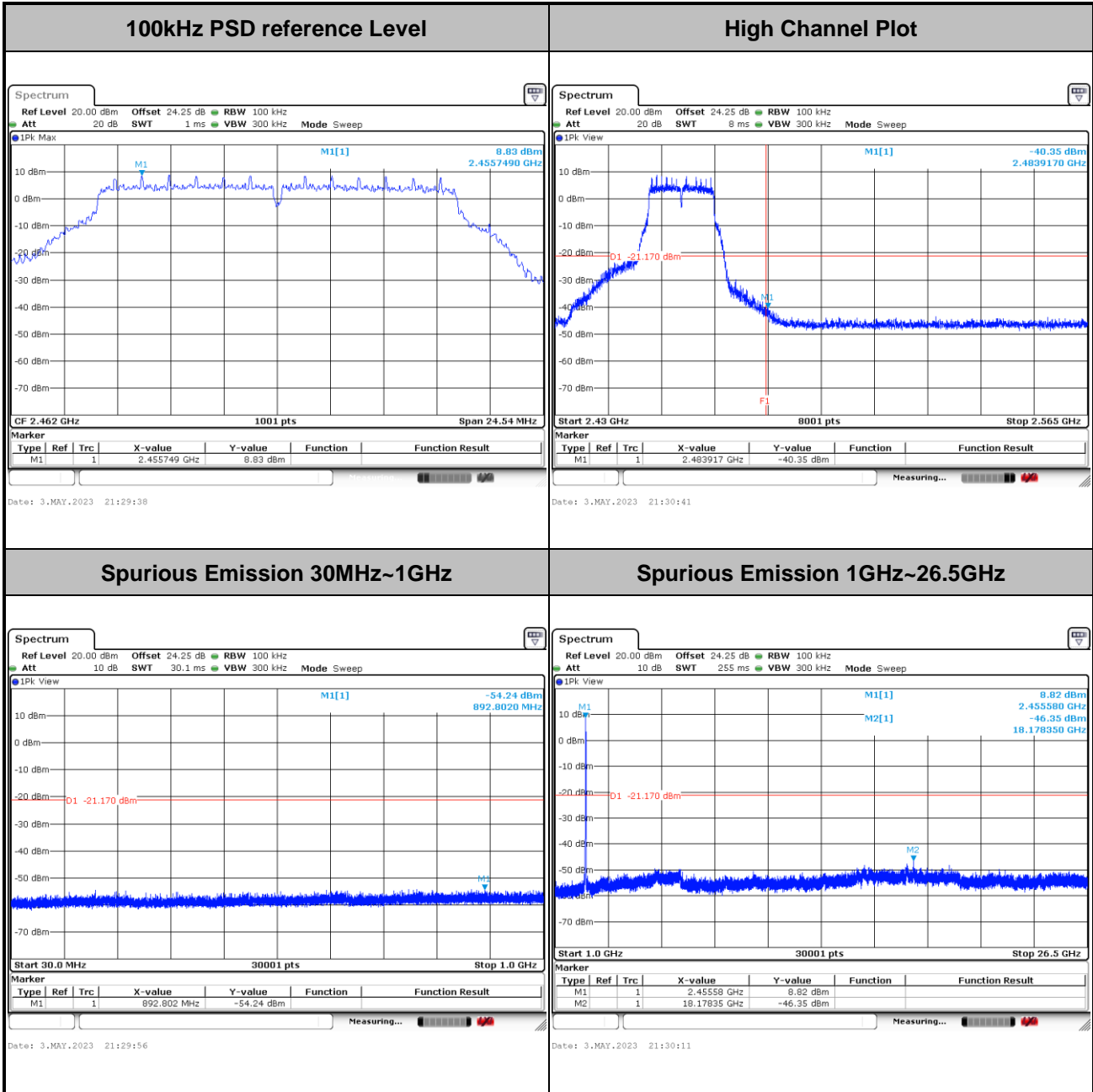



Test Mode :	802.11g	Test Channel :	12
-------------	---------	----------------	----

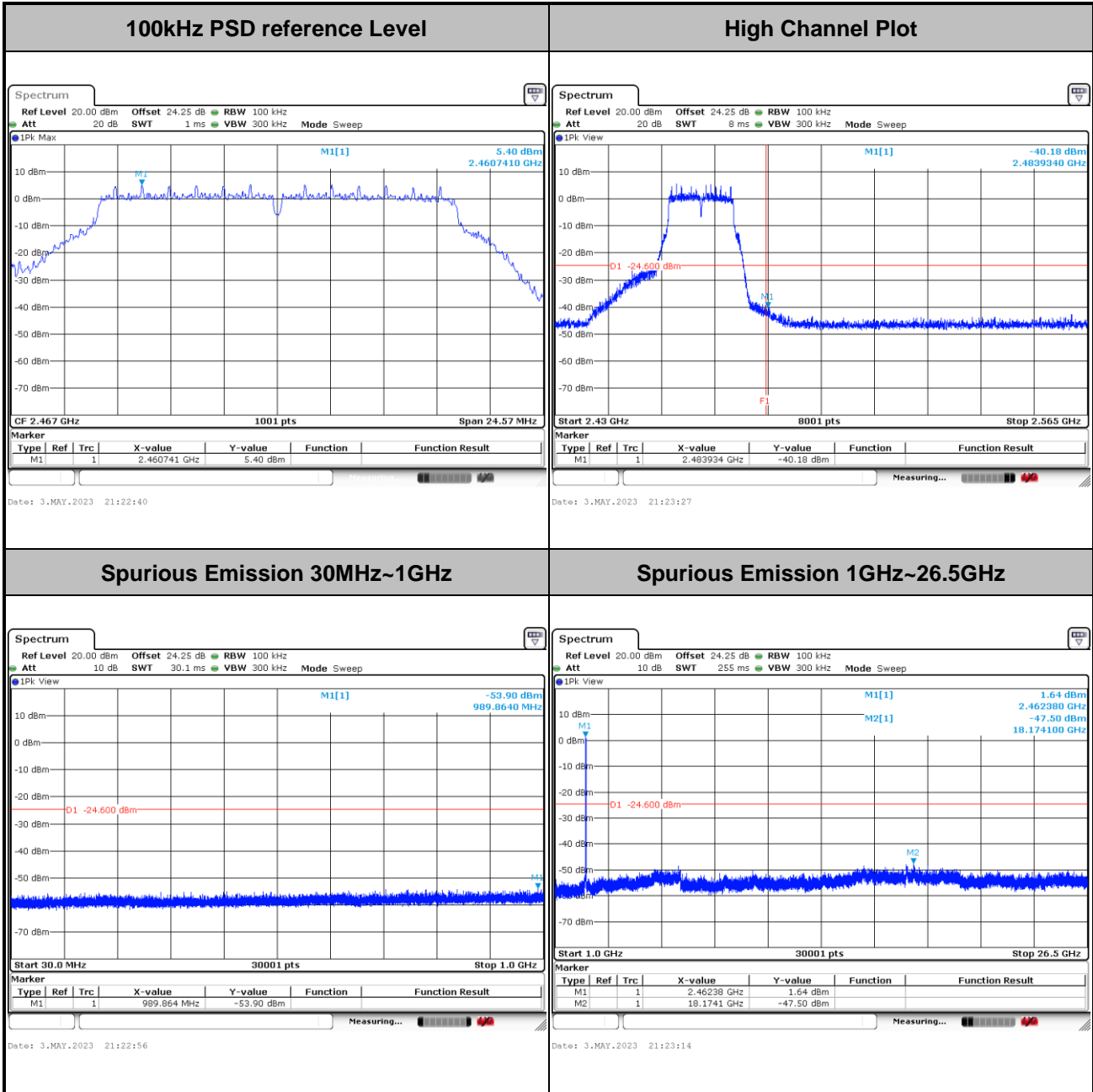



Test Mode :	802.11g	Test Channel :	13
-------------	---------	----------------	----

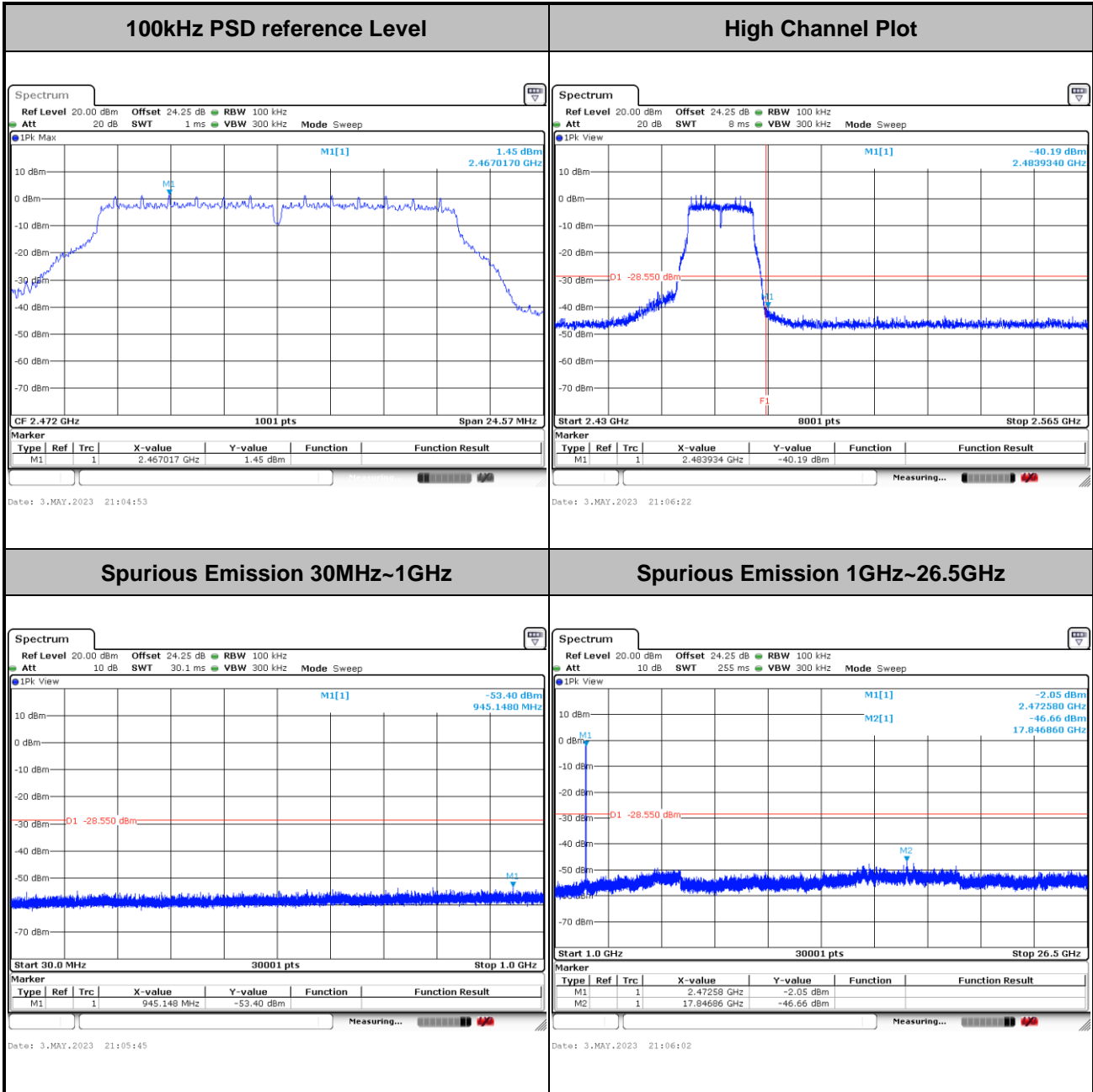



Test Mode :	802.11be EHT20	Test Channel :	01
-------------	----------------	----------------	----

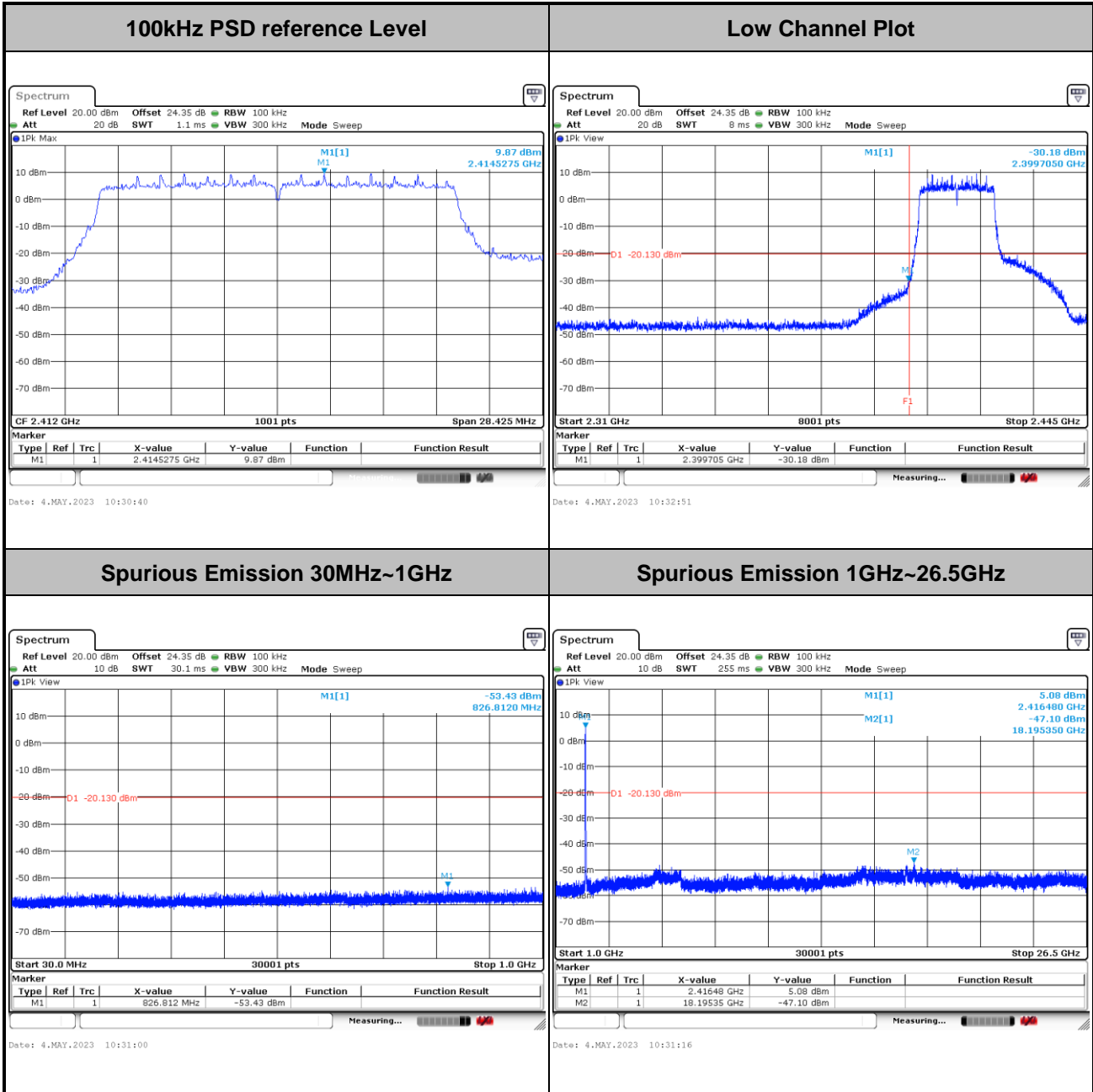



Test Mode :	802.11be EHT20	Test Channel :	06
-------------	----------------	----------------	----

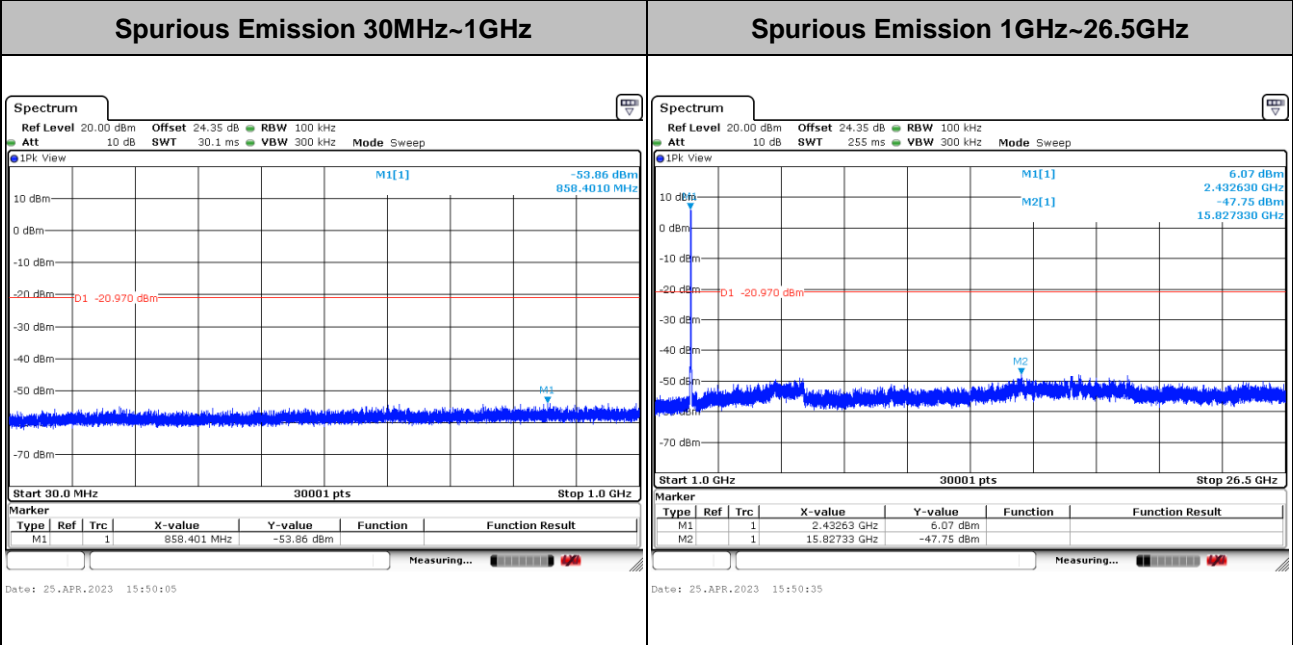
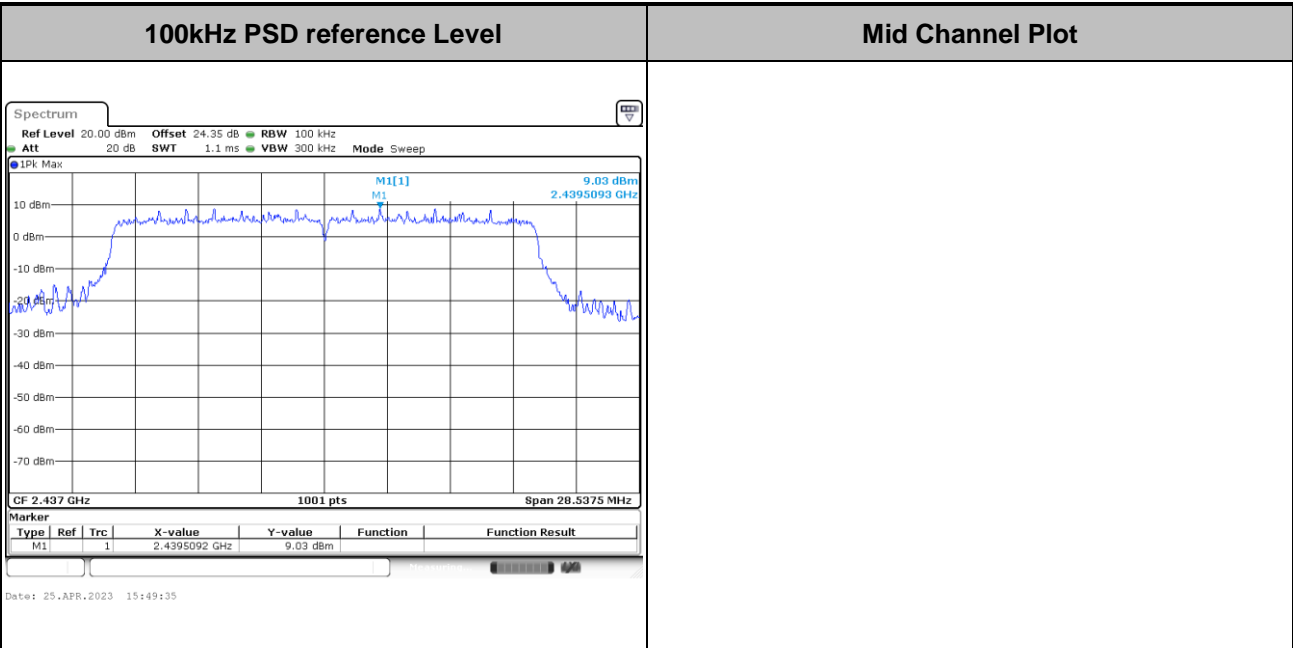



Test Mode :	802.11be EHT20	Test Channel :	11
-------------	----------------	----------------	----

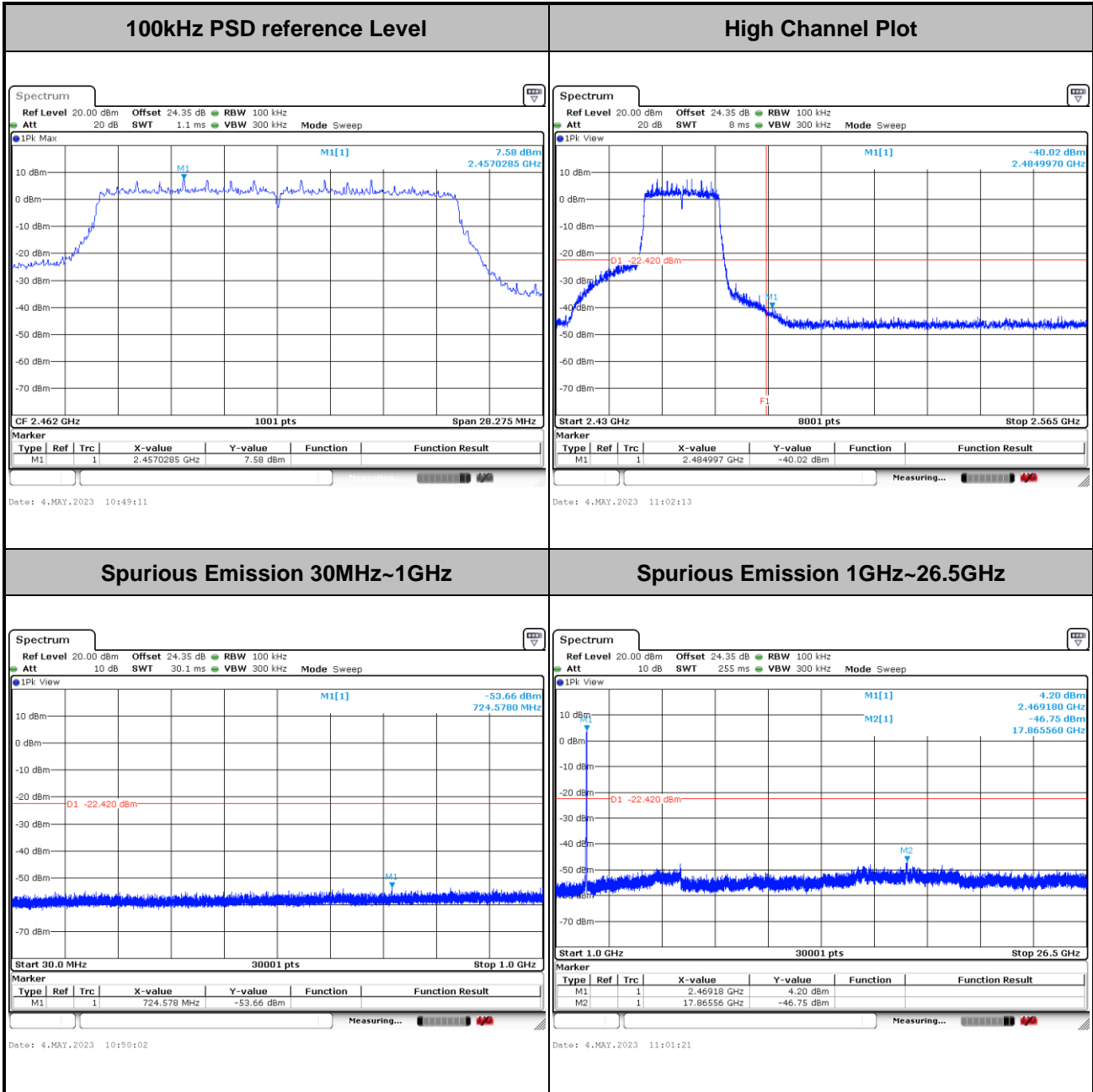





Test Mode :	802.11be EHT20	Test Channel :	12
-------------	----------------	----------------	----

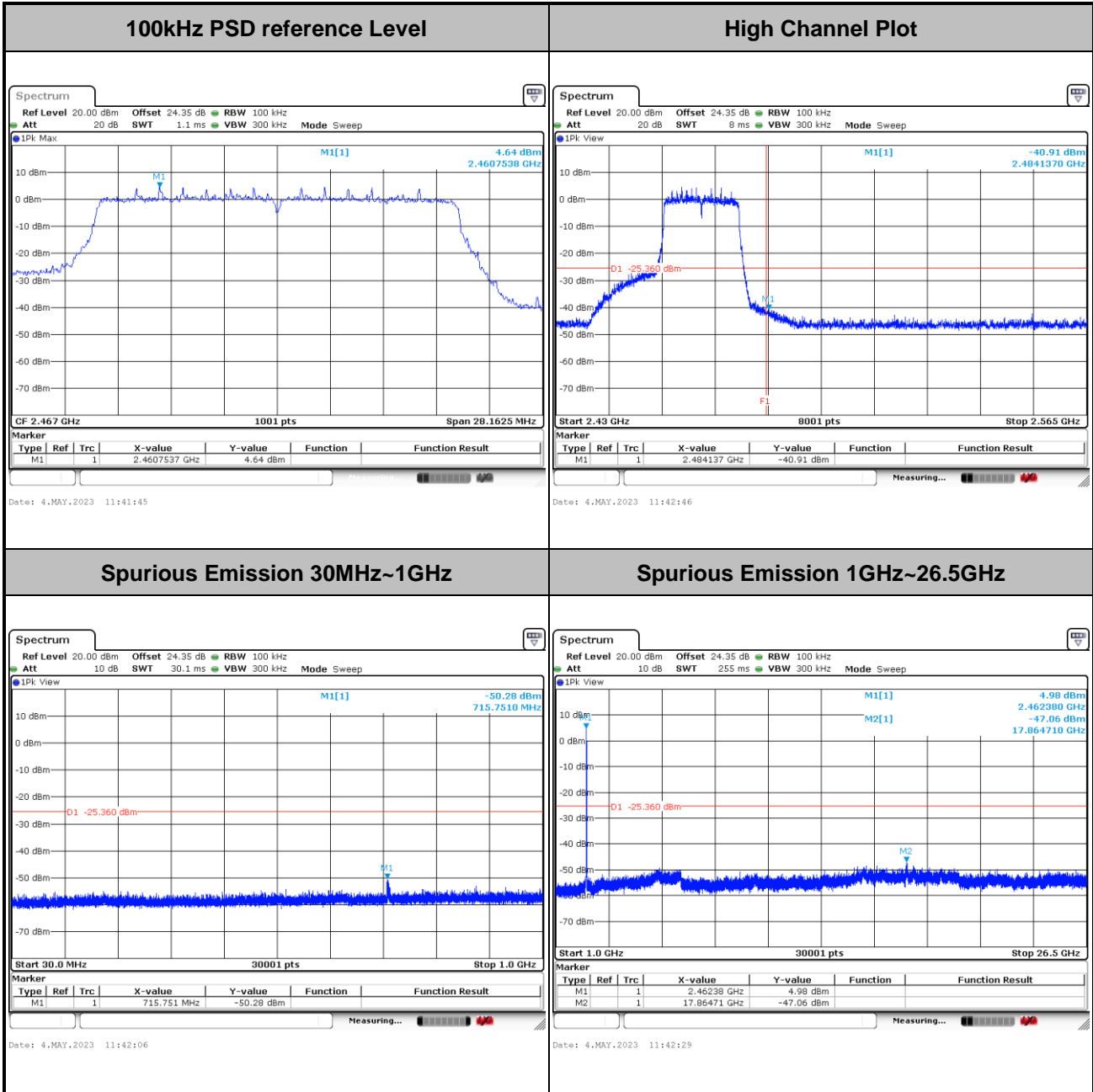



Test Mode :	802.11be EHT20	Test Channel :	13
-------------	----------------	----------------	----

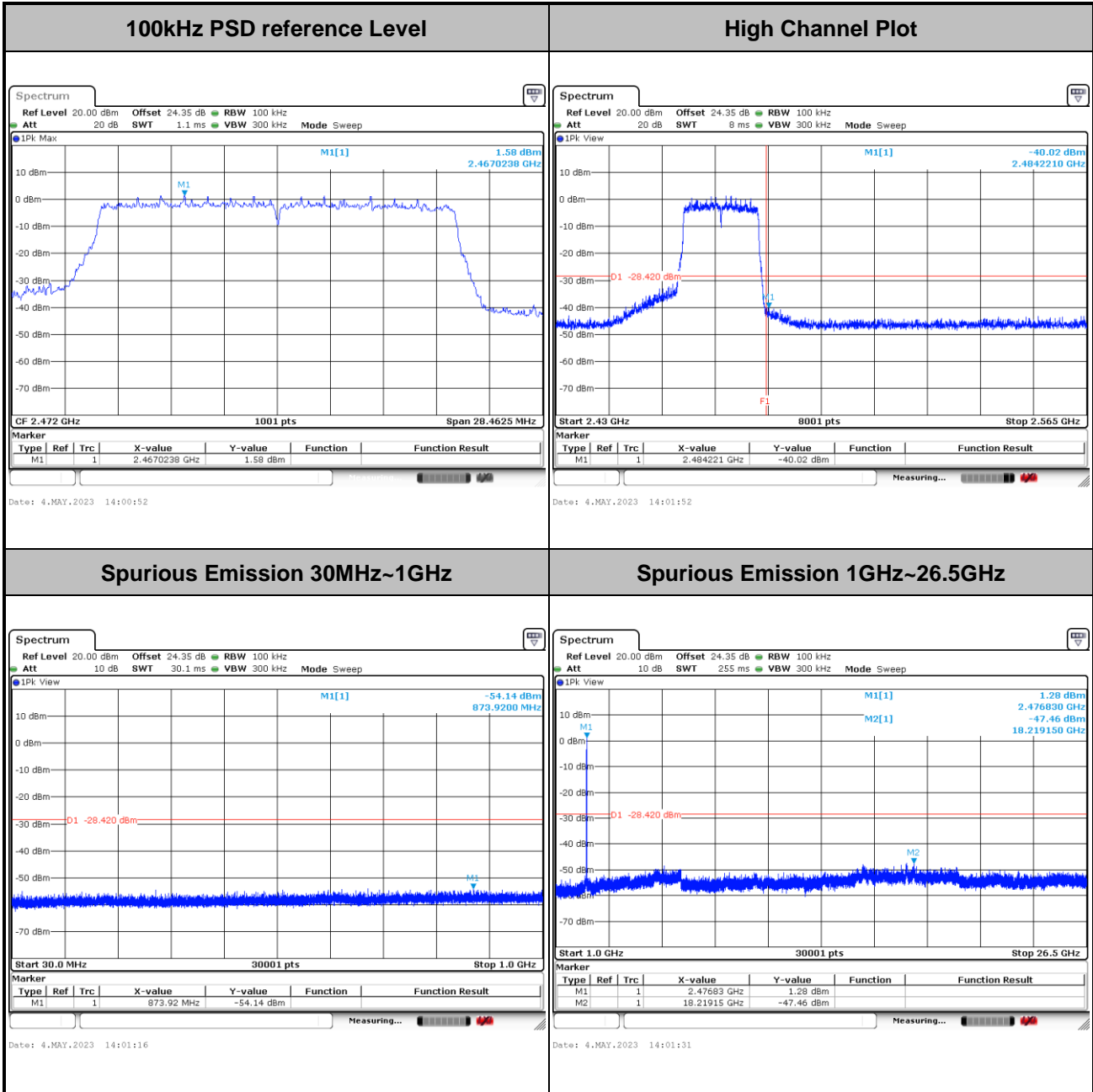



Number of TX = 2, Ant. 4 (Measured)

Test Mode :	802.11g	Test Channel :	01
-------------	---------	----------------	----

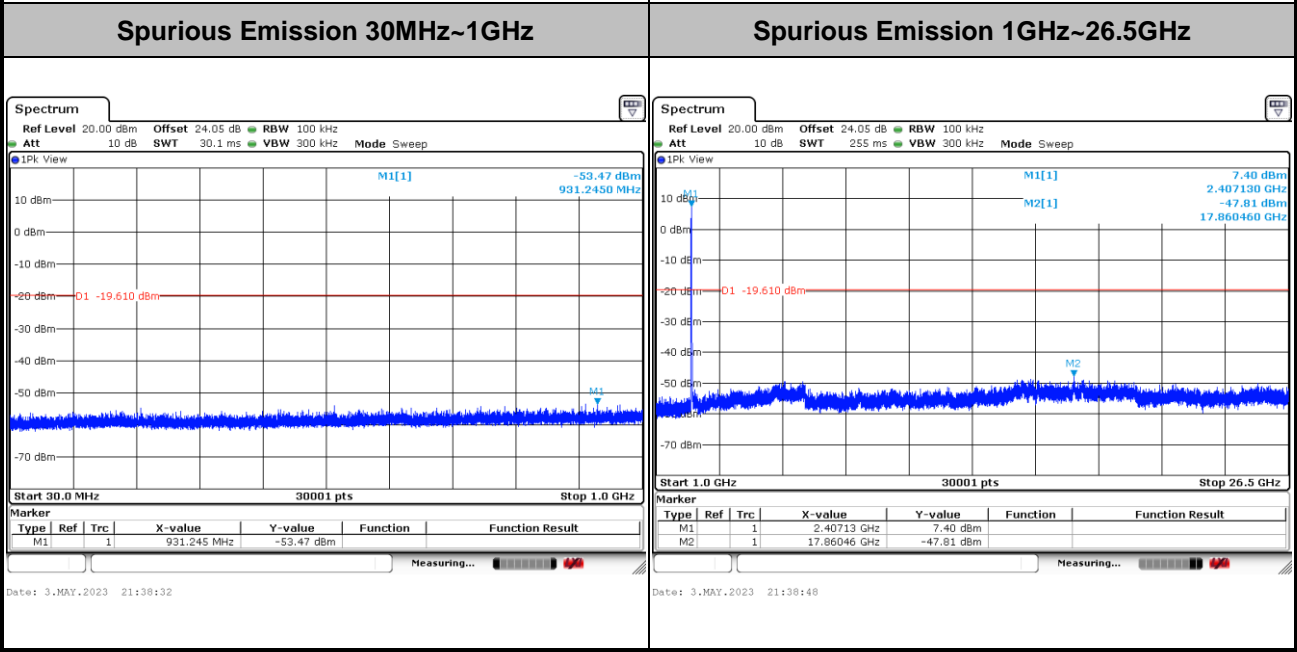
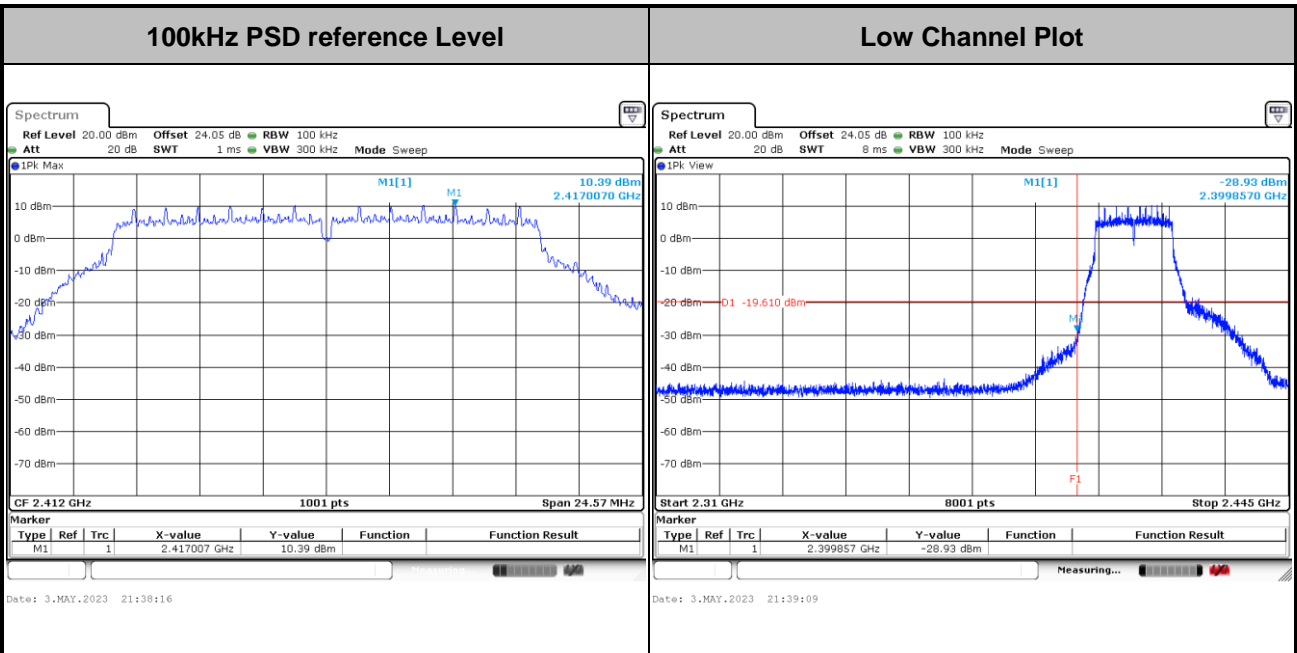



Test Mode :	802.11g	Test Channel :	06
-------------	---------	----------------	----

