



FCC RADIO TEST REPORT

FCC ID : A4RG9BQD
Equipment : Phone
Model Name : G9BQD
Applicant : Google LLC
1600 Amphitheatre Parkway,
Mountain View, California, 94043 USA
Standard : FCC Part 15 Subpart E §15.407

The product was received on Feb. 06, 2023 and testing was performed from Mar. 10, 2023 to Jun. 01, 2023. We, Sporton International Inc. EMC & Wireless Communications Laboratory, would like to declare that the tested sample has been evaluated in accordance with the test procedures and has been in compliance with the applicable technical standards.

The test results in this report apply exclusively to the tested model / sample. Without written approval from Sporton International Inc. EMC & Wireless Communications Laboratory, the test report shall not be reproduced except in full.

Louis Wu

Approved by: Louis Wu

Sporton International Inc. EMC & Wireless Communications Laboratory

No. 52, Huaya 1st Rd., Guishan Dist., Taoyuan City 333, Taiwan (R.O.C.)



Table of Contents

History of this test report3

Summary of Test Result4

1 General Description5

 1.1 Product Feature of Equipment Under Test5

 1.2 Product Specification of Equipment Under Test.....6

 1.3 Modification of EUT 10

 1.4 Testing Location 10

 1.5 Applicable Standards 10

2 Test Configuration of Equipment Under Test 11

 2.1 Carrier Frequency and Channel 11

 2.2 Test Mode 14

 2.3 Connection Diagram of Test System 17

 2.4 Support Unit used in test configuration and system 18

 2.5 EUT Operation Test Setup..... 18

 2.6 Measurement Results Explanation Example 18

3 Test Result..... 19

 3.1 26dB & 99% Occupied Bandwidth Measurement..... 19

 3.2 Fundamental Maximum EIRP Measurement 23

 3.3 Fundamental Power Spectral Density Measurement..... 24

 3.4 In-Band Emissions (Channel Mask)..... 31

 3.5 Contention Based Protocol 121

 3.6 Unwanted Emissions Measurement 144

 3.7 AC Conducted Emission Measurement 148

 3.8 Antenna Requirements 150

4 List of Measuring Equipment 151

5 Measurement Uncertainty 153

Appendix A. Conducted Test Results

Appendix B. AC Conducted Emission Test Result

Appendix C. Radiated Spurious Emission

Appendix D. Radiated Spurious Emission Plots

Appendix E. Duty Cycle Plots

Appendix F. Setup Photographs



Summary of Test Result

Report Clause	Ref Std. Clause	Test Items	Result (PASS/FAIL)	Remark
3.1	15.407(a)(10)	26dB Emission Bandwidth	Pass	-
3.1	2.1049	99% Occupied Bandwidth	Reporting only	-
3.2	15.407(a)(8)	Fundamental Maximum EIRP	Pass	-
3.3	15.407(a)(8)	Fundamental Power Spectral Density	Pass	-
3.4	15.407(b)(6)	In-Band Emissions (Channel Mask)	Pass	-
3.5	15.407(d)(6)	Contention Based Protocol	Pass	-
3.6	15.407(b)	Unwanted Emissions	Pass	10.19 dB under the limit at 5916.20 MHz
3.7	15.207	AC Conducted Emission	Pass	13.54 dB under the limit at 1.53 MHz
3.8	15.203 15.407(a)	Antenna Requirement	Pass	-

Conformity Assessment Condition:

1. The test results (PASS/FAIL) with all measurement uncertainty excluded are presented against the regulation limits or in accordance with the requirements stipulated by the applicant/manufacture who shall bear all the risks of non-compliance that may potentially occur if measurement uncertainty is taken into account.
2. The measurement uncertainty please refer to each test result in the section "Measurement Uncertainty".

Disclaimer:

The product specifications of the EUT presented in the test report that may affect the test assessments are declared by the manufacturer who shall take full responsibility for the authenticity.

Reviewed by: William Chen**Report Producer: Lucy Wu**



1 General Description

1.1 Product Feature of Equipment Under Test

Product Feature	
Equipment	Phone
Model Name	G9BQD
FCC ID	A4RG9BQD
EUT supports Radios application	GSM/EGPRS/WCDMA/HSPA/LTE/5G NR/NFC/GNSS/WPT WLAN 11b/g/n HT20 WLAN 11a/n HT20/HT40 WLAN 11ac VHT20/VHT40/VHT80/VHT160 WLAN 11ax HE20/HE40/HE80/HE160 WLAN 11be EHT20/EHT40/EHT80/EHT160 Bluetooth BR/EDR/LE/HR

Remark: The above EUTs information was declared by manufacturer.

EUT Information List	
S/N	Performed Test Item
31051FDJH0006A	Conducted Measurement
33241FDJH0004A	Radiated Spurious Emission
33201FDJH000KU	Conducted Emission
35091FDJH0003T	Contention Based Protocol



1.2 Product Specification of Equipment Under Test

Product Specification is subject to this standard	
Tx/Rx Frequency Range	5925 MHz ~ 6425 MHz 6425 MHz ~ 6525 MHz 6525 MHz ~ 6875 MHz 6875 MHz ~ 7125 MHz
Maximum Output Power	<p>MIMO <Ant. 3+4></p> <p><5925 MHz ~ 6425 MHz> 802.11a: 10.91 dBm / 0.0123 W 802.11ax HE20: 11.26 dBm / 0.0134 W 802.11ax HE40: 14.52 dBm / 0.0283 W 802.11ax HE80: 17.46 dBm / 0.0557 W 802.11ax HE160: 20.57 dBm / 0.1140 W 802.11be EHT20: 11.36 dBm / 0.0137 W 802.11be EHT40: 14.62 dBm / 0.0290 W 802.11be EHT 80: 17.53 dBm / 0.0566 W 802.11be EHT 160: 20.67 dBm / 0.1167 W</p> <p><6425 MHz ~ 6525 MHz> 802.11a: 11.02 dBm / 0.0126 W 802.11ax HE20: 11.27 dBm / 0.0134 W 802.11ax HE40: 14.66 dBm / 0.0292 W 802.11ax HE80: 17.63 dBm / 0.0579 W 802.11ax HE160: 20.66 dBm / 0.1164 W 802.11be EHT20: 11.37 dBm / 0.0137 W 802.11be EHT40: 14.76 dBm / 0.0299 W 802.11be EHT80: 17.73 dBm / 0.0593 W 802.11be EHT160: 20.76 dBm / 0.1191 W</p> <p><6525 MHz ~ 6875 MHz> 802.11a: 12.76 dBm / 0.0189 W 802.11ax HE20: 10.86 dBm / 0.0122 W 802.11ax HE40: 14.05 dBm / 0.0254 W 802.11ax HE80: 17.33 dBm / 0.0541 W 802.11ax HE160: 20.30 dBm / 0.1072 W 802.11be EHT20: 10.96 dBm / 0.0125 W 802.11be EHT40: 14.15 dBm / 0.0260 W 802.11be EHT80: 17.39 dBm / 0.0548 W 802.11be EHT160: 20.40 dBm / 0.1096 W</p> <p><6875 MHz ~ 7125 MHz> 802.11a: 12.17 dBm / 0.0165 W 802.11ax HE20: 12.03 dBm / 0.0160 W 802.11ax HE40: 14.41 dBm / 0.0286 W 802.11ax HE80: 17.25 dBm / 0.0531 W 802.11ax HE160: 19.95 dBm / 0.0989 W 802.11be EHT20: 12.13 dBm / 0.0163 W 802.11be EHT40: 14.67 dBm / 0.0293 W 802.11be EHT80: 17.35 dBm / 0.0543 W 802.11be EHT160: 20.05 dBm / 0.1012 W</p>



Product Specification is subject to this standard	
99% Occupied Bandwidth	<p>MIMO <Ant. 3> 802.11a: 17.48 MHz 802.11be EHT20: 19.28 MHz 802.11be EHT40: 37.96 MHz 802.11be EHT80: 77.44 MHz 802.11be EHT160: 157.76 MHz</p> <p>MIMO <Ant. 4> 802.11a: 17.18 MHz 802.11be EHT20: 19.23 MHz 802.11be EHT40: 37.96 MHz 802.11be EHT80: 77.32 MHz 802.11be EHT160: 157.76 MHz</p>
Antenna Type	<p><5925 MHz ~ 6425 MHz> <Ant. 3>: Loop Antenna <Ant. 4>: Monopole Antenna</p> <p><6425 MHz ~ 6525 MHz> <Ant. 3>: Loop Antenna <Ant. 4>: Monopole Antenna</p> <p><6525 MHz ~ 6875 MHz> <Ant. 3>: Loop Antenna <Ant. 4>: Monopole Antenna</p> <p><6875 MHz ~ 7125 MHz> <Ant. 3>: Loop Antenna <Ant. 4>: Monopole Antenna</p>
Antenna Gain	<p><5925 MHz ~ 6425 MHz> <Ant. 3>: -3.4 dBi <Ant. 4>: -3.7 dBi</p> <p><6425 MHz ~ 6525 MHz> <Ant. 3>: -3.0 dBi <Ant. 4>: -4.9 dBi</p> <p><6525 MHz ~ 6875 MHz> <Ant. 3>: -4.1 dBi <Ant. 4>: -2.2 dBi</p> <p><6875 MHz ~ 7125 MHz> <Ant. 3>: -2.4 dBi <Ant. 4>: -4.7 dBi</p>



Product Specification is subject to this standard			
Type of Modulation	802.11a : OFDM (BPSK/QPSK/16QAM/64QAM)		
	802.11ax : OFDMA (BPSK/QPSK/16QAM/64QAM/256QAM/1024QAM)		
Antenna Function Description	802.11be : OFDMA (BPSK/QPSK/16QAM/64QAM/256QAM/1024QAM/ 4096QAM)		
		Ant. 3	Ant. 4
	802.11a/ax/be MIMO	V	V

Remark:

1. MIMO Ant. 3+4 Directional Gain is a calculated result from MIMO Ant. 3 and MIMO Ant. 4. The formula used in calculation is documented in section 1.2.1.
2. Power of MIMO Ant. 3 + Ant. 4 is a calculated result from sum of the power MIMO Ant. 3 and MIMO Ant. 4.
3. The EUT's information above is declared by manufacturer. Please refer to Disclaimer in report summary.
4. The CBP antenna gain is considering the minimum gain from closed mode as worse case.

1.2.1 Antenna Directional Gain

Follows FCC KDB 662911 D01 Multiple Transmitter Output v02r01 F)2)f)ii)

Directional gain = G_{ANT} + Array Gain, where Array Gain is as follows:

For power measurements on IEEE 802.11 devices,

Array Gain = 0 dB (i.e., no array gain) for $N_{ANT} \leq 4$.

G_{ANT} is set equal to the gain of the antenna having the highest gain.

For PSD measurements, the directional gain calculation.

$$DirectionalGain = 10 \cdot \log \left[\frac{\sum_{j=1}^{N_{SS}} \left\{ \sum_{k=1}^{N_{ANT}} g_{j,k} \right\}^2}{N_{ANT}} \right]$$

where

Each antenna is driven by no more than one spatial stream;

N_{SS} = the number of independent spatial streams of data;

N_{ANT} = the total number of antennas

$g_{j,k} = 10^{G_k / 20}$ if the k th antenna is being fed by spatial stream j , or zero if it is not;
 G_k is the gain in dBi of the k th antenna.

As minimum $N_{SS}=1$ is supported by EUT, the formula can be simplified as:

$$Directional\ gain = 10 \cdot \log \left[\frac{10^{G_1 / 20} + 10^{G_2 / 20} + \dots + 10^{G_N / 20}}{N_{ANT}} \right] \text{ dBi}$$

Where G_1, G_2, \dots, G_N denote single antenna gain.

The directional gain "DG" is calculated as following table.

	Ant 3	Ant 4	DG for Power	DG for PSD
	(dBi)	(dBi)	(dBi)	(dBi)
5925 MHz ~ 6425 MHz	-3.40	-3.70	-3.40	-0.54
6425 MHz ~ 6525 MHz	-3.00	-4.90	-3.00	-0.89
6525 MHz ~ 6875 MHz	-4.10	-2.20	-2.20	-0.09
6875 MHz ~ 7125 MHz	-2.40	-4.70	-2.40	-0.46

Calculation example:

If a device has two antenna, $G_{ANT1} = -3.4\text{dBi}$; $G_{ANT2} = -3.7\text{dBi}$

Directional gain of power measurement = $\max(-3.4, -3.7) + 0 = -3.4 \text{ dBi}$

Directional gain of PSD derived from formula which is

$$10 \times \log \left\{ \left[10^{(-3.4 \text{ dBi} / 20)} + 10^{(-3.7 \text{ dBi} / 20)} \right]^2 / 2 \right\}$$

$$= -0.54 \text{ dBi}$$



1.3 Modification of EUT

No modifications made to the EUT during the testing.

1.4 Testing Location

Test Site	Sporton International Inc. EMC & Wireless Communications Laboratory
Test Site Location	No.52, Huaya 1st Rd., Guishan Dist., Taoyuan City 333, Taiwan (R.O.C.) TEL: +886-3-327-3456 FAX: +886-3-328-4978
Test Site No.	Sporton Site No. CO05-HY, DF02-HY

Note: The test site complies with ANSI C63.4 2014 requirement.

Test Site	Sporton International Inc. Wensan Laboratory
Test Site Location	No.58, Aly. 75, Ln. 564, Wenhua 3rd, Rd., Guishan Dist., Taoyuan City 333010, Taiwan (R.O.C.) TEL: +886-3-327-0868 FAX: +886-3-327-0855
Test Site No.	Sporton Site No. TH05-HY, 03CH16-HY (TAF Code: 3786)
Remark	The Conducted and Radiated Spurious Emission test items are subcontracted to Sporton International Inc. Wensan Laboratory.

Note: The test site complies with ANSI C63.4 2014 requirement.

FCC designation No.: TW1190 and TW3786

1.5 Applicable Standards

According to the specifications declared by the manufacturer, the EUT must comply with the requirements of the following standards:

- ♦ FCC Part 15 Subpart E
- ♦ FCC KDB 789033 D02 General UNII Test Procedures New Rules v02r01.
- ♦ FCC KDB 987594 D02 U-NII 6 GHz EMC Measurement v01r01
- ♦ FCC KDB 414788 D01 Radiated Test Site v01r01.
- ♦ FCC KDB 662911 D01 Multiple Transmitter Output v02r01.
- ♦ ANSI C63.10-2013

Remark:

1. All the test items were validated and recorded in accordance with the standards without any modification during the testing.
2. The TAF code is not including all the FCC KDB listed without accreditation.



2 Test Configuration of Equipment Under Test

- a. The EUT has been associated with peripherals and configuration operated in a manner tended to maximize its emission characteristics in a typical application. Frequency range investigated: conduction emission (150 kHz to 30 MHz), radiation emission (9 kHz to the 10th harmonic of the highest fundamental frequency or to 40 GHz, whichever is lower). For radiated measurement, , the measured emission level of the EUT was maximized by rotating the EUT on a turntable, adjusting the orientation of the EUT antenna in three orthogonal axis (X: flat, Y: portrait, Z: landscape) and accessory (Adapter or Earphone), and adjusting the measurement antenna orientation, following C63.10 exploratory test procedures and only the worst case emissions were reported in this report.
- b. AC power line Conducted Emission was tested under maximum output power.

2.1 Carrier Frequency and Channel

BW 20M	Channel	1	5	9	13	17	21	25	29
	Freq. (MHz)	5955	5975	5995	6015	6035	6055	6075	6095
BW 40M	Channel	3		11		19		27	
	Freq. (MHz)	5965		6005		6045		6085	
BW 80M	Channel	7				23			
	Freq. (MHz)	5985				6065			
BW 160M	Channel	15							
	Freq. (MHz)	6025							

BW 20M	Channel	33	37	41	45	49	53	57	61
	Freq. (MHz)	6115	6135	6155	6175	6195	6215	6235	6255
BW 40M	Channel	35		43		51		59	
	Freq. (MHz)	6125		6165		6205		6245	
BW 80M	Channel	39				55			
	Freq. (MHz)	6145				6225			
BW 160M	Channel	47							
	Freq. (MHz)	6185							



BW 20M	Channel	65	69	73	77	81	85	89	93
	Freq. (MHz)	6275	6295	6315	6335	6355	6375	6395	6415
BW 40M	Channel	67		75		83		91	
	Freq. (MHz)	6285		6325		6365		6405	
BW 80M	Channel	71				87			
	Freq. (MHz)	6305				6385			
BW 160M	Channel	79							
	Freq. (MHz)	6345							

BW 20M	Channel	97	101	105	109	113	117	121	125
	Freq. (MHz)	6435	6455	6475	6495	6515	6535	6555	6575
BW 40M	Channel	99		107		115		123	
	Freq. (MHz)	6445		6485		6525		6565	
BW 80M	Channel	103				119			
	Freq. (MHz)	6465				6545			
BW 160M	Channel	111							
	Freq. (MHz)	6505							

BW 20M	Channel	129	133	137	141	145	149	153	157
	Freq. (MHz)	6595	6615	6635	6655	6675	6695	6715	6735
BW 40M	Channel	131		139		147		155	
	Freq. (MHz)	6605		6645		6685		6725	
BW 80M	Channel	135				151			
	Freq. (MHz)	6625				6705			
BW 160M	Channel	143							
	Freq. (MHz)	6665							

BW 20M	Channel	161	165	169	173	177	181	185	189
	Freq. (MHz)	6755	6775	6795	6815	6835	6855	6875	6895
BW 40M	Channel	163		171		179		187	
	Freq. (MHz)	6765		6805		6845		6885	
BW 80M	Channel	167				183			
	Freq. (MHz)	6785				6865			
BW 160M	Channel	175							
	Freq. (MHz)	6825							



BW 20M	Channel	193	197	201	205	209	213	217	221
	Freq. (MHz)	6915	6935	6955	6975	6995	7015	7035	7055
BW 40M	Channel	195		203		211		219	
	Freq. (MHz)	6925		6965		7005		7045	
BW 80M	Channel	199				215			
	Freq. (MHz)	6945				7025			
BW 160M	Channel	207							
	Freq. (MHz)	6985							
BW 20M	Channel	225				229			
	Freq. (MHz)	7075				7095			
BW 40M	Channel	227							
	Freq. (MHz)	7085							



2.2 Test Mode

This device supports WiFi 802.11be 20MHz bandwidth for 2.4GHz and 160MHz bandwidth for both 5GHz and 6GHz.

This device supports 26/52/106/242/484/996 single tone RU modes for 802.11ax/be modes and the 242/484/996-tone RU modes are covered by 20/40/80MHz channels.

This device supports MRU 52T+26T/106T+26T (small RU) and punctured modes (large RU) for 802.11be mode.

The PSD of partial RU/MRU modes are reduced to be smaller than full RU according to TCB workshop interim guidance Oct. 2018 and Oct. 2022 for WiFi 7 device.

The 802.11ax/be modes are investigated among full RU, single RU and MRU modes for emission spot check and the 11ax modes are covered by 11be modes.

The PSD and power of partial RU and MRU are less than full RU configurations so the full RU is chosen as main test configuration.

The SISO mode conducted power is covered by MIMO mode per chain, so only the MIMO mode is chosen as main test configuration.

The power for 802.11n, 802.11ac and 802.11ax mode is smaller than 802.11be mode, so all other conducted and radiated test is covered by 802.11be mode.

The final test modes include the worst data rates for each modulation shown in the table below.

MIMO Mode

Modulation	Data Rate
802.11a	6 Mbps
802.11ax HE20 (Covered by EHT20)	MCS0
802.11ax HE40 (Covered by EHT40)	MCS0
802.11ax HE80 (Covered by EHT80)	MCS0
802.11ax HE160 (Covered by EHT160)	MCS0
802.11be EHT20	MCS0
802.11be EHT40	MCS0
802.11be EHT80	MCS0
802.11be EHT160	MCS0

Remark: The conducted power level of each chain in MIMO mode is equal or higher than SISO mode.



Test Cases	
AC Conducted Emission	Mode 1 : GSM850 Idle + WLAN (6GHz) Link + Bluetooth Link + USB Cable 1 (Charging from AC Adapter 1)
Remark:	
<ol style="list-style-type: none"> For Radiated Test Cases, the tests were performed with Adapter 2 and USB Cable 2. During the preliminary test, both charging modes (Adapter mode and WPT mode) were verified. It is determined that the adaptor mode is the worst case for official test. 	

Based on ANSI C63.10 clause 5.6.2.2, b) spurious emissions,

Measure the mode with the highest output power and the mode with highest output power spectral density for each modulation family.

		5.6.2.2 (b) Spurious Emissions
UNII-5	20MHz	Covered by 160MHz
	40MHz	Covered by 160MHz
	80MHz	Covered by 160MHz
	160MHz	Test
UNII-6	20MHz	Covered by 160MHz
	40MHz	Covered by 160MHz
	80MHz	Covered by 160MHz
	160MHz	Test
UNII-7	20MHz	Covered by 160MHz
	40MHz	Covered by 160MHz
	80MHz	Covered by 160MHz
	160MHz	Test
UNII-8	20MHz	Covered by 160MHz
	40MHz	Covered by 160MHz
	80MHz	Covered by 160MHz
	160MHz	Test



Ch. #		UNII-5 (5925-6425 MHz)	UNII-6 (6425-6525 MHz)	UNII-7 (6525-6875 MHz)	UNII-8 (6875-7125 MHz)
		802.11be EHT20	802.11be EHT20	802.11be EHT20	802.11be EHT20
L	Low	001	-	-	-
M	Middle	-	-	-	-
H	High	-	-	-	229
Straddle		-	-	-	-

Ch. #		UNII-5 (5925-6425 MHz)	UNII-6 (6425-6525 MHz)	UNII-7 (6525-6875 MHz)	UNII-8 (6875-7125 MHz)
		802.11be EHT40	802.11be EHT40	802.11be EHT40	802.11be EHT40
L	Low	003	-	-	-
M	Middle	-	-	-	-
H	High	-	-	-	227
Straddle		-	-	-	-

Ch. #		UNII-5 (5925-6425 MHz)	UNII-6 (6425-6525 MHz)	UNII-7 (6525-6875 MHz)	UNII-8 (6875-7125 MHz)
		802.11be EHT80	802.11be EHT80	802.11be EHT80	802.11be EHT80
L	Low	007	-	-	-
M	Middle	-		-	-
H	High	-		-	215
Straddle		-	-	-	-

Ch. #		UNII-5 (5925-6425 MHz)	UNII-6 (6425-6525 MHz)	UNII-7 (6525-6875 MHz)	UNII-8 (6875-7125 MHz)
		802.11be EHT160	802.11be EHT160	802.11be EHT160	802.11be EHT160
L	Low	015	-	143	207
M	Middle	047			
H	High	079			
Straddle		-	111	175	-

Remark: Based on ANSI C63.10 clause 5.6.2.2, b) Spurious emissions, measure the mode with the highest output power and the mode with highest output power spectral density for each modulation family.

2.3 Connection Diagram of Test System

<AC Conducted Emission Mode>

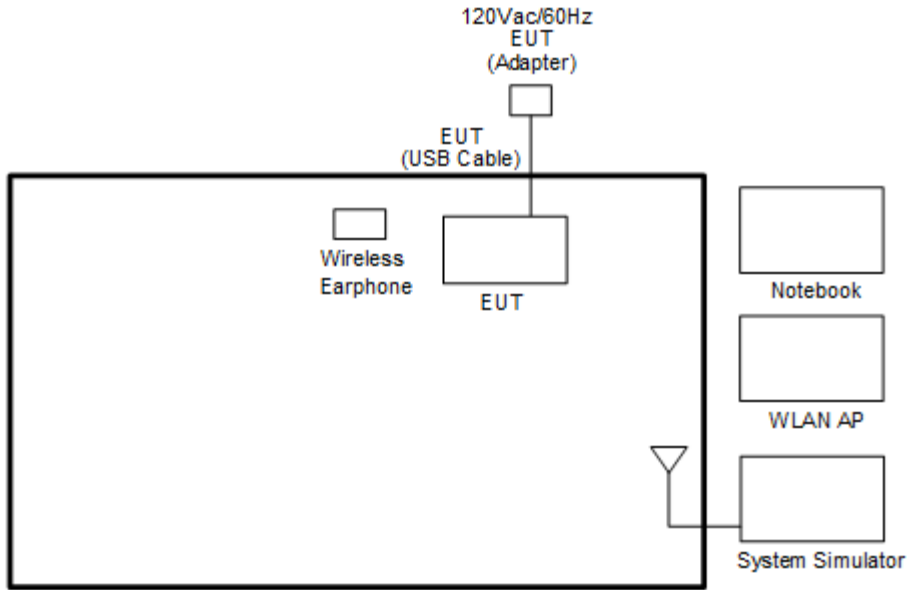

<WLAN Tx Mode>

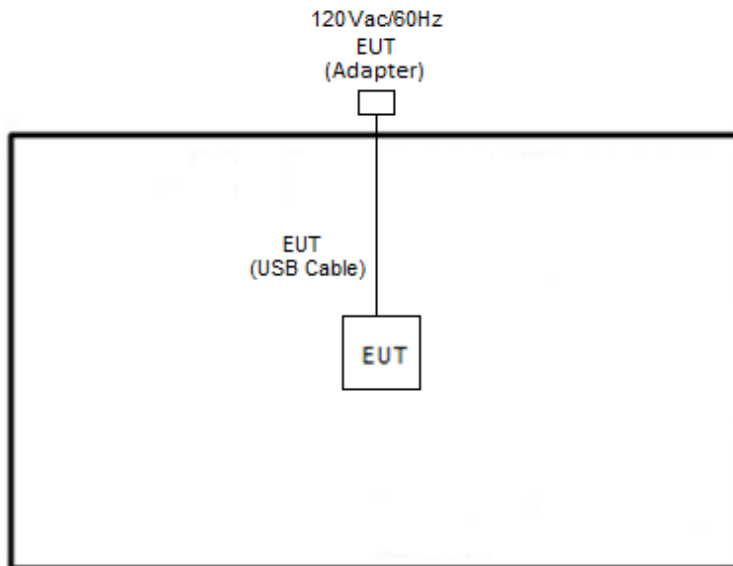



2.4 Support Unit used in test configuration and system

Item	Equipment	Brand Name	Model Name	FCC ID	Data Cable	Power Cord
1.	System Simulator	Anritsu	MT8820C	N/A	N/A	Unshielded,1.8m
2.	Wireless Earphone	Google	G1007/G1008	A4RG1007/ A4RG1008	N/A	N/A
3.	WLAN AP	NETGEAR64	RAXE500	N/A	N/A	Unshielded,1.8m
4.	Notebook	Dell	Latitude 3420	FCC DoC	N/A	AC I/P: Unshielded, 1.2 m DC O/P: Shielded, 1.8 m

2.5 EUT Operation Test Setup

The RF test items, utility “cmd 10.0.19042.1526” was installed in Notebook which was programmed in order to make the EUT get into the engineering modes to provide channel selection, power level, data rate and the application type and for continuous transmitting signals.

2.6 Measurement Results Explanation Example

For all conducted test items:

The offset level is set in the spectrum analyzer to compensate the RF cable loss and attenuator factor between EUT conducted output port and spectrum analyzer. With the offset compensation, the spectrum analyzer reading level is exactly the EUT RF output level.

Example :

The spectrum analyzer offset is derived from RF cable loss and attenuator factor.

Offset = RF cable loss + attenuator factor.

Following shows an offset computation example with cable loss 4.2 dB and 10dB attenuator.

$$\begin{aligned} \text{Offset(dB)} &= \text{RF cable loss(dB)} + \text{attenuator factor(dB)}. \\ &= 4.2 + 10 = 14.2 \text{ (dB)} \end{aligned}$$

3 Test Result

3.1 26dB & 99% Occupied Bandwidth Measurement

3.1.1 Limit of 26dB & 99% Occupied Bandwidth

<FCC 14-30 CFR 15.407>

(a)(10) The maximum transmitter channel bandwidth for U-NII devices in the 5.925-7.125 GHz band is 320 megahertz.

3.1.2 Measuring Instruments

Please refer to the measuring equipment list in this test report.

3.1.3 Test Procedures

1. The testing follows FCC KDB 789033 D02 General UNII Test Procedures New Rules v02r01. Section C) Emission bandwidth
2. Set RBW = approximately 1% of the emission bandwidth.
3. Set the VBW > RBW.
4. Detector = Peak.
5. Trace mode = max hold
6. Measure the maximum width of the emission that is 26 dB down from the peak of the emission. Compare this with the RBW setting of the analyzer. Readjust RBW and repeat measurement as needed until the RBW/EBW ratio is approximately 1%.
7. For 99% Bandwidth Measurement, the spectrum analyzer's resolution bandwidth (RBW) is set 1-5% of the emission bandwidth and set the Video bandwidth (VBW) $\geq 3 * RBW$.
8. Measure and record the results in the test report.

3.1.4 Test Setup

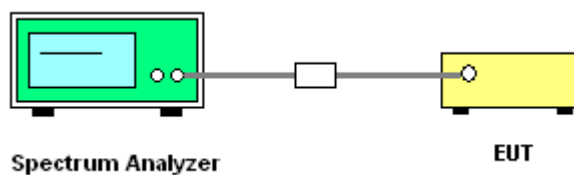

3.1.5 Test Result of 26dB & 99% Occupied Bandwidth

Please refer to Appendix A.



MIMO <Ant. 3+4>

<802.11a>

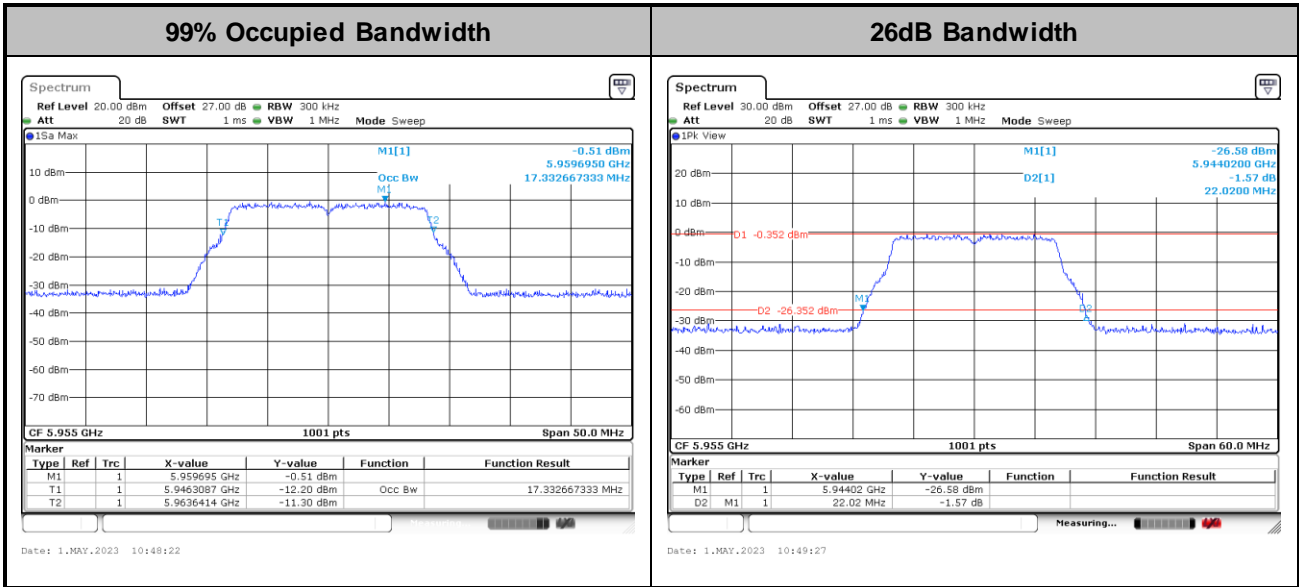

Note: The occupied channel bandwidth is maintained within the band of operation for all of the modulations.

<802.11be EHT20>

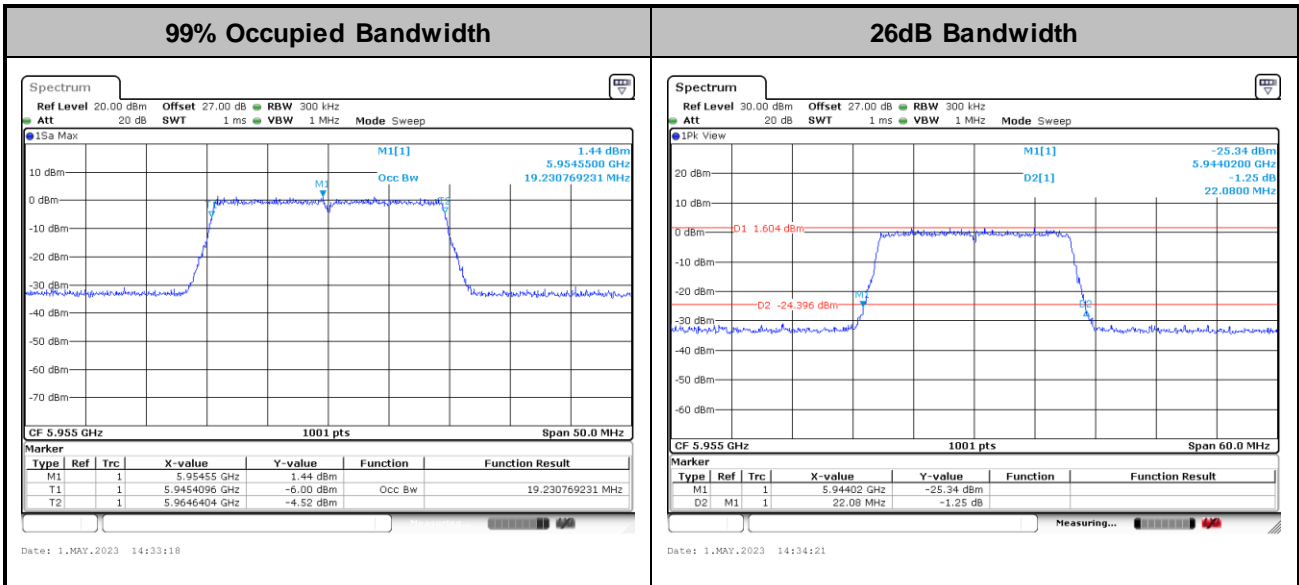

Note: The occupied channel bandwidth is maintained within the band of operation for all of the modulations.



<802.11be EHT40>

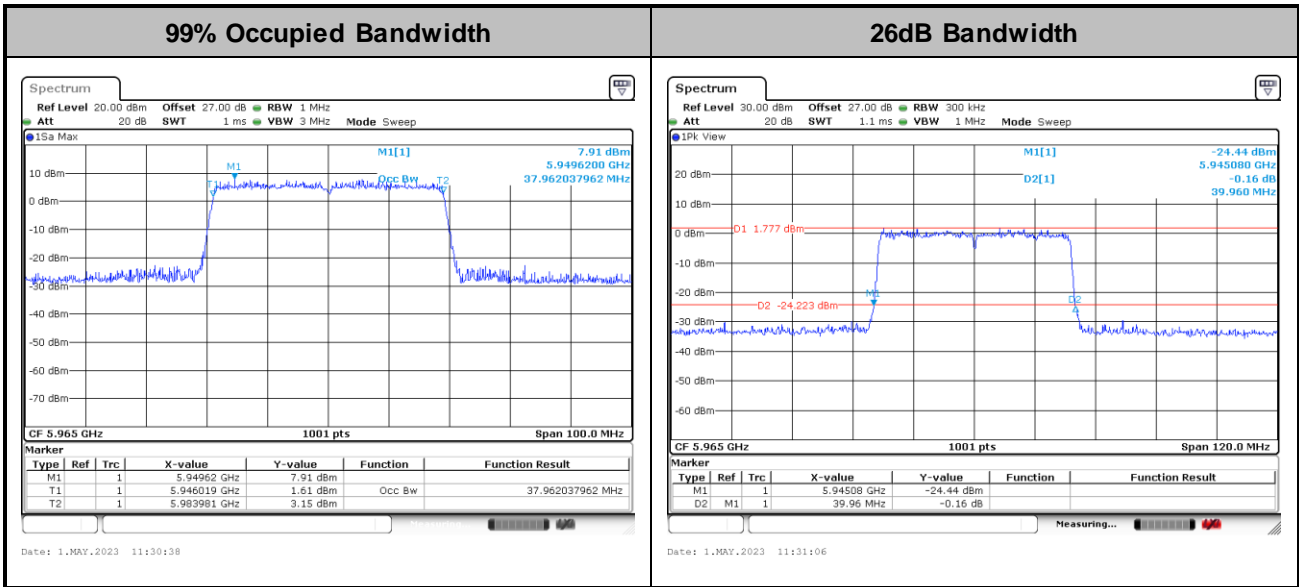

Note: The occupied channel bandwidth is maintained within the band of operation for all of the modulations.

<802.11be EHT80>

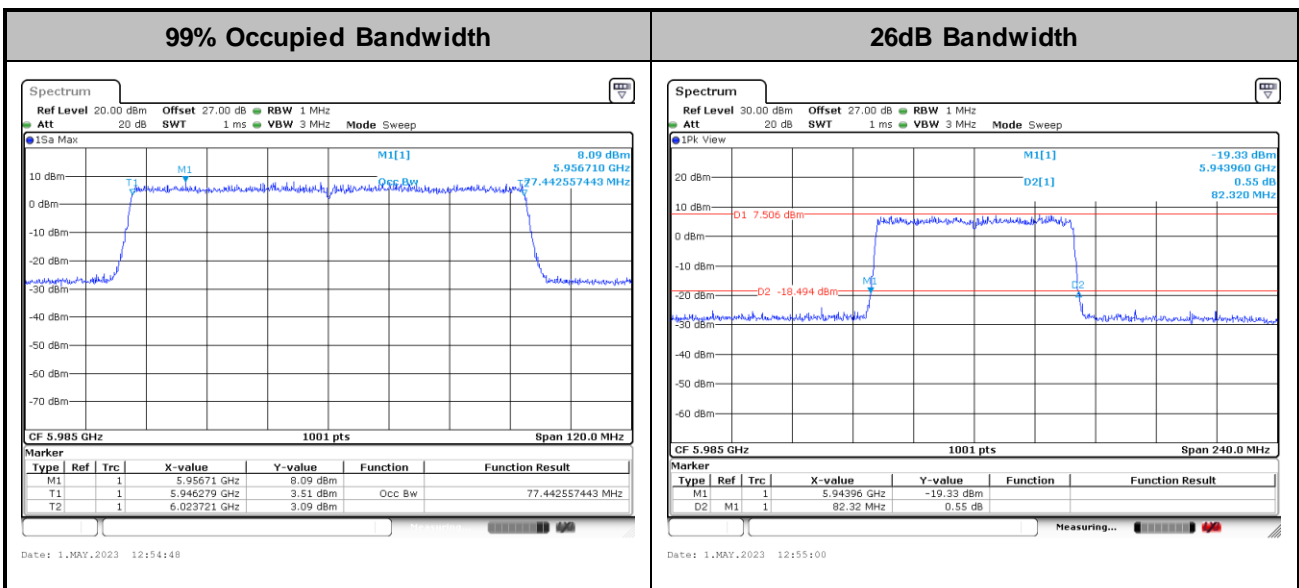

Note: The occupied channel bandwidth is maintained within the band of operation for all of the modulations.



<802.11be EHT160>

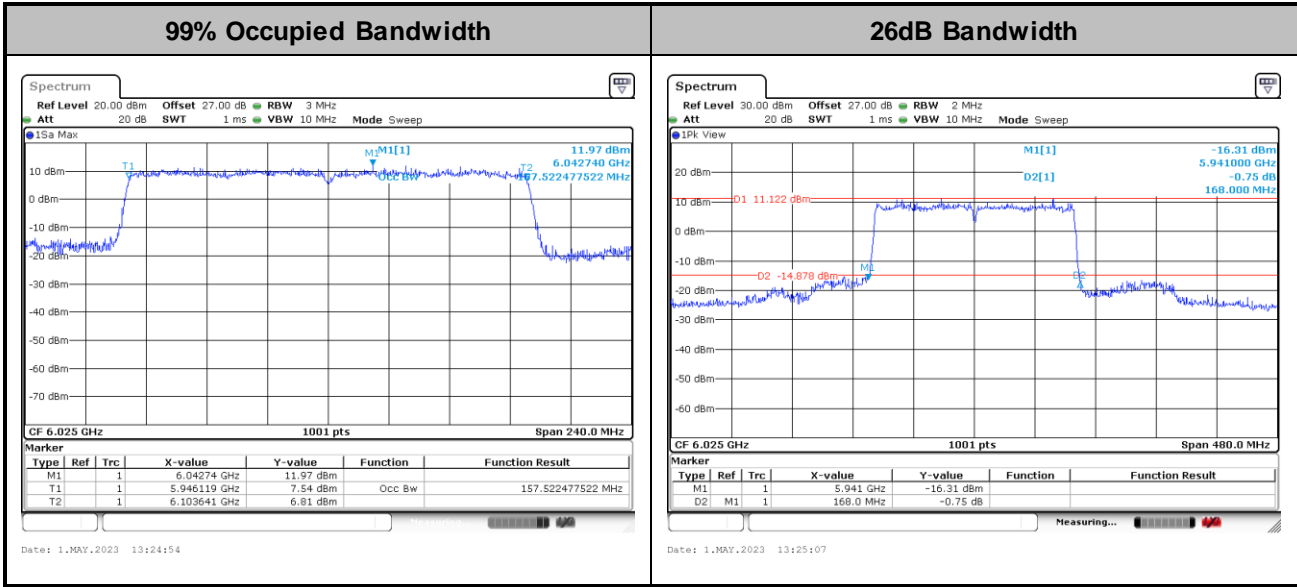

Note: The occupied channel bandwidth is maintained within the band of operation for all of the modulations.

3.2 Fundamental Maximum EIRP Measurement

3.2.1 Limit of Fundamental Maximum EIRP

<FCC 14-30 CFR 15.407>

(a)(8) For client devices operating under the control of an indoor access point in the 5.925-7.125 GHz bands, the maximum e.i.r.p. over the frequency band of operation must not exceed 24 dBm.

3.2.2 Measuring Instruments

Please refer to the measuring equipment list in this test report.

3.2.3 Test Procedures

The testing follows Method PM-G of FCC KDB 789033 D02 General UNII Test Procedures New Rules v02r01.

Method PM-G (Measurement using a gated RF average power meter):

1. Measurement is performed using a wideband RF power meter.
2. The EUT is configured to transmit at its maximum power control level.
3. Measure the average power of the transmitter.
4. Since the measurement is made only during the ON time of the transmitter, no duty cycle correction factor is required.
5. For MIMO mode, calculation method follows FCC KDB 662911 D01 Multiple Transmitter Output v02r01.

3.2.4 Test Setup

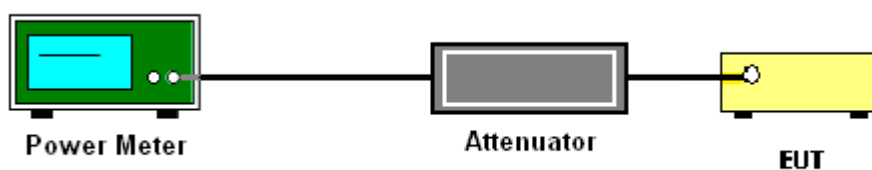

3.2.5 Test Result of Fundamental Maximum EIRP

Please refer to Appendix A.



3.3 Fundamental Power Spectral Density Measurement

3.3.1 Limit of Fundamental Power Spectral Density

<FCC 14-30 CFR 15.407>

(a)(8) For client devices operating under the control of an indoor access point in the 5.925-7.125 GHz bands, the maximum power spectral density must not exceed -1 dBm e.i.r.p. in any 1-megahertz band.

3.3.2 Measuring Instruments

Please refer to the measuring equipment list in this test report.

3.3.3 Test Procedures

The testing follows FCC KDB 789033 D02 General UNII Test Procedures New Rules v02r01. Section F) Maximum power spectral density.

Method SA-2

(trace averaging across on and off times of the EUT transmissions, followed by duty cycle correction).

- Measure the duty cycle.
 - Set span to encompass the entire emission bandwidth (EBW) of the signal.
 - Set RBW = 1 MHz.
 - Set VBW \geq 3 MHz.
 - Number of points in sweep \geq 2 Span / RBW.
 - Sweep time = auto.
 - Detector = RMS
 - Trace average at least 100 traces in power averaging mode.
 - Add $10 \log(1/x)$, where x is the duty cycle, to the measured power in order to compute the average power during the actual transmission times. For example, add $10 \log(1/0.25) = 6$ dB if the duty cycle is 25 percent.
1. The RF output of EUT was connected to the spectrum analyzer by a low loss cable.
 2. Each plot has already offset with cable loss, and attenuator loss. Measure the PPSD and record it.
 3. For MIMO mode, calculation method follows FCC KDB 662911 D01 Multiple Transmitter Output v02r01.

Method (a): Measure and sum the spectra across the outputs.

The total final Power Spectral Density is from a device with 2 transmitter outputs. The spectrum measurements of the individual outputs are all performed with the same span and number of points; the spectrum value in the first spectral bin of output 1 is summed with that in the first spectral bin of output 2 to obtain the value for the first frequency bin of the summed spectrum.

3.3.4 Test Setup

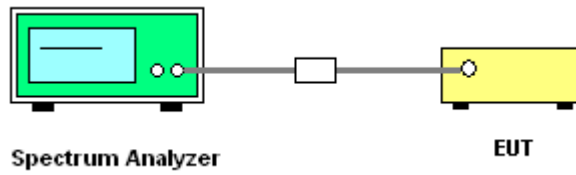

3.3.5 Test Result of Power Spectral Density

Please refer to Appendix A.



<802.11a>

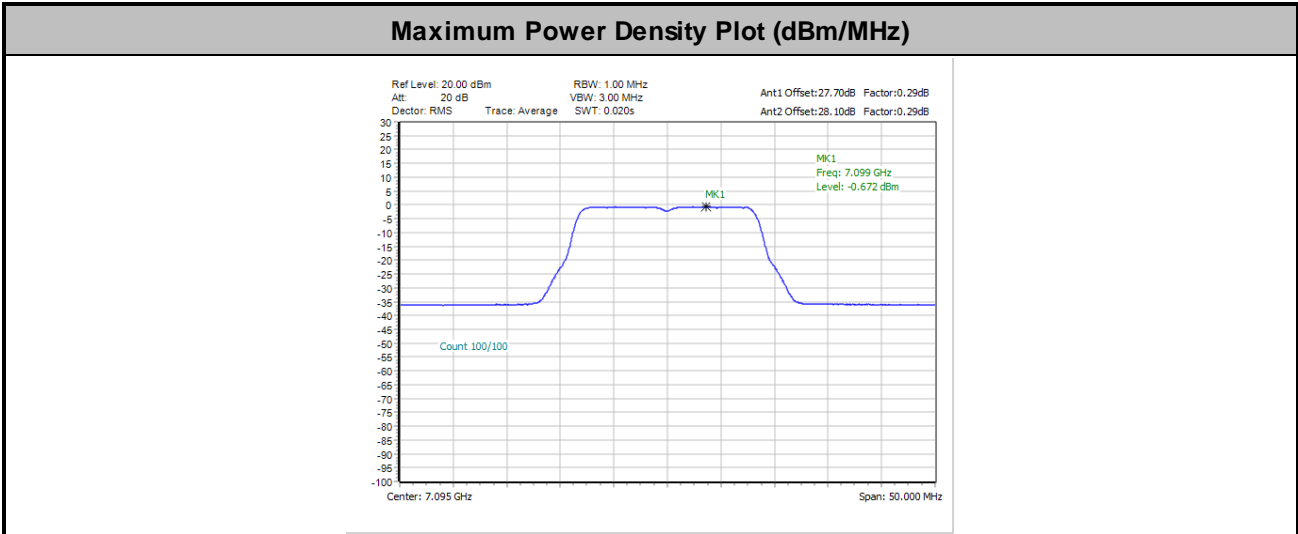

Note:

1. EIRP Power Density (dBm/MHz) = Measured value+ Duty Factor + Directional Gain
2. The test plot is showing a bin by bin combined result mathematically adds two traces.

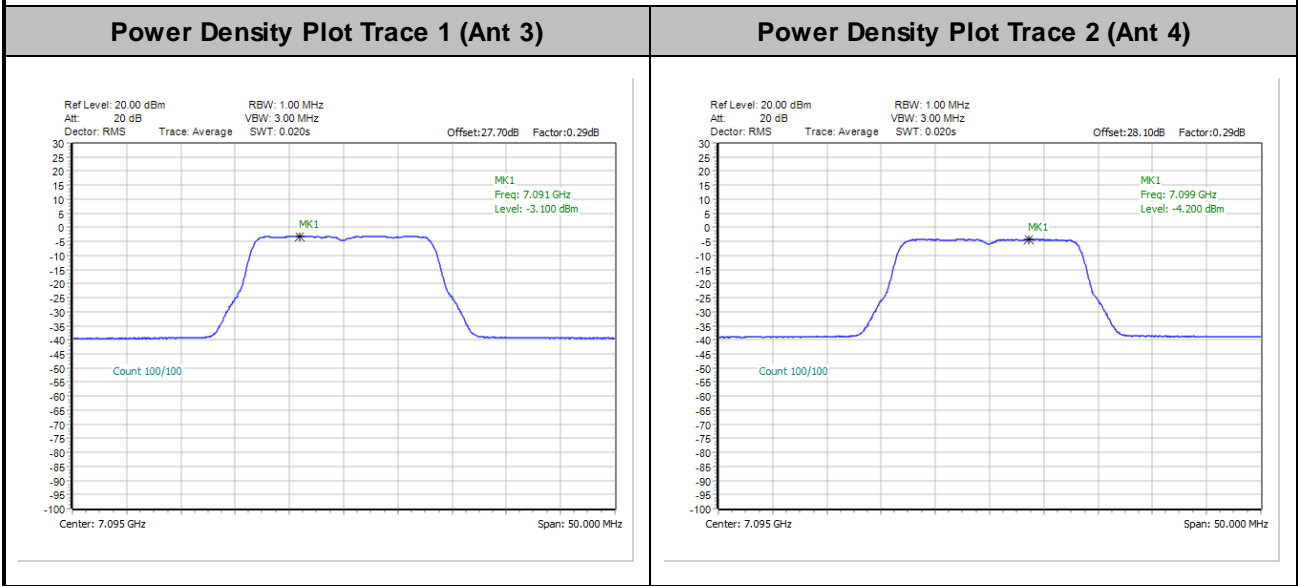



<802.11be EHT20 Full RU>

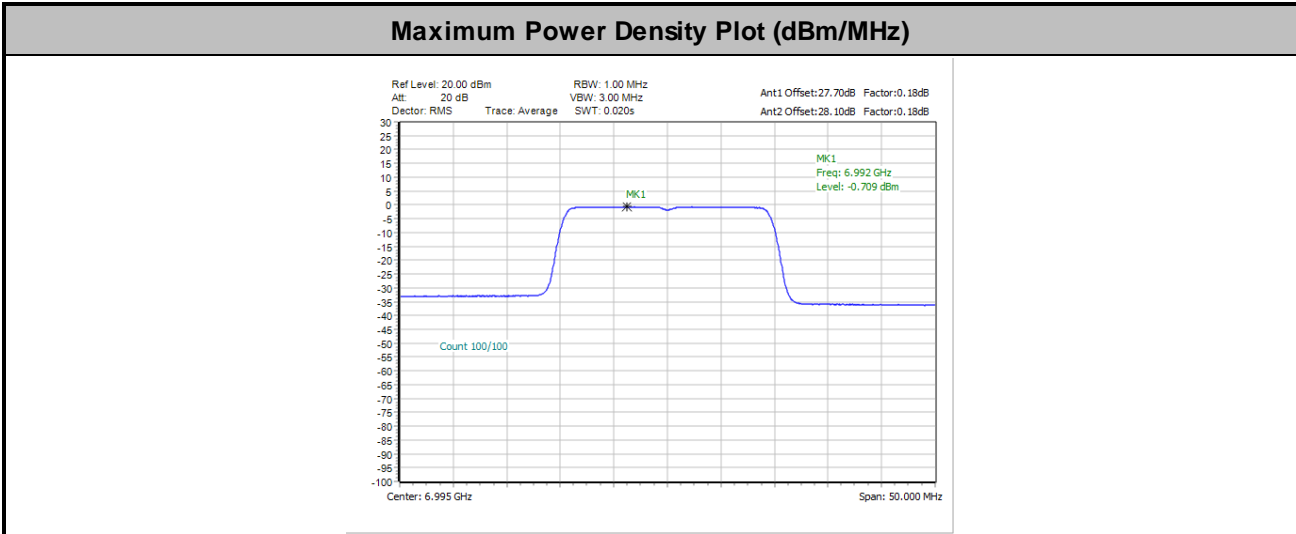

Note:

1. EIRP Power Density (dBm/MHz) = Measured value+ Duty Factor + Directional Gain
2. The test plot is showing a bin by bin combined result mathematically adds two traces.

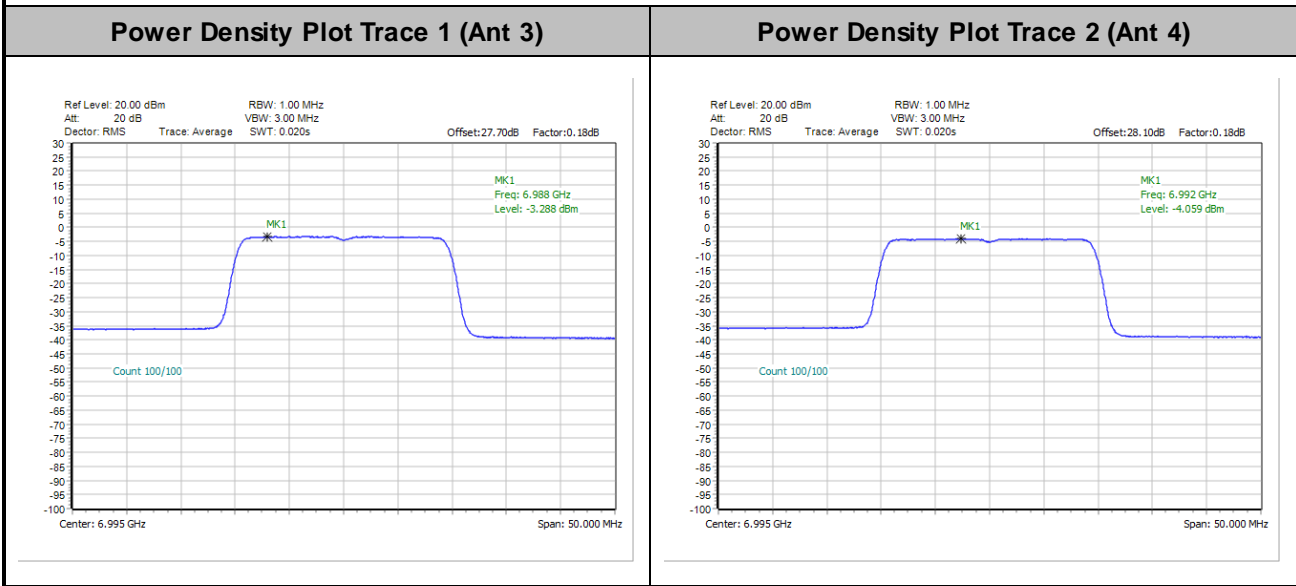



<802.11be EHT40 Full RU>

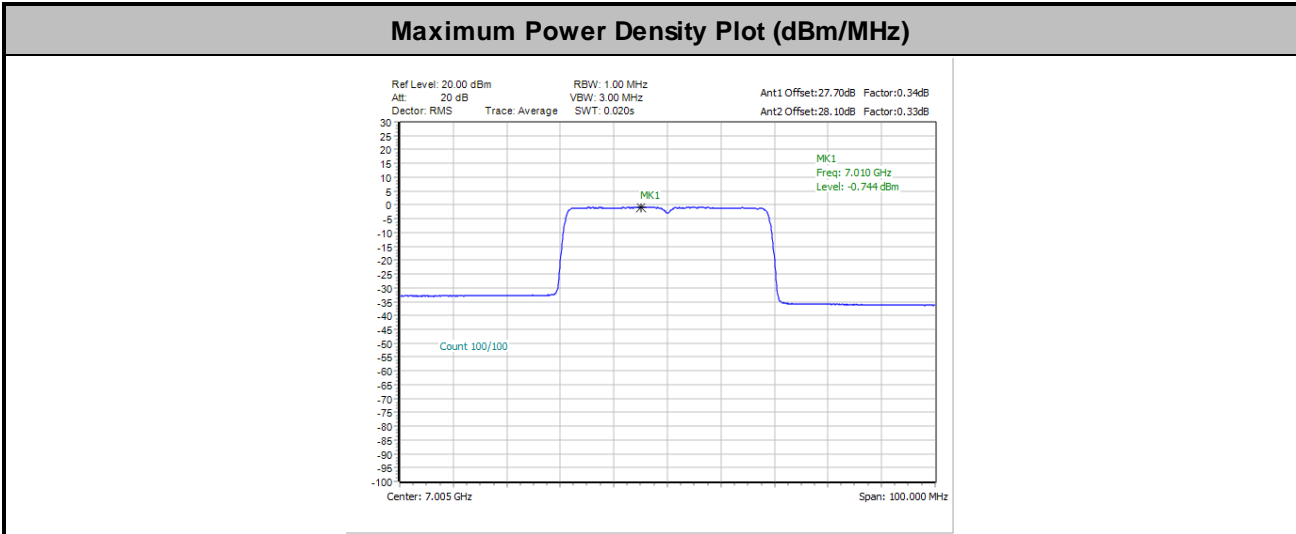

Note:

1. EIRP Power Density (dBm/MHz) = Measured value+ Duty Factor + Directional Gain
2. The test plot is showing a bin by bin combined result mathematically adds two traces.

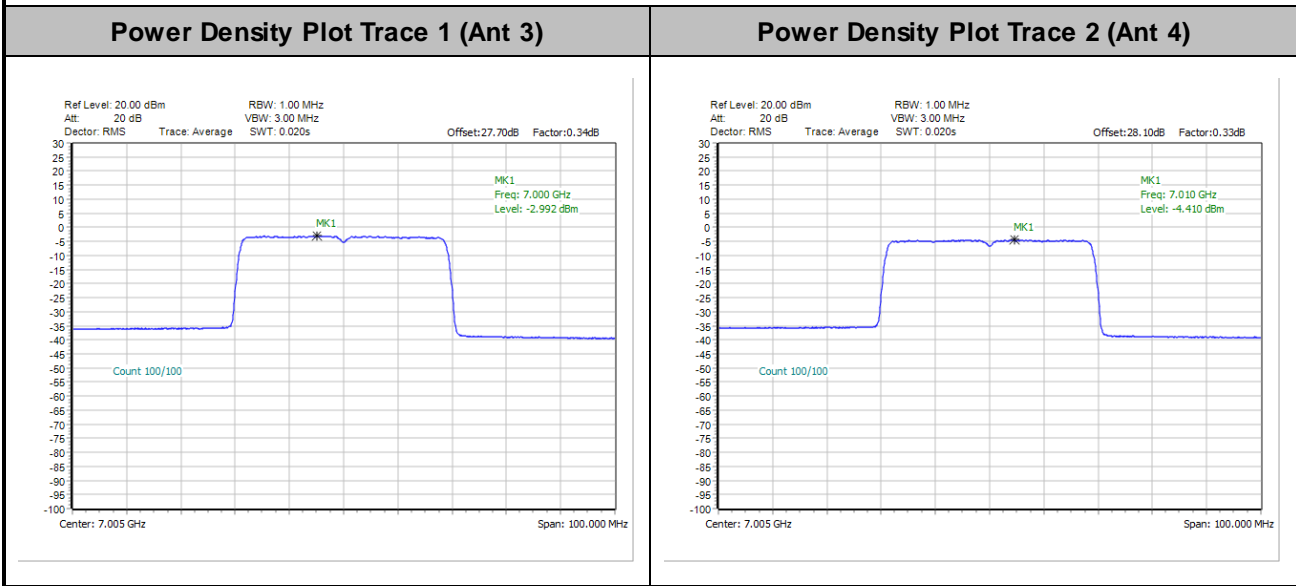



<802.11be EHT160 Full RU>

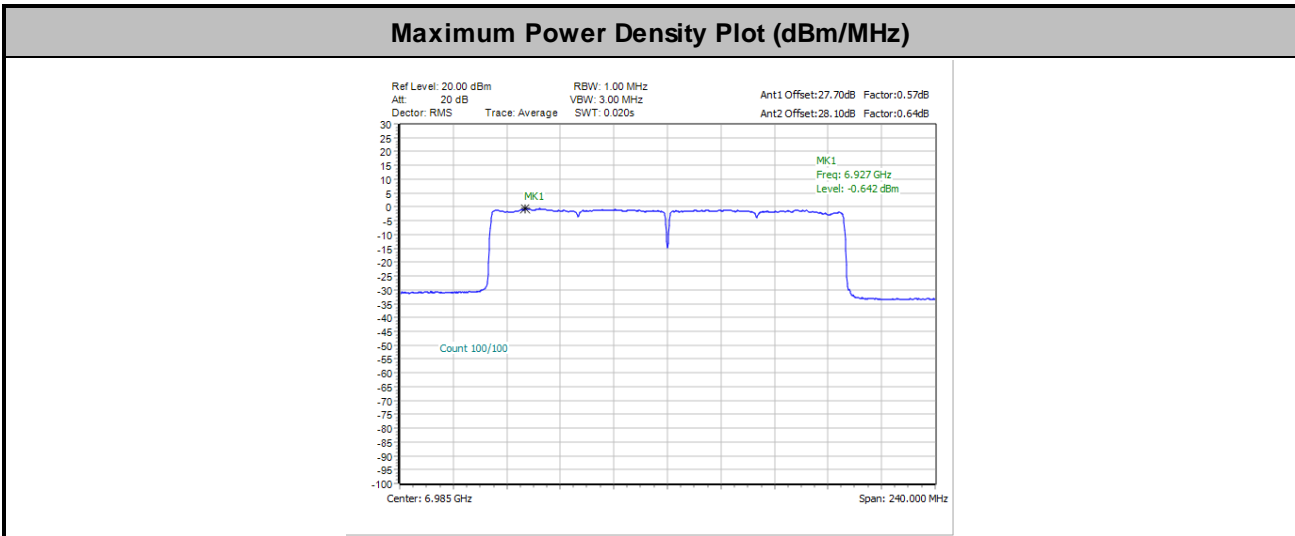

Note:

1. EIRP Power Density (dBm/MHz) = Measured value+ Duty Factor + Directional Gain
2. The test plot is showing a bin by bin combined result mathematically adds two traces.

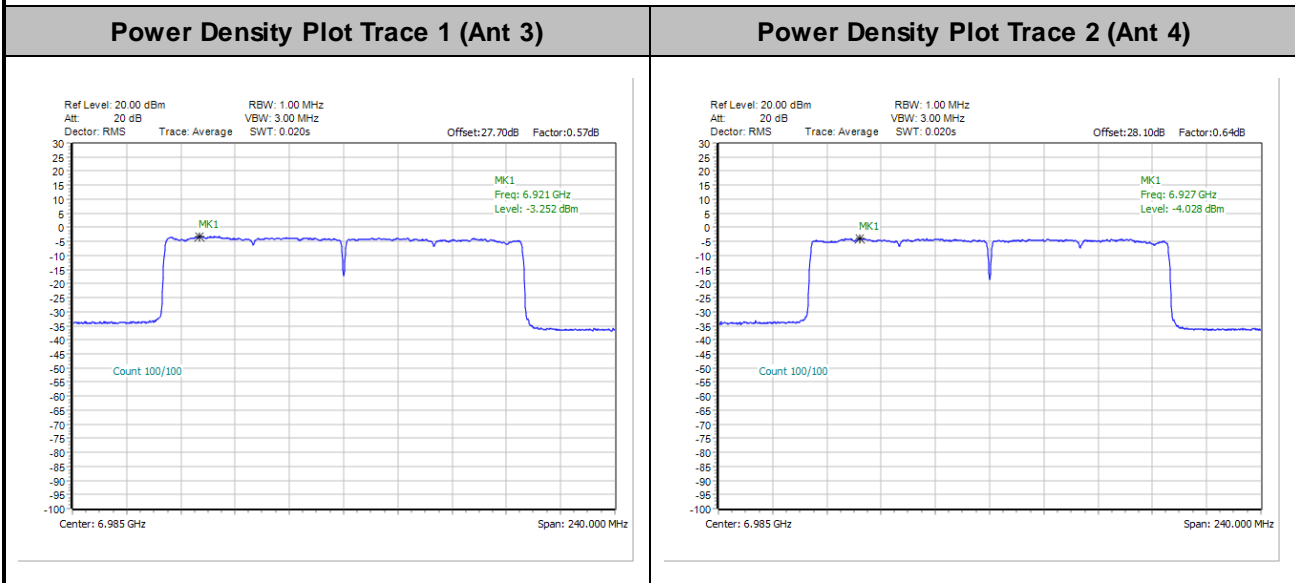



3.4 In-Band Emissions (Channel Mask)

3.4.1 Limit of Unwanted Emissions

<FCC 14-30 CFR 15.407>

(a)(6) For transmitters operating within the 5.925-7.125 GHz bands: Power spectral density must be suppressed by 20 dB at 1 MHz outside of channel edge, by 28 dB at one channel bandwidth from the channel center, and by 40 dB at one- and one-half times the channel bandwidth away from channel center. At frequencies between one megahertz outside an unlicensed device's channel edge and one channel bandwidth from the center of the channel, the limits must be linearly interpolated between 20 dB and 28 dB suppression, and at frequencies between one and one- and one-half times an unlicensed device's channel bandwidth, the limits must be linearly interpolated between 28 dB and 40 dB suppression. Emissions removed from the channel center by more than one- and one-half times the channel bandwidth must be suppressed by at least 40 dB.

3.4.2 Measuring Instruments

Please refer to the measuring equipment list in this test report.

3.4.3 Test Procedures

The testing follows FCC KDB 987594 D02 U-NII 6GHz EMC Measurement v01.

Section J) In-Band Emissions.

1. Take nominal bandwidth as reference channel bandwidth provided that 26 dB emission bandwidth is always larger than nominal bandwidth
2. Measure the power spectral density (which will be used for emissions mask reference) using the following procedure:
 - a) Set the span to encompass the entire 26 dB EBW of the signal.
 - b) Set RBW = same RBW used for 26 dB EBW measurement.
 - c) Set VBW $\geq 3 \times$ RBW
 - d) Number of points in sweep $\geq [2 \times \text{span} / \text{RBW}]$.
 - e) Sweep time = auto.
 - f) Detector = RMS (i.e., power averaging)
 - g) Trace average at least 100 traces in power averaging (rms) mode.
 - h) Use the peak search function on the instrument to find the peak of the spectrum.
3. Using the measuring equipment limit line function, develop the emissions mask based on the following requirements. The emissions power spectral density must be reduced below the peak power spectral density (in dB) as follows:
 - a. Suppressed by 20 dB at 1 MHz outside of the channel edge.
 - b. Suppressed by 28 dB at one channel bandwidth from the channel center.
 - c. Suppressed by 40 dB at one- and one-half times the channel bandwidth from the channel center.
4. Adjust the span to encompass the entire mask as necessary.
5. Clear trace.
6. Trace average at least 100 traces in power averaging (rms) mode.
7. Adjust the reference level as necessary so that the crest of the channel touches the top of the emission mask.

3.4.4 Test Setup

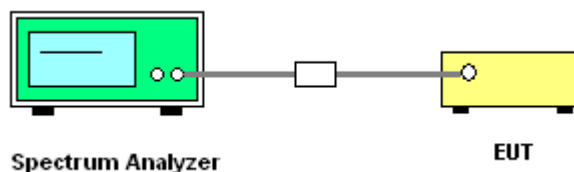



3.4.5 Test Result

MIMO <Ant. 3+4(3)>

EUT Mode : 802.11a

Plot on Channel 5955 MHz

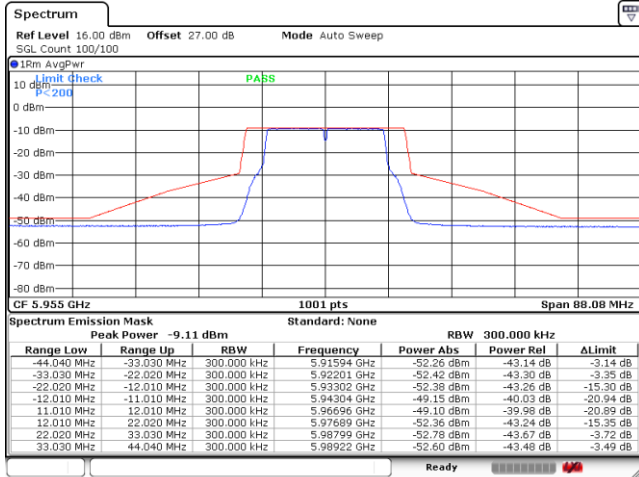

Date: 1.MAY.2023 10:49:49

Plot on Channel 6195 MHz

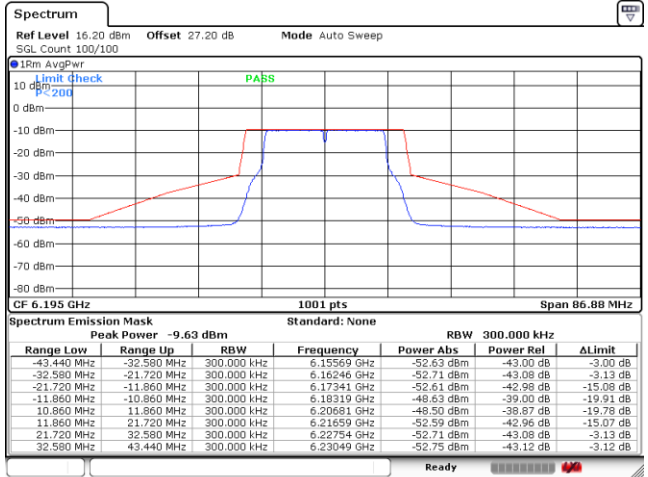

Date: 1.MAY.2023 10:47:49

Plot on Channel 6415 MHz

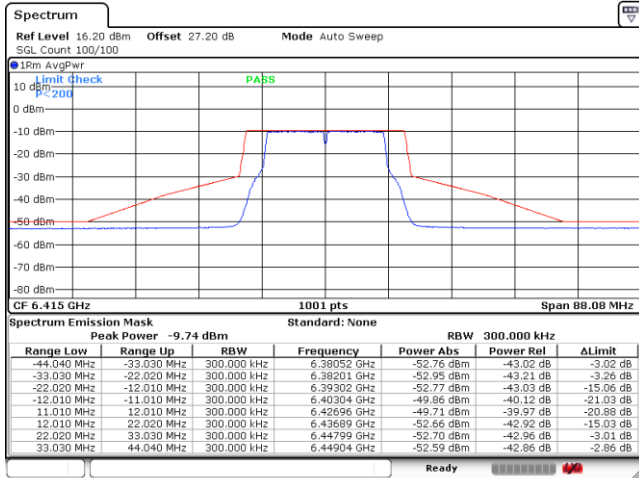

Date: 1.MAY.2023 10:43:27

Plot on Channel 6435 MHz

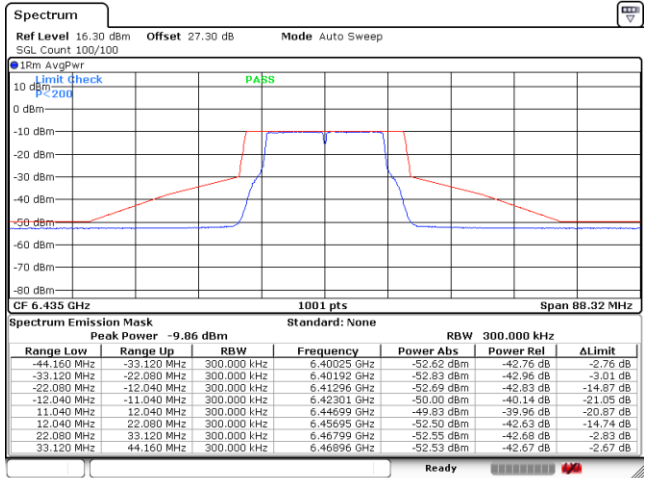

Date: 1.MAY.2023 10:41:06



Plot on Channel 6475 MHz

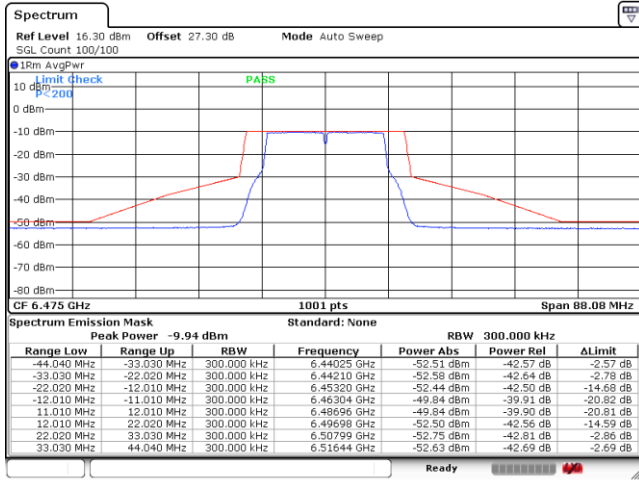

Date: 1.MAY.2023 10:36:31

Plot on Channel 6515 MHz

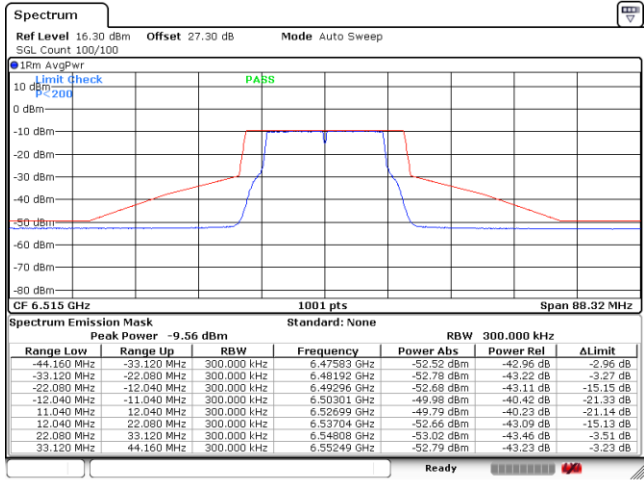

Date: 1.MAY.2023 10:34:50

Plot on Channel 6535 MHz

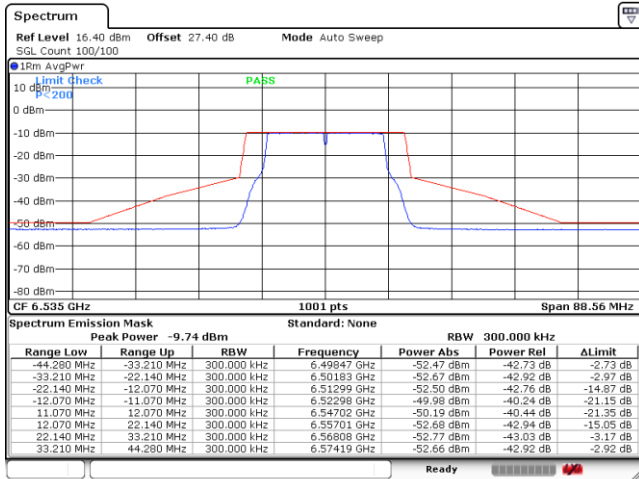

Date: 1.MAY.2023 10:30:28

Plot on Channel 6695 MHz

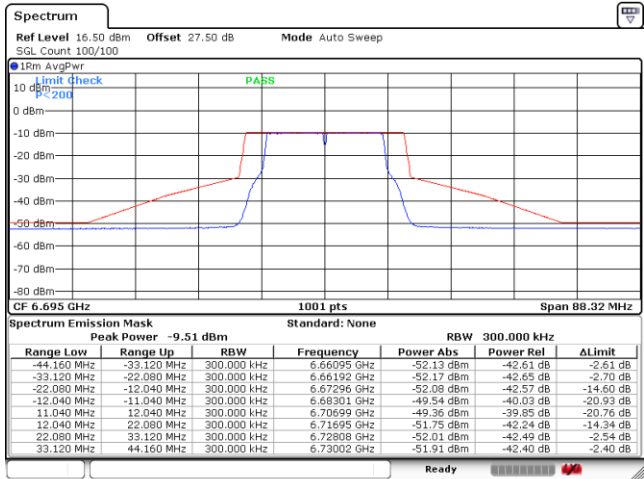

Date: 1.MAY.2023 11:01:38



Plot on Channel 6855 MHz

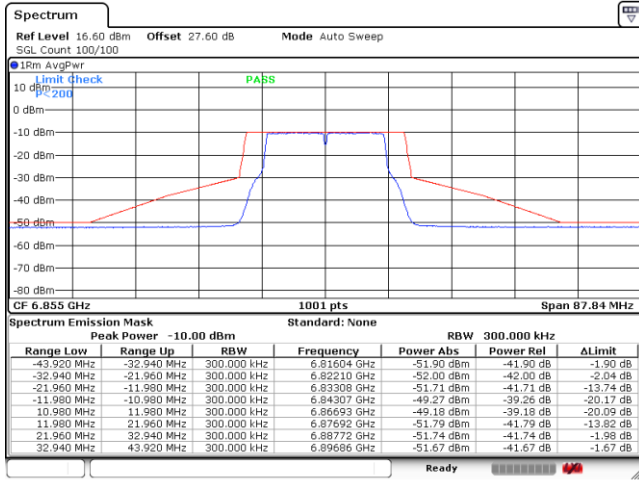

Date: 1.MAY.2023 11:14:09

Plot on Channel 6875 MHz

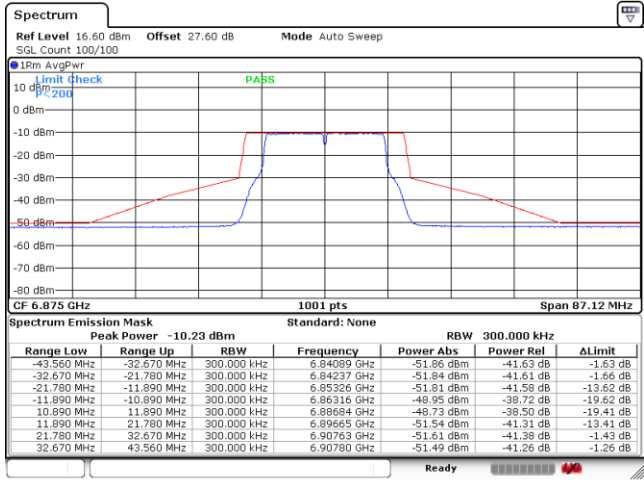

Date: 1.MAY.2023 11:22:28

Plot on Channel 6995 MHz

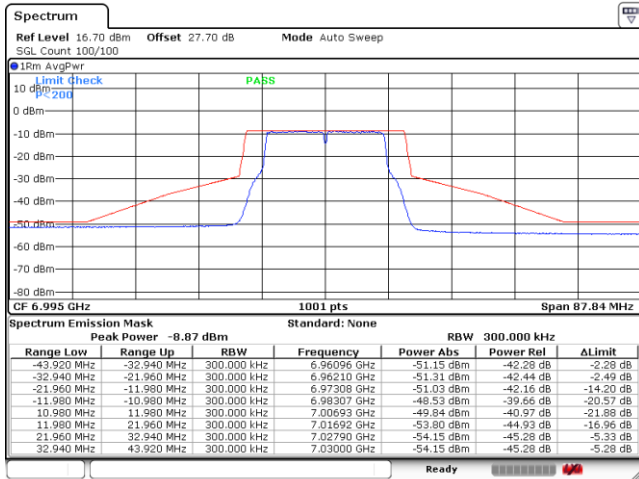

Date: 14.APR.2023 00:29:45

Plot on Channel 7095 MHz

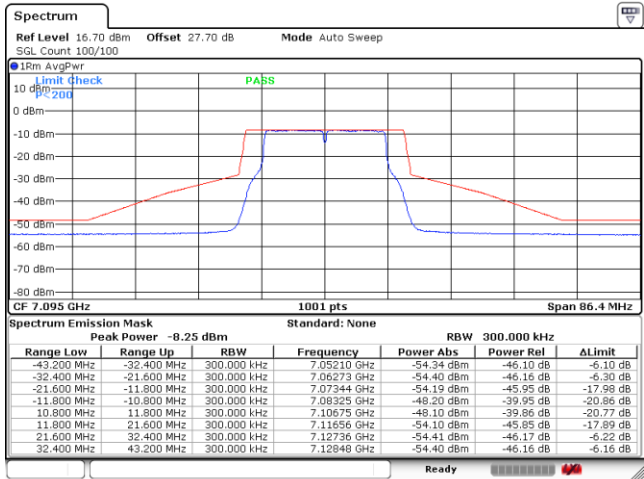

Date: 14.APR.2023 00:44:06



EUT Mode : 802.11be EHT20 Full RU

Plot on Channel 5955 MHz

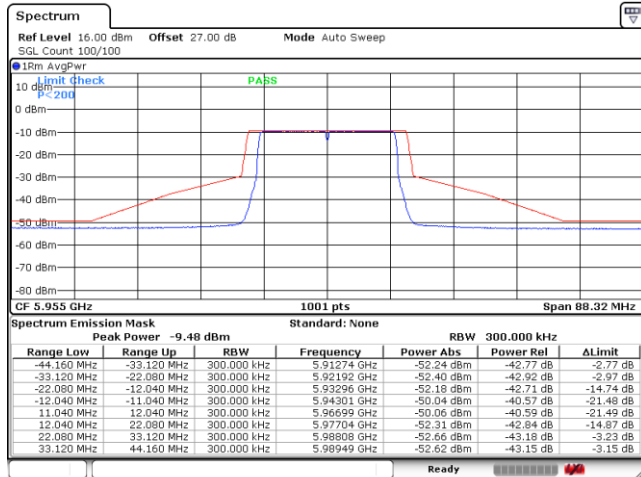

Date: 1.MAY.2023 14:35:08

Plot on Channel 6195 MHz

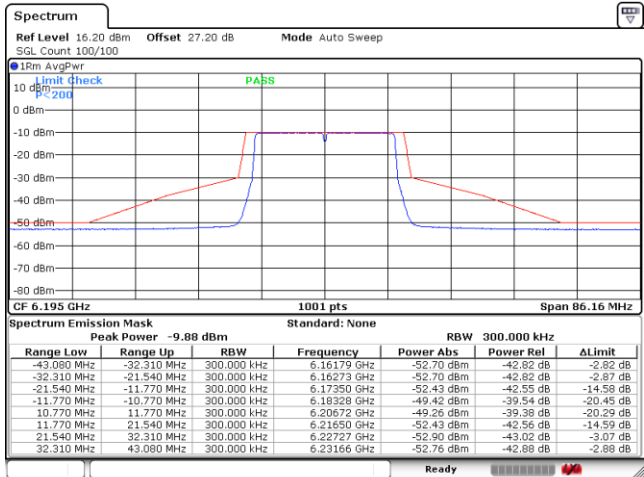

Date: 1.MAY.2023 14:49:55

Plot on Channel 6415 MHz

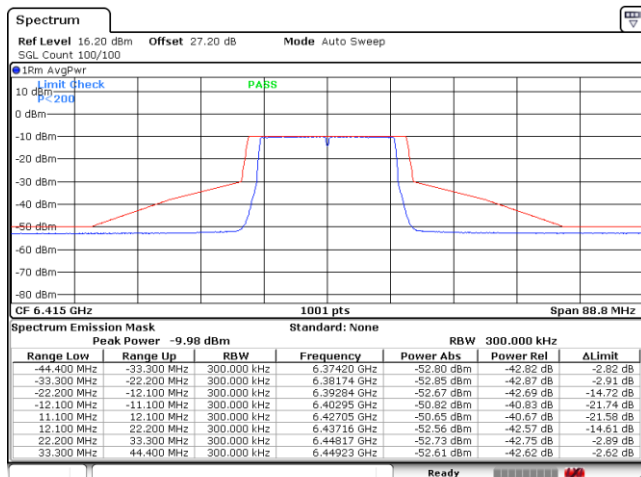

Date: 1.MAY.2023 14:57:20

Plot on Channel 6435 MHz

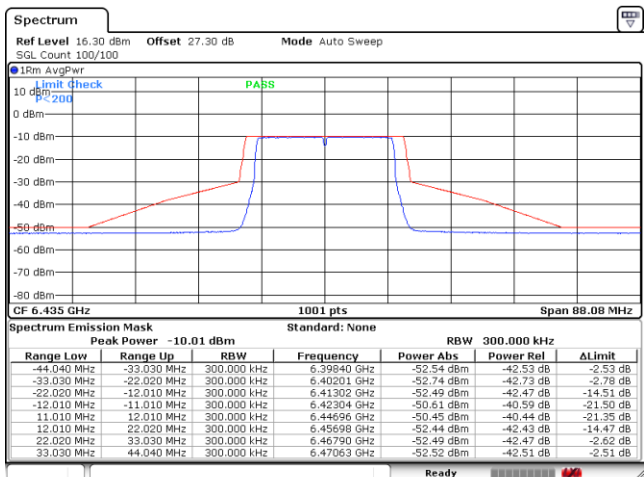

Date: 2.MAY.2023 09:57:49



Plot on Channel 6475 MHz

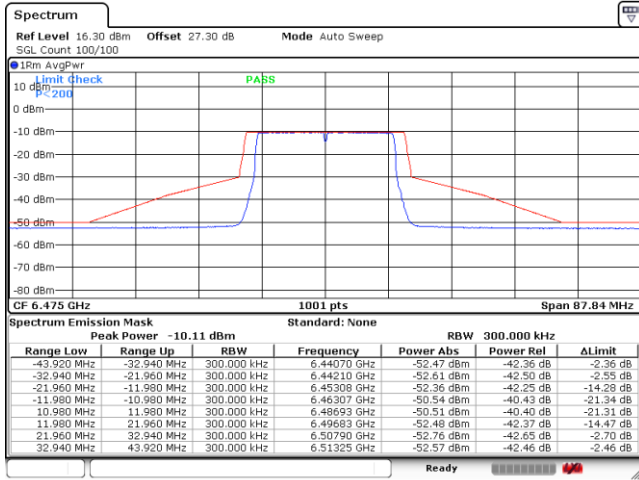

Date: 2.MAY.2023 10:14:48

Plot on Channel 6515 MHz

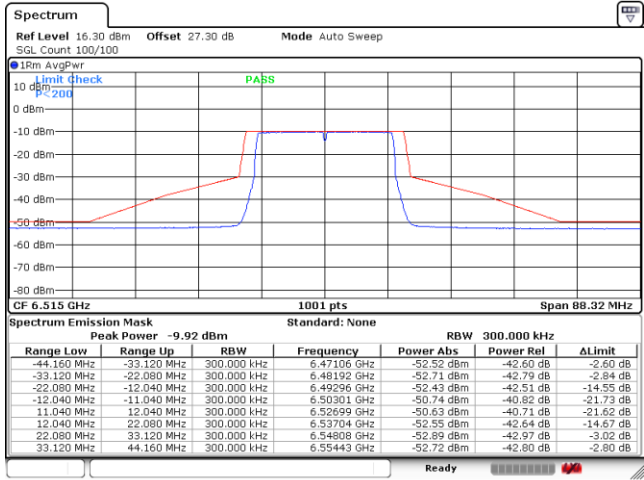

Date: 2.MAY.2023 10:24:05

Plot on Channel 6535 MHz

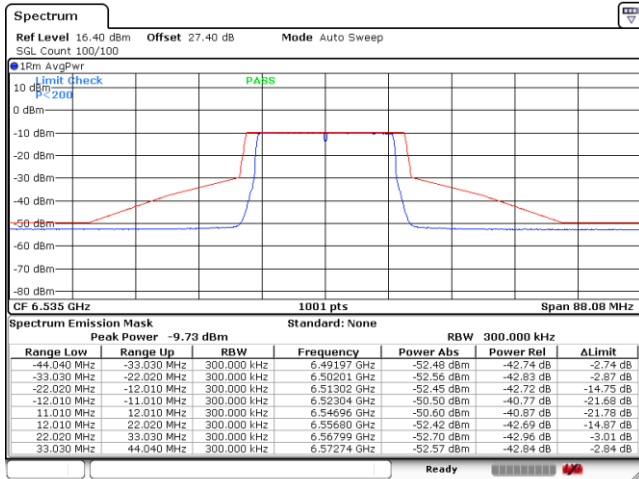

Date: 2.MAY.2023 11:14:42

Plot on Channel 6695 MHz

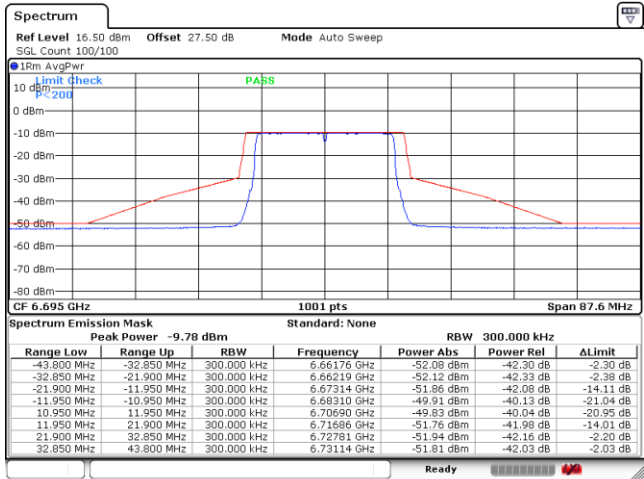

Date: 2.MAY.2023 11:27:11



Plot on Channel 6855 MHz

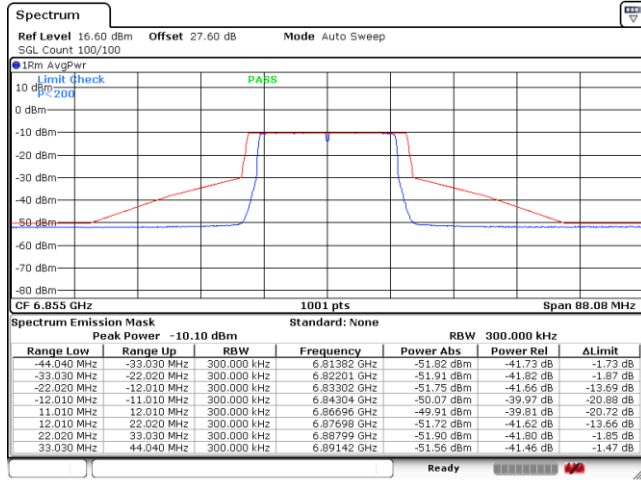

Date: 2.MAY.2023 11:40:40

Plot on Channel 6875 MHz

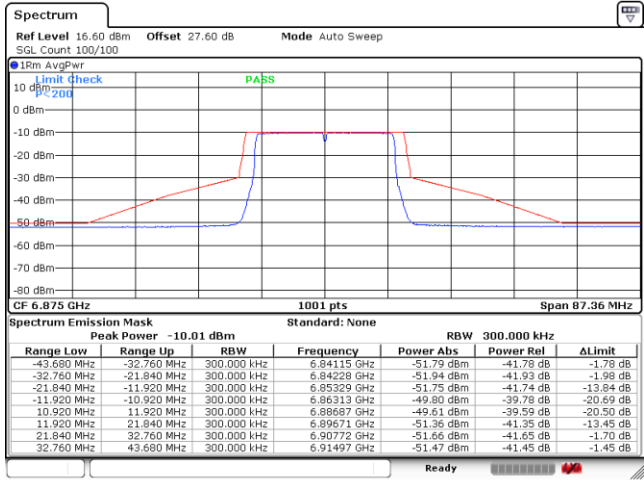

Date: 2.MAY.2023 11:50:19

Plot on Channel 6995 MHz

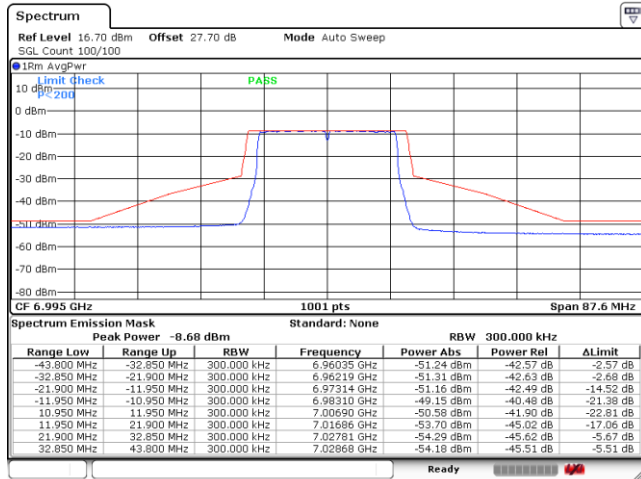

Date: 18.APR.2023 00:18:00

Plot on Channel 7095 MHz

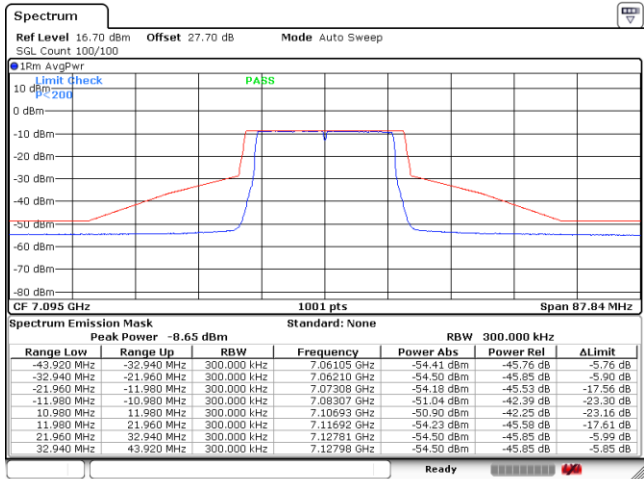

Date: 18.APR.2023 00:28:14



EUT Mode 802.11be EHT20 26RU0

Plot on Channel 5955 MHz

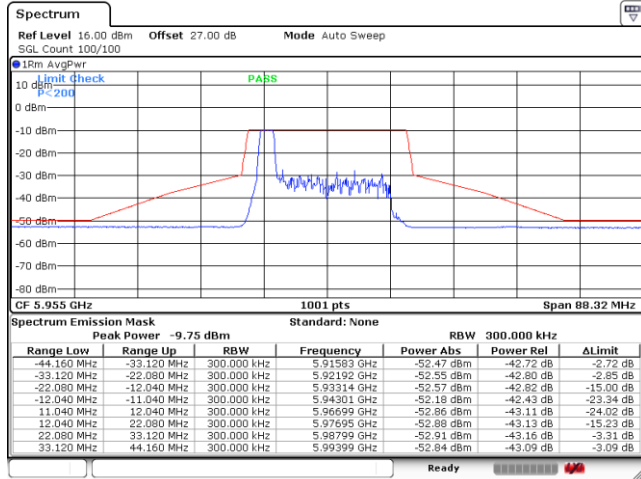

Date: 5.MAY.2023 11:31:03

Plot on Channel 6435 MHz

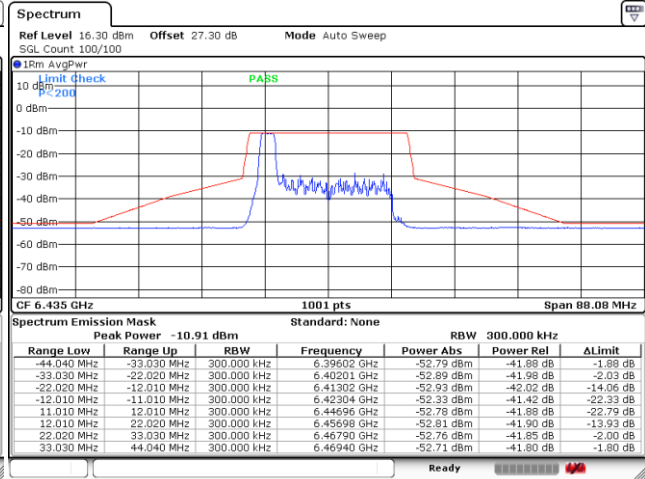

Date: 2.MAY.2023 17:47:58

Plot on Channel 6535 MHz

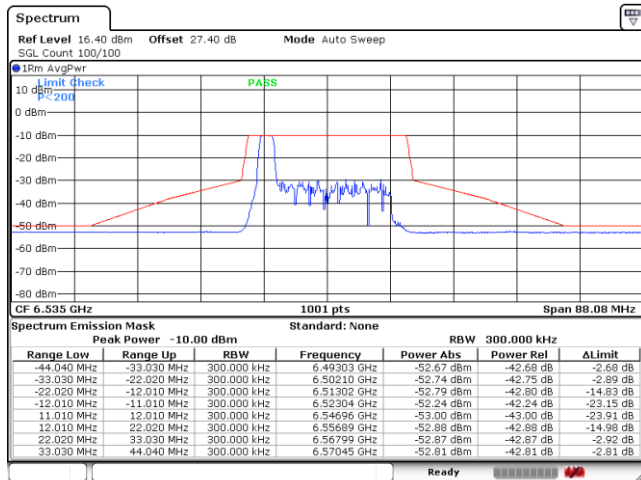

Date: 2.MAY.2023 21:00:16



EUT Mode 802.11be EHT20 26RU4

Plot on Channel 6195 MHz

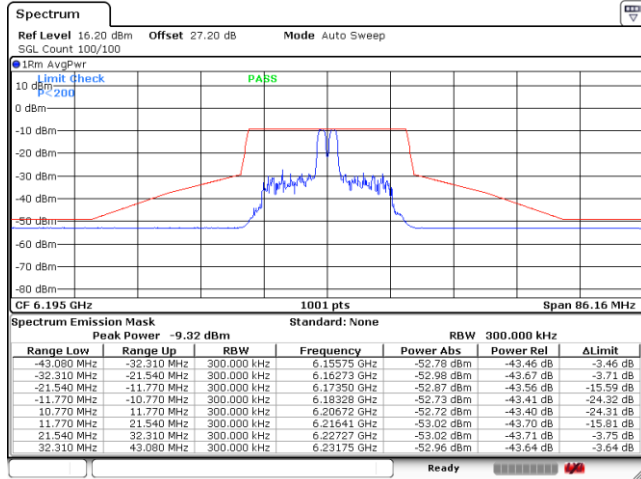

Date: 6.MAY.2023 17:21:57

Plot on Channel 6475 MHz

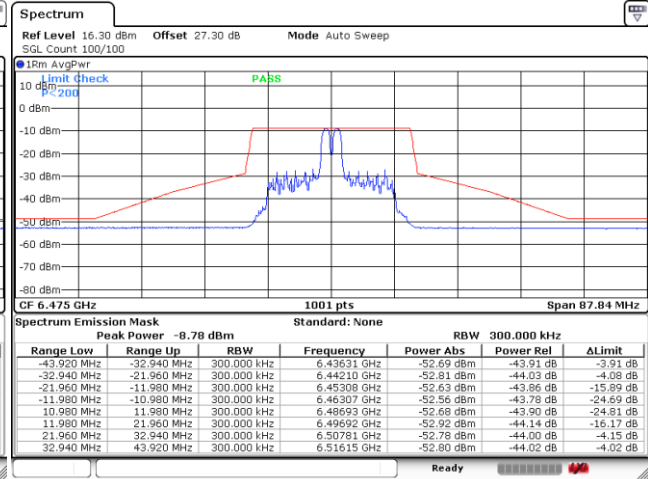

Date: 2.MAY.2023 18:03:38

Plot on Channel 6695 MHz

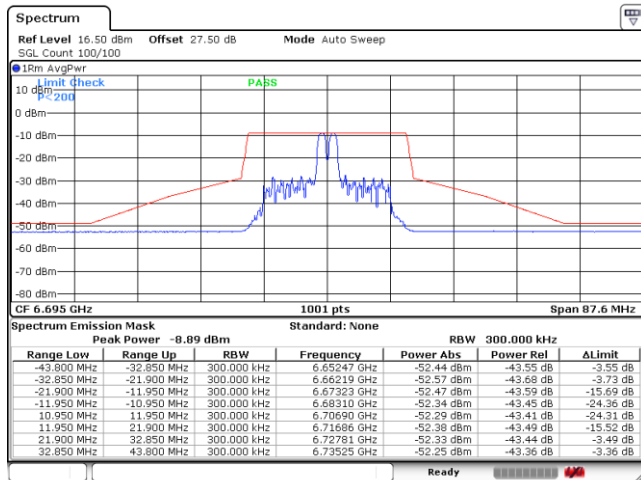

Date: 5.MAY.2023 15:48:51

Plot on Channel 6995 MHz

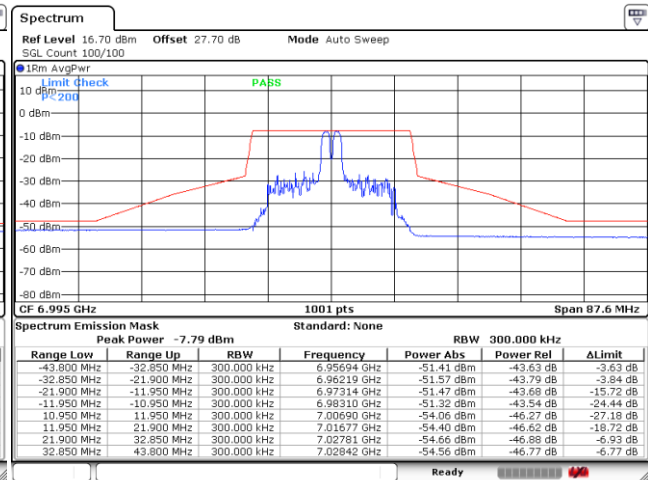

Date: 5.MAY.2023 03:21:16



EUT Mode 802.11be EHT20 26RU8

Plot on Channel 6415 MHz

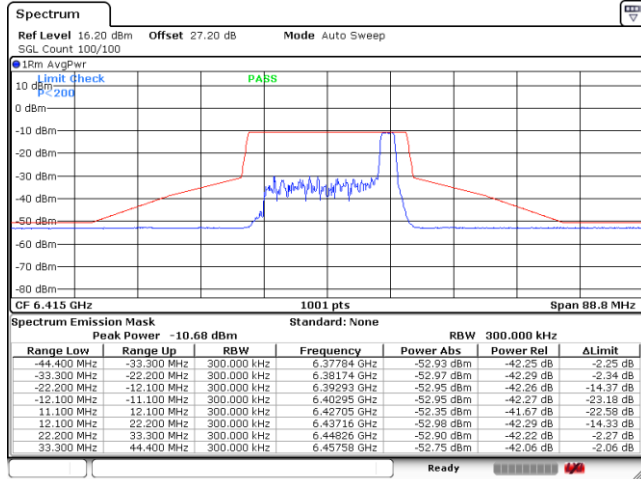

Date: 2.MAY.2023 16:09:07

Plot on Channel 6515 MHz

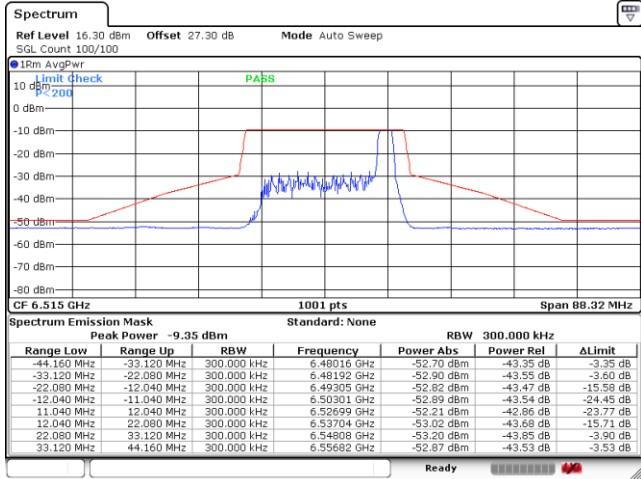

Date: 2.MAY.2023 20:24:13

Plot on Channel 6855 MHz

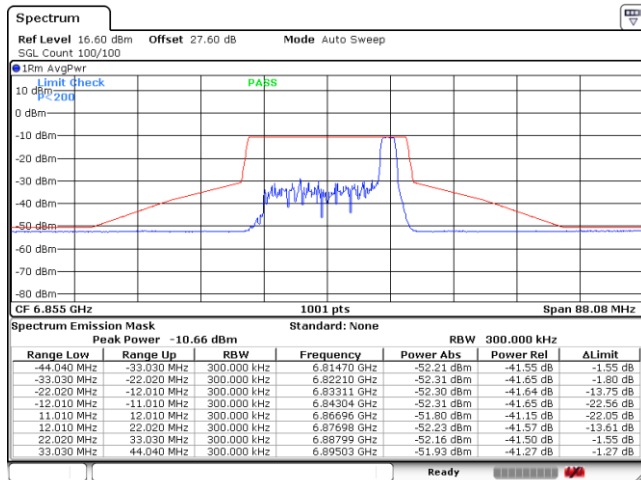

Date: 5.MAY.2023 16:45:46

Plot on Channel 6875 MHz

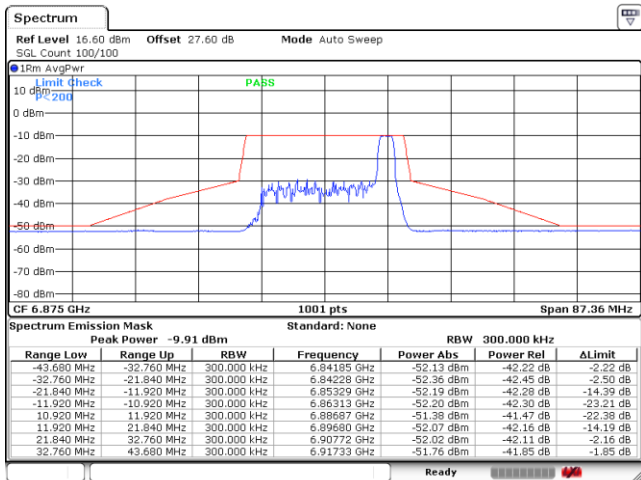

Date: 3.MAY.2023 15:13:03



Plot on Channel 7095 MHz

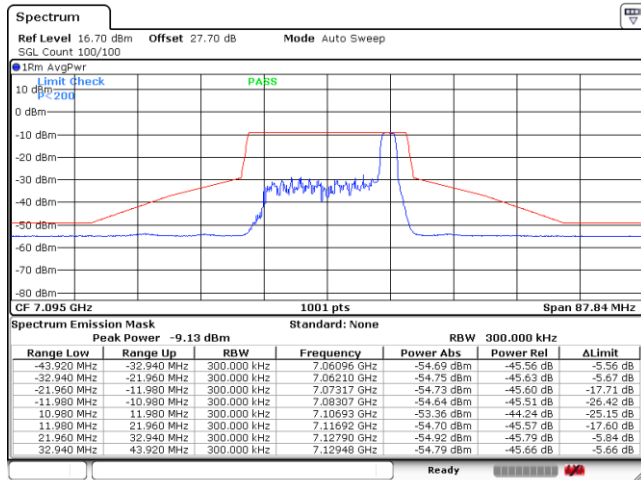

Date: 6.MAY.2023 13:59:12



EUT Mode 802.11be EHT20 52RU37

Plot on Channel 5955 MHz

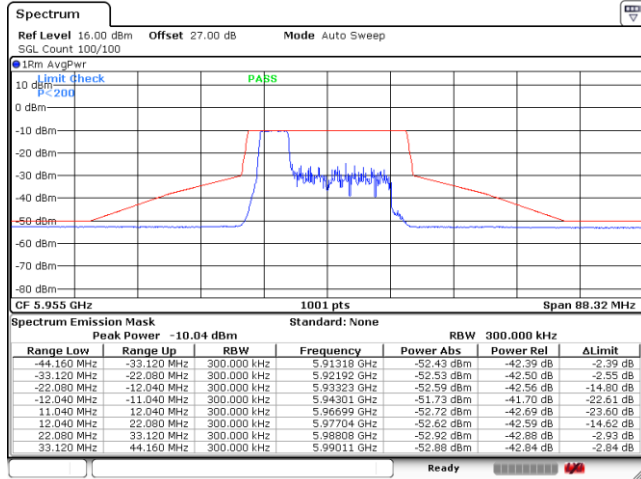

Date: 5.MAY.2023 11:42:11

Plot on Channel 6435 MHz

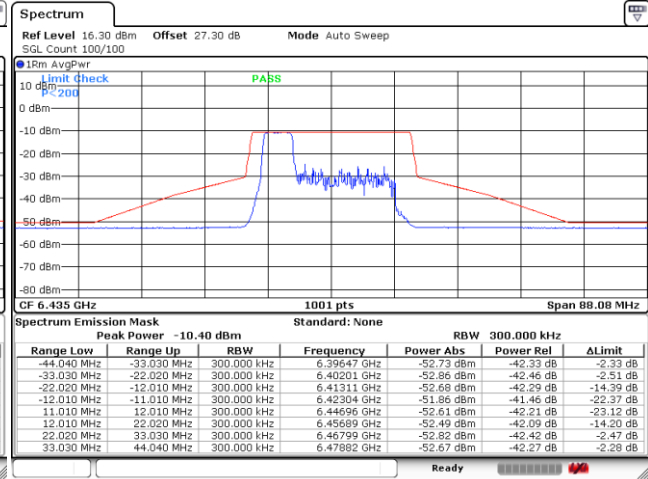

Date: 2.MAY.2023 17:32:36

Plot on Channel 6535 MHz

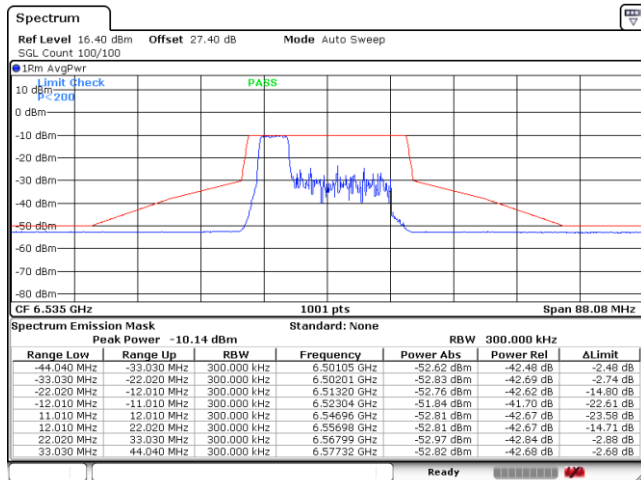

Date: 2.MAY.2023 21:08:12



EUT Mode 802.11be EHT20 52RU38

Plot on Channel 6195 MHz

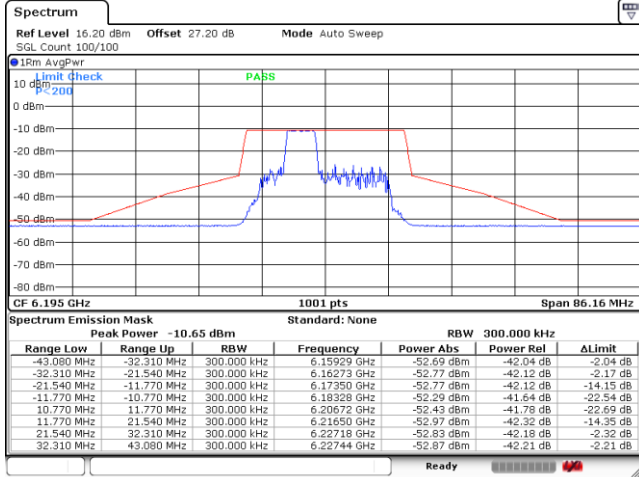

Date: 2.MAY.2023 15:27:26

Plot on Channel 6475 MHz

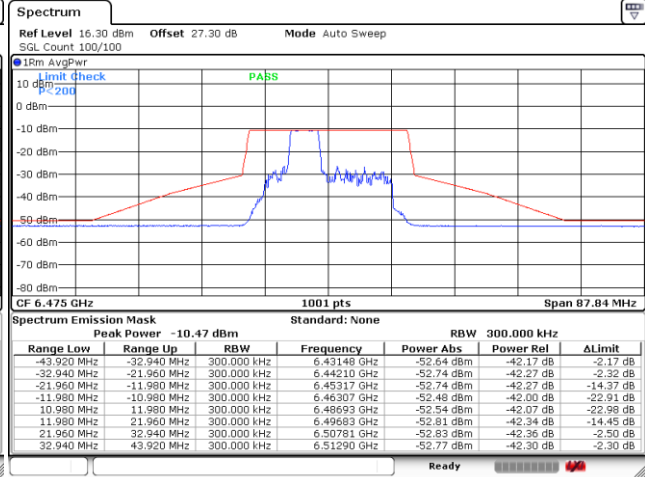

Date: 2.MAY.2023 19:04:33

Plot on Channel 6695 MHz

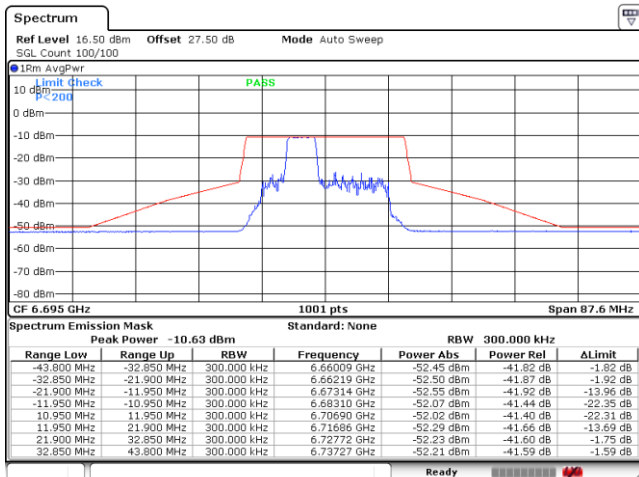

Date: 5.MAY.2023 15:59:07

Plot on Channel 6995 MHz

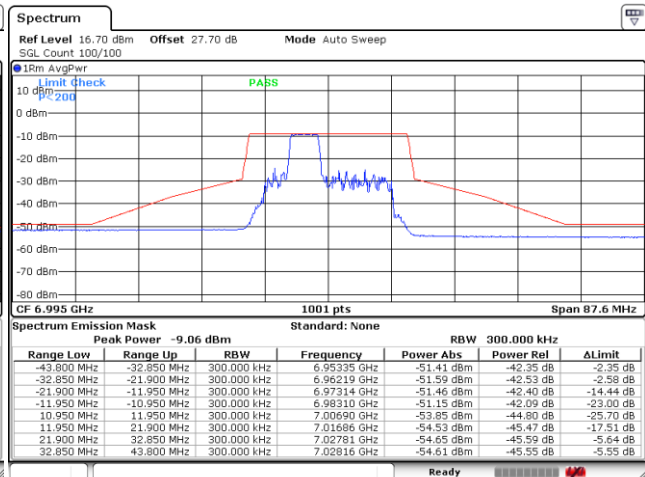

Date: 5.MAY.2023 03:54:55



EUT Mode 802.11be EHT20 52RU40

Plot on Channel 6415 MHz

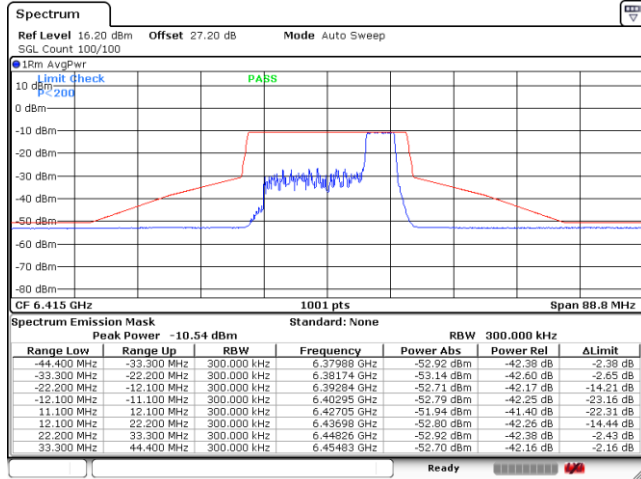

Date: 2.MAY.2023 16:21:19

Plot on Channel 6515 MHz

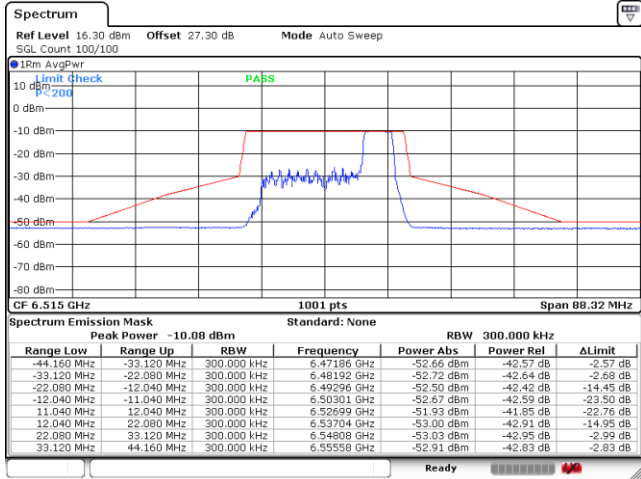

Date: 2.MAY.2023 20:08:07

Plot on Channel 6855 MHz

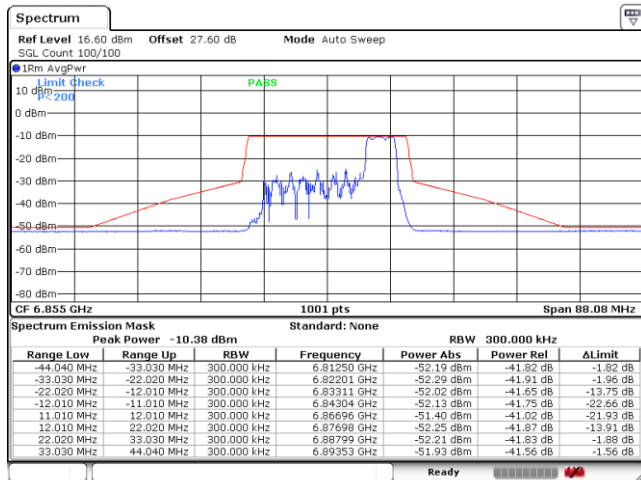

Date: 3.MAY.2023 11:16:01

Plot on Channel 6875 MHz

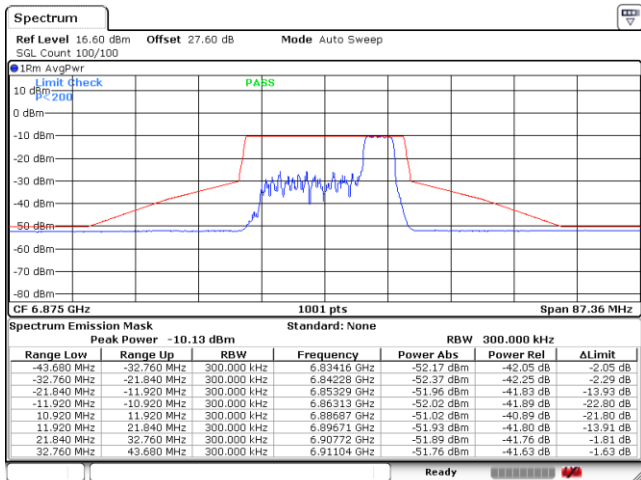

Date: 3.MAY.2023 13:54:17



Plot on Channel 7095 MHz

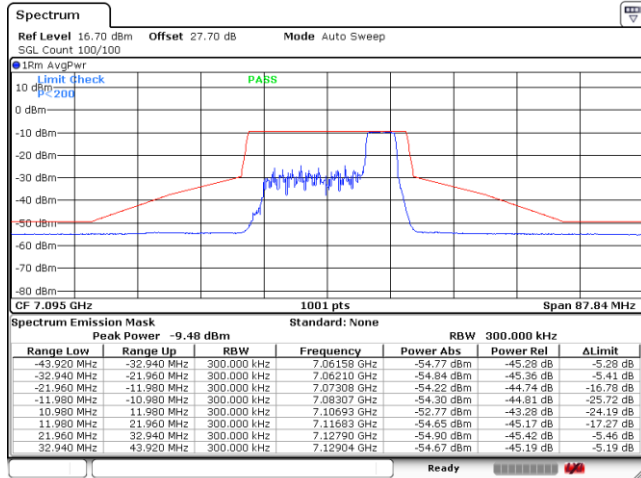

Date: 5.MAY.2023 04:41:33



EUT Mode 802.11be EHT20 106RU53

Plot on Channel 5955 MHz

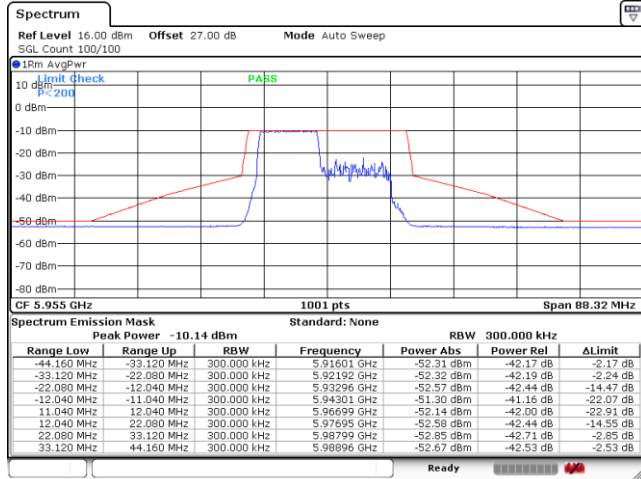

Date: 2.MAY.2023 14:36:09

Plot on Channel 6195 MHz

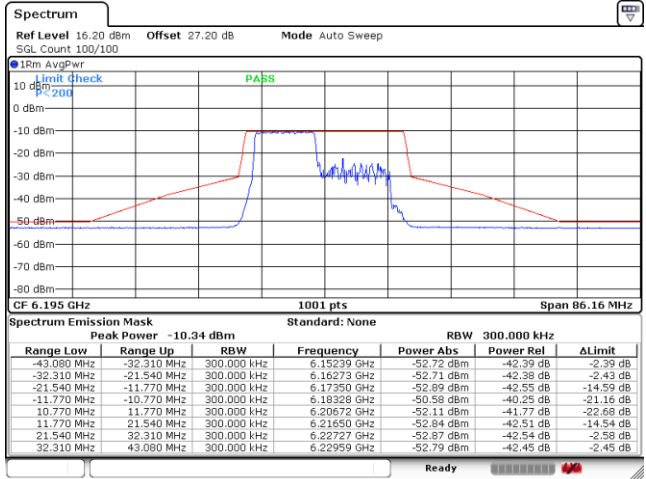

Date: 2.MAY.2023 15:15:06

Plot on Channel 6435 MHz

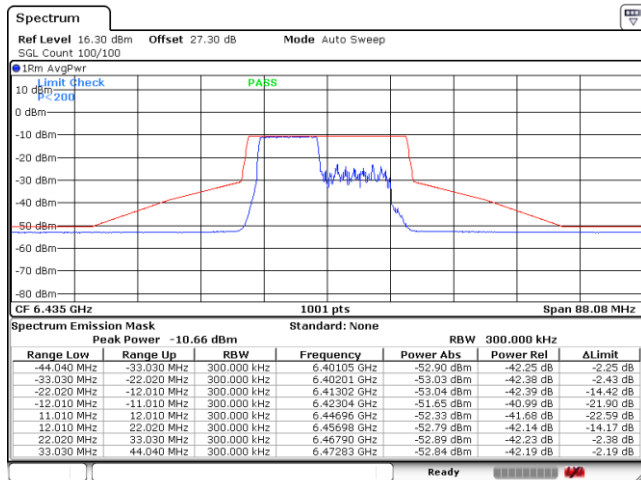

Date: 5.MAY.2023 15:11:09

Plot on Channel 6475 MHz

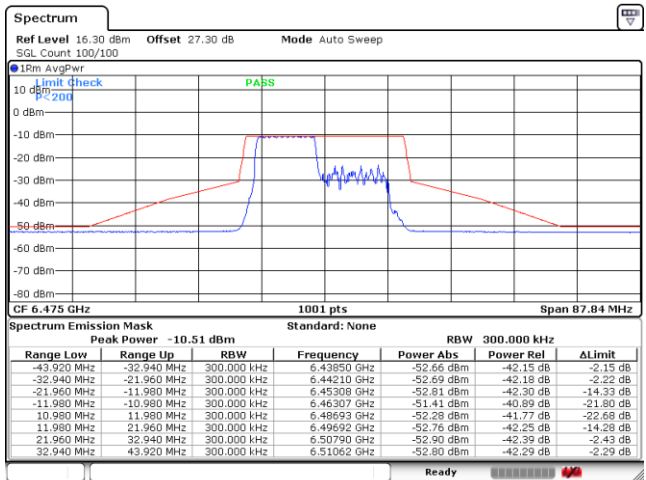

Date: 2.MAY.2023 19:33:15



Plot on Channel 6535 MHz

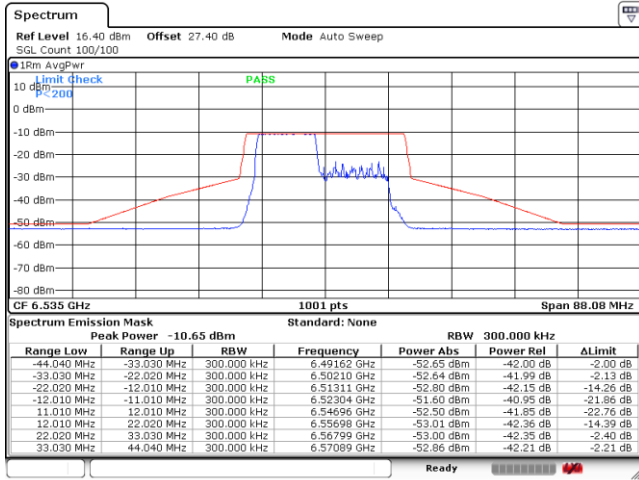

Date: 6.MAY.2023 16:37:05

Plot on Channel 6695 MHz

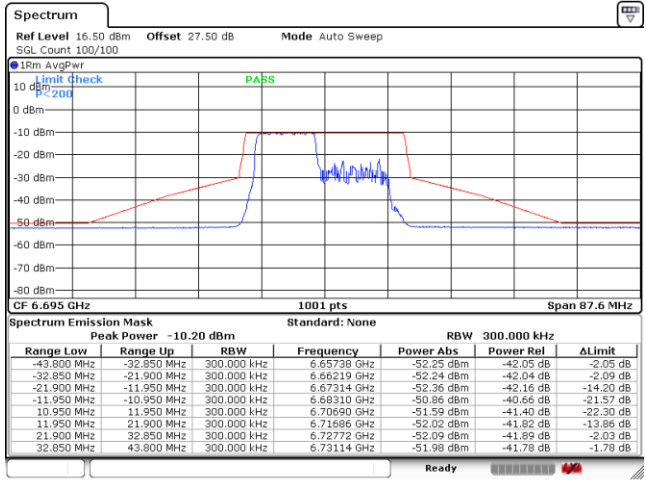

Date: 2.MAY.2023 21:28:38

Plot on Channel 6995 MHz

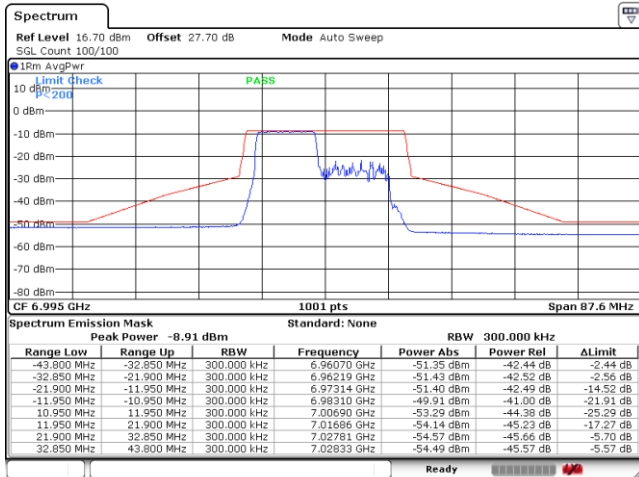

Date: 6.MAY.2023 12:01:00



EUT Mode 802.11be EHT20 106RU54

Plot on Channel 6415 MHz

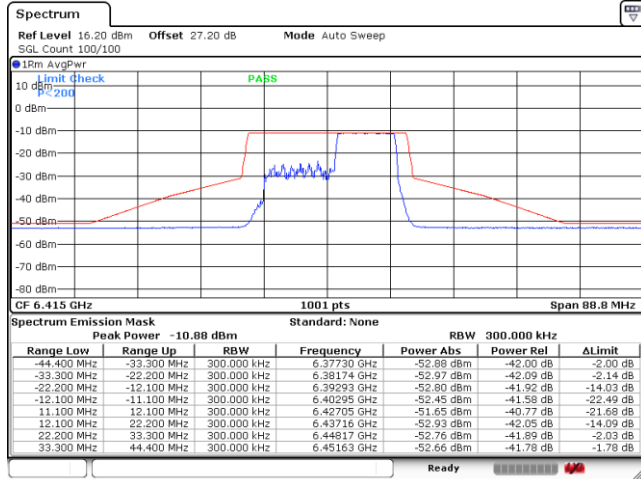

Date: 2.MAY.2023 16:47:08

Plot on Channel 6515 MHz

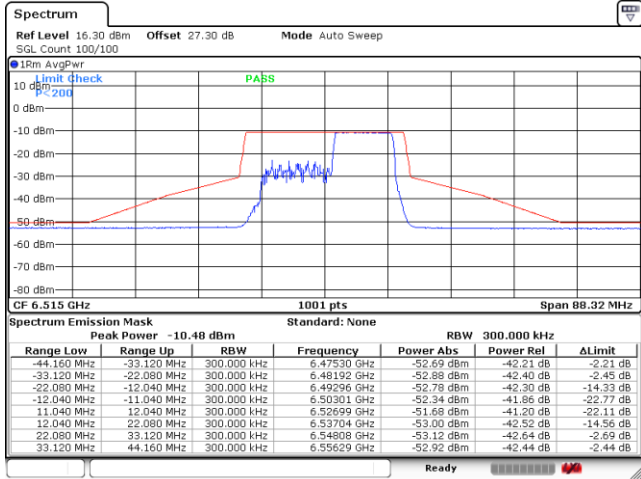

Date: 2.MAY.2023 19:48:46

Plot on Channel 6855 MHz

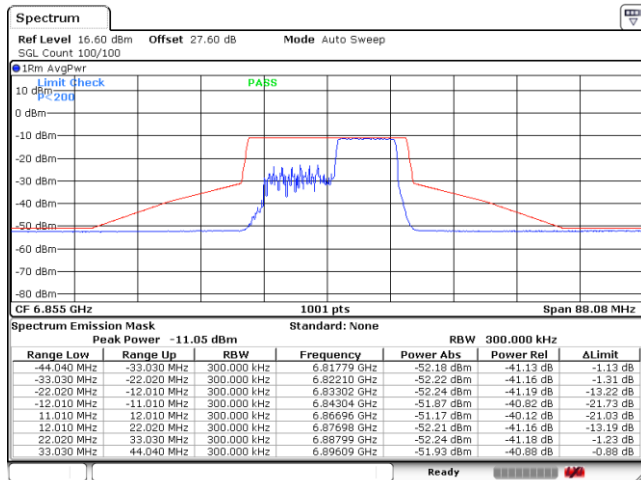

Date: 3.MAY.2023 11:26:09

Plot on Channel 6875 MHz

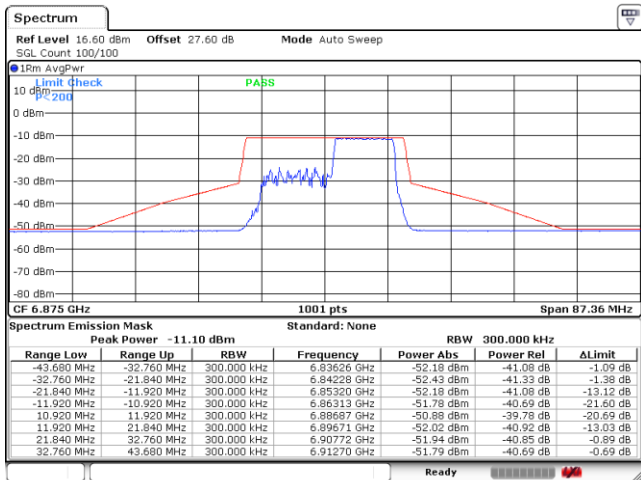

Date: 3.MAY.2023 11:39:35



Plot on Channel 7095 MHz

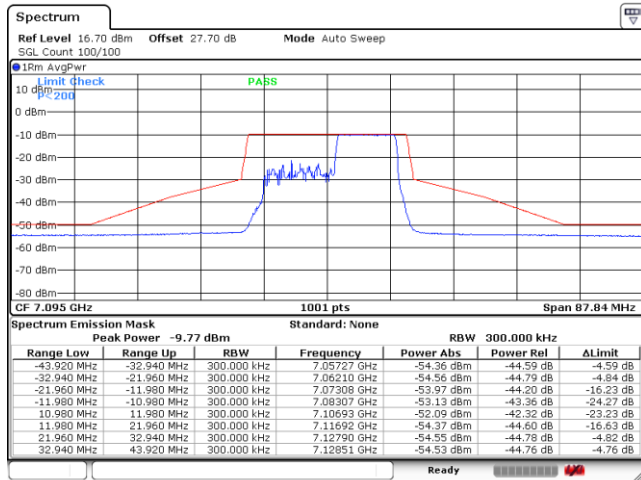

Date: 6.MAY.2023 11:43:36



EUT Mode 802.11be EHT20 MRU 106T+26T82

Plot on Channel 5955 MHz

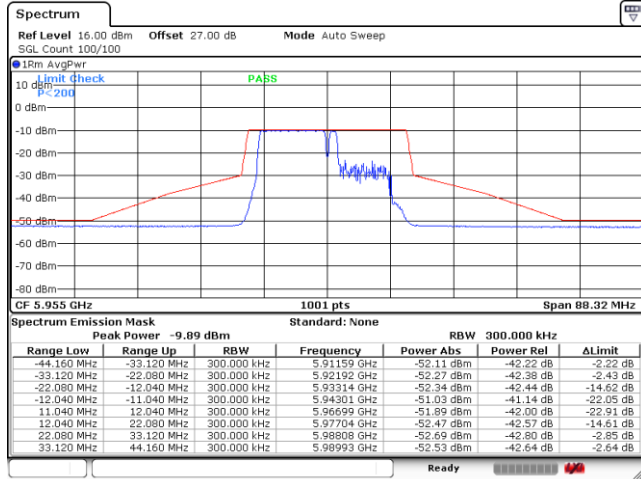

Date: 22.MAY.2023 16:16:14

Plot on Channel 6435 MHz

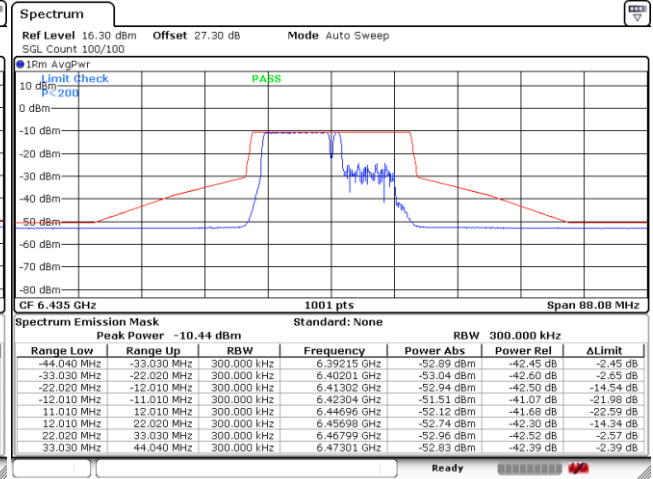

Date: 23.MAY.2023 09:50:29

Plot on Channel 6535 MHz

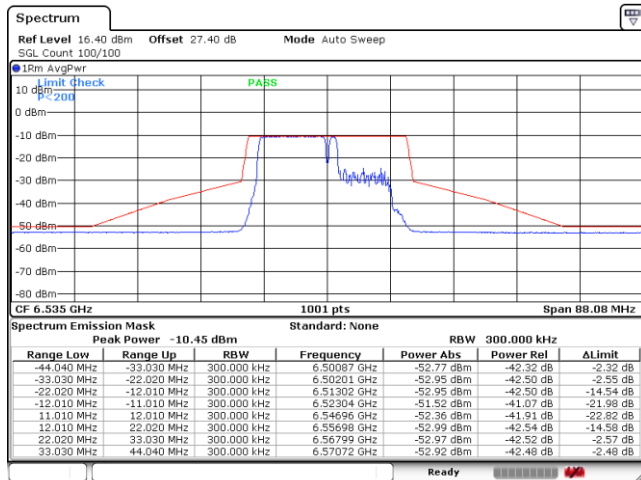

Date: 23.MAY.2023 14:36:39