



FCC RADIO TEST REPORT

FCC ID : A4RG8V0U
Equipment : Phone
Applicant : Google LLC
1600 Amphitheatre Parkway,
Mountain View, California, 94043 USA
Standard : FCC Part 15 Subpart E §15.407

The product was received on Jun. 10, 2021 and testing was performed from Jul. 07, 2021 to Dec. 16, 2022. We, Sporton International Inc. Wensan Laboratory, would like to declare that the tested sample has been evaluated in accordance with the test procedures and has been in compliance with the applicable technical standards.

The test results in this report apply exclusively to the tested model / sample. Without written approval of Sporton International Inc. Wensan Laboratory, the test report shall not be reproduced except in full.

Approved by: Louis Wu

Sporton International Inc. Wensan Laboratory

No.58, Aly. 75, Ln. 564, Wenhua 3rd, Rd., Guishan Dist., Taoyuan City 333010, Taiwan (R.O.C.)



Table of Contents

History of this test report.....	3
Summary of Test Result.....	4
1 General Description	5
1.1 Product Feature of Equipment Under Test.....	5
1.2 Product Specification of Equipment Under Test.....	6
1.3 Modification of EUT	8
1.4 Testing Location	8
1.5 Applicable Standards.....	8
2 Test Configuration of Equipment Under Test	9
2.1 Carrier Frequency and Channel	9
2.2 Test Mode.....	10
2.3 Connection Diagram of Test System.....	11
2.4 Support Unit used in test configuration and system	12
2.5 EUT Operation Test Setup	12
2.6 Measurement Results Explanation Example.....	13
3 Test Result	14
3.1 6dB and 26dB and 99% Occupied Bandwidth Measurement	14
3.2 Maximum E.I.R.P Output Power Measurement	19
3.3 Power Spectral Density Measurement	20
3.4 Unwanted Emissions Measurement.....	26
3.5 AC Conducted Emission Measurement.....	31
3.6 Antenna Requirements	33
4 List of Measuring Equipment.....	34
5 Uncertainty of Evaluation	35
Appendix A. Conducted Test Results	
Appendix B. AC Conducted Emission Test Result	
Appendix C. Radiated Spurious Emission	
Appendix D. Radiated Spurious Emission Plots	
Appendix E. Duty Cycle Plots	
Appendix F. Setup Photographs	



Summary of Test Result

Report Clause	Ref Std. Clause	Test Items	Result (PASS/FAIL)	Remark
3.1	15.407(e)	6dB & 26dB Bandwidth	Pass	-
3.1	2.1049	99% Occupied Bandwidth	Reporting only	-
3.2	15.407(a)	Maximum E.I.R.P Output Power	Pass	-
3.3	15.407(a)	Power Spectral Density	Pass	-
3.4	15.407(b)	Unwanted Emissions	Pass	1.61 dB under the limit at 5895.250 MHz
3.5	15.207	AC Conducted Emission	Pass	6.05 dB under the limit at 0.191 MHz
3.6	15.203	Antenna Requirement	Pass	-

Remark: Except Conducted and Unwanted Emissions test items are carrying out, the FR121931-24A report reuses test data from the FR121931-04E report.

Declaration of Conformity:

1. The test results (PASS/FAIL) with all measurement uncertainty excluded are presented in accordance with the regulation limits or requirements declared by manufacturers. It's means measurement values may risk exceeding the limit of regulation standards, if measurement uncertainty is include in test results.
2. The measurement uncertainty please refer to this report "Uncertainty of Evaluation".

Comments and Explanations:

The product specifications of the EUT presented in the report are declared by the manufacturer who shall take full responsibility for the authenticity.

Reviewed by: William Chen
Report Producer: Cindy Liu



1 General Description

1.1 Product Feature of Equipment Under Test

Product Feature	
Equipment	Phone
FCC ID	A4RG8V0U
EUT supports Radios application	GSM/EGPRS/WCDMA/HSPA/LTE/5G NR/ NFC/GNSS/WPC/WPT/UWB WLAN 11b/g/n HT20 WLAN 11a/n HT20/HT40 WLAN 11ac VHT20/VHT40/VHT80/VHT160 WLAN 11ax HE20/HE40/HE80/HE160 Bluetooth BR/EDR/LE

Remark: The above EUT's information was declared by manufacturer.

EUT Information List	
S/N	Performed Test Item
15291FDEE0000S	RF Conducted Measurement
16061FDEE0000Q	Radiated Spurious Emission
16061FDEE00001	Conducted Emission

1.2 Product Specification of Equipment Under Test

Product Specification is subject to this standard							
Tx/Rx Frequency Range	5850 MHz ~ 5895 MHz						
Maximum Output Power	MIMO <Ant. 7+3> 802.11a: 22.52 dBm / 0.1786W 802.11n HT20: 23.34 dBm / 0.2158 W 802.11n HT40: 22.24 dBm / 0.1675 W 802.11ac VHT20: 23.52 dBm / 0.2249 W 802.11ac VHT40: 22.29 dBm / 0.1694 W 802.11ac VHT80: 20.99 dBm / 0.1256 W 802.11ax HE20: 23.92 dBm / 0.2466 W 802.11ax HE40: 23.11 dBm / 0.2046 W 802.11ax HE80: 21.89 dBm / 0.1545 W						
99% Occupied Bandwidth	MIMO <Ant. 7> 802.11a: 17.78 MHz 802.11ax HE20: 19.78 MHz 802.11ax HE40: 38.26 MHz 802.11ax HE80: 77.20 MHz MIMO <Ant. 3> 802.11a: 17.58 MHz 802.11ax HE20: 19.88 MHz 802.11ax HE40: 38.26 MHz 802.11ax HE80: 77.32 MHz						
Antenna Type / Gain	<Ant. 7> : Slot Antenna with gain -1.9 dBi <Ant. 3> : IFA Antenna with gain -2.1 dBi						
Type of Modulation	802.11a/n : OFDM (BPSK / QPSK / 16QAM / 64QAM) 802.11ac : OFDM (BPSK / QPSK / 16QAM / 64QAM / 256QAM) 802.11ax : OFDMA (BPSK / QPSK / 16QAM / 64QAM / 256QAM / 1024QAM)						
Antenna Function Description	<table border="1"> <thead> <tr> <th></th> <th>Ant. 7</th> <th>Ant. 3</th> </tr> </thead> <tbody> <tr> <td>802.11a/n/ac/ax MIMO</td> <td>V</td> <td>V</td> </tr> </tbody> </table>		Ant. 7	Ant. 3	802.11a/n/ac/ax MIMO	V	V
	Ant. 7	Ant. 3					
802.11a/n/ac/ax MIMO	V	V					

Remark:

1. MIMO Ant. 7+3 Directional Gain is a calculated result from MIMO Ant. 7 and MIMO Ant. 3. The formula used in calculation is documented in section 1.2.1.
2. Power of MIMO Ant. 7 + Ant. 3 is a calculated result from sum of the power MIMO Ant. 7 and MIMO Ant. 3.
3. The EUT's information above is declared by manufacturer. Please refer to Comments and Explanations in report summary.

1.2.1 Antenna Directional Gain

Follows FCC KDB 662911 D01 Multiple Transmitter Output v02r01 F)2)f)ii)

Directional gain = G_{ANT} + Array Gain, where Array Gain is as follows:

For power measurements on IEEE 802.11 devices,

Array Gain = 0 dB (i.e., no array gain) for $N_{ANT} \leq 4$.

G_{ANT} is set equal to the gain of the antenna having the highest gain.

For PSD measurements, the directional gain calculation.

$$DirectionalGain = 10 \cdot \log \left[\frac{\sum_{j=1}^{N_{SS}} \left\{ \sum_{k=1}^{N_{ANT}} g_{j,k} \right\}^2}{N_{ANT}} \right]$$

where

Each antenna is driven by no more than one spatial stream;

N_{SS} = the number of independent spatial streams of data;

N_{ANT} = the total number of antennas

$g_{j,k} = 10^{G_k / 20}$ if the k th antenna is being fed by spatial stream j , or zero if it is not;
 G_k is the gain in dBi of the k th antenna.

As minimum $N_{SS}=1$ is supported by EUT, the formula can be simplified as:

Directional gain = $10 \cdot \log[(10^{G_1 / 20} + 10^{G_2 / 20} + \dots + 10^{G_N / 20})^2 / N_{ANT}]$ dBi

Where G_1, G_2, \dots, G_N denote single antenna gain.

The directional gain "DG" is calculated as following table.

UNII-4			DG	DG
			for	for
	Ant 7 (dBi)	Ant 3 (dBi)	Power (dBi)	PSD (dBi)
	-1.90	-2.10	-1.90	1.01

Calculation example:

If a device has two antenna, $G_{ANT1} = -1.90$ dBi; $G_{ANT2} = -2.10$ dBi

Directional gain of power measurement = $\max(-1.90, -2.10) + 0 = -1.90$ dBi

Directional gain of PSD derived from formula which is

$$10 \times \log \left\{ \left[10^{(-1.90 \text{ dBi} / 20)} + 10^{(-2.10 \text{ dBi} / 20)} \right]^2 / 2 \right\}$$

$$= 1.01 \text{ dBi}$$



1.3 Modification of EUT

No modifications are made to the EUT during all test items.

1.4 Testing Location

Test Site	Sporton International Inc. EMC & Wireless Communications Laboratory
Test Site Location	No.52, Huaya 1st Rd., Guishan Dist., Taoyuan City 333, Taiwan (R.O.C.) TEL: +886-3-327-3456 FAX: +886-3-328-4978
Test Site No.	Sporton Site No. CO05-HY (TAF Code: 1190)
Remark	The Conducted Emission test item subcontracted to Sporton International Inc. EMC & Wireless Communications Laboratory.

Note: The test site complies with ANSI C63.4 2014 requirement.

Test Site	Sporton International Inc. Wensan Laboratory
Test Site Location	No.58, Aly. 75, Ln. 564, Wenhua 3rd, Rd., Guishan Dist., Taoyuan City 333010, Taiwan (R.O.C.) TEL: +886-3-327-0868 FAX: +886-3-327-0855
Test Site No.	Sporton Site No. TH05-HY, 03CH15-HY

Note: The test site complies with ANSI C63.4 2014 requirement.

FCC designation No.: TW1190 and TW3786

1.5 Applicable Standards

According to the specifications of the manufacturer, the EUT must comply with the requirements of the following standards:

- ♦ FCC Part 15 Subpart E
- ♦ FCC KDB 789033 D02 General UNII Test Procedures New Rules v02r01.
- ♦ FCC KDB 414788 D01 Radiated Test Site v01r01.
- ♦ FCC KDB 662911 D01 Multiple Transmitter Output v02r01.
- ♦ FCC KDB 291074 D02 EMC Measurement v01 (Draft)
- ♦ ANSI C63.10-2013

Remark:

1. All the test items were validated and recorded in accordance with the standards without any modification during the testing.
2. The TAF code is not including all the FCC KDB listed without accreditation.



2 Test Configuration of Equipment Under Test

- a. The EUT has been associated with peripherals and configuration operated in a manner tended to maximize its emission characteristics in a typical application. Frequency range investigated: conduction emission (150 kHz to 30 MHz), radiation emission (9 kHz to the 10th harmonic of the highest fundamental frequency or to 40 GHz, whichever is lower). For radiated measurement, the measured emission level of the EUT was maximized by rotating the EUT on a turntable, adjusting the orientation of the EUT and EUT antenna in three orthogonal axis (X: flat, Y: portrait, Z: landscape) and accessory (Adapter or Earphone), and adjusting the measurement antenna orientation, following C63.10 exploratory test procedures and only the worst case emissions were reported in this report.

- b. AC power line Conducted Emission was tested under maximum output power.

2.1 Carrier Frequency and Channel

Frequency Band	Bandwidth	Channel	Frequency (MHz)	Note
5850-5895 MHz (U-NII-4)	20 MHz	169	5845	Straddle
		173	5865	
		177	5885	
	40 MHz	167	5835	Straddle
		175	5875	
	80 MHz	171	5855	Straddle

Note: The channel noted with “straddle” spans 5.725-5.850 GHz and 5.850-5.895 GHz.



2.2 Test Mode

This device support 26/52/106/242/484/996-tone RU.

The PSD of partial RU is reduced to be smaller than full RU according to TCB workshop interim guidance Oct. 2018.

The 802.11ax mode is investigated among different tones, full resource units (RU), partial resource units. The partial RU has no higher power than full RU's, thus the full RU is chosen as main test configuration.

The 242-tone RU is covered by 20MHz channel, 484-tone RU is covered by 40MHz channel and 996-tone RU is covered by 80MHz channel.

The SISO mode conducted power is covered by MIMO mode per chain, so only the MIMO mode is tested.

The power for 802.11n and 802.11ac mode is smaller than 802.11ax mode, so all other conducted and radiated test is covered by 802.11ax mode.

The final test modes include the worst data rates for each modulation shown in the table below.

MIMO Mode

Specification	MCS index /Data Rate
802.11a	6 Mbps
802.11n HT20 (Covered by HE20)	MCS0
802.11n HT40 (Covered by HE40)	MCS0
802.11ac VHT20 (Covered by HE20)	MCS0
802.11ac VHT40 (Covered by HE40)	MCS0
802.11ac VHT80 (Covered by HE80)	MCS0
802.11ax HE20	MCS0
802.11ax HE40	MCS0
802.11ax HE80	MCS0

Remark: The conducted power level of each chain in MIMO mode is equal or higher than SISO mode.

Test Cases	
AC Conducted Emission	Mode 1 : WLAN (5GHz) Link + Bluetooth Link + USB Cable 1 (Charging from AC Adapter 2)
Remark: 1. For Radiated Test Cases, the tests were performed with Adapter 2 and USB Cable 1. 2. During the preliminary test, both charging modes (Adapter mode and WPT Charging mode) were verified. It is determined that the adaptor mode is the worst case for official test.	

Ch. #		RF test channel of UNII-4 and UNII-3 & 4 span channels			
		802.11a	802.11ax HE20	802.11ax HE40	802.11ax HE80
L	Low	169	169	167	-
M	Middle	173	173	-	171
H	High	177	177	175	-

Remark: For radiation spurious emission, the modulation and the data rate picked for testing are determined by the Max. RF conducted power.

2.3 Connection Diagram of Test System

<AC Conducted Emission Mode>

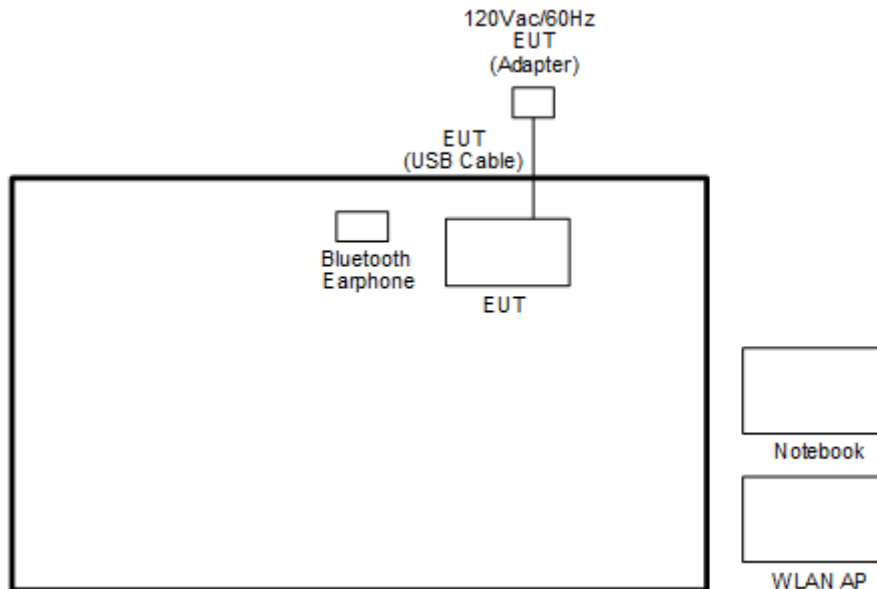

<WLAN Tx Mode>

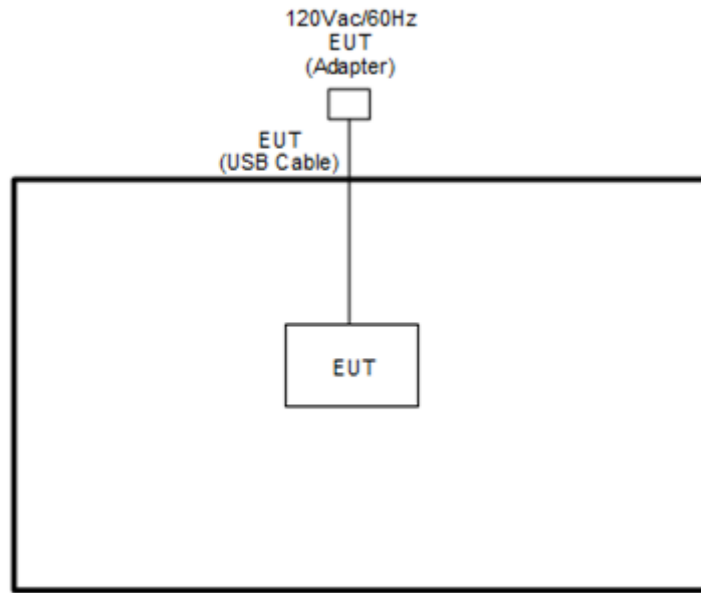

2.4 Support Unit used in test configuration and system

Item	Equipment	Brand Name	Model Name	FCC ID	Data Cable	Power Cord
1.	Bluetooth Earphone	Google	G1007, G1008	A4RG1008 A4RG1007	N/A	N/A
2.	WLAN AP	ASUS	RT-AC66U	MSQ-RTAC66U	N/A	Unshielded, 1.8 m
3.	Notebook	Dell	Latitude 3400	FCC DoC	N/A	AC I/P : Unshielded, 1.2m DC O/P : Shielded, 1.8m

2.5 EUT Operation Test Setup

The RF test items, utility “CMD v.10.0.18362.1256” was installed in Notebook which was programmed in order to make the EUT get into the engineering modes to provide channel selection, power level, data rate and the application type and for continuous transmitting signals.



2.6 Measurement Results Explanation Example

For all conducted test items:

The offset level is set in the spectrum analyzer to compensate the RF cable loss and attenuator factor between EUT conducted output port and spectrum analyzer. With the offset compensation, the spectrum analyzer reading level is exactly the EUT RF output level.

Example :

The spectrum analyzer offset is derived from RF cable loss and attenuator factor.

Offset = RF cable loss + attenuator factor.

Following shows an offset computation example with cable loss 4.2 dB and 10 dB attenuator.

$$\begin{aligned} \text{Offset(dB)} &= \text{RF cable loss(dB)} + \text{attenuator factor(dB)}. \\ &= 4.2 + 10 = 14.2 \text{ (dB)} \end{aligned}$$

3 Test Result

3.1 6dB and 26dB and 99% Occupied Bandwidth Measurement

3.1.1 Description of 6dB and 26dB and 99% Occupied Bandwidth

The minimum 6 dB bandwidth shall be at least 500 kHz.

26dB and 99% Occupied bandwidth are reporting only.

3.1.2 Measuring Instruments

See list of measuring equipment of this test report.

3.1.3 Test Procedures

The testing follows FCC KDB 291074 D02 EMC Measurement v01 (Draft) Section 2.11 Minimum Emission bandwidth

1. Set RBW = 100 kHz.
2. Set the VBW $\geq 3 \times$ RBW.
3. Detector = Peak.
4. Trace mode = max hold
5. Measure the maximum width of the emission that is 6 dB down from the peak of the emission.
6. Measure and record the results in the test report.

3.1.4 Test Setup

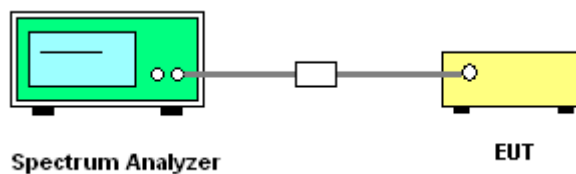

3.1.5 Test Result of 6dB and 26dB and 99% Occupied Bandwidth

Please refer to Appendix A.



MIMO <Ant. 7+3>

<802.11a Mode>

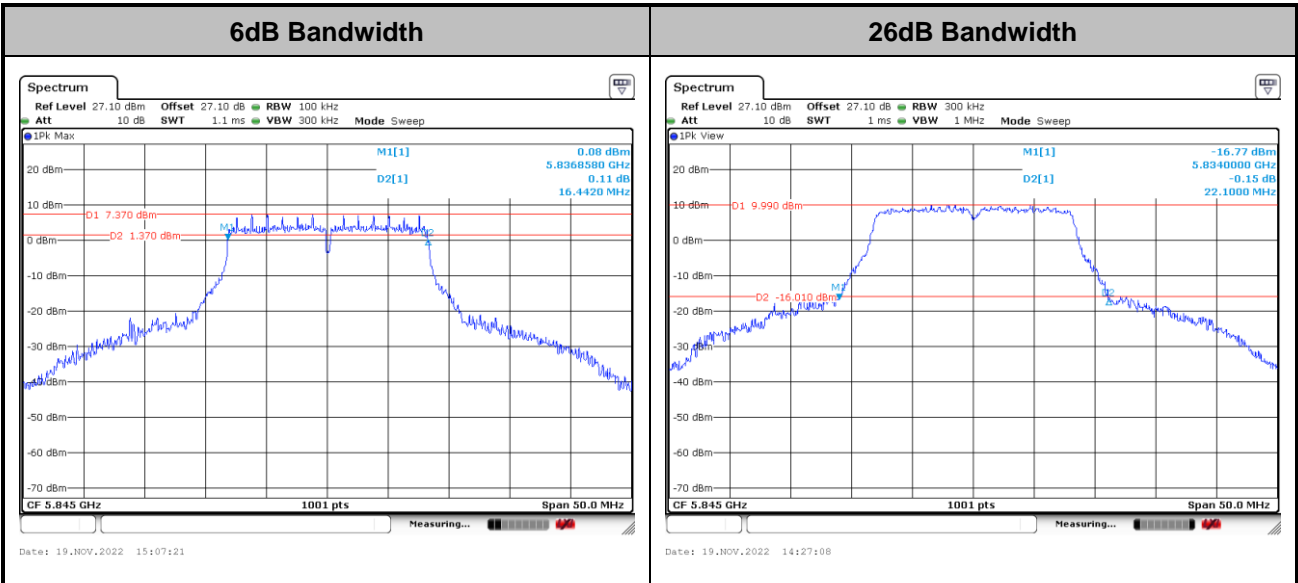

Occupied Bandwidth

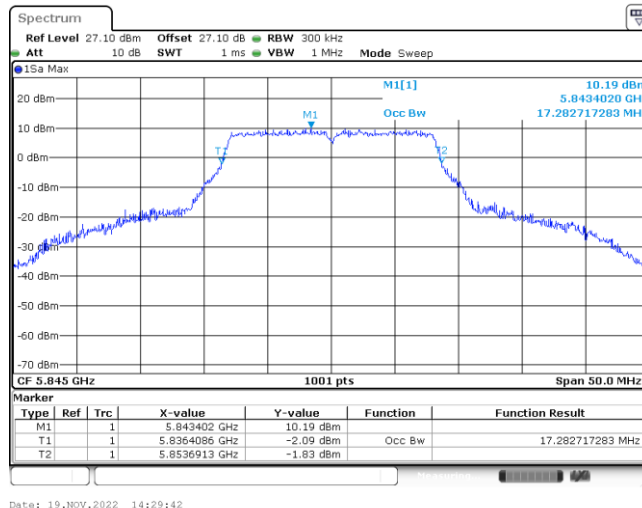

Note: The occupied channel bandwidth is maintained within the band of operation.



<802.11ax HE20 Mode>

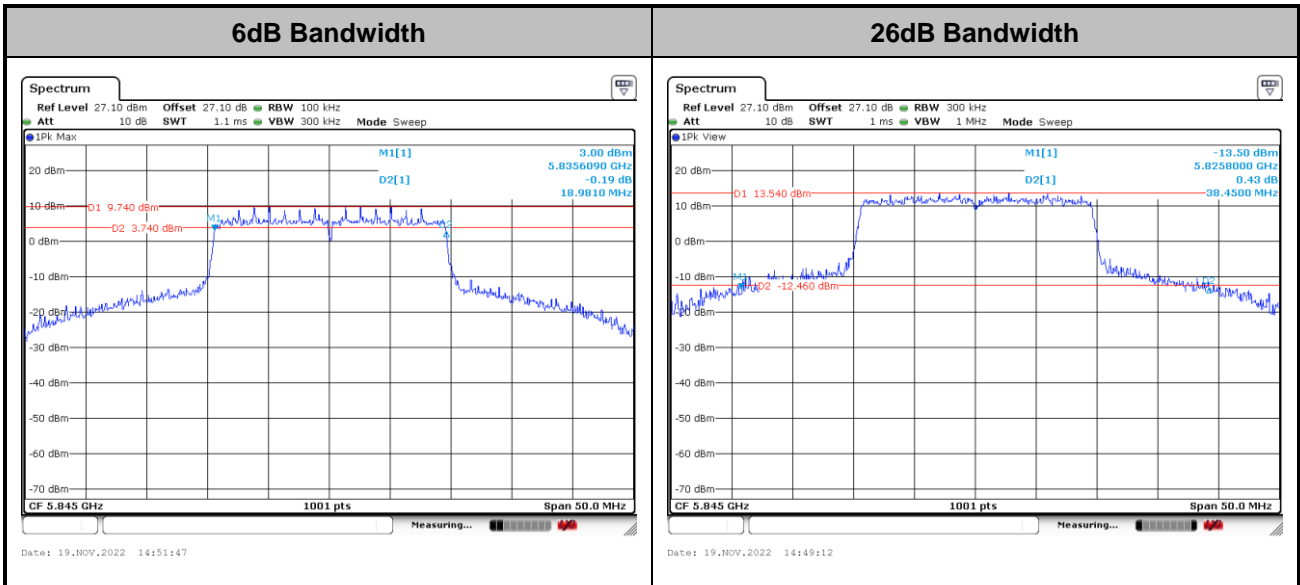

Occupied Bandwidth

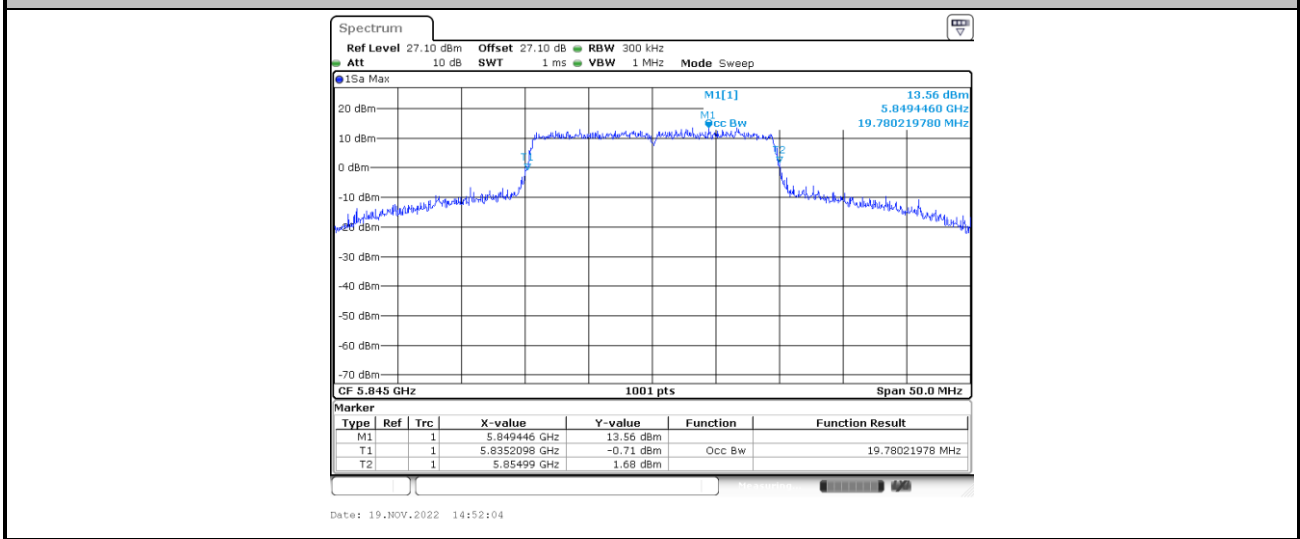

Note: The occupied channel bandwidth is maintained within the band of operation.



<802.11ax HE40 Mode>

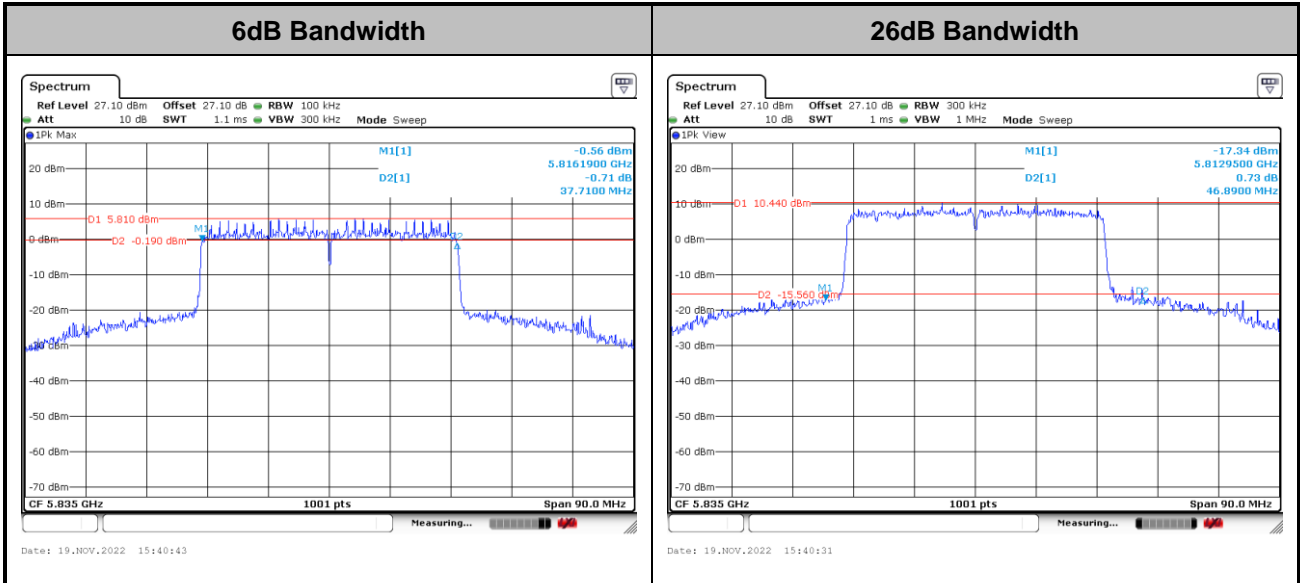

Occupied Bandwidth

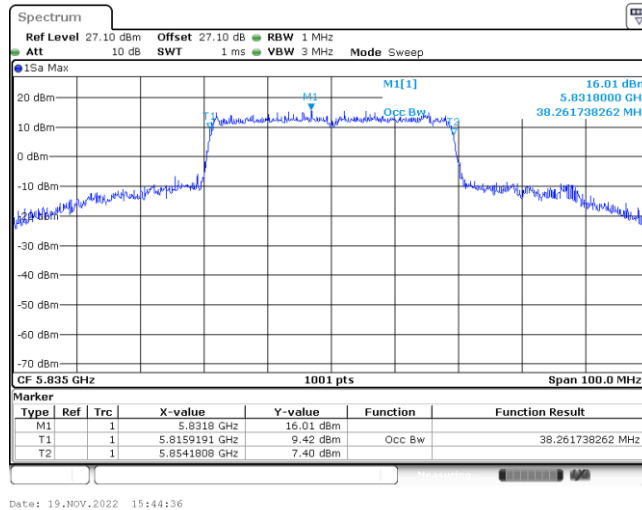

Note: The occupied channel bandwidth is maintained within the band of operation.



<802.11ax HE80 Mode>

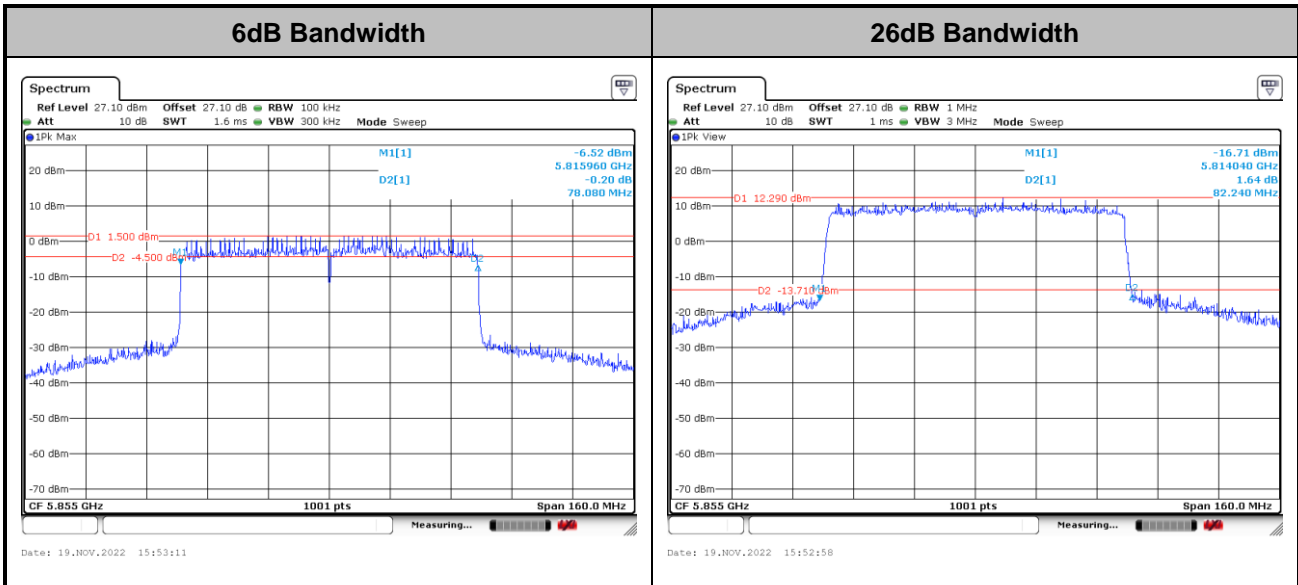

Occupied Bandwidth

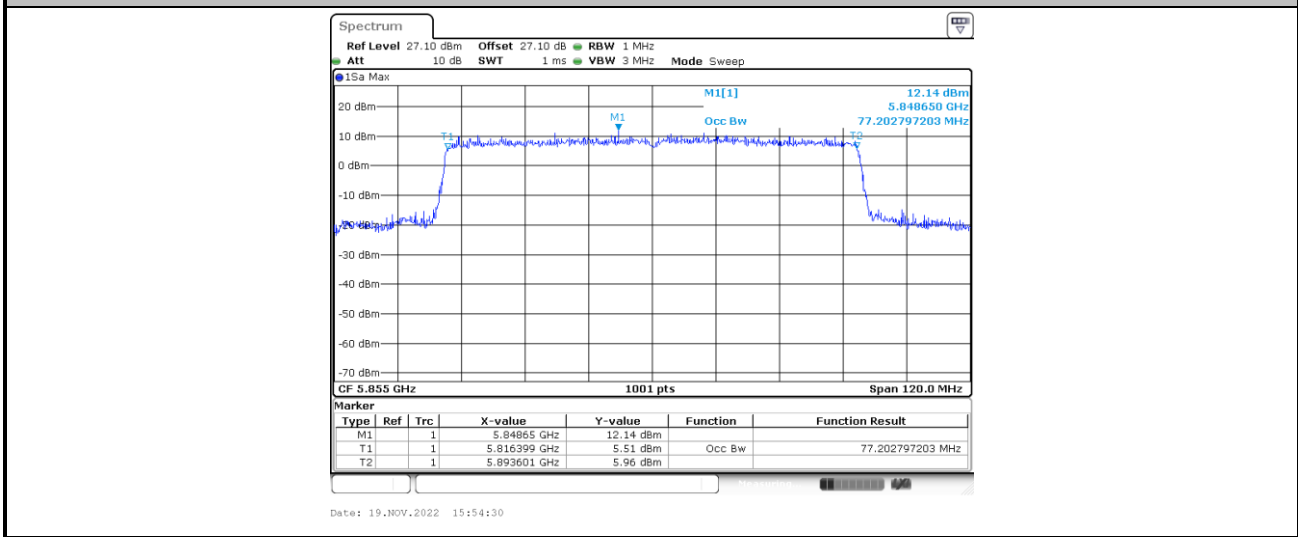

Note: The occupied channel bandwidth is maintained within the band of operation.

3.2 Maximum E.I.R.P Output Power Measurement

3.2.1 Limit of Maximum E.I.R.P Output Power

For client devices operating under the control of an indoor access point in the 5.850-5.895 GHz band, the maximum power spectral density must not exceed 14 dBm e.i.r.p. in any 1-megahertz band, and the maximum e.i.r.p. over the frequency band of operation must not exceed 30 dBm. Client devices operating on a channel that spans the 5.725-5.850 GHz and 5.850-5.895 GHz bands must not exceed an e.i.r.p. of 30 dBm.

3.2.2 Measuring Instruments

See list of measuring equipment of this test report.

3.2.3 Test Procedures

The testing follows Method PM-G of FCC KDB 789033 D02 General UNII Test Procedures New Rules v02r01.

Method PM-G (Measurement using a gated RF average power meter):

1. Measurement is performed using a wideband RF power meter.
2. The EUT is configured to transmit at its maximum power control level.
3. Measure the average power of the transmitter.
4. Since the measurement is made only during the ON time of the transmitter, no duty cycle correction factor is required.
5. For MIMO mode, calculation method follows FCC KDB 662911 D01 Multiple Transmitter Output v02r01.

3.2.4 Test Setup

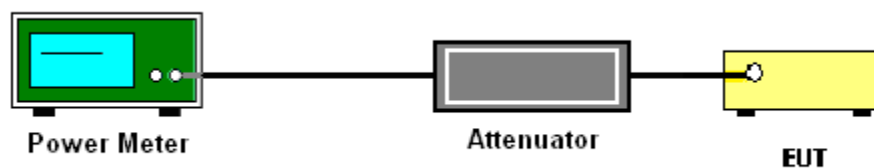

3.2.5 Test Result of Maximum Conducted Output Power

Please refer to Appendix A.



3.3 Power Spectral Density Measurement

3.3.1 Limit of Power Spectral Density

1. For client devices operating under the control of an indoor access point in the 5.850-5.895 GHz band, the maximum power spectral density must not exceed 14 dBm e.i.r.p. in any 1-megahertz band
2. For client devices operating on a channel that spans the 5.725-5.850 GHz and 5.850-5.895 GHz bands shall meet both 15.407(a)(3)(i) 30dBm/500kHz and 15.407(a)(3)(iii) 14dBm/MHz limit, where the stringent limit 14dBm/MHz is applied.

3.3.2 Measuring Instruments

See list of measuring equipment of this test report.

3.3.3 Test Procedures

The testing follows FCC KDB 789033 D02 General UNII Test Procedures New Rules v02r01. Section F) Maximum power spectral density.

Method SA-2

(trace averaging across on and off times of the EUT transmissions, followed by duty cycle correction).

- Measure the duty cycle.
 - Set span to encompass the entire emission bandwidth (EBW) of the signal.
 - Set RBW = 1 MHz.
 - Set VBW \geq 3 MHz.
 - Number of points in sweep \geq 2 Span / RBW.
 - Sweep time = auto.
 - Detector = RMS
 - Trace average at least 100 traces in power averaging mode.
 - Add $10 \log(1/x)$, where x is the duty cycle, to the measured power in order to compute the average power during the actual transmission times. For example, add $10 \log(1/0.25) = 6$ dB if the duty cycle is 25 percent.
1. The RF output of EUT is connected to the spectrum analyzer by a low loss cable.
 2. Each plot has already offset with cable loss, and attenuator loss. Measure the PPSD and record it.
 3. For MIMO mode, calculation method follows FCC KDB 662911 D01 Multiple Transmitter Output v02r01.

Method (a): Measure and sum the spectra across the outputs.

The total final Power Spectral Density is from a device with 2 transmitter outputs. The spectrum measurements of the individual outputs are all performed with the same span and number of points; the spectrum value in the first spectral bin of output 1 is summed with that in the first spectral bin of output 2 to obtain the value for the first frequency bin of the summed spectrum.

3.3.4 Test Setup

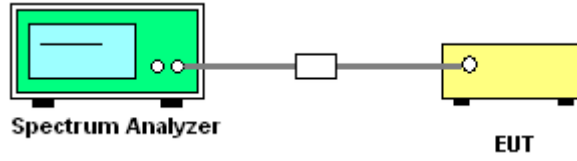

3.3.5 Test Result of Power Spectral Density

Please refer to Appendix A.



<802.11a Mode>

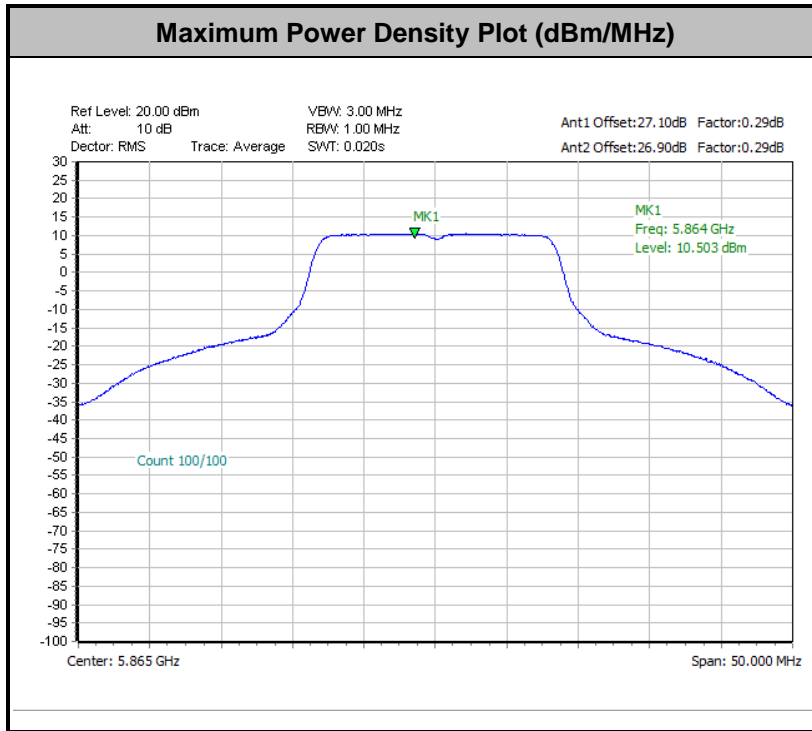

Remark: The test plot is showing a bin by bin combined result mathematically adds two traces.

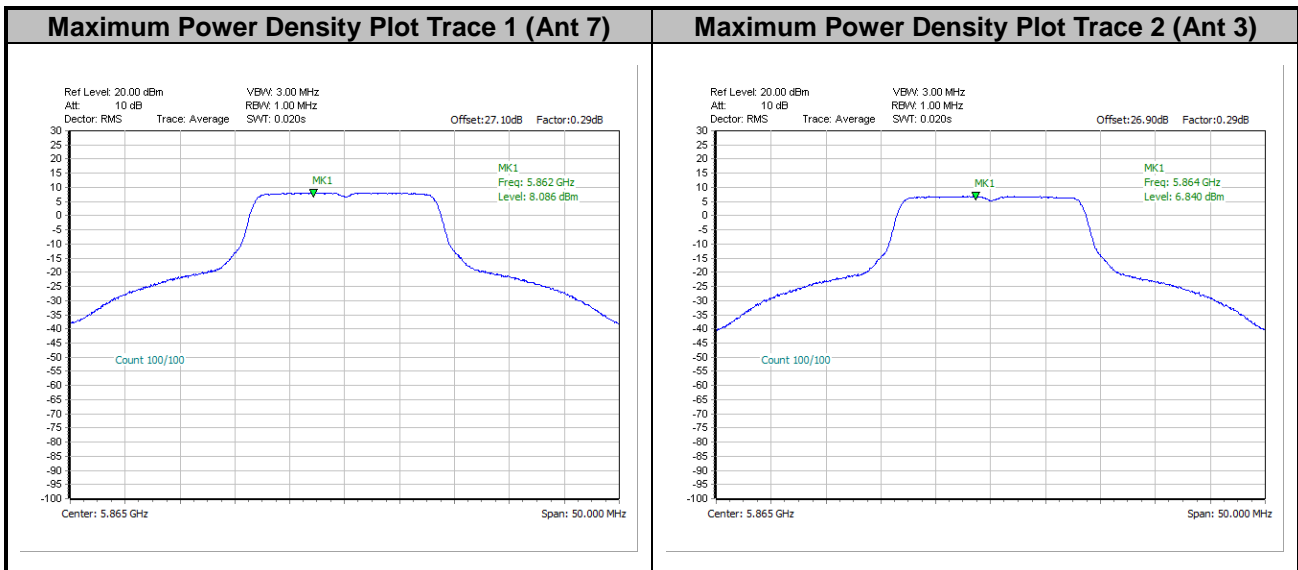



<802.11ax HE20 Mode>

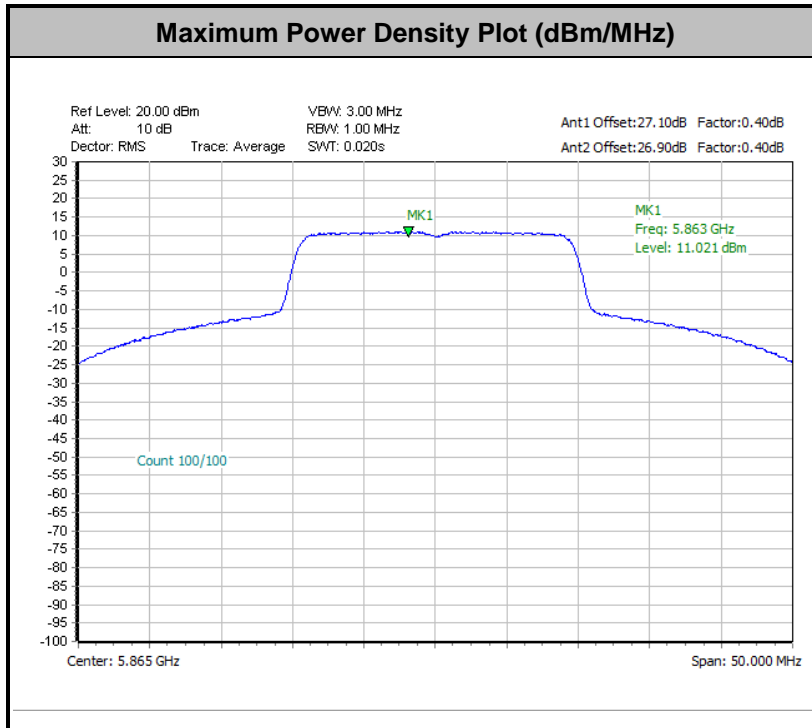

Remark: The test plot is showing a bin by bin combined result mathematically adds two traces.

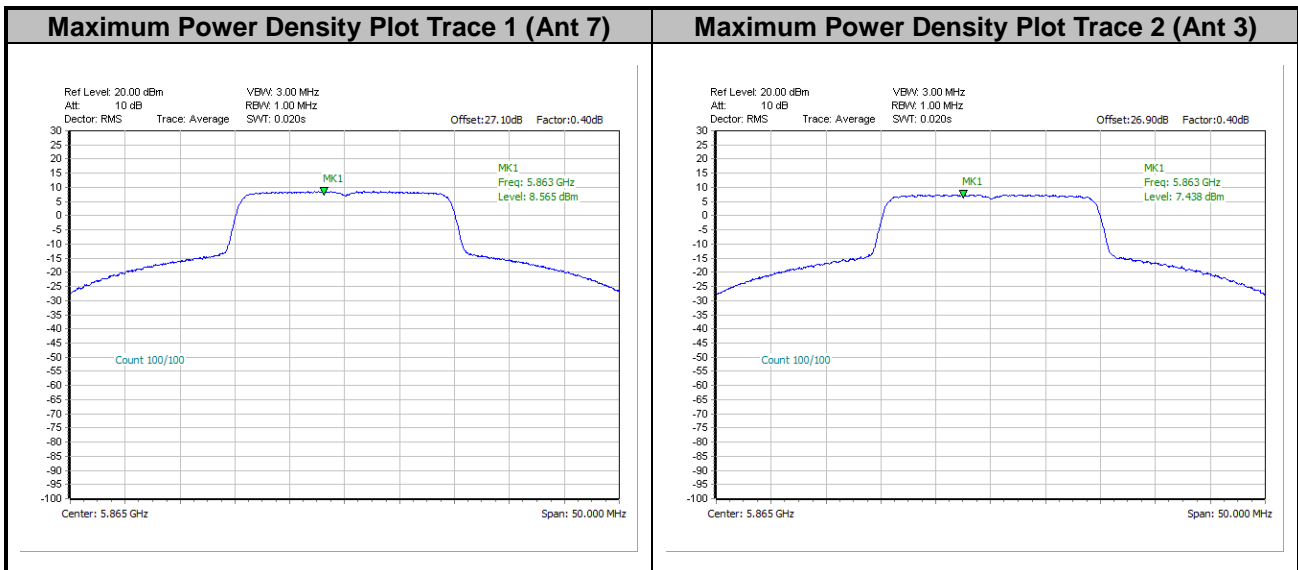



<802.11ax HE40 Mode>

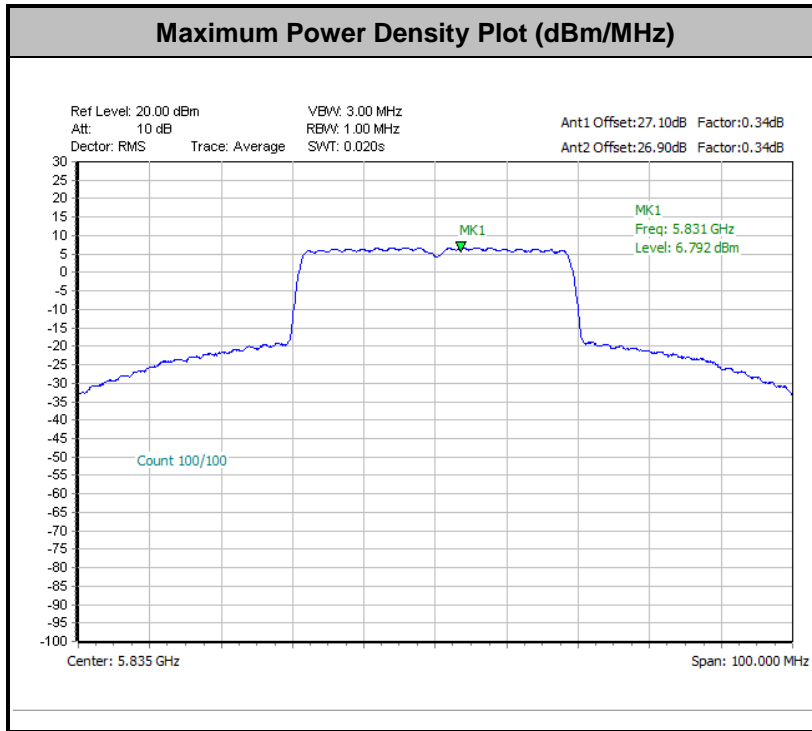

Remark: The test plot is showing a bin by bin combined result mathematically adds two traces.

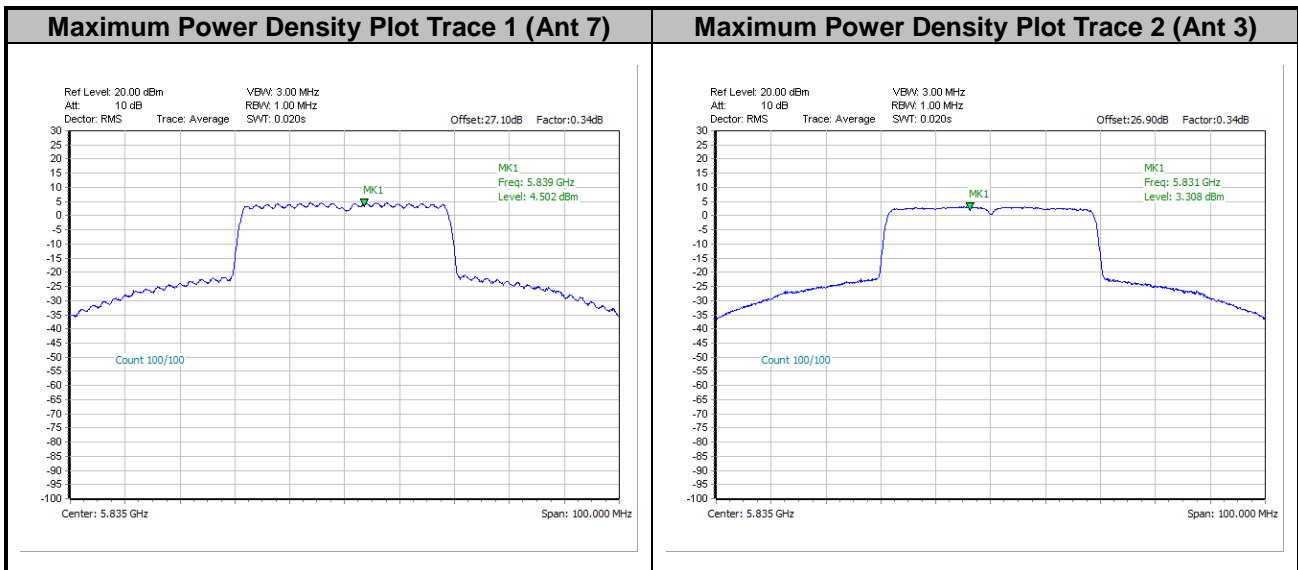



<802.11ax HE80 Mode>

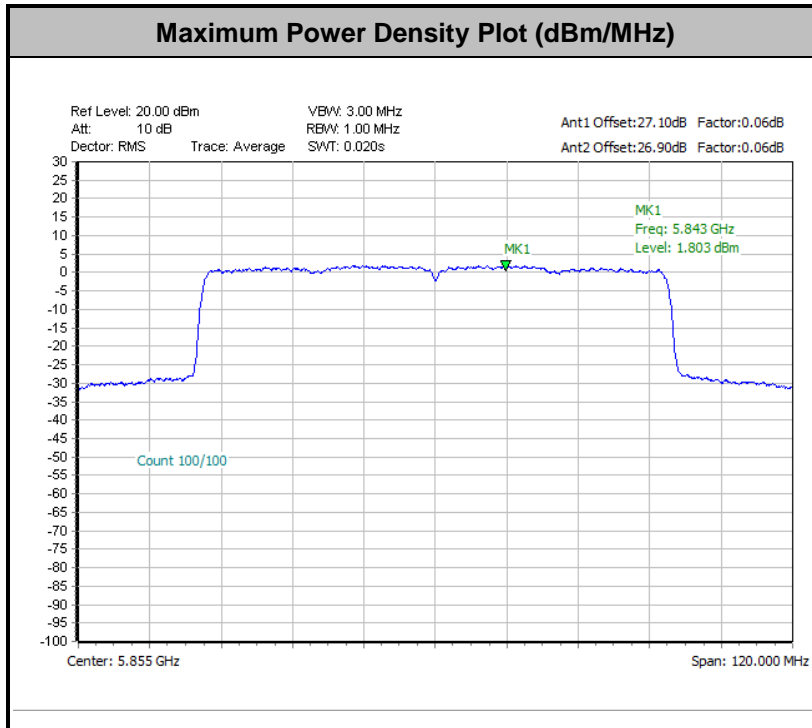

Remark: The test plot is showing a bin by bin combined result mathematically adds two traces.

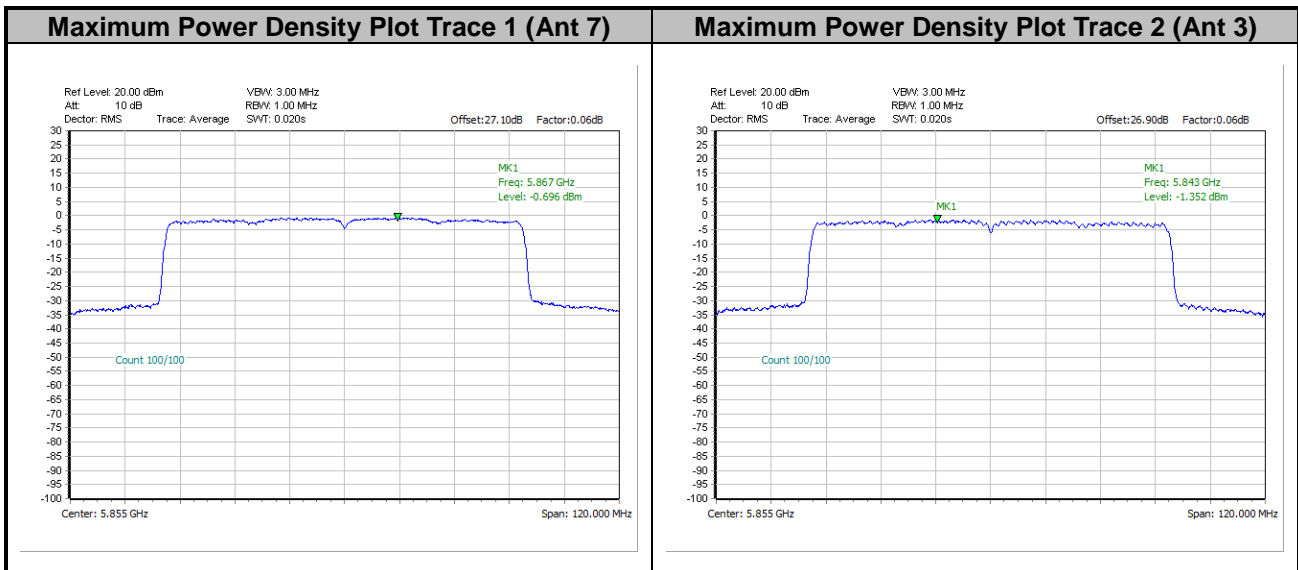



3.4 Unwanted Emissions Measurement

This section is to measure unwanted emissions through radiated measurement for band edge spurious emissions and out of band emissions measurement.

3.4.1 Limit of Unwanted Emissions

(1) Unwanted spurious emissions fallen in restricted bands shall comply with the general field strength limits as the following table:

Frequency (MHz)	Field Strength (microvolts/meter)	Measurement Distance (meters)
0.009 – 0.490	2400/F(kHz)	300
0.490 – 1.705	24000/F(kHz)	30
1.705 – 30.0	30	30
30 – 88	100	3
88 – 216	150	3
216 - 960	200	3
Above 960	500	3

Note: The following formula is used to convert the EIRP to field strength.

$$E = \frac{1000000\sqrt{30P}}{3} \text{ } \mu\text{V/m, where P is the eirp (Watts)}$$

(2) For transmitters operating solely in the 5.850-5.895 GHz band or operating on a channel that spans across 5.725-5.895 GHz:

15.407(b)(5)(i), all emissions at or above 5.895 GHz shall not exceed an e.i.r.p. of 15 dBm/MHz and shall decrease linearly to an e.i.r.p. of -7 dBm/MHz at or above 5.925 GHz.

All emissions below 5.725 GHz shall not exceed an e.i.r.p. of -27 dBm/MHz at 5.65 GHz increasing linearly to 10 dBm/MHz at 5.7 GHz, and from 5.7 GHz increasing linearly to a level of 15.6 dBm/MHz at 5.72 GHz, and from 5.72 GHz increasing linearly to a level of 27 dBm/MHz at 5.725 GHz.

(3) KDB789033 D02 v02r01 G)2)c)

Use guidance in KDB Publication 789033 for all measurements. Unwanted emissions outside of restricted bands are measured with an RMS detector. In addition, 15.35(b) applies where the peak emissions must be limited to no more than 20 dB above the average limit.

Unwanted band-edge emissions may be measured using the integration method as described in KDB Publication 789033 3. d) (ii). Emissions below 5725 MHz should be measured using peak-detection while emission above 5895 MHz should be measured using average.



Frequency(GHz)	EIRP (dBm)	Field Strength @3m distance (dBuV/m)	Note
Below 5.65	-27dBm/MHz	68.2	Peak
5.7	10dBm/MHz	105.2	Peak
5.72	15.6dBm/MHz	110.8	Peak
5.725	27dBm/MHz	122.2	Peak
5.895	-5dBm/MHz	90.2	Average
5.895	15dBm/MHz	110.2	Peak
Above 5.925	-27dBm/MHz	68.2	Average
Above 5.925	-7dBm/MHz	88.2	Peak

Note: Field strength at 3 m distance is converted to EIRP as the following equation:
 $EIRP[dBm] = E[dB\mu V/m] - 95.2$

3.4.2 Measuring Instruments

See list of measuring equipment of this test report.

3.4.3 Test Procedures

- The testing follows FCC KDB 789033 D02 General UNII Test Procedures New Rules v02r01. Section G) Unwanted emissions measurement.
 - Procedure for Unwanted Emissions Measurements Below 1000 MHz
 - RBW = 120 kHz
 - VBW = 300 kHz
 - Detector = Peak
 - Trace mode = max hold
 - Procedure for Peak Unwanted Emissions Measurements Above 1000 MHz
 - RBW = 1 MHz
 - VBW ≥ 3 MHz
 - Detector = Peak
 - Sweep time = auto
 - Trace mode = max hold
 - Procedures for Average Unwanted Emissions Measurements Above 1000 MHz
 - RBW = 1 MHz
 - VBW = 10 Hz, when duty cycle is no less than 98 percent.
 - VBW ≥ 1/T, when duty cycle is less than 98 percent where T is the minimum transmission duration over which the transmitter is on and is transmitting at its maximum power control level for the tested mode of operation.

2. The EUT was placed on a turntable with 0.8 meter for frequency below 1 GHz and 1.5 meter for frequency above 1 GHz respectively above ground.
3. The EUT was placed at distance 3 meter from measurement antenna which was mounted on the top of a variable height antenna tower.
4. The measurement antenna is a broadband antenna and its height is adjusted between one meter and four meters above ground to find the maximum value of the field strength for both horizontal polarization and vertical polarization.
5. For each suspected emission, the EUT was arranged to its worst case and then adjust the antenna tower (from 1 m to 4 m) and turntable (from 0 degree to 360 degrees) to find the maximum reading.
6. Radiated testing below 1GHz was performed by adjusting the antenna tower from 1m to 4m and by rotating the turn table from 0 degree to 360 degree to find the peak maximum hold reading. When there is no suspected emission found and the emission level is with at least 6dB margin against QP limit line, the position is marked as “-“.
7. Radiated testing above 1GHz was performed by adjusting the antenna tower from 1m to 4m and by rotating the turn table from 0 degree to 360 degree to find the peak maximum hold reading for scanning all frequencies. When there is no suspected emission found and the harmonic emission level is with at least 6dB margin against average limit line, the position is marked as “-“.

3.4.4 Test Setup

For radiated emissions below 30MHz

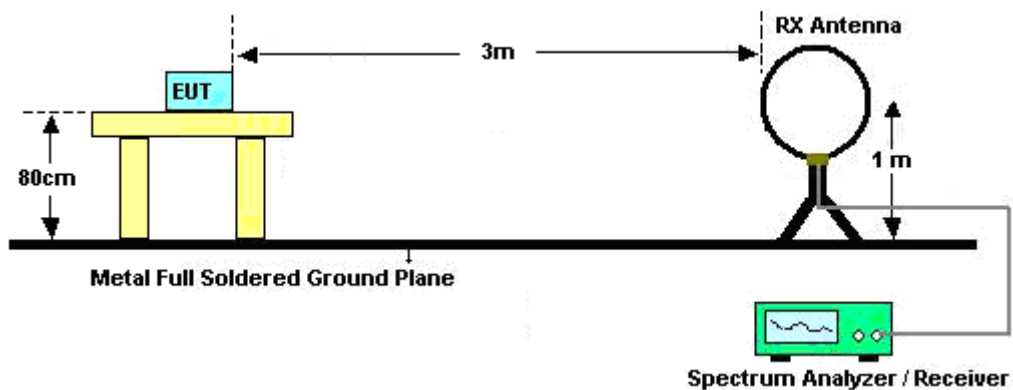

For radiated emissions from 30MHz to 1GHz

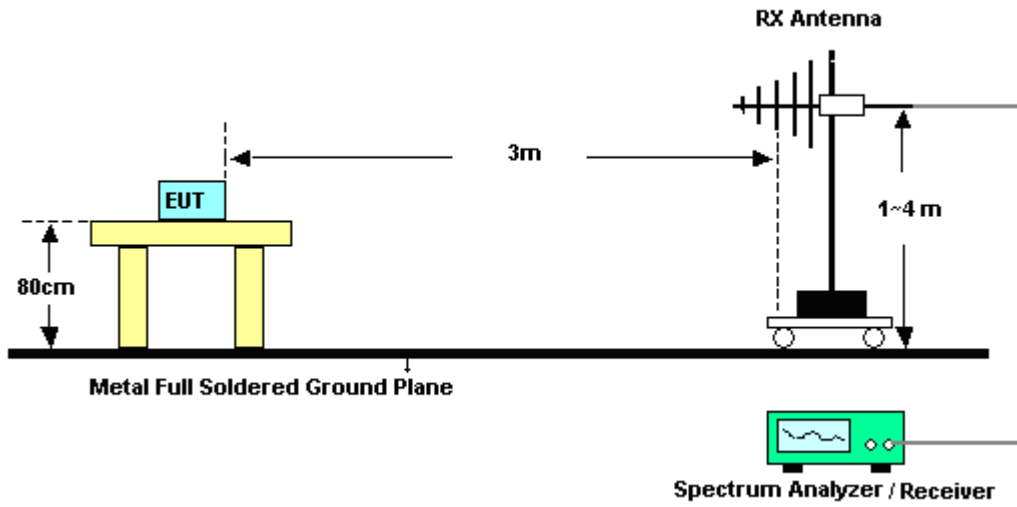

For radiated test from 1GHz to 18GHz

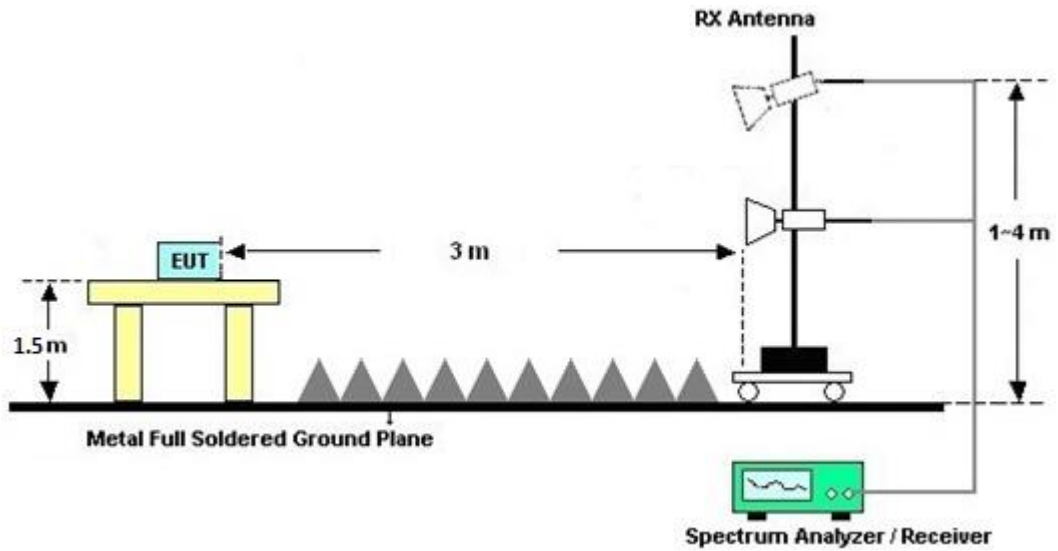

For radiated test above 18GHz

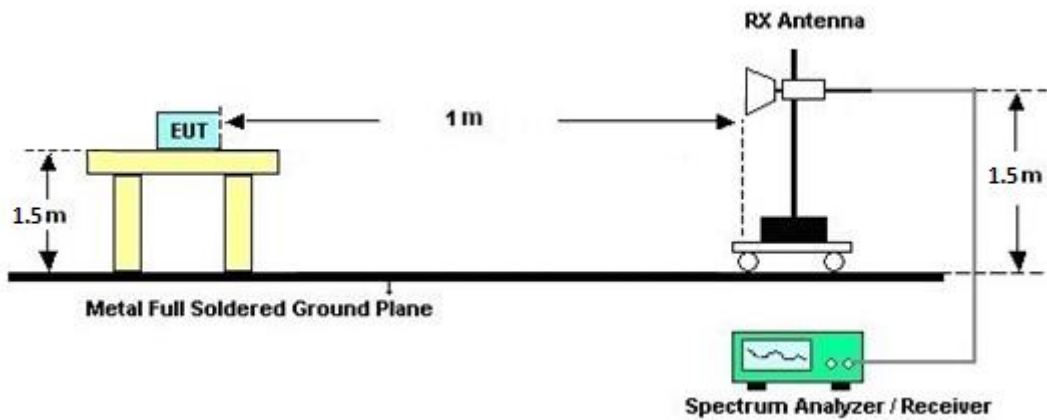

3.4.5 Test Results of Radiated Emissions (9 kHz ~ 30 MHz)

The low frequency, which started from 9 kHz to 30MHz, was pre-scanned and the result which was 20dB lower than the limit line was not reported.

There is adequate comparison measurement of both open-field test site and alternative test site - semi-Anechoic chamber according to 414788 D01 Radiated Test Site v01r01, and the result came out very similar.

3.4.6 Test Result of Radiated Band Edges

Please refer to Appendix C and D.

3.4.7 Duty Cycle

Please refer to Appendix E.

3.4.8 Test Result of Unwanted Radiated Emission (30MHz ~ 10th Harmonic)

Please refer to Appendix C and D.



3.5 AC Conducted Emission Measurement

3.5.1 Limit of AC Conducted Emission

For equipment that is designed to be connected to the public utility (AC) power line, the radio frequency voltage that is conducted back onto the AC power line on any frequency or frequencies within the band 150 kHz to 30 MHz shall not exceed the limits in the following table.

Frequency of emission (MHz)	Conducted limit (dB μ V)	
	Quasi-peak	Average
0.15-0.5	66 to 56*	56 to 46*
0.5-5	56	46
5-30	60	50

*Decreases with the logarithm of the frequency.

3.5.2 Measuring Instruments

See list of measuring equipment of this test report.

3.5.3 Test Procedures

1. The EUT was placed 0.4 meter from the conducting wall of the shielding room was kept at least 80 centimeters from any other grounded conducting surface.
2. Connect EUT to the power mains through a line impedance stabilization network (LISN).
3. All the support units are connecting to the other LISN.
4. The LISN provides 50 ohm coupling impedance for the measuring instrument.
5. The FCC states that a 50 ohm, 50 microhenry LISN shall be used.
6. Both sides of AC line were checked for maximum conducted interference.
7. The frequency range from 150 kHz to 30 MHz was searched.
8. Set the test-receiver system to Peak Detect Function and specified bandwidth with Maximum Hold Mode.

3.5.4 Test Setup

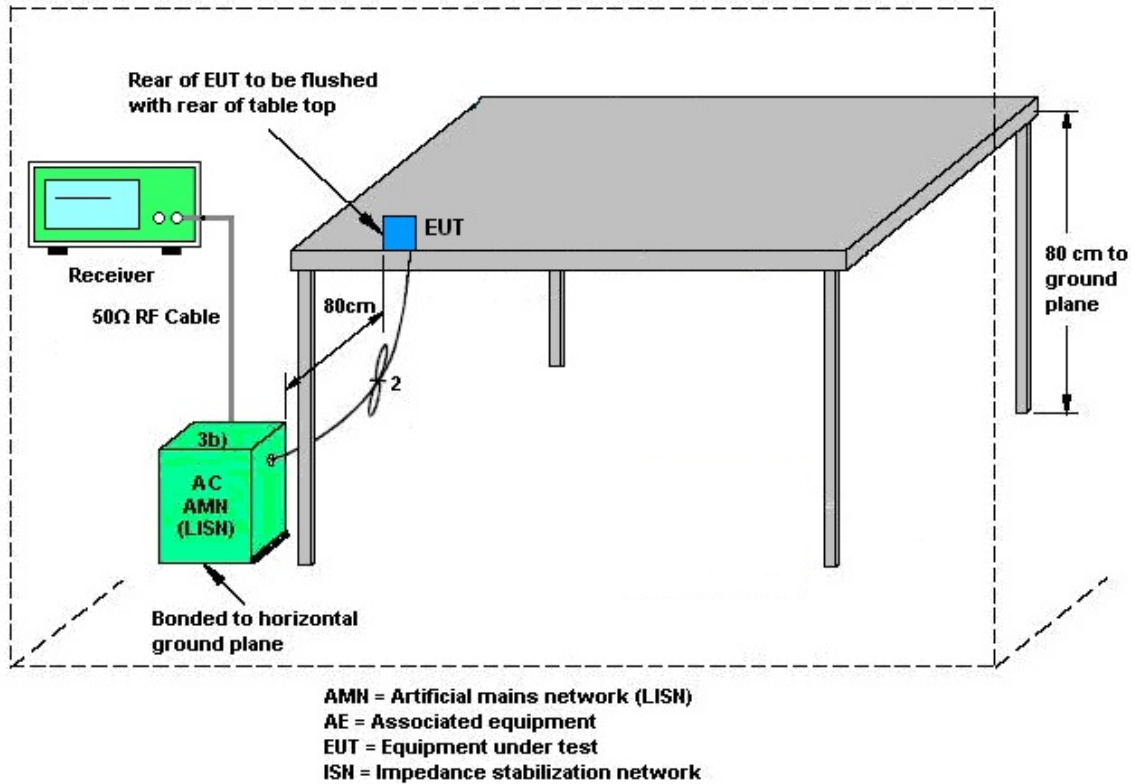

3.5.5 Test Result of AC Conducted Emission

Please refer to Appendix B.



3.6 Antenna Requirements

3.6.1 Standard Applicable

The use of a permanently attached antenna or of an antenna that uses a unique coupling to the intentional radiator shall be considered sufficient to comply with the rule.

3.6.2 Antenna Anti-Replacement Construction

An embedded-in antenna design is used.



4 List of Measuring Equipment

Instrument	Brand Name	Model No.	Serial No.	Characteristics	Calibration Date	Test Date	Due Date	Remark
Loop Antenna	TESEQ	HLA 6120	31244	9 kHz~30 MHz	Mar. 18, 2022	Nov. 09, 2022~ Nov. 19, 2022	Mar. 17, 2023	Radiation (03CH15-HY)
Bilog Antenna	TESEQ	CBL 6111D & 00800N1D01N- 06	41912 & 05	30MHz~1GHz	Feb. 06, 2022	Nov. 09, 2022~ Nov. 19, 2022	Feb. 05, 2023	Radiation (03CH15-HY)
Amplifier	SONOMA	310N	363440	9kHz~1GHz	Dec. 27, 2021	Nov. 09, 2022~ Nov. 19, 2022	Dec. 26, 2022	Radiation (03CH15-HY)
Horn Antenna	SCHWARZBE CK	BBHA 9120 D	9120D-02294	1GHz~18GHz	Jun. 23, 2022	Nov. 09, 2022~ Nov. 19, 2022	Jun. 22, 2023	Radiation (03CH15-HY)
SHF-EHF Horn Antenna	SCHWARZBE CK	BBHA 9170	00993	18GHz~40GHz	Nov. 30, 2021	Nov. 09, 2022~ Nov. 19, 2022	Nov. 29, 2022	Radiation (03CH15-HY)
Amplifier	EMEC	EM1G18G	060837	1GHz~18GHz	Sep. 01, 2022	Nov. 09, 2022~ Nov. 14, 2022	Aug. 31, 2023	Radiation (03CH15-HY)
Amplifier	EMEC	EM1G18G	060838	1GHz~18GHz	Sep. 01, 2022	Nov. 15, 2022~ Nov. 19, 2022	Aug. 31, 2023	Radiation (03CH15-HY)
Preamplifier	EM Electronics	EM01G18G	060803	1GHz-18GHz	Dec. 16, 2021	Nov. 09, 2022~ Nov. 19, 2022	Dec. 15, 2022	Radiation (03CH15-HY)
Preamplifier	EMEC	EM18G40G	060802	18-40GHz	Mar. 08, 2022	Nov. 09, 2022~ Nov. 19, 2022	Mar. 07, 2023	Radiation (03CH15-HY)
EMI Test Receiver	Keysight	N9038A(MXE)	MY54130085	20MHz~8.4GHz	Oct. 18, 2022	Nov. 09, 2022~ Nov. 19, 2022	Oct. 17, 2023	Radiation (03CH15-HY)
Spectrum Analyzer	Keysight	N9010	MY54200485	10Hz~44GHz	May 07, 2022	Nov. 09, 2022~ Nov. 19, 2022	May 06, 2023	Radiation (03CH15-HY)
Antenna Mast	ChainTek	MBS-520-1	N/A	1m~4m	N/A	Nov. 09, 2022~ Nov. 19, 2022	N/A	Radiation (03CH15-HY)
Turn Table	ChainTek	T-200-S-1	N/A	0~360 Degree	N/A	Nov. 09, 2022~ Nov. 19, 2022	N/A	Radiation (03CH15-HY)
Software	Audix	E3 6.2009-8-24(k5)	RK-000451	N/A	N/A	Nov. 09, 2022~ Nov. 19, 2022	N/A	Radiation (03CH15-HY)
RF Cable	HUBER + SUHNER	SUCOFLEX 104, 102E	MY582185/4, MY9838/4PE, 519228/2	N/A	Jun. 21, 2022	Nov. 09, 2022~ Nov. 19, 2022	Jun. 20, 2023	Radiation (03CH15-HY)
RF Cable	HUBER + SUHNER	SUCOFLEX 102	804011/2.804 012/2	30MHz-40GHz	Jan. 04, 2022	Nov. 09, 2022~ Nov. 19, 2022	Jan. 03, 2023	Radiation (03CH15-HY)
RF Cable	HUBER + SUHNER	SUCOFLEX 104	MY9837/4PE	9kHz~30MHz	Mar. 10, 2022	Nov. 09, 2022~ Nov. 19, 2022	Mar. 09, 2023	Radiation (03CH15-HY)
Hygrometer	TECPEL	DTM-303A	TP201996	N/A	Nov. 17, 2022	Dec. 16, 2022	Nov. 16, 2023	Conducted (TH05-HY)
Hygrometer	TECPEL	DTM-303B	TP200735	N/A	Mar. 22, 2022	Nov. 02, 2022~ Nov. 19, 2022	Mar. 21, 2023	Conducted (TH05-HY)
Power Sensor	DARE	RPR3006W	15100041SNO 10 (NO:248)	10MHz~6GHz	Dec. 29, 2021	Dec. 16, 2022	Dec. 28, 2022	Conducted (TH05-HY)
Signal Analyzer	Rohde & Schwarz	FSV40	101905	10Hz - 40GHz(amp)	Aug. 03, 2022	Dec. 16, 2022	Aug. 02, 2023	Conducted (TH05-HY)
AC Power Source	ChainTek	APC-1000W	N/A	N/A	N/A	Jul. 07, 2021	N/A	Conduction (CO05-HY)
EMI Test Receiver	Rohde & Schwarz	ESR3	102388	9kHz~3.6GHz	Nov. 30, 2020	Jul. 07, 2021	Nov. 29, 2021	Conduction (CO05-HY)
Hygrometer	Testo	608-H1	34913912	N/A	Nov. 18, 2020	Jul. 07, 2021	Nov. 17, 2021	Conduction (CO05-HY)
LISN	Rohde & Schwarz	ENV216	100081	9kHz~30MHz	Nov. 16, 2020	Jul. 07, 2021	Nov. 15, 2021	Conduction (CO05-HY)
Software	Rohde & Schwarz	EMC32 V10.30	N/A	N/A	N/A	Jul. 07, 2021	N/A	Conduction (CO05-HY)
Pulse Limiter	Rohde & Schwarz	ESH3-Z2	100851	N/A	Feb. 25, 2021	Jul. 07, 2021	Feb. 24, 2022	Conduction (CO05-HY)
LISN Cable	MVE	RG-400	260260	N/A	Dec. 31, 2020	Jul. 07, 2021	Dec. 30, 2021	Conduction (CO05-HY)



5 Uncertainty of Evaluation

Uncertainty of Conducted Emission Measurement (150kHz ~ 30MHz)

Measuring Uncertainty for a Level of Confidence of 95% ($U = 2Uc(y)$)	2.3 dB
-------------------------------------------------------------------------	--------

Uncertainty of Radiated Emission Measurement (30 MHz ~ 1000 MHz)

Measuring Uncertainty for a Level of Confidence of 95% ($U = 2Uc(y)$)	6.3 dB
-------------------------------------------------------------------------	--------

Uncertainty of Radiated Emission Measurement (1000 MHz ~ 6000 MHz)

Measuring Uncertainty for a Level of Confidence of 95% ($U = 2Uc(y)$)	4.2 dB
-------------------------------------------------------------------------	--------

Uncertainty of Radiated Emission Measurement (6000 MHz ~ 18000 MHz)

Measuring Uncertainty for a Level of Confidence of 95% ($U = 2Uc(y)$)	5.4 dB
-------------------------------------------------------------------------	--------

Uncertainty of Radiated Emission Measurement (18000 MHz ~ 40000 MHz)

Measuring Uncertainty for a Level of Confidence of 95% ($U = 2Uc(y)$)	5.2 dB
-------------------------------------------------------------------------	--------

Appendix A. Test Result of Conducted Test Items

Test Engineer:	ERIC WU	Temperature:	21~25	°C
Test Date:	2022/11/02~2022/12/16	Relative Humidity:	51~54	%

TEST RESULTS DATA
6dB and 26dB EBW and 99% OBW

UNII-4 MIMO												
Mod.	Data Rate	NTX	CH.	Freq. (MHz)	99% Bandwidth (MHz)		26dB Bandwidth (MHz)		6 dB Bandwidth (MHz)		6 dB Bandwidth Min. Limit (MHz)	Pass/Fail
					Ant 7	Ant 3	Ant 7	Ant 3	Ant 7	Ant 3		
11a	6Mbps	2	169	5845	17.28	17.08	22.10	22.25	16.44	16.44	0.5	Pass
11a	6Mbps	2	173	5865	17.63	17.48	30.05	30.90	16.44	16.43	0.5	Pass
11a	6Mbps	2	177	5885	17.78	17.58	30.90	31.20	16.44	16.44	0.5	Pass

TEST RESULTS DATA
Average Power Table

UNII-4 MIMO										
Mod.	Data Rate	NTX	CH.	Freq. (MHz)	Average Conducted Power (dBm)			DG (dBi)	E.I.R.P Power (dBm)	E.I.R.P Limit (dBm)
					Ant 7	Ant 3	SUM	Ant 7 + Ant 3	Ant 7 + Ant 3	Ant 7 + Ant 3
11a	6Mbps	2	169	5845	19.15	17.90	21.58	-1.90	19.68	30
11a	6Mbps	2	173	5865	20.05	18.90	22.52	-1.90	20.62	30
11a	6Mbps	2	177	5885	20.05	18.90	22.52	-1.90	20.62	30
HT20	MCS0	2	169	5845	20.35	20.30	23.34	-1.90	21.44	30
HT20	MCS0	2	173	5865	20.15	20.20	23.19	-1.90	21.29	30
HT20	MCS0	2	177	5885	18.05	18.10	21.09	-1.90	19.19	30
HT40	MCS0	2	167	5835	19.25	19.20	22.24	-1.90	20.34	30
HT40	MCS0	2	175	5875	19.05	19.20	22.14	-1.90	20.24	30
VHT20	MCS0	2	169	5845	20.80	20.20	23.52	-1.90	21.62	30
VHT20	MCS0	2	173	5865	20.40	20.20	23.31	-1.90	21.41	30
VHT20	MCS0	2	177	5885	18.30	18.10	21.21	-1.90	19.31	30
VHT40	MCS0	2	167	5835	19.35	19.20	22.29	-1.90	20.39	30
VHT40	MCS0	2	175	5875	19.05	19.20	22.14	-1.90	20.24	30
VHT80	MCS0	2	171	5855	17.95	18.00	20.99	-1.90	19.09	30

TEST RESULTS DATA
Power Spectral Density

UNII-4 MIMO													
Mod.	Data Rate	N _{TX}	CH.	Freq. (MHz)	Duty Factor (dB)		Average Power Density with Duty Factor (dBm/MHz)			DG (dBi)	EIRP PSD (dBm/MHz)	EIRP PSD Limit (dBm/MHz)	Pass /Fail
					Ant 7	Ant 3	Ant 7	Ant 3	SUM				
11a	6Mbps	2	169	5845	0.30	0.29			9.51	1.01	10.52	14.00	Pass
11a	6Mbps	2	173	5865	0.30	0.29			10.50	1.01	11.51	14.00	Pass
11a	6Mbps	2	177	5885	0.30	0.29			10.36	1.01	11.37	14.00	Pass

Note: PSD Sum = Max PSD(Ant. 7, Ant. 3) + 10 log (n)

TEST RESULTS DATA
6dB and 26dB EBW and 99% OBW

UNII-4 MIMO													
Mod.	Data Rate	NTX	CH.	Freq. (MHz)	RU Config	99% Bandwidth (MHz)		26dB Bandwidth (MHz)		6 dB Bandwidth (MHz)		6 dB Bandwidth Min. Limit (MHz)	Pass/Fail
						Ant 7	Ant 3	Ant 7	Ant 3	Ant 7	Ant 3		
HE20	MCS0	2	169	5845	Full	19.78	19.78	38.45	42.20	18.98	18.74	0.5	Pass
HE20	MCS0	2	173	5865	Full	19.78	19.88	41.80	39.00	18.94	19.00	0.5	Pass
HE20	MCS0	2	177	5885	Full	19.23	19.23	27.65	25.70	19.08	18.99	0.5	Pass
HE40	MCS0	2	167	5835	Full	38.26	38.26	46.89	48.60	37.71	37.71	0.5	Pass
HE40	MCS0	2	175	5875	Full	38.26	38.26	49.59	56.88	37.80	37.80	0.5	Pass
HE80	MCS0	2	171	5855	Full	77.20	77.32	82.24	88.16	78.08	76.80	0.5	Pass

TEST RESULTS DATA
Average Power Table

UNII-4 MIMO											
Mod.	Data Rate	NTX	CH.	Freq. (MHz)	RU Config	Average Conducted Power (dBm)			DG (dBi)	E.I.R.P Power (dBm)	E.I.R.P Limit (dBm)
						Ant 7	Ant 3	SUM			
HE20	MSC0	2	169	5845	Full	21.45	20.30	23.92	-1.90	22.02	30
HE20	MSC1	2	169	5845	26/0	11.85	11.10	14.50	-1.90	12.60	30
HE20	MSC2	2	169	5845	52/37	14.55	13.90	17.25	-1.90	15.35	30
HE20	MSC3	2	169	5845	106/53	17.55	16.80	20.20	-1.90	18.30	30
HE20	MSC0	2	173	5865	Full	21.45	20.30	23.92	-1.90	22.02	30
HE20	MSC5	2	173	5865	26/4	12.35	11.60	15.00	-1.90	13.10	30
HE20	MSC6	2	173	5865	52/38	14.85	14.10	17.50	-1.90	15.60	30
HE20	MSC7	2	173	5865	106/53	17.65	16.60	20.17	-1.90	18.27	30
HE20	MSC0	2	177	5885	Full	18.95	18.10	21.56	-1.90	19.66	30
HE20	MSC9	2	177	5885	26/8	9.45	8.60	12.06	-1.90	10.16	30
HE20	MSC10	2	177	5885	52/40	12.05	11.40	14.75	-1.90	12.85	30
HE20	MSC11	2	177	5885	106/54	15.25	14.60	17.95	-1.90	16.05	30
HE40	MSC0	2	167	5835	Full	20.55	19.50	23.07	-1.90	21.17	30
HE40	MSC0	2	175	5875	Full	20.55	19.60	23.11	-1.90	21.21	30
HE80	MSC0	2	171	5855	Full	19.15	18.60	21.89	-1.90	19.99	30

TEST RESULTS DATA
Power Spectral Density

UNII-4 MIMO														
Mod.	Data Rate	N _{TX}	CH.	Freq. (MHz)	RU Config	Duty Factor (dB)		Average Power Density with Duty Factor (dBm/MHz)			DG (dBi)	EIRP PSD (dBm/MHz)	EIRP PSD Limit (dBm/MHz)	Pass /Fail
						Ant 7	Ant 3	Ant 7	Ant 3	SUM				
HE20	MCS0	2	169	5845	Full	0.41	0.41			11.01	1.01	12.02	14.00	Pass
HE20	MCS0	2	169	5845	26/0	0.48	0.48			10.75	1.01	11.76	14.00	Pass
HE20	MCS0	2	169	5845	52/37	0.52	0.52			10.70	1.01	11.71	14.00	Pass
HE20	MCS0	2	169	5845	106/53	0.58	0.58			10.63	1.01	11.64	14.00	Pass
HE20	MCS0	2	173	5865	Full	0.41	0.41			11.02	1.01	12.03	14.00	Pass
HE20	MCS0	2	173	5865	26/4	0.48	0.48			10.53	1.01	11.54	14.00	Pass
HE20	MCS0	2	173	5865	52/38	0.52	0.52			10.96	1.01	11.97	14.00	Pass
HE20	MCS0	2	173	5865	106/53	0.58	0.58			10.65	1.01	11.66	14.00	Pass
HE20	MCS0	2	177	5885	Full	0.41	0.41			8.75	1.01	9.76	14.00	Pass
HE20	MCS0	2	177	5885	26/8	0.48	0.48			8.46	1.01	9.47	14.00	Pass
HE20	MCS0	2	177	5885	52/40	0.52	0.52			8.43	1.01	9.44	14.00	Pass
HE20	MCS0	2	177	5885	106/54	0.58	0.58			8.36	1.01	9.37	14.00	Pass
HE40	MCS0	2	167	5835	Full	0.34	0.34			6.79	1.01	7.80	14.00	Pass
HE40	MCS0	2	175	5875	Full	0.34	0.34			6.71	1.01	7.72	14.00	Pass
HE80	MCS0	2	171	5855	Full	0.43	0.43			1.80	1.01	2.81	14.00	Pass

Note: PSD Sum = Max PSD(Ant. 7, Ant. 3) + 10 log (n)



Appendix B. AC Conducted Emission Test Results

Test Engineer : Tom Lee	Temperature : 23~26°C
	Relative Humidity : 40~50%

EUT Information

Test Mode : Mode 1
 Test Voltage : 120Vac/60Hz
 Phase : Line

Full Spectrum

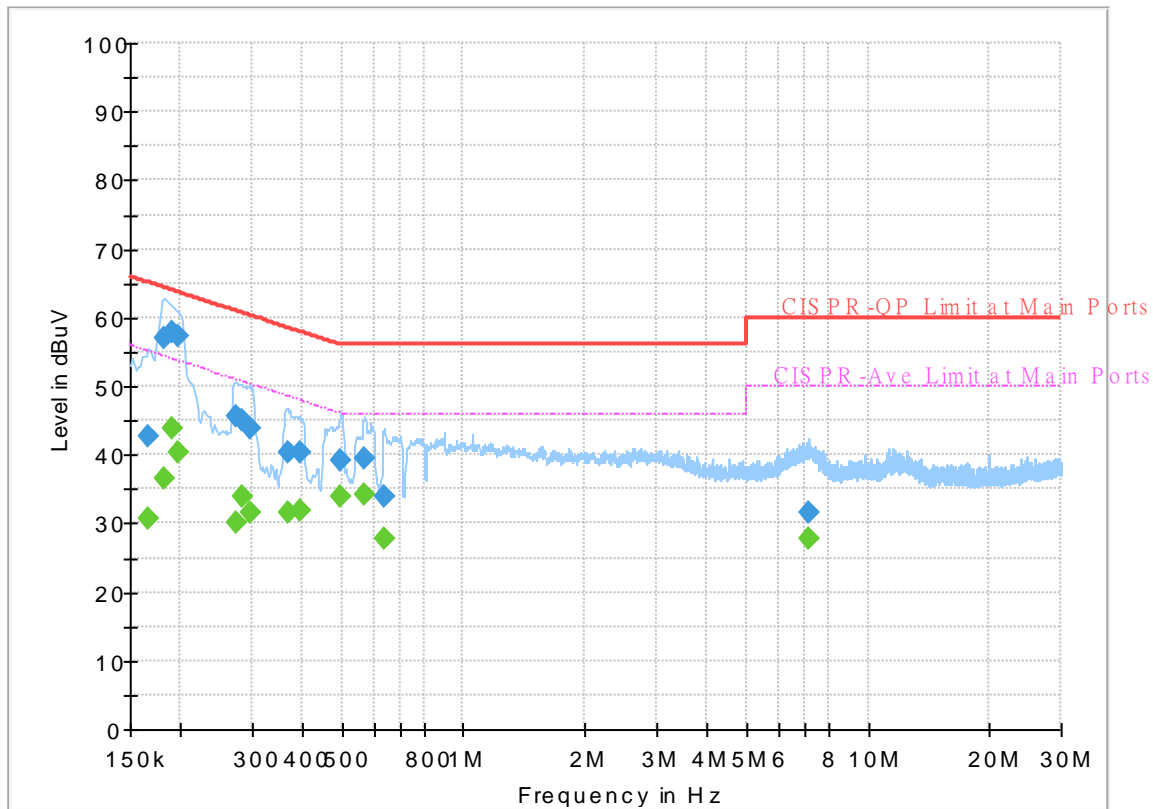

Final_Result

Frequency (MHz)	QuasiPeak (dBuV)	CAverage (dBuV)	Limit (dBuV)	Margin (dB)	Line	Filter	Corr. (dB)
0.165750	---	30.62	55.17	24.55	L1	OFF	19.5
0.165750	42.84	---	65.17	22.33	L1	OFF	19.5
0.181500	---	36.68	54.42	17.74	L1	OFF	19.5
0.181500	56.98	---	64.42	7.44	L1	OFF	19.5
0.190500	---	43.95	54.02	10.07	L1	OFF	19.5
0.190500	57.97	---	64.02	6.05	L1	OFF	19.5
0.197250	---	40.37	53.73	13.36	L1	OFF	19.5
0.197250	57.34	---	63.73	6.39	L1	OFF	19.5
0.273750	---	30.24	51.00	20.76	L1	OFF	19.5
0.273750	45.51	---	61.00	15.49	L1	OFF	19.5
0.282750	---	33.78	50.74	16.96	L1	OFF	19.5
0.282750	45.09	---	60.74	15.65	L1	OFF	19.5
0.298500	---	31.63	50.28	18.65	L1	OFF	19.5
0.298500	43.82	---	60.28	16.46	L1	OFF	19.5
0.368250	---	31.50	48.54	17.04	L1	OFF	19.5
0.368250	40.46	---	58.54	18.08	L1	OFF	19.5
0.393000	---	31.90	48.00	16.10	L1	OFF	19.5
0.393000	40.41	---	58.00	17.59	L1	OFF	19.5
0.498750	---	33.99	46.02	12.03	L1	OFF	19.7
0.498750	39.09	---	56.02	16.93	L1	OFF	19.7
0.570750	---	34.12	46.00	11.88	L1	OFF	19.7
0.570750	39.62	---	56.00	16.38	L1	OFF	19.7
0.638250	---	27.91	46.00	18.09	L1	OFF	19.8
0.638250	34.02	---	56.00	21.98	L1	OFF	19.8
7.170000	---	27.68	50.00	22.32	L1	OFF	19.9
7.170000	31.69	---	60.00	28.31	L1	OFF	19.9

EUT Information

Test Mode : Mode 1
 Test Voltage : 120Vac/60Hz
 Phase : Neutral

Full Spectrum

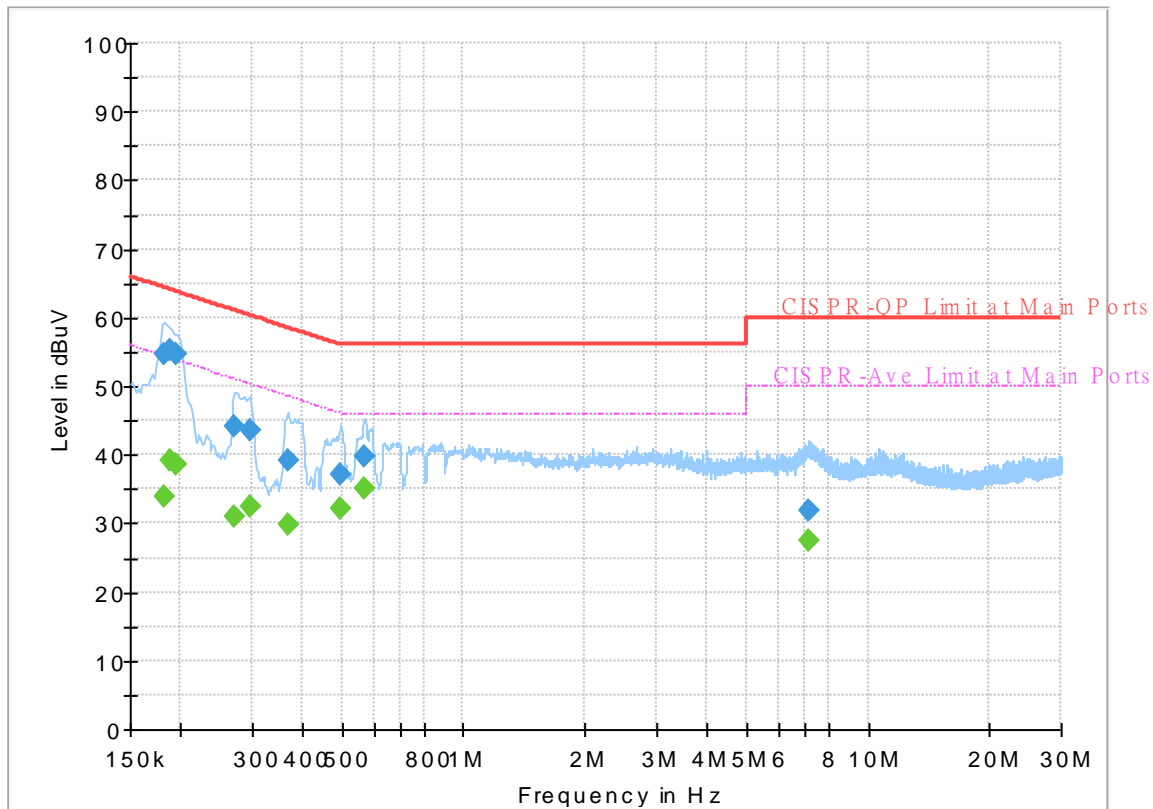

Final_Result

Frequency (MHz)	QuasiPeak (dBuV)	CAverage (dBuV)	Limit (dBuV)	Margin (dB)	Line	Filter	Corr. (dB)
0.181500	---	34.01	54.42	20.41	N	OFF	19.5
0.181500	54.53	---	64.42	9.89	N	OFF	19.5
0.188250	---	39.08	54.11	15.03	N	OFF	19.5
0.188250	55.30	---	64.11	8.81	N	OFF	19.5
0.195000	---	38.49	53.82	15.33	N	OFF	19.5
0.195000	54.59	---	63.82	9.23	N	OFF	19.5
0.271500	---	31.08	51.07	19.99	N	OFF	19.5
0.271500	44.08	---	61.07	16.99	N	OFF	19.5
0.296250	---	32.49	50.35	17.86	N	OFF	19.5
0.296250	43.44	---	60.35	16.91	N	OFF	19.5
0.368250	---	29.95	48.54	18.59	N	OFF	19.6
0.368250	39.18	---	58.54	19.36	N	OFF	19.6
0.496500	---	32.27	46.06	13.79	N	OFF	19.7
0.496500	37.27	---	56.06	18.79	N	OFF	19.7
0.568500	---	35.22	46.00	10.78	N	OFF	19.8
0.568500	39.68	---	56.00	16.32	N	OFF	19.8
7.149750	---	27.62	50.00	22.38	N	OFF	20.0
7.149750	31.81	---	60.00	28.19	N	OFF	20.0



Appendix C. Radiated Spurious Emission

Test Engineer :	Eric Xaio, Bigshow Wang and Quentin Liu	Temperature :	21.1~23.1°C
		Relative Humidity :	49~58%

UNII-4 - 5850~5895MHz

WIFI 802.11a (Band Edge @ 3m)

WIFI	Note	Frequency	Level	Margin	Limit	Read	Antenna	Path	Preamp	Ant	Table	Peak	Pol.	
Ant.					Line	Level	Factor	Loss	Factor	Pos	Pos	Avg.		
7+3		(MHz)	(dBµV/m)	(dB)	(dBµV/m)	(dBµV)	(dB/m)	(dB)	(dB)	(cm)	(deg)	(P/A)	(H/V)	
802.11a CH 169 5845MHz		5641.3	47.72	-20.48	68.2	41.82	33.08	9.54	36.72	258	303	P	H	
		5697.35	48.82	-54.43	103.25	42.31	33.67	9.56	36.72	258	303	P	H	
		5706.495	49.82	-57.2	107.02	43.23	33.74	9.57	36.72	258	303	P	H	
		5722.13	49.17	-66.49	115.66	42.49	33.83	9.57	36.72	258	303	P	H	
	*	5845	101.69			94.53	34.2	9.67	36.71	258	303	P	H	
	*	5845	103.35			96.19	34.2	9.67	36.71	258	303	A	H	
		5899.25	56.89	-50.19	107.08	49.56	34.3	9.74	36.71	258	303	P	H	
		5958.75	49.5	-38.7	88.2	42.29	34.1	9.82	36.71	258	303	P	H	
		5898	41.8	-46.19	87.99	34.47	34.3	9.74	36.71	258	303	A	H	
		5927	40.18	-28.02	68.2	32.92	34.19	9.78	36.71	258	303	A	H	
														H
														H
			5612.98	48.17	-20.03	68.2	42.33	33.03	9.53	36.72	178	327	P	V
			5692.925	48.79	-51.19	99.98	42.33	33.62	9.56	36.72	178	327	P	V
			5718.59	48.67	-61.74	110.41	42.01	33.81	9.57	36.72	178	327	P	V
			5720.655	48.18	-64.11	112.29	41.51	33.82	9.57	36.72	178	327	P	V
	*		5845	103.21			96.05	34.2	9.67	36.71	178	327	P	V
	*		5845	103.67			96.51	34.2	9.67	36.71	178	327	A	V
			5896	54.05	-55.41	109.46	46.73	34.29	9.74	36.71	178	327	P	V
			5955.75	51.29	-36.91	88.2	44.08	34.1	9.82	36.71	178	327	P	V
		5896.25	43.51	-45.77	89.28	36.19	34.29	9.74	36.71	178	327	A	V	
		5925.25	41.77	-26.43	68.2	34.5	34.2	9.78	36.71	178	327	A	V	
													V	
													V	



WIFI Ant. 7+3	Note	Frequency (MHz)	Level (dBμV/m)	Margin (dB)	Limit Line (dBμV/m)	Read Level (dBμV)	Antenna Factor (dB/m)	Path Loss (dB)	Preamp Factor (dB)	Ant Pos (cm)	Table Pos (deg)	Peak Avg. (P/A)	Pol. (H/V)
		5641.005	49.63	-18.57	68.2	43.73	33.08	9.54	36.72	259	305	P	H
		5677.585	49.58	-39.07	88.65	43.32	33.43	9.55	36.72	259	305	P	H
		5701.185	52.39	-53.14	105.53	45.83	33.71	9.57	36.72	259	305	P	H
		5720.36	54.01	-57.61	111.62	47.34	33.82	9.57	36.72	259	305	P	H
	*	5865	102.97			95.75	34.23	9.7	36.71	259	305	P	H
	*	5865	103.99			96.77	34.23	9.7	36.71	259	305	A	H
		5906.5	66.03	-35.72	101.75	58.72	34.27	9.75	36.71	259	305	P	H
		5925.5	57.21	-30.99	88.2	49.94	34.2	9.78	36.71	259	305	P	H
		5897.5	49.52	-38.84	88.36	42.2	34.29	9.74	36.71	259	305	A	H
		5925	40.9	-27.3	68.2	33.63	34.2	9.78	36.71	259	305	A	H
													H
													H
802.11a													
CH 173													
5865MHz		5647.495	48.36	-19.84	68.2	42.45	33.09	9.54	36.72	158	338	P	V
		5693.22	48.55	-51.65	100.2	42.09	33.62	9.56	36.72	158	338	P	V
		5705.02	49.17	-57.44	106.61	42.59	33.73	9.57	36.72	158	338	P	V
		5721.245	48.15	-65.49	113.64	41.47	33.83	9.57	36.72	158	338	P	V
	*	5865	105.25			98.03	34.23	9.7	36.71	158	338	P	V
	*	5865	105.53			98.31	34.23	9.7	36.71	158	338	A	V
		5897.5	65.05	-43.31	108.36	57.73	34.29	9.74	36.71	158	338	P	V
		5930	56.17	-32.03	88.2	48.91	34.18	9.79	36.71	158	338	P	V
		5895.25	53.58	-36.44	90.02	46.26	34.29	9.74	36.71	158	338	A	V
		5925.75	43.48	-24.72	68.2	36.21	34.2	9.78	36.71	158	338	A	V
													V
													V



WIFI Ant. 7+3	Note	Frequency (MHz)	Level (dBμV/m)	Margin (dB)	Limit Line (dBμV/m)	Read Level (dBμV)	Antenna Factor (dB/m)	Path Loss (dB)	Preamp Factor (dB)	Ant Pos (cm)	Table Pos (deg)	Peak Avg. (P/A)	Pol. (H/V)	
802.11a CH 177 5885MHz		5633.925	48	-20.2	68.2	42.11	33.07	9.54	36.72	260	280	P	H	
		5665.785	50.25	-29.67	79.92	44.13	33.29	9.55	36.72	260	280	P	H	
		5714.165	47.98	-61.19	109.17	41.35	33.78	9.57	36.72	260	280	P	H	
		5721.835	47.9	-67.08	114.98	41.22	33.83	9.57	36.72	260	280	P	H	
	*	5885	100.54			93.26	34.27	9.72	36.71	260	280	P	H	
	*	5885	102.21			94.93	34.27	9.72	36.71	260	280	A	H	
		5895.25	86.09	-23.93	110.02	78.77	34.29	9.74	36.71	260	280	P	H	
		5926.5	63.82	-24.38	88.2	56.56	34.19	9.78	36.71	260	280	P	H	
		5895.25	76.46	-13.56	90.02	69.14	34.29	9.74	36.71	260	280	A	H	
		5925.5	45.04	-23.16	68.2	37.77	34.2	9.78	36.71	260	280	A	H	
														H
														H
			5621.24	47.31	-20.89	68.2	41.46	33.04	9.53	36.72	178	324	P	V
			5687.615	48.76	-47.31	96.07	42.37	33.55	9.56	36.72	178	324	P	V
			5708.265	48.46	-59.06	107.52	41.86	33.75	9.57	36.72	178	324	P	V
			5721.835	48.02	-66.96	114.98	41.34	33.83	9.57	36.72	178	324	P	V
	*		5885	104.94			97.66	34.27	9.72	36.71	178	324	P	V
	*		5885	105.75			98.47	34.27	9.72	36.71	178	324	A	V
			5895.75	92.33	-17.32	109.65	85.01	34.29	9.74	36.71	178	324	P	V
			5926.5	61.38	-26.82	88.2	54.12	34.19	9.78	36.71	178	324	P	V
		5895.25	81.61	-8.41	90.02	74.29	34.29	9.74	36.71	178	324	A	V	
		5925.25	46.91	-21.29	68.2	39.64	34.2	9.78	36.71	178	324	A	V	
													V	
													V	
Remark	1. No other spurious found. 2. All results are PASS against Peak and Average limit line.													



UNII- 4 5850~5895MHz
WIFI 802.11a (Harmonic @ 3m)

WIFI Ant. 7+3	Note	Frequency (MHz)	Level (dBµV/m)	Margin (dB)	Limit Line (dBµV/m)	Read Level (dBµV)	Antenna Factor (dB/m)	Path Loss (dB)	Preamp Factor (dB)	Ant Pos (cm)	Table Pos (deg)	Peak Avg. (P/A)	Pol. (H/V)
802.11a CH 169 5845MHz		11690	45.11	-28.89	74	50.47	38.7	13.62	57.68	-	-	P	H
		17535	59.3	-8.9	68.2	63.87	38.64	16.73	59.94	251	22	P	H
													H
													H
													H
													H
													H
													H
													H
													H
													H
													H
													H
													H
													H
													H
													H
													H
													H
			11690	45.71	-28.29	74	51.04	38.7	13.62	57.65	-	-	P
		17535	64.71	-3.49	68.2	69.01	38.64	16.73	59.67	320	357	P	V
													V
													V
													V
													V
													V
													V
													V
													V
													V
													V
													V
													V
													V
													V
													V



WIFI Ant. 7+3	Note	Frequency (MHz)	Level (dBµV/m)	Margin (dB)	Limit Line (dBµV/m)	Read Level (dBµV)	Antenna Factor (dB/m)	Path Loss (dB)	Preamp Factor (dB)	Ant Pos (cm)	Table Pos (deg)	Peak Avg. (P/A)	Pol. (H/V)	
802.11a CH 173 5865MHz		11730	45.16	-28.84	74	50.47	38.7	13.64	57.65	-	-	P	H	
		17595	61.44	-6.76	68.2	65.67	38.88	16.77	59.88	238	56	P	H	
													H	
													H	
													H	
													H	
													H	
													H	
													H	
													H	
													H	
													H	
			11730	46.42	-27.58	74	51.7	38.7	13.64	57.62	-	-	P	V
			17595	64.12	-4.08	68.2	68.09	38.88	16.77	59.62	312	354	P	V
														V
														V
														V
														V
														V
														V
													V	
													V	
													V	
													V	
													V	



WiFi Ant. 7+3	Note	Frequency (MHz)	Level (dBμV/m)	Margin (dB)	Limit Line (dBμV/m)	Read Level (dBμV)	Antenna Factor (dB/m)	Path Loss (dB)	Preamp Factor (dB)	Ant Pos (cm)	Table Pos (deg)	Peak Avg. (P/A)	Pol. (H/V)
802.11a CH 177 5885MHz		11770	43.69	-30.31	74	48.95	38.7	13.67	57.63	-	-	P	H
		17655	60.86	-7.34	68.2	64.69	39.18	16.81	59.82	-	-	P	H
													H
													H
													H
													H
													H
													H
													H
													H
													H
													H
													H
													H
													H
													H
													H
													H
													H
			11770	43.41	-30.59	74	48.62	38.7	13.67	57.58	-	-	P
		17655	64.42	-3.78	68.2	68.01	39.18	16.81	59.58	202	53	P	V
													V
													V
													V
													V
													V
													V
													V
													V
													V
													V
													V
													V
													V
Remark	1. No other spurious found.												
	2. All results are PASS against Peak and Average limit line.												
	3. The emission position marked as "-" means no suspected emission found with sufficient margin against limit line or noise floor only.												



UNII- 4 5850~5895MHz
WIFI 802.11ax HE20_Full (Band Edge @ 3m)

WIFI Ant. 7+3	Note	Frequency (MHz)	Level (dBμV/m)	Margin (dB)	Limit Line (dBμV/m)	Read Level (dBμV)	Antenna Factor (dB/m)	Path Loss (dB)	Preamp Factor (dB)	Ant Pos (cm)	Table Pos (deg)	Peak Avg. (P/A)	Pol. (H/V)
		5632.745	48.59	-19.61	68.2	42.71	33.07	9.53	36.72	282	285	P	H
		5695.58	49.22	-52.72	101.94	42.73	33.65	9.56	36.72	282	285	P	H
		5707.085	49.09	-58.1	107.19	42.5	33.74	9.57	36.72	282	285	P	H
		5723.015	48.41	-69.27	117.68	41.71	33.84	9.58	36.72	282	285	P	H
	*	5845	103.01	-	-	95.85	34.2	9.67	36.71	282	285	P	H
	*	5845	101.96	-	-	94.8	34.2	9.67	36.71	282	285	A	H
		5896.75	58.78	-50.13	108.91	51.46	34.29	9.74	36.71	282	285	P	H
		5946.75	50.16	-38.04	88.2	42.95	34.11	9.81	36.71	282	285	P	H
		5895.5	46.74	-43.09	89.83	39.42	34.29	9.74	36.71	282	285	A	H
		5926.25	40.74	-27.46	68.2	33.48	34.19	9.78	36.71	282	285	A	H
802.11ax													H
HE20 Full													H
CH 169		5643.365	48.62	-19.58	68.2	42.71	33.09	9.54	36.72	165	332	P	V
5845MHz		5662.245	50.33	-26.96	77.29	44.25	33.25	9.55	36.72	165	332	P	V
		5705.61	50.02	-56.75	106.77	43.44	33.73	9.57	36.72	165	332	P	V
		5724.49	50.64	-70.4	121.04	43.93	33.85	9.58	36.72	165	332	P	V
	*	5845	106.86	-	-	99.7	34.2	9.67	36.71	165	332	P	V
	*	5845	106	-	-	98.84	34.2	9.67	36.71	165	332	A	V
		5896.25	63.13	-46.15	109.28	55.81	34.29	9.74	36.71	165	332	P	V
		5938	54.11	-34.09	88.2	46.87	34.15	9.8	36.71	165	332	P	V
		5895.25	51.88	-38.14	90.02	44.56	34.29	9.74	36.71	165	332	A	V
		5926.5	44.41	-23.79	68.2	37.15	34.19	9.78	36.71	165	332	A	V
													V
													V



WIFI Ant. 7+3	Note	Frequency (MHz)	Level (dBμV/m)	Margin (dB)	Limit Line (dBμV/m)	Read Level (dBμV)	Antenna Factor (dB/m)	Path Loss (dB)	Preamp Factor (dB)	Ant Pos (cm)	Table Pos (deg)	Peak Avg. (P/A)	Pol. (H/V)
		5606.195	48.61	-19.59	68.2	42.8	33.01	9.52	36.72	281	286	P	H
		5686.73	49.31	-46.1	95.41	42.93	33.54	9.56	36.72	281	286	P	H
		5707.675	51.32	-56.03	107.35	44.72	33.75	9.57	36.72	281	286	P	H
		5723.31	48.15	-70.2	118.35	41.45	33.84	9.58	36.72	281	286	P	H
	*	5865	103.12	-	-	95.9	34.23	9.7	36.71	281	286	P	H
	*	5865	102.13	-	-	94.91	34.23	9.7	36.71	281	286	A	H
		5895.5	68.24	-41.59	109.83	60.92	34.29	9.74	36.71	281	286	P	H
		5936	55.23	-32.97	88.2	47.99	34.16	9.79	36.71	281	286	P	H
		5895.25	57.5	-32.52	90.02	50.18	34.29	9.74	36.71	281	286	A	H
		5925	42.87	-25.33	68.2	35.6	34.2	9.78	36.71	281	286	A	H
802.11ax													H
HE20 Full													H
CH 173		5644.25	48.46	-19.74	68.2	42.55	33.09	9.54	36.72	199	343	P	V
5865MHz		5698.825	49.58	-54.75	104.33	43.05	33.69	9.56	36.72	199	343	P	V
		5702.955	50.94	-55.09	106.03	44.37	33.72	9.57	36.72	199	343	P	V
		5724.785	49.67	-72.04	121.71	42.96	33.85	9.58	36.72	199	343	P	V
	*	5865	107	-	-	99.78	34.23	9.7	36.71	199	343	P	V
	*	5865	105.96	-	-	98.74	34.23	9.7	36.71	199	343	A	V
		5895.75	74.4	-35.25	109.65	67.08	34.29	9.74	36.71	199	343	P	V
		5925.75	59.14	-29.06	88.2	51.87	34.2	9.78	36.71	199	343	P	V
		5895.25	62.42	-27.6	90.02	55.1	34.29	9.74	36.71	199	343	A	V
		5925	47.94	-20.26	68.2	40.67	34.2	9.78	36.71	199	343	A	V
													V
													V



WIFI Ant. 7+3	Note	Frequency (MHz)	Level (dBμV/m)	Margin (dB)	Limit Line (dBμV/ m)	Read Level (dBμV)	Antenna Factor (dB/m)	Path Loss (dB)	Preamp Factor (dB)	Ant Pos (cm)	Table Pos (deg)	Peak Avg. (P/A)	Pol. (H/V)
		5635.4	49.99	-18.21	68.2	44.1	33.07	9.54	36.72	256	279	P	H
		5699.12	50.43	-54.12	104.55	43.9	33.69	9.56	36.72	256	279	P	H
		5719.475	50.73	-59.92	110.65	44.06	33.82	9.57	36.72	256	279	P	H
		5724.195	50.79	-69.57	120.36	44.08	33.85	9.58	36.72	256	279	P	H
	*	5885	101.6	-	-	94.32	34.27	9.72	36.71	256	279	P	H
	*	5885	100.66	-	-	93.38	34.27	9.72	36.71	256	279	A	H
		5895.25	95.33	-14.69	110.02	88.01	34.29	9.74	36.71	256	279	P	H
		5925.5	64.24	-23.96	88.2	56.97	34.2	9.78	36.71	256	279	P	H
		5895.25	84.75	-5.27	90.02	77.43	34.29	9.74	36.71	256	279	A	H
		5925	45.3	-22.9	68.2	38.03	34.2	9.78	36.71	256	279	A	H
802.11ax													H
HE20 Full													H
CH 177		5645.725	48.4	-19.8	68.2	42.49	33.09	9.54	36.72	183	325	P	V
5885MHz		5695.875	49.91	-52.25	102.16	43.42	33.65	9.56	36.72	183	325	P	V
		5709.445	50.47	-57.38	107.85	43.86	33.76	9.57	36.72	183	325	P	V
		5724.785	49.59	-72.12	121.71	42.88	33.85	9.58	36.72	183	325	P	V
	*	5885	105.18	-	-	97.9	34.27	9.72	36.71	183	325	P	V
	*	5885	104.05	-	-	96.77	34.27	9.72	36.71	183	325	A	V
		5895.25	97.42	-12.6	110.02	90.1	34.29	9.74	36.71	183	325	P	V
		5926.25	61.31	-26.89	88.2	54.05	34.19	9.78	36.71	183	325	P	V
		5895.25	88.41	-1.61	90.02	81.09	34.29	9.74	36.71	183	325	A	V
		5925.25	48.35	-19.85	68.2	41.08	34.2	9.78	36.71	183	325	A	V
													V
													V
Remark	1. No other spurious found. 2. All results are PASS against Peak and Average limit line.												



UNII- 4 5850~5895MHz

WIFI 802.11ax HE20 Full (Harmonic @ 3m)

WIFI Ant. 7+3	Note	Frequency (MHz)	Level (dBµV/m)	Margin (dB)	Limit Line (dBµV/m)	Read Level (dBµV)	Antenna Factor (dB/m)	Path Loss (dB)	Preamp Factor (dB)	Ant Pos (cm)	Table Pos (deg)	Peak Avg. (P/A)	Pol. (H/V)	
802.11ax HE20 Full CH 169 5845MHz		11690	42.95	-31.05	74	48.31	38.7	13.62	57.68	-	-	P	H	
		17535	61.79	-6.41	68.2	66.36	38.64	16.73	59.94	201	23	P	H	
													H	
													H	
													H	
													H	
													H	
													H	
													H	
													H	
													H	
													H	
													H	
													H	
													H	
													H	
			11690	43.08	-30.92	74	48.41	38.7	13.62	57.65	-	-	P	V
			17535	63.71	-4.49	68.2	68.01	38.64	16.73	59.67	150	52	P	V
														V
													V	
													V	
													V	
													V	
													V	
													V	
													V	
													V	
													V	
													V	



WIFI Ant. 7+3	Note	Frequency (MHz)	Level (dBμV/m)	Margin (dB)	Limit Line (dBμV/m)	Read Level (dBμV)	Antenna Factor (dB/m)	Path Loss (dB)	Preamp Factor (dB)	Ant Pos (cm)	Table Pos (deg)	Peak Avg. (P/A)	Pol. (H/V)	
802.11ax HE20 Full CH 173 5865MHz		11730	46.24	-27.76	74	51.55	38.7	13.64	57.65	-	-	P	H	
		17595	59.94	-8.26	68.2	64.17	38.88	16.77	59.88	244	59	P	H	
													H	
													H	
													H	
													H	
													H	
													H	
													H	
													H	
													H	
													H	
													H	
			11730	46.17	-27.83	74	51.45	38.7	13.64	57.62	-	-	P	V
			17595	64.12	-4.08	68.2	68.09	38.88	16.77	59.62	308	355	P	V
														V
														V
														V
														V
													V	
													V	
													V	
													V	



WIFI Ant. 7+3	Note	Frequency (MHz)	Level (dBμV/m)	Margin (dB)	Limit Line (dBμV/m)	Read Level (dBμV)	Antenna Factor (dB/m)	Path Loss (dB)	Preamp Factor (dB)	Ant Pos (cm)	Table Pos (deg)	Peak Avg. (P/A)	Pol. (H/V)
802.11ax HE20 Full CH 177 5885MHz		11770	44.9	-29.1	74	50.16	38.7	13.67	57.63	-	-	P	H
		17655	56.66	-11.54	68.2	60.49	39.18	16.81	59.82	250	63	P	H
													H
													H
													H
													H
													H
													H
													H
													H
													H
													H
													H
													H
													H
													H
													H
													H
													H
			11770	45.46	-28.54	74	50.67	38.7	13.67	57.58	-	-	P
		17655	59.74	-8.46	68.2	63.33	39.18	16.81	59.58	250	54	P	V
													V
													V
													V
													V
													V
													V
													V
													V
													V
													V
													V
													V
													V
													V
Remark	<ol style="list-style-type: none"> No other spurious found. All results are PASS against Peak and Average limit line. The emission position marked as "-" means no suspected emission found with sufficient margin against limit line or noise floor only. 												



UNII- 4 5850~5895MHz
WIFI 802.11ax HE40_Full (Band Edge @ 3m)

WIFI Ant. 7+3	Note	Frequency (MHz)	Level (dBμV/m)	Margin (dB)	Limit Line (dBμV/m)	Read Level (dBμV)	Antenna Factor (dB/m)	Path Loss (dB)	Preamp Factor (dB)	Ant Pos (cm)	Table Pos (deg)	Peak Avg. (P/A)	Pol. (H/V)
		5603.54	51.39	-16.81	68.2	45.58	33.01	9.52	36.72	262	288	P	H
		5688.5	54.81	-41.91	96.72	48.41	33.56	9.56	36.72	262	288	P	H
		5700.89	52.9	-52.55	105.45	46.34	33.71	9.57	36.72	262	288	P	H
		5724.195	51.17	-69.19	120.36	44.46	33.85	9.58	36.72	262	288	P	H
	*	5835	100.5	-	-	93.35	34.2	9.66	36.71	262	288	P	H
	*	5835	100.48	-	-	93.33	34.2	9.66	36.71	262	288	A	H
		5899.25	62.35	-44.73	107.08	55.02	34.3	9.74	36.71	262	288	P	H
		5933	55.6	-32.6	88.2	48.35	34.17	9.79	36.71	262	288	P	H
		5896.75	53.19	-35.72	88.91	45.87	34.29	9.74	36.71	262	288	A	H
		5929.25	44.71	-23.49	68.2	37.46	34.18	9.78	36.71	262	288	A	H
802.11ax													H
HE40 Full													H
CH 167		5649.56	50.01	-18.19	68.2	44.09	33.1	9.54	36.72	150	338	P	V
5835MHz		5699.415	51.12	-53.65	104.77	44.59	33.69	9.56	36.72	150	338	P	V
		5704.43	51.18	-55.26	106.44	44.6	33.73	9.57	36.72	150	338	P	V
		5722.425	53.13	-63.2	116.33	46.44	33.83	9.58	36.72	150	338	P	V
	*	5835	103.75	-	-	96.6	34.2	9.66	36.71	150	338	P	V
	*	5835	103.2	-	-	96.05	34.2	9.66	36.71	150	338	A	V
		5899.75	71.47	-35.24	106.71	64.14	34.3	9.74	36.71	150	338	P	V
		5927.75	61.43	-26.77	88.2	54.17	34.19	9.78	36.71	150	338	P	V
		5895.25	57.58	-32.44	90.02	50.26	34.29	9.74	36.71	150	338	A	V
		5925	49.06	-19.14	68.2	41.79	34.2	9.78	36.71	150	338	A	V
													V
													V



WIFI Ant. 7+3	Note	Frequency (MHz)	Level (dBµV/m)	Margin (dB)	Limit Line (dBµV/m)	Read Level (dBµV)	Antenna Factor (dB/m)	Path Loss (dB)	Preamp Factor (dB)	Ant Pos (cm)	Table Pos (deg)	Peak Avg. (P/A)	Pol. (H/V)
		5643.955	49.1	-19.1	68.2	43.19	33.09	9.54	36.72	262	287	P	H
		5686.73	49.61	-45.8	95.41	43.23	33.54	9.56	36.72	262	287	P	H
		5713.87	50.01	-59.08	109.09	43.38	33.78	9.57	36.72	262	287	P	H
		5720.655	48.48	-63.81	112.29	41.81	33.82	9.57	36.72	262	287	P	H
	*	5875	100.04	-	-	92.79	34.25	9.71	36.71	262	287	P	H
	*	5875	100.36	-	-	93.11	34.25	9.71	36.71	262	287	A	H
		5901.75	86.36	-18.88	105.24	79.03	34.29	9.75	36.71	262	287	P	H
		5926.25	75.46	-12.74	88.2	68.2	34.19	9.78	36.71	262	287	P	H
		5897	75.14	-13.59	88.73	67.82	34.29	9.74	36.71	262	287	A	H
		5925	61.33	-6.87	68.2	54.06	34.2	9.78	36.71	262	287	A	H
802.11ax													H
HE40 Full													H
CH 175		5625.96	49.55	-18.65	68.2	43.69	33.05	9.53	36.72	154	337	P	V
5875MHz		5677.585	50.53	-38.12	88.65	44.27	33.43	9.55	36.72	154	337	P	V
		5713.28	51.5	-57.42	108.92	44.87	33.78	9.57	36.72	154	337	P	V
		5721.245	50.45	-63.19	113.64	43.77	33.83	9.57	36.72	154	337	P	V
	*	5875	104.7	-	-	97.45	34.25	9.71	36.71	154	337	P	V
	*	5875	103.99	-	-	96.74	34.25	9.71	36.71	154	337	A	V
		5895.5	90.36	-19.47	109.83	83.04	34.29	9.74	36.71	154	337	P	V
		5925	76.36	-11.84	88.2	69.09	34.2	9.78	36.71	154	337	P	V
		5895.25	80.18	-9.84	90.02	72.86	34.29	9.74	36.71	154	337	A	V
		5925	65.48	-2.72	68.2	58.21	34.2	9.78	36.71	154	337	A	V
													V
													V
Remark	<ol style="list-style-type: none"> No other spurious found. All results are PASS against Peak and Average limit line. 												



UNII- 4 5850~5895MHz
WIFI 802.11ax HE40_Full (Harmonic @ 3m)

WIFI Ant. 7+3	Note	Frequency (MHz)	Level (dBμV/m)	Margin (dB)	Limit Line (dBμV/m)	Read Level (dBμV)	Antenna Factor (dB/m)	Path Loss (dB)	Preamp Factor (dB)	Ant Pos (cm)	Table Pos (deg)	Peak Avg. (P/A)	Pol. (H/V)	
802.11ax HE40 Full CH 167 5835MHz		11670	45.92	-28.08	74	51.31	38.7	13.61	57.7	-	-	P	H	
		17505	54.2	-14	68.2	58.93	38.52	16.72	59.97	100	265	P	H	
													H	
													H	
													H	
													H	
													H	
													H	
													H	
													H	
													H	
													H	
			11670	45.9	-28.1	74	51.25	38.7	13.61	57.66	-	-	P	V
			17505	58.64	-9.56	68.2	63.1	38.52	16.72	59.7	300	354	P	V
														V
														V
														V
														V
													V	
													V	
													V	
													V	



WIFI Ant. 7+3	Note	Frequency (MHz)	Level (dBμV/m)	Margin (dB)	Limit Line (dBμV/m)	Read Level (dBμV)	Antenna Factor (dB/m)	Path Loss (dB)	Preamp Factor (dB)	Ant Pos (cm)	Table Pos (deg)	Peak Avg. (P/A)	Pol. (H/V)	
802.11ax HE40 Full CH 175 5875MHz		11750	44.58	-29.42	74	49.86	38.7	13.66	57.64	-	-	P	H	
		17625	54.93	-13.27	68.2	58.96	39.03	16.79	59.85	246	54	P	H	
													H	
													H	
													H	
													H	
													H	
													H	
													H	
													H	
													H	
													H	
													H	
													H	
													H	
													H	
													H	
													H	
			11750	45.12	-28.88	74	50.36	38.7	13.66	57.6	-	-	P	V
			17625	59.69	-8.51	68.2	63.47	39.03	16.79	59.6	298	352	P	V
													V	
													V	
													V	
													V	
													V	
													V	
													V	
													V	
													V	
													V	
													V	
													V	
													V	
Remark	<ol style="list-style-type: none"> No other spurious found. All results are PASS against Peak and Average limit line. The emission position marked as "-" means no suspected emission found with sufficient margin against limit line or noise floor only. 													



UNII- 4 5850~5895MHz
WIFI 802.11ax HE80_Full (Band Edge @ 3m)

WIFI Ant. 7+3	Note	Frequency (MHz)	Level (dBμV/m)	Margin (dB)	Limit Line (dBμV/m)	Read Level (dBμV)	Antenna Factor (dB/m)	Path Loss (dB)	Preamp Factor (dB)	Ant Pos (cm)	Table Pos (deg)	Peak Avg. (P/A)	Pol. (H/V)
		5636.58	52.33	-15.87	68.2	46.44	33.07	9.54	36.72	270	288	P	H
		5696.465	54.35	-48.24	102.59	47.85	33.66	9.56	36.72	270	288	P	H
		5719.77	57.35	-53.39	110.74	50.68	33.82	9.57	36.72	270	288	P	H
		5721.835	56.63	-58.35	114.98	49.95	33.83	9.57	36.72	270	288	P	H
	*	5855	97.4	-	-	90.22	34.21	9.68	36.71	270	288	P	H
	*	5855	96.64	-	-	89.46	34.21	9.68	36.71	270	288	A	H
		5897.25	79.54	-29.01	108.55	72.22	34.29	9.74	36.71	270	288	P	H
		5929.5	73.25	-14.95	88.2	66	34.18	9.78	36.71	270	288	P	H
		5895.25	67.65	-22.37	90.02	60.33	34.29	9.74	36.71	270	288	A	H
		5926.5	61.91	-6.29	68.2	54.65	34.19	9.78	36.71	270	288	A	H
802.11ax													H
HE80 Full													H
CH 171		5637.76	51.7	-16.5	68.2	45.8	33.08	9.54	36.72	137	338	P	V
5855MHz		5699.12	54.57	-49.98	104.55	48.04	33.69	9.56	36.72	137	338	P	V
		5702.955	55.72	-50.31	106.03	49.15	33.72	9.57	36.72	137	338	P	V
		5724.785	56.07	-65.64	121.71	49.36	33.85	9.58	36.72	137	338	P	V
	*	5855	101.07	-	-	93.89	34.21	9.68	36.71	137	338	P	V
	*	5855	99.79	-	-	92.61	34.21	9.68	36.71	137	338	A	V
		5895.75	82.85	-26.8	109.65	75.53	34.29	9.74	36.71	137	338	P	V
		5926	76.73	-11.47	88.2	69.46	34.2	9.78	36.71	137	338	P	V
		5895.25	72.23	-17.79	90.02	64.91	34.29	9.74	36.71	137	338	A	V
		5925	66.34	-1.86	68.2	59.07	34.2	9.78	36.71	137	338	A	V
													V
													V
Remark	1. No other spurious found. 2. All results are PASS against Peak and Average limit line.												



UNII- 4 5850~5895MHz
WIFI 802.11ax HE80_Full (Harmonic @ 3m)

WIFI Ant. 7+3	Note	Frequency (MHz)	Level (dBμV/m)	Margin (dB)	Limit Line (dBμV/m)	Read Level (dBμV)	Antenna Factor (dB/m)	Path Loss (dB)	Preamp Factor (dB)	Ant Pos (cm)	Table Pos (deg)	Peak Avg. (P/A)	Pol. (H/V)	
802.11ax HE80 Full CH 171 5855MHz		11710	44.74	-29.26	74	50.08	38.7	13.63	57.67	-	-	P	H	
		17565	47.11	-21.09	68.2	51.51	38.76	16.75	59.91	-	-	P	H	
													H	
													H	
													H	
													H	
													H	
													H	
													H	
													H	
													H	
													H	
													H	
													H	
													H	
													H	
													H	
													H	
			11710	45.06	-28.94	74	50.36	38.7	13.63	57.63	-	-	P	V
			17565	55.35	-12.85	68.2	59.49	38.76	16.75	59.65	310	351	P	V
													V	
													V	
													V	
													V	
													V	
													V	
													V	
													V	
													V	
													V	
													V	
													V	
Remark	<ol style="list-style-type: none"> No other spurious found. All results are PASS against Peak and Average limit line. The emission position marked as "-" means no suspected emission found with sufficient margin against limit line or noise floor only. 													



Emission above 18GHz

5GHz WIFI 802.11ax HE80 Full (SHF @ 1m)

WIFI	Note	Frequency	Level	Margin	Limit	Read	Antenna	Path	Preamp	Ant	Table	Peak	Pol.	
Ant.					Line	Level	Factor	Loss	Factor	Pos	Pos	Avg.		
7+3		(MHz)	(dBμV/m)	(dB)	(dBμV/m)	(dBμV)	(dB/m)	(dB)	(dB)	(cm)	(deg)	(P/A)	(H/V)	
802.11ax HE80 Full SHF		39516	49.19	-24.81	74	61.24	44.69	-0.46	56.28	-	-	P	H	
		39516	39.07	-14.93	54	51.12	44.69	-0.46	56.28	-	-	P	H	
													H	
													H	
													H	
													H	
													H	
													H	
													H	
													H	
													H	
			39824	48	-26	74	59.68	44.5	-0.2	55.98	-	-	P	V
			39824	37.7	-16.3	54	49.38	44.5	-0.2	55.98	-	-	P	V
														V
														V
														V
														V
														V
														V
														V
Remark	<ol style="list-style-type: none"> No other spurious found. All results are PASS against limit line. The emission position marked as "-" means no suspected emission found with sufficient margin against limit line or noise floor only. 													



Emission below 1GHz

5GHz WIFI 802.11ax HE80 Full (LF @ 3m)

WIFI	Note	Frequency	Level	Margin	Limit	Read	Antenna	Path	Preamp	Ant	Table	Peak	Pol.	
Ant.					Line	Level	Factor	Loss	Factor	Pos	Pos	Avg.		
7+3		(MHz)	(dBμV/m)	(dB)	(dBμV/m)	(dBμV)	(dB/m)	(dB)	(dB)	(cm)	(deg)	(P/A)	(H/V)	
802.11ax HE80 Full LF		30	23.1	-16.9	40	30.63	24.3	0.64	32.47	-	-	P	H	
		137.67	31.09	-12.41	43.5	44.83	17.36	1.4	32.5	-	-	P	H	
		193.93	31.75	-11.75	43.5	47.75	14.71	1.78	32.49	-	-	P	H	
		296.75	32.46	-13.54	46	43.71	19.06	2.09	32.4	-	-	P	H	
		586.78	26.39	-19.61	46	30.32	25.62	2.96	32.51	-	-	P	H	
		777.87	29.15	-16.85	46	30.14	27.88	3.39	32.26	-	-	P	H	
														H
														H
														H
														H
														H
														H
			33.88	31.61	-8.39	40	40.9	22.46	0.75	32.5	-	-	P	V
			94.99	29.84	-13.66	43.5	45.92	15.17	1.21	32.46	-	-	P	V
			193.93	31.13	-12.37	43.5	47.13	14.71	1.78	32.49	-	-	P	V
			293.84	32.21	-13.79	46	43.52	19.02	2.08	32.41	-	-	P	V
			600.36	31.25	-14.75	46	35.33	25.44	2.99	32.51	-	-	P	V
			719.67	32.19	-13.81	46	34.53	26.78	3.23	32.35	-	-	P	V
														V
														V
													V	
													V	
													V	
													V	

Remark

- No other spurious found.
- All results are PASS against limit line.
- The emission position marked as "-" means no suspected emission found and emission level has at least 6dB margin against limit or emission is noise floor only.



Note symbol

*	Fundamental Frequency which can be ignored. However, the level of any unwanted emissions shall not exceed the level of the fundamental frequency.
!	Test result is Margin line.
P/A	Peak or Average
H/V	Horizontal or Vertical



A calculation example for radiated spurious emission is shown as below:

WIFI	Note	Frequency	Level	Margin	Limit	Read	Antenna	Path	Preamp	Ant	Table	Peak	Pol.
Ant.					Line	Level	Factor	Loss	Factor	Pos	Pos	Avg.	
7+3		(MHz)	(dBμV/m)	(dB)	(dBμV/m)	(dBμV)	(dB/m)	(dB)	(dB)	(cm)	(deg)	(P/A)	(H/V)
802.11a CH 169 5845MHz		5945	52.49	-55.71	108.2	40.04	35.11	12.54	35.2	380	248	P	H

1. Path Loss(dB) = Cable loss(dB) + Filter loss(dB) + Attenuator loss(dB)
2. Level(dBμV/m) = Antenna Factor(dB/m) + Path Loss(dB) + Read Level(dBμV) - Preamp Factor(dB)
3. Margin(dB) = Level(dBμV/m) – Limit Line(dBμV/m)

For Peak Limit @ 11690MHz:

1. Level(dBμV/m)
= Antenna Factor(dB/m) + Path Loss(dB) + Read Level(dBμV) - Preamp Factor(dB)
= 38.48(dB/m) + 19.48(dB) + 49.34(dBμV) – 56.59 (dB)
= 50.71 (dBμV/m)
2. Margin(dB)
= Level(dBμV/m) – Limit Line(dBμV/m)
= 50.71(dBμV/m) – 74(dBμV/m)
= -23.29(dB)

For Average Limit @ 11690MHz:

3. Level(dBμV/m)
= Antenna Factor(dB/m) + Path Loss(dB) + Read Level(dBμV) - Preamp Factor(dB)
= 38.48(dB/m) + 19.48(dB) + 41.55(dBμV) – 56.59 (dB)
= 42.92 (dBμV/m)
4. Margin(dB)
= Level(dBμV/m) – Limit Line(dBμV/m)
= 42.92(dBμV/m) – 54(dBμV/m)
= -11.08(dB)

The average measured complies with the limit line, so test result is "PASS".



Appendix D. Radiated Spurious Emission Plots

Test Engineer :	Eric Xaio, Bigshow Wang and Quentin Liu	Temperature :	21.1~23.1°C
		Relative Humidity :	49~58%

Note symbol

-L	Low channel location
-R	High channel location



UNII-4 - 5850~5895MHz
WIFI 802.11a (Band Edge @ 3m)

WIFI	UNII- 4 5850~5895MHz Band Edge @ 3m	
ANT	802.11a CH169 5845MHz - L	
7+3	Horizontal	Fundamental
Peak	<p>Site : 03CH15-HY Condition : PEAK_SE[UNII4]_16-24_3m 91200_02294_220623 HORIZONTAL : RBW:1000.000kHz VBW:3000.000kHz SWT:Auto</p>	<p>Site : 03CH15-HY Condition : PEAK[UNII] 3m 91200_02294_220623 HORIZONTAL : RBW:1000.000kHz VBW:3000.000kHz SWT:Auto</p>
Avg.	Left blank	<p>Site : 03CH15-HY Condition : AVG_54 3m 91200_02294_220623 HORIZONTAL : RBW:1000.000kHz VBW:1.000kHz SWT:Auto</p>

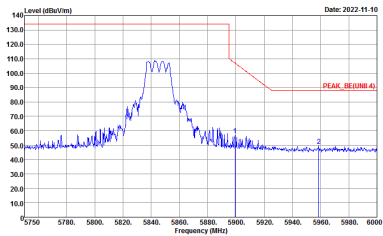
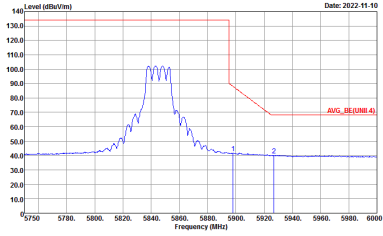

WIFI	UNII- 4 5850-5895MHz Band Edge @ 3m	
ANT	802.11a CH169 5845MHz - R	
7+3	Horizontal	Fundamental
<p>Peak</p>	 <p>Site : 03CH15-HY Condition : PEAK_BE(UNIT 4) 3m 91200_02294_220623 HORIZONTAL : RBW:1000.000KHz VBW:3000.000KHz SWT:Auto</p>	<p>Left blank</p>
<p>Avg.</p>	 <p>Site : 03CH15-HY Condition : AVG_BE(UNIT 4) 3m 91200_02294_220623 HORIZONTAL : RBW:1000.000KHz VBW:11000KHz SWT:Auto</p>	<p>Left blank</p>



WIFI	UNII- 4 5850-5895MHz Band Edge @ 3m	
ANT	802.11a CH169 5845MHz - L	
7+3	Vertical	Fundamental
Peak	<p>Site : 03CH15-HY Condition : PEAK_08(UNII4)_16-24 3m 91200_02294_220623 VERTICAL : RBW:1000.000KHz VBW:3000.000KHz SWT:Auto</p>	<p>Site : 03CH15-HY Condition : PEAK(UNII) 3m 91200_02294_220623 VERTICAL : RBW:1000.000KHz VBW:3000.000KHz SWT:Auto</p>
Avg.	Left blank	
		<p>Site : 03CH15-HY Condition : AVG_54 3m 91200_02294_220623 VERTICAL : RBW:1000.000KHz VBW:1000KHz SWT:Auto</p>

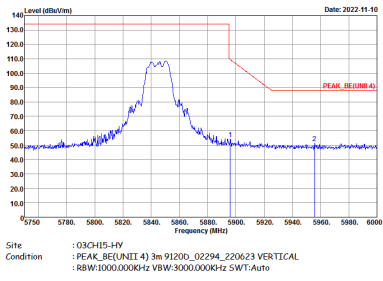
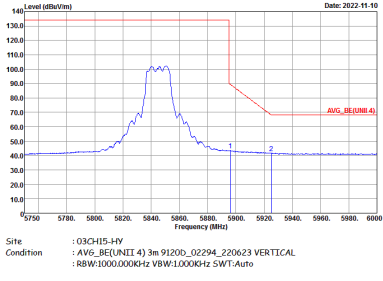

WIFI	UNII- 4 5850-5895MHz Band Edge @ 3m	
ANT	802.11a CH169 5845MHz - R	
7+3	Vertical	Fundamental
<p>Peak</p>		<p>Left blank</p>
<p>Avg.</p>		<p>Left blank</p>



WIFI	UNII- 4 5850~5895MHz Band Edge @ 3m	
ANT	802.11a CH173 5865MHz - L	
7+3	Horizontal	Fundamental
Peak	<p>Site : 03CH15-HY Condition : PEAK_REF(UNII4)_16-24 3m 91200_02294_220623 HORIZONTAL : RBW:1000.000KHz VBW:3000.000KHz SWT:Auto</p>	<p>Site : 03CH15-HY Condition : PEAK(UMR) 3m 91200_02294_220623 HORIZONTAL : RBW:1000.000KHz VBW:3000.000KHz SWT:Auto</p>
Avg.	Left blank	<p>Site : 03CH15-HY Condition : AVG_54 3m 91200_02294_220623 HORIZONTAL : RBW:1000.000KHz VBW:1000KHz SWT:Auto</p>



WIFI	UNII- 4 5850-5895MHz Band Edge @ 3m	
ANT	802.11a CH173 5865MHz – R	
7+3	Horizontal	Fundamental
<p>Peak</p>		<p>Left blank</p>
<p>Avg.</p>		<p>Left blank</p>

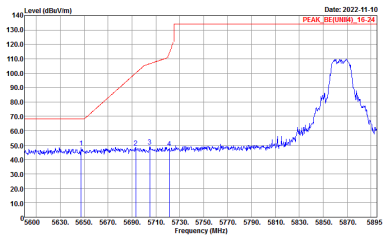
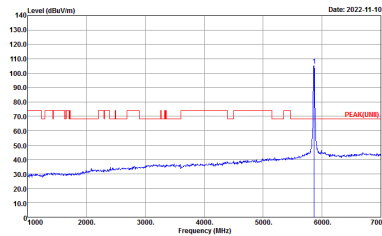
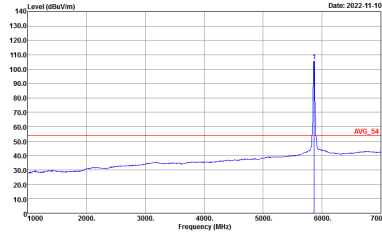

WIFI	UNII- 4 5850-5895MHz Band Edge @ 3m	
ANT	802.11a CH173 5865MHz - L	
7+3	Vertical	Fundamental
Peak	 <p>Site : 03CH15-HY Condition : PEAK_BC(UNII4)_16-24 3m 91200_02294_220623 VERTICAL : RBW:1000.000KHz VBW:3000.000KHz SWT:Auto</p>	 <p>Site : 03CH15-HY Condition : PEAK(LINE3) 3m 91200_02294_220623 VERTICAL : RBW:1000.000KHz VBW:3000.000KHz SWT:Auto</p>
Avg.	Left blank	
		 <p>Site : 03CH15-HY Condition : AV6_54 3m 91200_02294_220623 VERTICAL : RBW:1000.000KHz VBW:1000KHz SWT:Auto</p>

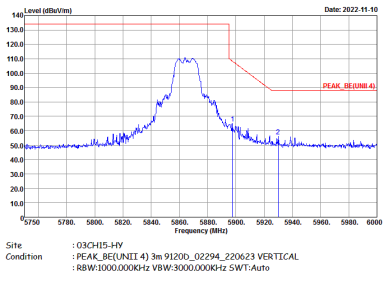
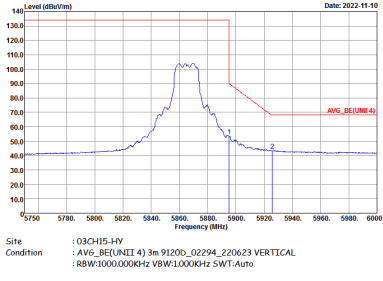

WIFI	UNII- 4 5850-5895MHz Band Edge @ 3m	
ANT	802.11a CH173 5865MHz – R	
7+3	Vertical	Fundamental
<p>Peak</p>		<p>Left blank</p>
<p>Avg.</p>		<p>Left blank</p>

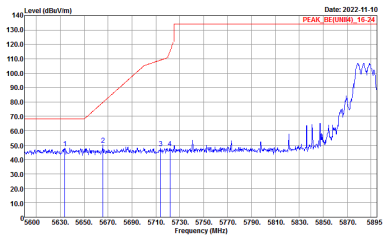
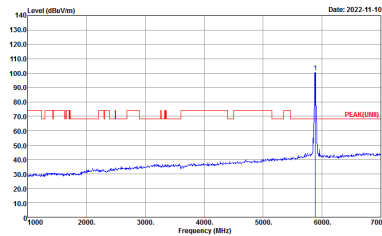
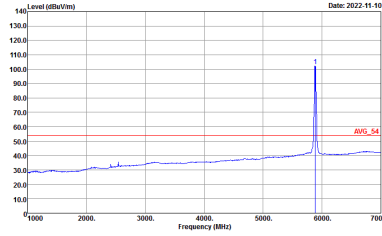

WIFI	UNII- 4 5850~5895MHz Band Edge @ 3m	
ANT	802.11a CH177 5885MHz - L	
7+3	Horizontal	Fundamental
Peak	 <p>Site : 03CH15-HY Condition : PEAK_BC(UNII4)_16-24 3m 91200_02294_220623 HORIZONTAL : RBW:1000.000KHz VBW:3000.000KHz SWT:Auto</p>	 <p>Site : 03CH15-HY Condition : PEAK(LINE3) 3m 91200_02294_220623 HORIZONTAL : RBW:1000.000KHz VBW:3000.000KHz SWT:Auto</p>
Avg.	Left blank	
		 <p>Site : 03CH15-HY Condition : AV6_54 3m 91200_02294_220623 HORIZONTAL : RBW:1000.000KHz VBW:1000KHz SWT:Auto</p>



WIFI	UNII- 4 5850-5895MHz Band Edge @ 3m	
ANT	802.11a CH177 5885MHz - R	
7+3	Horizontal	Fundamental
<p>Peak</p>	<p>Site : 03CH15-HY Condition : PEAK_BE(UNIT 4) 3m 91200_02294_220623 HORIZONTAL : RBW:1000.000KHz VBW:3000.000KHz SWT:Auto</p>	<p>Left blank</p>
<p>Avg.</p>	<p>Site : 03CH15-HY Condition : AVG_BE(UNIT 4) 3m 91200_02294_220623 HORIZONTAL : RBW:1000.000KHz VBW:11000KHz SWT:Auto</p>	<p>Left blank</p>

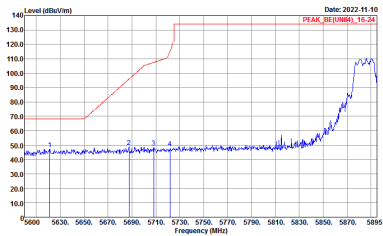
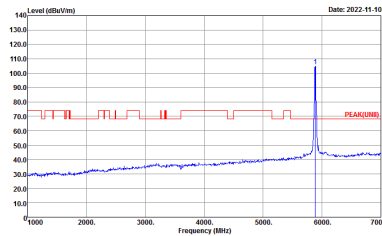
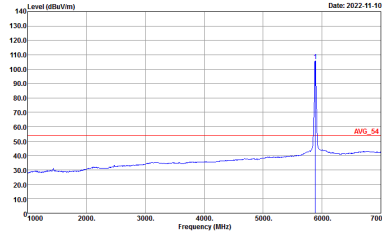

WIFI	UNII- 4 5850~5895MHz Band Edge @ 3m	
ANT	802.11a CH177 5885MHz - L	
7+3	Vertical	Fundamental
Peak	 <p>Site : 03CH15-HY Condition : PEAK_06(UNII)4_16-24 3m 91200_02294_220623 VERTICAL : RBW:1000.000KHz VBW:3000.000KHz SWT:Auto</p>	 <p>Site : 03CH15-HY Condition : PEAK(LINE)3 3m 91200_02294_220623 VERTICAL : RBW:1000.000KHz VBW:3000.000KHz SWT:Auto</p>
Avg.	Left blank	
		 <p>Site : 03CH15-HY Condition : AV6_54 3m 91200_02294_220623 VERTICAL : RBW:1000.000KHz VBW:1000KHz SWT:Auto</p>

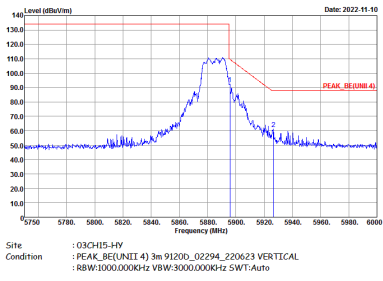
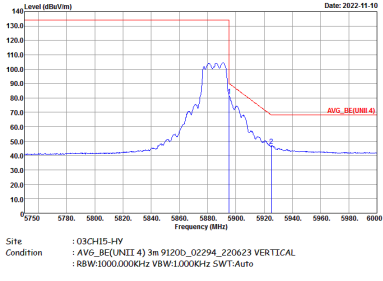

WIFI	UNII- 4 5850-5895MHz Band Edge @ 3m	
ANT	802.11a CH177 5885MHz - R	
7+3	Vertical	Fundamental
<p>Peak</p>		<p>Left blank</p>
<p>Avg.</p>		<p>Left blank</p>

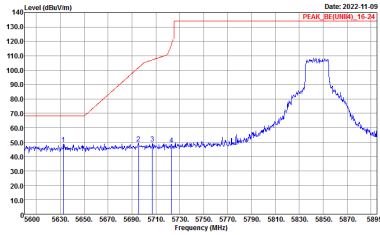
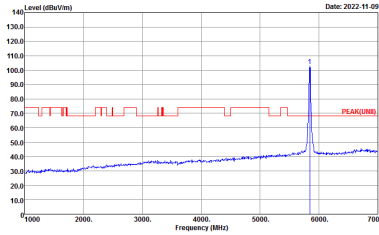
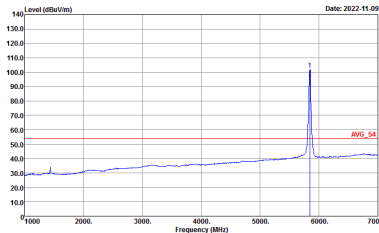

UNII-4 - 5850~5895MHz
WIFI 802.11ax HE20 Full (Band Edge @ 3m)

WIFI	UNII- 4 5850~5895MHz Band Edge @ 3m	
ANT	802.11ax HE20 Full CH169 5845MHz - L	
7+3	Horizontal	Fundamental
Peak	 <p>Site : 03CH15-HY Condition : PEAK_BE(UNII4)_16-24 3m 91200_02294_220623 HORIZONTAL : RBW:1000.000KHz VBW:3000.000KHz SWT:Auto</p>	 <p>Site : 03CH15-HY Condition : PEAK(UNII) 3m 91200_02294_220623 HORIZONTAL : RBW:1000.000KHz VBW:3000.000KHz SWT:Auto</p>
Avg.	Left blank	 <p>Site : 03CH15-HY Condition : AVG_54 3m 91200_02294_220623 HORIZONTAL : RBW:1000.000KHz VBW:1000KHz SWT:Auto</p>



WIFI	UNII- 4 5850-5895MHz Band Edge @ 3m	
ANT	802.11ax HE20 Full CH169 5845MHz - R	
7+3	Horizontal	Fundamental
Peak	<p>Site : 03CH15-HY Condition : PEAK_BE(UNIT 4) 3m 91200_02294_220623 HORIZONTAL : RBW:1000.000KHz VBW:3000.000KHz SWT:Auto</p>	Left blank
Avg.	<p>Site : 03CH15-HY Condition : AVG_BE(UNIT 4) 3m 91200_02294_220623 HORIZONTAL : RBW:1000.000KHz VBW:1000KHz SWT:Auto</p>	Left blank

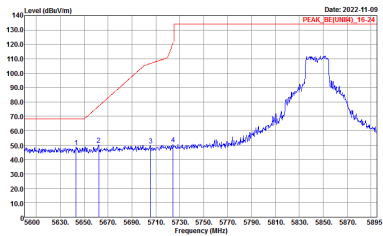
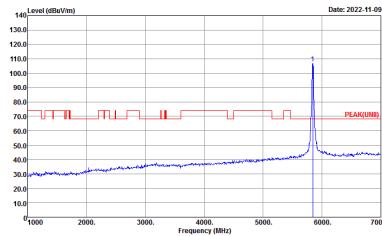
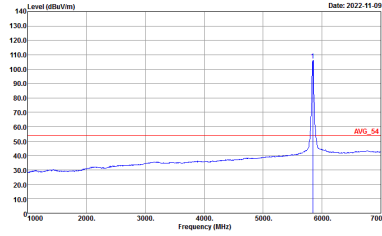

WIFI	UNII- 4 5850~5895MHz Band Edge @ 3m	
ANT	802.11ax HE20 Full CH169 5845MHz - L	
7+3	Vertical	Fundamental
Peak	 <p>Site : 03CH15-HY Condition : PEAK_SE(UNII4)_16-24 3m 91200_02294_220623 VERTICAL : RBW:1000.000KHz VBW:3000.000KHz SWT:Auto</p>	 <p>Site : 03CH15-HY Condition : PEAK(LINE3) 3m 91200_02294_220623 VERTICAL : RBW:1000.000KHz VBW:3000.000KHz SWT:Auto</p>
Avg.	Left blank	 <p>Site : 03CH15-HY Condition : AV6_54 3m 91200_02294_220623 VERTICAL : RBW:1000.000KHz VBW:1000KHz SWT:Auto</p>

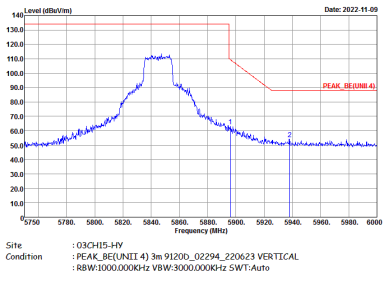
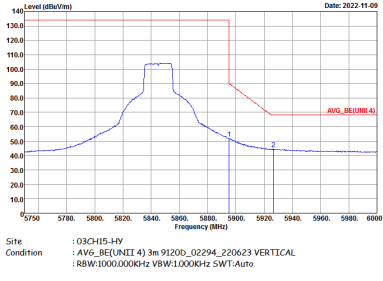

WIFI	UNII- 4 5850~5895MHz Band Edge @ 3m	
ANT	802.11ax HE20 Full CH169 5845MHz - R	
7+3	Vertical	Fundamental
<p>Peak</p>		<p>Left blank</p>
<p>Avg.</p>		<p>Left blank</p>

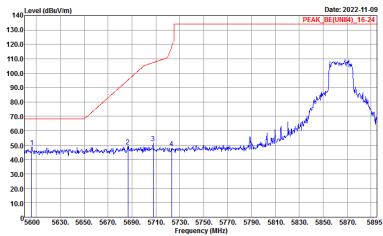
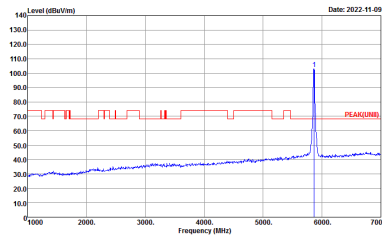
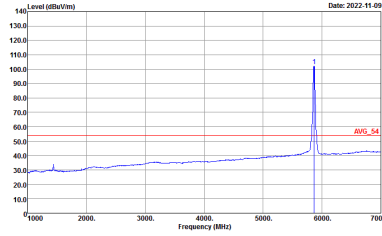

WIFI	UNII- 4 5850~5895MHz Band Edge @ 3m	
ANT	802.11ax HE20 Full CH173 5865MHz - L	
7+3	Horizontal	Fundamental
Peak	 <p>Site : 03CH15-HY Condition : PEAK_8C(UNII)4_16-24 3m 91200_02294_220623 HORIZONTAL : RBW:1000.000KHz VBW:3000.000KHz SWT:Auto</p>	 <p>Site : 03CH15-HY Condition : PEAK(LINE)3 3m 91200_02294_220623 HORIZONTAL : RBW:1000.000KHz VBW:3000.000KHz SWT:Auto</p>
Avg.	Left blank	
		 <p>Site : 03CH15-HY Condition : AV6_54 3m 91200_02294_220623 HORIZONTAL : RBW:1000.000KHz VBW:1000KHz SWT:Auto</p>



WIFI	UNII- 4 5850~5895MHz Band Edge @ 3m	
ANT	802.11ax HE20 Full CH173 5865MHz - R	
7+3	Horizontal	Fundamental
<p>Peak</p>		<p>Left blank</p>
<p>Avg.</p>		<p>Left blank</p>

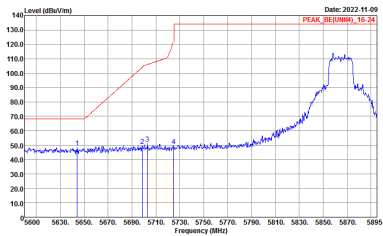
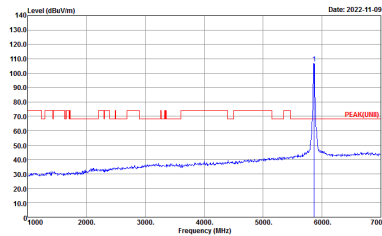
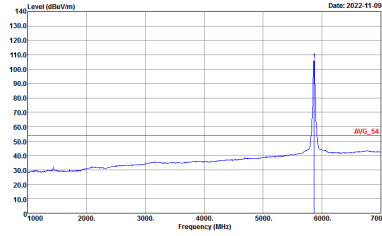

WIFI	UNII- 4 5850~5895MHz Band Edge @ 3m	
ANT	802.11ax HE20 Full CH173 5865MHz - L	
7+3	Vertical	Fundamental
Peak	 <p>Site : 03CH15-HY Condition : PEAK_8C(UNII)4_16-24 3m 91200_02294_220623 VERTICAL : RBW:1000.000KHz VBW:3000.000KHz SWT:Auto</p>	 <p>Site : 03CH15-HY Condition : PEAK(LINE)3 3m 91200_02294_220623 VERTICAL : RBW:1000.000KHz VBW:3000.000KHz SWT:Auto</p>
Avg.	Left blank	
		 <p>Site : 03CH15-HY Condition : AV6_54 3m 91200_02294_220623 VERTICAL : RBW:1000.000KHz VBW:1000KHz SWT:Auto</p>



WIFI	UNII- 4 5850~5895MHz Band Edge @ 3m	
ANT	802.11ax HE20 Full CH173 5865MHz - R	
7+3	Vertical	Fundamental
<p>Peak</p>	<p>Site : 03CH15-HY Condition : PEAK_BE(UNII 4) 3m 91200_02294_220623 VERTICAL : RBW:1000.000KHz VBW:3000.000KHz SWT:Auto</p>	<p>Left blank</p>
<p>Avg.</p>	<p>Site : 03CH15-HY Condition : AVG_BE(UNII 4) 3m 91200_02294_220623 VERTICAL : RBW:1000.000KHz VBW:11000KHz SWT:Auto</p>	<p>Left blank</p>

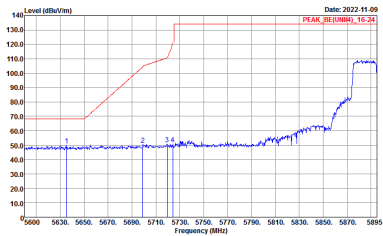
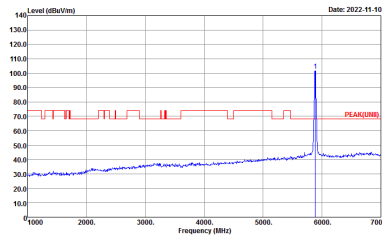
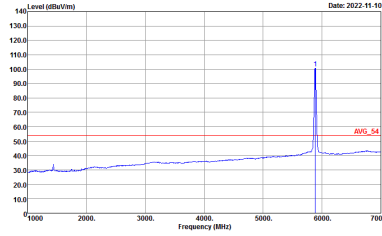

WIFI	UNII- 4 5850~5895MHz Band Edge @ 3m	
ANT	802.11ax HE20 Full CH177 5885MHz - L	
7+3	Horizontal	Fundamental
Peak	 <p>Site : 03CH15-HY Condition : PEAK_BE(UNII4)_16-24 3m 91200_02294_220623 HORIZONTAL</p>	 <p>Site : 03CH15-HY Condition : PEAK(UNII) 3m 91200_02294_220623 HORIZONTAL</p>
Avg.	Left blank	
		 <p>Site : 03CH15-HY Condition : AV6_54 3m 91200_02294_220623 HORIZONTAL</p>



WIFI	UNII- 4 5850~5895MHz Band Edge @ 3m	
ANT	802.11ax HE20 Full CH177 5885MHz - R	
7+3	Horizontal	Fundamental
<p>Peak</p>		<p>Left blank</p>
<p>Avg.</p>		<p>Left blank</p>

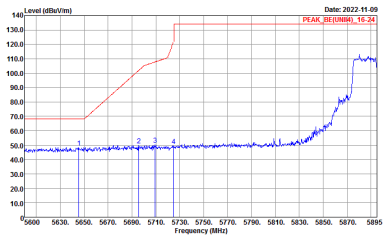
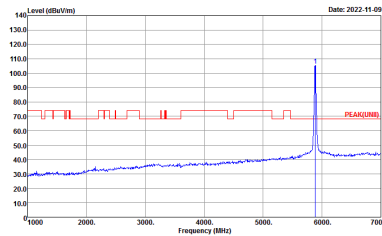
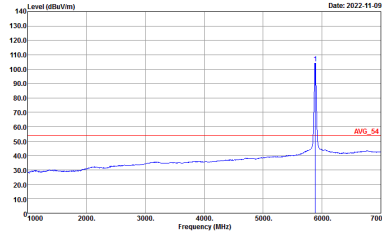

WIFI	UNII- 4 5850~5895MHz Band Edge @ 3m	
ANT	802.11ax HE20 Full CH177 5885MHz - L	
7+3	Vertical	Fundamental
Peak	 <p>Site : 03CH15-HY Condition : PEAK_BE(UNII4)_16-24 3m 91200_02294_220623 VERTICAL</p>	 <p>Site : 03CH15-HY Condition : PEAK(UNII) 3m 91200_02294_220623 VERTICAL</p>
Avg.	Left blank	 <p>Site : 03CH15-HY Condition : AV6_54 3m 91200_02294_220623 VERTICAL</p>



WIFI	UNII- 4 5850~5895MHz Band Edge @ 3m	
ANT	802.11ax HE20 Full CH177 5885MHz - R	
7+3	Vertical	Fundamental
<p>Peak</p>		<p>Left blank</p>
<p>Avg.</p>		<p>Left blank</p>



UNII-4 - 5850~5895MHz
WIFI 802.11ax HE40 Full (Band Edge @ 3m)

Table with 3 columns: WIFI, ANT, and 7+3. It contains two rows: 'Peak' and 'Avg.'. The 'Peak' row shows 'Horizontal' and 'Fundamental' plots. The 'Avg.' row shows a 'Left blank' plot. Each plot includes technical details like Site, Condition, and measurement parameters.



WIFI	UNII- 4 5850-5895MHz Band Edge @ 3m	
ANT	802.11ax HE40 Full CH167 5835MHz - R	
7+3	Horizontal	Fundamental
Peak	<p>Site : 03CH15-HY Condition : PEAK_BE(UNII 4) 3m 91200_02294_220623 HORIZONTAL : RBW:1000.000kHz VBW:3000.000kHz SWT:Auto</p>	Left blank
Avg.	<p>Site : 03CH15-HY Condition : AVG_BE(UNII 4) 3m 91200_02294_220623 HORIZONTAL : RBW:1000.000kHz VBW:11000kHz SWT:Auto</p>	Left blank

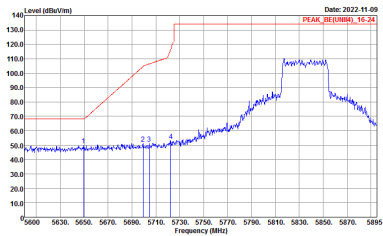
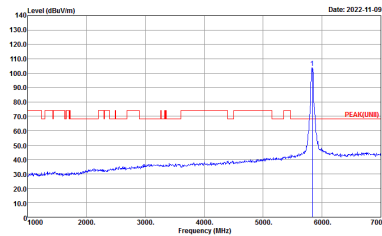
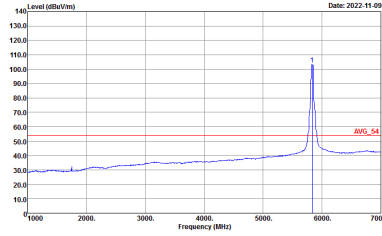

WIFI	UNII- 4 5850~5895MHz Band Edge @ 3m	
ANT	802.11ax HE40 Full CH167 5835MHz - L	
7+3	Vertical	Fundamental
Peak	 <p>Site : 03CH15-HY Condition : PEAK_SEQ(UNII4)_16-24 3m 91200_02294_220623 VERTICAL : RBW:1000.000KHz VBW:3000.000KHz SWT:Auto</p>	 <p>Site : 03CH15-HY Condition : PEAK(LINE3) 3m 91200_02294_220623 VERTICAL : RBW:1000.000KHz VBW:3000.000KHz SWT:Auto</p>
Avg.	Left blank	
		 <p>Site : 03CH15-HY Condition : AV6_54 3m 91200_02294_220623 VERTICAL : RBW:1000.000KHz VBW:1000KHz SWT:Auto</p>

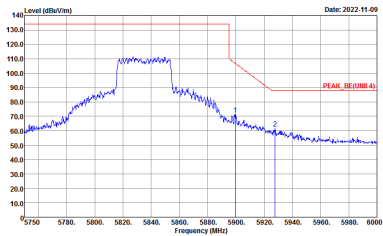
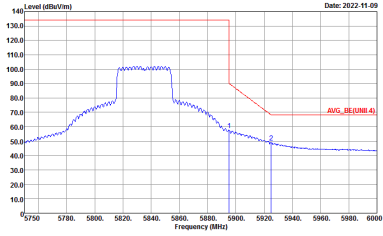

WIFI	UNII- 4 5850~5895MHz Band Edge @ 3m	
ANT	802.11ax HE40 Full CH167 5835MHz - R	
7+3	Vertical	Fundamental
<p>Peak</p>	 <p>Site : 03CH15-HY Condition : PEAK_BE(UNII 4) 3m 91200_02294_220623 VERTICAL : RBW:1000.000KHz VBW:3000.000KHz SWT:Auto</p>	<p>Left blank</p>
<p>Avg.</p>	 <p>Site : 03CH15-HY Condition : AVG_BE(UNII 4) 3m 91200_02294_220623 VERTICAL : RBW:1000.000KHz VBW:11000KHz SWT:Auto</p>	<p>Left blank</p>

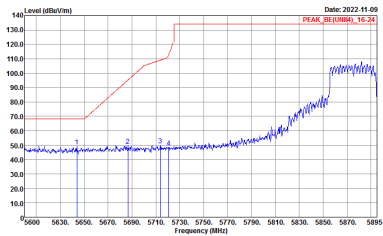
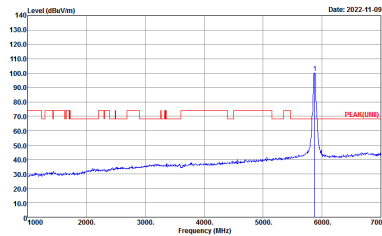
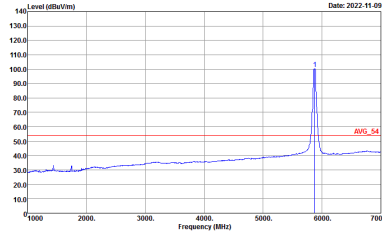

WIFI	UNII- 4 5850~5895MHz Band Edge @ 3m	
ANT	802.11ax HE40 Full CH175 5875MHz - L	
7+3	Horizontal	Fundamental
Peak	 <p>Site : 03CH15-HY Condition : PEAK_8E(UNII)4_16-24 3m 91200_02294_220623 HORIZONTAL : RBW:1000.000KHz VBW:3000.000KHz SWT:Auto</p>	 <p>Site : 03CH15-HY Condition : PEAK(LINE)3 3m 91200_02294_220623 HORIZONTAL : RBW:1000.000KHz VBW:3000.000KHz SWT:Auto</p>
Avg.	Left blank	
		 <p>Site : 03CH15-HY Condition : AV6_54 3m 91200_02294_220623 HORIZONTAL : RBW:1000.000KHz VBW:1000KHz SWT:Auto</p>

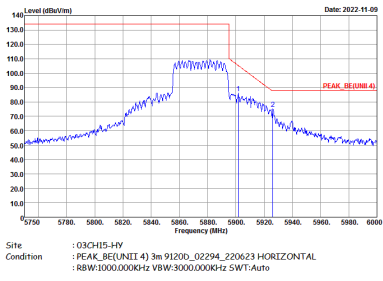
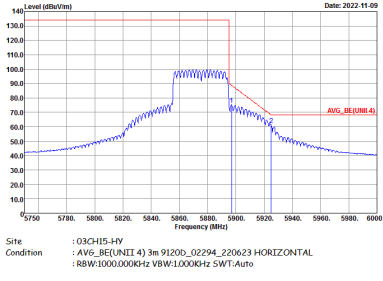

WIFI	UNII- 4 5850~5895MHz Band Edge @ 3m	
ANT	802.11ax HE40 Full CH175 5875MHz - R	
7+3	Horizontal	Fundamental
<p>Peak</p>		<p>Left blank</p>
<p>Avg.</p>		<p>Left blank</p>

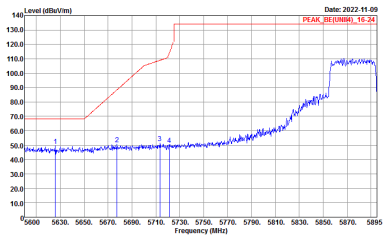
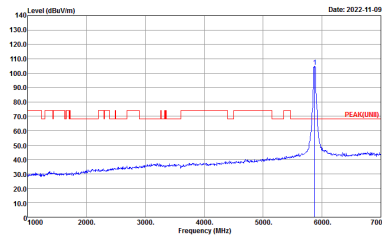
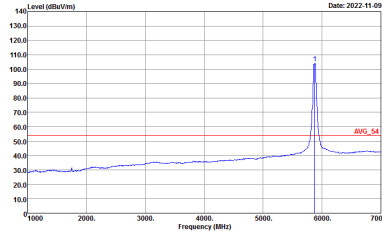

WIFI	UNII- 4 5850~5895MHz Band Edge @ 3m	
ANT	802.11ax HE40 Full CH175 5875MHz - L	
7+3	Vertical	Fundamental
Peak	 <p>Site : 03CH15-HY Condition : PEAK_8E(UNII)4_16-24 3m 91200_02294_220623 VERTICAL : RBW:1000.000KHz VBW:3000.000KHz SWT:Auto</p>	 <p>Site : 03CH15-HY Condition : PEAK(LINE)3 3m 91200_02294_220623 VERTICAL : RBW:1000.000KHz VBW:3000.000KHz SWT:Auto</p>
Avg.	Left blank	
		 <p>Site : 03CH15-HY Condition : AV6_54 3m 91200_02294_220623 VERTICAL : RBW:1000.000KHz VBW:1000KHz SWT:Auto</p>



WIFI	UNII- 4 5850-5895MHz Band Edge @ 3m	
ANT	802.11ax HE40 Full CH175 5875MHz - R	
7+3	Vertical	Fundamental
Peak	<p>Site : 03CH15-HY Condition : PEAK_BE(UNII 4) 3m 91200_02294_220623 VERTICAL : RBW:1000.000KHz VBW:3000.000KHz SWT:Auto</p>	Left blank
Avg.	<p>Site : 03CH15-HY Condition : AVG_BE(UNII 4) 3m 91200_02294_220623 VERTICAL : RBW:1000.000KHz VBW:1000KHz SWT:Auto</p>	Left blank



UNII-4 - 5850~5895MHz
WIFI 802.11ax HE80 Full (Band Edge @ 3m)

WIFI	UNII- 4 5850~5895MHz Band Edge @ 3m	
ANT	802.11ax HE80 Full CH171 5855MHz - L	
7+3	Horizontal	Fundamental
Peak	<p>Site : 03CH15-HY Condition : PEAK_BE(UNII4)_16-24 3m 91200_02294_220623 HORIZONTAL : RBW:1000.000KHz VBW:3000.000KHz SWT:Auto</p>	<p>Site : 03CH15-HY Condition : PEAK(UNII) 3m 91200_02294_220623 HORIZONTAL : RBW:1000.000KHz VBW:3000.000KHz SWT:Auto</p>
Avg.	Left blank	<p>Site : 03CH15-HY Condition : AVG_54 3m 91200_02294_220623 HORIZONTAL : RBW:1000.000KHz VBW:1000KHz SWT:Auto</p>



WIFI	UNII- 4 5850~5895MHz Band Edge @ 3m	
ANT	802.11ax HE80 Full CH171 5855MHz - R	
7+3	Horizontal	Fundamental
Peak	<p>Site : 03CH15-HY Condition : PEAK_BE(UNII.4) 3m 91200_02294_220623 HORIZONTAL : RBW:1000.000KHz VBW:3000.000KHz SWT:Auto</p>	Left blank
Avg.	<p>Site : 03CH15-HY Condition : AVG_BE(UNII.4) 3m 91200_02294_220623 HORIZONTAL : RBW:1000.000KHz VBW:1000KHz SWT:Auto</p>	Left blank

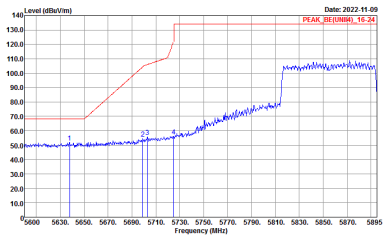
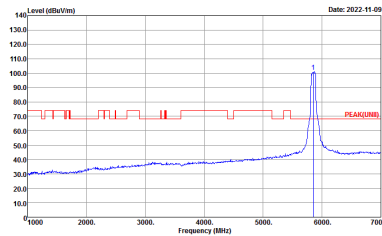
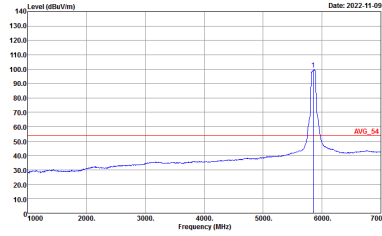

WIFI	UNII- 4 5850~5895MHz Band Edge @ 3m	
ANT	802.11ax HE80 Full CH171 5855MHz - L	
7+3	Vertical	Fundamental
Peak	 <p>Site : 03CH15-HY Condition : PEAK_SEQ(UNII4)_16-24 3m 91200_02294_220623 VERTICAL : RBW:1000.000KHz VBW:3000.000KHz SWT:Auto</p>	 <p>Site : 03CH15-HY Condition : PEAK(LINE3) 3m 91200_02294_220623 VERTICAL : RBW:1000.000KHz VBW:3000.000KHz SWT:Auto</p>
Avg.	Left blank	 <p>Site : 03CH15-HY Condition : AV6_54 3m 91200_02294_220623 VERTICAL : RBW:1000.000KHz VBW:1000KHz SWT:Auto</p>

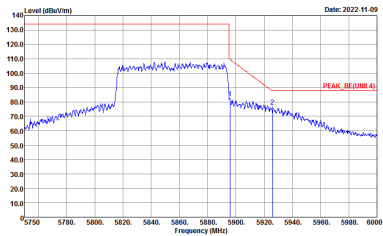
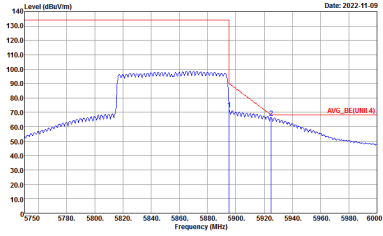

WIFI	UNII- 4 5850~5895MHz Band Edge @ 3m	
ANT	802.11ax HE80 Full CH171 5855MHz - R	
7+3	Vertical	Fundamental
<p>Peak</p>	 <p>Site : 03CH15-HY Condition : PEAK_BE(UNII 4) 3m 91200_02294_220623 VERTICAL : RBW:1000.000KHz VBW:3000.000KHz SWT:Auto</p>	<p>Left blank</p>
<p>Avg.</p>	 <p>Site : 03CH15-HY Condition : AVG_BE(UNII 4) 3m 91200_02294_220623 VERTICAL : RBW:1000.000KHz VBW:1000KHz SWT:Auto</p>	<p>Left blank</p>



UNII-4 - 5850~5895MHz
WIFI 802.11a (Harmonic @ 3m)

WIFI	UNII-4 - 5850~5895MHz Harmonic @ 3m	
ANT	802.11a CH169 5845MHz	
7+3	Horizontal	Vertical
Peak Avg.	<p>Horizontal spectrum plot showing Level (dBu/Vm) vs Frequency (MHz). The plot displays a series of peaks between 5850 MHz and 5895 MHz. A specific peak is highlighted at 5845 MHz with a red arrow and labeled 'PEAK[UNII]'. The y-axis ranges from 10.0 to 140.0 dBu/Vm, and the x-axis ranges from 7000 to 18000 MHz. The plot is dated 2022-11-10.</p> <p>Site : 03CH15-HY Condition : :PEAK[UNII] 3m 91200_02294_220623 HORIZONTAL</p>	<p>Vertical spectrum plot showing Level (dBu/Vm) vs Frequency (MHz). The plot displays a series of peaks between 5850 MHz and 5895 MHz. A specific peak is highlighted at 5845 MHz with a red arrow and labeled 'PEAK[UNII]'. The y-axis ranges from 10.0 to 140.0 dBu/Vm, and the x-axis ranges from 7000 to 18000 MHz. The plot is dated 2022-11-10.</p> <p>Site : 03CH15-HY Condition : :PEAK[UNII] 3m 91200_02294_220623 VERTICAL</p>

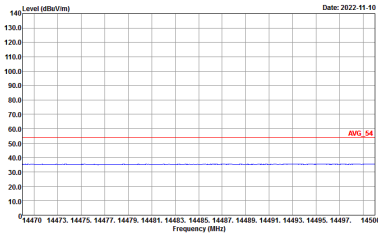
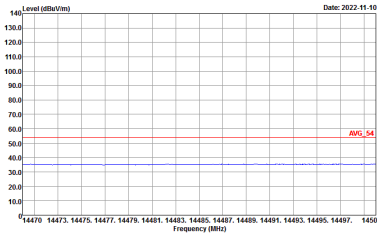
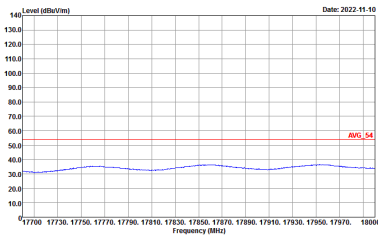
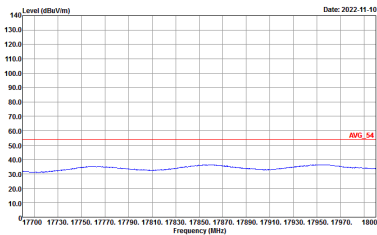

WIFI	UNII-4 - 5850~5895MHz Harmonic @ 3m	
ANT	802.11a CH169 5845MHz	
7+3	Horizontal	Vertical
Peak Avg.	 <p>Site : 03CH15-HY Condition : AV6_54 3m 91200_02294_220623 HORIZONTAL</p>	 <p>Site : 03CH15-HY Condition : AV6_54 3m 91200_02294_220623 VERTICAL</p>
Avg.	 <p>Site : 03CH15-HY Condition : AV6_54 3m 91200_02294_220623 HORIZONTAL</p>	 <p>Site : 03CH15-HY Condition : AV6_54 3m 91200_02294_220623 VERTICAL</p>

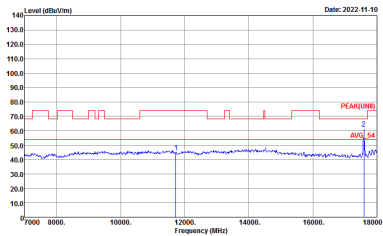
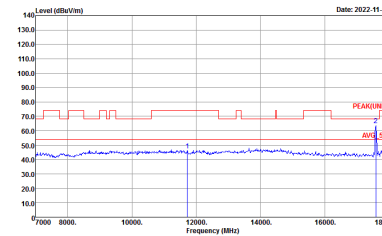

WIFI	UNII-4 - 5850~5895MHz Harmonic @ 3m	
ANT	802.11a CH173 5865MHz	
7+3	Horizontal	Vertical
Peak Avg.	<div style="display: flex; justify-content: space-around;"> <div style="width: 45%;">  <p>Site : 03CH15-HY Condition : PEAK(UNII) 3m 91200_02294_220623 HORIZONTAL</p> </div> <div style="width: 45%;">  <p>Site : 03CH15-HY Condition : PEAK(UNII) 3m 91200_02294_220623 VERTICAL</p> </div> </div>	

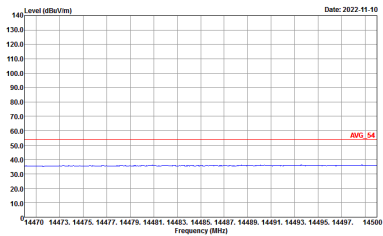
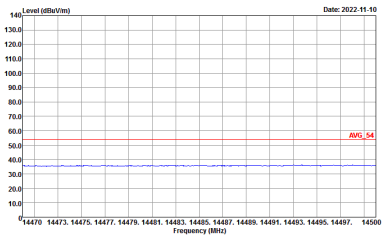
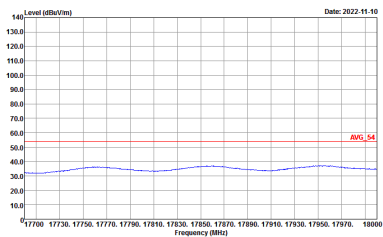
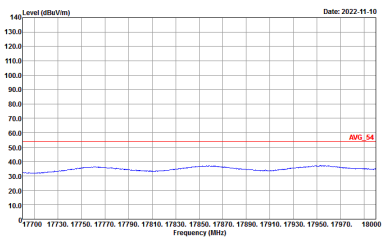

WIFI	UNII-4 - 5850~5895MHz Harmonic @ 3m	
ANT	802.11a CH173 5865MHz	
7+3	Horizontal	Vertical
Peak Avg.	 <p>Site : 03CH15-HY Condition : AV6_54 3m 91200_02294_220623 HORIZONTAL</p>	 <p>Site : 03CH15-HY Condition : AV6_54 3m 91200_02294_220623 VERTICAL</p>
Avg.	 <p>Site : 03CH15-HY Condition : AV6_54 3m 91200_02294_220623 HORIZONTAL</p>	 <p>Site : 03CH15-HY Condition : AV6_54 3m 91200_02294_220623 VERTICAL</p>



WIFI	UNII-4 - 5850~5895MHz Harmonic @ 3m	
ANT	802.11a CH177 5885MHz	
7+3	Horizontal	Vertical
Peak Avg.	<p>Site : 03CH15-HY Condition : PEAK(UNII) 3m 91200_02294_220623 HORIZONTAL</p>	<p>Site : 03CH15-HY Condition : PEAK(UNII) 3m 91200_02294_220623 VERTICAL</p>



WIFI	UNII-4 - 5850~5895MHz Harmonic @ 3m	
ANT	802.11a CH177 5885MHz	
7+3	Horizontal	Vertical
Peak Avg.	<p>Site : 03CH15-HY Condition : AV6_54 3m 91200_02294_220623 HORIZONTAL</p>	<p>Site : 03CH15-HY Condition : AV6_54 3m 91200_02294_220623 VERTICAL</p>
Avg.	<p>Site : 03CH15-HY Condition : AV6_54 3m 91200_02294_220623 HORIZONTAL</p>	<p>Site : 03CH15-HY Condition : AV6_54 3m 91200_02294_220623 VERTICAL</p>



UNII-4 - 5850~5895MHz
WIFI 802.11ax HE20 Full (Harmonic @ 3m)

WIFI	UNII-4 - 5850~5895MHz Harmonic @ 3m	
ANT	802.11ax HE20 Full CH169 5845MHz	
7+3	Horizontal	Vertical
Peak Avg.	<p>Site : 03CH15-HY Condition : PEAK(UNII) 3m 9120D_02294_220623 HORIZONTAL</p>	<p>Site : 03CH15-HY Condition : PEAK(UNII) 3m 9120D_02294_220623 VERTICAL</p>

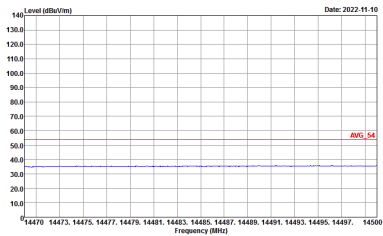
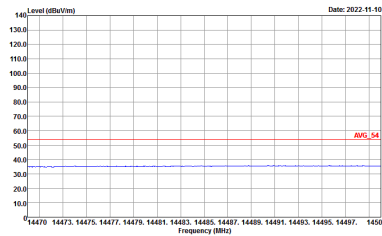
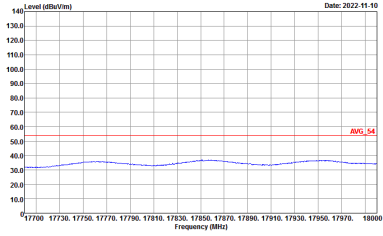
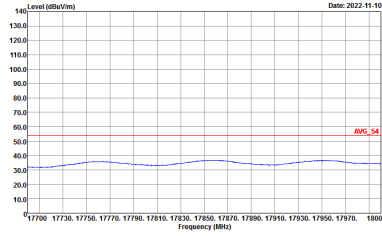

WIFI	UNII-4 - 5850~5895MHz Harmonic @ 3m	
ANT	802.11ax HE20 Full CH169 5845MHz	
7+3	Horizontal	Vertical
Peak Avg.	 <p>Site : 03CH15-HY Condition : AV6_54 3m 91200_02294_220623 HORIZONTAL</p>	 <p>Site : 03CH15-HY Condition : AV6_54 3m 91200_02294_220623 VERTICAL</p>
Avg.	 <p>Site : 03CH15-HY Condition : AV6_54 3m 91200_02294_220623 HORIZONTAL</p>	 <p>Site : 03CH15-HY Condition : AV6_54 3m 91200_02294_220623 VERTICAL</p>



WIFI	UNII-4 - 5850~5895MHz Harmonic @ 3m	
ANT	802.11ax HE20 Full CH173 5865MHz	
7+3	Horizontal	Vertical
Peak Avg.	<p>Site : 03CH15-HY Condition : PEAK(UNII) 3m 91200_02294_220623 HORIZONTAL</p>	<p>Site : 03CH15-HY Condition : PEAK(UNII) 3m 91200_02294_220623 VERTICAL</p>



WIFI	UNII-4 - 5850~5895MHz Harmonic @ 3m	
ANT	802.11ax HE20 Full CH173 5865MHz	
7+3	Horizontal	Vertical
Peak Avg.	<p>Site : 03CH15-HY Condition : AV6_54 3m 91200_02294_220623 HORIZONTAL</p>	<p>Site : 03CH15-HY Condition : AV6_54 3m 91200_02294_220623 VERTICAL</p>
Avg.	<p>Site : 03CH15-HY Condition : AV6_54 3m 91200_02294_220623 HORIZONTAL</p>	<p>Site : 03CH15-HY Condition : AV6_54 3m 91200_02294_220623 VERTICAL</p>



WIFI	UNII-4 - 5850~5895MHz Harmonic @ 3m	
ANT	802.11ax HE20 Full CH177 5885MHz	
7+3	Horizontal	Vertical
Peak Avg.	<p>Site : 03CH15-HY Condition : PEAK(UNII) 3m 91200_02294_220623 HORIZONTAL</p>	<p>Site : 03CH15-HY Condition : PEAK(UNII) 3m 91200_02294_220623 VERTICAL</p>

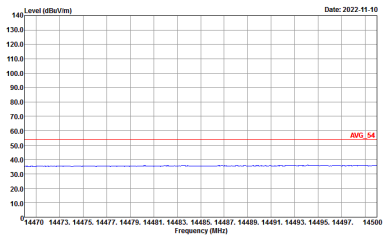
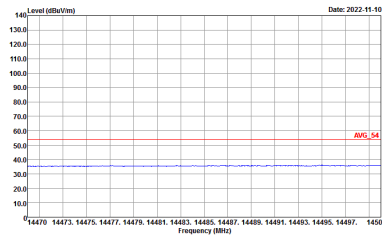
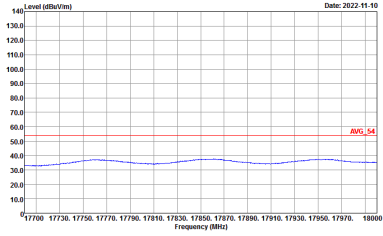
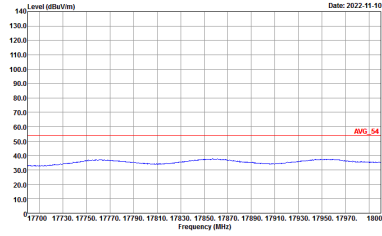

WIFI	UNII-4 - 5850~5895MHz Harmonic @ 3m	
ANT	802.11ax HE20 Full CH177 5885MHz	
7+3	Horizontal	Vertical
Peak Avg.	 <p>Site : 03CH15-HY Condition : AV6_54 3m 91200_02294_220623 HORIZONTAL</p>	 <p>Site : 03CH15-HY Condition : AV6_54 3m 91200_02294_220623 VERTICAL</p>
Avg.	 <p>Site : 03CH15-HY Condition : AV6_54 3m 91200_02294_220623 HORIZONTAL</p>	 <p>Site : 03CH15-HY Condition : AV6_54 3m 91200_02294_220623 VERTICAL</p>



UNII-4 - 5850~5895MHz
WIFI 802.11ax HE40 Full (Harmonic @ 3m)

WIFI	UNII-4 - 5850~5895MHz Harmonic @ 3m	
ANT	802.11ax HE40 Full CH167 5835MHz	
7+3	Horizontal	Vertical
Peak Avg.	<p>Site : 03CH15-HY Condition : PEAK(UNII) 3m 91200_02294_220623 HORIZONTAL</p>	<p>Site : 03CH15-HY Condition : PEAK(UNII) 3m 91200_02294_220623 VERTICAL</p>

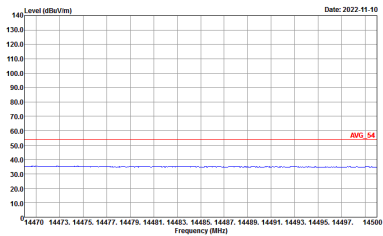
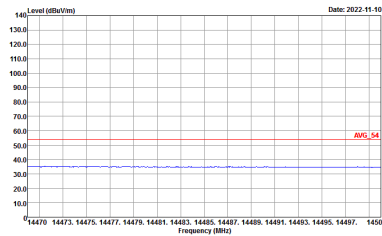
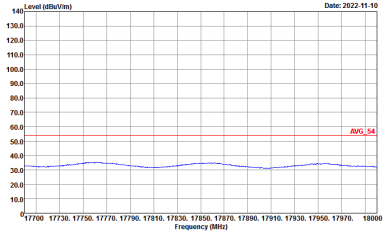
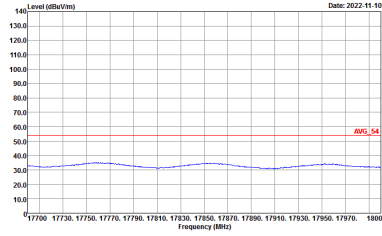

WIFI	UNII-4 - 5850~5895MHz Harmonic @ 3m	
ANT	802.11ax HE40 Full CH167 5835MHz	
7+3	Horizontal	Vertical
Peak Avg.	 <p>Site : 03CH15-HY Condition : AV6_54 3m 91200_02294_220623 HORIZONTAL</p>	 <p>Site : 03CH15-HY Condition : AV6_54 3m 91200_02294_220623 VERTICAL</p>
Avg.	 <p>Site : 03CH15-HY Condition : AV6_54 3m 91200_02294_220623 HORIZONTAL</p>	 <p>Site : 03CH15-HY Condition : AV6_54 3m 91200_02294_220623 VERTICAL</p>



WIFI	UNII-4 - 5850~5895MHz Harmonic @ 3m	
ANT	802.11ax HE40 Full CH175 5875MHz	
7+3	Horizontal	Vertical
Peak Avg.	<p>Site : 03CH15-HY Condition : PEAK(UNII) 3m 91200_02294_220623 HORIZONTAL</p>	<p>Site : 03CH15-HY Condition : PEAK(UNII) 3m 91200_02294_220623 VERTICAL</p>

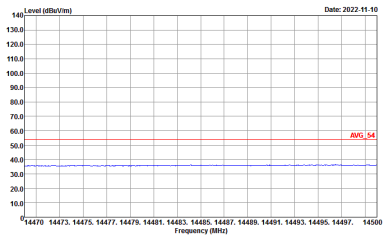
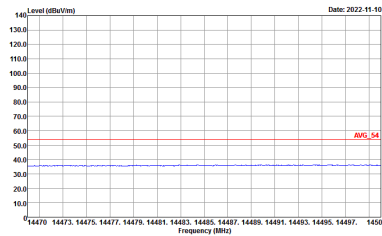
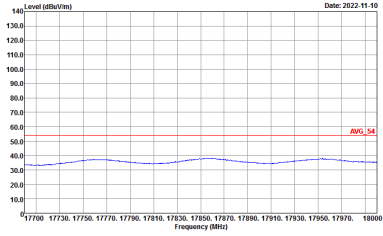
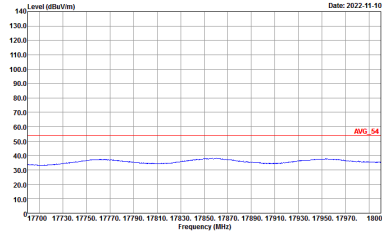

WIFI	UNII-4 - 5850~5895MHz Harmonic @ 3m	
ANT	802.11ax HE40 Full CH175 5875MHz	
7+3	Horizontal	Vertical
Peak Avg.	 <p>Site : 03CH15-HY Condition : AV6_54 3m 91200_02294_220623 HORIZONTAL</p>	 <p>Site : 03CH15-HY Condition : AV6_54 3m 91200_02294_220623 VERTICAL</p>
Avg.	 <p>Site : 03CH15-HY Condition : AV6_54 3m 91200_02294_220623 HORIZONTAL</p>	 <p>Site : 03CH15-HY Condition : AV6_54 3m 91200_02294_220623 VERTICAL</p>



UNII-4 - 5850~5895MHz
WIFI 802.11ax HE80 Full (Harmonic @ 3m)

Table with 2 columns: Horizontal and Vertical. Rows include WIFI, ANT, 7+3, and Peak Avg. Each cell contains a spectral plot of Level (dBuV/m) vs Frequency (MHz) with peak and average values indicated.

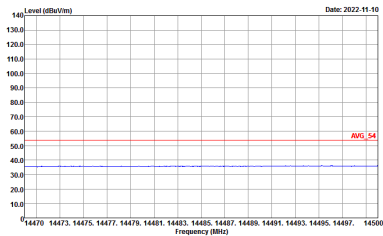
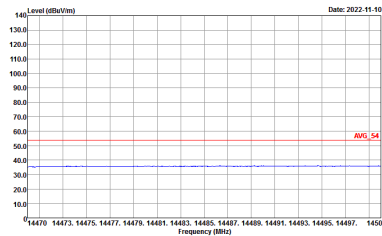
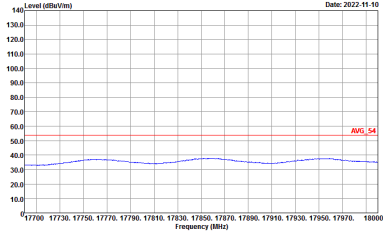
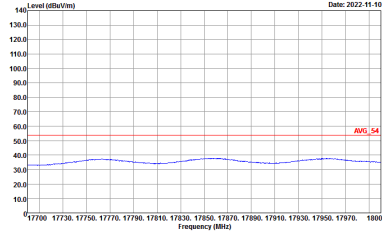

WIFI	UNII-4 - 5850~5895MHz Harmonic @ 3m	
ANT	802.11ax HE80 Full CH171 5855MHz	
7+3	Horizontal	Vertical
Peak Avg.	 <p>Level (dBuV/m) vs Frequency (MHz) for Horizontal orientation. The plot shows a flat spectrum with a red line at approximately 55 dBuV/m labeled 'AVG_54'. The x-axis ranges from 14470 to 14500 MHz. Site: 03CH15-HY, Condition: AV6_54 3m 91200_02294_220623 HORIZONTAL.</p>	 <p>Level (dBuV/m) vs Frequency (MHz) for Vertical orientation. The plot shows a flat spectrum with a red line at approximately 55 dBuV/m labeled 'AVG_54'. The x-axis ranges from 14470 to 14500 MHz. Site: 03CH15-HY, Condition: AV6_54 3m 91200_02294_220623 VERTICAL.</p>
Avg.	 <p>Average Horizontal Spectrum Plot. The plot shows a blue line fluctuating around 35 dBuV/m. The x-axis ranges from 17700 to 18000 MHz. Site: 03CH15-HY, Condition: AV6_54 3m 91200_02294_220623 HORIZONTAL.</p>	 <p>Average Vertical Spectrum Plot. The plot shows a blue line fluctuating around 35 dBuV/m. The x-axis ranges from 17700 to 18000 MHz. Site: 03CH15-HY, Condition: AV6_54 3m 91200_02294_220623 VERTICAL.</p>



Emission above 18GHz
5GHz WIFI 802.11ax HE80 Full (SHF @ 1m)

Table with 3 columns: WIFI (7+3), ANT (802.11ax HE80 Full SHF), and two sub-columns for Horizontal and Vertical orientations. Each sub-column contains a spectral plot of Level (dBuV/m) vs Frequency (MHz) with 'Peak' and 'Avg.' markers.



Emission below 1GHz
5GHz WIFI 802.11ax HE80 Full (LF @ 3m)

WIFI	5GHz WIFI	
ANT	802.11ax HE80 Full LF	
7+3	Horizontal	Vertical
QP / Peak	<p>Horizontal</p>	<p>Vertical</p>



Appendix E. Duty Cycle Plots

<For Radiated Spurious Emission test>

Antenna	Band	Duty Cycle(%)	T(us)	1/T(kHz)	VBW Setting					
7+3	802.11a	93.44	1425	0.70	1kHz					
7+3	5GHz 802.11ax HE20 Full RU	95.97	2405	0.42	1kHz					
7+3	5GHz 802.11ax HE40 Full RU	95.60	2390	1kHz	7+3	5GHz 802.11ax HE80 Full RU	92.16	1175	0.85	1kHz
7+3	5GHz 802.11ax HE80 Full RU	92.16	1175	0.85	1kHz					

MIMO <Ant. 7+3>

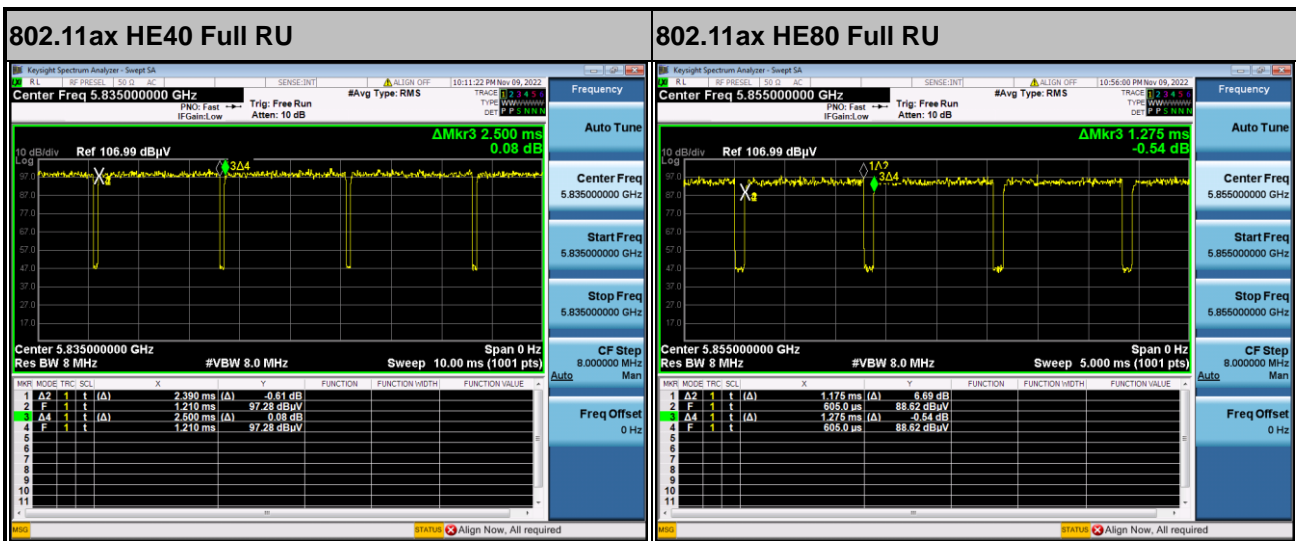
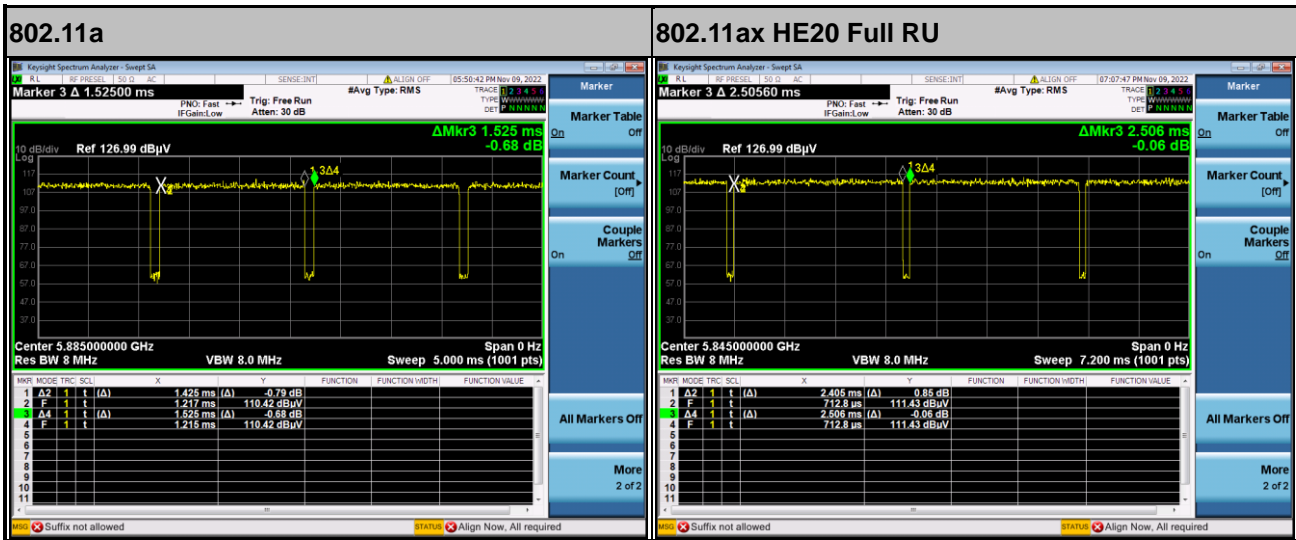

**<For Conducted test>**

Antenna	Band	Duty Cycle(%)	T(us)	VBW Setting
7+3	802.11a for Ant. 7	93.42	1420	0.30
7+3	802.11a for Ant. 3	93.51	1440	0.29
7+3	5GHz 802.11ax HE20 Full RU for Ant. 7	90.91	1000	0.41
7+3	5GHz 802.11ax HE20 Full RU for Ant. 3	91.07	1020	0.41
7+3	5GHz 802.11ax HE20 26 RU Ant. 7	89.58	860	0.48
7+3	5GHz 802.11ax HE20 26 RU Ant. 3	89.58	860	0.48
7+3	5GHz 802.11ax HE20 52 RU Ant. 7	88.64	780	0.52
7+3	5GHz 802.11ax HE20 52 RU Ant. 3	88.64	780	0.52
7+3	5GHz 802.11ax HE20 106 RU Ant. 7	87.50	700	0.58
7+3	5GHz 802.11ax HE20 106 RU Ant. 3	87.50	700	0.58
7+3	5GHz 802.11ax HE40 Full RU for Ant. 7	92.54	1240	0.34
7+3	5GHz 802.11ax HE40 Full RU for Ant. 3	92.54	1240	0.34
7+3	5GHz 802.11ax HE80 Full RU for Ant. 7	90.57	960	0.43
7+3	5GHz 802.11ax HE80 Full RU for Ant. 3	90.57	960	0.43



MIMO <Ant. 7>

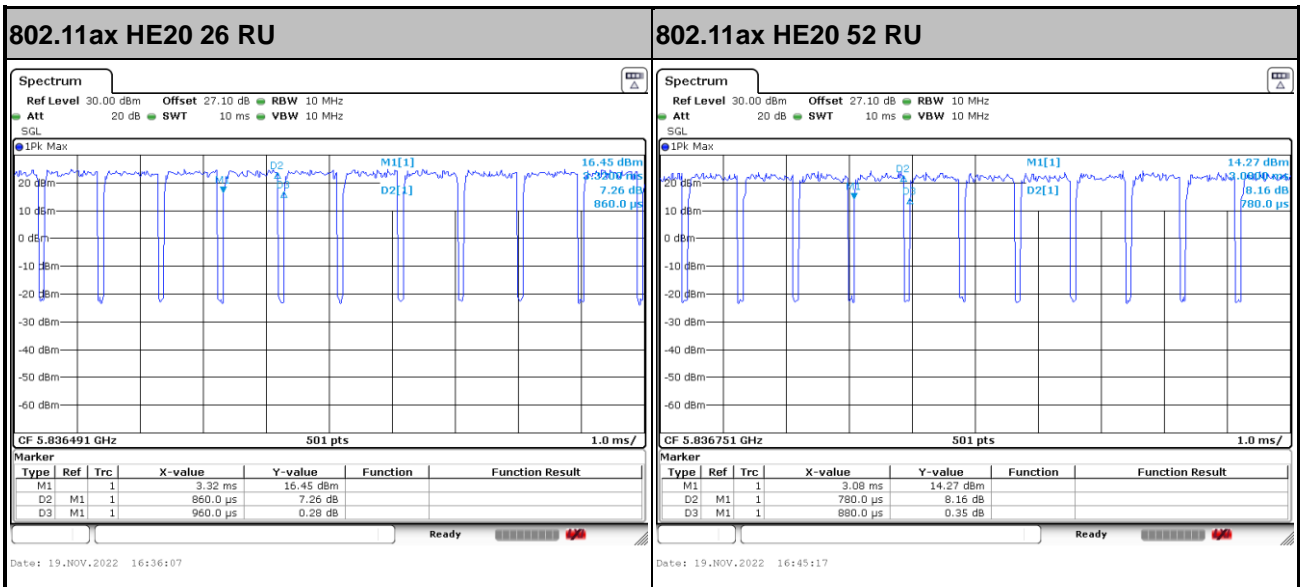
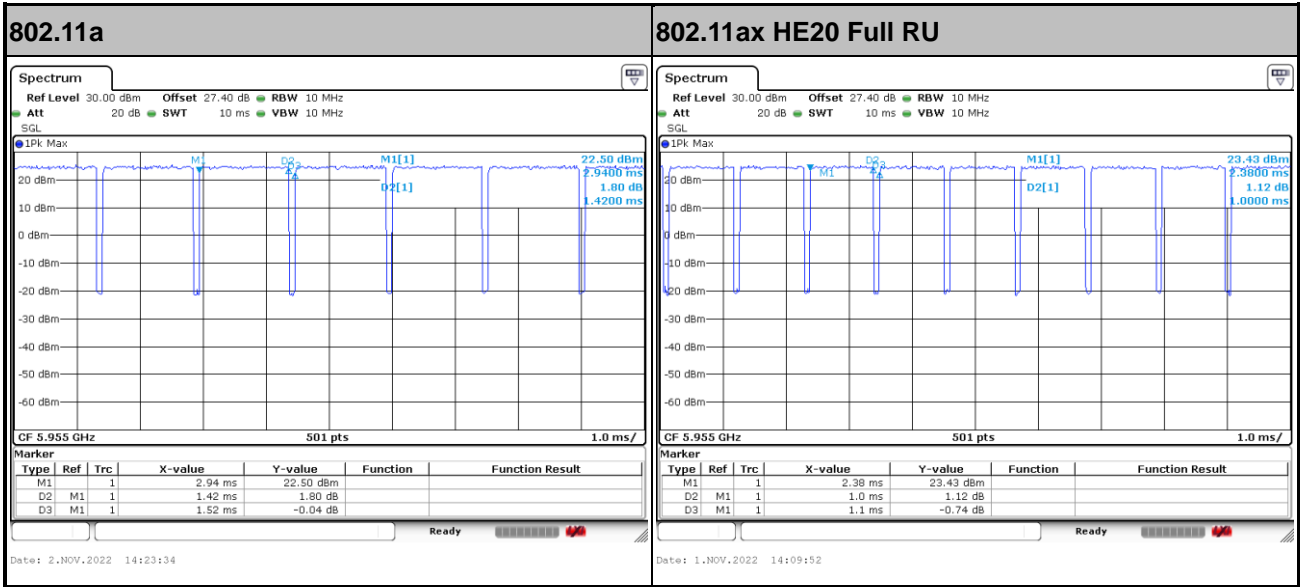

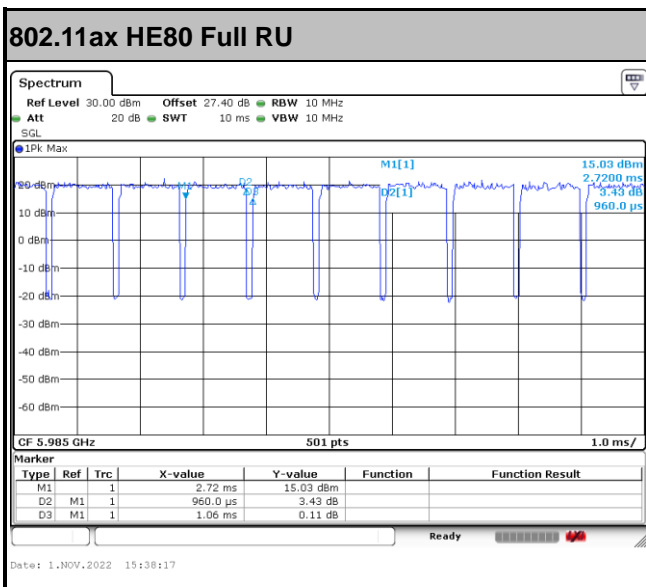
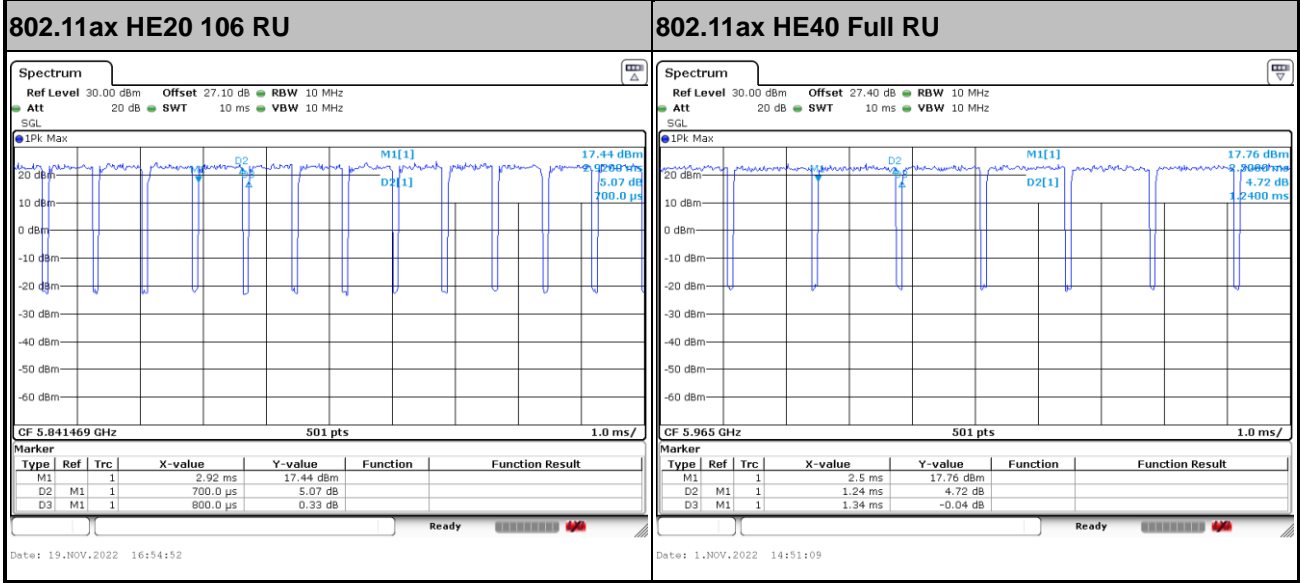



MIMO <Ant. 3>

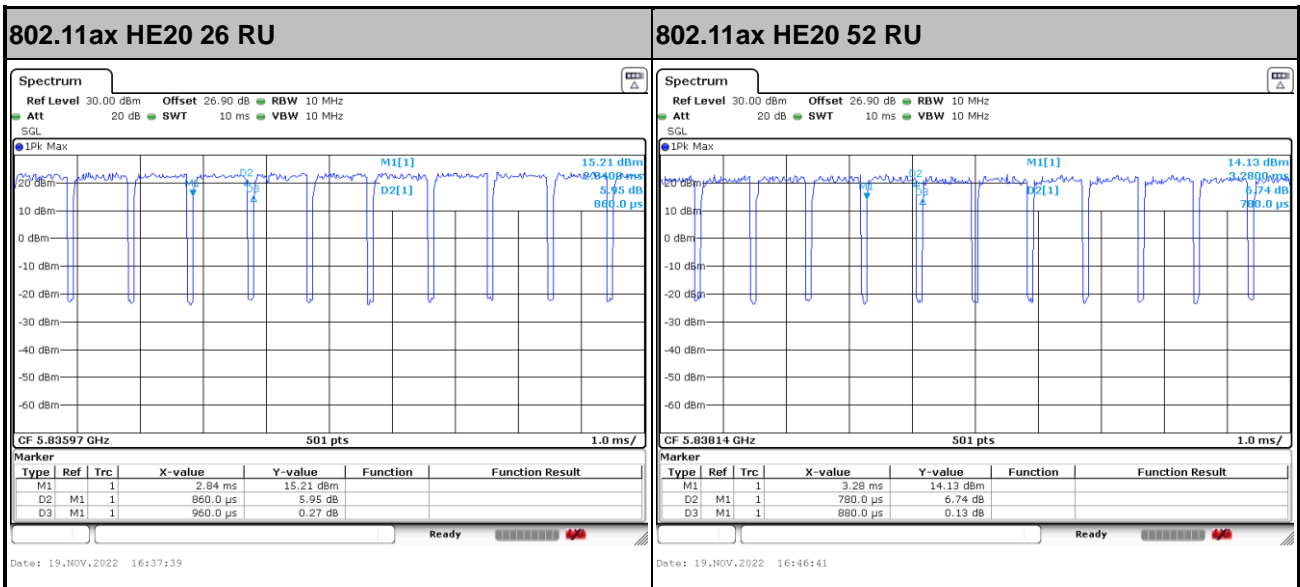
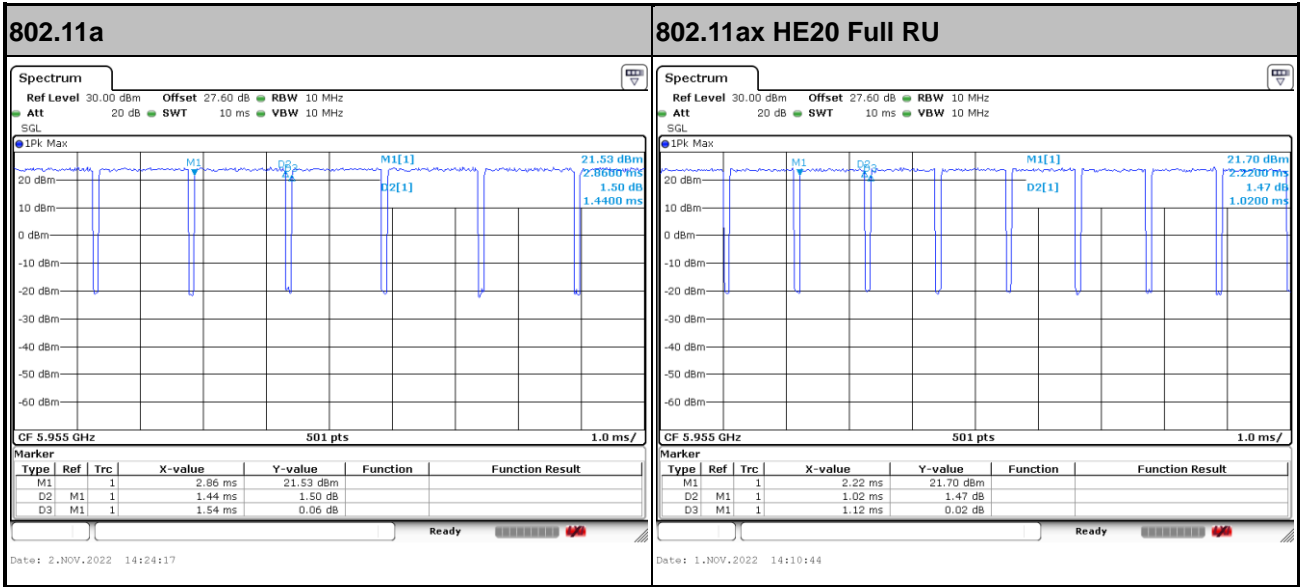



802.11ax HE20 106 RU

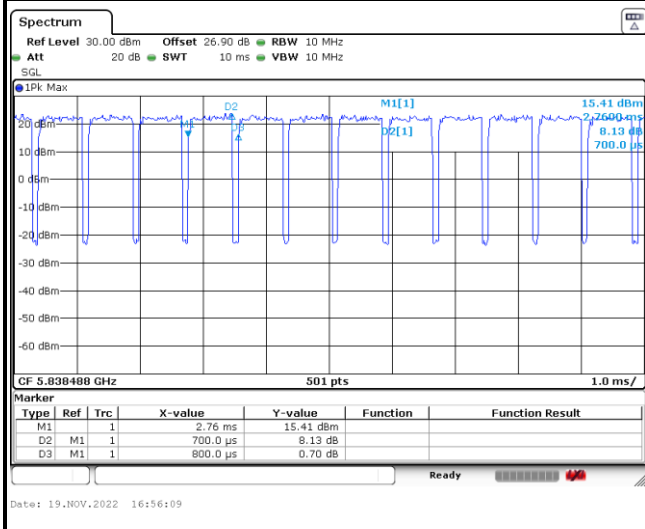

802.11ax HE40 Full RU

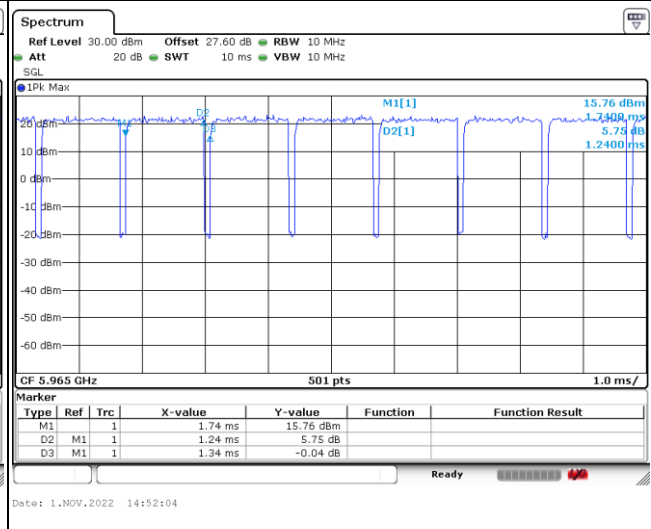

802.11ax HE80 Full RU

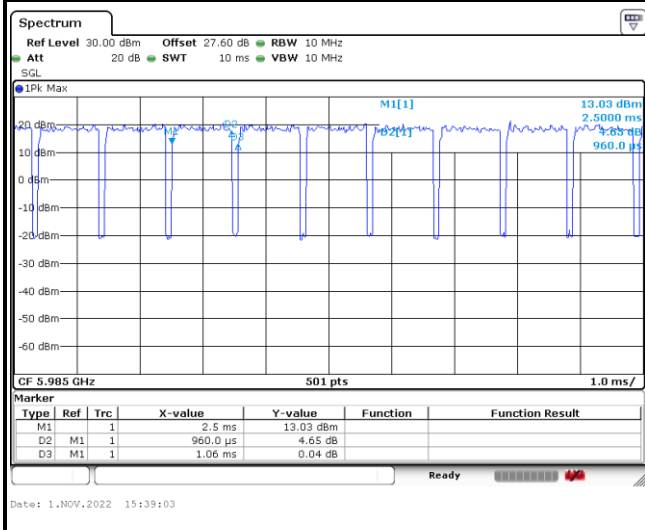

—THE END—