



FCC RADIO TEST REPORT

FCC ID : A4RG8V0U
Equipment : Phone
Model Name : G8V0U, GF5KQ
Applicant : Google LLC
1600 Amphitheatre Parkway,
Mountain View, California, 94043 USA
Standard : FCC 47 CFR Part 2, and 30

The product was received on Jul. 08, 2021 and testing was started from Jul. 08, 2021 and completed on Aug. 16, 2021. We, Sporton International Inc. Wensan Laboratory, would like to declare that the tested sample has been evaluated in accordance with the test procedures ANSI C63.26-2015 and has been in compliance with the applicable technical standards.

The test results in this report apply exclusively to the tested model / sample. Without written approval of Sporton International Inc. Wensan Laboratory, the test report shall not be reproduced except in full.

Approved by: Louis Wu

Sporton International Inc. Wensan Laboratory

No.58, Aly. 75, Ln. 564, Wenhua 3rd, Rd., Guishan Dist., Taoyuan City 333010, Taiwan (R.O.C.)



Table of Contents

History of this test report.....	3
Summary of Test Result.....	4
1 General Description	5
1.1 Feature of Equipment Under Test.....	5
1.2 Product Specification of Equipment Under Test	6
1.3 Modification of EUT	6
1.4 Testing Location	7
1.5 Applied Standards	7
2 Test Configuration of Equipment Under Test	8
2.1 Test Mode.....	8
2.2 Connection Diagram of Test System	9
2.3 Support Unit used in test configuration	9
2.4 Measurement Results Explanation Example	10
2.5 Far Field Condition for Frequency above 18GHz.....	11
2.6 Frequency List of Low/Middle/High Channels.....	12
3 Radiated Test Items	13
3.1 Measuring Instruments.....	13
3.2 Test Setup	13
3.3 Test Result of Radiated Test.....	16
3.4 EIRP Measurement	17
3.5 Occupied Bandwidth	18
3.6 Radiated Spurious Emission Measurement.....	19
3.7 Frequency Stability Measurement.....	20
4 List of Measuring Equipment.....	21
5 Uncertainty of Evaluation.....	23
Appendix A. Test Results of Conducted and Radiated Test	
Appendix B. R&S Mixer and Horn Antenna Calibration Reports	



Summary of Test Result

Report Clause	Ref Std. Clause	Test Items	Limit	Result (PASS/FAIL)	Remark
3.4	§2.1046 §30.202	EIRP Measurement	+43dBm	Pass	-
3.5	§2.1049	Occupied Bandwidth	Not Applicable	Reporting only	-
3.6	§2.1053 §30.203	Radiated Spurious Emission	-5dBm/MHz -13dBm/MHz	Pass	-
3.7	§2.1055	Frequency Stability for Temperature & Voltage	Within the band	Pass	-

Declaration of Conformity:

The test results with all measurement uncertainty excluded are presented in accordance with the regulation limits or requirements declared by manufacturers.

Comments and Explanations:

The declared of product specification for EUT presented in the report are provided by the manufacturer, and the manufacturer takes all the responsibilities for the accuracy of product specification.

Reviewed by: William Chen

Report Producer: Dara Chiu



1 General Description

1.1 Feature of Equipment Under Test

Product Feature & Specification	
Equipment	Phone
Model Name	G8V0U, GF5KQ
FCC ID	A4RG8V0U
EUT supports Radios application	GSM/EGPRS/WCDMA/HSPA/LTE/5G NR/NFC/ GNSS/WPC/WPT/UWB WLAN 11b/g/n HT20 WLAN 11a/n HT20/HT40 WLAN 11ac VHT20/VHT40/VHT80/VHT160 WLAN 11ax HE20/HE40/HE80/HE160 Bluetooth BR/EDR/LE

EUT Information List	
S/N	Performed Test Item
16011FDEE0005V	Conducted Measurement EIRP Radiated Spurious Emission

Remark: The above EUT's information was declared by manufacturer.



1.2 Product Specification of Equipment Under Test

Product Specification subjective to this standard	
Device Category in Part 30	Mobile station
Tx Frequency	NR band n258: 24.25GHz ~ 24.45GHz (258A) 24.75GHz ~ 25.25GHz (258B) NR band n260: 37GHz ~ 40GHz NR band n261: 27.5GHz ~ 28.35GHz
Rx Frequency	NR band n258: 24.25GHz ~ 24.45GHz (258A) 24.75GHz ~ 25.25GHz (258B) NR band n260: 37GHz ~ 40GHz NR band n261: 27.5GHz ~ 28.35GHz
Support Bandwidth	NR band n258: 100 MHz (1CC) and 200 MHz (2CC) NR band n260: 100 MHz (1CC) and 200 MHz (2CC) NR band n261: 100 MHz (1CC) and 200 MHz (2CC)
Maximum Number of contiguous CC	2
Maximum Aggregated Bandwidth	200MHz
Maximum Output Power (EIRP)	NR band n258A: Module A: 27.03 dBm Module B: 25.97 dBm NR band n258B: Module A: 27.81 dBm Module B: 27.51 dBm NR band n260: Module A: 30.98 dBm Module B: 29.21 dBm NR band n261: Module A: 31.93 dBm Module B: 31.54 dBm
Type of Modulation	CP-OFDM: QPSK / 16QAM / 64QAM DFT-s-OFDM: pi/2 BPSK / QPSK / 16QAM / 64QAM

Note 1: Highest EIRP was measured on Module A, dual beam case for n258, n260, and n261 band.

Note 2: The above EUT's information was declared by manufacturer. Please refer to Comments and Explanations in report summary.

1.3 Modification of EUT

No modifications are made to the EUT during all test items.



1.4 Testing Location

Test Site	Sporton International Inc. Wensan Laboratory			
Test Site Location	No.58, Aly. 75, Ln. 564, Wenhua 3rd, Rd., Guishan Dist., Taoyuan City 333010, Taiwan (R.O.C.) TEL: +886-3-327-3456 FAX: +886-3-328-4978			
Test Site Information	Site No.	Engineer	Temperature	Humidity
	03CH18-HY	Yu Wang	22~24°C	46~47 %
	03CH19-HY	Yu Wang	21~24°C	45~48 %

Note 1: FCC Designation No.: TW3786

Note 2: The highest accredited frequency is 280GHz and the ISO 17025 accreditation letter can be found on TAF (Taiwan Accreditation Foundation) Website ([Website link](#)).

1.5 Applied Standards

According to the specifications of the manufacturer, the EUT must comply with the requirements of the following standards:

- ♦ FCC 47 CFR Part 2, 30
- ♦ ANSI C63.26-2015
- ♦ FCC KDB 971168 D01 Power Meas. License Digital Systems v03r01
- ♦ FCC KDB 842590 D01 Upper Microwave Flexible Use Service v01r02

Remark:

1. All test items were verified and recorded according to the standards and without any deviation during the test.
2. The TAF code is not including all the FCC KDB listed without accreditation.



2 Test Configuration of Equipment Under Test

EUT has total 2 millimeter wave antenna modules and up to 2 beams operation for each module.

Any antenna module cannot transmit simultaneously with the other antenna modules.

Preliminary EIRP test was performed for all beam configurations in the anechoic chamber at the manufacturer’s facility so the EIRP worst case beam-pair were identified.

EIRP was investigated that the dual beam rated maximum EIRP is higher than single beam.

The NR radio operation is controlled via AT commands to enter FTM mode (Factory mode).

The EUT is forced to operate continuously (100% duty cycle) with maximum output power during the test.

2.1 Test Mode

For radiated measurement, the pre-scan is performed to find the worst cases EUT position.

Test Items	Band	Bandwidth (MHz)		Modulation			RB #			Test Channel		
		100	200	QPSK	16QAM	64QAM	1	Inner Full	Outer Full	L	M	H
EIRP	n258 n260 n261	v	v	v	v	v	v	v	v	v	v	v
99% Occupied Bandwidth	n258 n260 n261	v	v	v	v	v	-	-	v	v	v	v
Out of Band Emission	n258 n260 n261	v	v	v	v	v	v	-	v	v	-	v
Spurious Emission	n258 n260 n261	v	v	v	-	-	v	-	-	v	v	v
Frequency Stability	n258 n260 n261	CW tone								-	v	-
Remark	<ol style="list-style-type: none"> The mark "v " means that this configuration is chosen for testing. The device is investigated from 9kHz to 200GHz of fundamental signal for radiated spurious emission test under different RB size and modulations in exploratory test. Subsequently, only the worst case emissions are reported. Both modulation type DFT-s OFDM and CP-OFDM are evaluated and reported. All the radiated test cases were performed with built-in battery. The out of band emission were measured radiated EIRP. The TRP method is applied when EIRP exceeds limit. 											

2.2 Connection Diagram of Test System

<For radiated emissions from 30MHz to 18GHz>

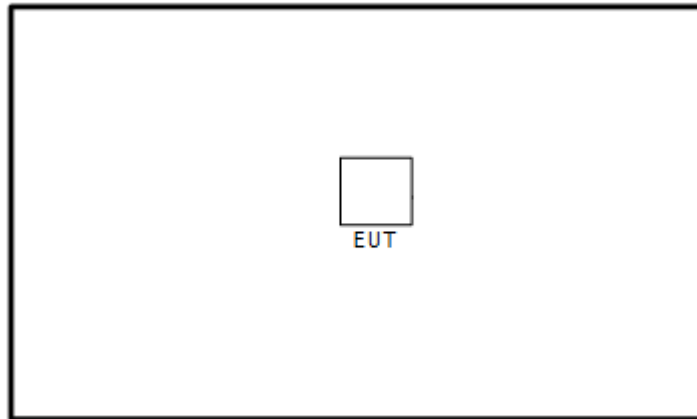

<For radiated emissions from 18GHz ~ 200GHz>

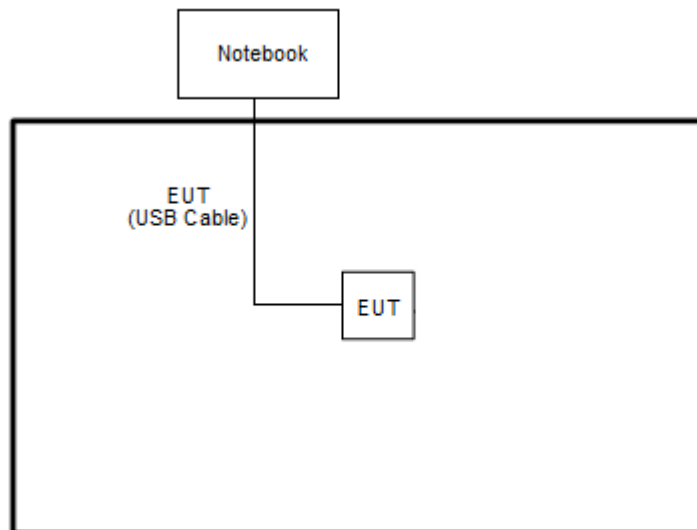

2.3 Support Unit used in test configuration

Item	Equipment	Brand Name	Model No.	FCC ID	Data Cable	Power Cord
1.	Notebook	DELL	Latitude 3400	FCC DoC	N/A	AC I/P: Unshielded, 1.2 m DC O/P: Shielded, 1.8 m

Remark: Applicant has ensured support unit would not be attached with the product on the market, support unit is provided by lab for testing.



2.4 Measurement Results Explanation Example

According to ANSI C63.26-2015 Section 5.2.7

$$\text{EIRP (dBm)} = \text{E(dBuV/m)} + 20\log(D) - 104.8.$$

- where D is the measurement distance (in the far field region) in m.
- $\text{E (dBuV/m)} = \text{Spectrum Reading Level (dBm)} + \text{Antenna Factor (dB/m)} + \text{Cable Loss (dB)} + 107$

Hence, the spectrum analyzer *Offset* is derived including RF cable loss and antenna factor.

$$\text{Offset} = \text{Antenna Factor (dB/m)} + \text{Cable Loss (dB)} + 107 + 20\log(D) - 104.8$$

The conversion loss of RF mixer is also included by the mixer table of spectrum analyzer when measurement frequency is above 40GHz.

Example :

$$\begin{aligned} \text{Offset} &= \text{Antenna Factor (dB/m)} + \text{Cable Loss (dB)} + 107 + 20\log(D) - 104.8 \\ &= 42.3 + 3.0 + 107 + 20\log(1) - 104.8 \\ &= 47.5 \text{ (dB)} \end{aligned}$$



2.5 Far Field Condition for Frequency above 18GHz

Horn Antenna	Frequency (GHz)	Antenna Dimension A (mm)	Wavelength (λ) (m)	Far field R (m) $\geq 2A^2 / \lambda$	Measurement Distance (D) (m)	Distance Factor $20\log(D)$ (dB)
BBHA 9170	18	60	0.0167	0.43	1	0.00
	40	60	0.0075	0.96		
QWH-UPRR00	40	48	0.0075	0.61	1	0.00
	60	48	0.0050	0.92		
QWH-EPRR00	60	31	0.0050	0.38	1	0.00
	90	31	0.0033	0.58		
QWH-FPRR00	90	21	0.0033	0.26	1	0.00
	140	21	0.0021	0.41		
QWH-GPRR00	140	15	0.0021	0.21	0.5	-6.02
	220	15	0.0014	0.33		



2.6 Frequency List of Low/Middle/High Channels

NR Band n258A (24.25-25.45GHz) Frequency List				
BW [MHz]	Channel/Frequency(MHz)	Lowest	Middle	Highest
100	Frequency	24300	24350	24400
200	Frequency 1	-	24300	-
	Frequency 2	-	24400	-

NR Band n258B (24.75-25.25GHz) Frequency List				
BW [MHz]	Channel/Frequency(MHz)	Lowest	Middle	Highest
100	Frequency	24800	25000	25200
200	Frequency 1	24800	24950	25100
	Frequency 2	24900	25050	25200

NR Band n260 Frequency List				
BW [MHz]	Channel/Frequency(MHz)	Lowest	Middle	Highest
100	Frequency	37050	38500	39950
200	Frequency 1	37050	38450	39850
	Frequency 2	37150	38550	39950

NR Band n261 Frequency List				
BW [MHz]	Channel/Frequency(MHz)	Lowest	Middle	Highest
100	Frequency	27550	27925	28300
200	Frequency 1	27550	27875	28200
	Frequency 2	27650	27975	28300

3 Radiated Test Items

3.1 Measuring Instruments

See list of measuring instruments of this test report.

3.2 Test Setup

For radiated emissions from 9kHz to 30MHz

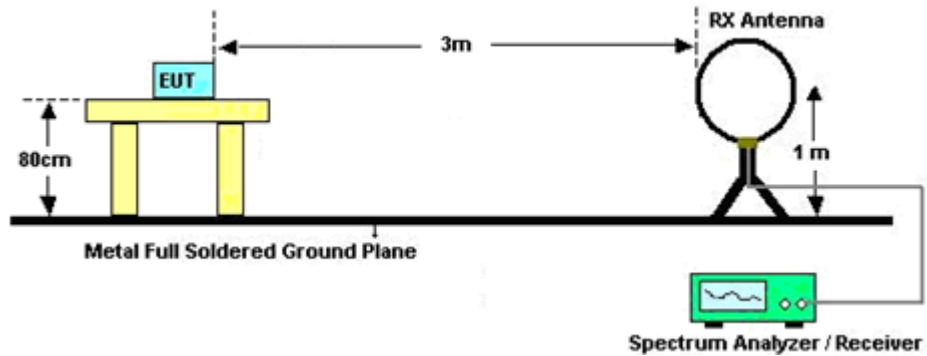

For radiated emissions from 30MHz to 1GHz

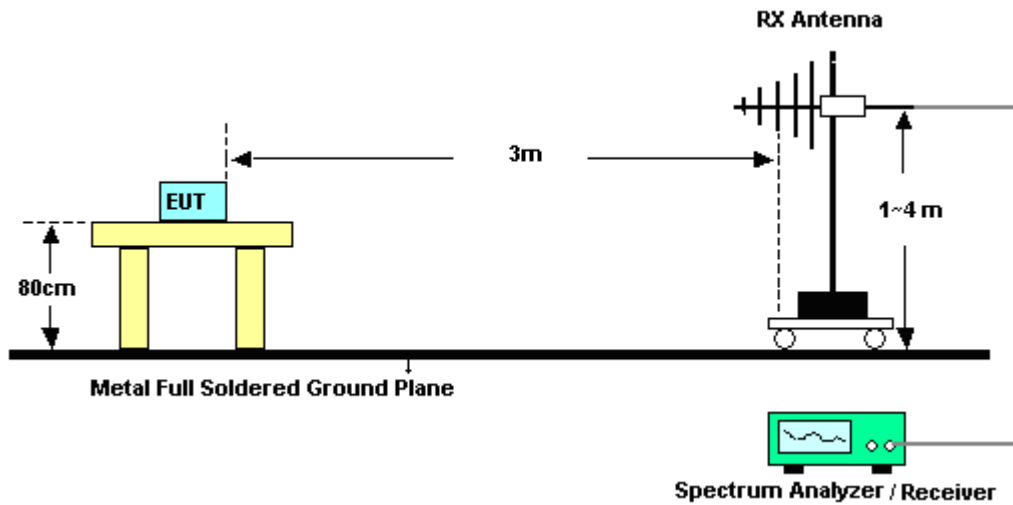

For radiated emissions 1GHz to 18GHz

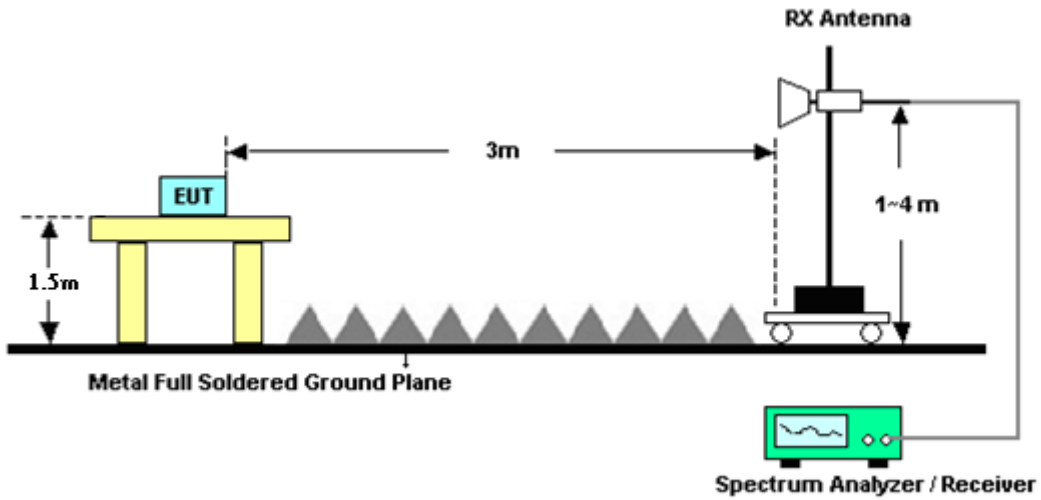

For radiated emissions from 18GHz to 40GHz

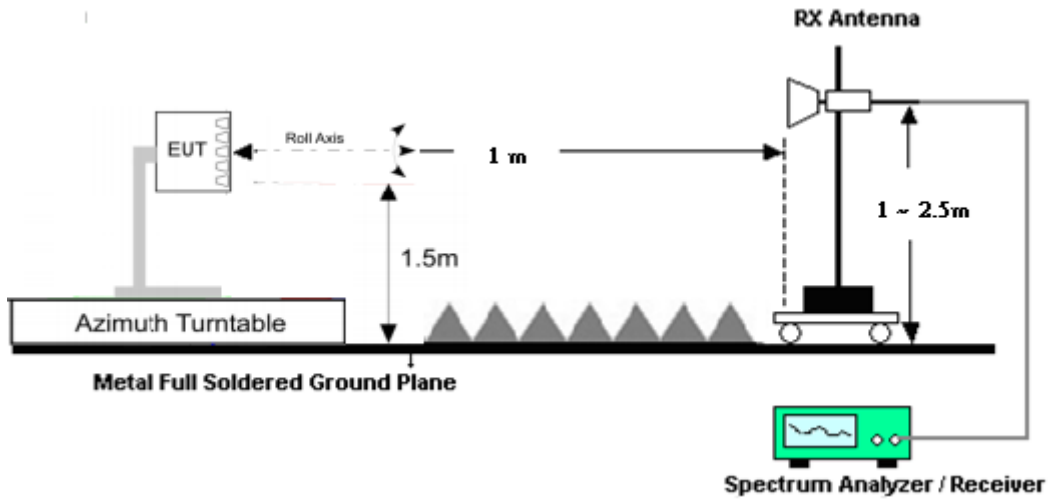

For radiated emissions above 40GHz up to 140GHz

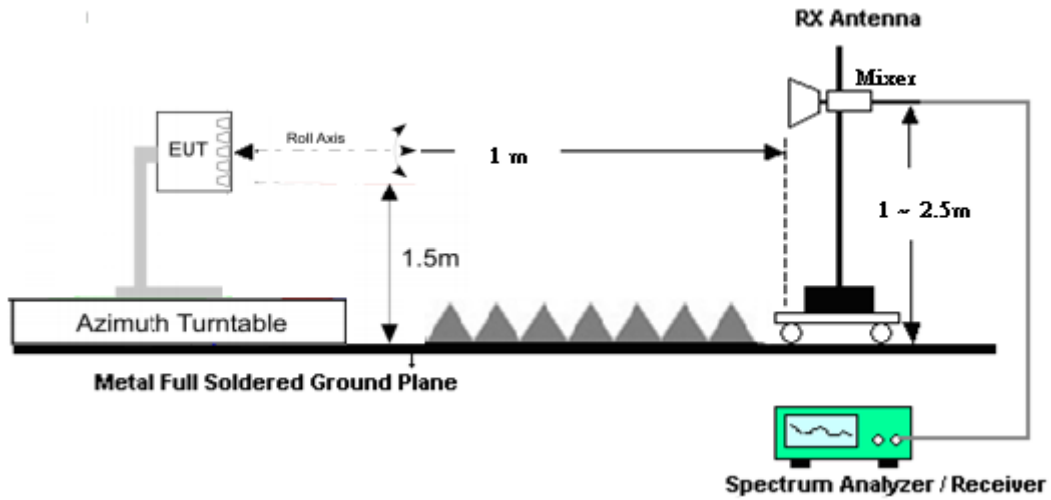

For radiated emissions above 140GHz up to 200GHz

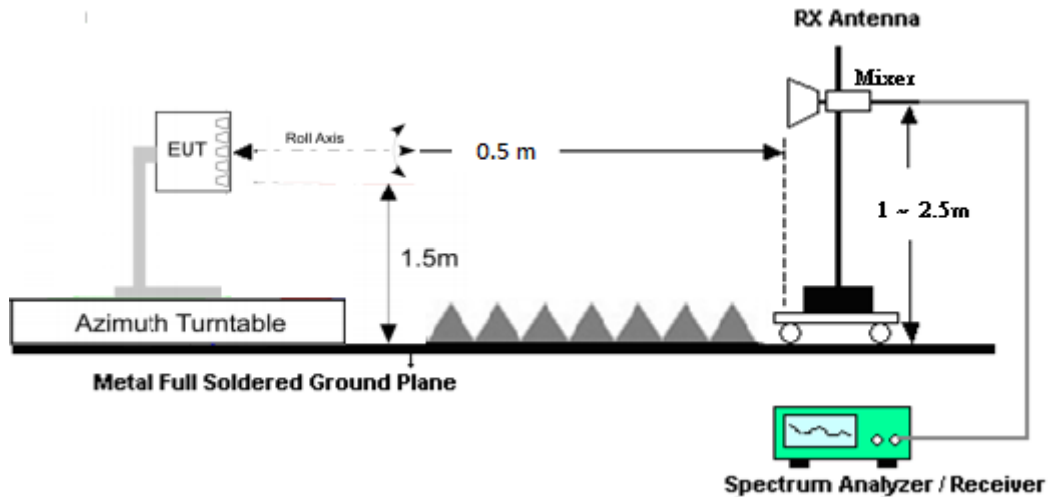

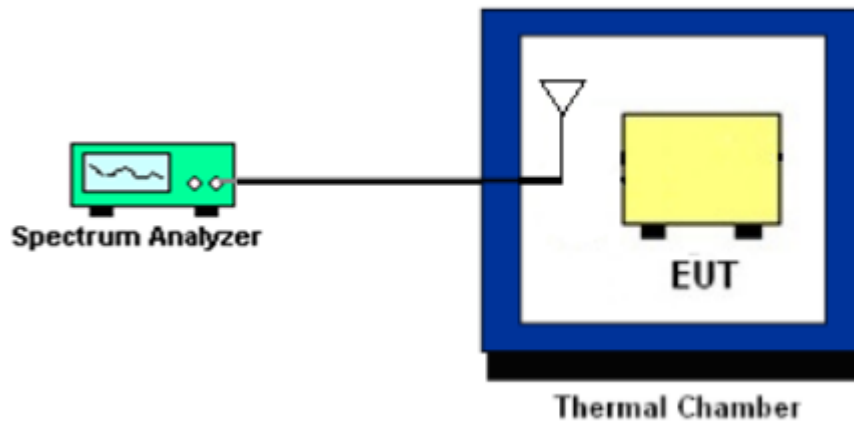
Frequency stability Setup**3.3 Test Result of Radiated Test**

Please refer to Appendix A.

Note:

The low frequency, which started from 9 kHz to 30MHz, was pre-scanned and the result which was 20dB lower than the limit line was not reported.

There is adequate comparison measurement of both open-field test site and alternative test site - semi-Anechoic chamber according to 414788 D01 Radiated Test Site v01r01, and the result came out very similar.



3.4 EIRP Measurement

3.4.1 Description of EIRP Measurement

For mobile stations, the average power of the sum of all antenna elements is limited to a maximum EIRP of +43 dBm.

3.4.2 Test Procedures

1. Set EUT at maximum output power.
2. Select lowest, middle, and highest channels for each band and different modulation.
3. Enable channel power function of spectrum analyzer
4. Set frequency would like to be investigated.
5. Set Detector = RMS
6. Set Trace mode = trace average
7. Set Sweep time = auto couple
8. Set sweep points $\geq 2 \times \text{Span/RBW}$
9. Set sweep count 100 and wait until the trace to be stabilized
10. Make the measurement with the spectrum analyzer's RBW = 1MHz, VBW = 3MHz, taking the record of maximum spurious emission.
11. Measure and record the power level from the spectrum analyzer.
12. The test result is calculated according to

ANSI C63.26-2015 Section 5.2.7

$$\text{EIRP (dBm)} = E(\text{dBuV/m}) + 20\log(D) - 104.8.$$

where D is the measurement distance (in the far field region) in m.

$$E(\text{dBuV/m}) = \text{Spectrum Level (dBm)} + \text{Antenna Factor (dB/m)} + \text{Cable Loss (dB)} + 107$$

That is, set the spectrum offset including sum of

$$\text{Antenna Factor (dB/m)} + \text{Cable Loss (dB)} + 107 + 20\log(D) - 104.8$$



3.5 Occupied Bandwidth

3.5.1 Description of Occupied Bandwidth Measurement

This is for reporting only.

The occupied bandwidth is the width of a frequency band such that, below the lower and above the upper frequency limits, the mean powers emitted are each equal to a specified percentage 0.5% of the total mean transmitted power.

3.5.2 Test Procedures

The testing follows ANSI C63.26-2015 Section 5.4.4

1. The spectrum analyzer center frequency is set to the nominal EUT channel center frequency. The span range for the spectrum analyzer shall be at least 1.5 times the anticipated OBW.
2. The nominal resolution bandwidth (RBW) shall be in the range of 1 to 5 % of the anticipated OBW, and the VBW shall be at least 3 times the RBW.
3. Set the detection mode to peak, and the trace mode to max hold.
4. Use the 99 % power bandwidth function of the spectrum analyzer and report the measured bandwidth.



3.6 Radiated Spurious Emission Measurement

3.6.1 Description of Radiated Spurious Emission Measurement

The spectrum is scanned from 30 MHz up to 200GHz.

The conductive power or the total radiated power of any emission outside a licensee's frequency block shall be -13 dBm/MHz or lower. However, in the bands immediately outside and adjacent to the licensee's frequency block, having a bandwidth equal to 10 percent of the channel bandwidth, the conductive power or the total radiated power of any emission shall be -5 dBm/MHz or lower.

3.6.2 Test Procedures

1. Set EUT at maximum output power..
2. Select lowest, middle, and highest channels for each band and different modulation.
3. Measure and record the power level from the spectrum analyzer.
4. Set frequency would like to be investigated.
5. Set Detector = RMS, Trace mode = trace average, sweep time = auto couple
6. Set sweep points $\geq 2 \times \text{Span/RBW}$, sweep count 100 and wait until the trace to be stabilized.
7. Make the measurement with the spectrum analyzer's RBW = 1MHz, VBW = 3MHz, taking the record of maximum spurious emission.
8. For measurement frequency from 30MHz to 18GHz,
An antenna was substituted in place of the EUT and was driven by a signal generator.
Tune the output power of signal generator to the same emission level with EUT maximum spurious emission. Take record of output power and repeat for another polarization.
9. For measurement frequency above 18GHz, the test result is calculated according to ANSI C63.26-2015 Section 5.2.7 and 5.7.3 and 5.7.4
$$\text{EIRP (dBm)} = \text{E(dBuV/m)} + 20\log(D) - 104.8.$$
where D is the measurement distance (in the far field region) in m.
$$\text{E (dBuV/m)} = \text{Spectrum Level (dBm)} + \text{Antenna Factor (dB/m)} + \text{Cable Loss (dB)} + 107$$
That is, set the spectrum offset including sum of
$$\text{Antenna Factor (dB/m)} + \text{Cable Loss (dB)} + 107 + 20\log(D) - 104.8$$
10. The conversion loss of RF mixer is also included in conversion loss table of the spectrum analyzer when measurement frequency is above 40GHz.
11. The TRP method refers to the clause 4.4.2.2 of FCC KDB 842590 D01 v01r02.
If EIRP measurement results exceed the emission limit, then TRP measurement will be used as an alternative method. Test results of TRP measurement are marked as "TRP Measurement".



3.7 Frequency Stability Measurement

3.7.1 Description of Frequency Stability Measurement

The frequency stability shall be measured by variation of ambient temperature and variation of primary supply voltage to ensure that the fundamental emission stays within the authorized frequency block.

3.7.2 Test Procedures for Temperature Variation

The testing follows FCC KDB 971168 D01 v03r01 Section 9.

1. The EUT was set up in the thermal chamber.
2. With power OFF, the temperature was decreased to -30°C and the EUT was stabilized before testing. Power was applied and the maximum change in frequency was recorded within one minute.
3. With power OFF, the temperature was raised in 10°C step up to 50°C. The EUT was stabilized at each step for at least half an hour. Power was applied and the maximum frequency change was recorded within one minute.

3.7.3 Test Procedures for Voltage Variation

The testing follows FCC KDB 971168 D01 v03r01 Section 9.

1. The EUT was placed in a temperature chamber at 20° C.
2. The power supply voltage to the EUT was varied from 85% to 115% of the nominal value measured at the input to the EUT.
3. The variation in frequency was measured for the worst case.



4 List of Measuring Equipment

Instrument	Brand Name	Model No.	Serial No.	Characteristics	Calibration Date	Test Date	Due Date	Remark
Amplifier	SONOMA	310N	187311	9kHz~1GHz	Oct. 21, 2020	Aug. 09, 2021	Oct. 20, 2021	Radiation (03CH19-HY)
Preamplifier	COM-POWER	PAM-103	18020199	1MHz~1000MHz	Jan. 04, 2021	Aug. 09, 2021	Jan. 03, 2022	Radiation (03CH19-HY)
Loop Antenna	Rohde & Schwarz	HFH2-Z2	100315	9kHz~30MHz	Jan. 04, 2021	Aug. 09, 2021	Jan. 03, 2022	Radiation (03CH19-HY)
Bilog Antenna	TESEQ	CBL 6111D & 00800N1D01N-06	55608 & 09	30MHz~1GHz	Oct. 22, 2020	Aug. 09, 2021	Oct. 21, 2021	Radiation (03CH19-HY)
Horn Antenna	SCHWARZBECK	BBHA 9120 D	9120D-02038	1GHz~18GHz	Nov. 03, 2020	Aug. 09, 2021	Nov. 02, 2021	Radiation (03CH19-HY)
Amplifier	EMCI	EMC118A45SE	980791	1GHz~18GHz	Nov. 16, 2020	Aug. 09, 2021	Nov. 15, 2021	Radiation (03CH19-HY)
EMI Test Receiver	Keysight	N9038A	MY59053012	N/A	Nov. 18, 2020	Aug. 09, 2021	Nov. 17, 2021	Radiation (03CH19-HY)
Controller	EMEC	EM 1000	N/A	Control Turn table & Ant Mast	N/A	Aug. 09, 2021	N/A	Radiation (03CH19-HY)
Antenna Mast	EMEC	AM-BS-4500-B	N/A	1~4m	N/A	Aug. 09, 2021	N/A	Radiation (03CH19-HY)
Turn Table	EMEC	TT 2200	N/A	0~360 Degree	N/A	Aug. 09, 2021	N/A	Radiation (03CH19-HY)
Software	Audix	E3 6.2009-8-24	RK-002155	N/A	Jun. 20, 2021	Aug. 09, 2021	N/A	Radiation (03CH19-HY)
RF Cable	HUBER + SUHNER	SUCOFLEX 102	519226/2,804014/2,804026/2	30MHz~40GHz	Jan. 20, 2021	Aug. 09, 2021	Jan. 19, 2022	Radiation (03CH19-HY)
SHF-EHF Horn Antenna	SCHWARZBECK	BBHA 9170	BBHA9170584	18GHz~40GHz	Dec. 11, 2020	Jul. 08, 2021~ Aug. 16, 2021	Dec. 10, 2021	Radiation (03CH18-HY)
Spectrum Analyzer	Rohde & Schwarz	FSV3044	101010	10Hz~44GHz	Nov. 25, 2020	Jul. 08, 2021~ Aug. 16, 2021	Nov. 24, 2021	Radiation (03CH18-HY)
RF Cable	HUBER + SUHNER	SUCOFLEX 102	801607/2	9kHz~40GHz	Dec. 22, 2020	Jul. 08, 2021~ Aug. 16, 2021	Dec. 21, 2021	Radiation (03CH18-HY)
Software	Sporton	TRP Tool v1	N/A	N/A	N/A	Jul. 08, 2021~ Aug. 16, 2021	N/A	Radiation (03CH18-HY)
Temperature & Humidity Cabinet Chamber	ESPEC	SU-641	92013721	-30°C ~70°C	Nov. 10, 2020	Jul. 08, 2021~ Aug. 09, 2021	Nov. 09, 2021	Radiation (03CH18-HY)
Turn Table	EMEC	N/A	N/A	Phi/Theta 0~360 Degree	N/A	Jul. 08, 2021~ Aug. 09, 2021	N/A	Radiation (03CH18-HY)
Controller	EMEC	EM 1000	N/A	Control Turn table	N/A	Jul. 08, 2021~ Aug. 09, 2021	N/A	Radiation (03CH18-HY)
*Mixer	Rohde & Schwarz	FS-Z60	101033	40 ~ 60 GHz	Mar. 17, 2020	Jul. 08, 2021~ Aug. 09, 2021	Mar. 16, 2023	Radiation (03CH18-HY)
*Mixer	Rohde & Schwarz	FS-Z90	101867	60 ~ 90 GHz	Jan. 10, 2019	Jul. 08, 2021~ Aug. 09, 2021	Jan. 09, 2022	Radiation (03CH18-HY)
*Mixer	Rohde & Schwarz	FS-Z140	101128	90 ~ 140 GHz	Oct. 26, 2020	Jul. 08, 2021~ Aug. 09, 2021	Oct. 25, 2023	Radiation (03CH18-HY)
*Mixer	Rohde & Schwarz	FS-Z220	101014	140 ~ 220 GHz	Aug. 27, 2018	Jul. 08, 2021~ Aug. 09, 2021	Aug. 26, 2021	Radiation (03CH18-HY)
Standard Horn Antenna	Quinstar	QWH-UPRR00	923600007	40 ~ 60 GHz	Aug. 17, 2018	Jul. 08, 2021~ Aug. 09, 2021	Aug. 16, 2021	Radiation (03CH18-HY)
Standard Horn Antenna	Quinstar	QWH-EPRR00	784600034	60 ~ 90 GHz	Aug. 17, 2018	Jul. 08, 2021~ Aug. 09, 2021	Aug. 16, 2021	Radiation (03CH18-HY)
Standard Horn Antenna	Quinstar	QWH-FPRR00	923800008	90 ~ 140 GHz	Aug. 17, 2018	Jul. 08, 2021~ Aug. 09, 2021	Aug. 16, 2021	Radiation (03CH18-HY)
Standard Horn Antenna	Quinstar	QWH-GPRR00	923900001	140 ~ 220 GHz	Aug. 17, 2018	Jul. 08, 2021~ Aug. 09, 2021	Aug. 16, 2021	Radiation (03CH18-HY)



Instrument	Brand Name	Model No.	Serial No.	Characteristics	Calibration Date	Test Date	Due Date	Remark
Controller	EMEC	EM 1000	N/A	Control 3D positioner	N/A	Jul. 08, 2021~ Aug. 09, 2021	N/A	Radiation (03CH18-HY)
3D positioner	EMEC	N/A	N/A	Theta/Phi	N/A	Jul. 08, 2021~ Aug. 09, 2021	N/A	Radiation (03CH18-HY)
RF Cable	HUBER + SUHNER	SUCOFLEX 102	801607/2	9kHz~40GHz	Dec. 22, 2020	Jul. 08, 2021~ Aug. 09, 2021	Dec. 21, 2021	Radiation (03CH18-HY)
RF Cable	HUBER + SUHNER	SUCOFLEX 102	801589/2	9kHz~40GHz	Dec. 22, 2020	Jul. 08, 2021~ Aug. 09, 2021	Dec. 21, 2021	Radiation (03CH18-HY)
Spectrum Analyzer	Rohde & Schwarz	FSV30	103738	9kHz to 30GHz	May 19, 2021	Jul. 08, 2021~ Aug. 09, 2021	May 18, 2022	Radiation (03CH18-HY)

Note 1: (*) Equipment manufacturer's Calibration Certificate.

Note 2: The Standard Gain Horn Antennas are calibrated by the ISO 17025 accredited test lab MWM Lab (<http://en.mwmlab.com/about>),

a sub unit of Belarussian State University of Informatics and Radio electronics which is accredited by the Belarussian State

Centre for Accreditation (BSCA). BSCA is the National accreditation body of the Republic of Belarus and an associated

member of the International Laboratory Accreditation Cooperation (ILAC).



5 Uncertainty of Evaluation

Uncertainty of Radiated Emission Measurement (30 MHz ~ 1000 MHz)

Measuring Uncertainty for a Level of Confidence of 95% (U = 2Uc(y))	3.31
---	------

Uncertainty of Radiated Emission Measurement (1 GHz ~ 18 GHz)

Measuring Uncertainty for a Level of Confidence of 95% (U = 2Uc(y))	3.62
---	------

Uncertainty of Radiated Emission Measurement (18 GHz ~ 40 GHz)

Measuring Uncertainty for a Level of Confidence of 95% (U = 2Uc(y))	4.62
---	------

Uncertainty of Radiated Emission Measurement (40 GHz ~ 140 GHz)

Measuring Uncertainty for a Level of Confidence of 95% (U = 2Uc(y))	5.92
---	------

Uncertainty of Radiated Emission Measurement (140 GHz ~ 200 GHz)

Measuring Uncertainty for a Level of Confidence of 95% (U = 2Uc(y))	6.78
---	------



Appendix A. Test Results of Conducted and Radiated Test

EIRP Power (Average power)

Module A

NR Band n258A Module A H (Beam ID: 4)					
Maximum Average EIRP [dBm]					
	BW [MHz]	Waveform	Modulation	Inner 1RB	Inner Full
Lowest	100	DFT-S	QPSK	22.37	22.48
	100	DFT-S	16QAM	19.42	19.26
	100	DFT-S	64QAM	16.42	17.21
	100	CP	QPSK	18.81	18.82
NR Band n258A Module A H (Beam ID: 3)					
Maximum Average EIRP [dBm]					
	BW [MHz]	Waveform	Modulation	Inner 1RB	Inner Full
Middle	100	DFT-S	QPSK	24.73	24.98
	100	DFT-S	16QAM	21.95	21.96
	100	DFT-S	64QAM	18.70	19.87
	100	CP	QPSK	21.65	21.66
	200	DFT-S	QPSK	21.62	23.03
	200	DFT-S	16QAM	20.84	21.06
	200	DFT-S	64QAM	17.82	18.75
	200	CP	QPSK	21.3	21.43
NR Band n258A Module A H (Beam ID: 3)					
Maximum Average EIRP [dBm]					
	BW [MHz]	Waveform	Modulation	Inner 1RB	Inner Full
Highest	100	DFT-S	QPSK	24.96	25.26
	100	DFT-S	16QAM	22.10	22.11
	100	DFT-S	64QAM	19.07	20.17
	100	CP	QPSK	21.33	21.84

Note : The 200MHz Bandwidth is carrier aggregation by 2CC of 100MHz.



NR Band n258A Module A V (Beam ID: 4)					
Maximum Average EIRP [dBm]					
	BW [MHz]	Waveform	Modulation	Inner 1RB	Inner Full
Lowest	100	DFT-S	QPSK	25.05	24.77
	100	DFT-S	16QAM	21.61	21.68
	100	DFT-S	64QAM	24.14	19.65
	100	CP	QPSK	22.13	21.26
NR Band n258A Module A V (Beam ID: 3)					
Maximum Average EIRP [dBm]					
	BW [MHz]	Waveform	Modulation	Inner 1RB	Inner Full
Middle	100	DFT-S	QPSK	26.28	26.06
	100	DFT-S	16QAM	22.52	22.90
	100	DFT-S	64QAM	21.09	20.97
	100	CP	QPSK	22.79	22.64
	200	DFT-S	QPSK	22.20	23.18
	200	DFT-S	16QAM	21.98	21.34
	200	DFT-S	64QAM	18.62	18.59
	200	CP	QPSK	21.87	22.13
	NR Band n258A Module A V (Beam ID: 3)				
Maximum Average EIRP [dBm]					
	BW [MHz]	Waveform	Modulation	Inner 1RB	Inner Full
Highest	100	DFT-S	QPSK	26.18	25.79
	100	DFT-S	16QAM	22.08	22.64
	100	DFT-S	64QAM	20.76	20.67
	100	CP	QPSK	22.78	22.44

Note : The 200MHz Bandwidth is carrier aggregation by 2CC of 100MHz.



NR Band n258A Module A H+V (Beam ID: 4+4)					
Maximum Average EIRP [dBm]					
Lowest	BW [MHz]	Waveform	Modulation	Inner 1RB	Inner Full
	100	DFT-S	QPSK	25.43	25.49
	100	DFT-S	16QAM	22.57	22.85
	100	DFT-S	64QAM	21.50	20.79
	100	CP	QPSK	22.20	22.41
NR Band n258A Module A H+V (Beam ID: 3+3)					
Maximum Average EIRP [dBm]					
Middle	BW [MHz]	Waveform	Modulation	Inner 1RB	Inner Full
	100	DFT-S	QPSK	26.80	26.96
	100	DFT-S	16QAM	23.72	23.83
	100	DFT-S	64QAM	20.70	21.74
	100	CP	QPSK	23.06	23.33
	200	DFT-S	QPSK	23.76	25.09
	200	DFT-S	16QAM	23.26	23.17
	200	DFT-S	64QAM	20.22	20.40
	200	CP	QPSK	23.36	23.20
NR Band n258A Module A H+V (Beam ID: 3+3)					
Maximum Average EIRP [dBm]					
Highest	BW [MHz]	Waveform	Modulation	Inner 1RB	Inner Full
	100	DFT-S	QPSK	26.76	27.03
	100	DFT-S	16QAM	23.44	23.84
	100	DFT-S	64QAM	21.88	21.87
	100	CP	QPSK	19.33	19.78

Note : The 200MHz Bandwidth is carrier aggregation by 2CC of 100MHz.

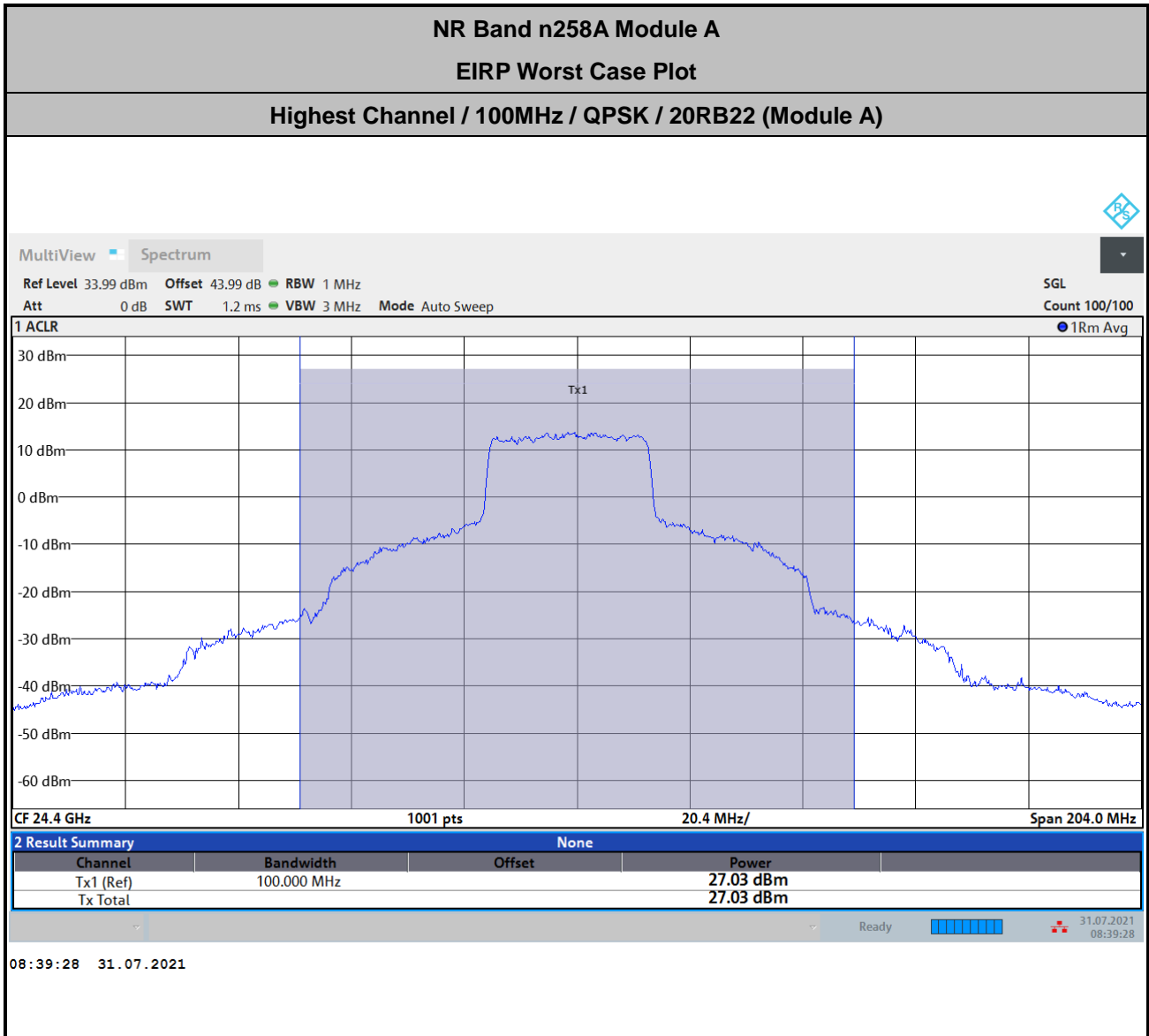

$$\text{Offset} = \text{Antenna Factor (dB/m)} + \text{Cable Loss (dB)} + 107 + 20\log(D) - 104.8$$

$$= 39.2 + 2.59 + 107 + 20\log(1) - 104.8 = 43.99 \text{ (dB)}$$



Module B

NR Band n258A Module B H (Beam ID: 2)					
Maximum Average EIRP [dBm]					
	BW [MHz]	Waveform	Modulation	Inner 1RB	Inner Full
Lowest	100	DFT-S	QPSK	24.36	24.28
	100	DFT-S	16QAM	21.59	21.58
	100	DFT-S	64QAM	19.14	19.25
	100	CP	QPSK	21.71	21.59
NR Band n258A Module B H (Beam ID: 5)					
Maximum Average EIRP [dBm]					
	BW [MHz]	Waveform	Modulation	Inner 1RB	Inner Full
Middle	100	DFT-S	QPSK	24.29	24.37
	100	DFT-S	16QAM	21.06	21.29
	100	DFT-S	64QAM	18.15	19.21
	100	CP	QPSK	20.58	20.94
	200	DFT-S	QPSK	22.01	23.08
	200	DFT-S	16QAM	20.00	21.34
	200	DFT-S	64QAM	17.86	18.95
	200	CP	QPSK	21.99	22.22
NR Band n258A Module B H (Beam ID: 2)					
Maximum Average EIRP [dBm]					
	BW [MHz]	Waveform	Modulation	Inner 1RB	Inner Full
Highest	100	DFT-S	QPSK	22.09	22.29
	100	DFT-S	16QAM	19.13	19.20
	100	DFT-S	64QAM	15.98	17.23
	100	CP	QPSK	18.46	18.83

Note : The 200MHz Bandwidth is carrier aggregation by 2CC of 100MHz.



NR Band n258A Module B V (Beam ID: 2)					
Maximum Average EIRP [dBm]					
	BW [MHz]	Waveform	Modulation	Inner 1RB	Inner Full
Lowest	100	DFT-S	QPSK	24.54	24.10
	100	DFT-S	16QAM	21.20	21.22
	100	DFT-S	64QAM	19.86	19.27
	100	CP	QPSK	21.82	21.74
NR Band n258A Module B V (Beam ID: 5)					
Maximum Average EIRP [dBm]					
	BW [MHz]	Waveform	Modulation	Inner 1RB	Inner Full
Middle	100	DFT-S	QPSK	24.99	24.91
	100	DFT-S	16QAM	21.15	21.58
	100	DFT-S	64QAM	19.59	19.35
	100	CP	QPSK	21.74	21.37
	200	DFT-S	QPSK	22.37	23.37
	200	DFT-S	16QAM	21.20	21.23
	200	DFT-S	64QAM	18.34	18.52
	200	CP	QPSK	22.17	22.36
NR Band n258A Module B V (Beam ID: 2)					
Maximum Average EIRP [dBm]					
	BW [MHz]	Waveform	Modulation	Inner 1RB	Inner Full
Highest	100	DFT-S	QPSK	25.16	25.08
	100	DFT-S	16QAM	21.47	21.94
	100	DFT-S	64QAM	20.29	19.98
	100	CP	QPSK	22.02	21.66

Note : The 200MHz Bandwidth is carrier aggregation by 2CC of 100MHz.



NR Band n258A Module B H+V (Beam ID: 2+2)					
Maximum Average EIRP [dBm]					
Lowest	BW [MHz]	Waveform	Modulation	Inner 1RB	Inner Full
	100	DFT-S	QPSK	24.93	24.58
	100	DFT-S	16QAM	21.33	21.19
	100	DFT-S	64QAM	19.57	19.10
	100	CP	QPSK	21.89	20.91
NR Band n258A Module B H+V (Beam ID: 5+5)					
Maximum Average EIRP [dBm]					
Middle	BW [MHz]	Waveform	Modulation	Inner 1RB	Inner Full
	100	DFT-S	QPSK	25.90	25.97
	100	DFT-S	16QAM	23.05	23.10
	100	DFT-S	64QAM	20.64	21.00
	100	CP	QPSK	22.59	22.66
	200	DFT-S	QPSK	24.00	24.80
	200	DFT-S	16QAM	22.83	22.75
	200	DFT-S	64QAM	19.52	20.31
	200	CP	QPSK	23.81	23.88
NR Band n258A Module B H+V (Beam ID: 2+2)					
Maximum Average EIRP [dBm]					
Highest	BW [MHz]	Waveform	Modulation	Inner 1RB	Inner Full
	100	DFT-S	QPSK	25.65	25.35
	100	DFT-S	16QAM	21.97	22.19
	100	DFT-S	64QAM	20.22	20.16
	100	CP	QPSK	22.40	21.96

Note : The 200MHz Bandwidth is carrier aggregation by 2CC of 100MHz.

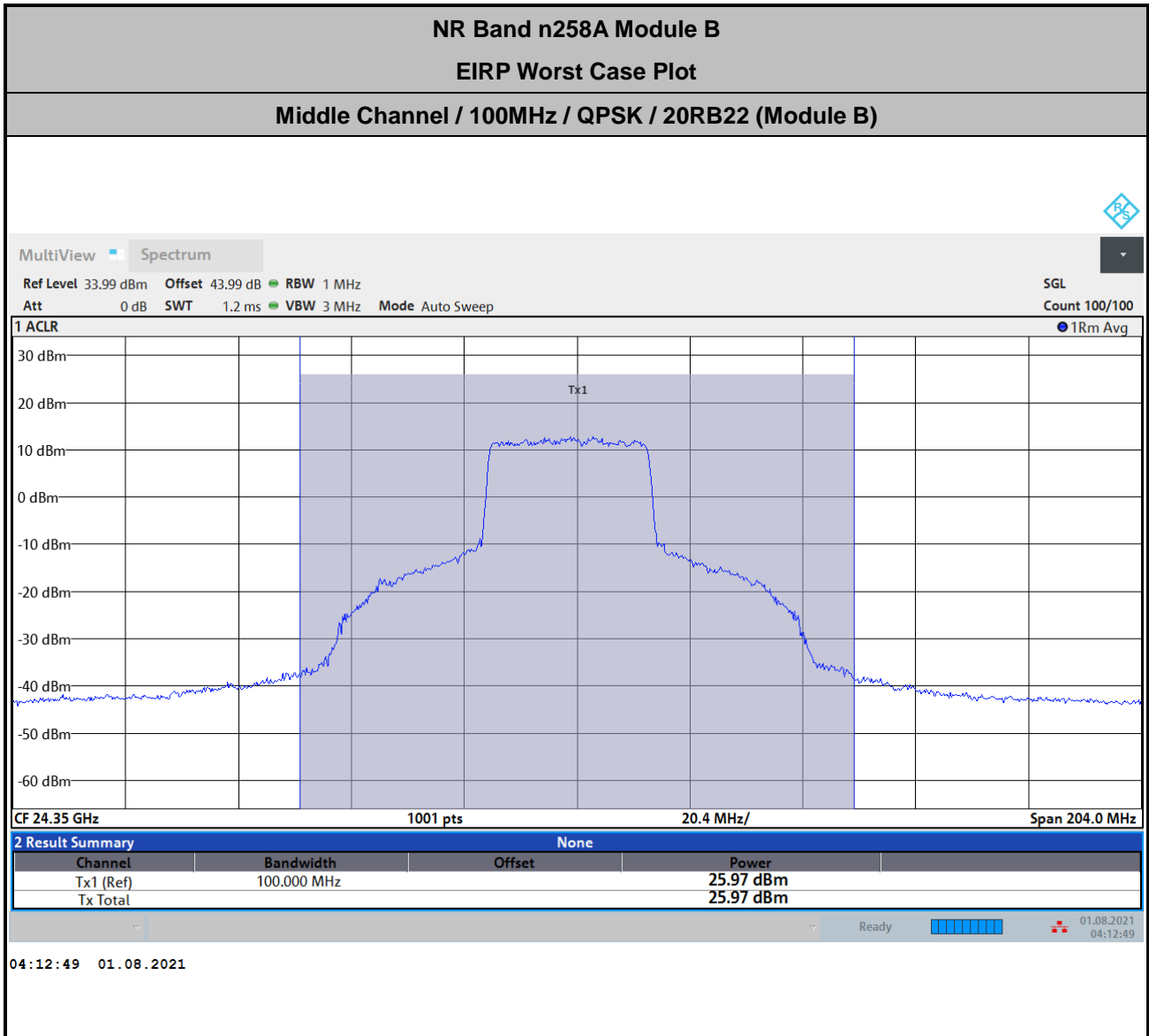

$$\text{Offset} = \text{Antenna Factor (dB/m)} + \text{Cable Loss (dB)} + 107 + 20\log(D) - 104.8$$

$$= 39.2 + 2.59 + 107 + 20\log(1) - 104.8 = 43.99 \text{ (dB)}$$



Module A

NR Band n258B Module A H (Beam ID: 4)					
Maximum Average EIRP [dBm]					
	BW [MHz]	Waveform	Modulation	Inner 1RB	Inner Full
Lowest	100	DFT-S	QPSK	22.29	22.44
	100	DFT-S	16QAM	19.34	19.07
	100	DFT-S	64QAM	16.42	17.01
	100	CP	QPSK	18.55	18.67
	200	DFT-S	QPSK	20.79	21.28
	200	DFT-S	16QAM	18.53	19.10
	200	DFT-S	64QAM	15.60	16.85
	200	CP	QPSK	19.75	20.40
NR Band n258B Module A H (Beam ID: 3)					
Maximum Average EIRP [dBm]					
	BW [MHz]	Waveform	Modulation	Inner 1RB	Inner Full
Middle	100	DFT-S	QPSK	24.53	24.46
	100	DFT-S	16QAM	21.44	21.29
	100	DFT-S	64QAM	18.17	19.27
	100	CP	QPSK	20.39	20.57
	200	DFT-S	QPSK	21.57	22.18
	200	DFT-S	16QAM	19.74	20.51
	200	DFT-S	64QAM	16.87	18.03
	200	CP	QPSK	20.51	21.07
NR Band n258B Module A H (Beam ID: 3)					
Maximum Average EIRP [dBm]					
	BW [MHz]	Waveform	Modulation	Inner 1RB	Inner Full
Highest	100	DFT-S	QPSK	24.46	24.35
	100	DFT-S	16QAM	21.55	21.28
	100	DFT-S	64QAM	18.55	19.11
	100	CP	QPSK	20.81	21.01
	200	DFT-S	QPSK	22.78	23.33
	200	DFT-S	16QAM	21.81	21.34
	200	DFT-S	64QAM	18.52	19.21
	200	CP	QPSK	22.40	22.30

Note : The 200MHz Bandwidth is carrier aggregation by 2CC of 100MHz.



NR Band n258B Module A V (Beam ID: 4)					
Maximum Average EIRP [dBm]					
	BW [MHz]	Waveform	Modulation	Inner 1RB	Inner Full
Lowest	100	DFT-S	QPSK	24.79	24.31
	100	DFT-S	16QAM	21.09	21.04
	100	DFT-S	64QAM	19.87	19.06
	100	CP	QPSK	21.55	20.83
	200	DFT-S	QPSK	21.76	22.66
	200	DFT-S	16QAM	20.77	20.27
	200	DFT-S	64QAM	17.70	18.12
	200	CP	QPSK	21.29	21.63
NR Band n258B Module A V (Beam ID: 3)					
Maximum Average EIRP [dBm]					
	BW [MHz]	Waveform	Modulation	Inner 1RB	Inner Full
Middle	100	DFT-S	QPSK	25.19	25.07
	100	DFT-S	16QAM	21.65	21.94
	100	DFT-S	64QAM	20.09	19.92
	100	CP	QPSK	21.99	21.67
	200	DFT-S	QPSK	23.39	24.29
	200	DFT-S	16QAM	21.08	22.12
	200	DFT-S	64QAM	19.01	19.59
	200	CP	QPSK	22.38	23.21
NR Band n258B Module A V (Beam ID: 3)					
Maximum Average EIRP [dBm]					
	BW [MHz]	Waveform	Modulation	Inner 1RB	Inner Full
Highest	100	DFT-S	QPSK	24.45	24.07
	100	DFT-S	16QAM	20.62	20.86
	100	DFT-S	64QAM	19.30	18.89
	100	CP	QPSK	20.86	20.67
	200	DFT-S	QPSK	21.96	23.09
	200	DFT-S	16QAM	20.25	21.45
	200	DFT-S	64QAM	17.95	18.53
	200	CP	QPSK	21.72	22.22

Note : The 200MHz Bandwidth is carrier aggregation by 2CC of 100MHz.



NR Band n258B Module A H+V (Beam ID: 4+4)					
Maximum Average EIRP [dBm]					
Lowest	BW [MHz]	Waveform	Modulation	Inner 1RB	Inner Full
	100	DFT-S	QPSK	25.66	25.84
	100	DFT-S	16QAM	22.34	22.57
	100	DFT-S	64QAM	20.86	20.45
	100	CP	QPSK	22.48	22.15
	200	DFT-S	QPSK	23.11	24.18
	200	DFT-S	16QAM	21.59	22.25
	200	DFT-S	64QAM	19.07	19.83
	200	CP	QPSK	22.69	23.20
NR Band n258B Module A H+V (Beam ID: 3+3)					
Maximum Average EIRP [dBm]					
Middle	BW [MHz]	Waveform	Modulation	Inner 1RB	Inner Full
	100	DFT-S	QPSK	27.62	27.81
	100	DFT-S	16QAM	24.02	24.33
	100	DFT-S	64QAM	22.06	22.29
	100	CP	QPSK	24.30	23.96
	200	DFT-S	QPSK	25.36	26.13
	200	DFT-S	16QAM	23.00	24.69
	200	DFT-S	64QAM	21.39	22.03
	200	CP	QPSK	24.33	24.99
NR Band n258B Module A H+V (Beam ID: 3+3)					
Maximum Average EIRP [dBm]					
Highest	BW [MHz]	Waveform	Modulation	Inner 1RB	Inner Full
	100	DFT-S	QPSK	27.43	27.12
	100	DFT-S	16QAM	23.92	23.90
	100	DFT-S	64QAM	21.78	21.98
	100	CP	QPSK	23.95	23.69
	200	DFT-S	QPSK	25.20	26.51
	200	DFT-S	16QAM	24.28	24.59
	200	DFT-S	64QAM	21.49	22.06
	200	CP	QPSK	25.00	25.52

Note : The 200MHz Bandwidth is carrier aggregation by 2CC of 100MHz.

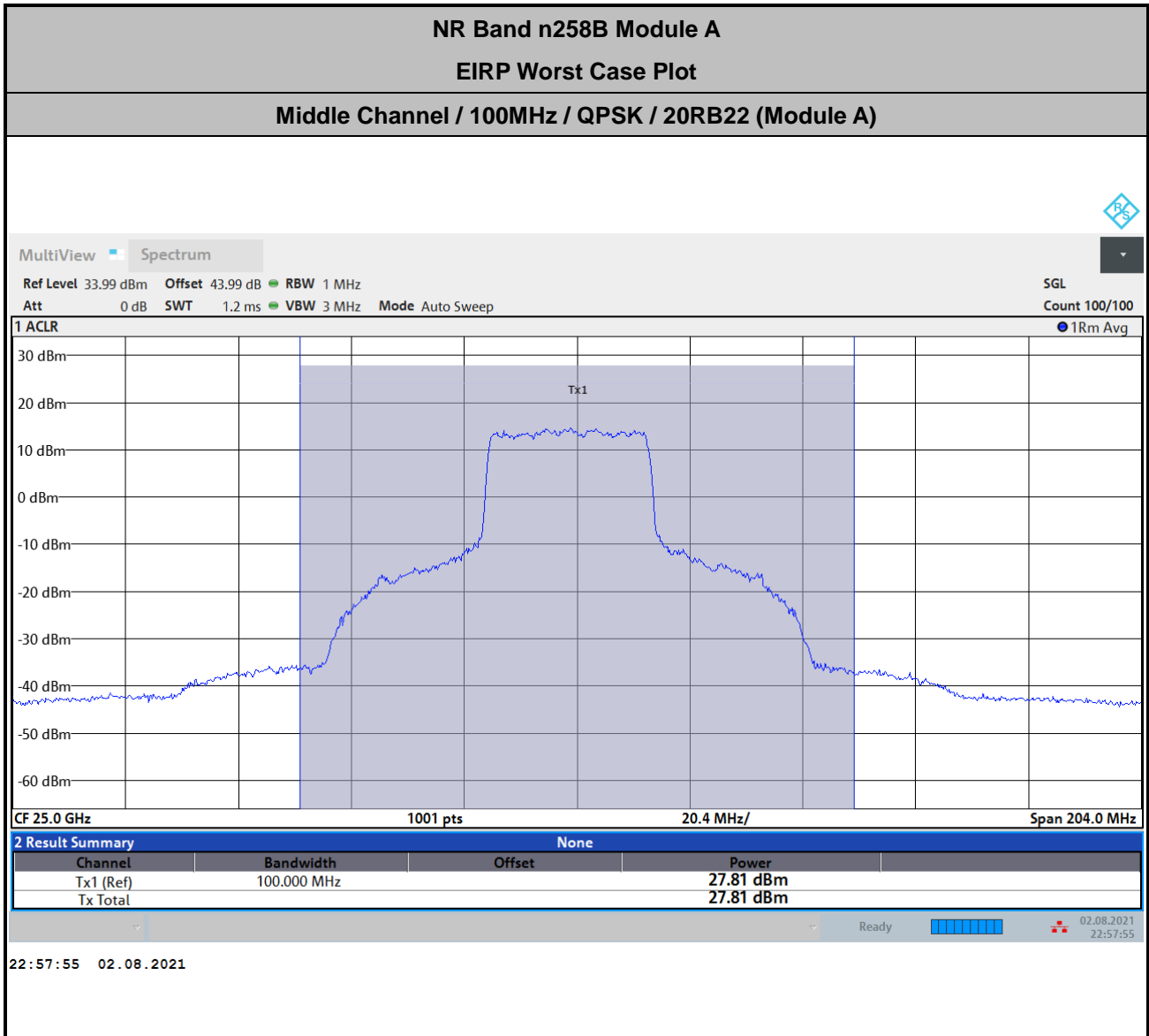

$$\text{Offset} = \text{Antenna Factor (dB/m)} + \text{Cable Loss (dB)} + 107 + 20\log(D) - 104.8$$

$$= 39.2 + 2.59 + 107 + 20\log(1) - 104.8 = 43.99 \text{ (dB)}$$



Module B

NR Band n258B Module B H (Beam ID: 2)					
Maximum Average EIRP [dBm]					
	BW [MHz]	Waveform	Modulation	Inner 1RB	Inner Full
Lowest	100	DFT-S	QPSK	21.89	21.83
	100	DFT-S	16QAM	18.90	18.63
	100	DFT-S	64QAM	15.88	16.73
	100	CP	QPSK	18.09	18.35
	200	DFT-S	QPSK	19.86	20.57
	200	DFT-S	16QAM	18.17	18.41
	200	DFT-S	64QAM	15.76	16.35
	200	CP	QPSK	19.34	19.67
NR Band n258B Module B H (Beam ID: 5)					
Maximum Average EIRP [dBm]					
	BW [MHz]	Waveform	Modulation	Inner 1RB	Inner Full
Middle	100	DFT-S	QPSK	23.20	23.51
	100	DFT-S	16QAM	20.36	20.38
	100	DFT-S	64QAM	17.11	18.35
	100	CP	QPSK	19.81	20.02
	200	DFT-S	QPSK	23.46	24.15
	200	DFT-S	16QAM	21.50	22.28
	200	DFT-S	64QAM	19.00	19.62
	200	CP	QPSK	22.67	23.17
NR Band n258B Module B H (Beam ID: 2)					
Maximum Average EIRP [dBm]					
	BW [MHz]	Waveform	Modulation	Inner 1RB	Inner Full
Highest	100	DFT-S	QPSK	23.86	24.03
	100	DFT-S	16QAM	21.13	21.01
	100	DFT-S	64QAM	17.95	19.05
	100	CP	QPSK	20.36	20.55
	200	DFT-S	QPSK	22.63	23.36
	200	DFT-S	16QAM	20.73	21.30
	200	DFT-S	64QAM	17.68	18.65
	200	CP	QPSK	21.42	22.61

Note : The 200MHz Bandwidth is carrier aggregation by 2CC of 100MHz.



NR Band n258B Module B V (Beam ID: 2)					
Maximum Average EIRP [dBm]					
	BW [MHz]	Waveform	Modulation	Inner 1RB	Inner Full
Lowest	100	DFT-S	QPSK	25.04	24.61
	100	DFT-S	16QAM	21.42	21.49
	100	DFT-S	64QAM	19.89	19.38
	100	CP	QPSK	21.67	23.64
	200	DFT-S	QPSK	22.95	23.81
	200	DFT-S	16QAM	21.44	21.77
	200	DFT-S	64QAM	18.42	19.06
	200	CP	QPSK	22.39	23.31
NR Band n258B Module B V (Beam ID: 5)					
Maximum Average EIRP [dBm]					
	BW [MHz]	Waveform	Modulation	Inner 1RB	Inner Full
Middle	100	DFT-S	QPSK	25.45	25.22
	100	DFT-S	16QAM	21.49	21.91
	100	DFT-S	64QAM	20.14	19.89
	100	CP	QPSK	20.89	20.86
	200	DFT-S	QPSK	23.48	24.20
	200	DFT-S	16QAM	22.01	22.12
	200	DFT-S	64QAM	19.46	19.61
	200	CP	QPSK	22.89	22.97
NR Band n258B Module B V (Beam ID: 2)					
Maximum Average EIRP [dBm]					
	BW [MHz]	Waveform	Modulation	Inner 1RB	Inner Full
Highest	100	DFT-S	QPSK	24.26	23.91
	100	DFT-S	16QAM	20.59	20.78
	100	DFT-S	64QAM	19.23	18.76
	100	CP	QPSK	20.47	20.43
	200	DFT-S	QPSK	21.36	22.65
	200	DFT-S	16QAM	20.20	20.91
	200	DFT-S	64QAM	17.76	18.30
	200	CP	QPSK	21.20	21.48

Note : The 200MHz Bandwidth is carrier aggregation by 2CC of 100MHz.



NR Band n258B Module B H+V (Beam ID: 2+2)					
Maximum Average EIRP [dBm]					
Lowest	BW [MHz]	Waveform	Modulation	Inner 1RB	Inner Full
	100	DFT-S	QPSK	25.48	25.08
	100	DFT-S	16QAM	22.01	21.99
	100	DFT-S	64QAM	20.16	19.97
	100	CP	QPSK	21.86	21.50
	200	DFT-S	QPSK	23.30	24.02
	200	DFT-S	16QAM	22.21	22.52
	200	DFT-S	64QAM	19.36	20.28
	200	CP	QPSK	22.65	23.16
NR Band n258B Module B H+V (Beam ID: 5+5)					
Maximum Average EIRP [dBm]					
Middle	BW [MHz]	Waveform	Modulation	Inner 1RB	Inner Full
	100	DFT-S	QPSK	27.51	27.47
	100	DFT-S	16QAM	24.08	24.36
	100	DFT-S	64QAM	21.88	22.30
	100	CP	QPSK	24.10	23.96
	200	DFT-S	QPSK	24.27	25.89
	200	DFT-S	16QAM	23.04	23.99
	200	DFT-S	64QAM	20.62	21.41
200	CP	QPSK	23.29	24.14	
NR Band n258B Module B H+V (Beam ID: 2+2)					
Maximum Average EIRP [dBm]					
Highest	BW [MHz]	Waveform	Modulation	Inner 1RB	Inner Full
	100	DFT-S	QPSK	24.67	24.32
	100	DFT-S	16QAM	20.99	21.18
	100	DFT-S	64QAM	19.06	19.11
	100	CP	QPSK	21.47	20.98
	200	DFT-S	QPSK	22.95	23.83
	200	DFT-S	16QAM	22.16	22.66
	200	DFT-S	64QAM	19.50	20.02
200	CP	QPSK	22.64	23.30	

Note : The 200MHz Bandwidth is carrier aggregation by 2CC of 100MHz.

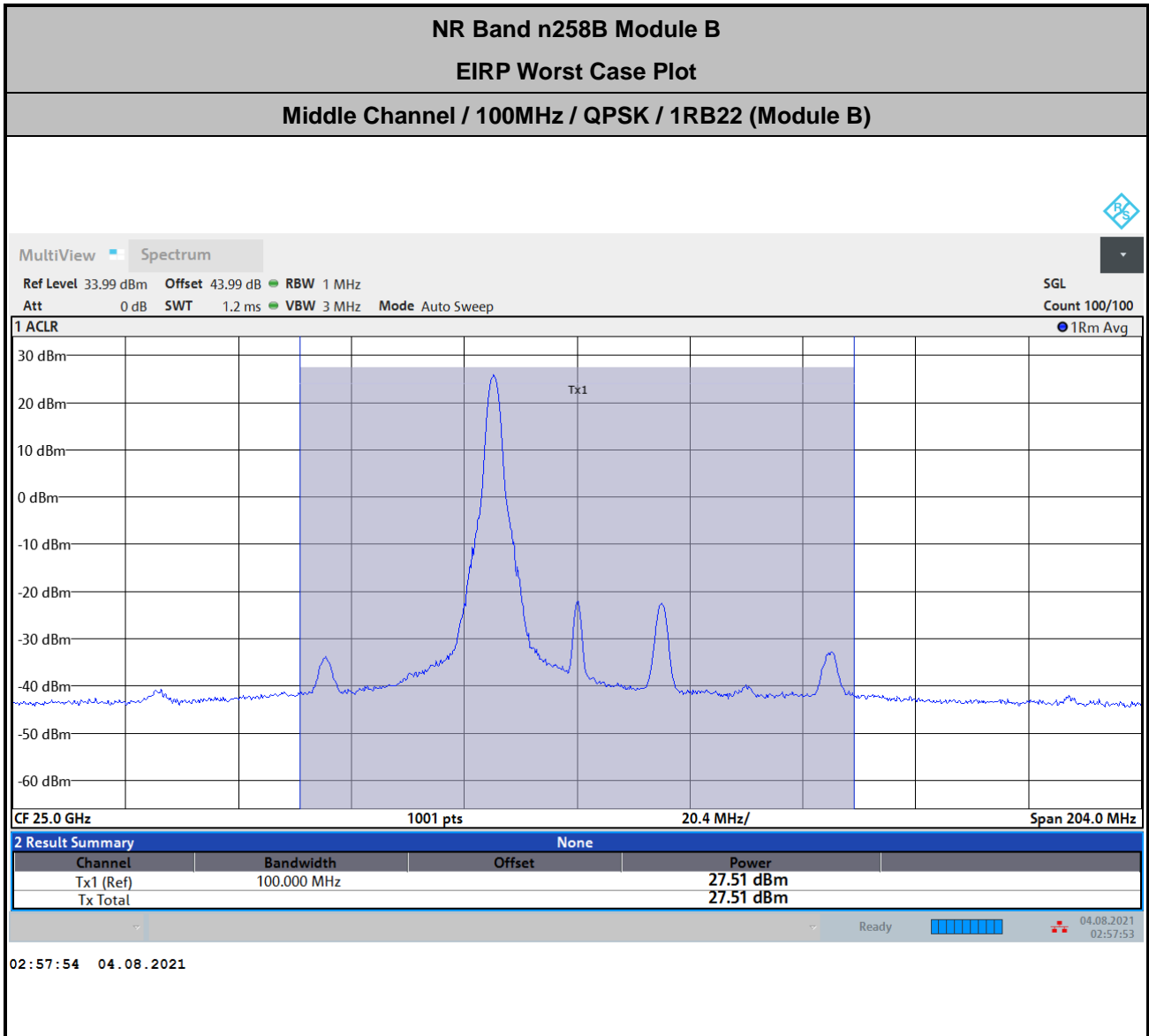

$$\text{Offset} = \text{Antenna Factor (dB/m)} + \text{Cable Loss (dB)} + 107 + 20\log(D) - 104.8$$

$$= 39.2 + 2.59 + 107 + 20\log(1) - 104.8 = 43.99 \text{ (dB)}$$



Module A

NR Band n260 Module A H (Beam ID: 4)					
Maximum Average EIRP [dBm]					
	BW [MHz]	Waveform	Modulation	Inner 1RB	Inner Full
Lowest	100	DFT-S	QPSK	26.76	26.75
	100	DFT-S	16QAM	23.44	23.27
	100	DFT-S	64QAM	20.57	21.52
	100	CP	QPSK	23.74	23.40
	200	DFT-S	QPSK	23.43	24.68
	200	DFT-S	16QAM	22.65	23.53
	200	DFT-S	64QAM	20.04	20.59
	200	CP	QPSK	23.24	23.71
NR Band n260 Module A H (Beam ID: 1)					
Maximum Average EIRP [dBm]					
	BW [MHz]	Waveform	Modulation	Inner 1RB	Inner Full
Middle	100	DFT-S	QPSK	24.77	24.76
	100	DFT-S	16QAM	22.31	21.79
	100	DFT-S	64QAM	19.49	19.89
	100	CP	QPSK	21.52	21.10
	200	DFT-S	QPSK	23.02	23.47
	200	DFT-S	16QAM	21.47	22.44
	200	DFT-S	64QAM	18.19	19.34
	200	CP	QPSK	22.41	23.06
NR Band n260 Module A H (Beam ID: 4)					
Maximum Average EIRP [dBm]					
	BW [MHz]	Waveform	Modulation	Inner 1RB	Inner Full
Highest	100	DFT-S	QPSK	23.31	23.54
	100	DFT-S	16QAM	20.45	20.27
	100	DFT-S	64QAM	17.36	17.96
	100	CP	QPSK	19.99	20.08
	200	DFT-S	QPSK	22.20	23.06
	200	DFT-S	16QAM	21.00	21.73
	200	DFT-S	64QAM	18.20	19.21
	200	CP	QPSK	22.01	22.14

Note : The 200MHz Bandwidth is carrier aggregation by 2CC of 100MHz.



NR Band n260 Module A V (Beam ID: 2)					
Maximum Average EIRP [dBm]					
	BW [MHz]	Waveform	Modulation	Inner 1RB	Inner Full
Lowest	100	DFT-S	QPSK	26.27	25.89
	100	DFT-S	16QAM	21.93	22.94
	100	DFT-S	64QAM	20.79	21.00
	100	CP	QPSK	22.80	23.15
	200	DFT-S	QPSK	22.15	23.41
	200	DFT-S	16QAM	20.58	21.87
	200	DFT-S	64QAM	18.23	19.22
	200	CP	QPSK	21.98	22.93
NR Band n260 Module A V (Beam ID: 4)					
Maximum Average EIRP [dBm]					
	BW [MHz]	Waveform	Modulation	Inner 1RB	Inner Full
Middle	100	DFT-S	QPSK	22.73	22.78
	100	DFT-S	16QAM	19.13	19.75
	100	DFT-S	64QAM	17.38	17.92
	100	CP	QPSK	19.29	19.42
	200	DFT-S	QPSK	22.71	23.42
	200	DFT-S	16QAM	20.51	21.19
	200	DFT-S	64QAM	18.24	18.80
	200	CP	QPSK	22.08	21.54
NR Band n260 Module A V (Beam ID: 3)					
Maximum Average EIRP [dBm]					
	BW [MHz]	Waveform	Modulation	Inner 1RB	Inner Full
Highest	100	DFT-S	QPSK	23.96	24.21
	100	DFT-S	16QAM	21.21	21.24
	100	DFT-S	64QAM	18.71	18.99
	100	CP	QPSK	20.69	20.96
	200	DFT-S	QPSK	22.38	23.36
	200	DFT-S	16QAM	21.22	21.89
	200	DFT-S	64QAM	18.11	19.06
	200	CP	QPSK	22.29	22.42

Note : The 200MHz Bandwidth is carrier aggregation by 2CC of 100MHz.



NR Band n260 Module A H+V (Beam ID: 4+4)					
Maximum Average EIRP [dBm]					
Lowest	BW [MHz]	Waveform	Modulation	Inner 1RB	Inner Full
	100	DFT-S	QPSK	28.97	30.72
	100	DFT-S	16QAM	26.78	27.76
	100	DFT-S	64QAM	24.94	26.27
	100	CP	QPSK	26.64	27.00
	200	DFT-S	QPSK	26.38	26.21
	200	DFT-S	16QAM	23.98	23.99
	200	DFT-S	64QAM	21.19	21.40
	200	CP	QPSK	24.04	24.20
NR Band n260 Module A H+V (Beam ID: 1+1)					
Maximum Average EIRP [dBm]					
Middle	BW [MHz]	Waveform	Modulation	Inner 1RB	Inner Full
	100	DFT-S	QPSK	27.16	28.42
	100	DFT-S	16QAM	24.88	25.59
	100	DFT-S	64QAM	23.22	23.44
	100	CP	QPSK	23.67	24.37
	200	DFT-S	QPSK	26.72	26.63
	200	DFT-S	16QAM	23.61	23.69
	200	DFT-S	64QAM	21.76	21.45
200	CP	QPSK	23.57	23.87	
NR Band n260 Module A H+V (Beam ID: 3+3)					
Maximum Average EIRP [dBm]					
Highest	BW [MHz]	Waveform	Modulation	Inner 1RB	Inner Full
	100	DFT-S	QPSK	29.46	30.98
	100	DFT-S	16QAM	27.17	28.31
	100	DFT-S	64QAM	25.47	26.14
	100	CP	QPSK	27.09	27.15
	200	DFT-S	QPSK	27.08	26.98
	200	DFT-S	16QAM	24.75	24.75
	200	DFT-S	64QAM	21.81	21.60
200	CP	QPSK	25.27	25.05	

Note : The 200MHz Bandwidth is carrier aggregation by 2CC of 100MHz.

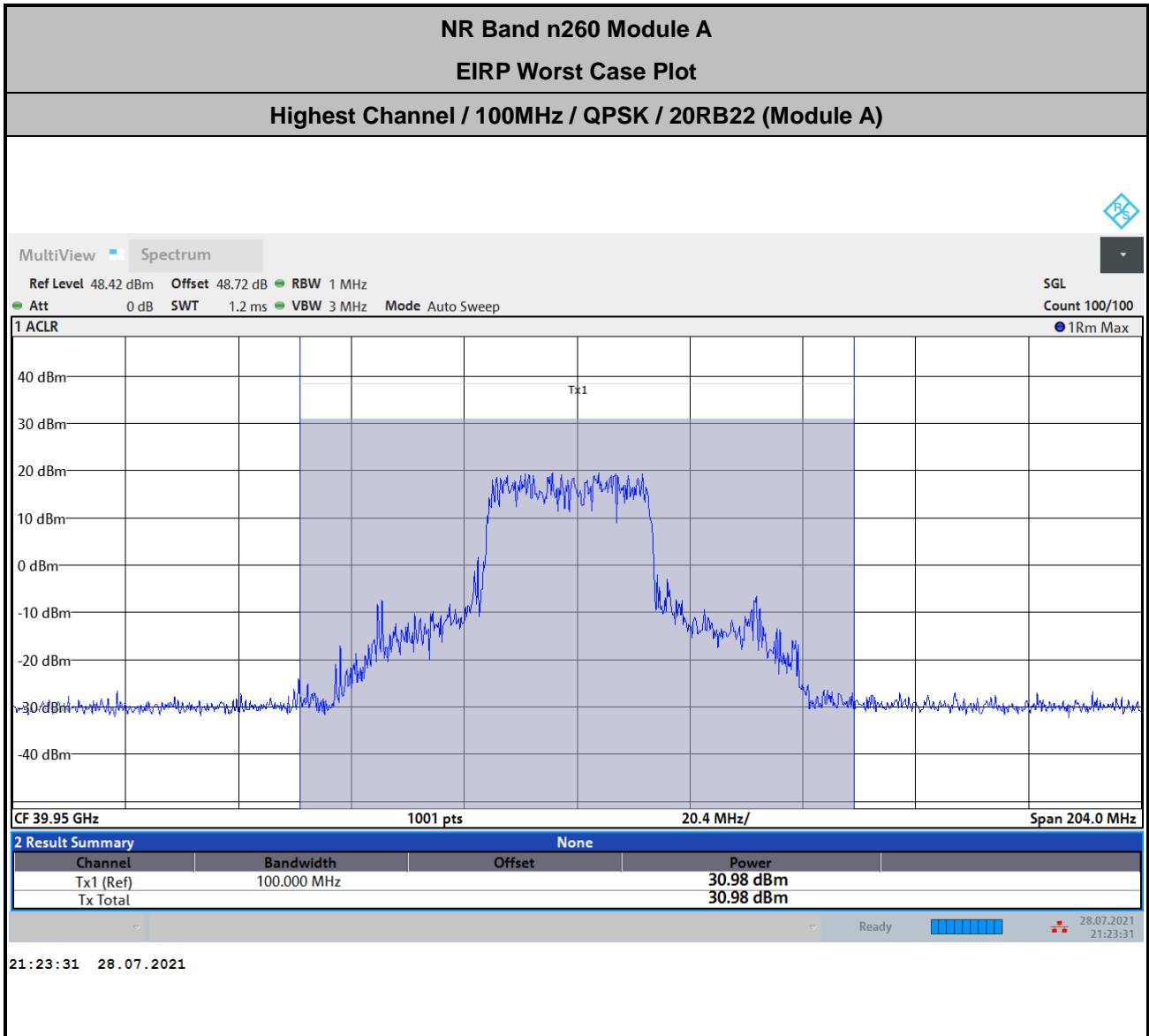

$$\text{Offset} = \text{Antenna Factor (dB/m)} + \text{Cable Loss (dB)} + 107 + 20\log(D) - 104.8$$

$$= 43.8 + 2.72 + 107 + 20\log(1) - 104.8 = 48.72 \text{ (dB)}$$



Module B

NR Band n260 Module B H (Beam ID: 4)					
Maximum Average EIRP [dBm]					
	BW [MHz]	Waveform	Modulation	Inner 1RB	Inner Full
Lowest	100	DFT-S	QPSK	23.83	23.85
	100	DFT-S	16QAM	20.87	20.69
	100	DFT-S	64QAM	18.00	18.89
	100	CP	QPSK	20.00	20.09
	200	DFT-S	QPSK	22.28	23.52
	200	DFT-S	16QAM	21.08	21.92
	200	DFT-S	64QAM	18.24	19.05
	200	CP	QPSK	21.66	22.18
NR Band n260 Module B H (Beam ID: 3)					
Maximum Average EIRP [dBm]					
	BW [MHz]	Waveform	Modulation	Inner 1RB	Inner Full
Middle	100	DFT-S	QPSK	23.40	23.41
	100	DFT-S	16QAM	20.94	20.49
	100	DFT-S	64QAM	17.97	18.24
	100	CP	QPSK	20.07	19.97
	200	DFT-S	QPSK	22.88	23.04
	200	DFT-S	16QAM	20.51	21.34
	200	DFT-S	64QAM	18.48	18.66
	200	CP	QPSK	21.66	22.03
NR Band n260 Module B H (Beam ID: 5)					
Maximum Average EIRP [dBm]					
	BW [MHz]	Waveform	Modulation	Inner 1RB	Inner Full
Highest	100	DFT-S	QPSK	21.17	21.55
	100	DFT-S	16QAM	18.59	18.84
	100	DFT-S	64QAM	15.96	16.27
	100	CP	QPSK	18.19	18.37
	200	DFT-S	QPSK	22.31	23.05
	200	DFT-S	16QAM	20.36	21.22
	200	DFT-S	64QAM	17.20	18.52
	200	CP	QPSK	21.48	21.73

Note : The 200MHz Bandwidth is carrier aggregation by 2CC of 100MHz.



NR Band n260 Module B V (Beam ID: 3)					
Maximum Average EIRP [dBm]					
	BW [MHz]	Waveform	Modulation	Inner 1RB	Inner Full
Lowest	100	DFT-S	QPSK	20.49	20.60
	100	DFT-S	16QAM	16.60	17.49
	100	DFT-S	64QAM	15.22	15.59
	100	CP	QPSK	16.77	17.07
	200	DFT-S	QPSK	22.51	23.09
	200	DFT-S	16QAM	20.94	21.76
	200	DFT-S	64QAM	18.83	19.01
	200	CP	QPSK	21.86	21.95
NR Band n260 Module B V (Beam ID: 3)					
Maximum Average EIRP [dBm]					
	BW [MHz]	Waveform	Modulation	Inner 1RB	Inner Full
Middle	100	DFT-S	QPSK	23.13	22.94
	100	DFT-S	16QAM	19.26	20.21
	100	DFT-S	64QAM	17.89	18.11
	100	CP	QPSK	19.68	19.36
	200	DFT-S	QPSK	22.45	23.50
	200	DFT-S	16QAM	21.26	21.65
	200	DFT-S	64QAM	19.05	19.22
	200	CP	QPSK	22.23	22.89
NR Band n260 Module B V (Beam ID: 2)					
Maximum Average EIRP [dBm]					
	BW [MHz]	Waveform	Modulation	Inner 1RB	Inner Full
Highest	100	DFT-S	QPSK	22.93	22.85
	100	DFT-S	16QAM	18.99	19.58
	100	DFT-S	64QAM	17.75	17.59
	100	CP	QPSK	19.22	19.31
	200	DFT-S	QPSK	22.68	23.08
	200	DFT-S	16QAM	20.93	21.29
	200	DFT-S	64QAM	18.13	19.04
	200	CP	QPSK	21.86	22.24

Note : The 200MHz Bandwidth is carrier aggregation by 2CC of 100MHz.



NR Band n260 Module B H+V (Beam ID: 4+4)					
Maximum Average EIRP [dBm]					
	BW [MHz]	Waveform	Modulation	Inner 1RB	Inner Full
Lowest	100	DFT-S	QPSK	27.93	29.21
	100	DFT-S	16QAM	24.88	26.13
	100	DFT-S	64QAM	23.24	23.88
	100	CP	QPSK	24.37	25.41
	200	DFT-S	QPSK	25.78	26.17
	200	DFT-S	16QAM	23.53	24.66
	200	DFT-S	64QAM	20.97	22.26
	200	CP	QPSK	25.19	25.37
NR Band n260 Module B H+V (Beam ID: 3+3)					
Maximum Average EIRP [dBm]					
	BW [MHz]	Waveform	Modulation	Inner 1RB	Inner Full
Middle	100	DFT-S	QPSK	27.65	28.86
	100	DFT-S	16QAM	25.06	25.77
	100	DFT-S	64QAM	23.65	24.11
	100	CP	QPSK	24.66	25.25
	200	DFT-S	QPSK	25.82	26.46
	200	DFT-S	16QAM	24.03	24.75
	200	DFT-S	64QAM	21.94	22.28
	200	CP	QPSK	25.22	26.00
NR Band n260 Module B H+V (Beam ID: 2+2)					
Maximum Average EIRP [dBm]					
	BW [MHz]	Waveform	Modulation	Inner 1RB	Inner Full
Highest	100	DFT-S	QPSK	27.16	28.72
	100	DFT-S	16QAM	24.75	25.62
	100	DFT-S	64QAM	23.43	24.25
	100	CP	QPSK	24.29	25.23
	200	DFT-S	QPSK	25.25	26.18
	200	DFT-S	16QAM	23.51	24.26
	200	DFT-S	64QAM	20.97	21.52
	200	CP	QPSK	24.47	25.44

Note : The 200MHz Bandwidth is carrier aggregation by 2CC of 100MHz.

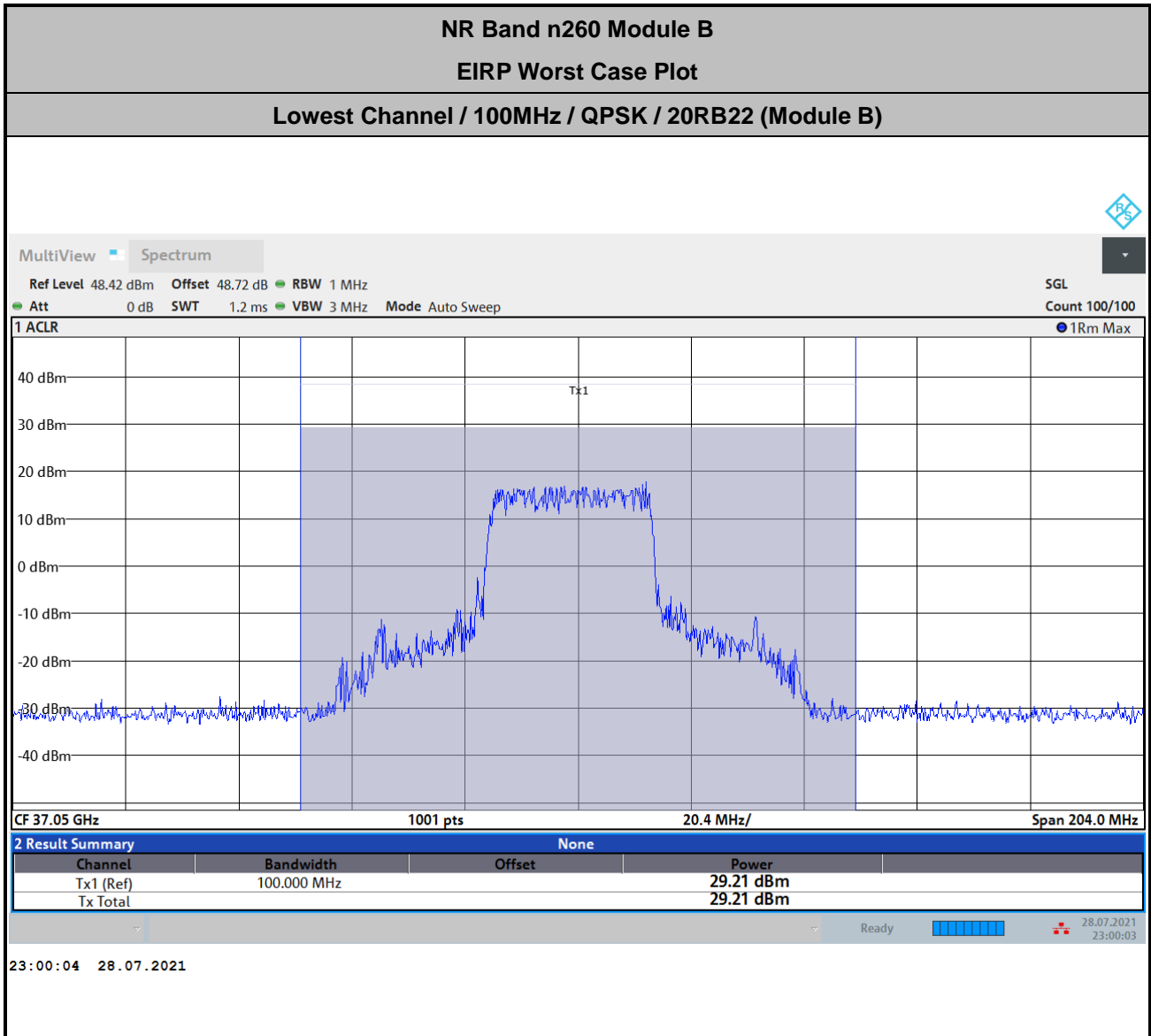

$$\text{Offset} = \text{Antenna Factor (dB/m)} + \text{Cable Loss (dB)} + 107 + 20\log(D) - 104.8$$

$$= 43.8 + 2.72 + 107 + 20\log(1) - 104.8 = 48.72 \text{ (dB)}$$



Module A

NR Band n261 Module A H (Beam ID: 4)					
Maximum Average EIRP [dBm]					
	BW [MHz]	Waveform	Modulation	Inner 1RB	Inner Full
Lowest	100	DFT-S	QPSK	26.77	26.76
	100	DFT-S	16QAM	24.48	24.00
	100	DFT-S	64QAM	21.99	21.78
	100	CP	QPSK	23.25	23.22
	200	DFT-S	QPSK	24.77	24.88
	200	DFT-S	16QAM	23.14	23.39
	200	DFT-S	64QAM	19.56	20.04
	200	CP	QPSK	23.28	23.47
NR Band n261 Module A H (Beam ID: 4)					
Maximum Average EIRP [dBm]					
	BW [MHz]	Waveform	Modulation	Inner 1RB	Inner Full
Middle	100	DFT-S	QPSK	26.26	26.08
	100	DFT-S	16QAM	23.53	23.15
	100	DFT-S	64QAM	20.51	21.05
	100	CP	QPSK	23.23	23.01
	200	DFT-S	QPSK	23.46	23.63
	200	DFT-S	16QAM	21.57	21.78
	200	DFT-S	64QAM	19.22	19.33
	200	CP	QPSK	23.30	23.38
NR Band n261 Module A H (Beam ID: 4)					
Maximum Average EIRP [dBm]					
	BW [MHz]	Waveform	Modulation	Inner 1RB	Inner Full
Highest	100	DFT-S	QPSK	27.82	27.80
	100	DFT-S	16QAM	24.91	24.69
	100	DFT-S	64QAM	22.33	22.87
	100	CP	QPSK	24.86	24.39
	200	DFT-S	QPSK	25.05	25.14
	200	DFT-S	16QAM	22.42	22.33
	200	DFT-S	64QAM	19.77	19.95
	200	CP	QPSK	22.60	22.38

Note : The 200MHz Bandwidth is carrier aggregation by 2CC of 100MHz.



NR Band n261 Module A V (Beam ID: 3)					
Maximum Average EIRP [dBm]					
	BW [MHz]	Waveform	Modulation	Inner 1RB	Inner Full
Lowest	100	DFT-S	QPSK	27.03	27.05
	100	DFT-S	16QAM	23.17	23.98
	100	DFT-S	64QAM	21.71	22.34
	100	CP	QPSK	23.52	23.81
	200	DFT-S	QPSK	24.38	24.51
	200	DFT-S	16QAM	21.93	21.91
	200	DFT-S	64QAM	20.39	20.29
	200	CP	QPSK	23.22	23.52
	NR Band n261 Module A V (Beam ID: 3)				
Maximum Average EIRP [dBm]					
	BW [MHz]	Waveform	Modulation	Inner 1RB	Inner Full
Middle	100	DFT-S	QPSK	25.79	25.63
	100	DFT-S	16QAM	21.67	22.44
	100	DFT-S	64QAM	20.98	20.81
	100	CP	QPSK	22.65	22.33
	200	DFT-S	QPSK	24.12	24.01
	200	DFT-S	16QAM	22.62	22.25
	200	DFT-S	64QAM	19.5	19.48
	200	CP	QPSK	23.08	23.22
	NR Band n261 Module A V (Beam ID: 2)				
Maximum Average EIRP [dBm]					
	BW [MHz]	Waveform	Modulation	Inner 1RB	Inner Full
Highest	100	DFT-S	QPSK	26.79	26.29
	100	DFT-S	16QAM	22.61	23.29
	100	DFT-S	64QAM	21.9	21.45
	100	CP	QPSK	23.97	22.94
	200	DFT-S	QPSK	24.38	24.14
	200	DFT-S	16QAM	22.31	22.38
	200	DFT-S	64QAM	19.58	19.59
	200	CP	QPSK	22.73	22.59

Note : The 200MHz Bandwidth is carrier aggregation by 2CC of 100MHz.



NR Band n261 Module A H+V (Beam ID: 3+3)					
Maximum Average EIRP [dBm]					
Lowest	BW [MHz]	Waveform	Modulation	Inner 1RB	Inner Full
	100	DFT-S	QPSK	30.87	31.19
	100	DFT-S	16QAM	28.10	28.42
	100	DFT-S	64QAM	26.51	26.41
	100	CP	QPSK	28.07	28.11
	200	DFT-S	QPSK	28.26	29.16
	200	DFT-S	16QAM	27.11	27.57
	200	DFT-S	64QAM	24.77	25.07
	200	CP	QPSK	27.92	28.33
NR Band n261 Module A H+V (Beam ID: 3+3)					
Maximum Average EIRP [dBm]					
Middle	BW [MHz]	Waveform	Modulation	Inner 1RB	Inner Full
	100	DFT-S	QPSK	31.18	31.93
	100	DFT-S	16QAM	28.82	29.04
	100	DFT-S	64QAM	27.19	27.49
	100	CP	QPSK	28.05	28.66
	200	DFT-S	QPSK	28.16	29.32
	200	DFT-S	16QAM	27.30	27.63
	200	DFT-S	64QAM	24.53	25.17
	200	CP	QPSK	27.64	28.50
NR Band n261 Module A H+V (Beam ID: 4+4)					
Maximum Average EIRP [dBm]					
Highest	BW [MHz]	Waveform	Modulation	Inner 1RB	Inner Full
	100	DFT-S	QPSK	30.47	31.05
	100	DFT-S	16QAM	27.99	28.97
	100	DFT-S	64QAM	27.05	27.42
	100	CP	QPSK	27.89	28.29
	200	DFT-S	QPSK	27.05	28.48
	200	DFT-S	16QAM	26.02	26.63
	200	DFT-S	64QAM	23.12	24.16
	200	CP	QPSK	26.67	27.90

Note : The 200MHz Bandwidth is carrier aggregation by 2CC of 100MHz.

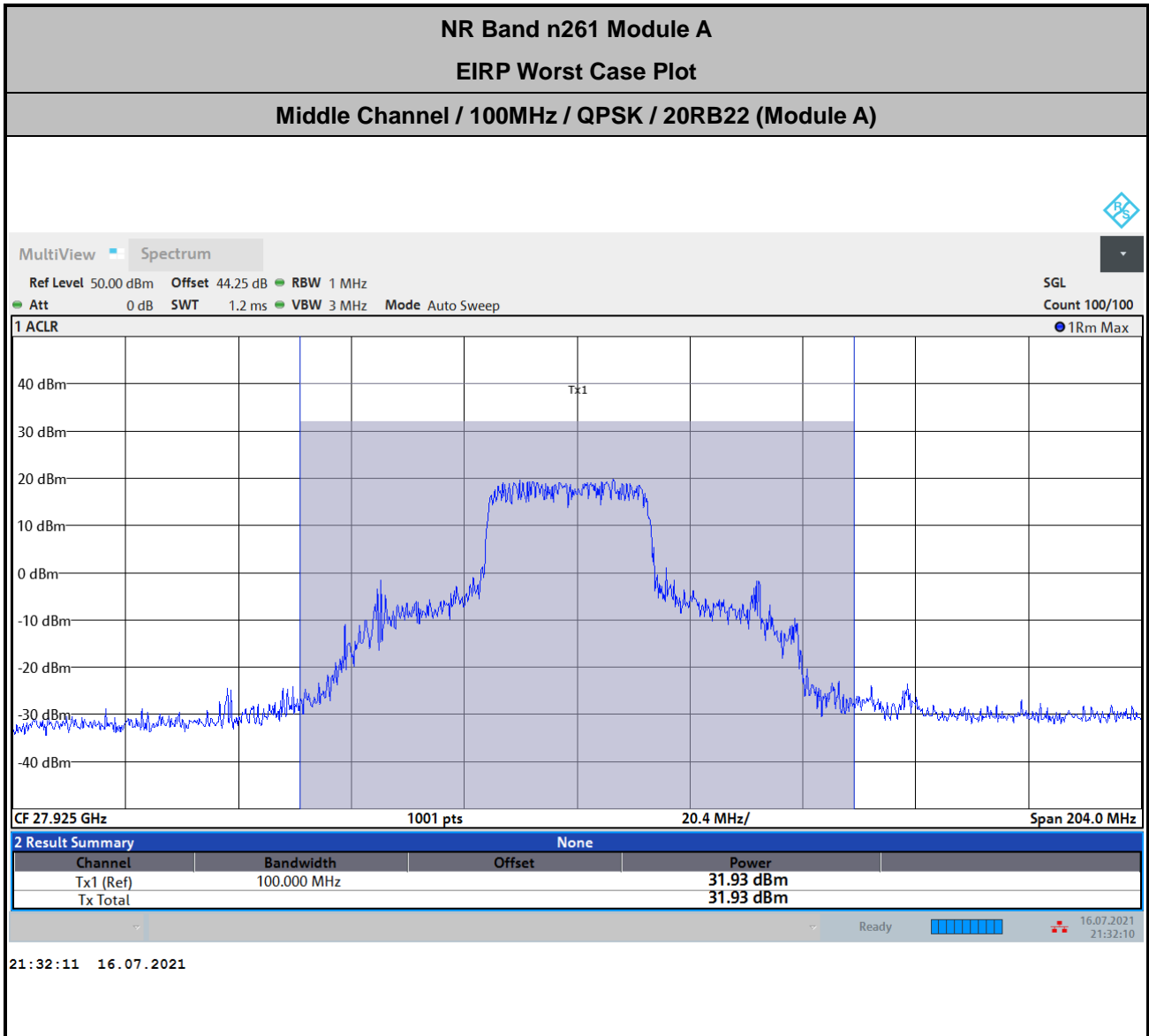

$$\text{Offset} = \text{Antenna Factor (dB/m)} + \text{Cable Loss (dB)} + 107 + 20\log(D) - 104.8$$

$$= 39.4 + 2.65 + 107 + 20\log(1) - 104.8 = 44.25 \text{ (dB)}$$



Module B

NR Band n261 Module B H (Beam ID: 4)					
Maximum Average EIRP [dBm]					
	BW [MHz]	Waveform	Modulation	Inner 1RB	Inner Full
Lowest	100	DFT-S	QPSK	26.50	26.63
	100	DFT-S	16QAM	23.92	23.61
	100	DFT-S	64QAM	21.30	21.81
	100	CP	QPSK	23.13	23.01
	200	DFT-S	QPSK	23.68	23.39
	200	DFT-S	16QAM	22.12	22.22
	200	DFT-S	64QAM	19.57	19.48
	200	CP	QPSK	22.31	22.41
NR Band n261 Module B H (Beam ID: 4)					
Maximum Average EIRP [dBm]					
	BW [MHz]	Waveform	Modulation	Inner 1RB	Inner Full
Middle	100	DFT-S	QPSK	26.55	26.18
	100	DFT-S	16QAM	23.59	23.53
	100	DFT-S	64QAM	21.18	21.52
	100	CP	QPSK	23.53	23.15
	200	DFT-S	QPSK	23.83	23.98
	200	DFT-S	16QAM	21.22	21.23
	200	DFT-S	64QAM	19.57	19.63
	200	CP	QPSK	21.53	21.57
NR Band n261 Module B H (Beam ID: 2)					
Maximum Average EIRP [dBm]					
	BW [MHz]	Waveform	Modulation	Inner 1RB	Inner Full
Highest	100	DFT-S	QPSK	24.43	27.63
	100	DFT-S	16QAM	24.75	24.91
	100	DFT-S	64QAM	22.86	22.83
	100	CP	QPSK	24.72	24.40
	200	DFT-S	QPSK	24.44	24.75
	200	DFT-S	16QAM	22.52	22.22
	200	DFT-S	64QAM	19.78	19.42
	200	CP	QPSK	22.64	22.22

Note : The 200MHz Bandwidth is carrier aggregation by 2CC of 100MHz.



NR Band n261 Module B V (Beam ID: 3)					
Maximum Average EIRP [dBm]					
Lowest	BW [MHz]	Waveform	Modulation	Inner 1RB	Inner Full
	100	DFT-S	QPSK	26.89	26.93
	100	DFT-S	16QAM	23.07	23.97
	100	DFT-S	64QAM	21.54	22.18
	100	CP	QPSK	23.91	23.77
	200	DFT-S	QPSK	23.37	23.48
	200	DFT-S	16QAM	22.38	22.01
	200	DFT-S	64QAM	19.13	19.04
	200	CP	QPSK	22.89	22.71
NR Band n261 Module B V (Beam ID: 3)					
Maximum Average EIRP [dBm]					
Middle	BW [MHz]	Waveform	Modulation	Inner 1RB	Inner Full
	100	DFT-S	QPSK	26.47	26.24
	100	DFT-S	16QAM	22.45	23.23
	100	DFT-S	64QAM	21.59	21.57
	100	CP	QPSK	23.27	23.14
	200	DFT-S	QPSK	24.71	24.74
	200	DFT-S	16QAM	22.68	22.26
	200	DFT-S	64QAM	19.91	19.90
200	CP	QPSK	22.63	22.38	
NR Band n261 Module B V (Beam ID: 3)					
Maximum Average EIRP [dBm]					
Highest	BW [MHz]	Waveform	Modulation	Inner 1RB	Inner Full
	100	DFT-S	QPSK	25.97	25.93
	100	DFT-S	16QAM	22.11	23.02
	100	DFT-S	64QAM	21.11	21.31
	100	CP	QPSK	23.09	23.05
	200	DFT-S	QPSK	23.94	24.11
	200	DFT-S	16QAM	22.60	22.69
	200	DFT-S	64QAM	19.54	19.57
200	CP	QPSK	22.89	23.10	

Note : The 200MHz Bandwidth is carrier aggregation by 2CC of 100MHz.



NR Band n261 Module B H+V (Beam ID: 3+3)					
Maximum Average EIRP [dBm]					
Lowest	BW [MHz]	Waveform	Modulation	Inner 1RB	Inner Full
	100	DFT-S	QPSK	30.87	31.23
	100	DFT-S	16QAM	28.79	29.24
	100	DFT-S	64QAM	26.38	26.20
	100	CP	QPSK	28.45	28.52
	200	DFT-S	QPSK	27.45	27.49
	200	DFT-S	16QAM	24.64	24.59
	200	DFT-S	64QAM	21.46	21.64
	200	CP	QPSK	24.80	24.28
NR Band n261 Module B H+V (Beam ID: 3+3)					
Maximum Average EIRP [dBm]					
Middle	BW [MHz]	Waveform	Modulation	Inner 1RB	Inner Full
	100	DFT-S	QPSK	30.60	31.54
	100	DFT-S	16QAM	28.25	29.29
	100	DFT-S	64QAM	26.16	26.50
	100	CP	QPSK	27.79	28.55
	200	DFT-S	QPSK	27.16	27.16
	200	DFT-S	16QAM	24.20	24.43
	200	DFT-S	64QAM	21.06	22.40
200	CP	QPSK	24.40	25.59	
NR Band n261 Module B H+V (Beam ID: 2+2)					
Maximum Average EIRP [dBm]					
Highest	BW [MHz]	Waveform	Modulation	Inner 1RB	Inner Full
	100	DFT-S	QPSK	30.83	31.07
	100	DFT-S	16QAM	28.93	29.18
	100	DFT-S	64QAM	26.16	26.34
	100	CP	QPSK	28.08	28.38
	200	DFT-S	QPSK	27.47	27.50
	200	DFT-S	16QAM	25.21	25.49
	200	DFT-S	64QAM	21.94	21.95
200	CP	QPSK	25.52	25.91	

Note : The 200MHz Bandwidth is carrier aggregation by 2CC of 100MHz.

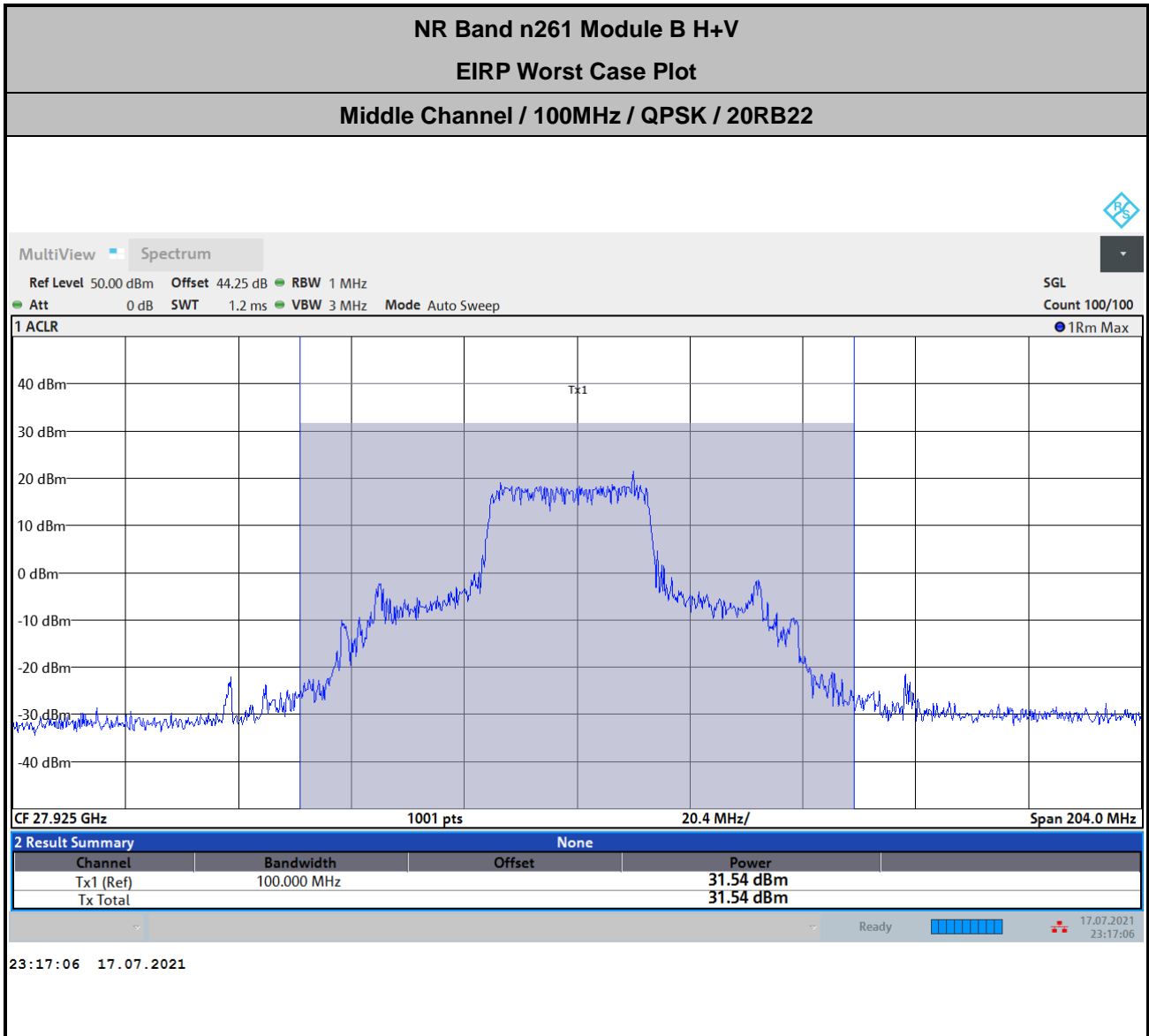

$$\text{Offset} = \text{Antenna Factor (dB/m)} + \text{Cable Loss (dB)} + 107 + 20\log(D) - 104.8$$

$$= 39.4 + 2.65 + 107 + 20\log(1) - 104.8 = 44.25 \text{ (dB)}$$



NR Band n258A Module A Beam H

Occupied Bandwidth

Mode	DFT-s-OFDM Module A NR Band n258A : 99%OBW(MHz)					
BW	100MHz			200MHz		
Mod.	QPSK	16QAM	64QAM	QPSK	16QAM	64QAM
Lowest CH	91.63	91.96	91.52	-	-	-
Middle CH	91.65	91.71	91.43	190.68	190.59	190.29
Highest CH	91.46	91.59	91.45	-	-	-

Mode	CP-OFDM Module A NR Band n258A : 99%OBW(MHz)	
BW	100MHz	200MHz
Mod.	QPSK	QPSK
Lowest CH	94.46	-
Middle CH	94.46	193.27
Highest CH	94.54	-



DFT-s-OFDM Module A

NR Band n258A

Lowest Channel / 100MHz / QPSK

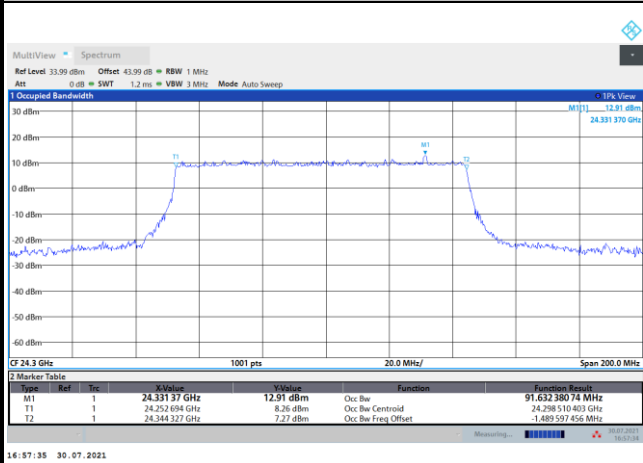

Lowest Channel / 100MHz / 16QAM

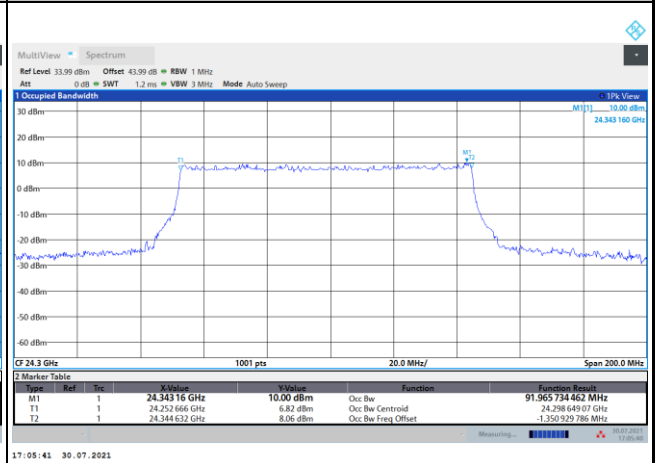

Middle Channel / 100MHz / QPSK

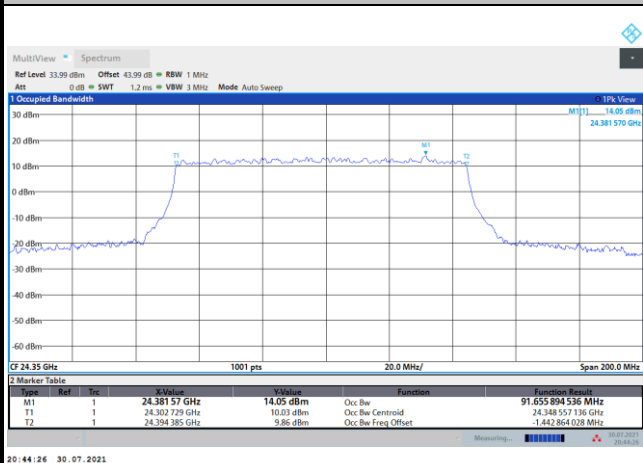

Middle Channel / 100MHz / 16QAM

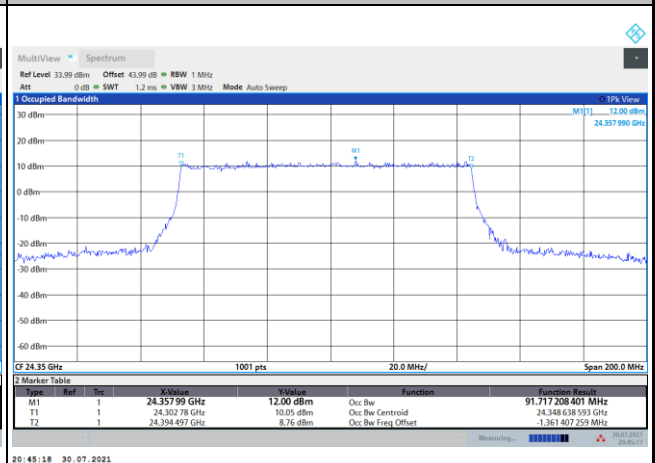

Highest Channel / 100MHz / QPSK

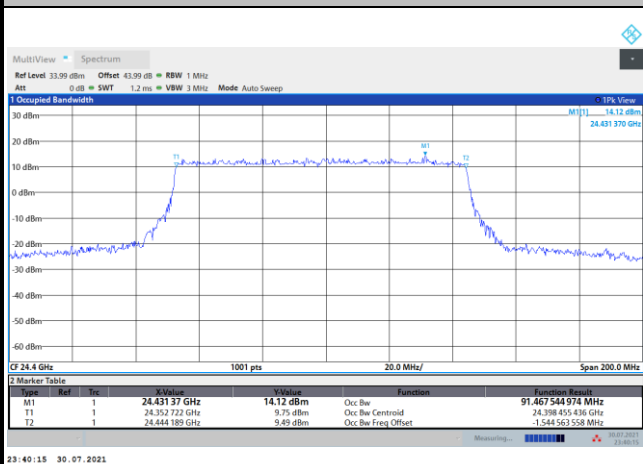

Highest Channel / 100MHz / 16QAM

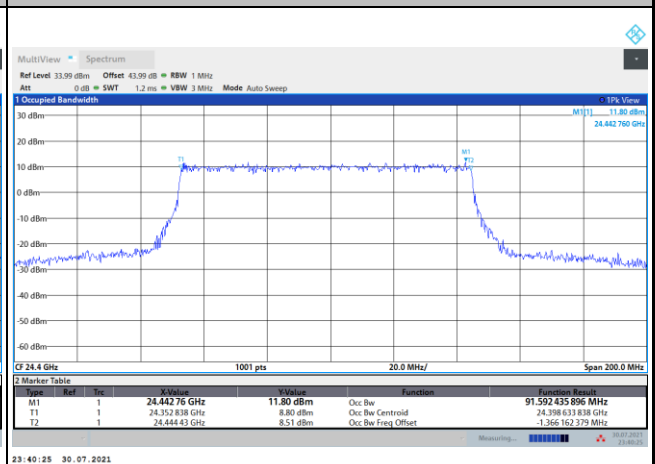



DFT-s-OFDM Module A

NR Band n258A

Lowest Channel / 100MHz / 64QAM

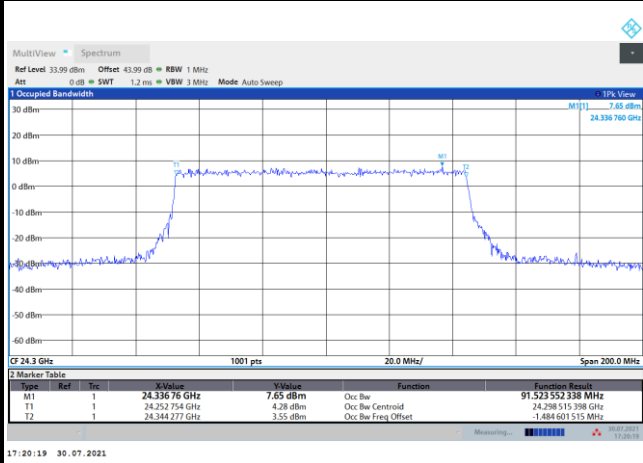

intentionally blank

Middle Channel / 100MHz / 64QAM

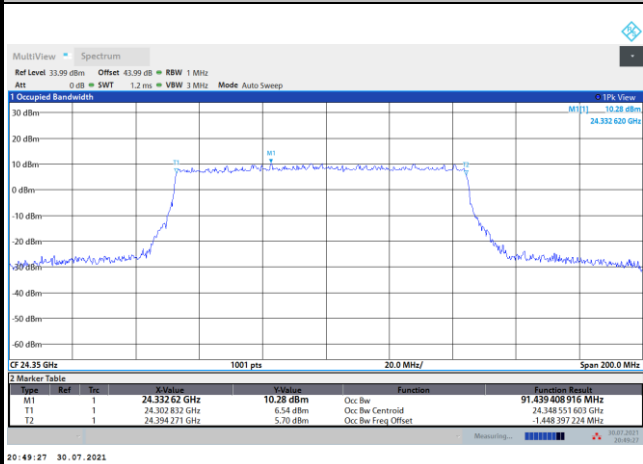

Middle Channel / 200MHz / QPSK

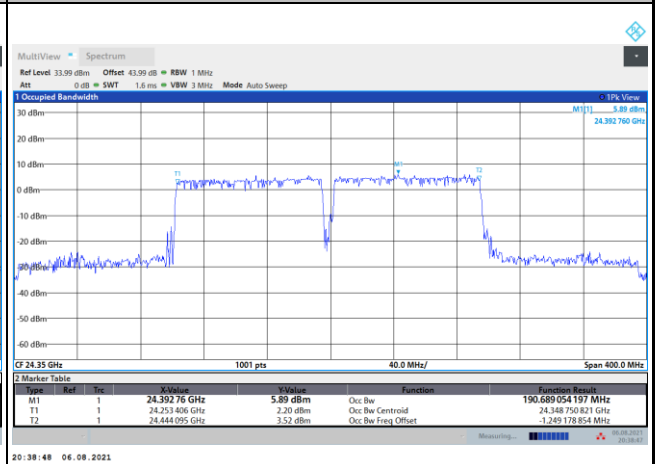

Highest Channel / 100MHz / 64QAM

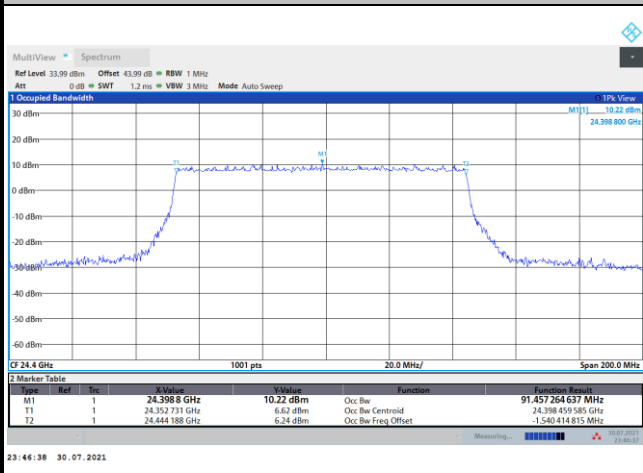

intentionally blank



DFT-s-OFDM Module A

NR Band n258A

Middle Channel / 200MHz / 16QAM

Middle Channel / 200MHz / 64QAM

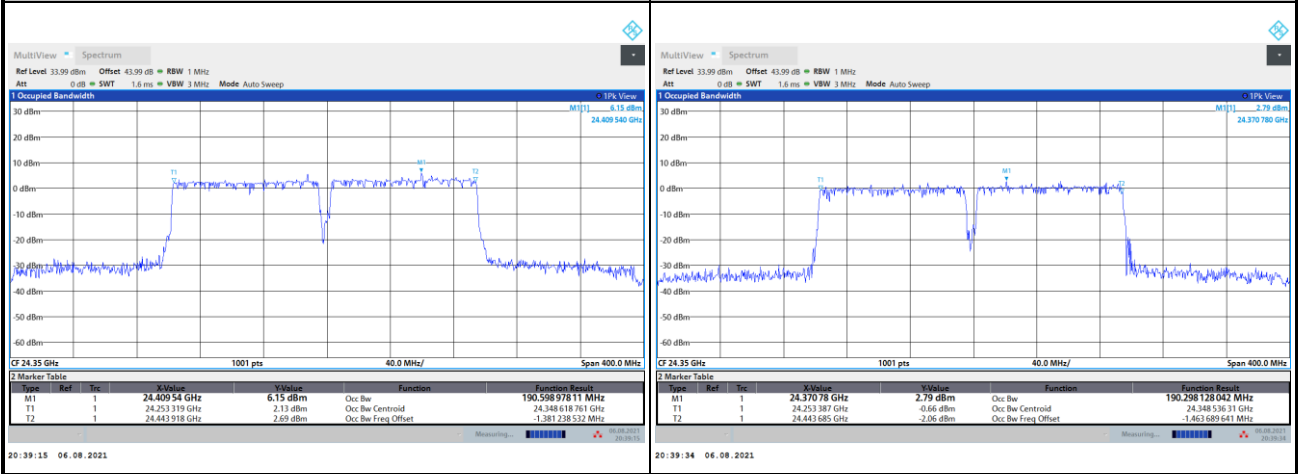



CP-OFDM Module A

NR Band n258A

Lowest Channel / 100MHz / QPSK

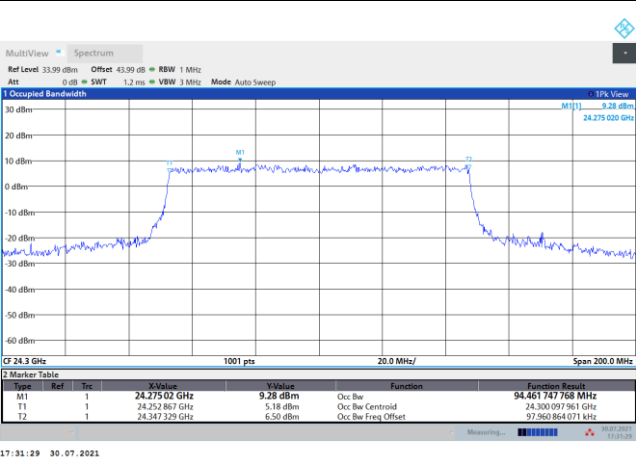

intentionally blank

Middle Channel / 100MHz / QPSK

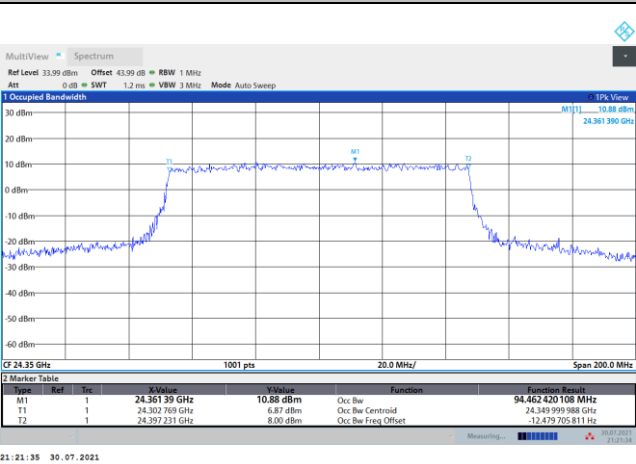

Middle Channel / 200MHz / QPSK

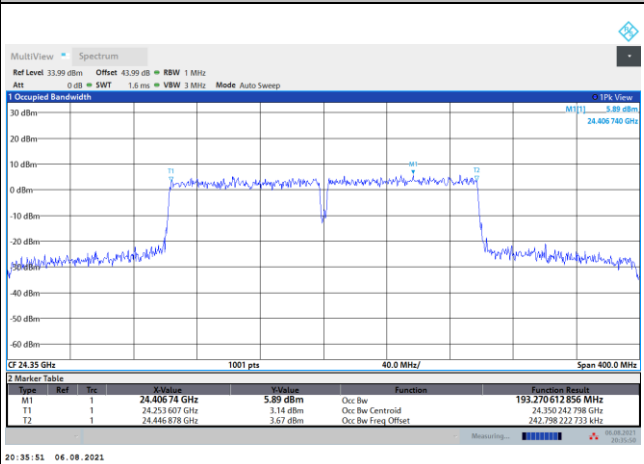

Highest Channel / 100MHz / QPSK

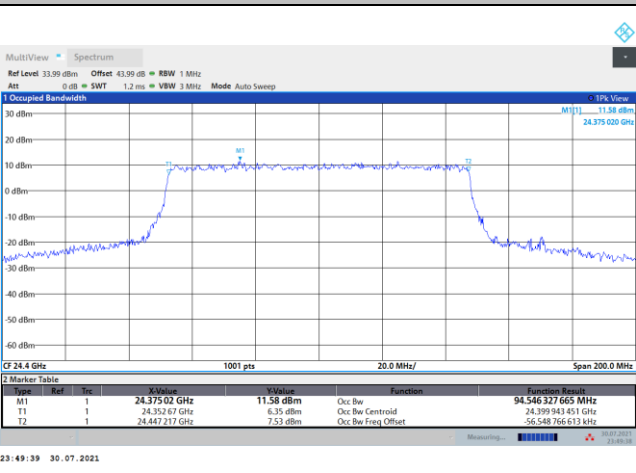

intentionally blank



Radiated Out of Band Emissions

Mode			DFT-s-OFDM Module A NR Band n258A : BE (dBm) 1 RB		
BW			100MHz		
Limit (dBm)			QPSK	16QAM	64QAM
Low CH	0~10%OB	≤ -5	-15.77	-14.31	-18.93
	>10%OB	≤ -13	-40.16	-40.94	-41.40
High CH	0~10%OB	≤ -5	-12.48	-14.00	-16.62
	>10%OB	≤ -13	-37.51	-39.04	-40.23
Result			Compliance		

Mode			CP-OFDM Module A NR Band n258A : BE (dBm) 1 RB		
BW			100MHz		
Limit (dBm)			QPSK		
Low CH	0~10%OB	≤ -5	-16.10		
	>10%OB	≤ -13	-40.76		
High CH	0~10%OB	≤ -5	-15.85		
	>10%OB	≤ -13	-39.41		
Result			Compliance		

Mode			DFT-s-OFDM Module A NR Band n258A : BE (dBm) Full RB		
BW			100MHz		
Limit (dBm)			QPSK	16QAM	64QAM
Low CH	0~10%OB	≤ -5	-22.00	-24.87	-28.85
	>10%OB	≤ -13	-29.66	-31.96	-35.84
High CH	0~10%OB	≤ -5	-25.11	-27.07	-29.63
	>10%OB	≤ -13	-29.35	-31.29	-34.76
Result			Compliance		

Mode			CP-OFDM Module A NR Band n258A : BE (dBm) Full RB		
BW			100MHz		
Limit (dBm)			QPSK		
Low CH	0~10%OB	≤ -5	-25.41		
	>10%OB	≤ -13	-30.32		
High CH	0~10%OB	≤ -5	-23.31		
	>10%OB	≤ -13	-29.54		
Result			Compliance		



DFT-s-OFDM Module A

NR Band n258A / 100MHz / QPSK

Lowest Band Edge / 1 RB

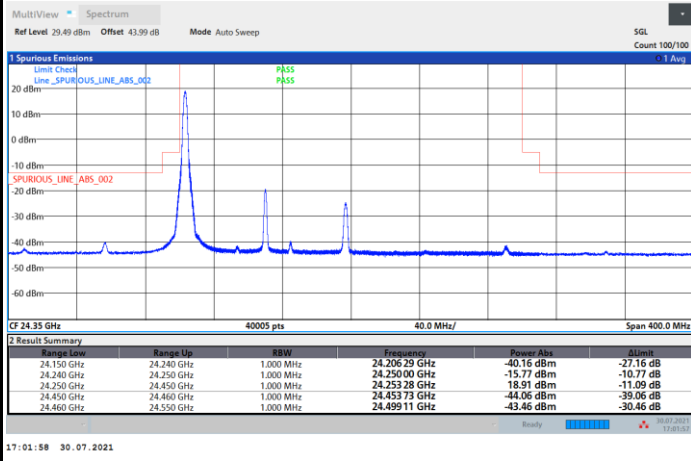

Highest Band Edge / 1 RB

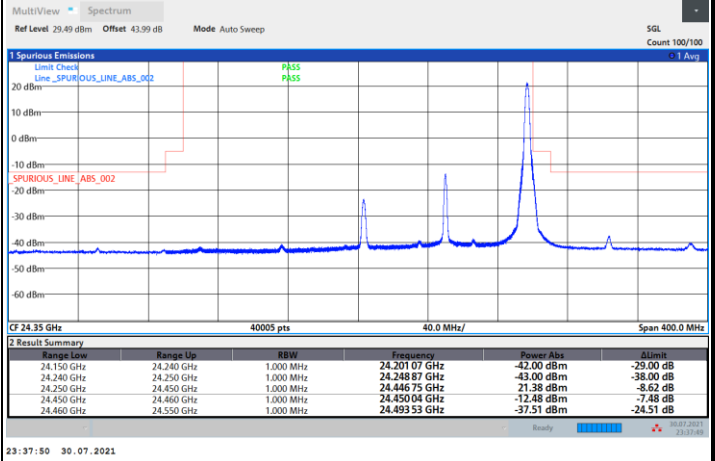

NR Band n258A / 100MHz / 16QAM

Lowest Band Edge / 1 RB

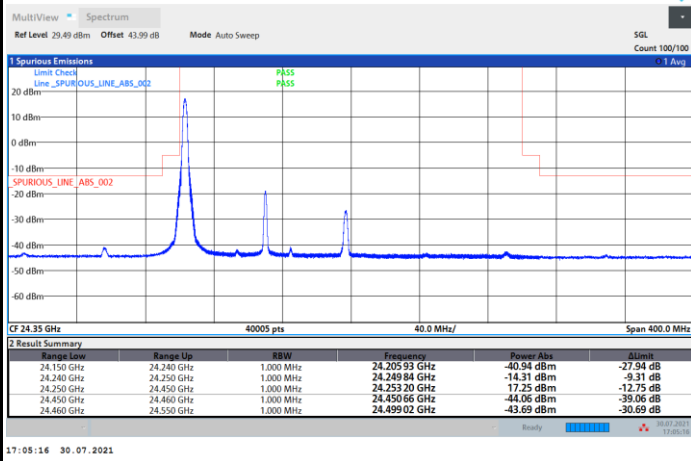

Highest Band Edge / 1 RB

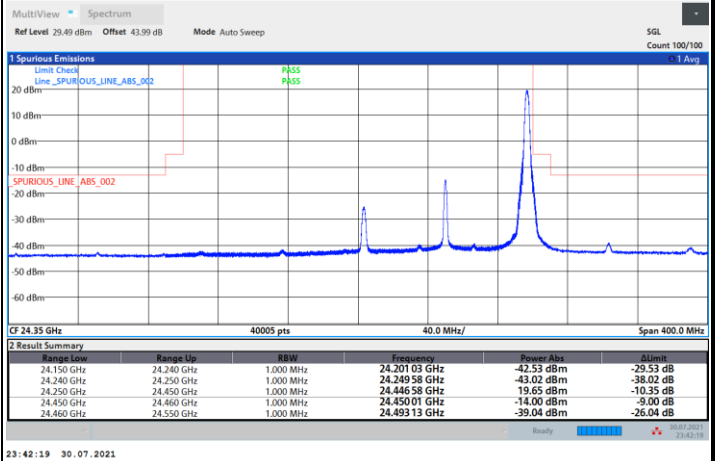



DFT-s-OFDM Module A

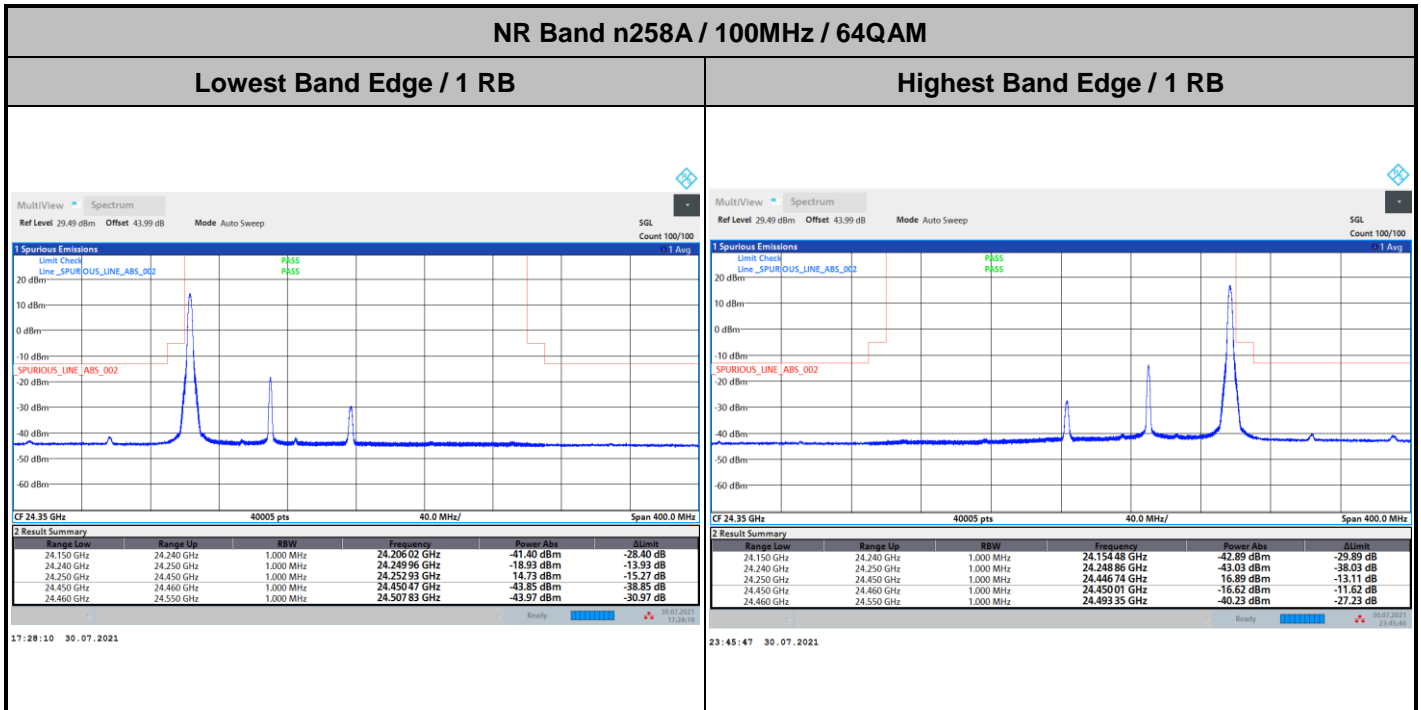

CP-OFDM Module A

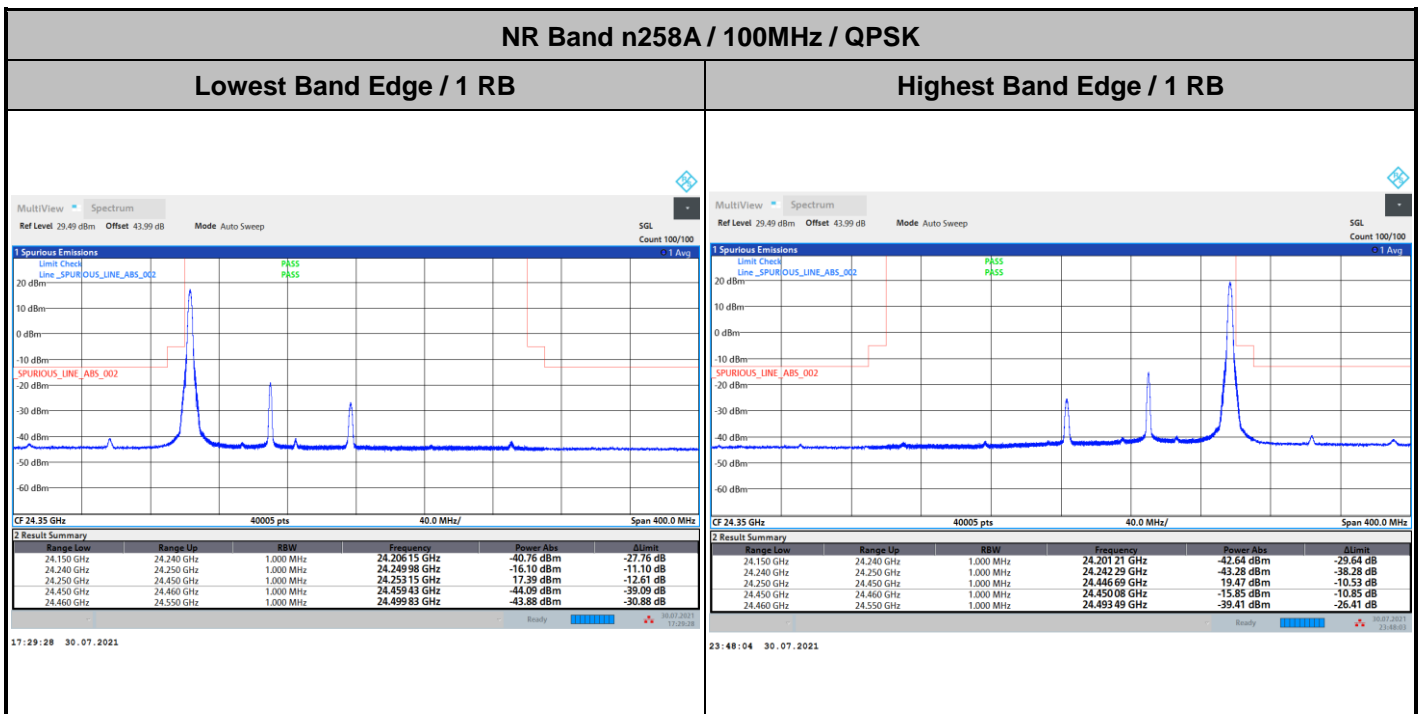



DFT-s-OFDM Module A

NR Band n258A / 100MHz / QPSK

Lowest Band Edge / Full RB

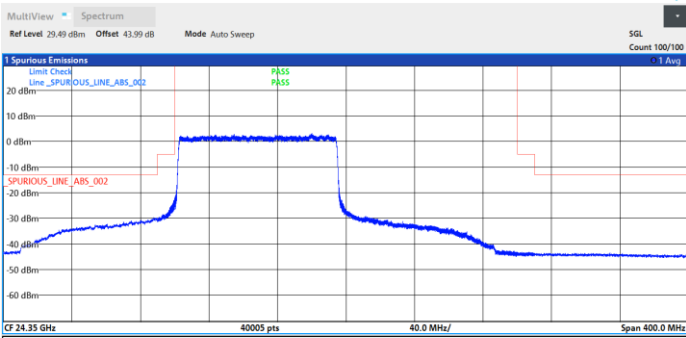

Range Low	Range Up	RBW	Frequency	Power Abs	Limit
24.150 GHz	24.240 GHz	1.000 MHz	24.23759 GHz	-29.66 dBm	-16.66 dB
24.240 GHz	24.250 GHz	1.000 MHz	24.24998 GHz	-22.00 dBm	-17.00 dB
24.250 GHz	24.450 GHz	1.000 MHz	24.32997 GHz	3.26 dBm	-26.74 dB
24.450 GHz	24.460 GHz	1.000 MHz	24.45671 GHz	-43.27 dBm	-38.27 dB
24.460 GHz	24.550 GHz	1.000 MHz	24.50415 GHz	-43.55 dBm	-30.55 dB

17:01:00 30.07.2021

Highest Band Edge / Full RB

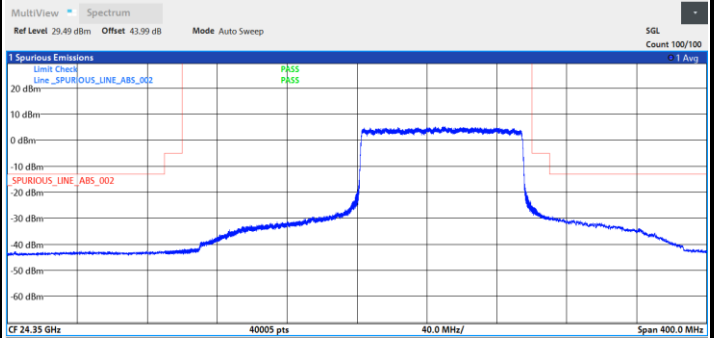

Range Low	Range Up	RBW	Frequency	Power Abs	Limit
24.150 GHz	24.240 GHz	1.000 MHz	24.23759 GHz	-42.54 dBm	-29.54 dB
24.240 GHz	24.250 GHz	1.000 MHz	24.24861 GHz	-42.03 dBm	-37.03 dB
24.250 GHz	24.450 GHz	1.000 MHz	24.39932 GHz	5.35 dBm	-24.65 dB
24.450 GHz	24.460 GHz	1.000 MHz	24.45005 GHz	-25.11 dBm	-20.11 dB
24.460 GHz	24.550 GHz	1.000 MHz	24.46160 GHz	-29.35 dBm	-16.35 dB

23:40:07 30.07.2021

NR Band n258A / 100MHz / 16QAM

Lowest Band Edge / Full RB

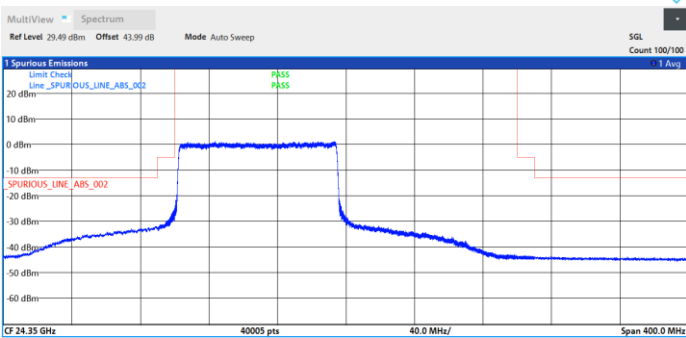

Range Low	Range Up	RBW	Frequency	Power Abs	Limit
24.150 GHz	24.240 GHz	1.000 MHz	24.23899 GHz	-31.96 dBm	-18.96 dB
24.240 GHz	24.250 GHz	1.000 MHz	24.24978 GHz	-24.87 dBm	-19.87 dB
24.250 GHz	24.450 GHz	1.000 MHz	24.27365 GHz	1.32 dBm	-28.68 dB
24.450 GHz	24.460 GHz	1.000 MHz	24.45510 GHz	-43.39 dBm	-38.39 dB
24.460 GHz	24.550 GHz	1.000 MHz	24.46969 GHz	-43.63 dBm	-30.63 dB

17:07:14 30.07.2021

Highest Band Edge / Full RB

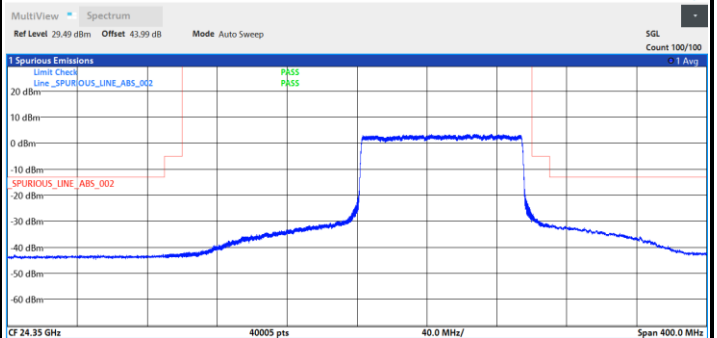

Range Low	Range Up	RBW	Frequency	Power Abs	Limit
24.150 GHz	24.240 GHz	1.000 MHz	24.23890 GHz	-42.61 dBm	-29.61 dB
24.240 GHz	24.250 GHz	1.000 MHz	24.24950 GHz	-42.32 dBm	-37.32 dB
24.250 GHz	24.450 GHz	1.000 MHz	24.42665 GHz	3.47 dBm	-26.53 dB
24.450 GHz	24.460 GHz	1.000 MHz	24.45077 GHz	-27.07 dBm	-22.07 dB
24.460 GHz	24.550 GHz	1.000 MHz	24.46200 GHz	-31.29 dBm	-18.29 dB

23:41:41 30.07.2021



DFT-s-OFDM Module A

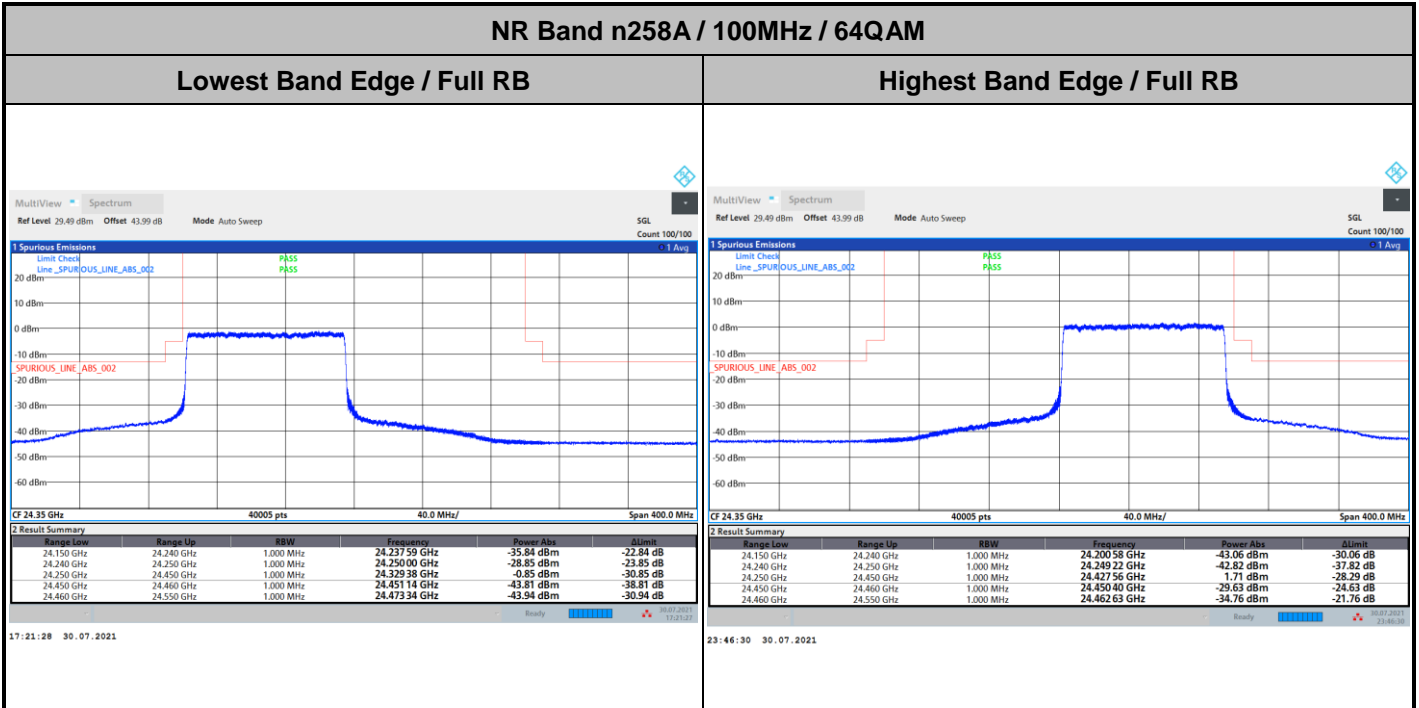

CP-OFDM Module A

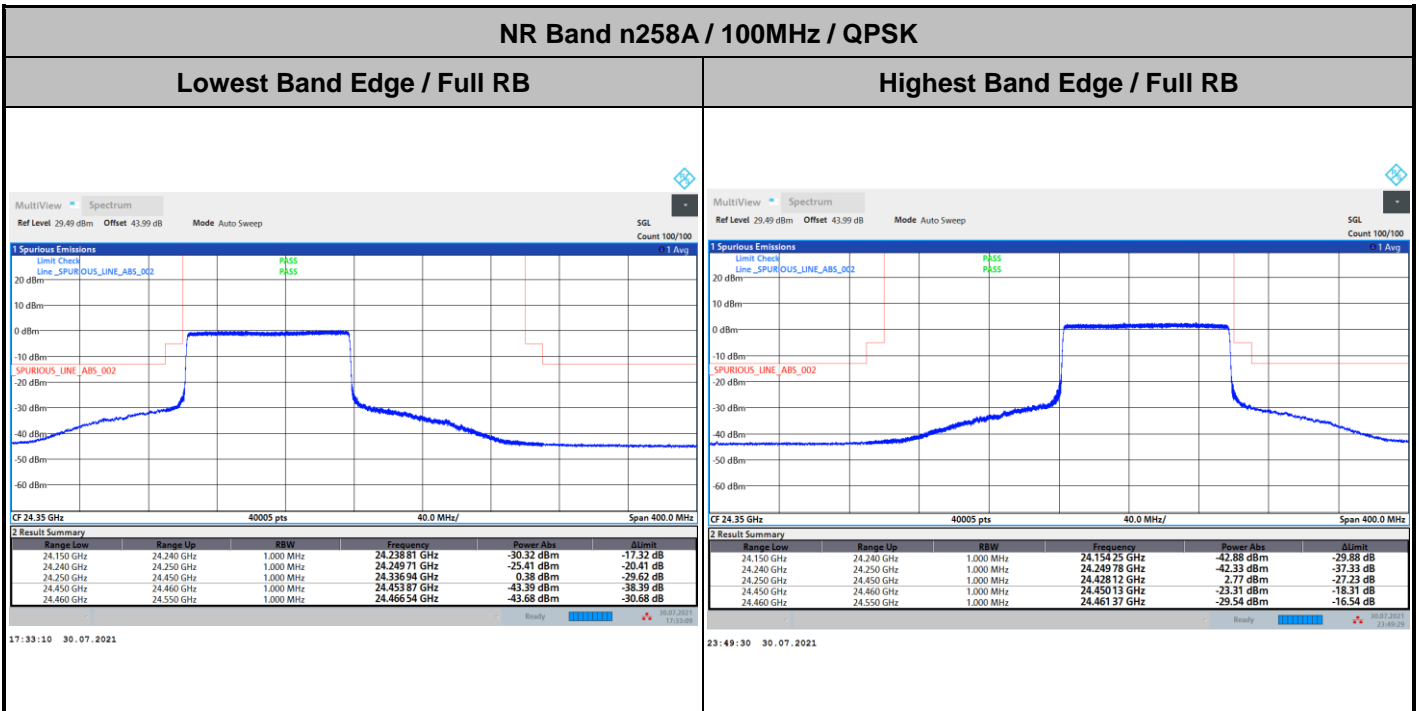

Mode			DFT-s-OFDM Module A NR Band n258A : BE (dBm) 1 RB		
BW			200MHz		
Limit (dBm)			QPSK	16QAM	64QAM
Low Edge	0~10%OB	≤ -5	-12.13	-16.82	-16.43
	>10%OB	≤ -13	-14.04	-16.34	-19.28
High Edge	0~10%OB	≤ -5	-14.84	-13.47	-19.57
	>10%OB	≤ -13	-16.04	-18.79	-22.89
Result			Compliance		

Mode			CP-OFDM Module A NR Band n258A : BE (dBm) 1 RB		
BW			200MHz		
Limit (dBm)			QPSK		
Low Edge	0~10%OB	≤ -5	-13.00		
	>10%OB	≤ -13	-14.29		
High Edge	0~10%OB	≤ -5	-14.71		
	>10%OB	≤ -13	-14.04		
Result			Compliance		

Mode			DFT-s-OFDM Module A NR Band n258A : BE (dBm) Full RB		
BW			200MHz		
Limit (dBm)			QPSK	16QAM	64QAM
Low Edge	0~10%OB	≤ -5	-21.65	-24.21	-28.03
	>10%OB	≤ -13	-27.02	-28.83	-32.00
High Edge	0~10%OB	≤ -5	-25.14	-28.60	-29.47
	>10%OB	≤ -13	-27.19	-29.48	-31.94
Result			Compliance		

Mode			CP-OFDM Module A NR Band n258A : BE (dBm) Full RB		
BW			200MHz		
Limit (dBm)			QPSK		
Low Edge	0~10%OB	≤ -5	-20.30		
	>10%OB	≤ -13	-23.34		
High Edge	0~10%OB	≤ -5	-20.50		
	>10%OB	≤ -13	-23.90		
Result			Compliance		



DFT-s-OFDM Module A

NR Band n258A / 200MHz / QPSK

Lowest Band Edge / 1 RB

Highest Band Edge / 1 RB

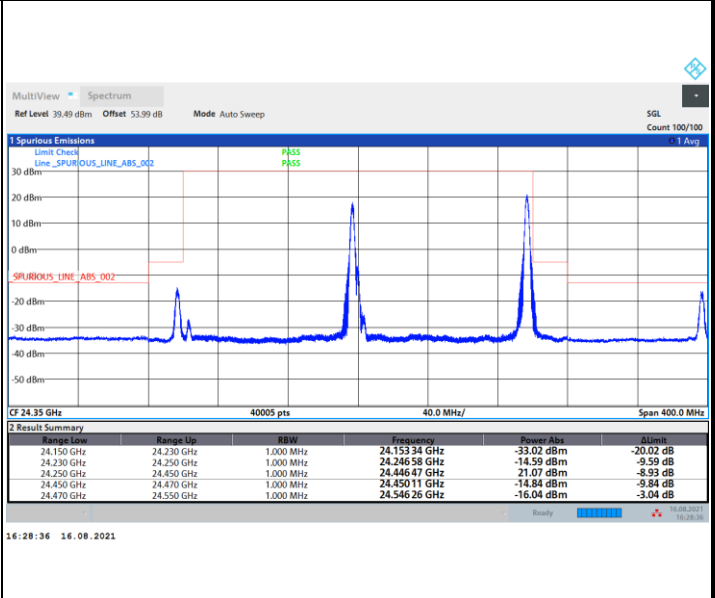
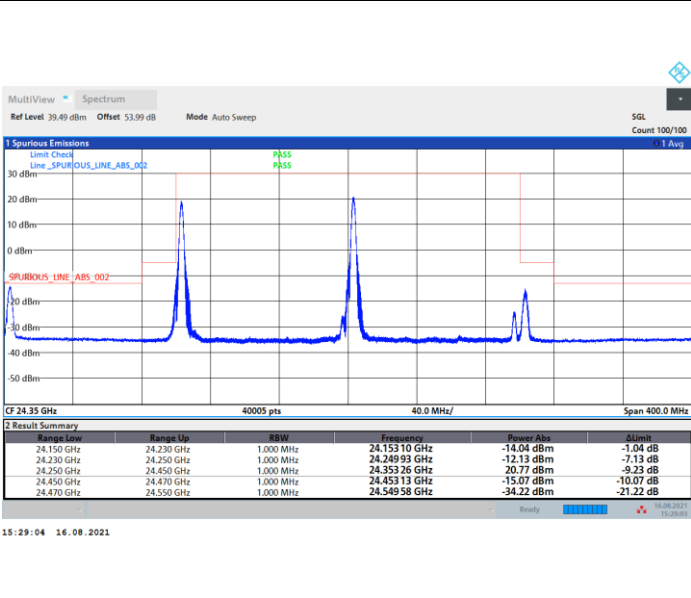

NR Band n258A / 200MHz / 16QAM

Lowest Band Edge / 1 RB

Highest Band Edge / 1 RB

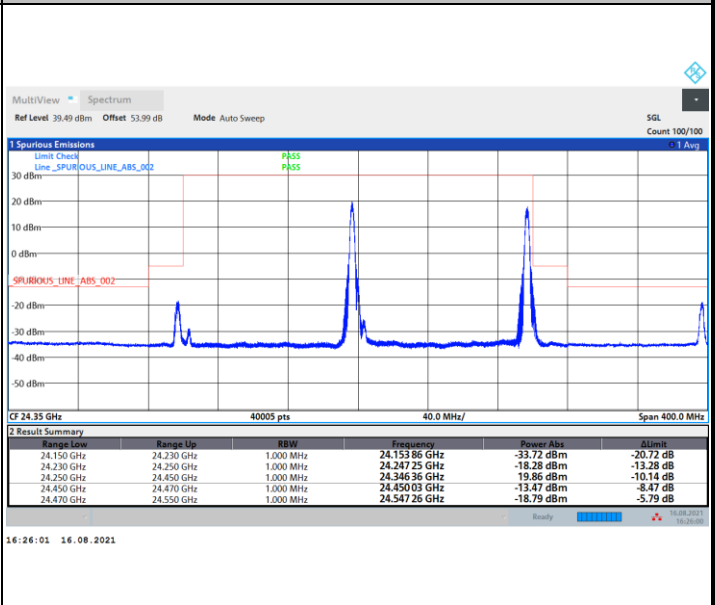
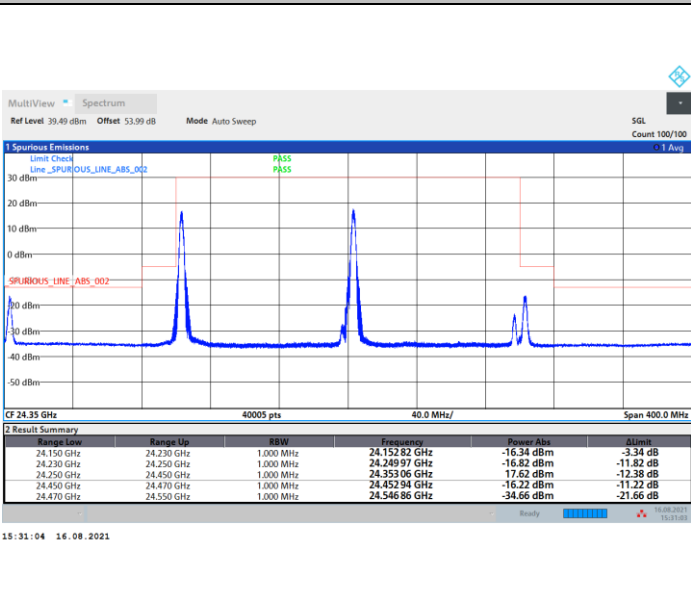



DFT-s-OFDM Module A

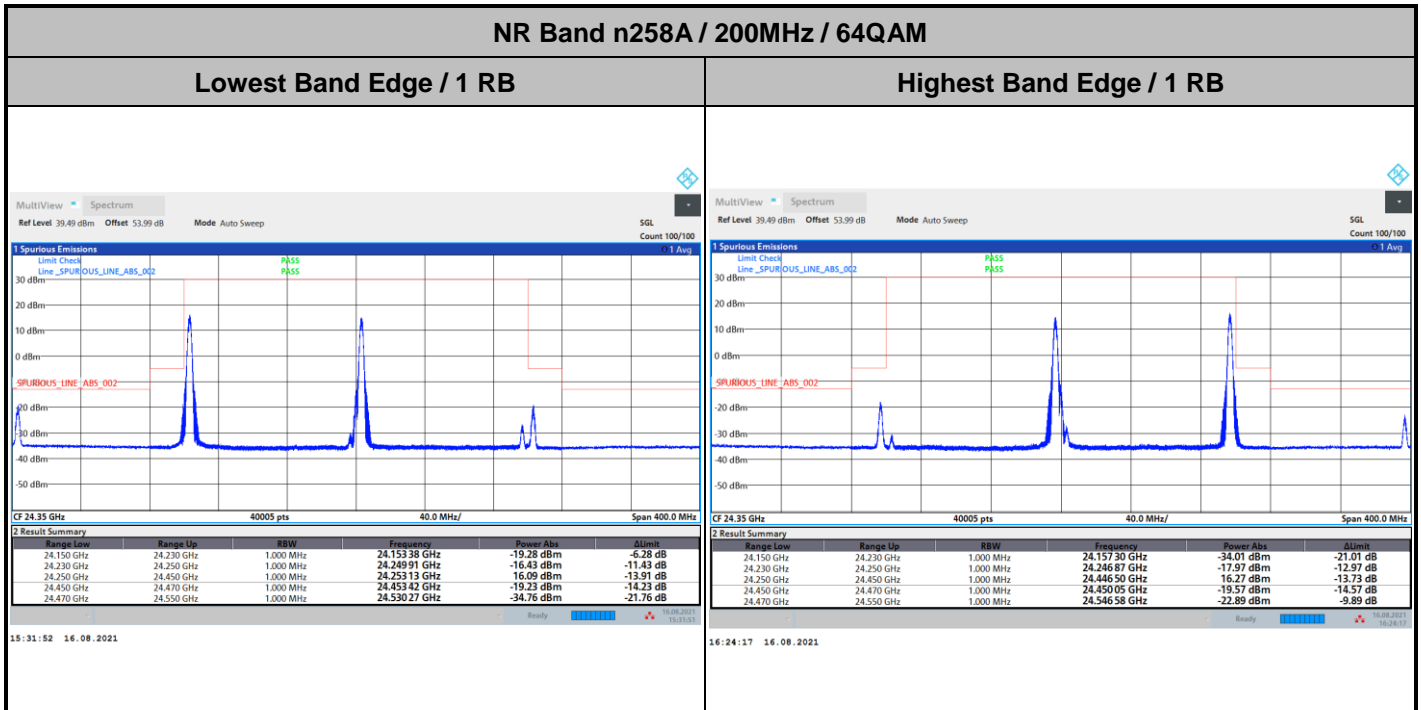

CP-OFDM Module A

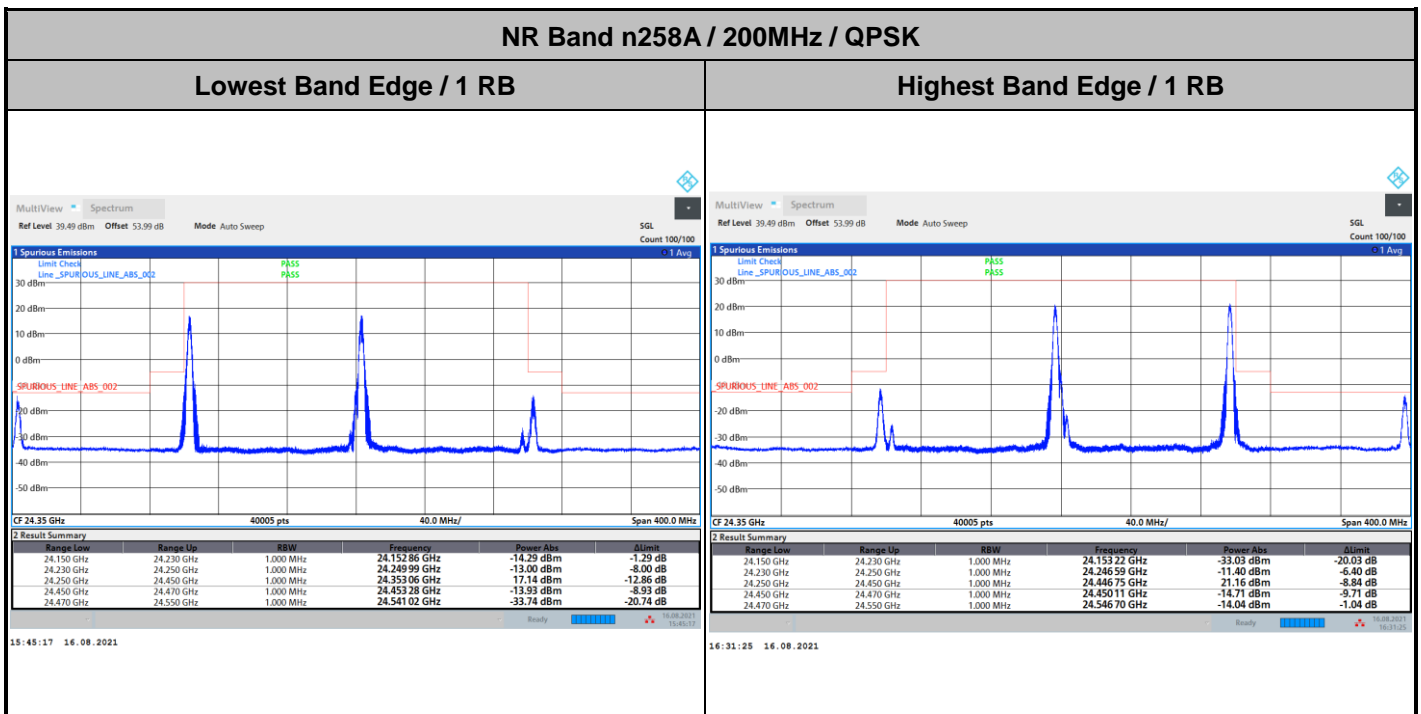



DFT-s-OFDM Module A

NR Band n258A / 200MHz / QPSK

Lowest Band Edge / Full RB

Highest Band Edge / Full RB

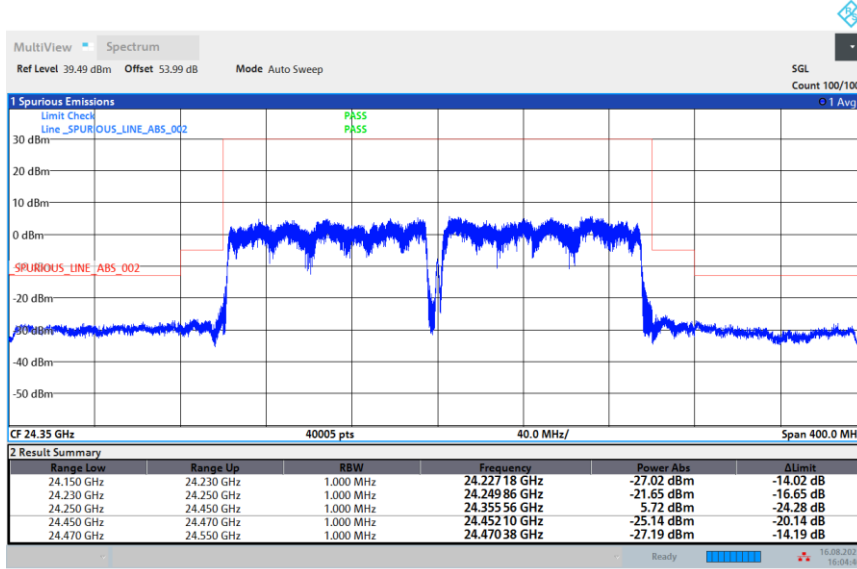

NR Band n258A / 200MHz / 16QAM

Lowest Band Edge / Full RB

Highest Band Edge / Full RB

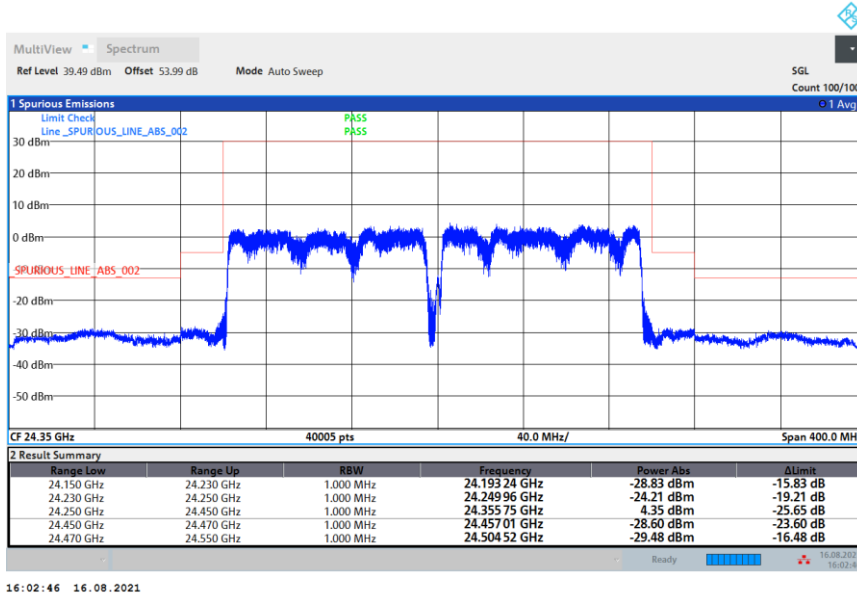



DFT-s-OFDM Module A

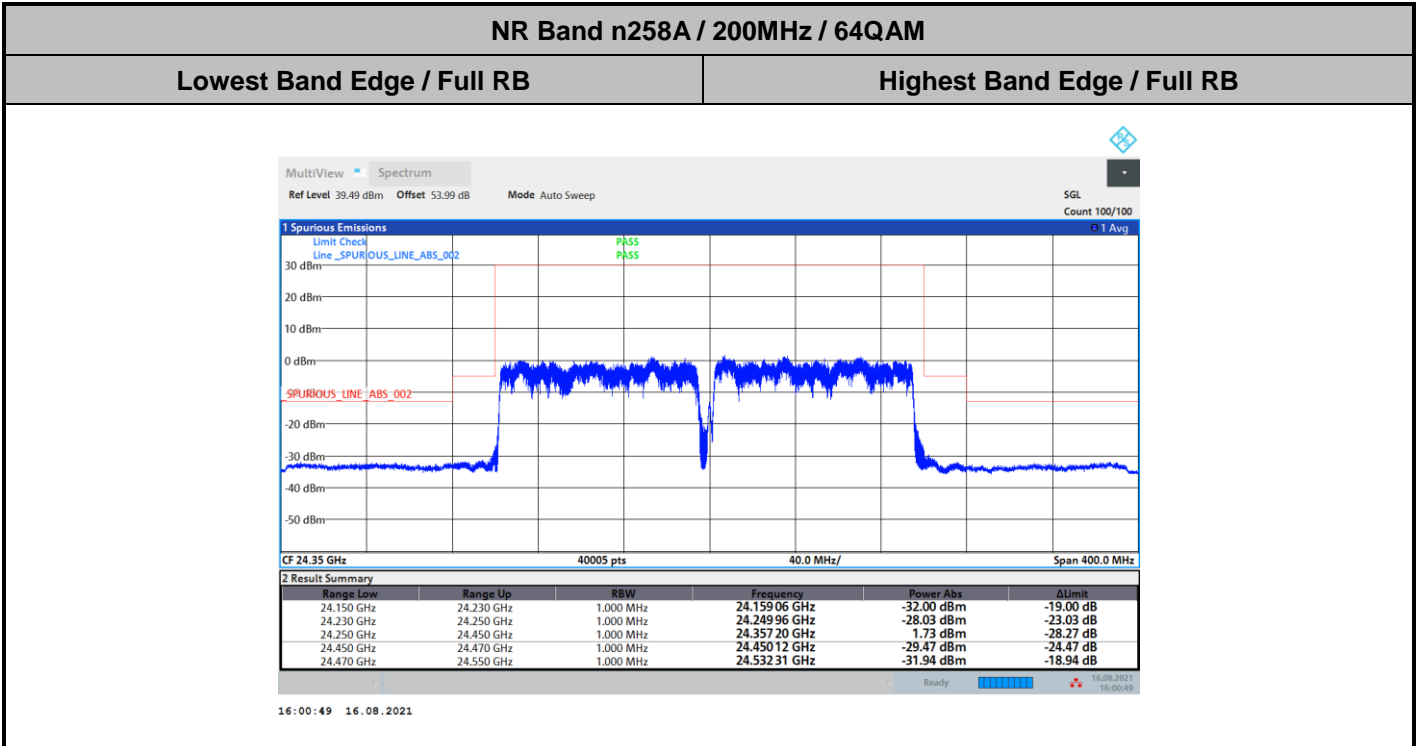

CP-OFDM Module A

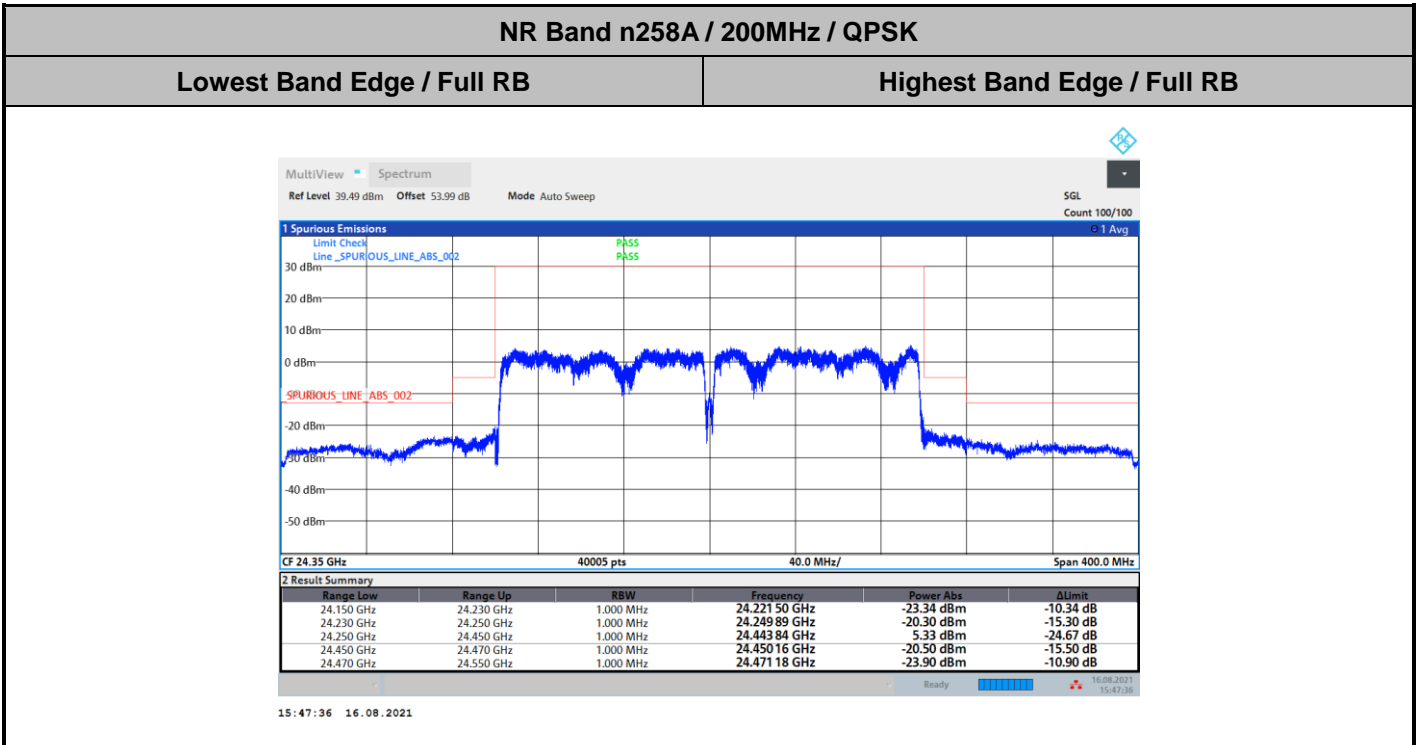



Spurious Emission



Spurious emission between 18GHz to 40GHz worst case plot is reported as following.

DFT-s-OFDM Module A

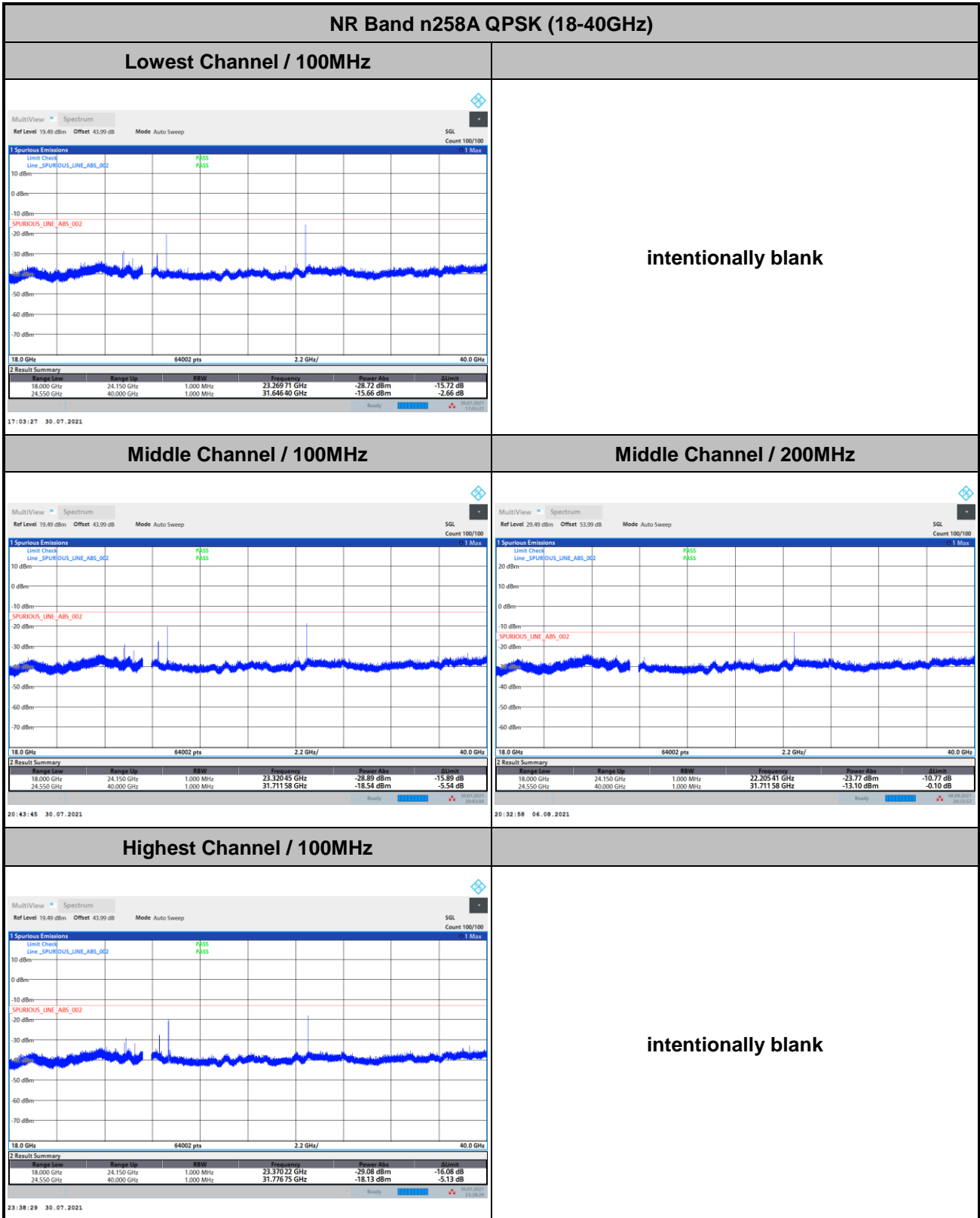

Remark: In band and out of band frequencies that has reported in previous results are omitted.



CP-OFDM Module A

NR Band n258A QPSK (18-40GHz)

Lowest Channel / 100MHz

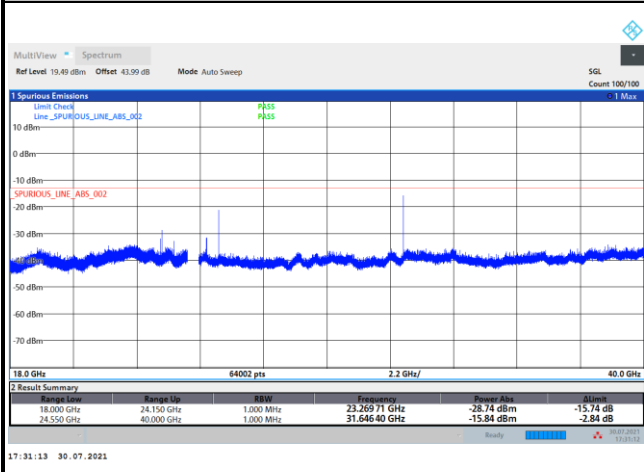

intentionally blank

Middle Channel / 100MHz

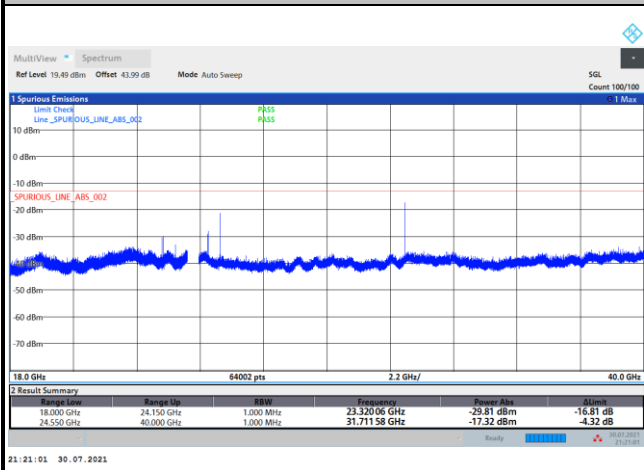

Middle Channel / 200MHz

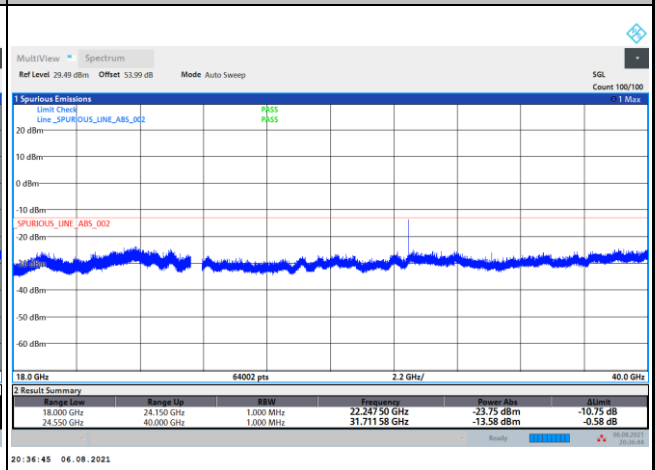

Highest Channel / 100MHz

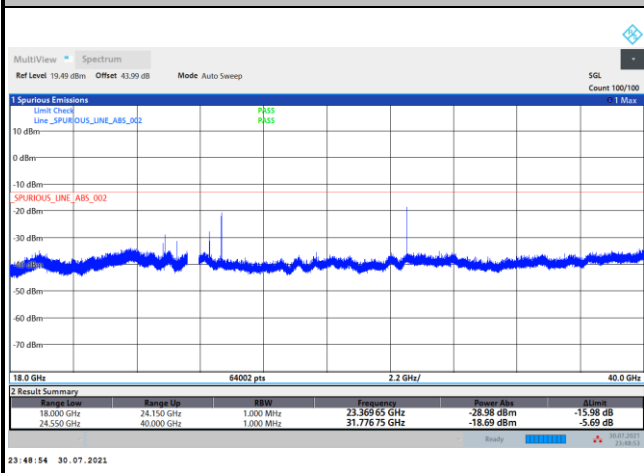

intentionally blank

Remark: In band and out of band frequencies that has reported in previous results are omitted.



NR Band n258A Module A Beam V

Occupied Bandwidth

Mode	DFT-s-OFDM Module A NR Band n258A : 99%OBW(MHz)					
BW	100MHz			200MHz		
Mod.	QPSK	16QAM	64QAM	QPSK	16QAM	64QAM
Lowest CH	91.87	91.89	91.54	-	-	-
Middle CH	91.73	91.71	91.41	190.64	190.45	190.45
Highest CH	91.75	91.80	91.45	-	-	-

Mode	CP-OFDM Module A NR Band n258A : 99%OBW(MHz)	
BW	100MHz	200MHz
Mod.	QPSK	QPSK
Lowest CH	94.76	-
Middle CH	94.73	193.44
Highest CH	94.78	-