



FCC RADIO TEST REPORT

FCC ID : A4RG8HHN
Equipment : Phone
Model Name : G8HHN
Applicant : Google LLC
1600 Amphitheatre Parkway,
Mountain View, California, 94043 USA
Standard : FCC 47 CFR Part 2, 22(H), 24(E)

The product was received on Aug. 25, 2023 and testing was performed from Aug. 25, 2023 to Dec. 05, 2023. We, Sporton International Inc. EMC & Wireless Communications Laboratory, would like to declare that the tested sample has been evaluated in accordance with the test procedures given in ANSI / TIA-603-E and has been in compliance with the applicable technical standards.

The test results in this report apply exclusively to the tested model / sample. Without written approval from Sporton International Inc. EMC & Wireless Communications Laboratory, the test report shall not be reproduced except in full.

Approved by: Louis Wu

Sporton International Inc. EMC & Wireless Communications Laboratory
No. 52, Huaya 1st Rd., Guishan Dist., Taoyuan City 333, Taiwan (R.O.C.)



Table of Contents

History of this test report..... 3

Summary of Test Result..... 4

1 General Description 6

 1.1 Product Feature of Equipment Under Test..... 6

 1.2 Modification of EUT 6

 1.3 Testing Location 7

 1.4 Applicable Standards..... 7

2 Test Configuration of Equipment Under Test 8

 2.1 Test Mode..... 8

 2.2 Connection Diagram of Test System..... 9

 2.3 Support Unit used in test configuration and system 10

 2.4 Measurement Results Explanation Example..... 10

 2.5 Frequency List of Low/Middle/High Channels 11

3 Conducted Test Items..... 14

 3.1 Measuring Instruments 14

 3.2 Conducted Output Power and ERP/EIRP 15

 3.3 Peak-to-Average Ratio 16

 3.4 Occupied Bandwidth..... 17

 3.5 Conducted Band Edge 18

 3.6 Conducted Spurious Emission 20

 3.7 Frequency Stability 21

4 Radiated Test Items 22

 4.1 Measuring Instruments 22

 4.2 Radiated Spurious Emission Measurement 24

5 List of Measuring Equipment..... 25

6 Measurement Uncertainty 26

Appendix A. Test Results of Conducted Test

Appendix B. Test Results of Radiated Test

Appendix C. Test Setup Photographs



History of this test report

Report No.	Version	Description	Issue Date
FG380306C	01	Initial issue of report	Dec. 01, 2023
FG380306C	02	Revise Section 1.1, Section 2.1, List of Measuring Equipment and Appendix A This report is an updated version, replacing the report issued on Dec. 01, 2023.	Dec. 06, 2023



Summary of Test Result

Report Clause	Ref Std. Clause	Test Items	Result (PASS/FAIL)	Remark
3.2	§2.1046	Conducted Output Power	Reporting only	-
	§22.913 (a)(5)	Effective Radiated Power (n5)	Pass	
	§27.50 (c)(10)	Effective Radiated Power (n71)		
	§24.232 (c) §27.50 (h)(2)	Equivalent Isotropic Radiated Power (n2) (n7)		
	§27.50 (d)(4)	Equivalent Isotropic Radiated Power (n66)		
3.3	§24.232 (d) §27.50 (d)(5)	Peak-to-Average Ratio	Pass	-
3.4	§2.1049	Occupied Bandwidth	Reporting only	-
3.5	§2.1051 §22.917 (a) §24.238 (a) §27.53 (g) §27.53 (h)	Conducted Band Edge Measurement (n2) (n5) (n66) (n71)	Pass	-
	§2.1051 §27.53 (m)(4)	Conducted Band Edge Measurement (n7)		



Report Clause	Ref Std. Clause	Test Items	Result (PASS/FAIL)	Remark
3.6	§2.1051 §22.917 (a) §24.238 (a) §27.53 (g) §27.53 (h)	Conducted Spurious Emission (n2) (n5) (n66) (n71)	Pass	-
	§2.1051 §27.53 (m)(4)	Conducted Spurious Emission (n7)		
3.7	§2.1055 §22.355 §24.235 §27.54	Frequency Stability Temperature & Voltage	Pass	-
4.2	§2.1053 §22.917 (a) §24.238 (a) §27.53 (g) §27.53 (h)	Radiated Spurious Emission (n2) (n5) (n66) (n71)	Pass	8.91 dB under the limit at 2037.00 MHz for Tx0 15.03 dB under the limit at 10205.00 MHz for Tx1
	§2.1051 §27.53 (m)(4)	Radiated Spurious Emission (n7)		

Conformity Assessment Condition:

1. The test results (PASS/FAIL) with all measurement uncertainty excluded are presented against the regulation limits or in accordance with the requirements stipulated by the applicant/manufacturer who shall bear all the risks of non-compliance that may potentially occur if measurement uncertainty is taken into account.
2. The measurement uncertainty please refer to each test result in the section "Measurement Uncertainty".

Disclaimer:

The product specifications of the EUT presented in the test report that may affect the test assessments are declared by the manufacturer who shall take full responsibility for the authenticity.

Reviewed by: William Chen

Report Producer: Michelle Chen



1 General Description

1.1 Product Feature of Equipment Under Test

Product Feature
<p>General Specs GSM/WCDMA/LTE/5G NR, Bluetooth, BLE, BLE channel sounding, Wi-Fi 2.4GHz 802.11b/g/n/ac/ax, Wi-Fi 5GHz 802.11a/n/ac/ax, Wi-Fi 6GHz 802.11a/ax, NFC, WPC Rx and GNSS Rx.</p> <p>Antenna Type WWAN: <Ant. 0>: ILA Antenna <Ant. 1>: ILA Antenna <Ant. 2>: IFA Antenna <Ant. 5>: IFA Antenna <Ant. 6>: IFA Antenna</p>

Remark: The above EUT's information was declared by manufacturer. Please refer to Disclaimer in report summary.

Support band and evaluated information	
Supported band	n2, n5, n7, n66, n71
Evaluated and Tested band	n2, n5, n7, n66, n71

Antenna information							
Band	Ant0	Ant1	Ant2	Ant5	Ant6	Main Ant. #	Sub Ant. #
n5	-4.3	-4.5				0	1
n71	-5.2	-8.9				0	1
n2	-2.6		-0.8			2	0
n7	-1.7		0.5			2	0
n66	-2.2		-0.5			2	0

Remark:

- For Test Items, Main Ant. means Tx0 and Sub Ant. means Tx1.
- After preliminary scan, the main antenna TX0 is selected as the worst mode to be reported for conducted test in the test report.

EUT Information List	
S/N	Performed Test Item
38011JEKB00251	Conducted Measurement ERP/EIRP
38031JEKB01525	Radiated Spurious Emission

1.2 Modification of EUT

No modifications made to the EUT during the testing.



1.3 Testing Location

Test Site	Sporton International Inc. EMC & Wireless Communications Laboratory
Test Site Location	No.52, Huaya 1st Rd., Guishan Dist., Taoyuan City 333, Taiwan (R.O.C.) TEL: +886-3-327-3456 FAX: +886-3-328-4978
Test Site No.	Sporton Site No.
	TH03-HY
Test Engineer	Sherry Wu
Temperature (°C)	20~24
Relative Humidity (%)	43~58

Test Site	Sporton International Inc. Wensan Laboratory
Test Site Location	No.58, Aly. 75, Ln. 564, Wenhua 3rd, Rd., Guishan Dist., Taoyuan City 333010, Taiwan (R.O.C.) TEL: +886-3-327-0868 FAX: +886-3-327-0855
Test Site No.	Sporton Site No.
	03CH20-HY (TAF Code: 3786)
Test Engineer	Wilson Wu, Jesse Fan and Tim Lee
Temperature (°C)	20~25
Relative Humidity (%)	50~60
Remark	The Radiated Spurious Emission test item subcontracted to Sporton International Inc. Wensan Laboratory.

Note: The test site complies with ANSI C63.4 2014 requirement.

FCC Designation No.: TW1190 and TW3786

1.4 Applicable Standards

According to the specifications declared by the manufacturer, the EUT must comply with the requirements of the following standards:

- ♦ ANSI C63.26-2015
- ♦ ANSI / TIA-603-E
- ♦ FCC 47 CFR Part 2, 22(H), 24(E)
- ♦ FCC KDB 971168 D01 Power Meas. License Digital Systems v03r01
- ♦ FCC KDB 412172 D01 Determining ERP and EIRP v01r01
- ♦ FCC KDB 414788 D01 Radiated Test Site v01r01.
- ♦ FCC KDB 662911 D01 Multiple Transmitter Output v02r01.

Remark:

1. All the test items were validated and recorded in accordance with the standards without any modification during the testing.
2. The TAF code is not including all the FCC KDB listed without accreditation.



2 Test Configuration of Equipment Under Test

2.1 Test Mode

Antenna port conducted and radiated test items listed below are performed according to KDB 971168 D01 Power Meas. License Digital Systems v03r01 with maximum output power.

For radiated measurement, the measured emission level of the EUT was maximized by rotating the EUT on a turntable, adjusting the orientation of the EUT and EUT antenna in three orthogonal axis (X: flat, Y: portrait, Z: landscape) and accessory (Adapter or Earphone), and adjusting the measurement antenna orientation, following C63.26 exploratory test procedures and find **<Tx0 Antenna>**: X with Adapter for 5G NR n2, Z with Adapter for 5G NR n5, EN-DC B5+n2, Y Plane with Earphone for 5G NR n7, Y with Adapter for EN-DC B5+n7, EN-DC B7+n71, 5G NR n66, 5G NR n71, X without Accessory for EN-DC B5+n66; **<Tx1 Antenna>**:Z plane with Adapter for 5G NR n2, X plane with Adapter for 5G NR n5, Z Plane without Accessory for EN-DC B2+n5, X Plane with Earphone for 5G NR n7, Y with Adapter for 5G NR n66 as worst plane.

Modulation Type	Modulation	Modulation Type	Modulation
A	DFT-s-OFDM pi/2 BPSK	N/A	N/A
B	DFT-s-OFDM QPSK	F	CP-OFDM QPSK
C	DFT-s-OFDM 16QAM	G	CP-OFDM 16QAM
D	DFT-s-OFDM 64QAM	H	CP-OFDM 64QAM
E	DFT-s-OFDM 256QAM	I	CP-OFDM 256QAM

Test Item	Modulation Type	Bandwidth	RB Size	Channel
Conducted Power	A, B, C, D, E	All	1, Half, Full	L, M, H
EIRP	A, B, C, D, E	All	1, Half, Full	L, M, H
PAR	A, B, C, D, E	20 MHz or less	Outer_Full	M
Bandwidth	A, F, G, H, I	All	Outer_Full	M
CBE	A, B, C, D, E, F	10MHz	Outer_1RB	L, H
		All	Outer_Full	
CSE	B	Minimum	Inner_1RB	L, M, H
Frequency Stability	A	20 MHz or less	Outer_Full	M
RSE	A or B	20 MHz or less	Inner_1RB	L, M, H

Remark:

1. Evaluated all the transmitter signal and reporting worst-case configuration among all modulation types.
2. The device is investigated from 30MHz to 10 times of fundamental signal for radiated spurious emission test under different RB size/offset and modulations in exploratory test. Subsequently, only the worst-case emissions are reported.
3. For 5G NR test combination are EN-DC 2A_n5A, EN-DC 5A_n2A, EN-DC 5A_n66A and EN-DC 7A_n71A.
4. During the RSE preliminary test, the standalone mode and charging modes (Adapter mode and WPT mode) were verified. It is determined that the adapter mode is the worst case for the official test.
5. All the radiated test cases were performed with Adapter 1 and USB Cable 3.

2.2 Connection Diagram of Test System

<EUT with Adapter>

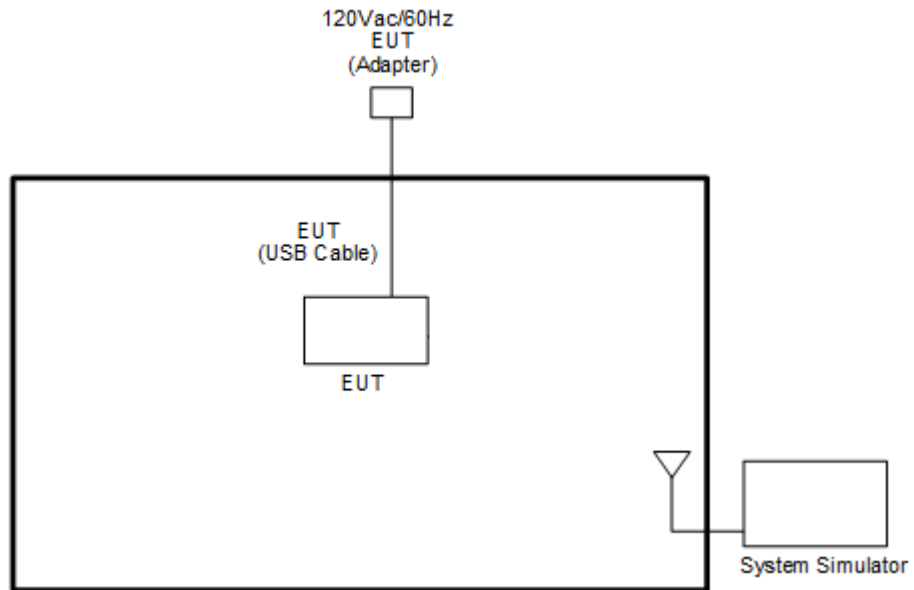

<EUT with Earphone>

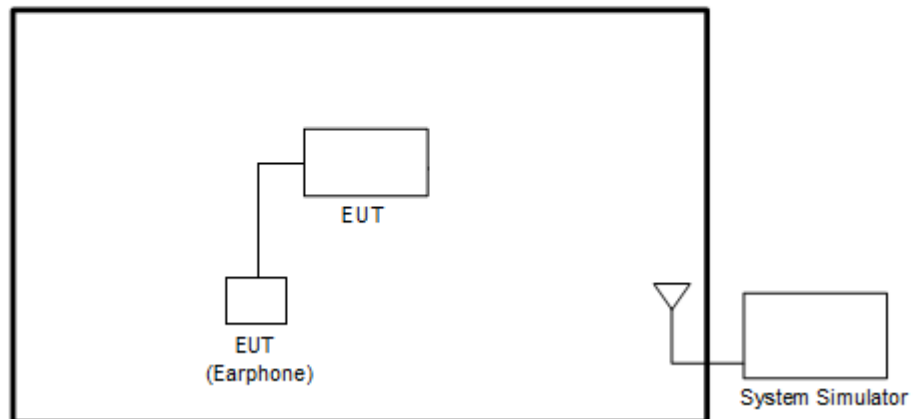

<EUT without Accessory>

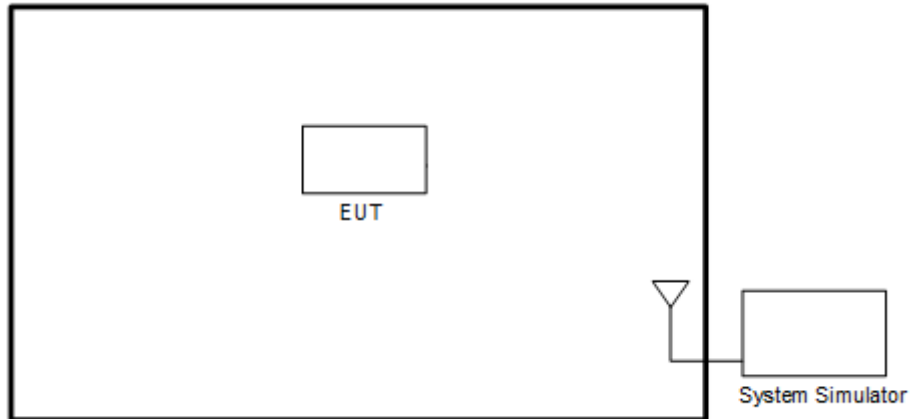

2.3 Support Unit used in test configuration and system

Item	Equipment	Brand Name	Model No.	FCC ID	Data Cable	Power Cord
1.	5G Wireless Test Platform	Anritsu	MT8000A	N/A	N/A	Unshielded, 1.8 m
2.	System Simulator	Anritsu	MT8821C	N/A	N/A	Unshielded, 1.8 m

2.4 Measurement Results Explanation Example

For all conducted test items:

The offset level is set in the spectrum analyzer to compensate the RF cable loss and attenuator factor between EUT conducted output port and spectrum analyzer. With the offset compensation, the spectrum analyzer reading level is exactly the EUT RF output level.

The spectrum analyzer offset is derived from RF cable loss and attenuator factor.

Offset = RF cable loss + attenuator factor.

Following shows an offset computation example with cable loss 4.2 dB and 10dB attenuator.

Example :

$$\begin{aligned}
 \text{Offset(dB)} &= \text{RF cable loss(dB)} + \text{attenuator factor(dB)}. \\
 &= 4.2 + 10 = 14.2 \text{ (dB)}
 \end{aligned}$$



2.5 Frequency List of Low/Middle/High Channels

5G NR n2 Channel and Frequency List				
BW [MHz]	Channel/Frequency(MHz)	Lowest	Middle	Highest
20	Channel	372000	376000	380000
	Frequency	1860	1880	1900
15	Channel	371500	376000	380500
	Frequency	1857.5	1880	1902.5
10	Channel	371000	376000	381000
	Frequency	1855	1880	1905
5	Channel	370500	376000	381500
	Frequency	1852.5	1880	1907.5

5G NR n5 Channel and Frequency List				
BW [MHz]	Channel/Frequency(MHz)	Lowest	Middle	Highest
20	Channel	166800	167300	167800
	Frequency	834	836.5	839
15	Channel	166300	167300	168300
	Frequency	831.5	836.5	841.5
10	Channel	165800	167300	168800
	Frequency	829	836.5	844
5	Channel	165300	167300	169300
	Frequency	826.5	836.5	846.5



5G NR n7 Channel and Frequency List				
BW [MHz]	Channel/Frequency(MHz)	Lowest	Middle	Highest
50	Channel	505000	507000	509000
	Frequency	2525	2535	2545
40	Channel	504000	507000	510000
	Frequency	2520	2535	2550
30	Channel	503000	507000	511000
	Frequency	2515	2535	2555
25	Channel	502500	507000	511500
	Frequency	2512.5	2535	2557.5
20	Channel	502000	507000	512000
	Frequency	2510	2535	2560
15	Channel	501500	507000	512500
	Frequency	2507.5	2535	2562.5
10	Channel	501000	507000	513000
	Frequency	2505	2535	2565
5	Channel	500500	507000	513500
	Frequency	2502.5	2535	2567.5

5G NR n66 Channel and Frequency List				
BW [MHz]	Channel/Frequency(MHz)	Lowest	Middle	Highest
40	Channel	346000	349000	352000
	Frequency	1730	1745	1760
30	Channel	345000	349000	353000
	Frequency	1725	1745	1765
25	Channel	344500	349000	353500
	Frequency	1722.5	1745	1767.5
20	Channel	344000	349000	354000
	Frequency	1720	1745	1770
15	Channel	343500	349000	354500
	Frequency	1717.5	1745	1772.5
10	Channel	343000	349000	355000
	Frequency	1715	1745	1775
5	Channel	342500	349000	355500
	Frequency	1712.5	1745	1777.5



5G NR n71 Channel and Frequency List				
BW [MHz]	Channel/Frequency(MHz)	Lowest	Middle	Highest
20	Channel	134600	136100	137600
	Frequency	673	680.5	688
15	Channel	134100	136100	138100
	Frequency	670.5	680.5	690.5
10	Channel	133600	136100	138600
	Frequency	668	680.5	693
5	Channel	133100	136100	139100
	Frequency	665.5	680.5	695.5

3 Conducted Test Items

3.1 Measuring Instruments

See list of measuring instruments of this test report.

3.1.1 Test Setup

3.1.2 Conducted Output Power

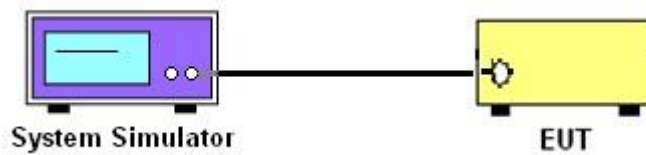

3.1.3 Peak-to-Average Ratio, Occupied Bandwidth ,Conducted Band-Edge and Conducted Spurious Emission

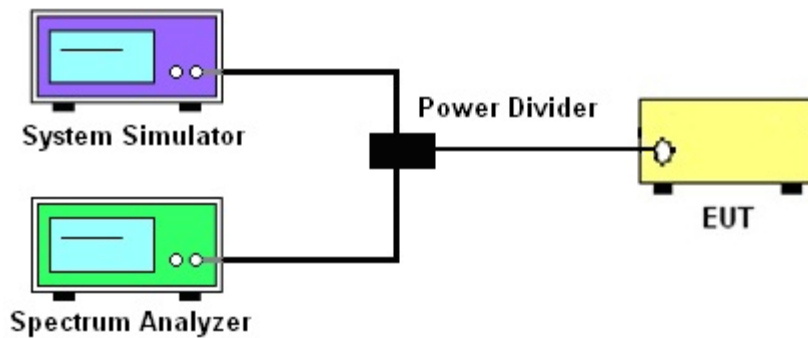

3.1.4 Frequency Stability



3.1.5 Test Result of Conducted Test

Please refer to Appendix A.



3.2 Conducted Output Power and ERP/EIRP

3.2.1 Description of the Conducted Output Power Measurement and ERP/EIRP Measurement

A system simulator was used to establish communication with the EUT. Its parameters were set to force the EUT transmitting at maximum output power. The measured power in the radio frequency on the transmitter output terminals shall be reported.

The ERP of mobile transmitters must not exceed 7 Watts for 5G NR n5

The ERP of mobile transmitters must not exceed 3 Watts for 5G NR n71

The EIRP of mobile transmitters must not exceed 2 Watts for 5G NR n2, n7

The EIRP of mobile transmitters must not exceed 1 Watts for 5G NR n66

According to KDB 412172 D01 Power Approach,

$EIRP = P_T + G_T - L_C$, $ERP = EIRP - 2.15$, where

P_T = transmitter output power in dBm

G_T = gain of the transmitting antenna in dBi

L_C = signal attenuation in the connecting cable between the transmitter and antenna in dB

3.2.2 Test Procedures

1. The transmitter output port was connected to the system simulator.
2. Set EUT at maximum power through the system simulator.
3. Select lowest, middle, and highest channels for each band and different modulation.
4. Measure and record the power level from the system simulator.



3.3 Peak-to-Average Ratio

3.3.1 Description of the PAR Measurement

Power Complementary Cumulative Distribution Function (CCDF) curves provide a means for characterizing the power peaks of a digitally modulated signal on a statistical basis. A CCDF curve depicts the probability of the peak signal amplitude exceeding the average power level. Most contemporary measurement instrumentation include the capability to produce CCDF curves for an input signal provided that the instrument's resolution bandwidth can be set wide enough to accommodate the entire input signal bandwidth. In measuring transmissions in this band using an average power technique, the peak-to-average ratio (PAR) of the transmission may not exceed 13 dB.

3.3.2 Test Procedures

The testing follows ANSI C63.26-2015 Section 5.2.6

1. The EUT was connected to spectrum and system simulator via a power divider.
2. Set the CCDF (Complementary Cumulative Distribution Function) option in spectrum analyzer.
3. The highest RF powers were measured and recorded the maximum PAPR level associated with a probability of 0.1 %.
4. Record the deviation as Peak to Average Ratio.



3.4 Occupied Bandwidth

3.4.1 Description of Occupied Bandwidth Measurement

The occupied bandwidth is the width of a frequency band such that, below the lower and above the upper frequency limits, the mean powers emitted are each equal to a specified percentage 0.5% of the total mean transmitted power.

The 26 dB emission bandwidth is defined as the frequency range between two points, one above and one below the carrier frequency, at which the spectral density of the emission is attenuated 26 dB below the maximum in-band spectral density of the modulated signal. Spectral density (power per unit bandwidth) is to be measured with a detector of resolution bandwidth equal to approximately 1.0% of the emission bandwidth.

3.4.2 Test Procedures

The testing follows ANSI C63.26-2015 Section 5.4.3 (26dB) and Section 5.4.4 (99OB)

1. The EUT was connected to spectrum analyzer and system simulator via a power divider.
2. The spectrum analyzer center frequency is set to the nominal EUT channel center frequency. The span range for the spectrum analyzer shall be between two and five times the anticipated OBW.
3. The nominal resolution bandwidth (RBW) shall be in the range of 1 to 5 % of the anticipated OBW, and the VBW shall be at least 3 times the RBW.
4. Set the detection mode to peak, and the trace mode to max hold.
5. Determine the reference value: Set the EUT to transmit a modulated signal. Allow the trace to stabilize. Set the spectrum analyzer marker to the highest level of the displayed trace.
(this is the reference value)
6. Determine the “-26 dB down amplitude” as equal to (Reference Value – X).
7. Place two markers, one at the lowest and the other at the highest frequency of the envelope of the spectral display such that each marker is at or slightly below the “-X dB down amplitude” determined in step 6. If a marker is below this “-X dB down amplitude” value it shall be placed as close as possible to this value. The OBW is the positive frequency difference between the two markers.
8. Use the 99 % power bandwidth function of the spectrum analyzer and report the measured bandwidth.



3.5 Conducted Band Edge

3.5.1 Description of Conducted Band Edge Measurement

22.917(a)

For operations in the 824 – 849 MHz band, the FCC limit is $43 + 10\log_{10}(P[\text{Watts}])$ dB below the transmitter power $P(\text{Watts})$ in a 100kHz bandwidth. However, in the 1MHz bands immediately outside and adjacent to the licensee's frequency block, a resolution bandwidth of at least one percent of the emission bandwidth of the fundamental emission of the transmitter may be employed.

24.238 (a)

For operations in the 1850-1910 and 1930-1990 MHz band, the FCC limit is $43 + 10\log_{10}(P[\text{Watts}])$ dB below the transmitter power $P(\text{Watts})$ in a 1MHz bandwidth. However, in the 1 MHz bands immediately outside and adjacent to the frequency block a resolution bandwidth of at least one percent of the emission bandwidth of the fundamental emission of the transmitter may be employed.

27.53 (g)

For operations in the 600MHz band and 698-746 MHz band, the FCC limit is $43 + 10\log_{10}(P[\text{Watts}])$ dB below the transmitter power $P(\text{Watts})$ in a 100 kHz bandwidth. However, in the 100 kilohertz bands immediately outside and adjacent to a licensee's frequency block, a resolution bandwidth of at least 30 kHz may be employed.

27.53 (h)

For operations in the 1710 – 1755 MHz band, 1755-1780 MHz, the FCC limit is $43 + 10\log_{10}(P[\text{Watts}])$ dB below the transmitter power $P(\text{Watts})$ in a 1 MHz bandwidth. However, in the 1MHz bands immediately outside and adjacent to the licensee's frequency block, a resolution bandwidth of at least one percent of the emission bandwidth of the fundamental emission of the transmitter may be employed.

**27.53(m)(4)**

For mobile digital stations, the attenuation factor shall be not less than $40 + 10 \log (P)$ dB on all frequencies between the channel edge and 5 megahertz from the channel edge, $43 + 10 \log (P)$ dB on all frequencies between 5 megahertz and X megahertz from the channel edge, and $55 + 10 \log (P)$ dB on all frequencies more than X megahertz from the channel edge, where X is the greater of 6 megahertz or the actual emission bandwidth as defined in paragraph (m)(6) of this section. In addition, the attenuation factor shall not be less that $43 + 10 \log (P)$ dB on all frequencies between 2490.5 MHz and 2496 MHz and $55 + 10 \log (P)$ dB at or below 2490.5 MHz. Mobile Satellite Service licensees operating on frequencies below 2495 MHz may also submit a documented interference complaint against BRS licensees operating on channel BRS Channel 1 on the same terms and conditions as adjacent channel BRS or EBS licensees.

3.5.2 Test Procedures

The testing follows FCC KDB 971168 D01 v03r01 Section 6.1.

1. The EUT was connected to spectrum analyzer and system simulator via a power divider.
2. The band edges of low and high channels for the highest RF powers were measured.
3. Set RBW \geq 1% EBW in the 1MHz band immediately outside and adjacent to the band edge.
4. Beyond the 1 MHz band from the band edge, RBW=1MHz was used.
5. Set spectrum analyzer with RMS detector.
6. The RF fundamental frequency should be excluded against the limit line in the operating frequency band.
7. Checked that all the results comply with the emission limit line.

The limit line is derived from $43 + 10\log(P)$ dB below the transmitter power P(Watts)

For 5G NR n7

The other 40 dB, and 55 dB have additionally applied same calculation above.



3.6 Conducted Spurious Emission

3.6.1 Description of Conducted Spurious Emission Measurement

The power of any emission outside of the authorized operating frequency ranges must be lower than the transmitter power (P) by a factor of at least $43 + 10 \log (P)$ dB.

For 5G NR n7

The power of any emission outside of the authorized operating frequency ranges must be lower than the transmitter power (P) by a factor of at least $55 + 10 \log (P)$ dB.

It is measured by means of a calibrated spectrum analyzer and scanned from 30 MHz up to a frequency including its 10th harmonic.

3.6.2 Test Procedures

The testing follows FCC KDB 971168 D01 v03r01 Section 6.1.

1. The EUT was connected to spectrum analyzer and system simulator via a power divider.
2. The RF output of EUT was connected to the spectrum analyzer by RF cable and attenuator. The path loss was compensated to the results for each measurement.
3. The conducted spurious emission for the whole frequency range was taken.
4. Make the measurement with the spectrum analyzer's RBW = 100 kHz if the authorized frequency band/block is at or below 1 GHz and 1 MHz if the authorized frequency band/block is above 1 GHz, VBW = 3 * RBW.
5. Set spectrum analyzer with RMS detector.
6. Taking the record of maximum spurious emission.
7. The RF fundamental frequency should be excluded against the limit line in the operating frequency band.
8. The limit line is derived from $43 + 10\log(P)$ dB below the transmitter power P(Watts)

For 5G NR n7

The limit line is derived from $55 + 10\log(P)$ dB below the transmitter power P(Watts)



3.7 Frequency Stability

3.7.1 Description of Frequency Stability Measurement

The frequency stability shall be sufficient to ensure that the fundamental emission stays within the authorized frequency block.

22.355

The frequency stability shall be sufficient to ensure that the occupied bandwidth stays within each of the sub-bands when tested at the temperature and supply voltage variations specified in RSS-Gen.

24.235 & 27.54

The frequency stability shall be sufficient to ensure that the fundamental emission stays within the authorized frequency block.

3.7.2 Test Procedures for Temperature Variation

The testing follows FCC KDB 971168 D01 v03r01 Section 9.0.

1. The EUT was set up in the thermal chamber and connected with the system simulator.
2. With power OFF, the temperature was decreased to -30°C and the EUT was stabilized before testing. Power was applied and the maximum change in frequency was recorded within one minute.
3. With power OFF, the temperature was raised in 10°C step up to 50°C. The EUT was stabilized at each step for at least half an hour. Power was applied and the maximum frequency change was recorded within one minute.

3.7.3 Test Procedures for Voltage Variation

The testing follows FCC KDB 971168 D01 v03r01 Section 9.0.

1. The EUT was placed in a temperature chamber at 20±5° C and connected with the system simulator.
2. The power supply voltage to the EUT was varied from 85% to 115% of the nominal value measured at the input to the EUT.
3. The variation in frequency was measured for the worst case.

4 Radiated Test Items

4.1 Measuring Instruments

See list of measuring instruments of this test report.

4.1.1 Test Setup

For radiated test below 30MHz

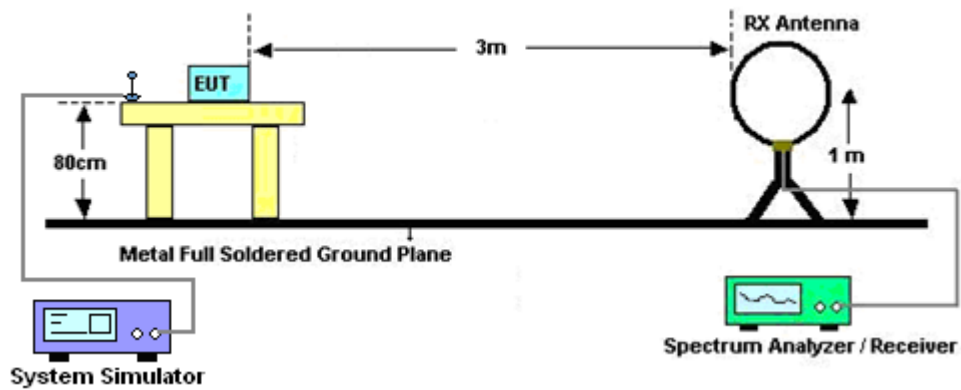

For radiated test from 30MHz to 1GHz

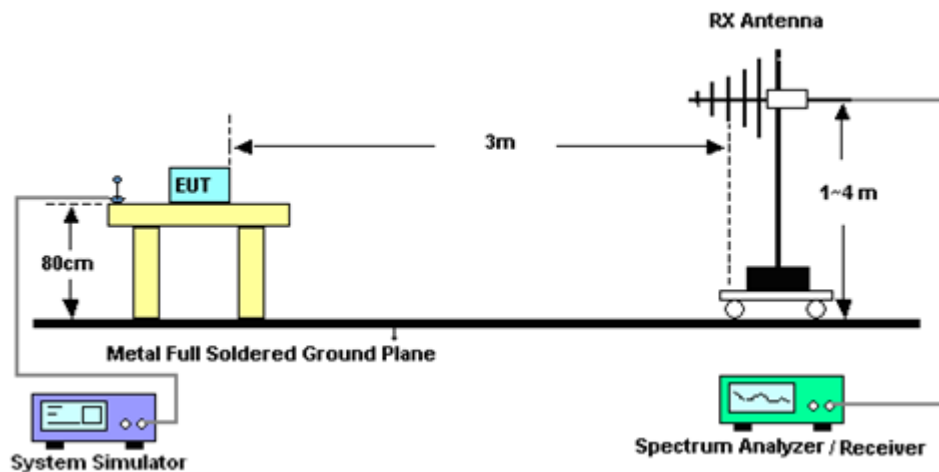

For radiated test from 1GHz to 18GHz

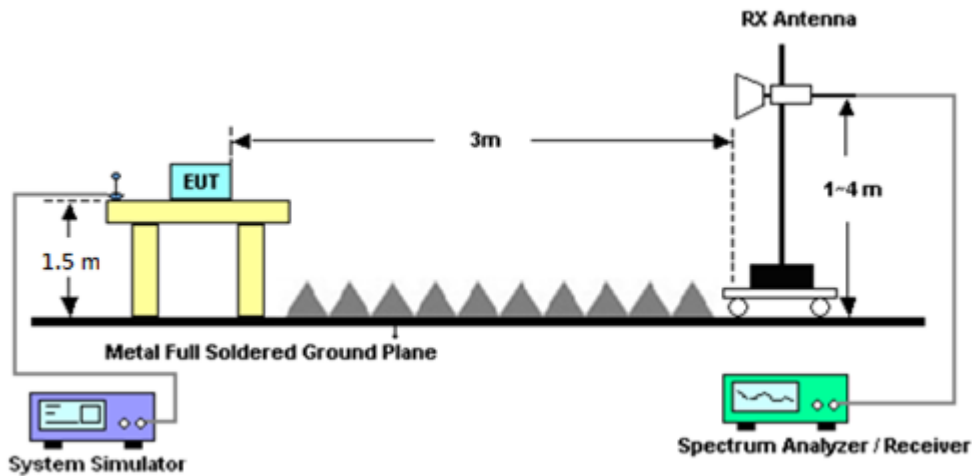

For radiated test above 18GHz

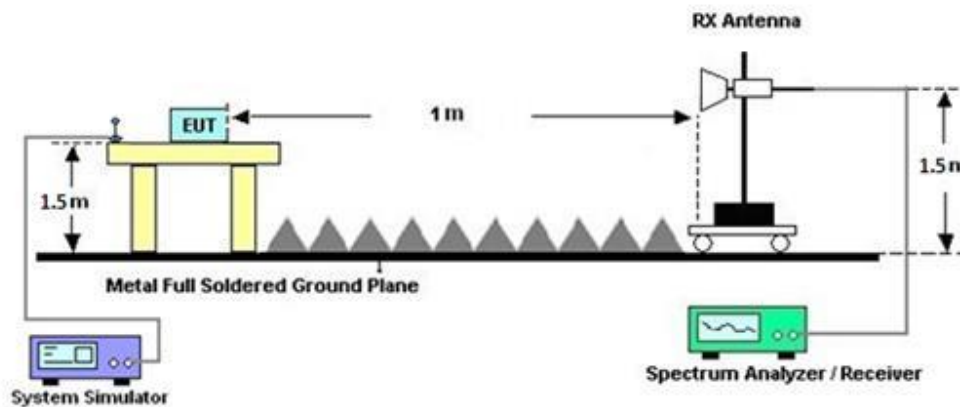

4.1.2 Test Result of Radiated Test

Please refer to Appendix B.

Note:

The low frequency, which started from 9 kHz to 30MHz, was pre-scanned and the result which was 20dB lower than the limit line was not reported.

There is adequate comparison measurement of both open-field test site and alternative test site - semi-Anechoic chamber according to 414788 D01 Radiated Test Site v01r01, and the result came out very similar.



4.2 Radiated Spurious Emission Measurement

4.2.1 Description of Radiated Spurious Emission Measurement

The radiated spurious emission was measured by substitution method according to ANSI / TIA-603-E. The power of any emission outside of the authorized operating frequency ranges must be attenuated below the transmitter power (P) by a factor of at least $43 + 10 \log (P)$ dB

For 5G NR n7

The power of any emission outside of the authorized operating frequency ranges must be attenuated below the transmitter power (P) by a factor of at least $55 + 10 \log (P)$ dB.

The spectrum is scanned from 30 MHz up to a frequency including its 10th harmonic.

4.2.2 Test Procedures

The testing follows FCC KDB 971168 D01 v03r01 Section 7 and ANSI / TIA-603-E Section 2.2.12.

1. The EUT was placed on a turntable with 0.8 meter for frequency below 1GHz and 1.5 meter for frequency above 1GHz respectively above ground.
2. The EUT was set 3 meters from the receiving antenna, which was mounted on the antenna tower.
3. The table was rotated 360 degrees to determine the position of the highest spurious emission.
4. The height of the receiving antenna is varied between one meter and four meters to search the maximum spurious emission for both horizontal and vertical polarizations.
5. Make the measurement with the spectrum analyzer's RBW = 1MHz, VBW = 3MHz, taking the record of maximum spurious emission.
6. To convert spectrum reading E(dBuV/m) to EIRP(dBm)
 $EIRP(dBm) = Level (dBuV/m) + 20\log(d) - 104.77$, where d is the distance at which field strength limit is specified in the rules
7. Field Strength Level (dBm) = Spectrum Reading (dBm) + Antenna Factor + Cable Loss + Read Level - Preamp Factor.
8. ERP (dBm) = EIRP - 2.15
9. The RF fundamental frequency should be excluded against the limit line in the operating frequency band.

The limit line is derived from $43 + 10\log(P)$ dB below the transmitter power P(Watts)

For 5G NR n7

The limit line is derived from $55 + 10\log(P)$ dB below the transmitter power P(Watts)



5 List of Measuring Equipment

Instrument	Brand Name	Model No.	Serial No.	Characteristics	Calibration Date	Test Date	Due Date	Remark
Loop Antenna	Rohde & Schwarz	HFH2-Z2	100315	9 kHz~30 MHz	Feb. 28, 2023	Aug. 29, 2023~ Oct. 05, 2023	Feb. 27, 2024	Radiation (03CH12-HY)
Bilog Antenna	TESEQ	CBL 6111D & 00800N1D01N -06	37059 & 01	30MHz~1GHz	Nov. 10, 2022	Aug. 29, 2023~ Oct. 05, 2023	Nov. 09, 2023	Radiation (03CH12-HY)
Horn Antenna	SCHWARZBE CK	BBHA 9120 D	9120D-1241	1GHz~18GHz	Jul. 31, 2023	Aug. 29, 2023~ Oct. 05, 2023	Jul. 30, 2024	Radiation (03CH12-HY)
SHF-EHF Horn Antenna	SCHWARZBE CK	BBHA9170	00993	18GHz~40GHz	Nov. 24, 2022	Aug. 29, 2023~ Oct. 05, 2023	Nov. 23, 2023	Radiation (03CH12-HY)
Preamplifier	COM-POWER	PAM-103	161075	10MHz~1GHz	Mar. 21, 2023	Aug. 29, 2023~ Oct. 05, 2023	Mar. 20, 2024	Radiation (03CH12-HY)
Preamplifier	Agilent	8449B	3008A02375	1GHz~26.5GHz	May 23, 2023	Aug. 29, 2023~ Oct. 05, 2023	May 22, 2024	Radiation (03CH12-HY)
Preamplifier	E-INSTRUME NT TECH LTD.	ERA-100M-18 G-56-01-A70	EC1900249	1GHz-18GHz	Dec. 21, 2022	Aug. 29, 2023~ Oct. 05, 2023	Dec. 20, 2023	Radiation (03CH12-HY)
Preamplifier	EMEC	EM18G40G	060715	18GHz~40GHz	Dec. 07, 2022	Aug. 29, 2023~ Oct. 05, 2023	Dec. 06, 2023	Radiation (03CH12-HY)
Spectrum Analyzer	Agilent	N9010A	MY53470118	10Hz~44GHz	Jan. 10, 2023	Aug. 29, 2023~ Oct. 05, 2023	Jan. 09, 2024	Radiation (03CH12-HY)
Filter	Wainwright	WHKX8-5872. 5-6750-18000- 40ST	SN2	6.75GHz High Pass Filter	Mar. 14, 2023	Aug. 29, 2023~ Oct. 05, 2023	Mar. 13, 2024	Radiation (03CH12-HY)
RF Cable	HUBER + SUHNER	SUCOFLEX 102	803951/2	9kHz~30MHz	Mar. 07, 2023	Aug. 29, 2023~ Oct. 05, 2023	Mar. 06, 2024	Radiation (03CH12-HY)
RF Cable	HUBER + SUHNER	SUCOFLEX 126E	0058/126E	30MHz~18GHz	Dec. 20, 2022	Aug. 29, 2023~ Oct. 05, 2023	Dec. 19, 2023	Radiation (03CH12-HY)
RF Cable	HUBER + SUHNER	SUCOFLEX 102	505134/2	30MHz~40GHz	Dec. 20, 2022	Aug. 29, 2023~ Oct. 05, 2023	Dec. 19, 2023	Radiation (03CH12-HY)
RF Cable	HUBER + SUHNER	SUCOFLEX 102	803953/2	30MHz~40GHz	Dec. 20, 2022	Aug. 29, 2023~ Oct. 05, 2023	Dec. 19, 2023	Radiation (03CH12-HY)
Hygrometer	TECPEL	DTM-303B	TP161250	N/A	Jul. 26, 2023	Aug. 29, 2023~ Oct. 05, 2023	Jul. 25, 2024	Radiation (03CH12-HY)
Controller	EMEC	EM1000	N/A	Control Turn table & Ant Mast	N/A	Aug. 29, 2023~ Oct. 05, 2023	N/A	Radiation (03CH12-HY)
Antenna Mast	EMEC	AM-BS-4500-B	N/A	1m~4m	N/A	Aug. 29, 2023~ Oct. 05, 2023	N/A	Radiation (03CH12-HY)
Turn Table	EMEC	TT2000	N/A	0~360 Degree	N/A	Aug. 29, 2023~ Oct. 05, 2023	N/A	Radiation (03CH12-HY)
Software	Audix	E3 6.2009-8-24	RK-000989	N/A	N/A	Aug. 29, 2023~ Oct. 05, 2023	N/A	Radiation (03CH12-HY)
Programmable Power Supply	GW Instek	GPE-2323	GET910884	0V~64V ;0A~6A	Dec. 21, 2022	Aug. 25, 2023~ Dec. 05, 2023	Dec. 20, 2023	Conducted (TH03-HY)
Signal Analyzer	Rohde & Schwarz	FSV3044	101048	10Hz~44GHz	May 03, 2023	Aug. 25, 2023~ Dec. 05, 2023	May 02, 2024	Conducted (TH03-HY)
Temperature Chamber	ESPEC	SH-241	92003713	-30℃ ~90℃	May 17, 2023	Aug. 25, 2023~ Dec. 05, 2023	May 16, 2024	Conducted (TH03-HY)
Base Station (Measure)	Anritsu	MT8821C	6262116730	LTE	Jul. 10, 2023	Aug. 25, 2023~ Dec. 05, 2023	Jul. 09, 2024	Conducted (TH03-HY)
Base Station (Measure)	Anritsu	MT8000A	6262134933	FR1	Jul. 10, 2023	Aug. 25, 2023~ Dec. 05, 2023	Jul. 09, 2024	Conducted (TH03-HY)
Signal Analyzer	Rohde & Schwarz	FSW43	101456	RBW 50MHz	Feb. 23, 2023	Aug. 25, 2023~ Dec. 05, 2023	Feb. 22, 2024	Conducted (TH03-HY)



6 Measurement Uncertainty

Uncertainty of Radiated Emission Measurement (30 MHz ~ 1000 MHz)

Measuring Uncertainty for a Level of Confidence of 95% ($U = 2Uc(y)$)	3.07 dB
---	---------

Uncertainty of Radiated Emission Measurement (1 GHz ~ 18 GHz)

Measuring Uncertainty for a Level of Confidence of 95% ($U = 2Uc(y)$)	3.63 dB
---	---------

Uncertainty of Radiated Emission Measurement (18 GHz ~ 40 GHz)

Measuring Uncertainty for a Level of Confidence of 95% ($U = 2Uc(y)$)	4.14 dB
---	---------



Appendix A. Test Results of Conducted Test

Conducted Output Power(Average power) and ERP/EIRP

<Tx0 Antenna>

NR n2 Maximum Average Power [dBm] (GT - LC = -0.8 dB)								
BW [MHz]	RB Size	RB Offset	Mod	Lowest	Middle	Highest	EIRP (dBm)	EIRP(W)
5	1	1	PI/2 BPSK	24.45	24.37	24.51	23.95	0.2483
5	1	23		24.52	24.42	24.75		
5	12	6		24.45	24.35	24.66		
5	1	0		23.83	23.91	23.97		
5	1	24		23.97	23.85	24.15		
5	25	0		24.00	23.86	24.06		
5	1	1	QPSK	24.43	24.42	24.60		
5	1	23		24.51	24.28	24.71		
5	12	6		24.49	24.32	24.66		
5	1	0		23.51	23.33	23.51		
5	1	24		23.44	23.29	23.70		
5	25	0		23.48	23.37	23.63		
5	1	1	16-QAM	23.52	23.37	23.62	22.82	0.1914
5	1	1	64-QAM	22.01	21.92	22.09		
5	1	1	256-QAM	19.90	19.74	19.85		
Limit	EIRP < 2W			Result			Pass	

NR n2 Maximum Average Power [dBm] (GT - LC = -0.8 dB)								
BW [MHz]	RB Size	RB Offset	Mod	Lowest	Middle	Highest	EIRP (dBm)	EIRP(W)
10	1	1	PI/2 BPSK	24.53	24.43	24.44	23.93	0.2472
10	1	50		24.52	24.26	24.73		
10	25	12		24.51	24.36	24.63		
10	1	0		23.84	23.88	23.90		
10	1	51		23.92	23.87	24.21		
10	50	0		23.98	23.93	24.02		
10	1	1	QPSK	24.47	24.42	24.39		
10	1	50		24.53	24.33	24.71		
10	25	12		24.54	24.38	24.62		
10	1	0		23.51	23.39	23.50		
10	1	51		23.58	23.35	23.78		
10	50	0		23.50	23.35	23.51		
10	1	1	16-QAM	23.45	23.41	23.57	22.77	0.1892
10	1	1	64-QAM	22.07	21.75	21.89		
10	1	1	256-QAM	19.89	19.77	19.86		
Limit	EIRP < 2W			Result			Pass	



NR n2 Maximum Average Power [dBm] (GT - LC = -0.8 dB)										
BW [MHz]	RB Size	RB Offset	Mod	Lowest	Middle	Highest	EIRP (dBm)	EIRP(W)		
15	1	1	PI/2 BPSK	24.49	24.45	24.38	23.89	0.2449		
15	1	77		24.48	24.30	24.69				
15	36	18		24.47	24.44	24.41				
15	1	0		23.93	23.90	23.79				
15	1	78		23.91	23.81	24.15				
15	75	0		23.94	23.90	23.95				
15	1	1	QPSK	24.56	24.45	24.36			23.89	0.2449
15	1	77		24.44	24.38	24.64				
15	36	18		24.56	24.43	24.43				
15	1	0		23.50	23.47	23.37				
15	1	78		23.50	23.31	23.63				
15	75	0		23.51	23.43	23.48				
15	1	1	16-QAM	23.44	23.55	23.49	22.75	0.1884		
15	1	1	64-QAM	22.09	21.98	22.04				
15	1	1	256-QAM	19.81	19.80	19.86				
Limit	EIRP < 2W			Result			Pass			

NR n2 Maximum Average Power [dBm] (GT - LC = -0.8 dB)										
BW [MHz]	RB Size	RB Offset	Mod	Lowest	Middle	Highest	EIRP (dBm)	EIRP(W)		
20	1	1	PI/2 BPSK	24.43	24.45	24.35	23.9	0.2455		
20	1	104		24.40	24.22	24.66				
20	50	25		24.52	24.37	24.43				
20	1	0		23.98	23.97	23.79				
20	1	105		23.83	23.80	24.11				
20	100	0		23.90	23.86	23.89				
20	1	1	QPSK	24.48	24.49	24.39			23.9	0.2455
20	1	104		24.36	24.28	24.70				
20	50	25		24.51	24.38	24.42				
20	1	0		23.46	23.48	23.38				
20	1	105		23.41	23.31	23.62				
20	100	0		23.41	23.43	23.46				
20	1	1	16-QAM	23.59	23.58	23.42	22.79	0.1901		
20	1	1	64-QAM	22.05	21.90	21.76				
20	1	1	256-QAM	19.98	19.81	19.72				
Limit	EIRP < 2W			Result			Pass			



NR n5 Maximum Average Power [dBm] (GT - LC = -4.3 dB)										
BW [MHz]	RB Size	RB Offset	Mod	Lowest	Middle	Highest	ERP (dBm)	ERP(W)		
5	1	1	PI/2 BPSK	24.67	24.64	24.76	18.36	0.0685		
5	1	23		24.69	24.73	24.78				
5	12	6		24.68	24.72	24.81				
5	1	0		24.18	24.16	24.28				
5	1	24		24.18	24.24	24.28				
5	25	0		24.20	24.23	24.28				
5	1	1	QPSK	24.70	24.63	24.72			17.42	0.0552
5	1	23		24.71	24.70	24.74				
5	12	6		24.66	24.71	24.80				
5	1	0		23.63	23.71	23.79				
5	1	24		23.69	23.74	23.75				
5	25	0		23.67	23.74	23.81				
5	1	1	16-QAM	23.79	23.68	23.87	17.42	0.0552		
5	1	1	64-QAM	21.25	21.12	21.39				
5	1	1	256-QAM	20.30	20.21	20.32				
Limit	ERP < 7W			Result			Pass			

NR n5 Maximum Average Power [dBm] (GT - LC = -4.3 dB)										
BW [MHz]	RB Size	RB Offset	Mod	Lowest	Middle	Highest	ERP (dBm)	ERP(W)		
10	1	1	PI/2 BPSK	24.64	24.70	24.69	18.38	0.0689		
10	1	50		24.67	24.83	24.70				
10	25	12		24.71	24.77	24.71				
10	1	0		24.19	24.18	24.19				
10	1	51		24.09	24.33	24.16				
10	50	0		24.17	24.22	24.17				
10	1	1	QPSK	24.64	24.67	24.64			17.31	0.0538
10	1	50		24.70	24.75	24.78				
10	25	12		24.69	24.68	24.70				
10	1	0		23.63	23.87	23.67				
10	1	51		23.75	23.67	23.75				
10	50	0		23.77	23.73	23.78				
10	1	1	16-QAM	23.76	23.57	23.70	17.31	0.0538		
10	1	1	64-QAM	21.37	21.28	21.44				
10	1	1	256-QAM	20.14	20.19	20.18				
Limit	ERP < 7W			Result			Pass			



NR n5 Maximum Average Power [dBm] (GT - LC = -4.3 dB)										
BW [MHz]	RB Size	RB Offset	Mod	Lowest	Middle	Highest	ERP (dBm)	ERP(W)		
15	1	1	PI/2 BPSK	24.61	24.66	24.56	18.38	0.0689		
15	1	77		24.71	24.80	24.69				
15	36	18		24.62	24.70	24.71				
15	1	0		24.12	24.22	24.09				
15	1	78		24.15	24.23	24.30				
15	75	0		24.18	24.26	24.22				
15	1	1	QPSK	24.68	24.66	24.64			17.33	0.0541
15	1	77		24.66	24.83	24.79				
15	36	18		24.69	24.69	24.72				
15	1	0		23.60	23.70	23.65				
15	1	78		23.64	23.76	23.80				
15	75	0		23.71	23.77	23.71				
15	1	1	16-QAM	23.78	23.72	23.60	17.33	0.0541		
15	1	1	64-QAM	21.20	21.40	21.03				
15	1	1	256-QAM	20.02	20.15	20.25				
Limit	ERP < 7W			Result			Pass			

NR n5 Maximum Average Power [dBm] (GT - LC = -4.3 dB)										
BW [MHz]	RB Size	RB Offset	Mod	Lowest	Middle	Highest	ERP (dBm)	ERP(W)		
20	1	1	PI/2 BPSK	24.54	24.62	24.62	18.34	0.0682		
20	1	104		24.73	24.79	24.77				
20	50	25		24.60	24.77	24.75				
20	1	0		24.11	24.08	24.15				
20	1	105		24.30	24.32	24.26				
20	100	0		24.18	24.21	24.25				
20	1	1	QPSK	24.53	24.70	24.67			17.30	0.0537
20	1	104		24.72	24.79	24.78				
20	50	25		24.61	24.70	24.71				
20	1	0		23.66	23.73	23.65				
20	1	105		23.74	23.84	23.77				
20	100	0		23.61	23.72	23.74				
20	1	1	16-QAM	23.45	23.51	23.75	17.30	0.0537		
20	1	1	64-QAM	21.08	21.22	21.26				
20	1	1	256-QAM	20.10	20.02	20.24				
Limit	ERP < 7W			Result			Pass			



NR n7 Maximum Average Power [dBm] (GT - LC = 0.5 dB)										
BW [MHz]	RB Size	RB Offset	Mod	Lowest	Middle	Highest	EIRP (dBm)	EIRP(W)		
5	1	1	PI/2 BPSK	24.58	24.42	24.58	25.2	0.3311		
5	1	23		24.70	24.46	24.50				
5	12	6		24.60	24.48	24.53				
5	1	0		24.10	23.84	24.00				
5	1	24		24.16	23.88	24.04				
5	25	0		24.23	23.97	24.12				
5	1	1	QPSK	24.66	24.34	24.57			24.23	0.2649
5	1	23		24.67	24.41	24.55				
5	12	6		24.69	24.40	24.58				
5	1	0		23.63	23.45	23.51				
5	1	24		23.68	23.47	23.56				
5	25	0		23.64	23.47	23.57				
5	1	1	16-QAM	23.73	23.57	23.53	24.23	0.2649		
5	1	1	64-QAM	22.34	21.74	22.02				
5	1	1	256-QAM	19.97	20.05	19.89				
Limit	Power < 2W			Result			Pass			

NR n7 Maximum Average Power [dBm] (GT - LC = 0.5 dB)										
BW [MHz]	RB Size	RB Offset	Mod	Lowest	Middle	Highest	EIRP (dBm)	EIRP(W)		
10	1	1	PI/2 BPSK	24.50	24.42	24.50	25.08	0.3221		
10	1	50		24.58	24.48	24.48				
10	25	12		24.53	24.48	24.48				
10	1	0		23.94	24.15	24.02				
10	1	51		24.11	23.99	24.06				
10	50	0		24.04	23.96	24.00				
10	1	1	QPSK	24.52	24.42	24.47			24.16	0.2606
10	1	50		24.51	24.42	24.50				
10	25	12		24.49	24.41	24.55				
10	1	0		23.48	23.51	23.59				
10	1	51		23.63	23.38	23.49				
10	50	0		23.52	23.47	23.51				
10	1	1	16-QAM	23.66	23.56	23.60	24.16	0.2606		
10	1	1	64-QAM	21.70	22.04	22.10				
10	1	1	256-QAM	20.02	19.99	20.01				
Limit	Power < 2W			Result			Pass			



NR n7 Maximum Average Power [dBm] (GT - LC = 0.5 dB)										
BW [MHz]	RB Size	RB Offset	Mod	Lowest	Middle	Highest	EIRP (dBm)	EIRP(W)		
15	1	1	PI/2 BPSK	24.57	24.54	24.67	25.2	0.3311		
15	1	77		24.63	24.42	24.70				
15	36	18		24.61	24.46	24.66				
15	1	0		24.03	23.98	24.11				
15	1	78		24.10	23.99	24.20				
15	75	0		24.12	23.98	24.15				
15	1	1	QPSK	24.63	24.44	24.66			24.15	0.26
15	1	77		24.65	24.41	24.60				
15	36	18		24.61	24.48	24.66				
15	1	0		23.59	23.52	23.64				
15	1	78		23.68	23.48	23.68				
15	75	0		23.71	23.46	23.74				
15	1	1	16-QAM	23.65	23.59	23.64	24.15	0.26		
15	1	1	64-QAM	22.07	22.19	22.43				
15	1	1	256-QAM	20.34	19.77	20.15				
Limit	Power < 2W			Result			Pass			

NR n7 Maximum Average Power [dBm] (GT - LC = 0.5 dB)										
BW [MHz]	RB Size	RB Offset	Mod	Lowest	Middle	Highest	EIRP (dBm)	EIRP(W)		
20	1	1	PI/2 BPSK	24.58	24.58	24.57	25.26	0.3357		
20	1	104		24.69	24.48	24.61				
20	50	25		24.76	24.45	24.61				
20	1	0		24.14	24.11	24.02				
20	1	105		24.16	23.89	24.08				
20	100	0		24.21	23.97	24.15				
20	1	1	QPSK	24.65	24.53	24.58			24.2	0.263
20	1	104		24.71	24.43	24.64				
20	50	25		24.76	24.49	24.61				
20	1	0		23.64	23.56	23.60				
20	1	105		23.63	23.55	23.62				
20	100	0		23.68	23.45	23.61				
20	1	1	16-QAM	23.70	23.53	23.66	24.2	0.263		
20	1	1	64-QAM	22.08	21.96	22.19				
20	1	1	256-QAM	20.03	19.76	23.62				
Limit	Power < 2W			Result			Pass			



NR n7 Maximum Average Power [dBm] (GT - LC = 0.5 dB)										
BW [MHz]	RB Size	RB Offset	Mod	Lowest	Middle	Highest	EIRP (dBm)	EIRP(W)		
25	1	1	PI/2 BPSK	24.71	24.55	24.52	25.24	0.3342		
25	1	131		24.68	24.44	24.63				
25	64	32		24.74	24.50	24.55				
25	1	0		24.21	23.99	24.01				
25	1	132		24.13	24.00	24.15				
25	128	0		24.29	24.05	24.04				
25	1	1	QPSK	24.65	24.55	24.43			24.25	0.2661
25	1	131		24.68	24.52	24.57				
25	64	32		24.73	24.51	24.57				
25	1	0		23.75	23.63	23.57				
25	1	132		23.69	23.62	23.67				
25	128	0		23.75	23.52	23.56				
25	1	1	16-QAM	23.75	23.43	23.46	24.25	0.2661		
25	1	1	64-QAM	22.33	22.01	21.98				
25	1	1	256-QAM	20.26	20.19	20.06				
Limit	Power < 2W			Result			Pass			

NR n7 Maximum Average Power [dBm] (GT - LC = 0.5 dB)										
BW [MHz]	RB Size	RB Offset	Mod	Lowest	Middle	Highest	EIRP (dBm)	EIRP(W)		
30	1	1	PI/2 BPSK	24.61	24.57	24.47	25.14	0.3266		
30	1	158		24.61	24.49	24.57				
30	80	40		24.62	24.46	24.51				
30	1	0		24.12	24.13	24.07				
30	1	159		24.10	24.01	24.11				
30	160	0		24.18	23.96	24.04				
30	1	1	QPSK	24.59	24.60	24.59			24.1	0.257
30	1	158		24.60	24.43	24.64				
30	80	40		24.59	24.52	24.49				
30	1	0		23.60	23.60	23.56				
30	1	159		23.62	23.54	23.62				
30	160	0		23.59	23.48	23.49				
30	1	1	16-QAM	23.47	23.51	23.60	24.1	0.257		
30	1	1	64-QAM	22.12	22.11	21.99				
30	1	1	256-QAM	19.87	20.13	19.62				
Limit	Power < 2W			Result			Pass			



NR n7 Maximum Average Power [dBm] (GT - LC = 0.5 dB)										
BW [MHz]	RB Size	RB Offset	Mod	Lowest	Middle	Highest	EIRP (dBm)	EIRP(W)		
40	1	1	PI/2 BPSK	24.76	24.76	24.75	25.28	0.3373		
40	1	214		24.67	24.61	24.74				
40	108	54		24.64	24.52	24.56				
40	1	0		24.29	24.28	24.28				
40	1	215		24.24	24.15	24.16				
40	216	0		24.20	24.03	24.02				
40	1	1	QPSK	24.76	24.71	24.78			24.47	0.2799
40	1	214		24.69	24.59	24.76				
40	108	54		24.68	24.61	24.64				
40	1	0		23.87	23.77	23.62				
40	1	215		23.59	23.72	23.73				
40	216	0		23.75	23.53	23.69				
40	1	1	16-QAM	23.84	23.97	23.90	24.47	0.2799		
40	1	1	64-QAM	22.20	22.48	22.37				
40	1	1	256-QAM	20.35	20.79	20.17				
Limit	Power < 2W			Result			Pass			

NR n7 Maximum Average Power [dBm] (GT - LC = 0.5 dB)										
BW [MHz]	RB Size	RB Offset	Mod	Lowest	Middle	Highest	EIRP (dBm)	EIRP(W)		
50	1	1	PI/2 BPSK	24.79	24.84	24.72	25.38	0.3451		
50	1	268		24.73	24.69	24.77				
50	135	67		24.60	24.52	24.53				
50	1	0		24.38	24.35	24.34				
50	1	269		24.25	24.23	24.29				
50	270	0		24.09	24.08	24.04				
50	1	1	QPSK	24.85	24.88	24.74			24.37	0.2735
50	1	268		24.70	24.75	24.79				
50	135	67		24.66	24.54	24.55				
50	1	0		23.87	23.89	23.82				
50	1	269		23.83	23.78	23.79				
50	270	0		23.68	23.67	23.56				
50	1	1	16-QAM	23.83	23.87	23.73	24.37	0.2735		
50	1	1	64-QAM	22.30	22.33	22.44				
50	1	1	256-QAM	20.36	20.43	20.12				
Limit	Power < 2W			Result			Pass			



NR n66 Maximum Average Power [dBm] (GT - LC = -0.5 dB)										
BW [MHz]	RB Size	RB Offset	Mod	Lowest	Middle	Highest	EIRP (dBm)	EIRP(W)		
5	1	1	PI/2 BPSK	24.68	24.72	24.65	24.33	0.2710		
5	1	23		24.75	24.74	24.54				
5	12	6		24.71	24.79	24.58				
5	1	0		24.12	24.24	24.13				
5	1	24		24.25	24.16	24.05				
5	25	0		24.28	24.22	24.05				
5	1	1	QPSK	24.70	24.75	24.60			23.28	0.2128
5	1	23		24.83	24.72	24.54				
5	12	6		24.77	24.69	24.55				
5	1	0		23.78	23.69	23.59				
5	1	24		23.72	23.75	23.55				
5	25	0		23.70	23.69	23.59				
5	1	1	16-QAM	23.62	23.78	23.58	23.28	0.2128		
5	1	1	64-QAM	22.20	22.29	22.04				
5	1	1	256-QAM	20.15	20.03	20.03				
Limit	EIRP < 1W			Result			Pass			

NR n66 Maximum Average Power [dBm] (GT - LC = -0.5 dB)										
BW [MHz]	RB Size	RB Offset	Mod	Lowest	Middle	Highest	EIRP (dBm)	EIRP(W)		
10	1	1	PI/2 BPSK	24.77	24.76	24.76	24.36	0.2729		
10	1	50		24.74	24.75	24.61				
10	25	12		24.80	24.70	24.76				
10	1	0		24.26	24.25	24.10				
10	1	51		24.24	24.23	24.10				
10	50	0		24.36	24.20	24.20				
10	1	1	QPSK	24.85	24.73	24.83			23.46	0.2218
10	1	50		24.77	24.67	24.65				
10	25	12		24.85	24.77	24.86				
10	1	0		23.80	23.71	23.80				
10	1	51		23.82	23.76	23.62				
10	50	0		23.89	23.70	23.77				
10	1	1	16-QAM	23.86	23.84	23.96	23.46	0.2218		
10	1	1	64-QAM	22.38	22.15	22.20				
10	1	1	256-QAM	20.32	20.18	20.13				
Limit	EIRP < 1W			Result			Pass			



NR n66 Maximum Average Power [dBm] (GT - LC = -0.5 dB)										
BW [MHz]	RB Size	RB Offset	Mod	Lowest	Middle	Highest	EIRP (dBm)	EIRP(W)		
15	1	1	PI/2 BPSK	24.85	24.70	24.68	24.39	0.2748		
15	1	77		24.68	24.70	24.50				
15	36	18		24.83	24.79	24.65				
15	1	0		24.32	24.22	24.19				
15	1	78		24.21	24.20	23.97				
15	75	0		24.29	24.23	24.12				
15	1	1	QPSK	24.84	24.76	24.69			23.35	0.2163
15	1	77		24.70	24.74	24.47				
15	36	18		24.89	24.79	24.58				
15	1	0		23.93	23.73	23.68				
15	1	78		23.68	23.68	23.40				
15	75	0		23.82	23.73	23.66				
15	1	1	16-QAM	23.85	23.70	23.67	23.35	0.2163		
15	1	1	64-QAM	22.34	22.22	22.26				
15	1	1	256-QAM	20.24	20.30	20.08				
Limit	EIRP < 1W			Result			Pass			

NR n66 Maximum Average Power [dBm] (GT - LC = -0.5 dB)										
BW [MHz]	RB Size	RB Offset	Mod	Lowest	Middle	Highest	EIRP (dBm)	EIRP(W)		
20	1	1	PI/2 BPSK	24.80	24.74	24.64	24.35	0.2723		
20	1	104		24.73	24.70	24.42				
20	50	25		24.85	24.73	24.60				
20	1	0		24.33	24.23	24.13				
20	1	105		24.17	24.28	23.90				
20	100	0		24.29	24.31	24.11				
20	1	1	QPSK	24.80	24.69	24.73			23.35	0.2163
20	1	104		24.76	24.73	24.40				
20	50	25		24.83	24.73	24.65				
20	1	0		23.82	23.75	23.69				
20	1	105		23.66	23.64	23.51				
20	100	0		23.81	23.73	23.66				
20	1	1	16-QAM	23.85	23.80	23.71	23.35	0.2163		
20	1	1	64-QAM	22.27	22.12	22.35				
20	1	1	256-QAM	20.24	20.19	20.01				
Limit	EIRP < 1W			Result			Pass			



NR n66 Maximum Average Power [dBm] (GT - LC = -0.5 dB)										
BW [MHz]	RB Size	RB Offset	Mod	Lowest	Middle	Highest	EIRP (dBm)	EIRP(W)		
25	1	1	PI/2 BPSK	24.76	24.78	24.88	24.38	0.2742		
25	1	131		24.58	24.73	24.61				
25	64	32		24.70	24.81	24.82				
25	1	0		24.26	24.23	24.22				
25	1	132		24.08	24.26	24.10				
25	128	0		24.18	24.19	24.23				
25	1	1	QPSK	24.76	24.75	24.79			23.41	0.2193
25	1	131		24.69	24.78	24.60				
25	64	32		24.77	24.72	24.82				
25	1	0		23.75	23.75	23.78				
25	1	132		23.62	23.64	23.64				
25	128	0		23.75	23.74	23.80				
25	1	1	16-QAM	23.91	23.54	23.82	23.41	0.2193		
25	1	1	64-QAM	22.43	22.40	22.36				
25	1	1	256-QAM	20.15	20.12	20.19				
Limit	EIRP < 1W			Result			Pass			

NR n66 Maximum Average Power [dBm] (GT - LC = -0.5 dB)										
BW [MHz]	RB Size	RB Offset	Mod	Lowest	Middle	Highest	EIRP (dBm)	EIRP(W)		
30	1	1	PI/2 BPSK	24.90	24.72	24.91	24.46	0.2793		
30	1	158		24.71	24.64	24.57				
30	80	40		24.84	24.77	24.96				
30	1	0		24.30	24.29	24.25				
30	1	159		24.13	24.19	24.02				
30	160	0		24.28	24.19	24.34				
30	1	1	QPSK	24.88	24.79	24.94			23.45	0.2213
30	1	158		24.68	24.63	24.59				
30	80	40		24.81	24.80	24.88				
30	1	0		23.86	23.78	23.81				
30	1	159		23.65	23.67	23.54				
30	160	0		23.78	23.70	23.81				
30	1	1	16-QAM	23.95	23.85	23.89	23.45	0.2213		
30	1	1	64-QAM	22.43	22.32	22.41				
30	1	1	256-QAM	20.65	20.38	20.29				
Limit	EIRP < 1W			Result			Pass			



NR n66 Maximum Average Power [dBm] (GT - LC = -0.5 dB)										
BW [MHz]	RB Size	RB Offset	Mod	Lowest	Middle	Highest	EIRP (dBm)	EIRP(W)		
40	1	1	PI/2 BPSK	24.82	24.76	24.71	24.37	0.2735		
40	1	214		24.61	24.58	24.50				
40	108	54		24.74	24.81	24.86				
40	1	0		24.22	24.24	24.15				
40	1	215		24.05	24.07	23.98				
40	216	0		24.25	24.20	24.17				
40	1	1	QPSK	24.76	24.83	24.69			24.37	0.2735
40	1	214		24.58	24.69	24.49				
40	108	54		24.77	24.79	24.87				
40	1	0		23.83	23.74	23.72				
40	1	215		23.60	23.68	23.42				
40	216	0		23.64	23.69	23.75				
40	1	1	16-QAM	23.93	23.56	23.83	23.43	0.2203		
40	1	1	64-QAM	22.36	22.52	22.07				
40	1	1	256-QAM	20.11	20.07	20.03				
Limit	EIRP < 1W			Result			Pass			



NR n71 Maximum Average Power [dBm] (GT - LC = -5.2 dB)										
BW [MHz]	RB Size	RB Offset	Mod	Lowest	Middle	Highest	ERP (dBm)	ERP(W)		
5	1	1	PI/2 BPSK	24.95	24.67	24.75	17.61	0.0577		
5	1	23		24.96	24.70	24.86				
5	12	6		24.86	24.70	24.88				
5	1	0		24.37	24.24	24.33				
5	1	24		24.34	24.27	24.37				
5	25	0		24.39	24.24	24.38				
5	1	1	QPSK	24.81	24.70	24.83			16.66	0.0463
5	1	23		24.92	24.72	24.89				
5	12	6		24.92	24.72	24.86				
5	1	0		23.86	23.67	23.82				
5	1	24		23.90	23.76	23.92				
5	25	0		23.93	23.77	23.93				
5	1	1	16-QAM	23.78	24.01	23.91	16.66	0.0463		
5	1	1	64-QAM	21.67	21.29	21.44				
5	1	1	256-QAM	20.47	20.26	20.29				
Limit	ERP < 3W			Result			Pass			

NR n71 Maximum Average Power [dBm] (GT - LC = -5.2 dB)										
BW [MHz]	RB Size	RB Offset	Mod	Lowest	Middle	Highest	ERP (dBm)	ERP(W)		
10	1	1	PI/2 BPSK	24.86	24.64	24.69	17.54	0.0568		
10	1	50		24.78	24.67	24.72				
10	25	12		24.89	24.82	24.71				
10	1	0		24.39	24.23	24.15				
10	1	51		24.37	24.17	24.27				
10	50	0		24.35	24.25	24.25				
10	1	1	QPSK	24.86	24.67	24.68			16.59	0.0456
10	1	50		24.80	24.65	24.78				
10	25	12		24.85	24.72	24.71				
10	1	0		23.94	23.68	23.70				
10	1	51		23.78	23.69	23.89				
10	50	0		23.93	23.78	23.75				
10	1	1	16-QAM	23.94	23.86	23.65	16.59	0.0456		
10	1	1	64-QAM	21.53	21.37	21.39				
10	1	1	256-QAM	20.46	20.27	20.30				
Limit	ERP < 3W			Result			Pass			



NR n71 Maximum Average Power [dBm] (GT - LC = -5.2 dB)										
BW [MHz]	RB Size	RB Offset	Mod	Lowest	Middle	Highest	ERP (dBm)	ERP(W)		
15	1	1	PI/2 BPSK	24.79	24.64	24.73	17.54	0.0568		
15	1	77		24.73	24.70	24.85				
15	36	18		24.83	24.66	24.74				
15	1	0		24.37	24.21	24.23				
15	1	78		24.31	24.24	24.35				
15	75	0		24.30	24.30	24.26				
15	1	1	QPSK	24.80	24.64	24.68			16.65	0.0462
15	1	77		24.74	24.74	24.89				
15	36	18		24.78	24.75	24.71				
15	1	0		23.84	23.76	23.77				
15	1	78		23.72	23.69	23.83				
15	75	0		23.78	23.72	23.78				
15	1	1	16-QAM	23.90	24.00	23.67	16.65	0.0462		
15	1	1	64-QAM	21.40	21.61	21.37				
15	1	1	256-QAM	20.45	20.32	20.15				
Limit	ERP < 3W			Result			Pass			

NR n71 Maximum Average Power [dBm] (GT - LC = -5.2 dB)										
BW [MHz]	RB Size	RB Offset	Mod	Lowest	Middle	Highest	ERP (dBm)	ERP(W)		
20	1	1	PI/2 BPSK	24.68	24.78	24.73	17.51	0.0564		
20	1	104		24.73	24.69	24.86				
20	50	25		24.76	24.69	24.77				
20	1	0		24.28	24.29	24.17				
20	1	105		24.19	24.22	24.36				
20	100	0		24.26	24.21	24.25				
20	1	1	QPSK	24.78	24.77	24.75			16.56	0.0453
20	1	104		24.70	24.67	24.81				
20	50	25		24.67	24.77	24.75				
20	1	0		23.75	23.74	23.72				
20	1	105		23.74	23.81	23.97				
20	100	0		23.69	23.73	23.77				
20	1	1	16-QAM	23.91	23.72	23.72	16.56	0.0453		
20	1	1	64-QAM	21.47	21.28	21.35				
20	1	1	256-QAM	20.49	20.39	20.21				
Limit	ERP < 3W			Result			Pass			



FR1 n2

Peak-to-Average Ratio

Mode	FR1 n2 / 20MHz / DFT-S OFDM				
Mod.	PI/2 BPSK	QPSK	16QAM	64QAM	Limit: 13dB
RB Size	Full RB	Full RB	Full RB	Full RB	Result
Middle CH	4.70	5.78	6.50	6.98	PASS
Mode	FR1 n2 / 20MHz / DFT-S OFDM				
Mod.	256QAM				Limit: 13dB
RB Size	Full RB				Result
Middle CH	6.70				PASS



FR1 n2 / 20MHz / DFT-S OFDM / Middle Channel / Full RB

PI/2 BPSK

QPSK

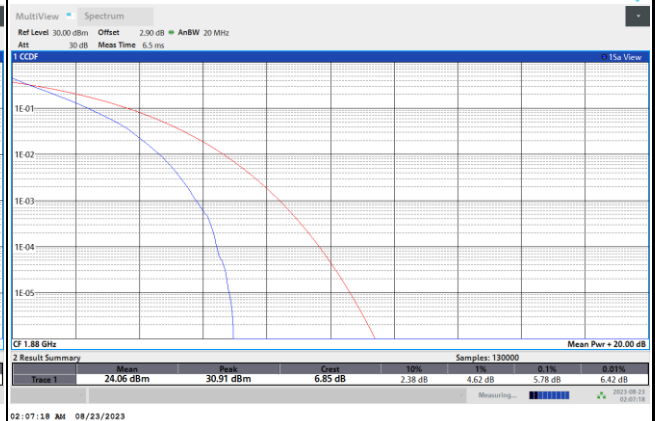
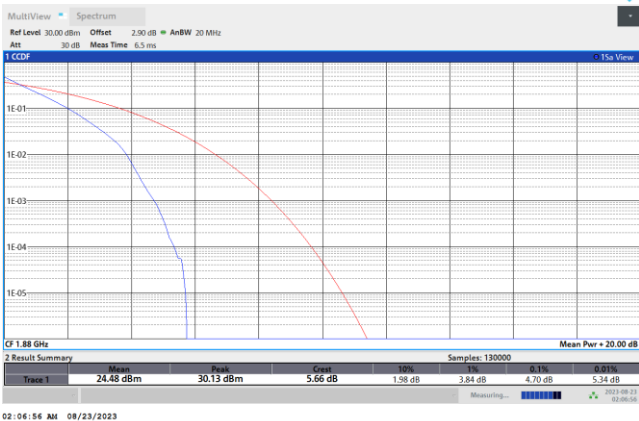

16QAM

64QAM

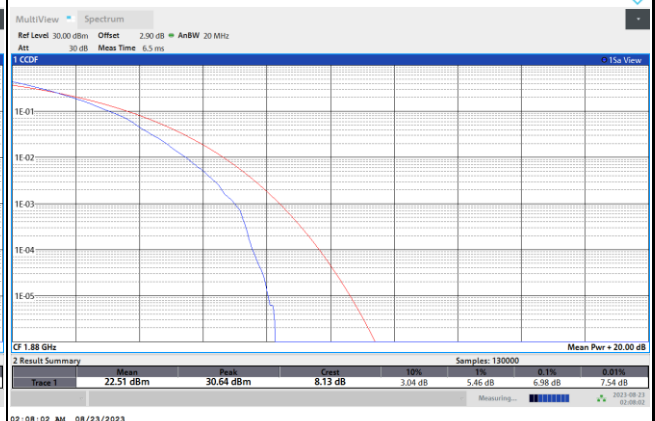
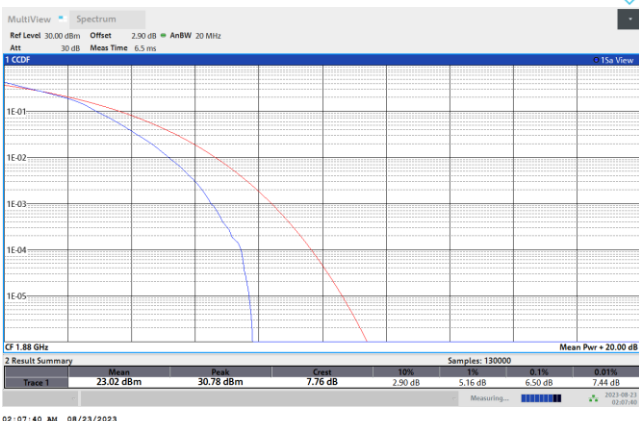

256QAM

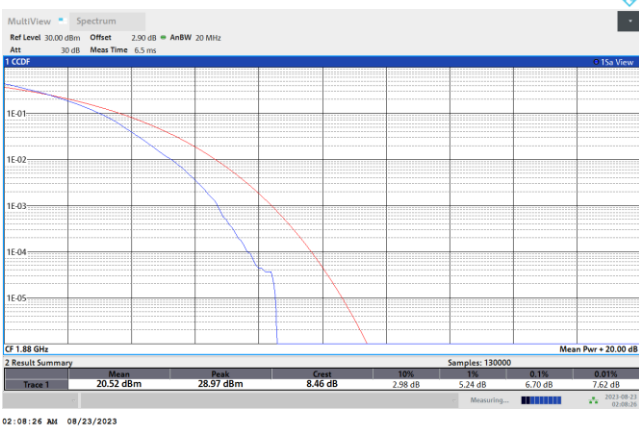



26dB Bandwidth

Mode	FR1 n2 : 26dB BW(MHz) / DFT-S OFDM							
BW	5MHz		10MHz		15MHz		20MHz	
Mod.	PI/2 BPSK		PI/2 BPSK		PI/2 BPSK		PI/2 BPSK	
Middle CH	5.25		9.85		14.66		19.22	

Mode	FR1 n2 : 26dB BW(MHz) / CP OFDM							
BW	5MHz		10MHz		15MHz		20MHz	
Mod.	QPSK	16QAM	QPSK	16QAM	QPSK	16QAM	QPSK	16QAM
Middle CH	5.37	5.52	10.45	10.37	15.44	15.52	20.86	20.98
Mod.	64QAM	256QAM	64QAM	256QAM	64QAM	256QAM	64QAM	256QAM
Middle CH	5.38	5.38	10.27	10.23	15.38	15.41	20.98	21.26



FR1 n2 / 5MHz / DFT-S OFDM / Middle Channel / Full RB

PI/2 BPSK

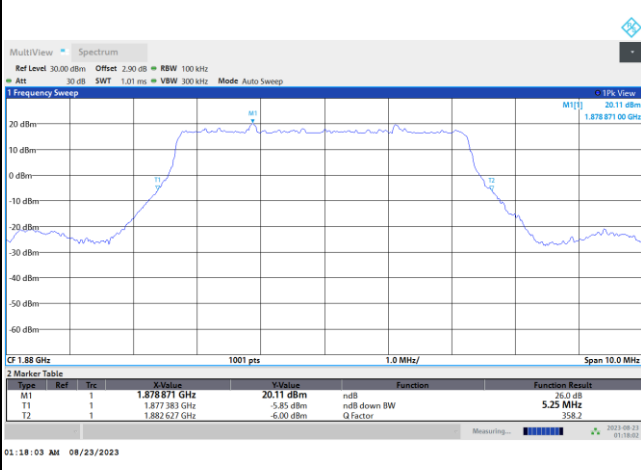

FR1 n2 / 5MHz / CP OFDM / Middle Channel / Full RB

QPSK

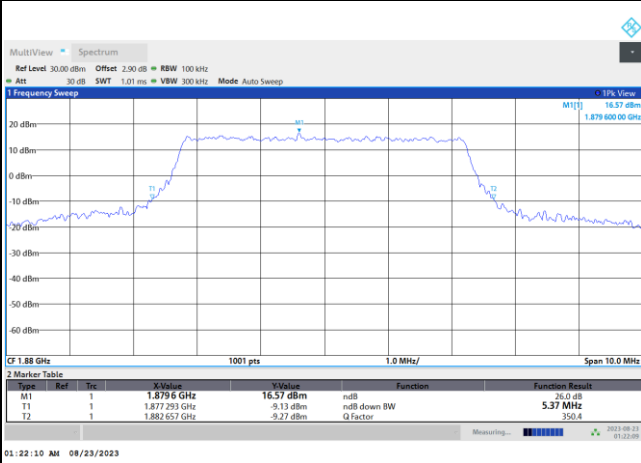

16QAM

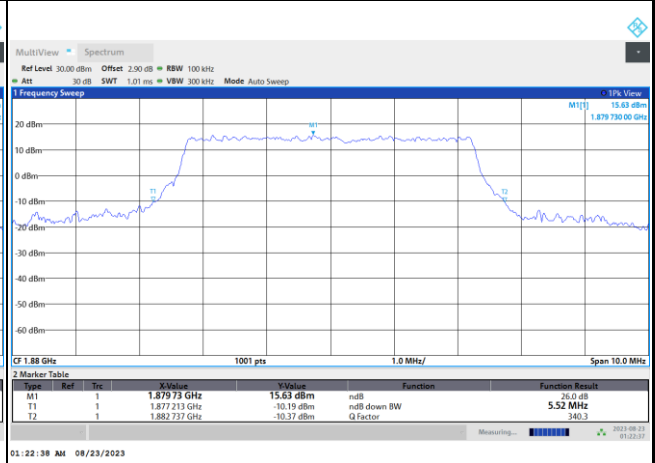

64QAM

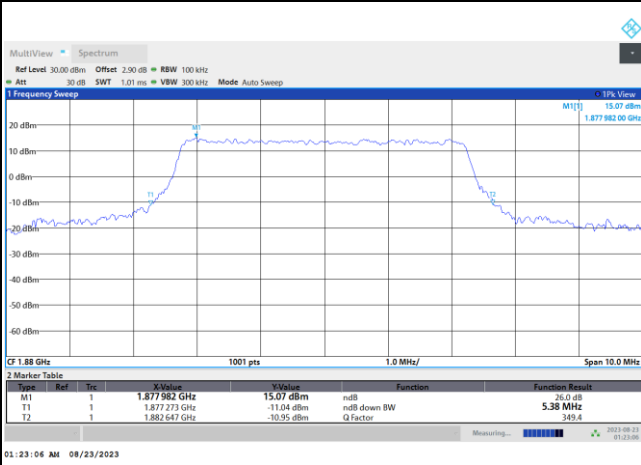

256QAM

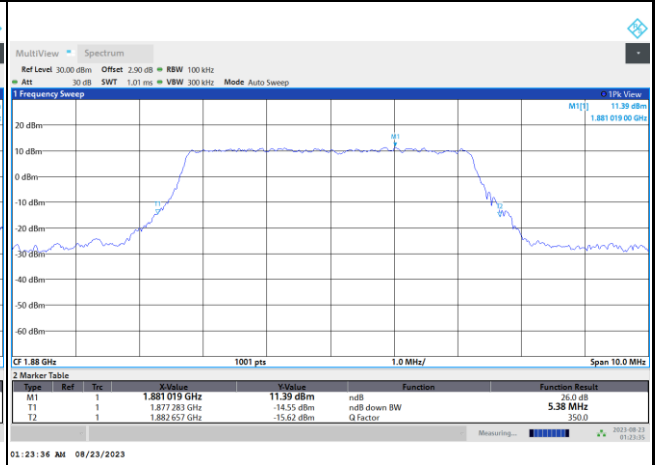



FR1 n2 / 10MHz / DFT-S OFDM / Middle Channel / Full RB

PI/2 BPSK

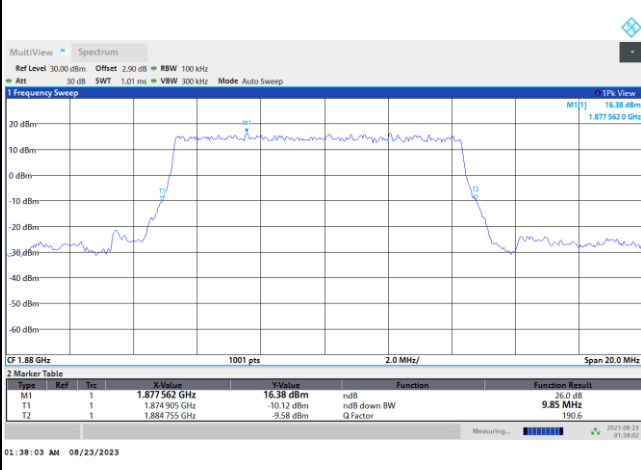

FR1 n2 / 10MHz / CP OFDM / Middle Channel / Full RB

QPSK

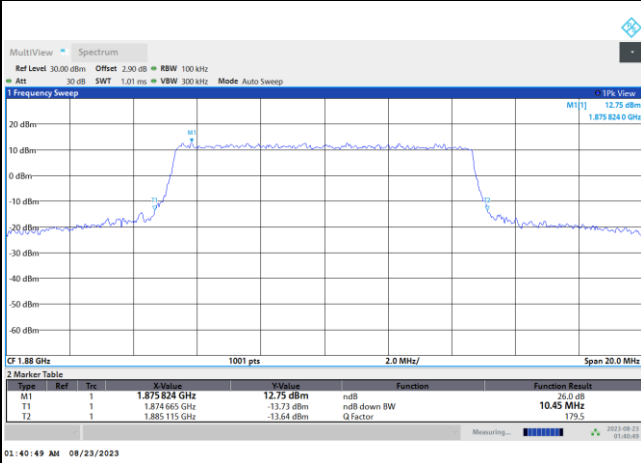

16QAM

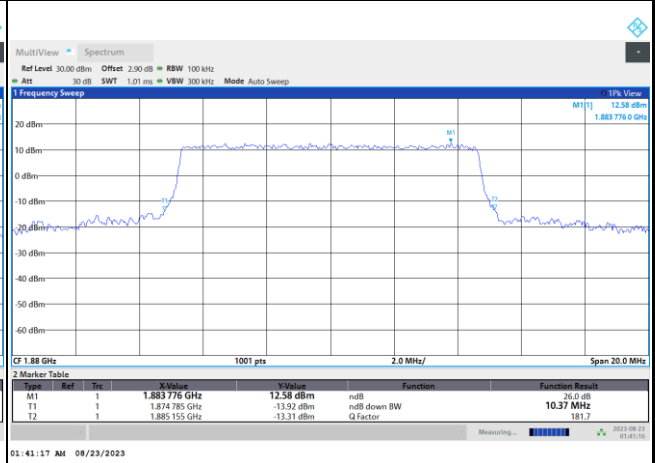

64QAM

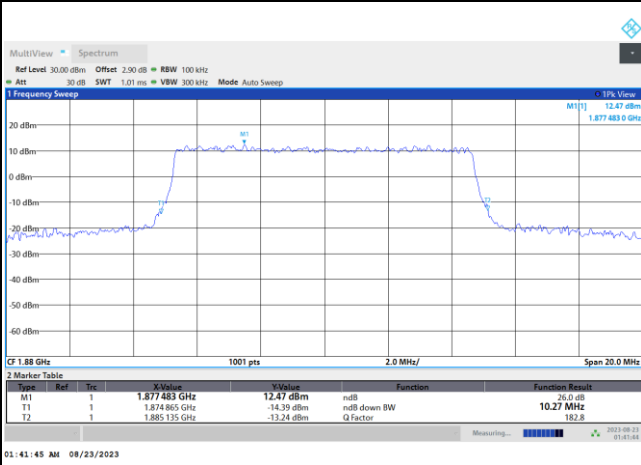

256QAM

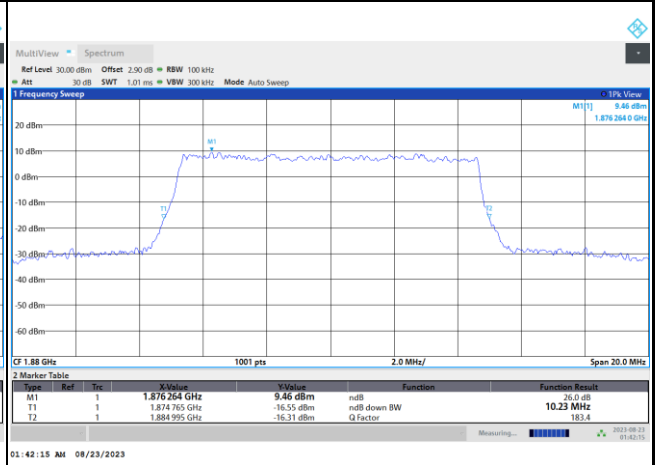



FR1 n2 / 15MHz / DFT-S OFDM / Middle Channel / Full RB

PI/2 BPSK

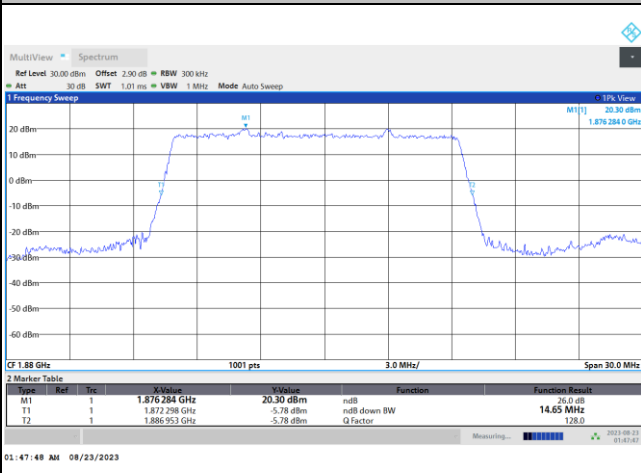

FR1 n2 / 15MHz / CP OFDM / Middle Channel / Full RB

QPSK

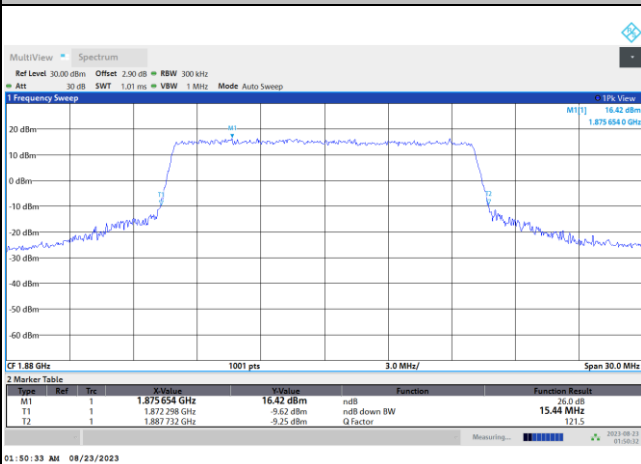

16QAM

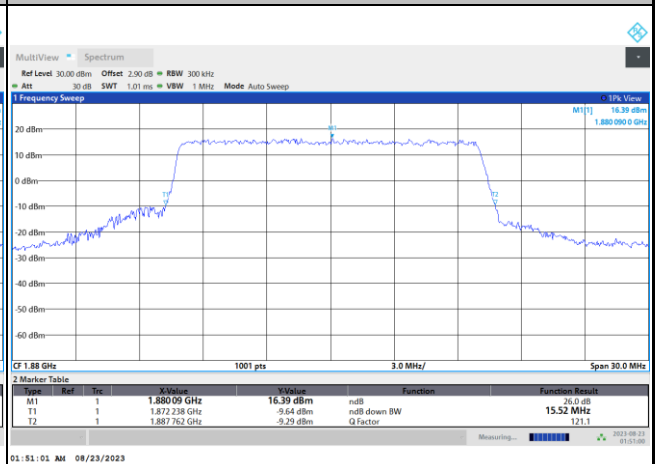

64QAM

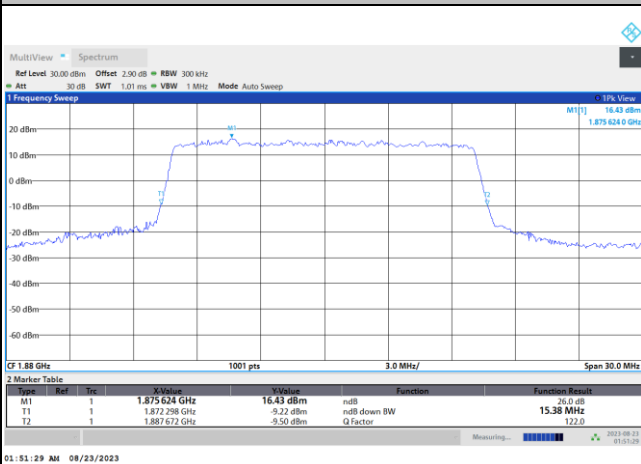

256QAM

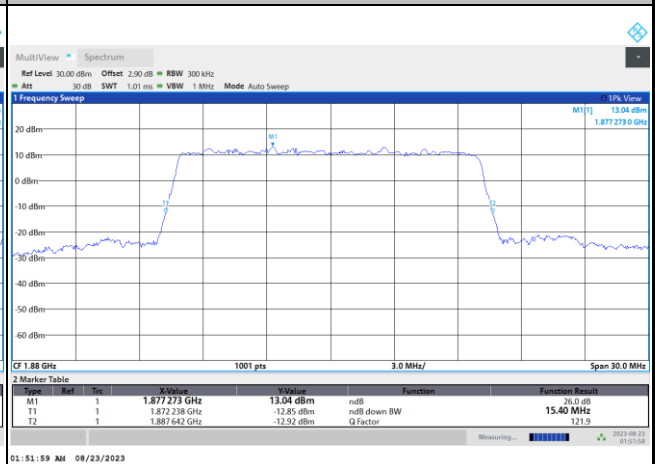



FR1 n2 / 20MHz / DFT-S OFDM / Middle Channel / Full RB

PI/2 BPSK

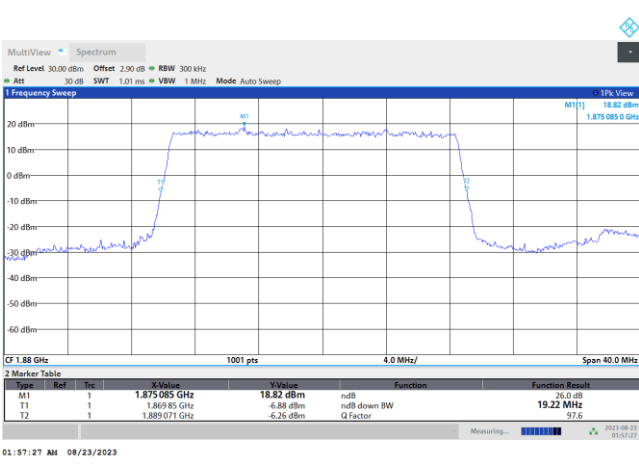

FR1 n2 / 20MHz / CP OFDM / Middle Channel / Full RB

QPSK

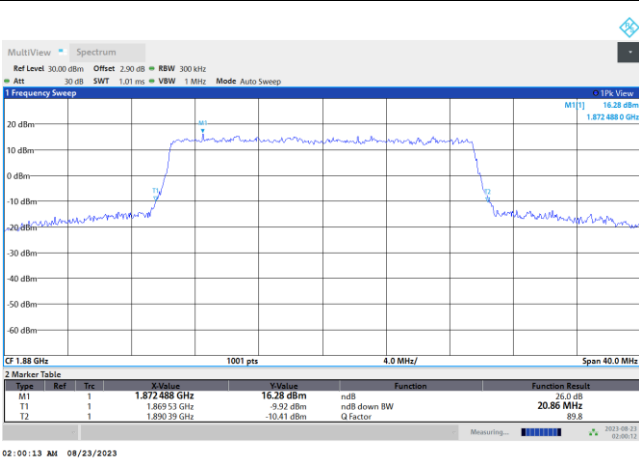

16QAM

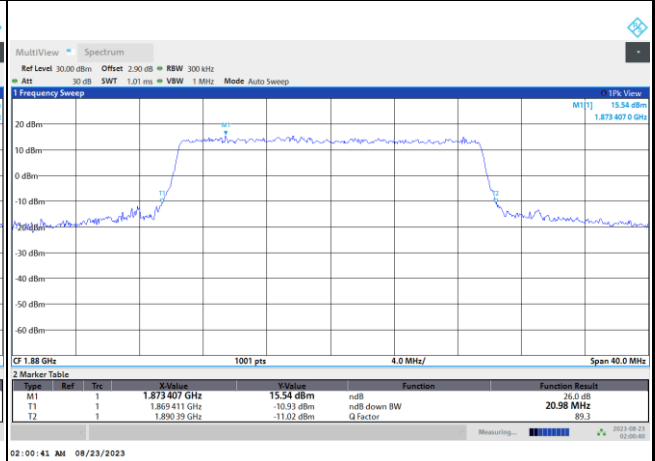

64QAM

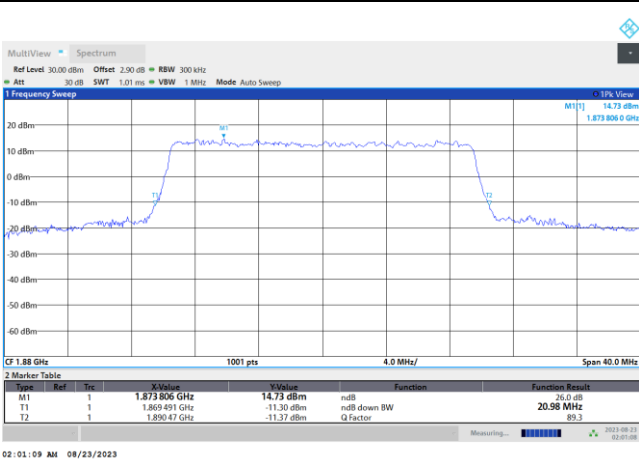

256QAM

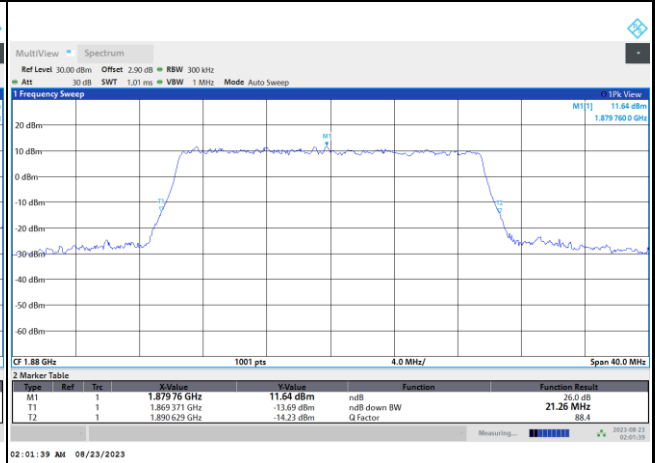



Occupied Bandwidth

Mode	FR1 n2 : 99%OBW(MHz) / DFT-S OFDM							
BW	5MHz		10MHz		15MHz		20MHz	
Mod.	PI/2 BPSK		PI/2 BPSK		PI/2 BPSK		PI/2 BPSK	
Middle CH	4.55		8.96		13.48		17.93	

Mode	FR1 n2 : 99%OBW (MHz) / CP OFDM							
BW	5MHz		10MHz		15MHz		20MHz	
Mod.	QPSK	16QAM	QPSK	16QAM	QPSK	16QAM	QPSK	16QAM
Middle CH	4.51	4.52	9.29	9.29	14.15	14.17	19.00	18.97
Mod.	64QAM	256QAM	64QAM	256QAM	64QAM	256QAM	64QAM	256QAM
Middle CH	4.53	4.54	9.31	9.32	14.17	14.15	18.99	19.01



FR1 n2 / 5MHz / DFT-S OFDM / Middle Channel / Full RB

PI/2 BPSK

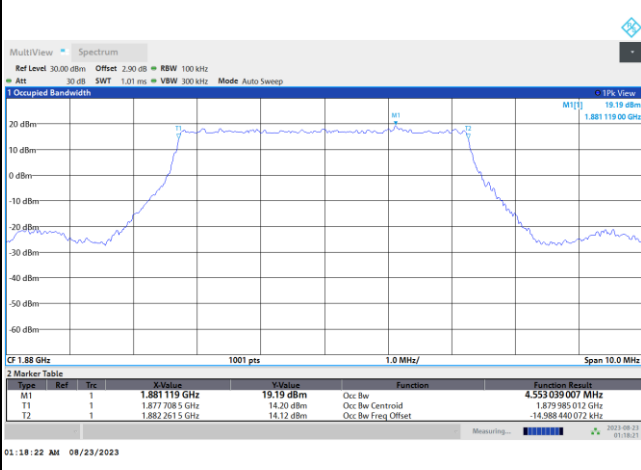

FR1 n2 / 5MHz / CP OFDM / Middle Channel / Full RB

QPSK

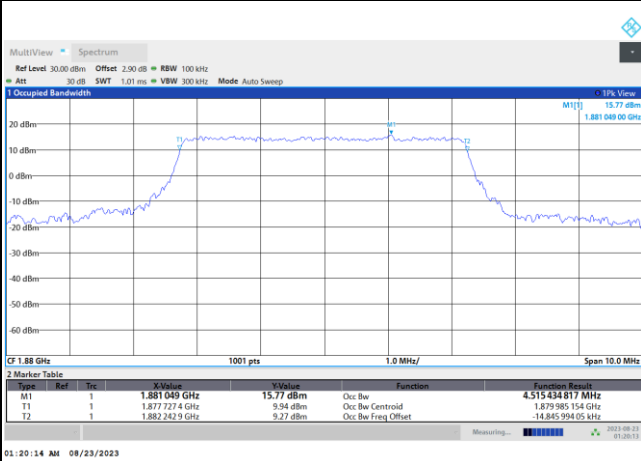

16QAM

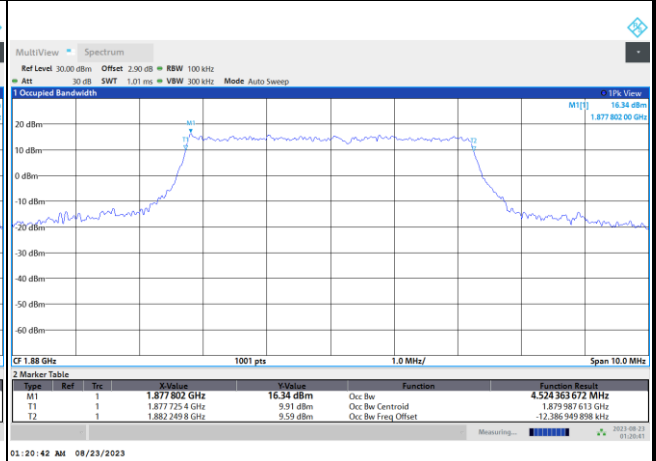

64QAM

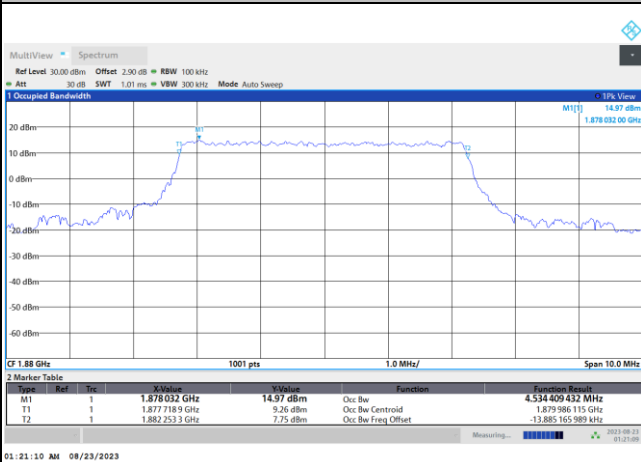

256QAM

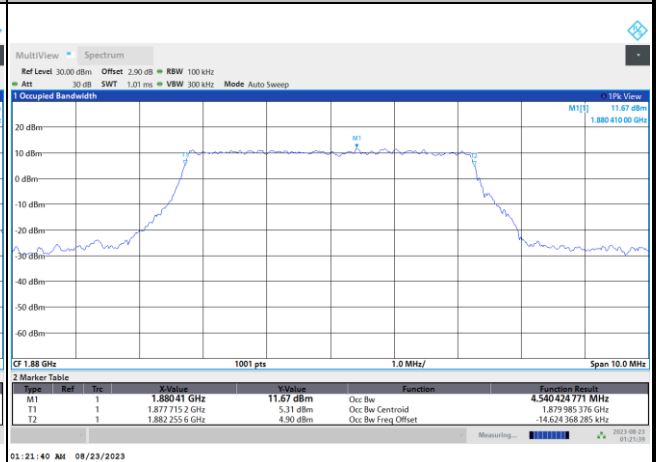



FR1 n2 / 10MHz / DFT-S OFDM / Middle Channel / Full RB

PI/2 BPSK

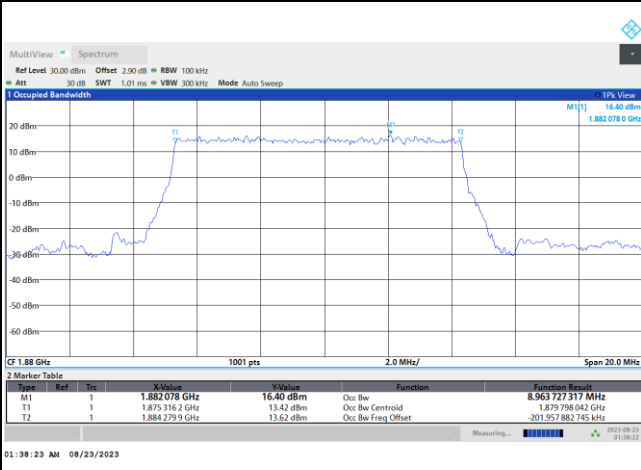

FR1 n2 / 10MHz / CP OFDM / Middle Channel / Full RB

QPSK

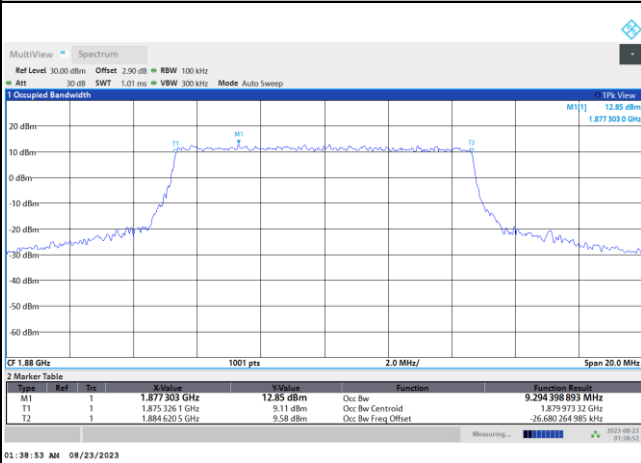

16QAM

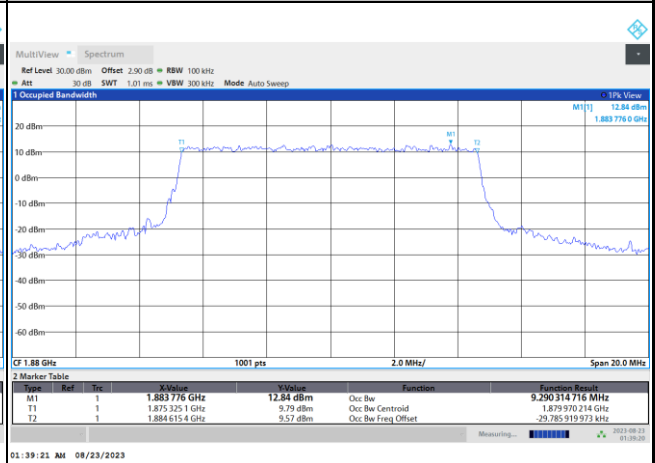

64QAM

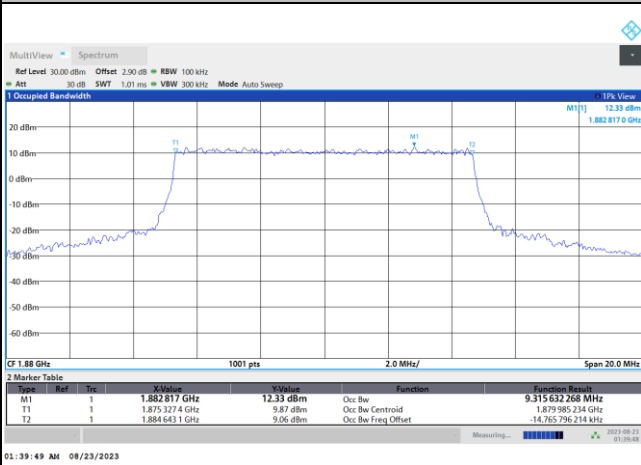

256QAM

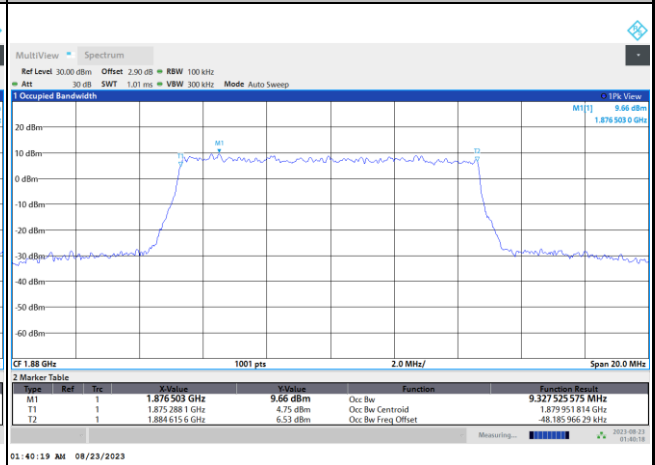



FR1 n2 / 15MHz / DFT-S OFDM / Middle Channel / Full RB

PI/2 BPSK

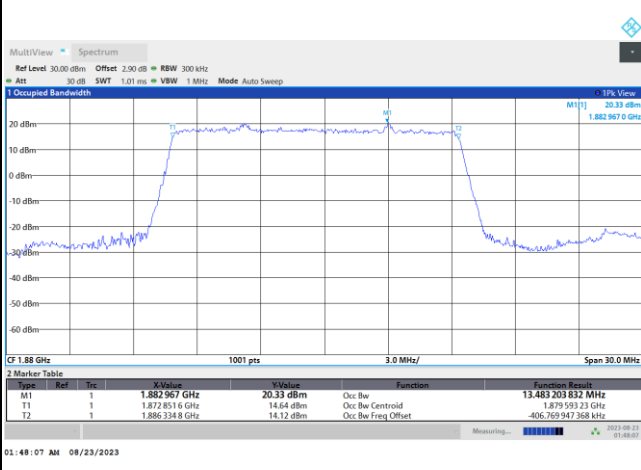

FR1 n2 / 15MHz / CP OFDM / Middle Channel / Full RB

QPSK

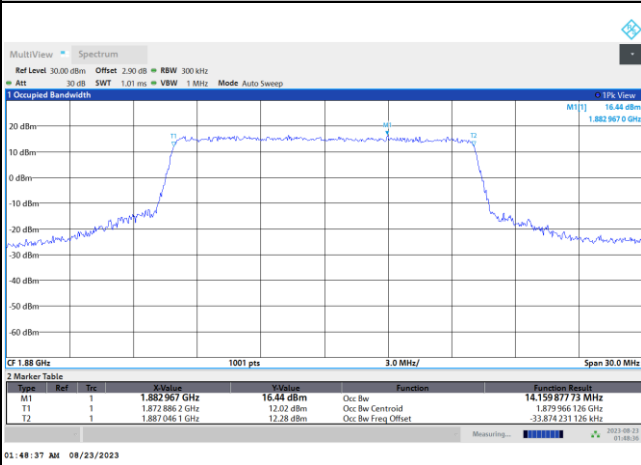

16QAM

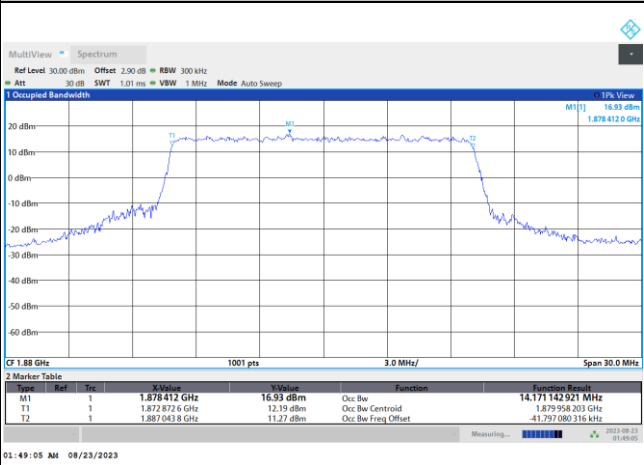

64QAM

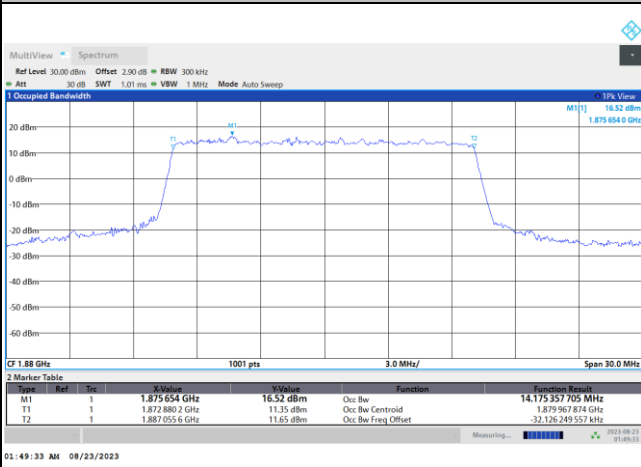

256QAM

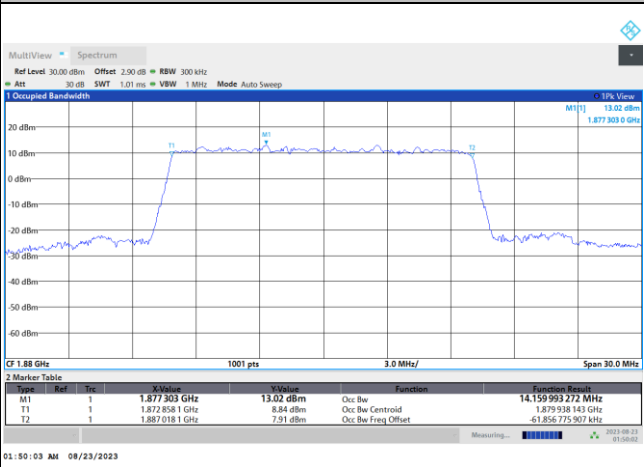



FR1 n2 / 20MHz / DFT-S OFDM / Middle Channel / Full RB

PI/2 BPSK

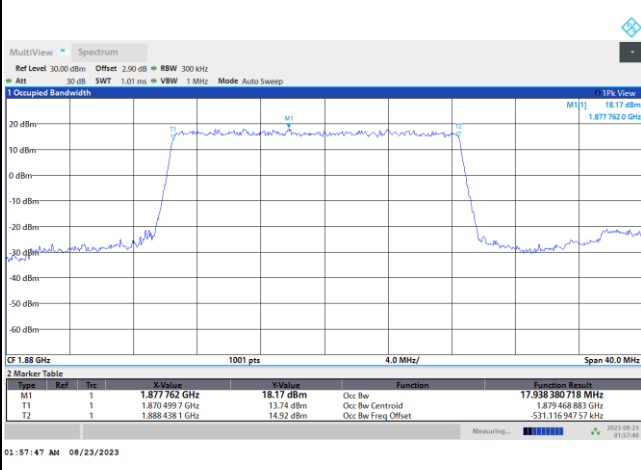

FR1 n2 / 20MHz / CP OFDM / Middle Channel / Full RB

QPSK

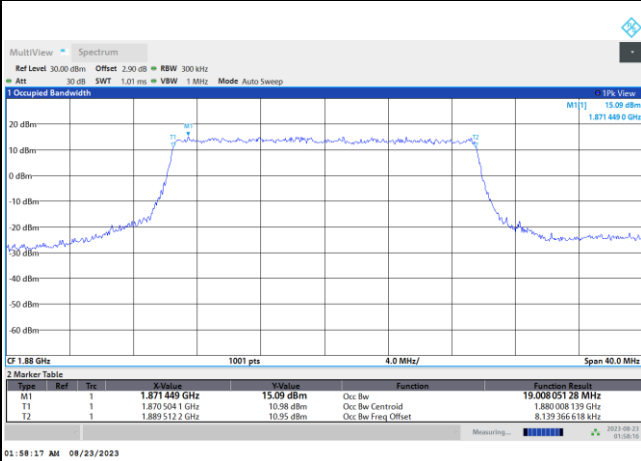

16QAM

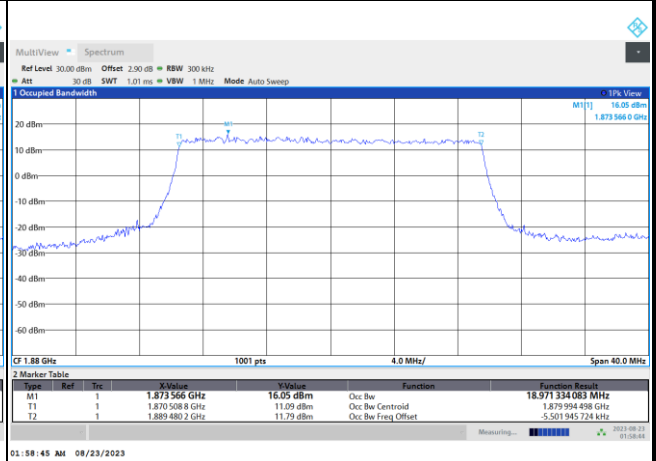

64QAM

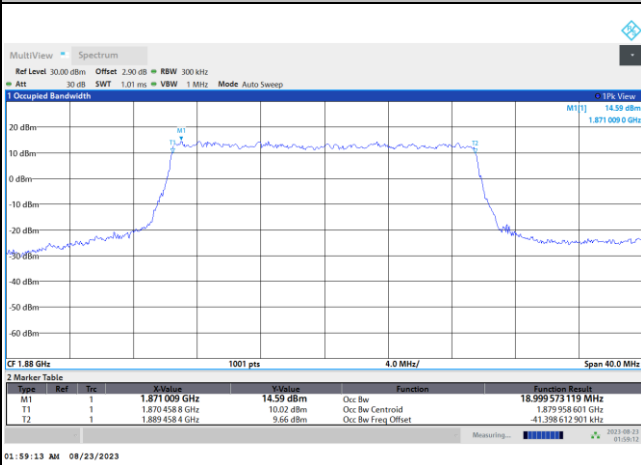

256QAM

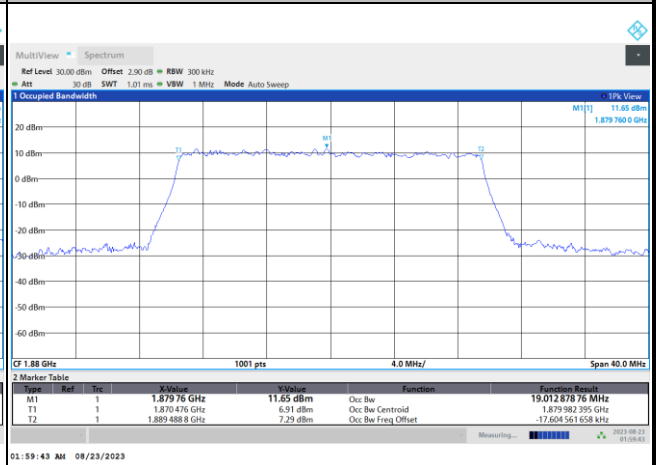



Conducted Band Edge

FR1 n2 / 5MHz / DFT-S OFDM / PI/2 BPSK

Lowest Band Edge / 1RB0

Highest Band Edge / 1RBmax

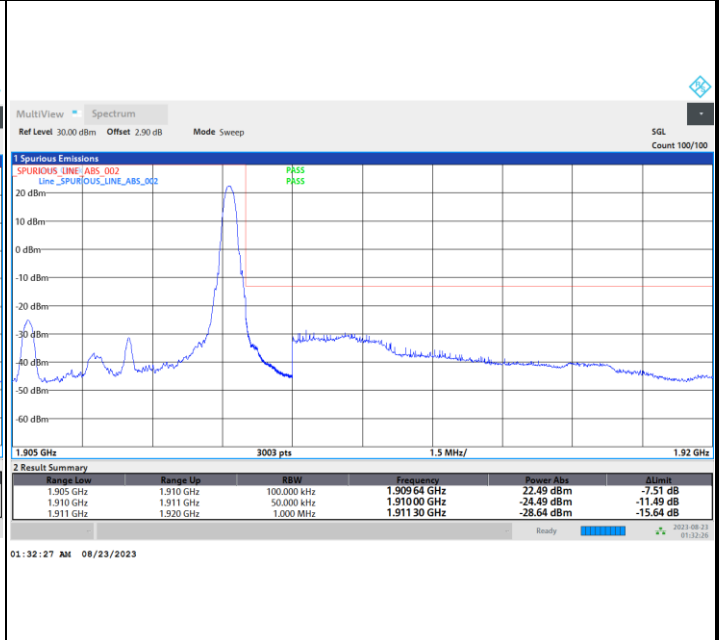
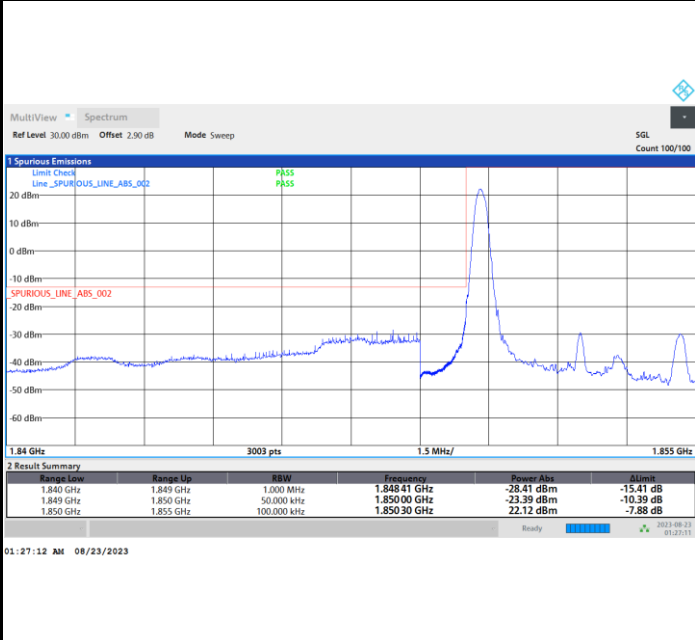

Lowest Band Edge / Full RB

Highest Band Edge / Full RB

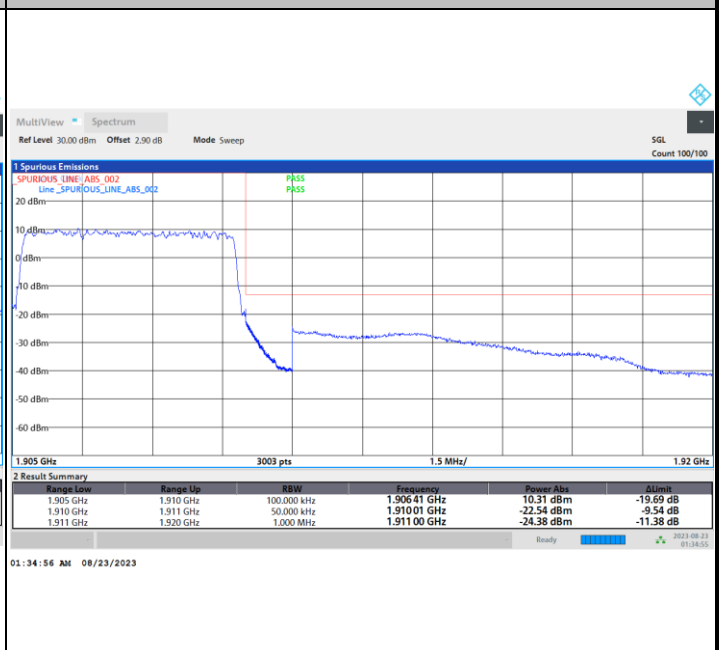
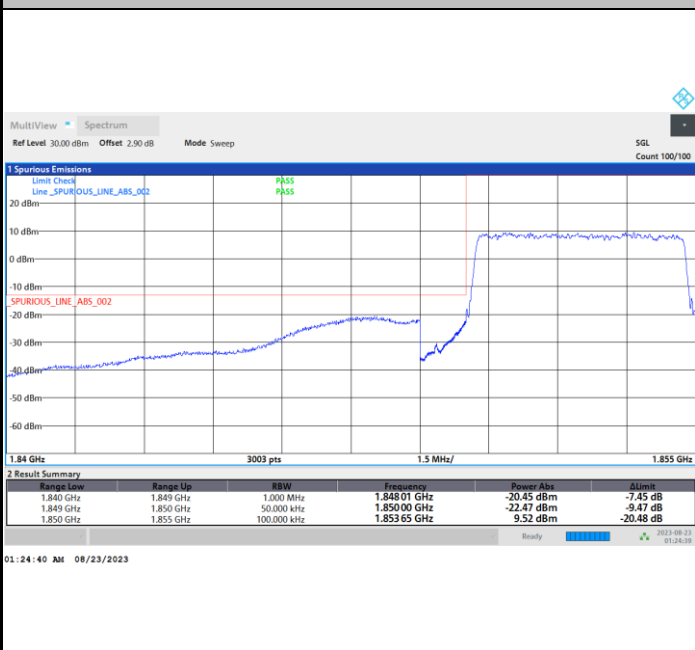



FR1 n2 / 5MHz / DFT-S OFDM / QPSK

Lowest Band Edge / 1RB0

Highest Band Edge / 1RBmax

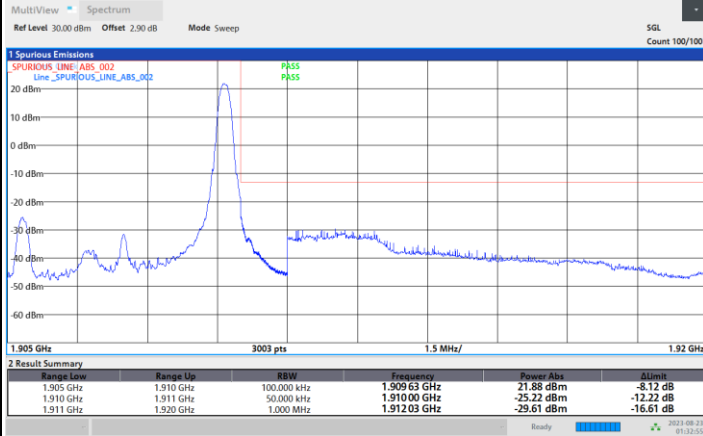
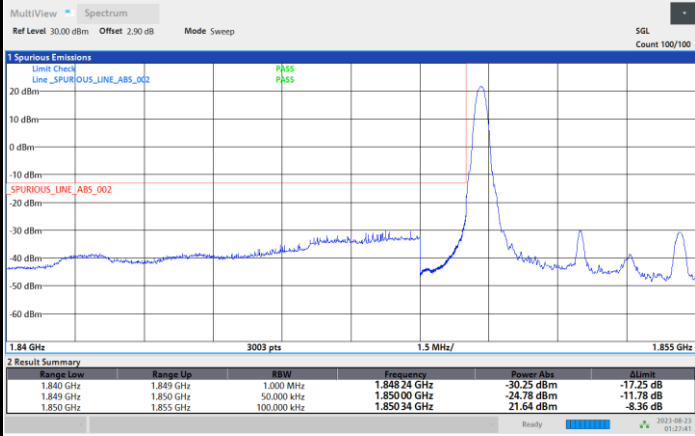

Lowest Band Edge / Full RB

Highest Band Edge / Full RB

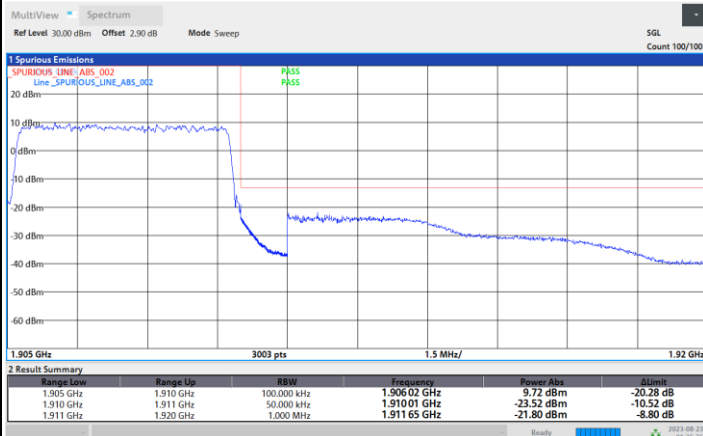
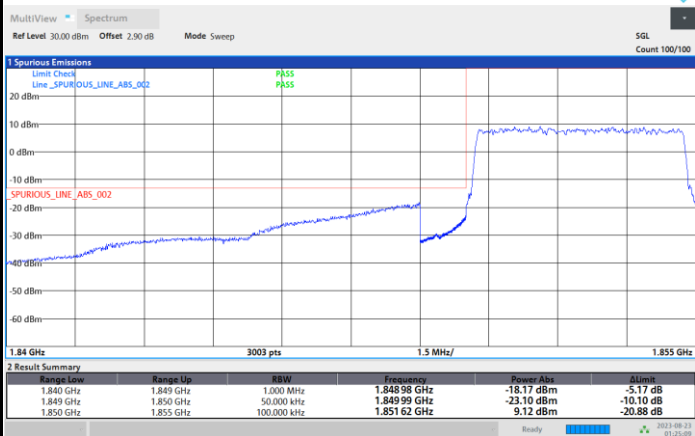



FR1 n2 / 5MHz / DFT-S OFDM / 16QAM

Lowest Band Edge / 1RB0

Highest Band Edge / 1RBmax

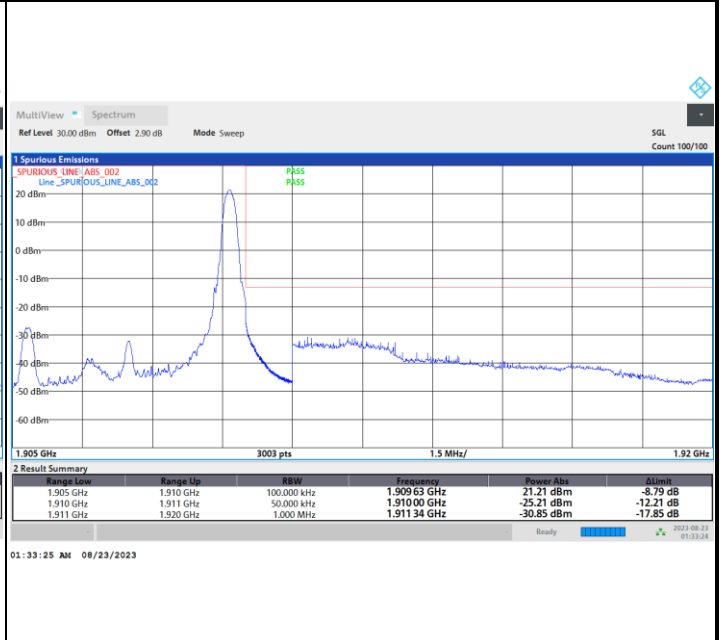
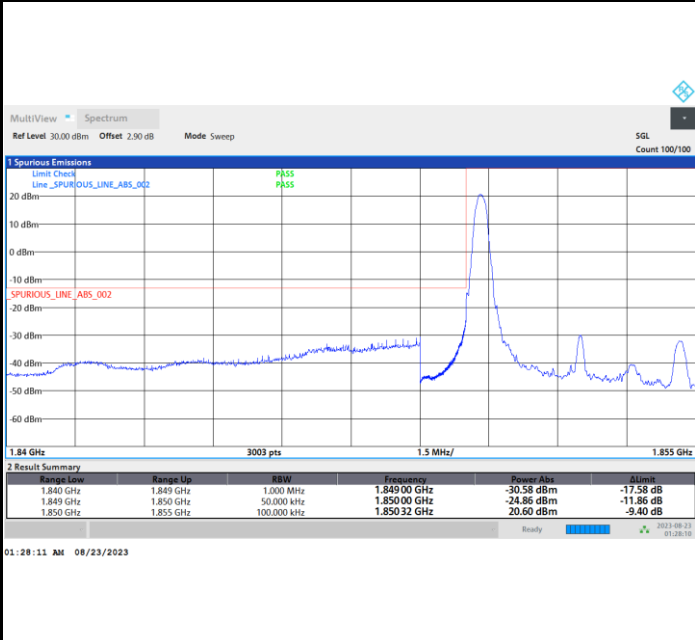

Lowest Band Edge / Full RB

Highest Band Edge / Full RB

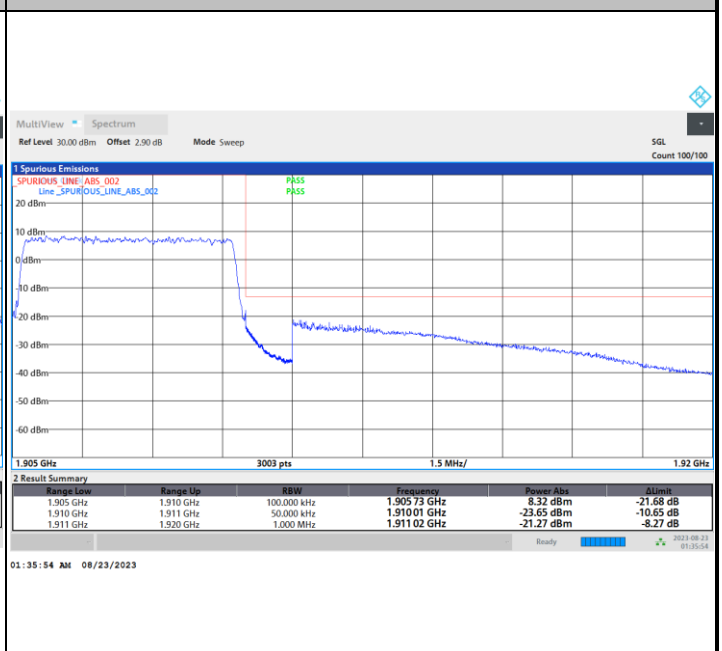
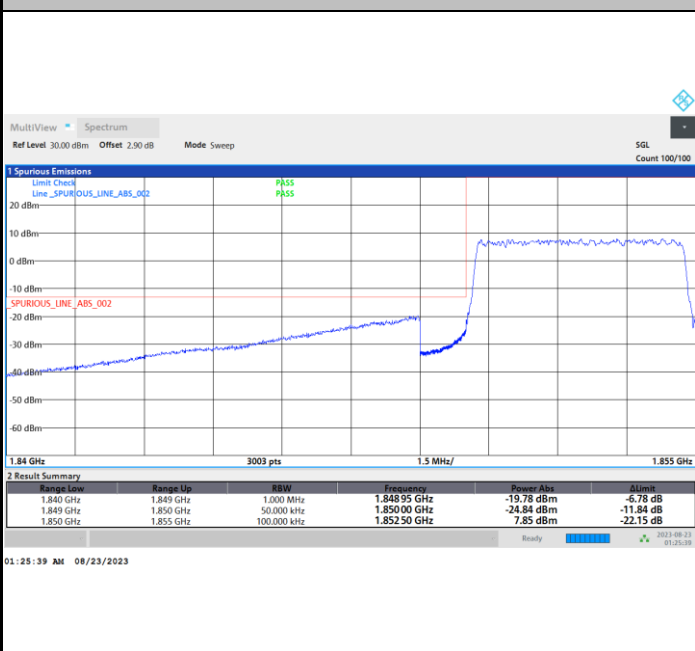



FR1 n2 / 5MHz / DFT-S OFDM / 64QAM

Lowest Band Edge / 1RB0

Highest Band Edge / 1RBmax

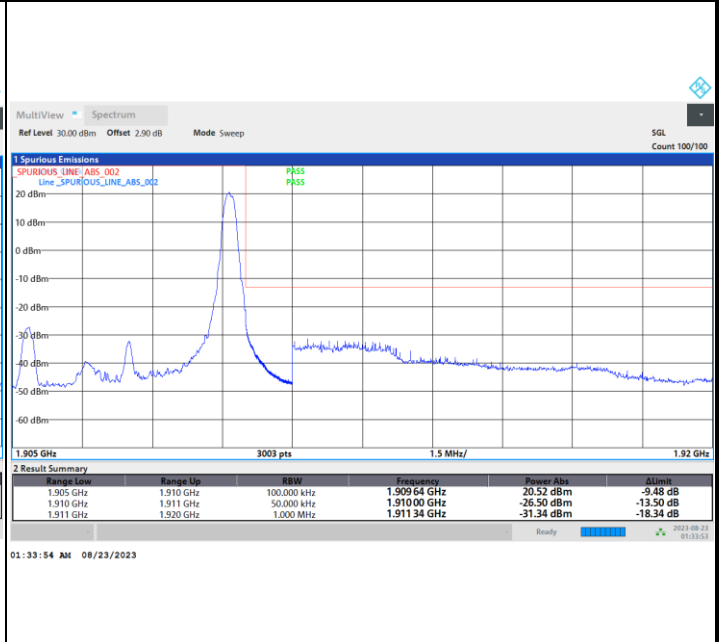
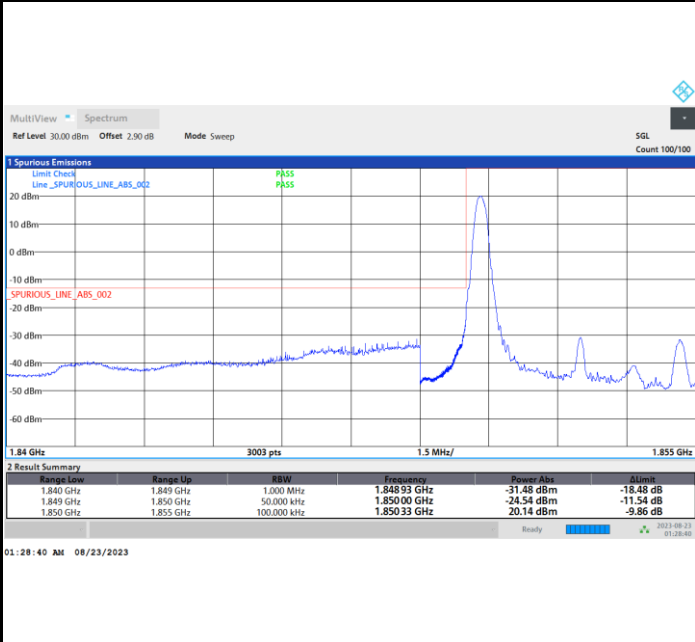

Lowest Band Edge / Full RB

Highest Band Edge / Full RB

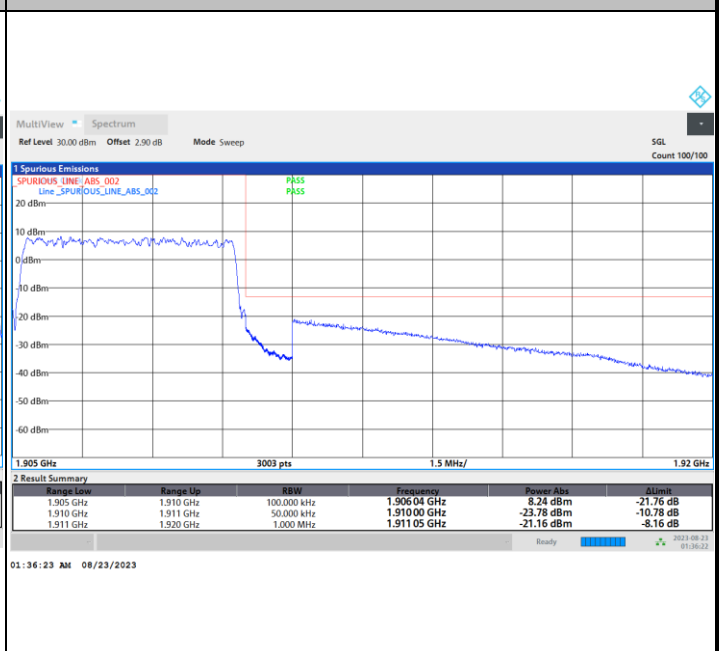
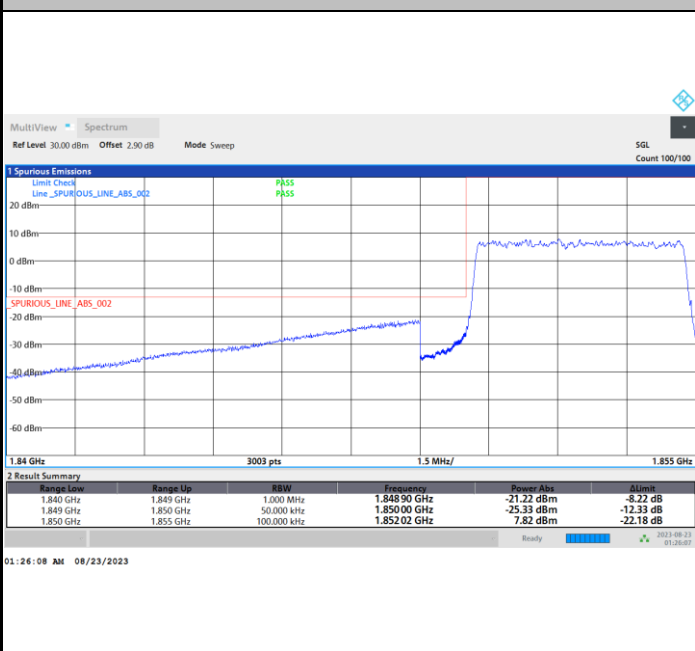



FR1 n2 / 5MHz / DFT-S OFDM / 256QAM

Lowest Band Edge / 1RB0

Highest Band Edge / 1RBmax

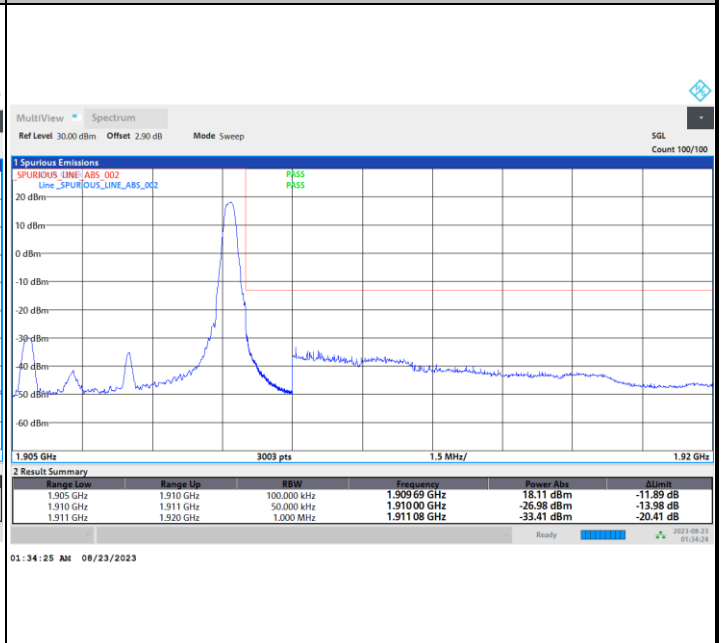
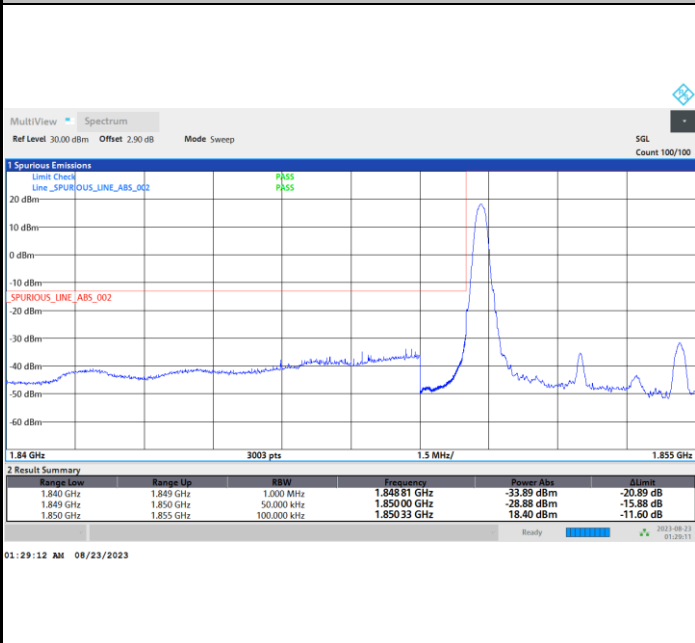

Lowest Band Edge / Full RB

Highest Band Edge / Full RB

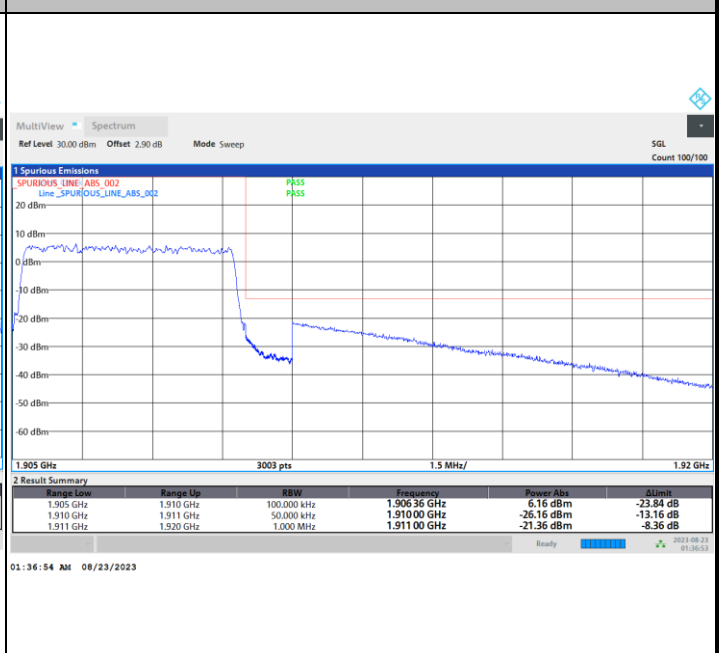
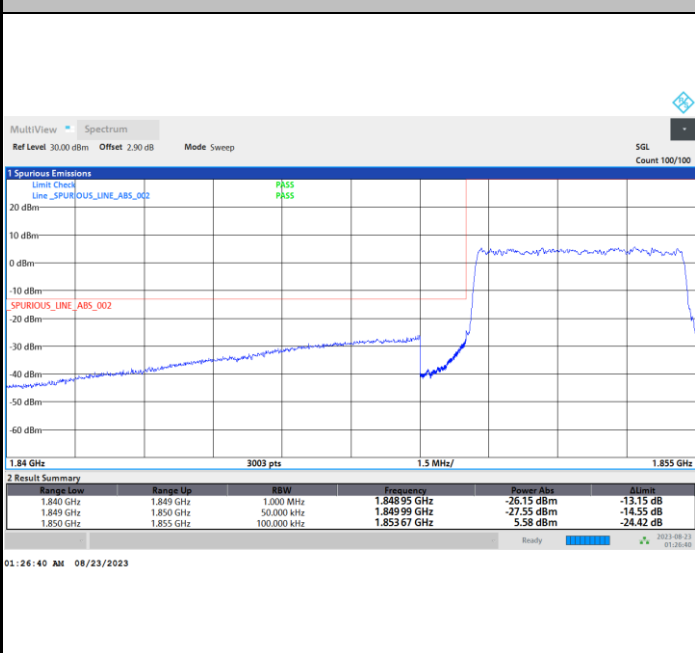



FR1 n2 / 5MHz / CP OFDM / QPSK / Full RB

Lowest Band Edge

Highest Band Edge

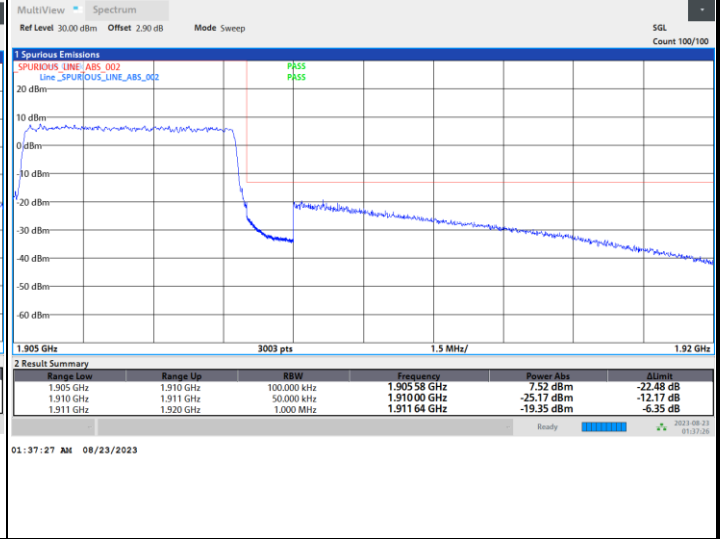
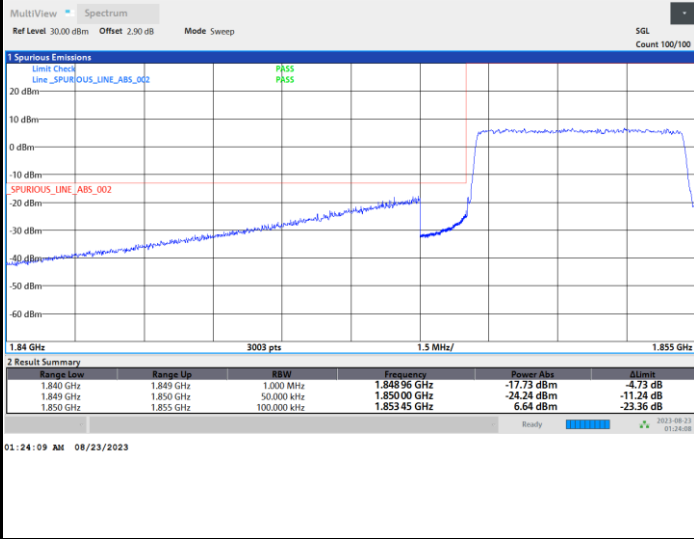



FR1 n2 / 10MHz / DFT-s-OFDM / PI/2 BPSK / Full RB

Lowest Band Edge

Highest Band Edge

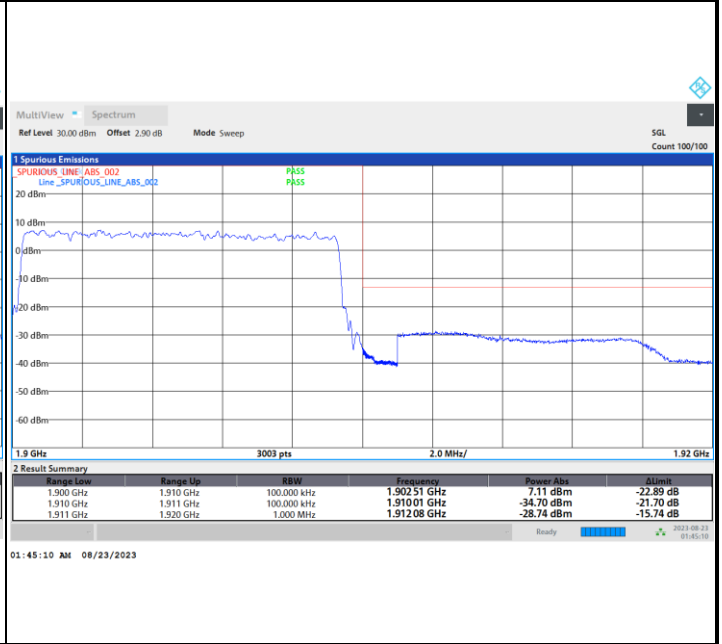
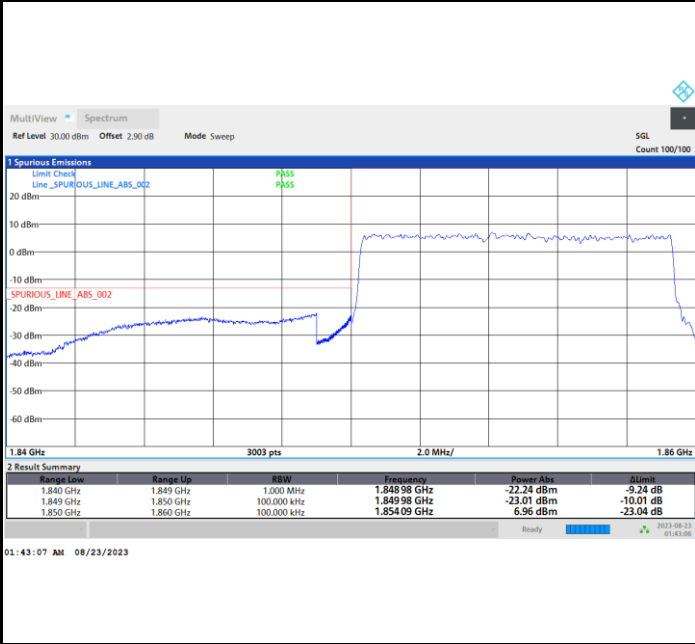

FR1 n2 / 10MHz / DFT-s-OFDM / QPSK / Full RB

Lowest Band Edge

Highest Band Edge

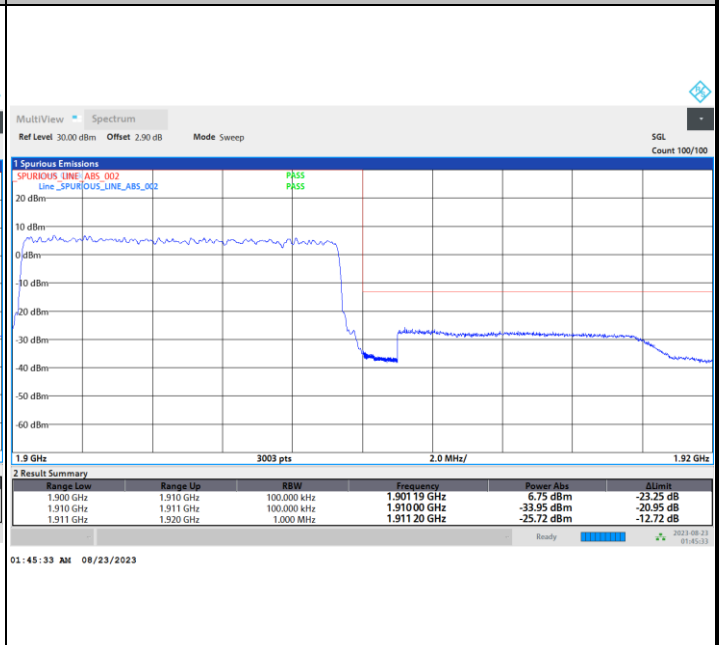
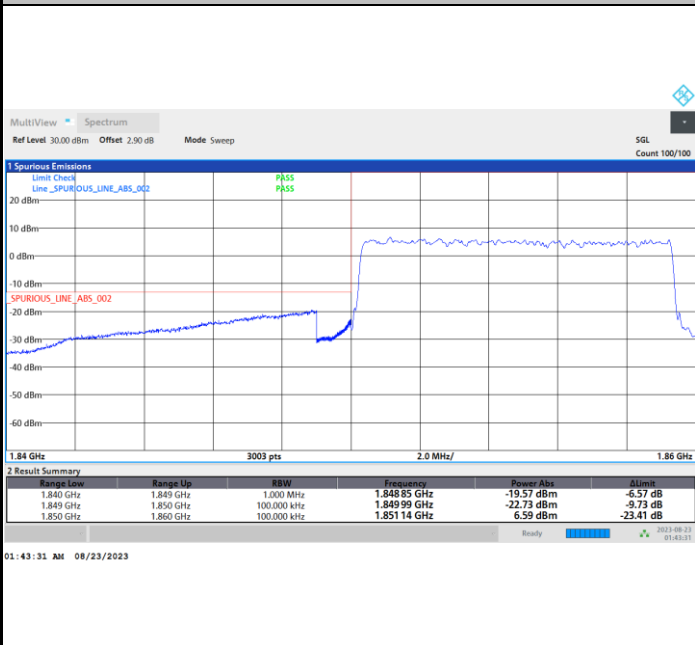



FR1 n2 / 10MHz / DFT-s-OFDM / 16QAM / Full RB

Lowest Band Edge

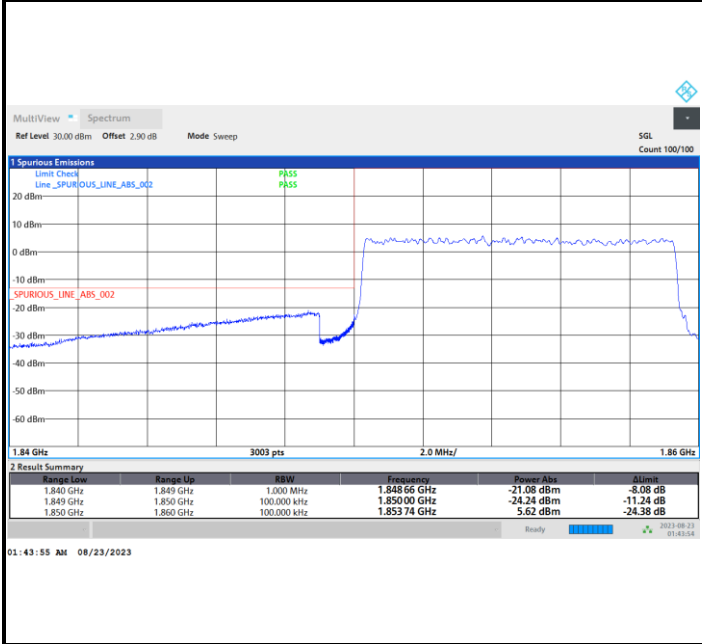

Highest Band Edge

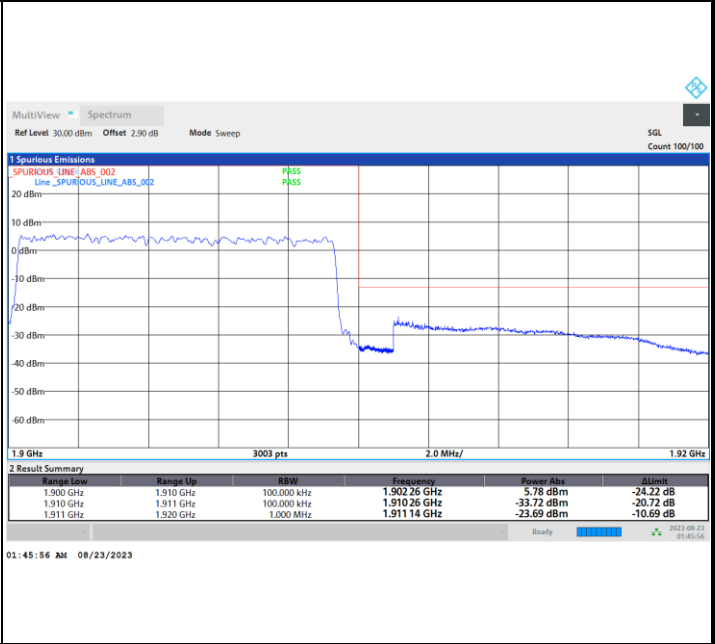

FR1 n2 / 10MHz / DFT-s-OFDM / 64QAM / Full RB

Lowest Band Edge

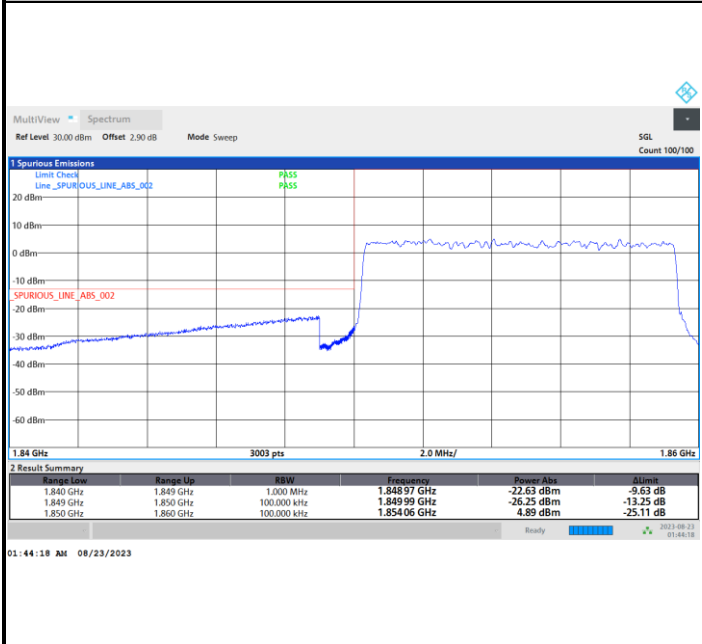

Highest Band Edge

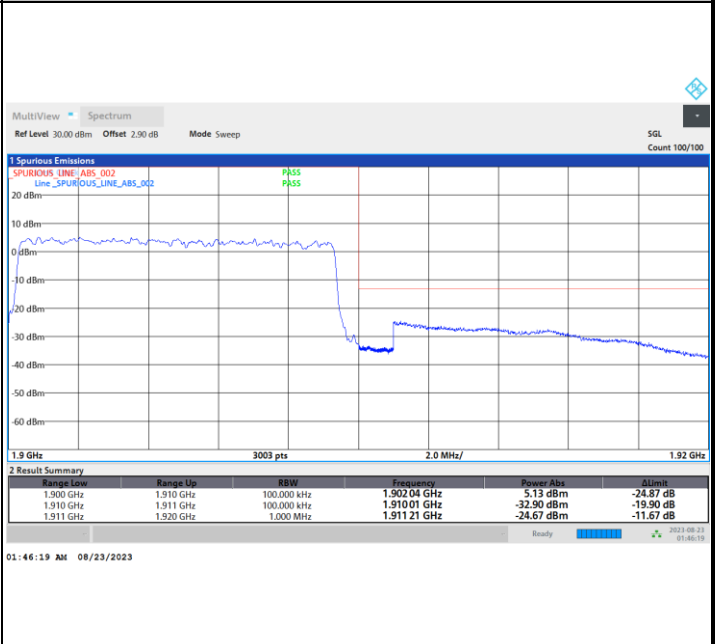



FR1 n2 / 10MHz / DFT-s-OFDM / 256QAM / Full RB

Lowest Band Edge

Highest Band Edge

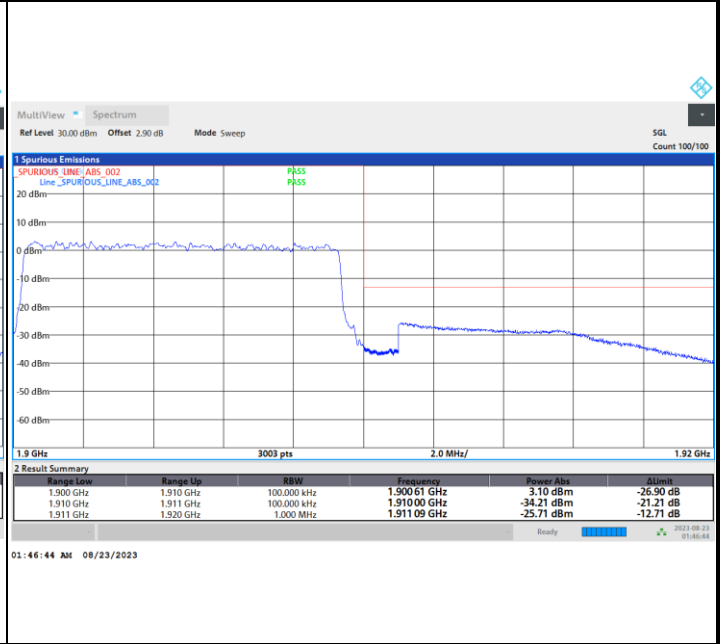
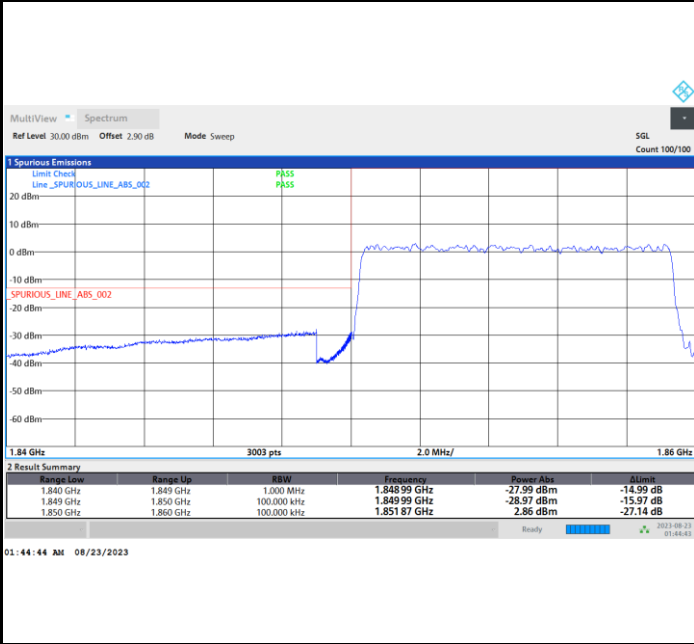

FR1 n2 / 10MHz / CP OFDM / QPSK / Full RB

Lowest Band Edge

Highest Band Edge

