



FCC RADIO TEST REPORT

FCC ID : A4RG6QU3
Equipment : Phone
Model Name : G6QU3
Applicant : Google LLC
1600 Amphitheatre Parkway,
Mountain View, California, 94043 USA
Standard : FCC 47 CFR Part 2, and 30

The product was received on Apr. 27, 2020 and testing was started from Apr. 27, 2020 and completed on Jul. 27, 2020. We, SPORTON INTERNATIONAL INC. EMC & Wireless Communications Laboratory, would like to declare that the tested sample has been evaluated in accordance with the test procedures ANSI C63.26-2015 and has been in compliance with the applicable technical standards.

The test results in this report apply exclusively to the tested model / sample. Without written approval of SPORTON INTERNATIONAL INC. EMC & Wireless Communications Laboratory, the test report shall not be reproduced except in full.

Louis Wu

Approved by: Louis Wu

SPORTON INTERNATIONAL INC. EMC & Wireless Communications Laboratory
No. 52, Huaya 1st Rd., Guishan Dist., Taoyuan City, Taiwan (R.O.C.)



Table of Contents

History of this test report.....	3
Summary of Test Result.....	4
1 General Description	5
1.1 Feature of Equipment Under Test.....	5
1.2 Product Specification of Equipment Under Test	5
1.3 Modification of EUT	6
1.4 Testing Location	6
1.5 Applied Standards	6
2 Test Configuration of Equipment Under Test	7
2.1 Test Mode.....	7
2.2 Connection Diagram of Test System	8
2.3 Support Unit used in test configuration	8
2.4 Measurement Results Explanation Example	8
2.5 Far Field Condition for Frequency above 18GHz.....	9
2.6 Frequency List of Low/Middle/High Channels.....	9
3 Radiated Test Items	10
3.1 Measuring Instruments.....	10
3.2 Test Setup	10
3.3 Test Result of Radiated Test.....	12
3.4 EIRP Measurement	13
3.5 Occupied Bandwidth	14
3.6 Radiated Spurious Emission Measurement.....	15
3.7 Frequency Stability Measurement.....	16
4 List of Measuring Equipment.....	17
5 Uncertainty of Evaluation.....	19
Appendix A. Test Results of EIRP and Radiated Test	
Appendix B. R&S Mixer Certificate	



History of this test report

Report No.	Version	Description	Issued Date
FG050515H	01	Initial issue of report	Aug. 04, 2020
FG050515H	02	Revise the typo of radiated out of band emissions at page A2-22 of 76	Aug. 12, 2020



Summary of Test Result

Report Clause	Ref Std. Clause	Test Items	Limit	Result (PASS/FAIL)	Remark
3.4	§2.1046 §30.202	EIRP Measurement	+43dBm	Pass	-
3.5	§2.1049	Occupied Bandwidth	Not Applicable	Reporting only	-
3.6	§2.1053 §30.203	Radiated Spurious Emission	-5dBm/MHz -13dBm/MHz	Pass	-
3.7	§2.1055	Frequency Stability for Temperature & Voltage	Within the band	Pass	-

Declaration of Conformity:

The test results with all measurement uncertainty excluded are presented in accordance with the regulation limits or requirements declared by manufacturers.

Comments and Explanations:

The declared of product specification for EUT presented in the report are provided by the manufacturer, and the manufacturer takes all the responsibilities for the accuracy of product specification.

Reviewed by: Wii Chang

Report Producer: Dara Chiu



1 General Description

1.1 Feature of Equipment Under Test

Product Feature & Specification	
Equipment	Phone
Model Name	G6QU3
FCC ID	A4RG6QU3
EUT supports Radios application	CDMA/EV-DO/GSM/EGPRS/WCDMA/HSPA/LTE/5G NR/ NFC/GNSS WLAN 11b/g/n HT20 WLAN 11a/n HT20/HT40 WLAN 11ac VHT20/VHT40/VHT80 Bluetooth BR/EDR/LE

Remark: The above EUT's information was declared by manufacturer.

EUT Information List	
S/N	Performed Test Item
05151FQCB00198 05151FQCB00205	Frequency Stability
03301FQCB00016 04081FQCB00144 04081FQCB00097	EIRP Radiated Spurious Emission

1.2 Product Specification of Equipment Under Test

Product Specification subjective to this standard	
Device Category in Part 30	Mobile station
Tx Frequency	NR band n260: 37GHz ~ 40GHz NR band n261: 27.5GHz ~ 28.35GHz
Rx Frequency	NR band n260: 37GHz ~ 40GHz NR band n261: 27.5GHz ~ 28.35GHz
Support Bandwidth	NR band n260: 50 MHz, 100 MHz, and 200 MHz NR band n261: 50 MHz, 100 MHz, and 200 MHz
Maximum Number of contiguous CC	2
Maximum Aggregated Bandwidth	200MHz
Maximum Output Power (EIRP)	NR band n260: Module 0: 26.52 dBm Module 1: 28.60 dBm NR band n261: Module 0: 25.54 dBm Module 1: 26.21 dBm
Type of Modulation	CP-OFDM: QPSK / 16QAM / 64QAM DFT-s-OFDM: QPSK / 16QAM / 64QAM

Note 1: Highest EIRP was measured on Module 1, dual beam case for n260 band.

Note 2: Highest EIRP was measured on Module 1, dual beam case for n261 band.



1.3 Modification of EUT

No modifications are made to the EUT during all test items.

1.4 Testing Location

Test Site	SPORTON INTERNATIONAL INC. EMC & Wireless Communications Laboratory			
Test Site Location	No.52, Huaya 1st Rd., Guishan Dist., Taoyuan City, Taiwan (R.O.C.) TEL: +886-3-327-3456 FAX: +886-3-328-4978			
Test Site Information	Site No.	Engineer	Temperature	Humidity
	TH05-HY	Chester Chen	22~24°C	42~46 %
Test Site	SPORTON INTERNATIONAL INC. EMC & Wireless Communications Laboratory			
Test Site Location	No.58, Aly. 75, Ln. 564, Wenhua 3rd, Rd., Guishan Dist., Taoyuan City, Taiwan (R.O.C.) TEL: +886-3-327-0868 FAX: +886-3-327-0855			
Test Site Information	Site No.	Engineer	Temperature	Humidity
	03CH10-HY	Yu Wang	23~24°C	46~47 %
	03CH18-HY	Yu Wang	22~23°C	46~48 %

FCC Designation No. TW1190 and TW0007

1.5 Applied Standards

According to the specifications of the manufacturer, the EUT must comply with the requirements of the following standards:

- ♦ FCC 47 CFR Part 2, 30
- ♦ ANSI C63.26-2015
- ♦ FCC KDB 971168 D01 Power Meas. License Digital Systems v03r01
- ♦ FCC KDB 842590 D01 Upper Microwave Flexible Use Service v01r01

Remark:

1. All test items were verified and recorded according to the standards and without any deviation during the test.
2. The TAF code is not including all the FCC KDB listed without accreditation.



2 Test Configuration of Equipment Under Test

EUT has total 2 millimeter wave antenna modules and up to 2 beams operation for each module.

Any antenna module cannot transmit simultaneously with the other antenna modules.

Preliminary EIRP test was performed for all beam configurations in the anechoic chamber at the manufacturer’s facility so the EIRP worst case beam-pair were identified.

EIRP was investigated that the dual beam rated maximum EIRP is higher than single beam.

EUT configured to transmit a single beam at a time and combine the measured value together for both beams by math calculation in linear form method.

The NR radio operation is controlled via software tool QRCT FTM mode (Factory mode).

The EUT is forced to operate continuously (100% duty cycle) with maximum output power during the test.

2.1 Test Mode

For radiated measurement, the pre-scan is performed to find the worst cases EUT position.

Test Items	Band	Bandwidth (MHz)			Modulation			RB #			Test Channel		
		50	100	200	QPSK	16QAM	64QAM	1	-	Full	L	M	H
EIRP	n260 n261	v	v	v	v	v	v	v		v	v	v	v
99% Occupied Bandwidth	n260 n261	v	v	v	v	v	v			v	v	v	v
Out of Band Emission	n260 n261	v	v	v	v	v	v	v		v	v		v
Spurious Emission	n260 n261	v	v	v	v			v			v	v	v
Frequency Stability	n260 n261	CW tone										v	
Remark	<ol style="list-style-type: none"> The mark "v " means that this configuration is chosen for testing. The device is investigated from 30MHz to 200GHz of fundamental signal for radiated spurious emission test under different RB size and modulations in exploratory test. Subsequently, only the worst case emissions are reported. Both modulation type DFT-s OFDM and CP-OFDM are evaluated and reported. All the radiated test cases were performed with built-in battery and was controlled by supported unit (Sec.2.2). The out of band emission were measured conducted emission level by radiated EIRP minus antenna gain declared. The spurious emissions were measured radiated EIRP. 												

2.2 Connection Diagram of Test System

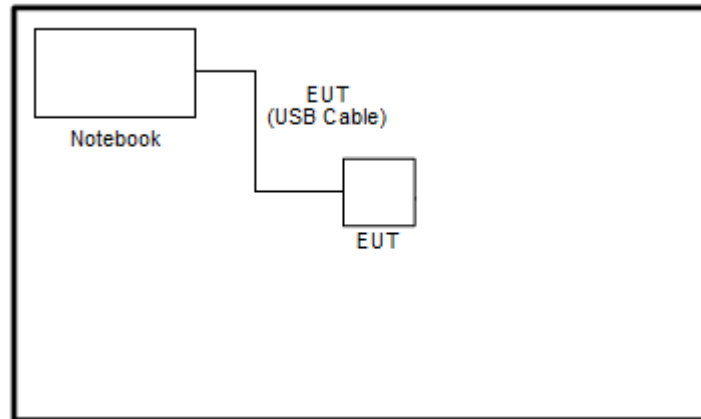

2.3 Support Unit used in test configuration

Item	Equipment	Trade Name	Model No.	FCC ID	Data Cable	Power Cord
1.	Notebook	Dell	P111G	N/A	N/A	N/A

2.4 Measurement Results Explanation Example

According to ANSI C63.26-2015 Section 5.2.7

$$EIRP \text{ (dBm)} = E \text{ (dBuV/m)} + 20\log(D) - 104.8.$$

where D is the measurement distance (in the far field region) in m.

$$E \text{ (dBuV/m)} = \text{Spectrum Reading Level (dBm)} + \text{Antenna Factor (dB/m)} + \text{Cable Loss (dB)} + 107$$

Hence, the spectrum analyzer *Offset* is derived including RF cable loss and antenna factor.

$$\text{Offset} = \text{Antenna Factor (dB/m)} + \text{Cable Loss (dB)} + 107 + 20\log(D) - 104.8$$

The conversion loss of RF mixer is also included by the mixer table of spectrum analyzer when measurement frequency is above 40GHz.

Example :

$$\begin{aligned} \text{Offset} &= \text{Antenna Factor (dB/m)} + \text{Cable Loss (dB)} + 107 + 20\log(D) - 104.8 \\ &= 42.3 + 3.0 + 107 + 20\log(1) - 104.8 \\ &= 47.5 \text{ (dB)} \end{aligned}$$



2.5 Far Field Condition for Frequency above 18GHz

Horn Antenna	Frequency (GHz)	Antenna Dimension A (mm)	Wavelength (λ) (m)	Far field R (m) $\geq 2A^2 / \lambda$	Measurement Distance (D) (m)	Distance Factor $20\log(D)$ (dB)
BBHA 9170	18	60	0.0167	0.43	1	0.00
	40	60	0.0075	0.96		
QWH-UPRR00	40	48	0.0075	0.61	1	0.00
	60	48	0.0050	0.92		
QWH-EPRR00	60	31	0.0050	0.38	1	0.00
	90	31	0.0033	0.58		
QWH-FPRR00	90	21	0.0033	0.26	1	0.00
	140	21	0.0021	0.41		
QWH-GPRR00	140	15	0.0021	0.21	0.5	-6.02
	220	15	0.0014	0.33		

2.6 Frequency List of Low/Middle/High Channels

NR Band n260 Channel and Frequency List				
BW [MHz]	Channel/Frequency(MHz)	Lowest	Middle	Highest
50	Frequency	37025	38500	39975
100	Frequency	37050	38500	39950
200	Frequency 1	37050	38450	39850
	Frequency 2	37150	38550	39950

NR Band n261 Channel and Frequency List				
BW [MHz]	Channel/Frequency(MHz)	Lowest	Middle	Highest
50	Frequency	27525	27925	28325
100	Frequency	27550	27925	28300
200	Frequency 1	27550	27875	28200
	Frequency 2	27650	27975	28300

3 Radiated Test Items

3.1 Measuring Instruments

See list of measuring instruments of this test report.

3.2 Test Setup

For radiated emissions from 30MHz to 1GHz

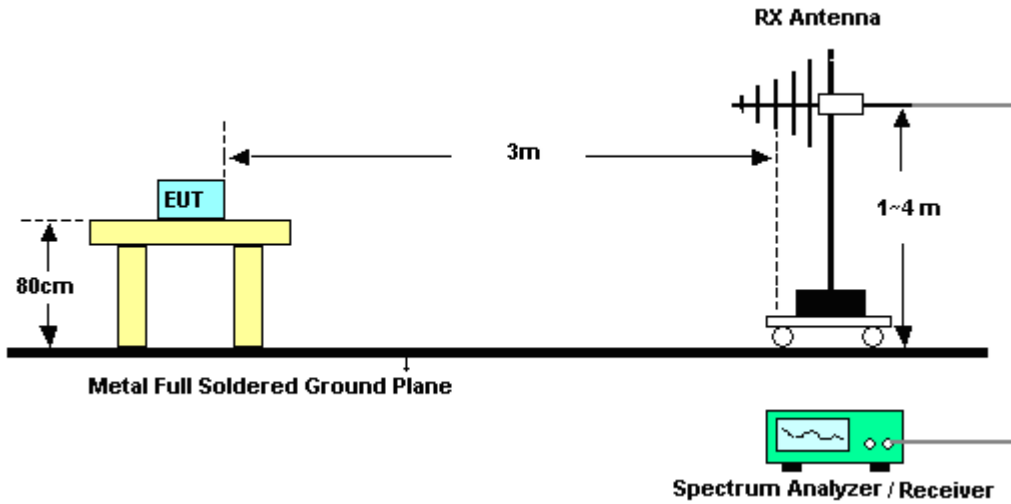

For radiated emissions 1GHz to 18GHz

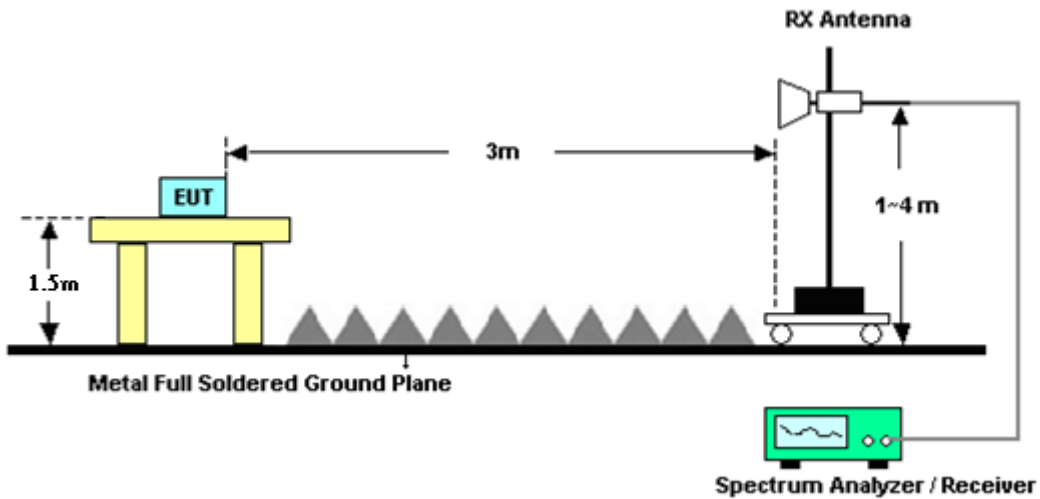

For radiated emissions above 18GHz up to 40GHz

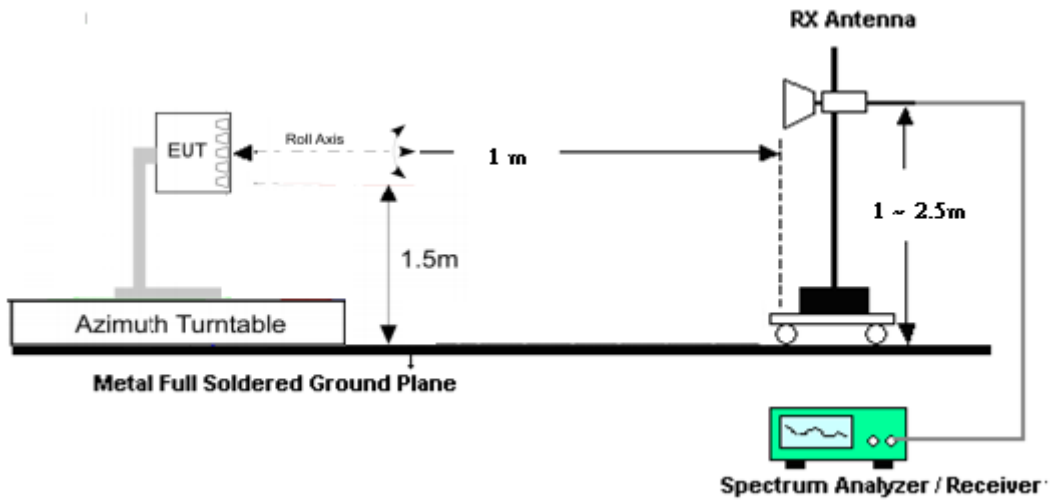

For radiated emissions above 40GHz up to 140GHz

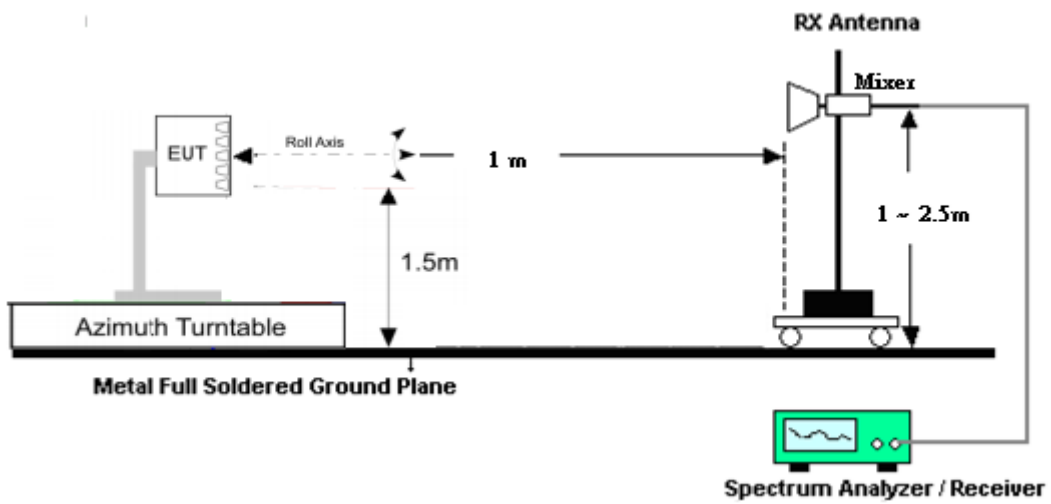

For radiated emissions above 140GHz up to 200GHz

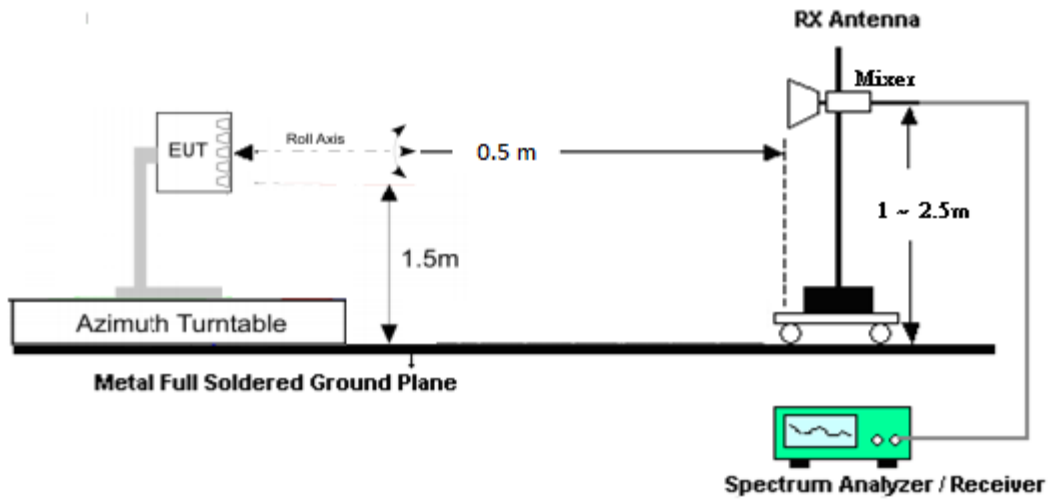

3.3 Test Result of Radiated Test

Please refer to Appendix A.



3.4 EIRP Measurement

3.4.1 Description of EIRP Measurement

For mobile stations, the average power of the sum of all antenna elements is limited to a maximum EIRP of +43 dBm.

3.4.2 Test Procedures

1. Set EUT at maximum output power.
2. Select lowest, middle, and highest channels for each band and different modulation.
3. Enable channel power function of spectrum analyzer
4. Set frequency would like to be investigated.
5. Set Detector = RMS
6. Set Trace mode = trace average
7. Set Sweep time = auto couple
8. Set sweep points $\geq 2 \times \text{Span/RBW}$
9. Set sweep count 100 and wait until the trace to be stabilized
10. Make the measurement with the spectrum analyzer's RBW = 1MHz, VBW = 3MHz, taking the record of maximum spurious emission.
11. Measure and record the power level from the spectrum analyzer.
12. The test result is calculated according to

ANSI C63.26-2015 Section 5.2.7

$$\text{EIRP (dBm)} = \text{E(dBuV/m)} + 20\log(D) - 104.8.$$

where D is the measurement distance (in the far field region) in m.

$$\text{E (dBuV/m)} = \text{Spectrum Level (dBm)} + \text{Antenna Factor (dB/m)} + \text{Cable Loss (dB)} + 107$$

That is, set the spectrum offset including sum of

$$\text{Antenna Factor (dB/m)} + \text{Cable Loss (dB)} + 107 + 20\log(D) - 104.8$$



3.5 Occupied Bandwidth

3.5.1 Description of Occupied Bandwidth Measurement

This is for reporting only.

The occupied bandwidth is the width of a frequency band such that, below the lower and above the upper frequency limits, the mean powers emitted are each equal to a specified percentage 0.5% of the total mean transmitted power.

3.5.2 Test Procedures

The testing follows ANSI C63.26-2015 Section 5.4.4

1. The spectrum analyzer center frequency is set to the nominal EUT channel center frequency. The span range for the spectrum analyzer shall be at least 1.5 times the anticipated OBW.
2. The nominal resolution bandwidth (RBW) shall be in the range of 1 to 5 % of the anticipated OBW, and the VBW shall be at least 3 times the RBW.
3. Set the detection mode to peak, and the trace mode to max hold.
4. Use the 99 % power bandwidth function of the spectrum analyzer and report the measured bandwidth.



3.6 Radiated Spurious Emission Measurement

3.6.1 Description of Radiated Spurious Emission Measurement

The spectrum is scanned from 30 MHz up to 200GHz.

The conductive power or the total radiated power of any emission outside a licensee's frequency block shall be -13 dBm/MHz or lower. However, in the bands immediately outside and adjacent to the licensee's frequency block, having a bandwidth equal to 10 percent of the channel bandwidth, the conductive power or the total radiated power of any emission shall be -5 dBm/MHz or lower.

3.6.2 Test Procedures

1. Set EUT at maximum output power..
2. Select lowest, middle, and highest channels for each band and different modulation.
3. Measure and record the power level from the spectrum analyzer.
4. Set frequency would like to be investigated.
5. Set Detector = RMS, Trace mode = trace average, sweep time = auto couple
6. Set sweep points $\geq 2 \times \text{Span/RBW}$, sweep count 100 and wait until the trace to be stabilized.
7. Make the measurement with the spectrum analyzer's RBW = 1MHz, VBW = 3MHz, taking the record of maximum spurious emission.
8. For measurement frequency from 30MHz to 18GHz,

An antenna was substituted in place of the EUT and was driven by a signal generator. Tune the output power of signal generator to the same emission level with EUT maximum spurious emission. Take record of output power and repeat for another polarization.

9. For measurement frequency above 18GHz, the test result is calculated according to ANSI C63.26-2015 Section 5.2.7 and 5.7.3 and 5.7.4

$$\text{EIRP (dBm)} = \text{E(dBuV/m)} + 20\log(D) - 104.8.$$

where D is the measurement distance (in the far field region) in m.

$$\text{E (dBuV/m)} = \text{Spectrum Level (dBm)} + \text{Antenna Factor (dB/m)} + \text{Cable Loss (dB)} + 107$$

That is, set the spectrum offset including sum of

$$\text{Antenna Factor (dB/m)} + \text{Cable Loss (dB)} + 107 + 20\log(D) - 104.8$$

For band edge, the antenna gain offset is included in order to compare to the conductive limit.

Antenna Gain (dBi)	AG0	AG1	AG0+AG1
n260 Module 0	9.60	9.50	9.60
n261 Module 0	9.37	9.40	9.40
n260 Module 1	10.20	10.54	10.54
n261 Module 1	9.23	7.90	9.23

Note: The antenna gain value in the table is declared by the manufacturer.

10. The conversion loss of RF mixer is also included in conversion loss table of the spectrum analyzer when measurement frequency is above 40GHz.



3.7 Frequency Stability Measurement

3.7.1 Description of Frequency Stability Measurement

The frequency stability shall be measured by variation of ambient temperature and variation of primary supply voltage to ensure that the fundamental emission stays within the authorized frequency block.

3.7.2 Test Procedures for Temperature Variation

The testing follows FCC KDB 971168 D01 v03r01 Section 9.

1. The EUT was set up in the thermal chamber.
2. With power OFF, the temperature was decreased to -30°C and the EUT was stabilized before testing. Power was applied and the maximum change in frequency was recorded within one minute.
3. With power OFF, the temperature was raised in 10°C step up to 50°C. The EUT was stabilized at each step for at least half an hour. Power was applied and the maximum frequency change was recorded within one minute.

3.7.3 Test Procedures for Voltage Variation

The testing follows FCC KDB 971168 D01 v03r01 Section 9.

1. The EUT was placed in a temperature chamber at 20° C.
2. The power supply voltage to the EUT was varied from 85% to 115% of the nominal value measured at the input to the EUT.
3. The variation in frequency was measured for the worst case.



4 List of Measuring Equipment

Instrument	Manufacturer	Model No.	Serial No.	Characteristics	Calibration Date	Test Date	Due Date	Remark
Amplifier	SONOMA	310N	187311	9kHz~1GHz	Oct. 22, 2019	Apr. 27, 2020 ~ Jun. 08, 2020	Oct. 21, 2020	Radiation (03CH10-HY)
Loop Antenna	Rohde & Schwarz	HFH2-Z2	100488	9kHz~30MHz	Jan. 09, 2020	Apr. 27, 2020 ~ Jun. 08, 2020	Jan. 08, 2021	Radiation (03CH10-HY)
Bilog Antenna	TESEQ	CBL 6111D&00800 N1D01N-06	35413 & 02	30MHz~1GHz	Feb. 09, 2020	Apr. 27, 2020 ~ Jun. 08, 2020	Feb. 08, 2021	Radiation (03CH10-HY)
Horn Antenna	SCHWARZBECK	BBHA 9120 D	9120D-1325	1GHz~18GHz	Oct. 09, 2019	Apr. 27, 2020 ~ Jun. 08, 2020	Oct. 08, 2020	Radiation (03CH10-HY)
Preamplifier	Jet-Power	JAP00101800-30-10P	160118550004	1GHz~18GHz	Sep. 27, 2019	Apr. 27, 2020 ~ Jun. 08, 2020	Sep. 26, 2020	Radiation (03CH10-HY)
Spectrum Analyzer	Rohde & Schwarz	FSV40	101564	10Hz~40GHz	Jul. 17, 2019	Apr. 27, 2020 ~ Jun. 08, 2020	Jul. 16, 2020	Radiation (03CH10-HY)
Controller	EMEC	EM 1000	N/A	Control Turn table & Ant Mast	N/A	Apr. 27, 2020 ~ Jun. 08, 2020	N/A	Radiation (03CH10-HY)
Antenna Mast	EMEC	AM-BS-4500-B	N/A	1~4m	N/A	Apr. 27, 2020 ~ Jun. 08, 2020	N/A	Radiation (03CH10-HY)
Turn Table	EMEC	TT 2200	N/A	0~360 Degree	N/A	Apr. 27, 2020 ~ Jun. 08, 2020	N/A	Radiation (03CH10-HY)
Software	Audix	E3 6.2009-8-24	RK-001042	N/A	N/A	Apr. 27, 2020 ~ Jun. 08, 2020	N/A	Radiation (03CH10-HY)
RF Cable	HUBER + SUHNER	SUCOFLEX 104 / 102	MY11692/4P E,MY11693/4 PE,MY2855/2	30MHz~1GHz	Nov. 07, 2019	Apr. 27, 2020 ~ Jun. 08, 2020	Nov. 06, 2020	Radiation (03CH10-HY)
RF Cable	HUBER + SUHNER	SUCOFLEX 104 / 102	MY11692/4P E,MY11693/4 PE,MY2855/2	1GHz~18GHz	Nov. 07, 2019	Apr. 27, 2020 ~ Jun. 08, 2020	Nov. 06, 2020	Radiation (03CH10-HY)
SHF-EHF Horn Antenna	SCHWARZBECK	BBHA 9170	BBHA9170251	18GHz~40GHz	Nov. 26, 2019	Apr. 27, 2020 ~ Jun. 08, 2020	Nov. 25, 2020	Radiation (03CH18-HY)
Signal Analyzer	Rohde & Schwarz	FSV3044	101010	10Hz~44GHz	Nov. 11, 2019	Apr. 27, 2020 ~ Jun. 08, 2020	Nov. 10, 2020	Radiation (03CH18-HY)
Spectrum Analyzer	Rohde & Schwarz	FSV40	101564	10Hz~40GHz	Jul. 17, 2019	Apr. 27, 2020 ~ Jun. 08, 2020	Jul. 16, 2020	Radiation (03CH18-HY)
Controller	EMEC	EM 1000	N/A	Control 3D positioner	N/A	Apr. 27, 2020 ~ Jun. 08, 2020	N/A	Radiation (03CH18-HY)
3D positioner	EMEC	N/A	N/A	Theta/Phi	N/A	Apr. 27, 2020 ~ Jun. 08, 2020	N/A	Radiation (03CH18-HY)
Harmonic Mixer (*)	Rohde & Schwarz	RPG FS-Z60	100986	40 ~ 60 GHz	Oct. 31, 2018	Apr. 27, 2020 ~ Jun. 08, 2020	Oct. 30, 2021	Radiation (03CH18-HY)
Harmonic Mixer (*)	Rohde & Schwarz	FS-Z90	101811	60 ~ 90 GHz	Jul. 16, 2018	Apr. 27, 2020 ~ Jun. 08, 2020	Jul. 15, 2021	Radiation (03CH18-HY)
Harmonic Mixer (*)	Rohde & Schwarz	RPG FS-Z140	101128	90 ~ 140 GHz	Sep. 03, 2018	Apr. 27, 2020 ~ Jun. 08, 2020	Sep. 02, 2021	Radiation (03CH18-HY)
Harmonic Mixer (*)	Rohde & Schwarz	RPG FS-Z220	101014	140 ~ 220 GHz	Aug. 27, 2018	Apr. 27, 2020 ~ Jun. 08, 2020	Aug. 26, 2021	Radiation (03CH18-HY)
Standard Horn Antenna	Quinstar	QWH-UPRR00	923600007	40 ~ 60 GHz	Aug. 17, 2018	Apr. 27, 2020 ~ Jun. 08, 2020	Aug. 16, 2021	Radiation (03CH18-HY)
Standard Horn Antenna	Quinstar	QWH-EPRR00	784600034	60 ~ 90 GHz	Aug. 17, 2018	Apr. 27, 2020 ~ Jun. 08, 2020	Aug. 16, 2021	Radiation (03CH18-HY)
Standard Horn Antenna	Quinstar	QWH-FPRR00	923800008	90 ~ 140 GHz	Aug. 17, 2018	Apr. 27, 2020 ~ Jun. 08, 2020	Aug. 16, 2021	Radiation (03CH18-HY)
Standard Horn Antenna	Quinstar	QWH-GPRR00	923900001	140 ~ 220 GHz	Aug. 17, 2018	Apr. 27, 2020 ~ Jun. 08, 2020	Aug. 16, 2021	Radiation (03CH18-HY)
SHF-EHF Horn Antenna	SCHWARZBECK	BBHA 9170	BBHA9170251	18~40GHz	Nov. 26, 2019	Jul. 24, 2020	Nov. 25, 2020	Radiation (03CH18-HY)
Spectrum Analyzer	Rohde & Schwarz	FSV40	101756	10Hz~40GHz	Dec. 24, 2019	Jul. 24, 2020	Dec. 23, 2020	Radiation (03CH18-HY)



Instrument	Manufacturer	Model No.	Serial No.	Characteristics	Calibration Date	Test Date	Due Date	Remark
RF Cable	HUBER + SUHNER	SF102/2*11SK 252	MY4278/2	9kHz~40GHz	Jul. 03, 2020	Jul. 24, 2020	Jul. 02, 2021	Radiation (03CH18-HY)
Temperature & Humidity Cabinet Chamber	ESPEC	LHU-113	1012005860	N/A	Dec.12. 2019	Jul. 24, 2020	Dec.11, 2020	Radiation (03CH18-HY)

Note: (*) Equipment manufacturer's Calibration Certificate.



5 Uncertainty of Evaluation

Uncertainty of Radiated Emission Measurement (30 MHz ~ 1000 MHz)

Measuring Uncertainty for a Level of Confidence of 95% (U = 2Uc(y))	3.25
---------------------------------------------------------------------	------

Uncertainty of Radiated Emission Measurement (1 GHz ~ 18 GHz)

Measuring Uncertainty for a Level of Confidence of 95% (U = 2Uc(y))	3.51
---------------------------------------------------------------------	------

Uncertainty of Radiated Emission Measurement (18 GHz ~ 40 GHz)

Measuring Uncertainty for a Level of Confidence of 95% (U = 2Uc(y))	4.03
---------------------------------------------------------------------	------

Uncertainty of Radiated Emission Measurement (40 GHz ~ 140 GHz)

Measuring Uncertainty for a Level of Confidence of 95% (U = 2Uc(y))	5.80
---------------------------------------------------------------------	------

Uncertainty of Radiated Emission Measurement (140 GHz ~ 200 GHz)

Measuring Uncertainty for a Level of Confidence of 95% (U = 2Uc(y))	6.80
---------------------------------------------------------------------	------



Appendix A. Test Results of EIRP and Radiated Test

EIRP Power(Average power)

NR Band n260 Module 0

NR Band n260 Module 0 AGO							
Maximum Average EIRP [dBm]							
	BW [MHz]	Waveform	Modulation	Outer 1RB	Outer Full	Inner 1RB	Inner Full
Lowest	50	DFT-S	QPSK	21.83	21.66	23.99	24.16
	50	DFT-S	16QAM	19.94	20.15	21.48	21.75
	50	DFT-S	64QAM	18.03	17.91	19.81	19.55
	50	CP	QPSK	18.67	18.79	19.24	20.00
	50	CP	16QAM	18.40	17.88	18.96	18.92
	50	CP	64QAM	15.05	14.95	16.63	16.37
	100	DFT-S	QPSK	21.63	21.92	23.98	24.26
	100	DFT-S	16QAM	19.57	20.22	21.40	21.96
	100	DFT-S	64QAM	18.17	18.02	20.00	19.75
	100	CP	QPSK	19.86	19.83	21.13	19.92
	100	CP	16QAM	17.99	18.39	19.14	18.02
	100	CP	64QAM	14.78	15.85	16.66	17.58
	200	DFT-S	QPSK	19.88	21.99	19.65	22.25
	200	DFT-S	16QAM	18.64	19.51	18.32	20.62
	200	DFT-S	64QAM	16.50	16.81	17.38	17.75
	200	CP	QPSK	19.00	20.17	18.90	20.69
	200	CP	16QAM	17.16	17.95	17.55	18.36
	200	CP	64QAM	15.13	15.16	15.60	16.27

Note :The 200MHz BW is carrier aggregation by 2CC of 100MHz.



NR Band n260 Module 0 AGO							
Maximum Average EIRP [dBm]							
	BW [MHz]	Waveform	Modulation	Outer 1RB	Outer Full	Inner 1RB	Inner Full
Middle	50	DFT-S	QPSK	20.99	21.59	23.66	23.83
	50	DFT-S	16QAM	19.46	20.01	21.53	21.80
	50	DFT-S	64QAM	17.51	18.14	19.75	19.46
	50	CP	QPSK	18.49	19.62	20.82	20.77
	50	CP	16QAM	17.91	18.41	19.93	19.90
	50	CP	64QAM	15.92	15.84	17.02	17.00
	100	DFT-S	QPSK	21.54	22.12	23.82	24.32
	100	DFT-S	16QAM	19.98	20.56	21.83	22.28
	100	DFT-S	64QAM	18.46	18.39	20.17	20.04
	100	CP	QPSK	19.42	20.00	20.55	21.16
	100	CP	16QAM	18.51	18.89	19.80	19.87
	100	CP	64QAM	16.53	16.11	18.06	17.93
	200	DFT-S	QPSK	17.19	20.22	17.56	20.21
	200	DFT-S	16QAM	18.16	19.62	18.25	19.58
	200	DFT-S	64QAM	17.80	17.60	17.94	17.51
	200	CP	QPSK	17.11	19.01	17.26	19.02
	200	CP	16QAM	17.63	17.39	17.83	17.31
	200	CP	64QAM	11.79	14.99	15.44	15.10

Note :The 200MHz BW is carrier aggregation by 2CC of 100MHz.



NR Band n260 Module 0 AG0							
Maximum Average EIRP [dBm]							
	BW [MHz]	Waveform	Modulation	Outer 1RB	Outer Full	Inner 1RB	Inner Full
Highest	50	DFT-S	QPSK	20.07	20.47	22.55	22.93
	50	DFT-S	16QAM	18.67	19.02	20.50	20.55
	50	DFT-S	64QAM	16.63	16.93	18.61	18.56
	50	CP	QPSK	17.14	18.34	19.00	18.97
	50	CP	16QAM	16.34	17.44	18.70	17.70
	50	CP	64QAM	14.41	14.67	16.64	15.00
	100	DFT-S	QPSK	20.17	20.38	22.08	22.16
	100	DFT-S	16QAM	18.54	18.80	20.17	20.23
	100	DFT-S	64QAM	16.24	16.61	18.14	18.06
	100	CP	QPSK	18.03	17.55	18.09	18.56
	100	CP	16QAM	16.75	16.56	16.79	17.18
	100	CP	64QAM	14.30	14.09	15.08	15.02
	200	DFT-S	QPSK	19.52	19.44	19.29	21.12
	200	DFT-S	16QAM	18.57	18.47	16.92	20.55
	200	DFT-S	64QAM	15.47	15.84	15.40	18.37
	200	CP	QPSK	16.69	16.94	16.57	17.61
	200	CP	16QAM	14.14	15.46	15.37	15.80
	200	CP	64QAM	12.60	13.29	13.18	13.79

Note :The 200MHz BW is carrier aggregation by 2CC of 100MHz.



NR Band n260 Module 0 AG1							
Maximum Average EIRP [dBm]							
	BW [MHz]	Waveform	Modulation	Outer 1RB	Outer Full	Inner 1RB	Inner Full
Lowest	50	DFT-S	QPSK	21.65	22.08	23.88	24.39
	50	DFT-S	16QAM	19.22	20.68	21.05	22.22
	50	DFT-S	64QAM	18.05	18.22	19.91	19.77
	50	CP	QPSK	20.14	19.94	21.47	19.68
	50	CP	16QAM	17.81	18.84	19.22	18.58
	50	CP	64QAM	15.65	15.63	17.54	15.63
	100	DFT-S	QPSK	21.37	22.17	23.92	24.43
	100	DFT-S	16QAM	19.19	20.48	21.17	22.19
	100	DFT-S	64QAM	17.74	18.27	19.78	19.92
	100	CP	QPSK	20.20	20.01	21.31	21.41
	100	CP	16QAM	17.95	18.64	19.35	19.78
	100	CP	64QAM	15.66	16.18	17.65	17.92
	200	DFT-S	QPSK	15.23	18.79	15.25	18.44
	200	DFT-S	16QAM	14.25	18.27	14.43	17.86
	200	DFT-S	64QAM	14.77	15.84	14.88	15.80
	200	CP	QPSK	14.52	16.95	14.43	16.78
	200	CP	16QAM	14.70	15.40	14.84	15.23
	200	CP	64QAM	12.71	12.83	12.25	12.46

Note :The 200MHz BW is carrier aggregation by 2CC of 100MHz.



NR Band n260 Module 0 AG1							
Maximum Average EIRP [dBm]							
	BW [MHz]	Waveform	Modulation	Outer 1RB	Outer Full	Inner 1RB	Inner Full
Middle	50	DFT-S	QPSK	22.86	23.5	25.32	25.47
	50	DFT-S	16QAM	21.21	21.83	23.18	23.34
	50	DFT-S	64QAM	19.57	19.74	21.65	21.26
	50	CP	QPSK	21.28	21.50	22.50	21.18
	50	CP	16QAM	19.12	20.22	20.39	20.32
	50	CP	64QAM	18.77	17.62	20.44	17.16
	100	DFT-S	QPSK	22.93	23.30	24.98	25.43
	100	DFT-S	16QAM	21.39	21.81	22.78	23.19
	100	DFT-S	64QAM	19.46	19.58	21.15	21.26
	100	CP	QPSK	21.36	21.34	22.34	22.46
	100	CP	16QAM	19.21	19.99	20.08	21.27
	100	CP	64QAM	18.47	17.47	20.02	18.98
	200	DFT-S	QPSK	17.96	21.20	17.96	21.21
	200	DFT-S	16QAM	18.34	20.75	18.81	20.63
	200	DFT-S	64QAM	18.04	18.49	18.52	18.42
	200	CP	QPSK	17.85	18.71	17.18	19.96
	200	CP	16QAM	17.77	17.10	16.68	18.27
	200	CP	64QAM	15.63	14.01	14.28	15.94

Note :The 200MHz BW is carrier aggregation by 2CC of 100MHz.



NR Band n260 Module 0 AG1							
Maximum Average EIRP [dBm]							
	BW [MHz]	Waveform	Modulation	Outer 1RB	Outer Full	Inner 1RB	Inner Full
Highest	50	DFT-S	QPSK	20.45	20.90	20.91	23.31
	50	DFT-S	16QAM	19.05	19.45	21.04	21.01
	50	DFT-S	64QAM	16.90	17.38	18.63	18.99
	50	CP	QPSK	19.49	18.92	20.74	19.10
	50	CP	16QAM	16.90	17.96	18.34	18.01
	50	CP	64QAM	14.63	14.84	16.44	15.09
	100	DFT-S	QPSK	22.10	22.05	23.76	23.82
	100	DFT-S	16QAM	20.28	20.47	21.20	21.55
	100	DFT-S	64QAM	18.72	18.38	19.59	19.55
	100	CP	QPSK	20.00	19.52	20.52	20.39
	100	CP	16QAM	18.32	18.19	18.67	19.18
	100	CP	64QAM	15.63	15.89	16.31	16.84
	200	DFT-S	QPSK	15.14	17.69	15.40	17.56
	200	DFT-S	16QAM	14.72	17.18	14.76	17.13
	200	DFT-S	64QAM	14.68	15.10	15.22	15.05
	200	CP	QPSK	14.24	17.00	14.28	16.98
	200	CP	16QAM	14.97	15.29	15.01	15.39
	200	CP	64QAM	12.83	12.70	12.50	12.33

Note :The 200MHz BW is carrier aggregation by 2CC of 100MHz.



NR Band n260 Module 0 AG0+1							
Maximum Average EIRP [dBm]							
	BW [MHz]	Waveform	Modulation	Outer 1RB	Outer Full	Inner 1RB	Inner Full
Lowest	50	DFT-S	QPSK	23.73	23.81	25.96	26.35
	50	DFT-S	16QAM	22.55	22.18	24.38	23.90
	50	DFT-S	64QAM	19.80	19.65	21.40	21.92
	50	CP	QPSK	21.05	20.75	22.01	22.14
	50	CP	16QAM	19.45	19.77	20.78	20.82
	50	CP	64QAM	15.54	16.86	17.22	18.91
	100	DFT-S	QPSK	24.02	24.14	26.08	26.52
	100	DFT-S	16QAM	22.66	22.6	24.62	24.22
	100	DFT-S	64QAM	19.89	19.94	21.7	21.72
	100	CP	QPSK	20.86	21.02	22.05	22.04
	100	CP	16QAM	19.71	19.93	20.77	21.00
	100	CP	64QAM	15.60	17.09	17.65	18.74
	200	DFT-S	QPSK	21.16	23.69	21.00	23.76
	200	DFT-S	16QAM	19.99	21.94	19.81	22.47
	200	DFT-S	64QAM	18.73	19.36	19.32	19.89
	200	CP	QPSK	17.73	20.23	17.98	20.17
	200	CP	16QAM	18.06	18.53	18.04	18.48
	200	CP	64QAM	16.28	16.55	17.78	16.07

Note :The 200MHz BW is carrier aggregation by 2CC of 100MHz.



NR Band n260 Module 0 AG0+1							
Maximum Average EIRP [dBm]							
	BW [MHz]	Waveform	Modulation	Outer 1RB	Outer Full	Inner 1RB	Inner Full
Middle	50	DFT-S	QPSK	22.47	23.10	25.14	25.19
	50	DFT-S	16QAM	21.07	21.37	22.95	23.26
	50	DFT-S	64QAM	18.78	19.30	20.90	21.04
	50	CP	QPSK	20.05	20.34	21.43	21.32
	50	CP	16QAM	17.77	19.22	19.05	20.37
	50	CP	64QAM	16.36	16.41	18.24	17.75
	100	DFT-S	QPSK	23.39	23.12	25.10	25.11
	100	DFT-S	16QAM	21.35	21.50	22.70	23.04
	100	DFT-S	64QAM	19.76	19.45	21.08	20.95
	100	CP	QPSK	20.58	20.21	21.36	21.23
	100	CP	16QAM	19.43	19.27	20.05	20.47
	100	CP	64QAM	16.65	16.59	17.90	18.12
	200	DFT-S	QPSK	20.60	23.75	20.77	23.75
	200	DFT-S	16QAM	21.26	23.23	21.55	23.15
	200	DFT-S	64QAM	20.93	21.08	21.25	21.00
	200	CP	QPSK	19.66	19.97	19.95	20.32
	200	CP	16QAM	19.56	18.57	19.92	18.84
	200	CP	64QAM	12.13	15.91	15.85	15.96

Note :The 200MHz BW is carrier aggregation by 2CC of 100MHz.



NR Band n260 Module 0 AG0+1							
Maximum Average EIRP [dBm]							
	BW [MHz]	Waveform	Modulation	Outer 1RB	Outer Full	Inner 1RB	Inner Full
Highest	50	DFT-S	QPSK	23.02	23.37	24.07	24.56
	50	DFT-S	16QAM	22.25	21.83	23.02	22.74
	50	DFT-S	64QAM	19.50	19.35	20.02	20.52
	50	CP	QPSK	19.84	21.32	22.02	22.74
	50	CP	16QAM	19.48	19.95	20.74	21.48
	50	CP	64QAM	17.71	17.36	20.22	19.77
	100	DFT-S	QPSK	24.14	23.32	25.04	25.22
	100	DFT-S	16QAM	22.92	21.64	23.02	23.18
	100	DFT-S	64QAM	18.85	19.64	21.08	20.90
	100	CP	QPSK	21.15	20.64	21.67	21.24
	100	CP	16QAM	19.49	19.46	19.92	20.24
	100	CP	64QAM	17.05	16.79	17.99	18.21
	200	DFT-S	QPSK	20.87	21.66	20.78	22.71
	200	DFT-S	16QAM	20.07	20.88	18.98	22.18
	200	DFT-S	64QAM	18.10	18.50	18.32	20.03
	200	CP	QPSK	18.32	20.48	18.24	20.47
	200	CP	16QAM	18.15	18.86	18.46	18.74
	200	CP	64QAM	12.15	16.36	15.68	16.05

Note :The 200MHz BW is carrier aggregation by 2CC of 100MHz.

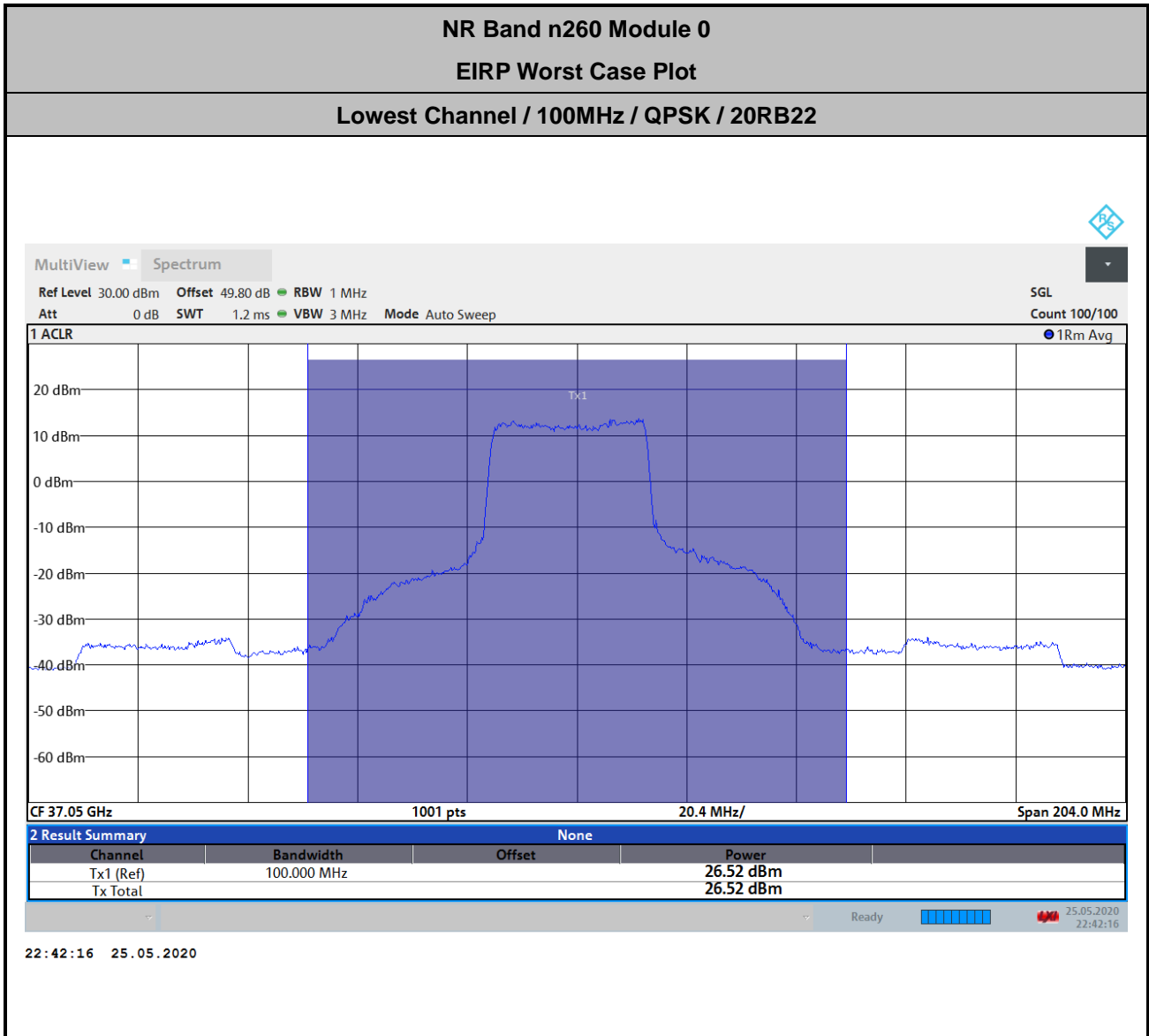

$$\begin{aligned}
 \text{Offset} &= \text{Antenna Factor (dB/m)} + \text{Cable Loss (dB)} + 107 + 20\log(D) - 104.8 \\
 &= 45.1 + 2.5 + 107 + 20\log(1) - 104.8 \\
 &= 49.8 \text{ (dB)}
 \end{aligned}$$



NR Band n260 Module 1

NR Band n260 Module 1 AGO							
Maximum Average EIRP [dBm]							
	BW [MHz]	Waveform	Modulation	Outer 1RB	Outer Full	Inner 1RB	Inner Full
Lowest	50	DFT-S	QPSK	24.23	24.00	26.75	26.26
	50	DFT-S	16QAM	22.03	22.09	24.19	23.67
	50	DFT-S	64QAM	19.59	19.89	21.38	21.97
	50	CP	QPSK	21.37	21.85	22.81	22.93
	50	CP	16QAM	20.58	20.55	21.88	22.02
	50	CP	64QAM	18.42	18.10	20.48	19.28
	100	DFT-S	QPSK	23.77	23.66	26.31	25.82
	100	DFT-S	16QAM	22.68	21.96	24.24	23.36
	100	DFT-S	64QAM	18.99	19.72	20.81	21.30
	100	CP	QPSK	20.58	21.04	21.96	22.22
	100	CP	16QAM	19.90	19.99	21.21	20.99
	100	CP	64QAM	17.46	17.15	19.31	18.91
	200	DFT-S	QPSK	18.31	21.21	18.92	21.29
	200	DFT-S	16QAM	17.58	20.63	17.85	20.52
	200	DFT-S	64QAM	17.07	18.3	17.68	18.22
	200	CP	QPSK	18.27	19.76	18.59	19.9
	200	CP	16QAM	17.35	18.02	17.71	18.22
	200	CP	64QAM	15.22	15.11	15.25	15.36

Note :The 200MHz BW is carrier aggregation by 2CC of 100MHz.



NR Band n260 Module 1 AG0							
Maximum Average EIRP [dBm]							
	BW [MHz]	Waveform	Modulation	Outer 1RB	Outer Full	Inner 1RB	Inner Full
Middle	50	DFT-S	QPSK	23.37	23.92	26.12	26.04
	50	DFT-S	16QAM	22.80	22.40	23.79	24.01
	50	DFT-S	64QAM	19.63	20.31	21.40	21.71
	50	CP	QPSK	21.87	21.87	22.45	22.64
	50	CP	16QAM	21.84	20.63	22.35	22.30
	50	CP	64QAM	18.77	18.33	19.83	19.37
	100	DFT-S	QPSK	22.51	22.82	25.01	25.18
	100	DFT-S	16QAM	21.94	21.43	23.27	22.90
	100	DFT-S	64QAM	19.02	18.95	21.04	20.90
	100	CP	QPSK	21.35	20.79	22.12	22.06
	100	CP	16QAM	21.20	19.52	22.04	21.17
	100	CP	64QAM	18.04	16.81	19.26	18.77
	200	DFT-S	QPSK	18.6	21.00	18.61	21.28
	200	DFT-S	16QAM	18.36	20.41	18.49	20.76
	200	DFT-S	64QAM	17.94	18.21	18.4	18.96
	200	CP	QPSK	18.47	19.56	18.37	20.33
	200	CP	16QAM	18.35	18.30	18.21	18.89
	200	CP	64QAM	16.05	17.30	15.95	16.01

Note :The 200MHz BW is carrier aggregation by 2CC of 100MHz.



NR Band n260 Module 1 AG0							
Maximum Average EIRP [dBm]							
	BW [MHz]	Waveform	Modulation	Outer 1RB	Outer Full	Inner 1RB	Inner Full
Highest	50	DFT-S	QPSK	22.47	22.39	25.04	24.53
	50	DFT-S	16QAM	21.55	20.50	22.99	22.30
	50	DFT-S	64QAM	18.03	20.39	19.63	20.24
	50	CP	QPSK	19.89	20.02	20.95	21.12
	50	CP	16QAM	19.35	18.94	20.25	19.91
	50	CP	64QAM	17.16	16.52	18.71	17.86
	100	DFT-S	QPSK	22.79	22.59	24.95	24.63
	100	DFT-S	16QAM	21.10	21.04	22.77	22.40
	100	DFT-S	64QAM	18.08	18.89	19.71	20.35
	100	CP	QPSK	20.58	20.35	21.78	21.43
	100	CP	16QAM	18.89	19.38	20.13	20.12
	100	CP	64QAM	17.07	16.64	18.97	18.25
	200	DFT-S	QPSK	14.23	17.83	14.69	18.28
	200	DFT-S	16QAM	14.01	17.19	14.45	17.58
	200	DFT-S	64QAM	13.55	14.98	13.96	15.17
	200	CP	QPSK	14.03	16.67	14.65	16.46
	200	CP	16QAM	13.79	14.87	14.29	14.84
	200	CP	64QAM	11.17	11.88	12.30	11.98

Note :The 200MHz BW is carrier aggregation by 2CC of 100MHz.



NR Band n260 Module 1 AG1							
Maximum Average EIRP [dBm]							
	BW [MHz]	Waveform	Modulation	Outer 1RB	Outer Full	Inner 1RB	Inner Full
Lowest	50	DFT-S	QPSK	22.99	23.16	25.47	25.44
	50	DFT-S	16QAM	21.24	21.33	23.27	23.24
	50	DFT-S	64QAM	17.91	19.14	20.02	21.01
	50	CP	QPSK	20.50	20.77	22.01	21.94
	50	CP	16QAM	19.34	19.51	20.87	20.88
	50	CP	64QAM	17.44	17.06	19.54	18.72
	100	DFT-S	QPSK	22.9	22.92	25.17	25.01
	100	DFT-S	16QAM	21.15	21.17	22.87	22.77
	100	DFT-S	64QAM	17.81	18.88	19.61	20.52
	100	CP	QPSK	20.78	20.36	22.02	21.57
	100	CP	16QAM	18.83	19.26	20.06	20.32
	100	CP	64QAM	16.91	16.32	18.79	18.21
	200	DFT-S	QPSK	16.72	20.24	17.19	20.33
	200	DFT-S	16QAM	16.59	19.61	16.92	19.80
	200	DFT-S	64QAM	15.74	17.04	16.45	17.10
	200	CP	QPSK	16.51	18.45	16.93	18.88
	200	CP	16QAM	16.10	16.83	16.44	16.87
	200	CP	64QAM	13.98	14.00	14.52	14.14

Note :The 200MHz BW is carrier aggregation by 2CC of 100MHz.



NR Band n260 Module 1 AG1							
Maximum Average EIRP [dBm]							
	BW [MHz]	Waveform	Modulation	Outer 1RB	Outer Full	Inner 1RB	Inner Full
Middle	50	DFT-S	QPSK	23.70	24.20	25.79	26.12
	50	DFT-S	16QAM	22.25	22.56	23.97	23.85
	50	DFT-S	64QAM	19.94	20.22	21.93	21.78
	50	CP	QPSK	22.31	21.92	23.39	22.93
	50	CP	16QAM	21.23	20.63	22.63	22.34
	50	CP	64QAM	17.85	18.28	19.40	19.53
	100	DFT-S	QPSK	24.43	24.03	26.04	25.91
	100	DFT-S	16QAM	22.89	22.31	23.95	23.78
	100	DFT-S	64QAM	20.63	20.32	21.78	21.39
	100	CP	QPSK	22.88	21.97	23.56	22.62
	100	CP	16QAM	21.89	20.91	22.32	21.95
	100	CP	64QAM	19.08	18.24	19.96	19.74
	200	DFT-S	QPSK	18.95	21.30	20.07	21.55
	200	DFT-S	16QAM	18.62	20.91	18.61	21.14
	200	DFT-S	64QAM	18.54	18.91	19.10	18.75
	200	CP	QPSK	19.60	20.63	19.66	20.78
	200	CP	16QAM	19.00	19.12	18.01	19.10
	200	CP	64QAM	18.92	16.00	17.22	16.74

Note :The 200MHz BW is carrier aggregation by 2CC of 100MHz.



NR Band n260 Module 1 AG1							
Maximum Average EIRP [dBm]							
	BW [MHz]	Waveform	Modulation	Outer 1RB	Outer Full	Inner 1RB	Inner Full
Highest	50	DFT-S	QPSK	21.91	21.61	24.00	23.67
	50	DFT-S	16QAM	19.9	19.83	21.41	21.82
	50	DFT-S	64QAM	17.52	17.83	19.42	19.65
	50	CP	QPSK	20.23	18.89	21.20	19.71
	50	CP	16QAM	18.33	17.67	19.40	19.38
	50	CP	64QAM	16.33	15.34	17.88	16.54
	100	DFT-S	QPSK	21.42	21.37	23.79	23.42
	100	DFT-S	16QAM	19.17	19.69	21.07	21.53
	100	DFT-S	64QAM	16.73	17.53	19.01	19.09
	100	CP	QPSK	19.58	19.05	21.01	20.35
	100	CP	16QAM	17.82	18.13	19.18	19.22
	100	CP	64QAM	16.18	15.25	18.00	17.12
	200	DFT-S	QPSK	15.69	19.42	16.05	19.46
	200	DFT-S	16QAM	14.91	18.73	15.62	18.9
	200	DFT-S	64QAM	14.41	16.10	15.56	16.29
	200	CP	QPSK	15.31	18.11	15.78	17.95
	200	CP	16QAM	15.11	16.30	15.53	16.28
	200	CP	64QAM	13.15	13.82	14.05	13.7

Note :The 200MHz BW is carrier aggregation by 2CC of 100MHz.



NR Band n260 Module 1 AG0+1							
Maximum Average EIRP [dBm]							
	BW [MHz]	Waveform	Modulation	Outer 1RB	Outer Full	Inner 1RB	Inner Full
Lowest	50	DFT-S	QPSK	25.37	26.33	28.25	28.6
	50	DFT-S	16QAM	24.74	24.36	26.15	26.4
	50	DFT-S	64QAM	21.14	22.37	23.32	24.27
	50	CP	QPSK	21.03	21.59	22.48	23.1
	50	CP	16QAM	20.32	20.54	21.73	21.81
	50	CP	64QAM	17.53	17.5	19.4	19.46
	100	DFT-S	QPSK	25.55	26.06	28.05	27.63
	100	DFT-S	16QAM	24.39	24.56	26.18	25.86
	100	DFT-S	64QAM	21.33	22.2	23.17	23.44
	100	CP	QPSK	21.15	21.52	22.67	22.91
	100	CP	16QAM	20.37	20.32	21.62	21.61
	100	CP	64QAM	17.29	17.55	19.21	19.16
	200	DFT-S	QPSK	20.60	23.76	21.15	23.85
	200	DFT-S	16QAM	20.12	23.16	20.42	23.19
	200	DFT-S	64QAM	19.47	20.73	20.12	20.71
	200	CP	QPSK	17.97	20.43	18.05	20.44
	200	CP	16QAM	17.54	18.52	17.81	18.22
	200	CP	64QAM	11.50	16.04	15.77	15.76

Note :The 200MHz BW is carrier aggregation by 2CC of 100MHz.



NR Band n260 Module 1 AG0+1							
Maximum Average EIRP [dBm]							
	BW [MHz]	Waveform	Modulation	Outer 1RB	Outer Full	Inner 1RB	Inner Full
Middle	50	DFT-S	QPSK	24.46	24.57	27.08	26.86
	50	DFT-S	16QAM	23.11	22.9	25.23	24.68
	50	DFT-S	64QAM	19.75	20.69	22.33	22.36
	50	CP	QPSK	22.6	22.68	23.44	23.91
	50	CP	16QAM	21.56	21.75	22.6	22.47
	50	CP	64QAM	18.55	18.95	20.62	20.57
	100	DFT-S	QPSK	22.87	22.84	24.77	25.27
	100	DFT-S	16QAM	22.08	21.37	23.48	22.91
	100	DFT-S	64QAM	19.68	19.01	21.2	20.54
	100	CP	QPSK	21.86	21.03	22.1	22.1
	100	CP	16QAM	20.32	20.07	20.82	21.22
	100	CP	64QAM	18.05	17.4	19.07	18.67
	200	DFT-S	QPSK	21.79	24.16	22.41	24.43
	200	DFT-S	16QAM	21.50	23.68	21.56	23.96
	200	DFT-S	64QAM	21.26	21.58	21.77	21.87
	200	CP	QPSK	20.60	21.89	21.07	21.78
	200	CP	16QAM	19.60	20.35	20.03	20.28
	200	CP	64QAM	17.48	17.47	17.92	17.71

Note :The 200MHz BW is carrier aggregation by 2CC of 100MHz.



NR Band n260 Module 1 AG0+1							
Maximum Average EIRP [dBm]							
	BW [MHz]	Waveform	Modulation	Outer 1RB	Outer Full	Inner 1RB	Inner Full
Highest	50	DFT-S	QPSK	20.94	20.80	23.06	22.84
	50	DFT-S	16QAM	20.18	19.04	21.47	20.67
	50	DFT-S	64QAM	17.56	17.03	19.28	18.87
	50	CP	QPSK	18.92	18.64	20.03	19.41
	50	CP	16QAM	18.10	17.23	19.16	18.50
	50	CP	64QAM	15.58	15.04	17.18	16.18
	100	DFT-S	QPSK	22.02	22.25	24.71	24.61
	100	DFT-S	16QAM	20.70	20.59	22.39	22.33
	100	DFT-S	64QAM	18.13	18.44	20.42	19.94
	100	CP	QPSK	20.72	20.52	21.28	21.25
	100	CP	16QAM	19.00	19.38	20.15	19.91
	100	CP	64QAM	16.63	16.72	18.27	18.10
	200	DFT-S	QPSK	18.03	21.71	18.43	21.92
	200	DFT-S	16QAM	17.49	21.04	18.08	21.30
	200	DFT-S	64QAM	17.01	18.59	17.84	18.78
	200	CP	QPSK	17.66	19.94	18.31	20.13
	200	CP	16QAM	17.24	18.41	17.92	18.44
	200	CP	64QAM	15.82	15.52	15.91	15.67

Note :The 200MHz BW is carrier aggregation by 2CC of 100MHz.

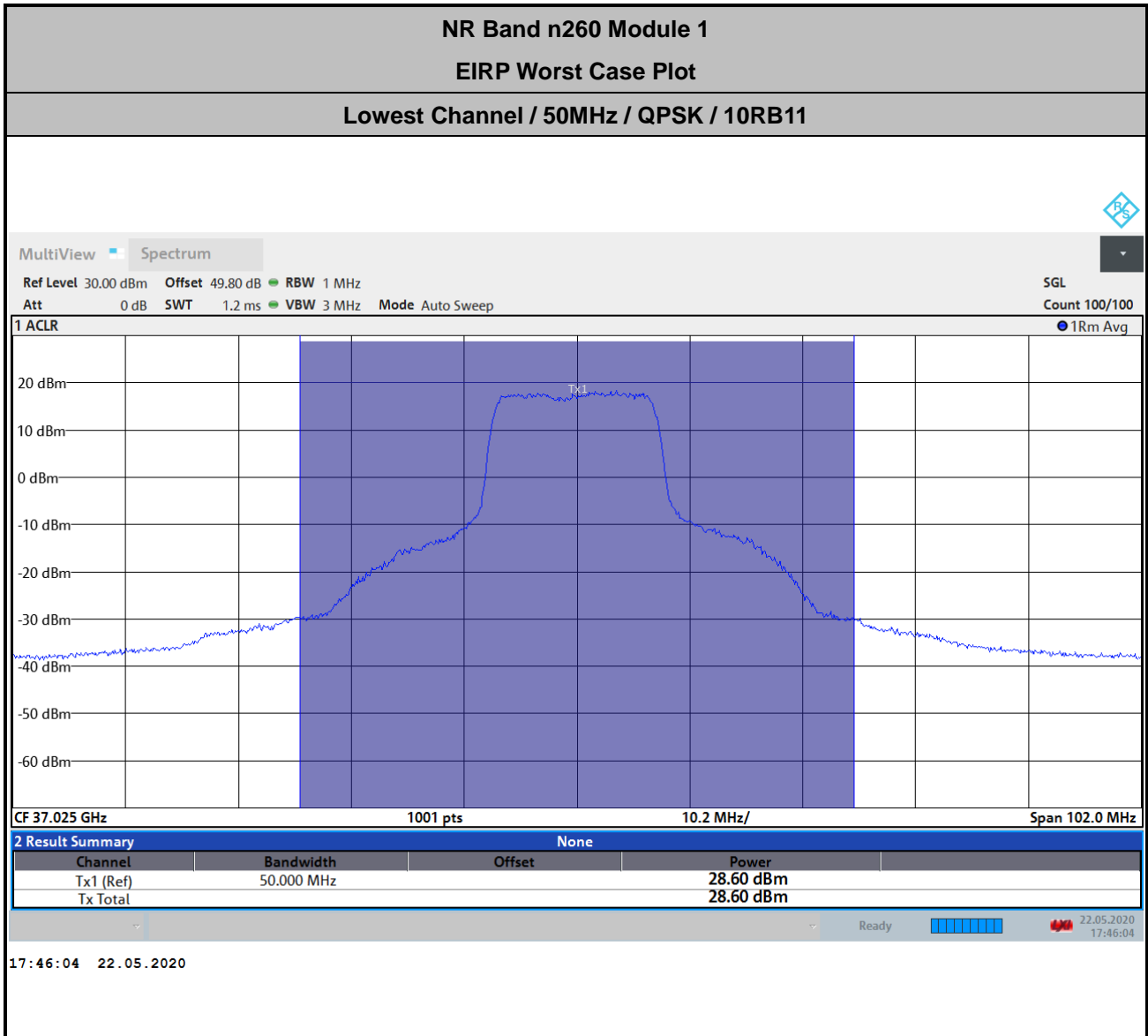

$$\begin{aligned}
 \text{Offset} &= \text{Antenna Factor (dB/m)} + \text{Cable Loss (dB)} + 107 + 20\log(D) - 104.8 \\
 &= 45.1 + 2.5 + 107 + 20\log(1) - 104.8 \\
 &= 49.8 \text{ (dB)}
 \end{aligned}$$



NR Band n261 Module 0

NR Band n261 Module 0 AGO							
Maximum Average EIRP [dBm]							
	BW [MHz]	Waveform	Modulation	Outer 1RB	Outer Full	Inner 1RB	Inner Full
Lowest	50	DFT-S	QPSK	22.16	22.03	24.27	24.22
	50	DFT-S	16QAM	20.30	20.39	22.31	21.98
	50	DFT-S	64QAM	18.68	18.35	20.07	19.89
	50	CP	QPSK	20.08	20.06	21.00	20.08
	50	CP	16QAM	18.88	19.05	19.71	18.82
	50	CP	64QAM	16.70	16.20	18.15	16.15
	100	DFT-S	QPSK	23.51	22.99	25.34	25.04
	100	DFT-S	16QAM	22.49	21.37	23.59	22.90
	100	DFT-S	64QAM	20.18	19.28	21.41	20.75
	100	CP	QPSK	20.89	20.75	21.70	21.80
	100	CP	16QAM	19.64	19.56	20.32	20.44
	100	CP	64QAM	16.90	17.02	18.10	18.61
	200	DFT-S	QPSK	16.42	18.79	16.06	18.67
	200	DFT-S	16QAM	16.00	18.27	15.63	18.09
	200	DFT-S	64QAM	16.00	16.14	15.89	16.01
	200	CP	QPSK	15.61	17.58	15.28	17.66
	200	CP	16QAM	16.02	15.88	15.72	15.53
	200	CP	64QAM	13.27	16.16	12.23	12.12

Note :The 200MHz BW is carrier aggregation by 2CC of 100MHz.



NR Band n261 Module 0 AGO							
Maximum Average EIRP [dBm]							
	BW [MHz]	Waveform	Modulation	Outer 1RB	Outer Full	Inner 1RB	Inner Full
Middle	50	DFT-S	QPSK	20.51	20.22	22.38	22.08
	50	DFT-S	16QAM	19.33	18.52	20.5	20.13
	50	DFT-S	64QAM	17.45	16.42	18.65	17.88
	50	CP	QPSK	18.24	17.79	18.97	17.77
	50	CP	16QAM	17.23	17.03	18.21	16.86
	50	CP	64QAM	14.34	14.11	15.73	14.02
	100	DFT-S	QPSK	21.91	21.70	24.09	23.64
	100	DFT-S	16QAM	20.51	20.15	22.02	21.52
	100	DFT-S	64QAM	18.81	17.97	20.27	19.43
	100	CP	QPSK	19.55	19.51	20.6	20.33
	100	CP	16QAM	18.42	18.63	19.62	19.26
	100	CP	64QAM	15.73	15.81	17.33	17.39
	200	DFT-S	QPSK	16.29	19.02	16.26	19.23
	200	DFT-S	16QAM	15.71	18.39	15.68	18.62
	200	DFT-S	64QAM	14.47	14.99	15.30	15.11
	200	CP	QPSK	16.45	18.08	16.42	18.16
	200	CP	16QAM	16.43	16.50	16.32	16.27
	200	CP	64QAM	14.00	14.07	13.26	13.45

Note :The 200MHz BW is carrier aggregation by 2CC of 100MHz.



NR Band n261 Module 0 AGO							
Maximum Average EIRP [dBm]							
	BW [MHz]	Waveform	Modulation	Outer 1RB	Outer Full	Inner 1RB	Inner Full
Highest	50	DFT-S	QPSK	20.47	20.88	23.21	23.13
	50	DFT-S	16QAM	18.38	19.44	20.36	20.91
	50	DFT-S	64QAM	17.30	17.35	19.55	18.80
	50	CP	QPSK	17.57	17.97	19.26	18.52
	50	CP	16QAM	16.56	17.46	18.44	17.79
	50	CP	64QAM	14.02	14.71	16.36	14.84
	100	DFT-S	QPSK	21.48	21.59	23.41	23.44
	100	DFT-S	16QAM	19.27	20.09	20.63	21.49
	100	DFT-S	64QAM	17.92	17.93	19.82	19.38
	100	CP	QPSK	18.30	19.33	19.32	20.51
	100	CP	16QAM	17.37	18.35	18.43	19.37
	100	CP	64QAM	15.03	15.27	16.54	17.48
	200	DFT-S	QPSK	17.80	19.11	18.46	19.34
	200	DFT-S	16QAM	16.97	18.57	17.06	18.72
	200	DFT-S	64QAM	14.56	16.87	16.12	17.00
	200	CP	QPSK	17.33	17.61	17.31	17.75
	200	CP	16QAM	15.35	15.75	16.17	16.61
	200	CP	64QAM	13.40	12.77	13.59	14.04

Note :The 200MHz BW is carrier aggregation by 2CC of 100MHz.



NR Band n261 Module 0 AG1							
Maximum Average EIRP [dBm]							
	BW [MHz]	Waveform	Modulation	Outer 1RB	Outer Full	Inner 1RB	Inner Full
Lowest	50	DFT-S	QPSK	21.2	21.27	23.09	23.33
	50	DFT-S	16QAM	18.98	19.68	20.36	21.41
	50	DFT-S	64QAM	17.63	17.57	19.19	19.09
	50	CP	QPSK	19.42	18.97	20.31	18.89
	50	CP	16QAM	17.33	18.11	18.34	17.74
	50	CP	64QAM	15.29	15.03	16.79	15.03
	100	DFT-S	QPSK	21.68	22.06	23.82	23.98
	100	DFT-S	16QAM	19.80	20.51	21.30	21.94
	100	DFT-S	64QAM	18.42	18.28	19.91	19.86
	100	CP	QPSK	20.34	19.79	21.11	20.69
	100	CP	16QAM	18.20	18.62	18.99	19.49
	100	CP	64QAM	16.36	16.18	17.44	17.49
	200	DFT-S	QPSK	17.87	18.69	18.39	19.08
	200	DFT-S	16QAM	15.56	16.31	18.00	18.59
	200	DFT-S	64QAM	14.79	15.22	16.34	16.15
	200	CP	QPSK	17.61	17.28	18.10	18.69
	200	CP	16QAM	16.12	15.80	16.73	17.76
	200	CP	64QAM	13.72	14.63	14.18	14.60

Note :The 200MHz BW is carrier aggregation by 2CC of 100MHz.



NR Band n261 Module 0 AG1							
Maximum Average EIRP [dBm]							
	BW [MHz]	Waveform	Modulation	Outer 1RB	Outer Full	Inner 1RB	Inner Full
Middle	50	DFT-S	QPSK	21.10	20.87	22.94	22.91
	50	DFT-S	16QAM	19.03	19.07	20.19	20.75
	50	DFT-S	64QAM	17.78	17.00	19.25	18.49
	50	CP	QPSK	18.75	19.19	19.61	20.02
	50	CP	16QAM	17.61	18.11	18.73	19.33
	50	CP	64QAM	15.38	15.22	16.55	16.72
	100	DFT-S	QPSK	22.39	22.32	24.42	24.23
	100	DFT-S	16QAM	20.20	20.78	21.70	22.18
	100	DFT-S	64QAM	19.17	18.57	20.77	20.13
	100	CP	QPSK	19.85	20.18	20.78	21.18
	100	CP	16QAM	18.48	19.20	19.65	20.10
	100	CP	64QAM	16.41	16.39	17.80	18.10
	200	DFT-S	QPSK	16.71	18.14	17.06	18.4
	200	DFT-S	16QAM	15.66	18.10	15.73	18.26
	200	DFT-S	64QAM	14.43	16.46	15.37	16.58
	200	CP	QPSK	16.10	18.04	16.37	18.02
	200	CP	16QAM	14.98	16.39	14.90	16.73
	200	CP	64QAM	13.99	14.45	14.07	14.97

Note :The 200MHz BW is carrier aggregation by 2CC of 100MHz.



NR Band n261 Module 0 AG1							
Maximum Average EIRP [dBm]							
	BW [MHz]	Waveform	Modulation	Outer 1RB	Outer Full	Inner 1RB	Inner Full
Highest	50	DFT-S	QPSK	20.32	21.14	23.39	23.47
	50	DFT-S	16QAM	18.84	19.52	21.48	21.48
	50	DFT-S	64QAM	17.50	17.37	20.03	18.74
	50	CP	QPSK	19.66	19.16	20.41	19.15
	50	CP	16QAM	17.30	18.03	18.87	17.85
	50	CP	64QAM	14.59	15.11	16.45	15.36
	100	DFT-S	QPSK	21.95	21.77	23.13	23.90
	100	DFT-S	16QAM	19.90	20.16	21.30	21.83
	100	DFT-S	64QAM	18.55	18.04	20.48	19.78
	100	CP	QPSK	19.66	20.25	20.69	21.38
	100	CP	16QAM	18.77	19.33	19.87	19.99
	100	CP	64QAM	16.45	16.54	17.72	18.04
	200	DFT-S	QPSK	15.64	17.57	15.57	17.36
	200	DFT-S	16QAM	15.53	17.66	15.45	17.42
	200	DFT-S	64QAM	16.69	16.05	16.35	15.80
	200	CP	QPSK	15.81	17.34	15.69	17.23
	200	CP	16QAM	16.58	16.08	16.30	15.70
	200	CP	64QAM	14.46	13.50	12.92	12.87

Note :The 200MHz BW is carrier aggregation by 2CC of 100MHz.



NR Band n261 Module 0 AG0+1							
Maximum Average EIRP [dBm]							
	BW [MHz]	Waveform	Modulation	Outer 1RB	Outer Full	Inner 1RB	Inner Full
Lowest	50	DFT-S	QPSK	21.38	21.08	22.27	22.26
	50	DFT-S	16QAM	20.03	19.41	21.59	21.00
	50	DFT-S	64QAM	17.49	17.36	18.84	19.15
	50	CP	QPSK	19.11	18.92	20.22	19.67
	50	CP	16QAM	19.24	17.73	19.11	18.83
	50	CP	64QAM	14.78	15.17	16.32	17.07
	100	DFT-S	QPSK	22.78	22.29	24.60	24.37
	100	DFT-S	16QAM	21.32	20.66	22.79	22.43
	100	DFT-S	64QAM	18.96	18.59	20.14	20.06
	100	CP	QPSK	19.56	18.97	20.44	19.71
	100	CP	16QAM	18.06	17.86	18.80	18.72
	100	CP	64QAM	15.35	15.16	16.70	16.73
	200	DFT-S	QPSK	20.22	21.75	20.39	21.89
	200	DFT-S	16QAM	18.80	20.41	19.99	21.36
	200	DFT-S	64QAM	18.45	18.71	19.13	19.09
	200	CP	QPSK	18.28	19.87	18.01	19.83
	200	CP	16QAM	17.45	18.19	17.14	18.04
	200	CP	64QAM	12.67	15.87	15.47	15.36

Note :The 200MHz BW is carrier aggregation by 2CC of 100MHz.



NR Band n261 Module 0 AG0+1							
Maximum Average EIRP [dBm]							
	BW [MHz]	Waveform	Modulation	Outer 1RB	Outer Full	Inner 1RB	Inner Full
Middle	50	DFT-S	QPSK	21.88	21.04	23.65	23.23
	50	DFT-S	16QAM	20.31	19.44	21.67	21.03
	50	DFT-S	64QAM	17.81	17.36	19.03	18.81
	50	CP	QPSK	18.04	17.65	18.63	18.55
	50	CP	16QAM	16.29	16.50	17.04	17.26
	50	CP	64QAM	14.01	13.82	15.17	15.50
	100	DFT-S	QPSK	23.00	22.23	23.69	23.19
	100	DFT-S	16QAM	21.41	20.68	22.89	22.26
	100	DFT-S	64QAM	19.04	18.53	20.25	20.00
	100	CP	QPSK	19.21	19.02	19.85	19.62
	100	CP	16QAM	17.71	17.85	18.23	18.81
	100	CP	64QAM	15.11	15.12	16.54	16.63
	200	DFT-S	QPSK	19.52	21.61	19.69	21.85
	200	DFT-S	16QAM	18.70	21.26	18.72	21.45
	200	DFT-S	64QAM	17.46	18.80	18.35	18.92
	200	CP	QPSK	17.13	19.55	17.19	19.71
	200	CP	16QAM	17.99	17.70	17.90	18.05
	200	CP	64QAM	11.22	15.16	15.54	15.48

Note :The 200MHz BW is carrier aggregation by 2CC of 100MHz.



NR Band n261 Module 0 AG0+1							
Maximum Average EIRP [dBm]							
	BW [MHz]	Waveform	Modulation	Outer 1RB	Outer Full	Inner 1RB	Inner Full
Highest	50	DFT-S	QPSK	22.15	22.33	23.85	23.91
	50	DFT-S	16QAM	20.59	20.61	23.19	22.72
	50	DFT-S	64QAM	18.06	18.67	20.37	20.42
	50	CP	QPSK	18.61	18.69	20.16	18.84
	50	CP	16QAM	16.61	17.59	18.28	18.77
	50	CP	64QAM	14.00	14.99	16.15	17.05
	100	DFT-S	QPSK	23.71	23.34	25.54	25.35
	100	DFT-S	16QAM	22.36	21.66	23.84	23.34
	100	DFT-S	64QAM	19.74	19.61	21.19	21.17
	100	CP	QPSK	20.08	20.19	20.79	21.14
	100	CP	16QAM	19.29	19.14	20.28	20.32
	100	CP	64QAM	15.74	16.50	17.16	18.09
	200	DFT-S	QPSK	19.86	21.42	20.26	21.47
	200	DFT-S	16QAM	19.32	21.15	19.34	21.13
	200	DFT-S	64QAM	18.76	19.49	19.25	19.45
	200	CP	QPSK	16.96	18.76	16.52	18.50
	200	CP	16QAM	16.28	17.18	16.02	16.80
	200	CP	64QAM	14.43	14.23	13.97	14.19

Note :The 200MHz BW is carrier aggregation by 2CC of 100MHz.

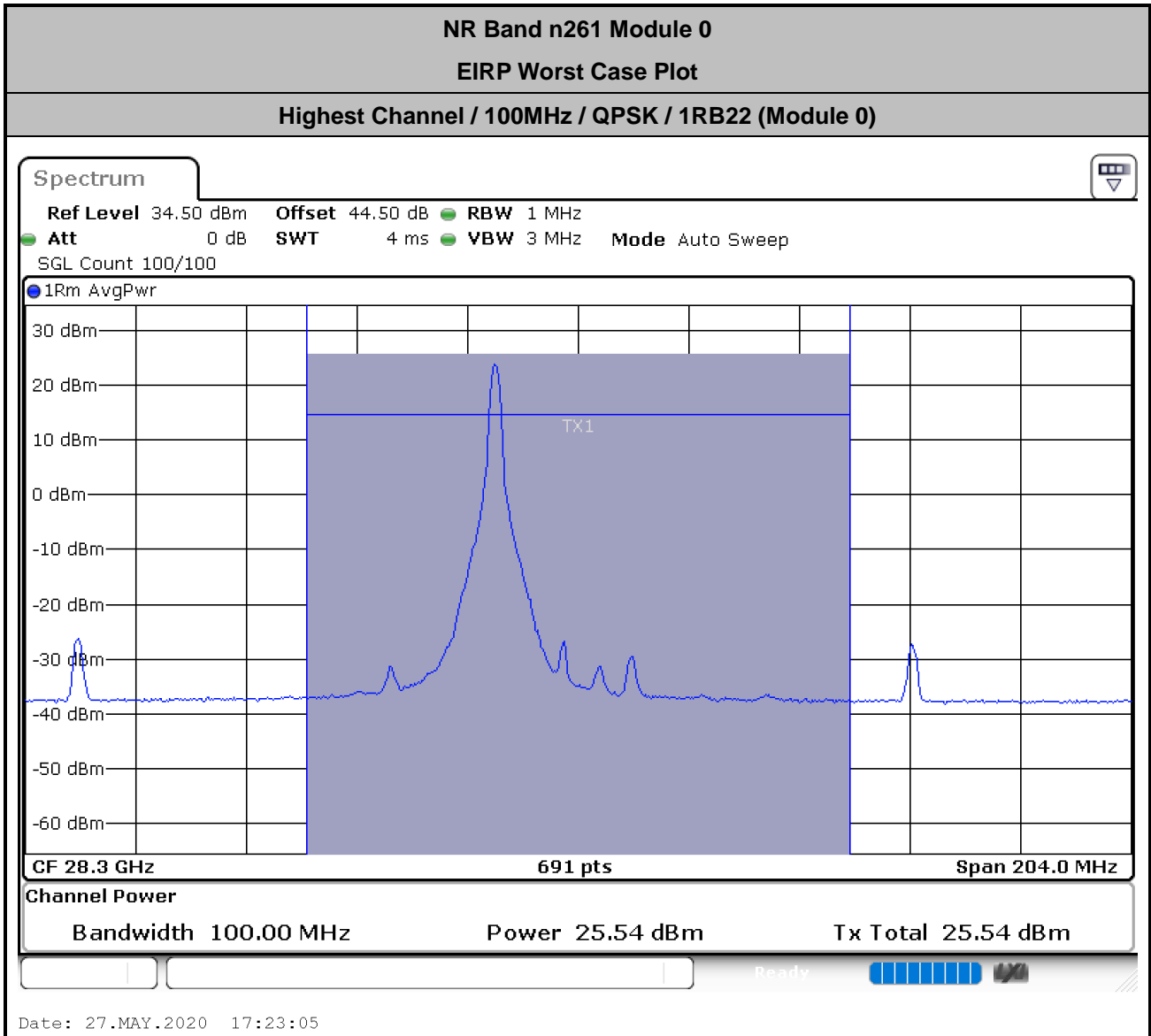

$$\begin{aligned}
 \text{Offset} &= \text{Antenna Factor (dB/m)} + \text{Cable Loss (dB)} + 107 + 20\log(D) - 104.8 \\
 &= 40.5 + 1.8 + 107 + 20\log(1) - 104.8 \\
 &= 44.5 \text{ (dB)}
 \end{aligned}$$



NR Band n261 Module 1

NR Band n261 Module 1 AGO							
Maximum Average EIRP [dBm]							
	BW [MHz]	Waveform	Modulation	Outer 1RB	Outer Full	Inner 1RB	Inner Full
Lowest	50	DFT-S	QPSK	20.99	21.52	23.14	23.51
	50	DFT-S	16QAM	19.27	20.00	20.76	21.35
	50	DFT-S	64QAM	17.18	17.8	18.74	19.40
	50	CP	QPSK	19.93	19.35	20.73	19.48
	50	CP	16QAM	18.27	18.21	19.47	17.84
	50	CP	64QAM	15.28	15.39	16.71	15.19
	100	DFT-S	QPSK	20.99	21.27	23.56	23.71
	100	DFT-S	16QAM	19.04	19.59	20.90	21.55
	100	DFT-S	64QAM	16.81	17.64	18.73	19.58
	100	CP	QPSK	19.48	18.99	20.74	20.71
	100	CP	16QAM	18.02	17.93	19.43	19.20
	100	CP	64QAM	14.98	15.66	16.68	17.26
	200	DFT-S	QPSK	15.77	18.45	15.82	18.77
	200	DFT-S	16QAM	14.90	17.88	14.87	18.20
	200	DFT-S	64QAM	15.56	14.49	15.73	15.77
	200	CP	QPSK	14.97	17.51	14.76	17.29
	200	CP	16QAM	14.80	15.55	14.43	15.45
	200	CP	64QAM	12.50	13.32	12.19	12.49

Note :The 200MHz BW is carrier aggregation by 2CC of 100MHz.



NR Band n261 Module 1 AG0							
Maximum Average EIRP [dBm]							
	BW [MHz]	Waveform	Modulation	Outer 1RB	Outer Full	Inner 1RB	Inner Full
Middle	50	DFT-S	QPSK	22.57	21.49	24.46	23.66
	50	DFT-S	16QAM	20.48	19.72	21.86	21.64
	50	DFT-S	64QAM	18.69	17.72	20.05	19.30
	50	CP	QPSK	20.83	19.20	21.47	19.25
	50	CP	16QAM	18.38	18.55	19.25	18.08
	50	CP	64QAM	16.13	15.60	17.50	15.21
	100	DFT-S	QPSK	22.11	20.84	23.79	22.94
	100	DFT-S	16QAM	20.36	19.35	21.81	20.74
	100	DFT-S	64QAM	18.66	17.16	19.94	18.77
	100	CP	QPSK	19.20	18.77	20.07	19.88
	100	CP	16QAM	19.24	17.83	19.87	18.75
	100	CP	64QAM	15.92	15.01	17.31	16.92
	200	DFT-S	QPSK	15.38	18.78	15.75	18.8
	200	DFT-S	16QAM	15.35	18.23	15.93	18.24
	200	DFT-S	64QAM	16.18	16.40	16.70	16.41
	200	CP	QPSK	15.08	17.97	15.58	17.66
	200	CP	16QAM	15.92	16.53	16.19	16.66
	200	CP	64QAM	9.28	13.34	13.49	14.34

Note :The 200MHz BW is carrier aggregation by 2CC of 100MHz.



NR Band n261 Module 1 AG0							
Maximum Average EIRP [dBm]							
	BW [MHz]	Waveform	Modulation	Outer 1RB	Outer Full	Inner 1RB	Inner Full
Highest	50	DFT-S	QPSK	21.20	21.13	23.19	23.27
	50	DFT-S	16QAM	19.80	19.52	21.03	21.23
	50	DFT-S	64QAM	18.71	17.44	20.15	18.72
	50	CP	QPSK	18.83	18.91	19.79	19.97
	50	CP	16QAM	18.63	18.28	19.72	19.10
	50	CP	64QAM	15.90	15.35	17.41	16.60
	100	DFT-S	QPSK	21.82	21.63	23.91	23.91
	100	DFT-S	16QAM	20.21	20.09	21.64	21.77
	100	DFT-S	64QAM	19.29	17.89	20.95	19.55
	100	CP	QPSK	19.62	19.52	20.46	20.63
	100	CP	16QAM	19.18	18.74	20.19	19.50
	100	CP	64QAM	16.54	15.79	18.01	17.64
	200	DFT-S	QPSK	15.59	19.54	16.54	19.54
	200	DFT-S	16QAM	15.60	19.03	16.66	19.15
	200	DFT-S	64QAM	16.76	17.13	17.53	17.05
	200	CP	QPSK	15.36	18.77	16.35	18.31
	200	CP	16QAM	16.08	17.26	16.96	17.92
	200	CP	64QAM	9.73	13.64	14.34	14.62

Note :The 200MHz BW is carrier aggregation by 2CC of 100MHz.



NR Band n261 Module 1 AG1							
Maximum Average EIRP [dBm]							
	BW [MHz]	Waveform	Modulation	Outer 1RB	Outer Full	Inner 1RB	Inner Full
Lowest	50	DFT-S	QPSK	20.73	20.49	22.81	22.51
	50	DFT-S	16QAM	18.84	18.88	20.07	20.50
	50	DFT-S	64QAM	16.96	16.81	18.77	18.35
	50	CP	QPSK	17.72	18.33	18.92	18.65
	50	CP	16QAM	16.35	17.39	17.49	17.21
	50	CP	64QAM	14.24	14.54	16.02	14.33
	100	DFT-S	QPSK	21.09	20.58	23.17	22.72
	100	DFT-S	16QAM	18.71	18.97	20.28	20.71
	100	DFT-S	64QAM	17.40	16.75	19.02	18.47
	100	CP	QPSK	18.03	18.48	19.15	19.32
	100	CP	16QAM	16.50	17.26	17.73	18.14
	100	CP	64QAM	14.32	14.74	16.01	16.38
	200	DFT-S	QPSK	14.74	18.74	14.91	18.89
	200	DFT-S	16QAM	14.34	18.15	14.62	18.14
	200	DFT-S	64QAM	15.53	15.66	15.53	15.85
	200	CP	QPSK	14.46	17.61	14.74	17.51
	200	CP	16QAM	15.08	15.72	15.14	15.37
	200	CP	64QAM	9.57	13.51	12.79	13.07

Note :The 200MHz BW is carrier aggregation by 2CC of 100MHz.



NR Band n261 Module 1 AG1							
Maximum Average EIRP [dBm]							
	BW [MHz]	Waveform	Modulation	Outer 1RB	Outer Full	Inner 1RB	Inner Full
Middle	50	DFT-S	QPSK	20.73	20.26	22.53	22.41
	50	DFT-S	16QAM	19.20	18.59	20.39	20.49
	50	DFT-S	64QAM	18.21	16.59	19.53	17.98
	50	CP	QPSK	18.59	18.05	19.16	18.21
	50	CP	16QAM	18.24	17.38	19.06	17.01
	50	CP	64QAM	15.67	14.42	16.82	14.16
	100	DFT-S	QPSK	21.10	20.48	21.17	21.19
	100	DFT-S	16QAM	19.34	18.84	19.36	19.74
	100	DFT-S	64QAM	18.60	16.70	18.75	17.33
	100	CP	QPSK	18.93	18.39	19.62	19.36
	100	CP	16QAM	18.54	17.47	19.40	18.23
	100	CP	64QAM	16.01	14.58	17.29	16.33
	200	DFT-S	QPSK	15.11	18.54	15.68	18.62
	200	DFT-S	16QAM	15.06	18.06	15.65	18.21
	200	DFT-S	64QAM	15.94	16.12	16.58	16.30
	200	CP	QPSK	14.95	17.70	15.55	17.43
	200	CP	16QAM	15.65	16.33	16.11	16.56
	200	CP	64QAM	9.66	13.77	13.31	13.97

Note :The 200MHz BW is carrier aggregation by 2CC of 100MHz.



NR Band n261 Module 1 AG1							
Maximum Average EIRP [dBm]							
	BW [MHz]	Waveform	Modulation	Outer 1RB	Outer Full	Inner 1RB	Inner Full
Highest	50	DFT-S	QPSK	20.33	20.40	22.45	22.54
	50	DFT-S	16QAM	18.76	18.77	20.37	20.57
	50	DFT-S	64QAM	17.65	16.74	19.47	18.08
	50	CP	QPSK	18.09	18.20	19.02	18.35
	50	CP	16QAM	17.70	17.53	18.90	17.23
	50	CP	64QAM	15.14	14.61	16.67	14.27
	100	DFT-S	QPSK	20.68	20.44	22.61	22.56
	100	DFT-S	16QAM	19.00	18.86	20.41	20.50
	100	DFT-S	64QAM	18.29	16.68	19.79	18.26
	100	CP	QPSK	18.53	18.31	19.24	19.34
	100	CP	16QAM	18.04	17.42	18.91	18.19
	100	CP	64QAM	15.49	14.53	16.79	16.32
	200	DFT-S	QPSK	15.18	19.18	16.02	19.27
	200	DFT-S	16QAM	15.12	18.57	16.22	18.79
	200	DFT-S	64QAM	16.14	16.70	17.01	16.67
	200	CP	QPSK	15.08	18.19	16.09	18.30
	200	CP	16QAM	15.74	16.86	16.55	16.98
	200	CP	64QAM	13.77	14.23	17.42	14.30

Note :The 200MHz BW is carrier aggregation by 2CC of 100MHz.



NR Band n261 Module 1 AG0+1							
Maximum Average EIRP [dBm]							
	BW [MHz]	Waveform	Modulation	Outer 1RB	Outer Full	Inner 1RB	Inner Full
Lowest	50	DFT-S	QPSK	23.89	23.94	24.65	24.72
	50	DFT-S	16QAM	22.45	22.28	23.83	23.53
	50	DFT-S	64QAM	19.89	20.20	21.25	21.82
	50	CP	QPSK	18.56	18.89	19.75	19.52
	50	CP	16QAM	17.41	17.62	18.56	18.89
	50	CP	64QAM	15.00	14.96	16.64	18.96
	100	DFT-S	QPSK	24.03	23.83	25.01	24.9
	100	DFT-S	16QAM	22.72	22.20	24.42	23.86
	100	DFT-S	64QAM	19.87	20.01	21.59	21.65
	100	CP	QPSK	18.87	18.63	19.79	19.72
	100	CP	16QAM	17.86	17.53	18.73	18.47
	100	CP	64QAM	15.31	17.59	17.02	16.49
	200	DFT-S	QPSK	18.30	21.61	18.40	21.84
	200	DFT-S	16QAM	17.64	21.03	17.76	21.18
	200	DFT-S	64QAM	18.56	18.12	18.64	18.82
	200	CP	QPSK	15.96	17.95	16.05	17.84
	200	CP	16QAM	15.34	15.97	15.55	15.93
	200	CP	64QAM	10.55	13.75	13.44	13.32

Note :The 200MHz BW is carrier aggregation by 2CC of 100MHz.



NR Band n261 Module 1 AG0+1							
Maximum Average EIRP [dBm]							
	BW [MHz]	Waveform	Modulation	Outer 1RB	Outer Full	Inner 1RB	Inner Full
Middle	50	DFT-S	QPSK	24.90	23.97	25.62	25.21
	50	DFT-S	16QAM	23.41	22.91	24.73	24.09
	50	DFT-S	64QAM	20.54	20.34	22.17	21.96
	50	CP	QPSK	18.36	18.46	19.33	19.52
	50	CP	16QAM	17.58	17.29	18.60	18.48
	50	CP	64QAM	15.04	14.60	16.58	16.21
	100	DFT-S	QPSK	24.85	23.80	25.74	25.26
	100	DFT-S	16QAM	23.52	22.34	25.21	24.23
	100	DFT-S	64QAM	20.87	20.25	22.61	21.94
	100	CP	QPSK	18.27	18.54	19.61	19.78
	100	CP	16QAM	17.95	17.33	19.01	18.37
	100	CP	64QAM	15.49	14.70	17.03	16.34
	200	DFT-S	QPSK	18.26	21.67	18.73	21.72
	200	DFT-S	16QAM	18.22	21.16	18.80	21.24
	200	DFT-S	64QAM	19.07	19.27	19.65	19.37
	200	CP	QPSK	15.98	17.49	16.73	18.52
	200	CP	16QAM	16.03	16.08	17.05	16.76
	200	CP	64QAM	10.48	14.15	13.66	14.08

Note :The 200MHz BW is carrier aggregation by 2CC of 100MHz.



NR Band n261 Module 1 AG0+1							
Maximum Average EIRP [dBm]							
	BW [MHz]	Waveform	Modulation	Outer 1RB	Outer Full	Inner 1RB	Inner Full
Highest	50	DFT-S	QPSK	24.78	23.99	25.39	25.08
	50	DFT-S	16QAM	23.20	22.45	24.55	23.92
	50	DFT-S	64QAM	20.57	20.44	21.98	21.98
	50	CP	QPSK	18.65	18.62	19.59	19.62
	50	CP	16QAM	17.71	17.38	18.64	18.65
	50	CP	64QAM	15.06	14.75	16.64	16.14
	100	DFT-S	QPSK	24.47	23.89	26.21	26.20
	100	DFT-S	16QAM	23.32	22.23	24.75	24.29
	100	DFT-S	64QAM	21.42	20.15	22.58	22.02
	100	CP	QPSK	18.96	18.45	19.84	19.77
	100	CP	16QAM	18.10	17.50	18.93	18.65
	100	CP	64QAM	15.18	14.73	16.59	16.64
	200	DFT-S	QPSK	18.40	22.37	19.30	22.42
	200	DFT-S	16QAM	18.38	21.82	19.46	21.98
	200	DFT-S	64QAM	19.47	19.93	20.29	19.87
	200	CP	QPSK	16.36	18.1	16.95	18.05
	200	CP	16QAM	16.44	16.6	17.08	16.49
	200	CP	64QAM	9.77	14.1	14.78	14.91

Note :The 200MHz BW is carrier aggregation by 2CC of 100MHz.

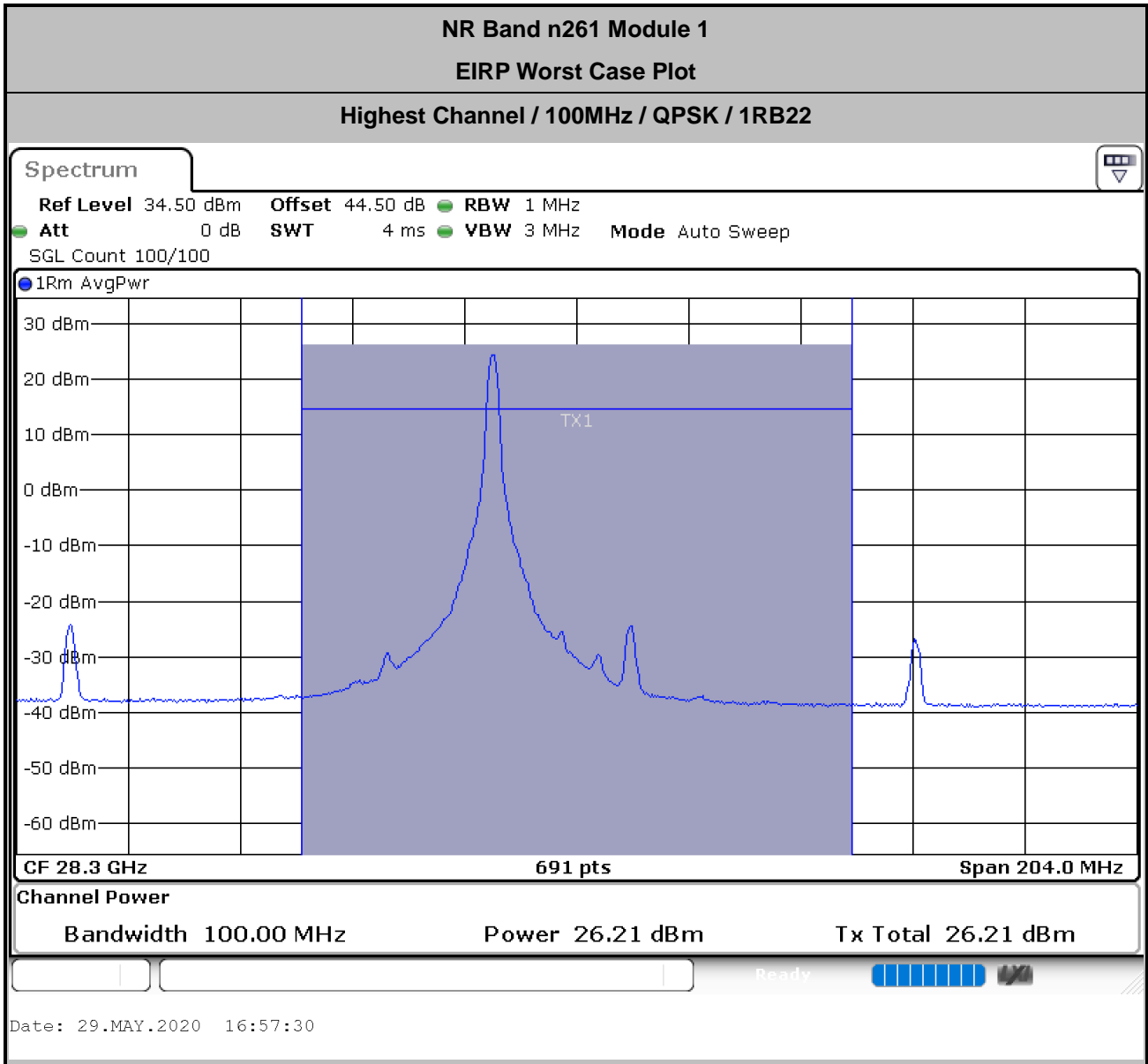

$$\begin{aligned} \text{Offset} &= \text{Antenna Factor (dB/m)} + \text{Cable Loss (dB)} + 107 + 20\log(D) - 104.8 \\ &= 40.5 + 1.8 + 107 + 20\log(1) - 104.8 \\ &= 44.5 \text{ (dB)} \end{aligned}$$



NR Band n260 AGO

Occupied Bandwidth

Mode	DFT-s-OFDM Module 0 NR Band n260 : 99%OBW(MHz)								
BW	50MHz			100MHz			200MHz		
Mod.	QPSK	16QAM	64QAM	QPSK	16QAM	64QAM	QPSK	16QAM	64QAM
Lowest CH	45.21	45.21	45.19	90.20	90.56	90.33	188.14	185.75	188.28
Middle CH	45.41	45.19	45.25	90.27	90.30	90.19	188.75	188.85	184.56
Highest CH	45.44	45.05	45.16	90.32	90.34	90.24	187.75	188.12	185.38

Mode	DFT-s-OFDM Module 1 NR Band n260 : 99%OBW(MHz)								
BW	50MHz			100MHz			200MHz		
Mod.	QPSK	16QAM	64QAM	QPSK	16QAM	64QAM	QPSK	16QAM	64QAM
Lowest CH	45.13	45.15	45.18	90.61	90.56	90.11	187.26	188.24	185.6
Middle CH	45.16	45.35	45.36	90.75	90.63	90.20	188.29	188.31	188.84
Highest CH	45.16	45.37	45.42	90.44	90.64	90.31	188.35	188.67	186.49

Mode	CP-OFDM Module 0 NR Band n260 : 99%OBW(MHz)								
BW	50MHz			100MHz			200MHz		
Mod.	QPSK	16QAM	64QAM	QPSK	16QAM	64QAM	QPSK	16QAM	64QAM
Lowest CH	45.53	45.23	45.31	92.89	92.89	92.51	190.23	186.99	189.78
Middle CH	45.38	45.37	45.16	92.85	92.80	92.55	190.41	186.66	190.00
Highest CH	45.35	45.33	45.24	93.08	92.96	92.84	190.17	186.98	189.93

Mode	CP-OFDM Module 1 NR Band n260 : 99%OBW(MHz)								
BW	50MHz			100MHz			200MHz		
Mod.	QPSK	16QAM	64QAM	QPSK	16QAM	64QAM	QPSK	16QAM	64QAM
Lowest CH	45.38	45.19	45.06	90.33	90.28	90.18	190.19	187.30	189.63
Middle CH	45.14	45.13	45.07	92.73	93.18	92.82	190.16	186.46	190.92
Highest CH	45.16	45.17	45.21	93.06	93.23	92.70	190.67	187.59	190.39



DFT-s-OFDM Module 0

NR Band n260

Lowest Channel / 50MHz / QPSK

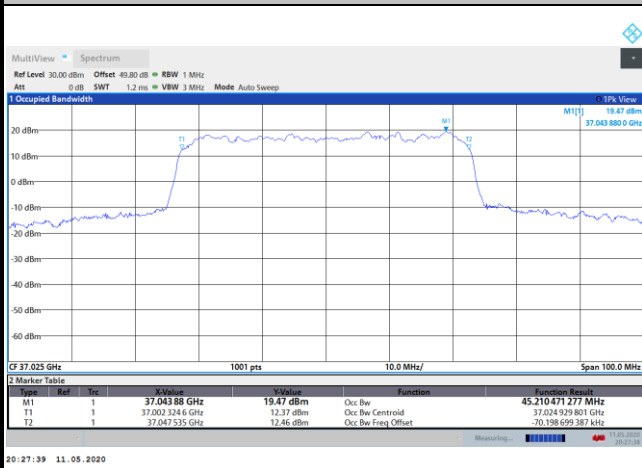

Lowest Channel / 50MHz / 16QAM

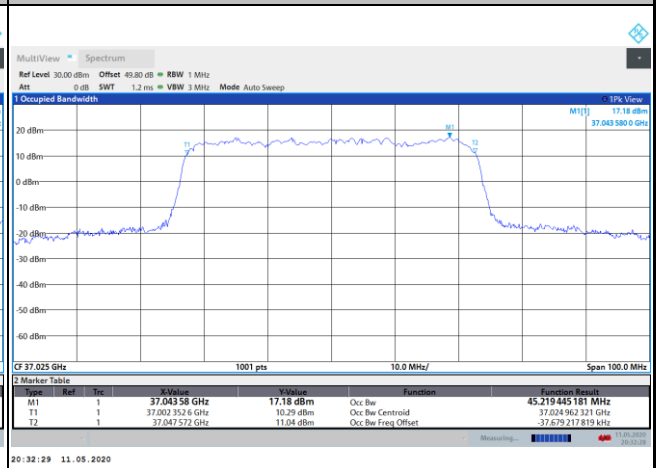

Middle Channel / 50MHz / QPSK

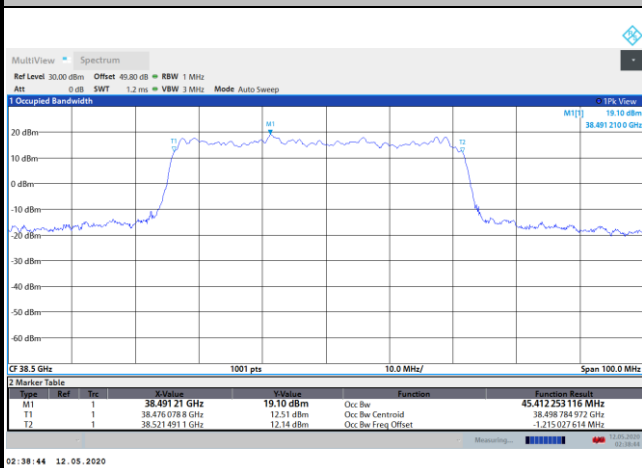

Middle Channel / 50MHz / 16QAM

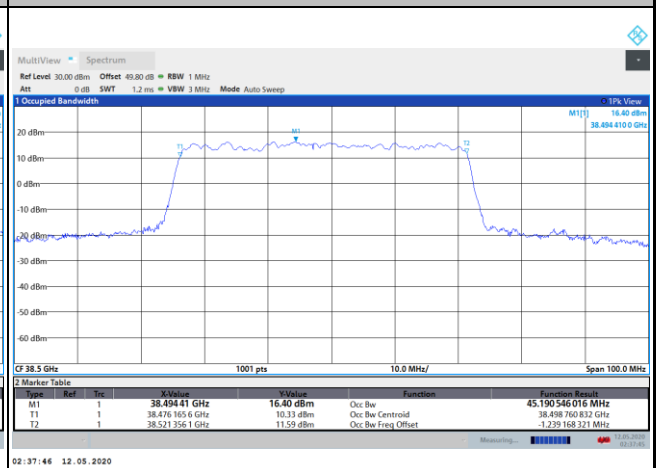

Highest Channel / 50MHz / QPSK

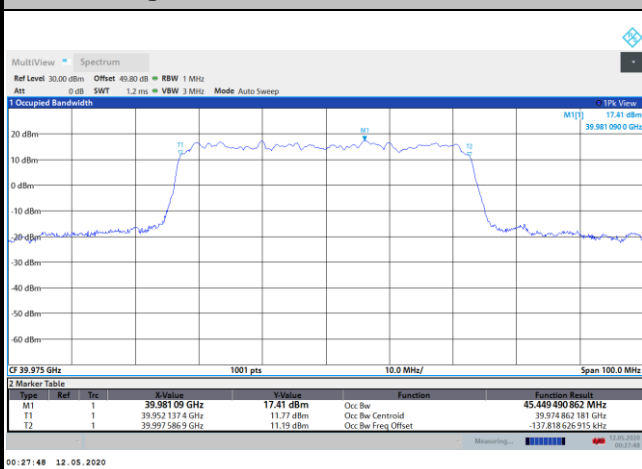

Highest Channel / 50MHz / 16QAM

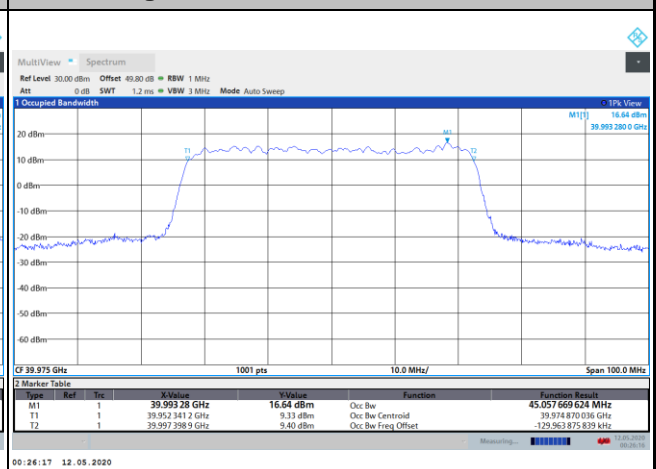



DFT-s-OFDM Module 0

NR Band n260

Lowest Channel / 50MHz / 64QAM

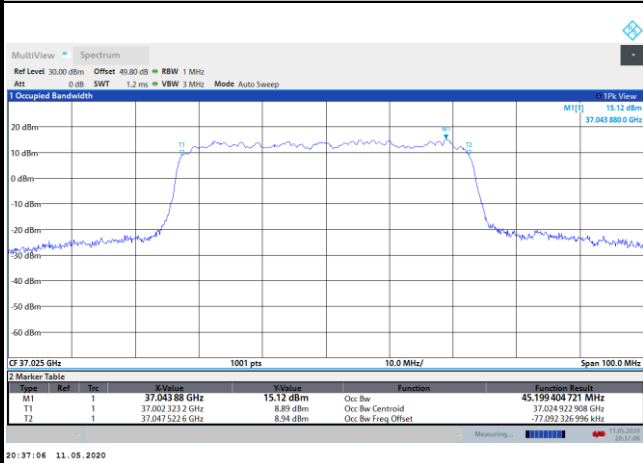

Lowest Channel / 100MHz / QPSK

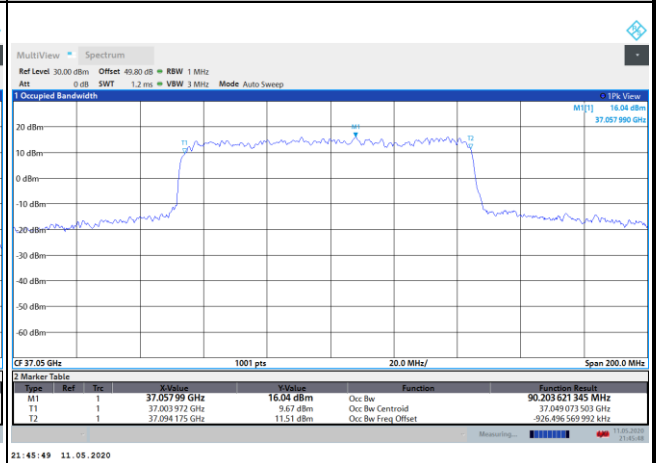

Middle Channel / 50MHz / 64QAM

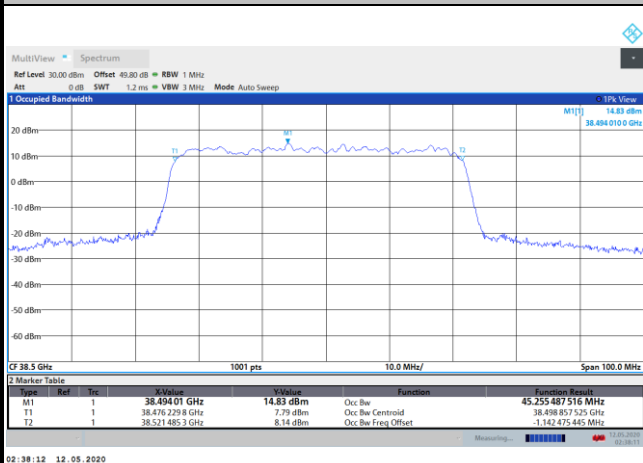

Middle Channel / 100MHz / QPSK

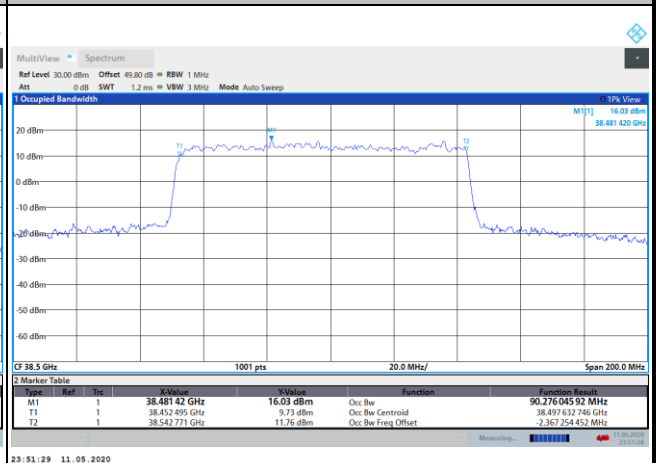

Highest Channel / 50MHz / 64QAM

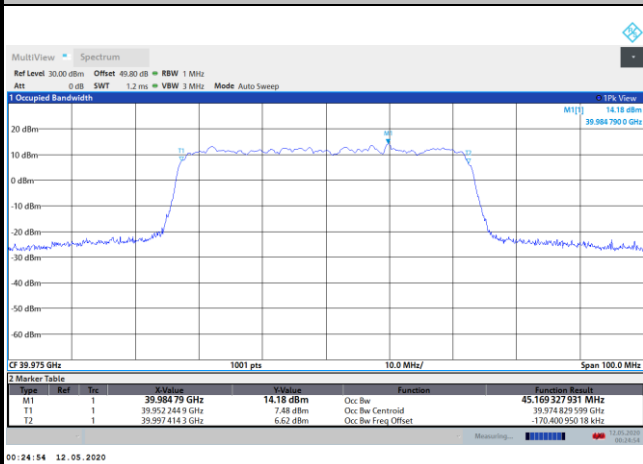

Highest Channel / 100MHz / QPSK

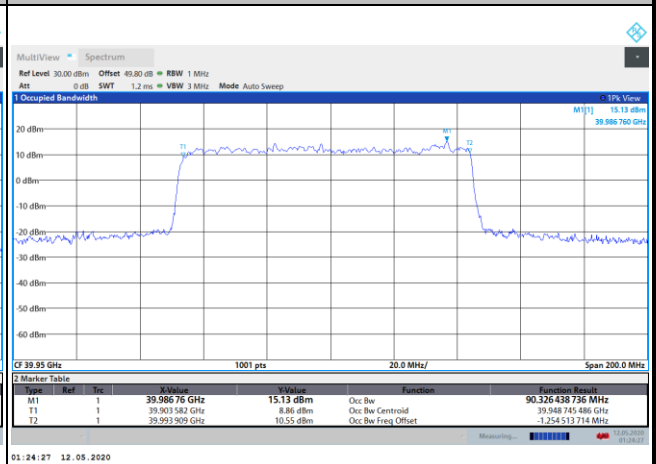



DFT-s-OFDM Module 0

NR Band n260

Lowest Channel / 100MHz / 16QAM

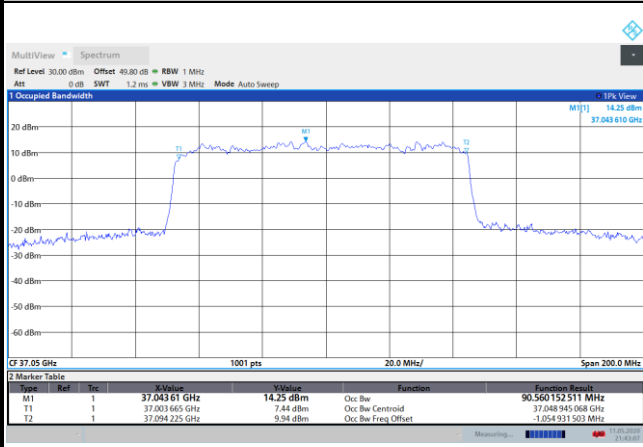

Lowest Channel / 100MHz / 64QAM

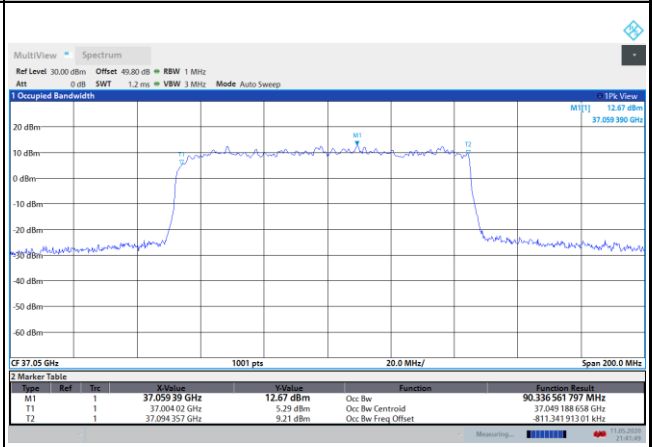

Middle Channel / 100MHz / 16QAM

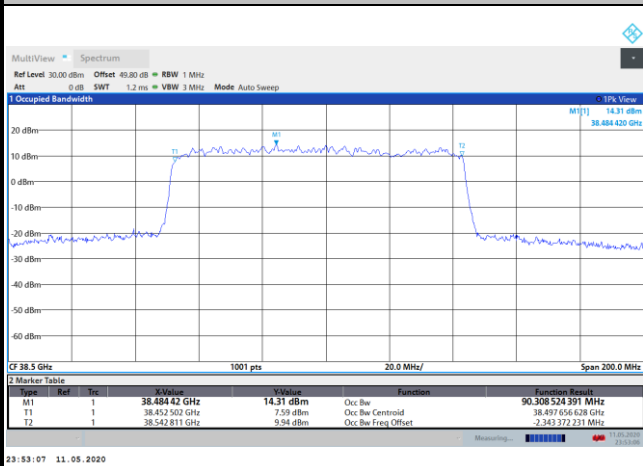

Middle Channel / 100MHz / 64QAM

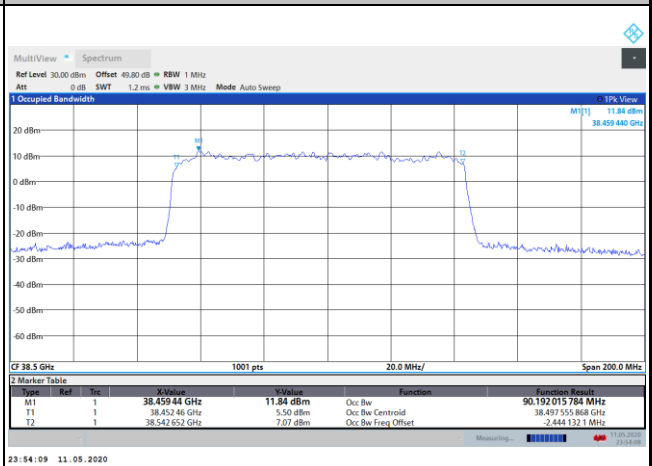

Highest Channel / 100MHz / 16QAM

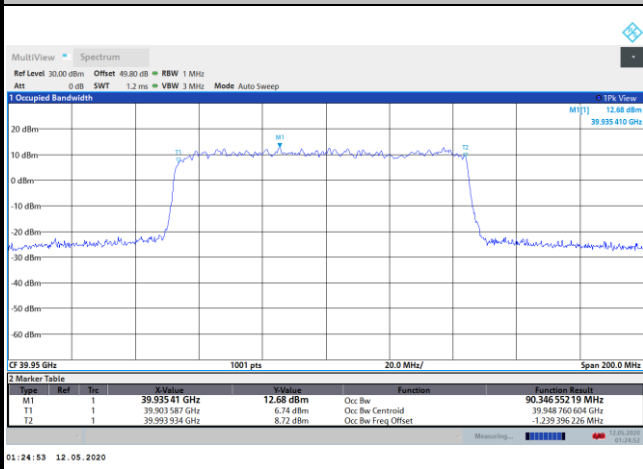

Highest Channel / 100MHz / 64QAM

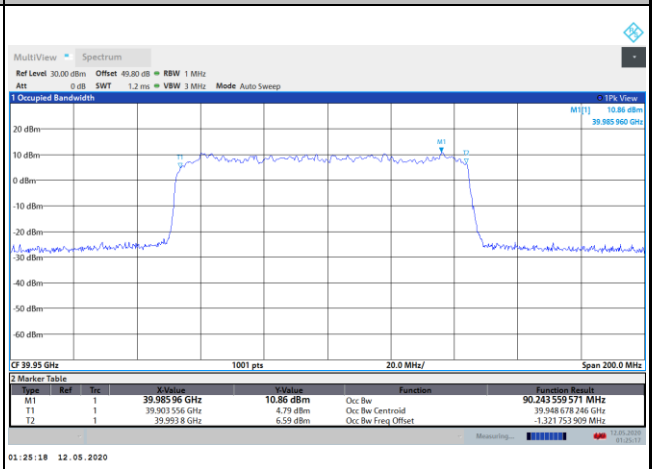



DFT-s-OFDM Module 0

NR Band n260

Lowest Channel / 200MHz / QPSK

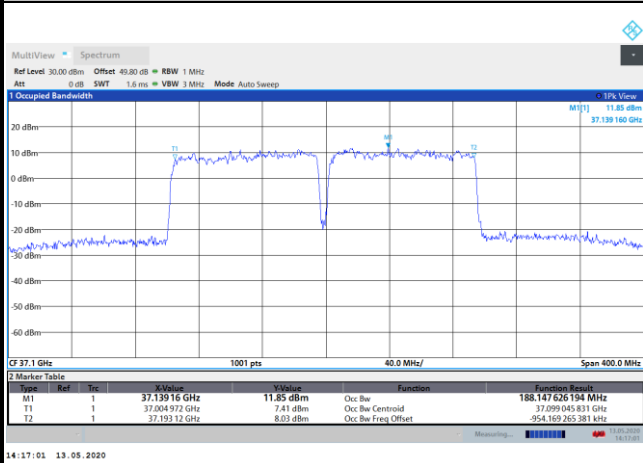

Lowest Channel / 200MHz / 16QAM

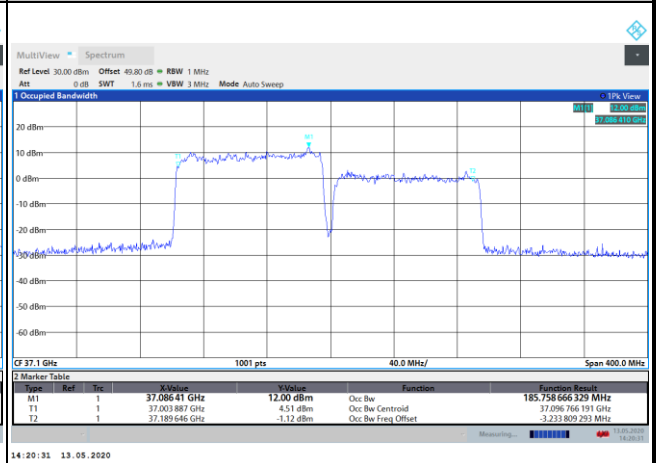

Middle Channel / 200MHz / QPSK

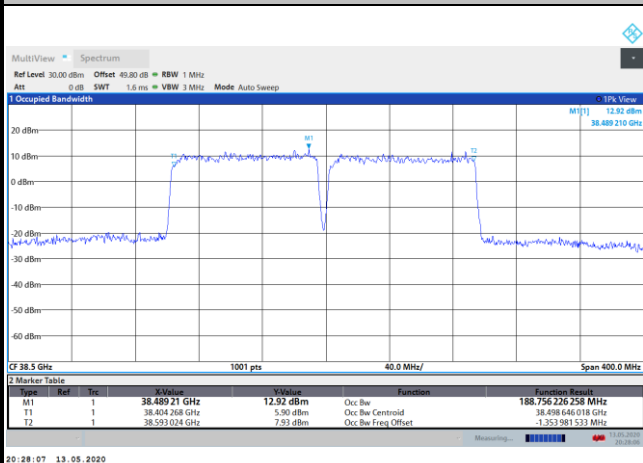

Middle Channel / 200MHz / 16QAM

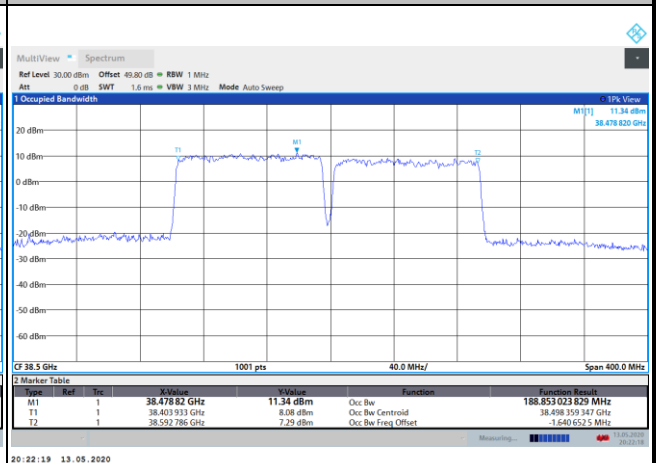

Highest Channel / 200MHz / QPSK

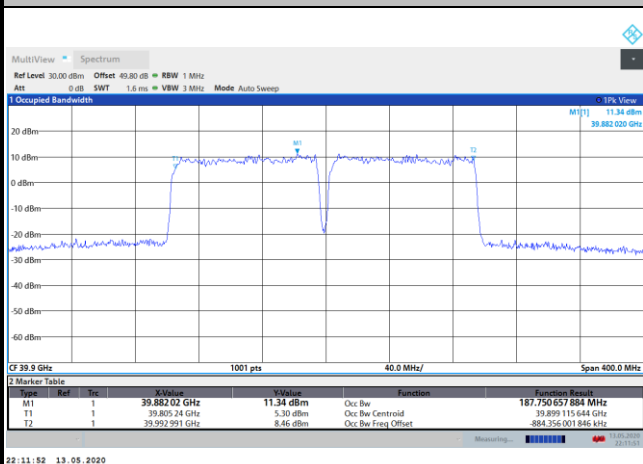

Highest Channel / 200MHz / 16QAM

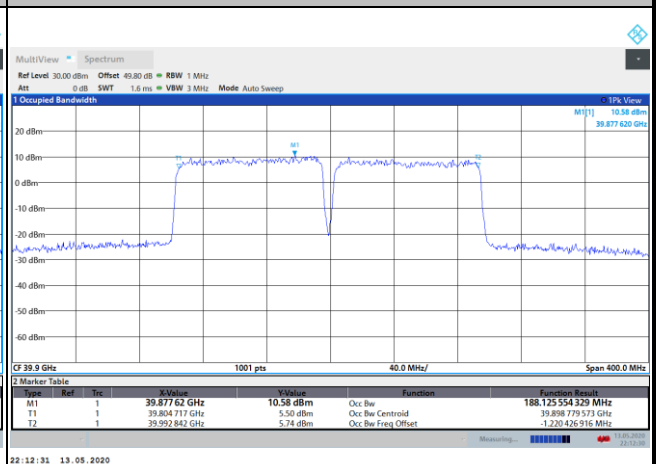



DFT-s-OFDM Module 0

NR Band n260

Lowest Channel / 200MHz / 64QAM

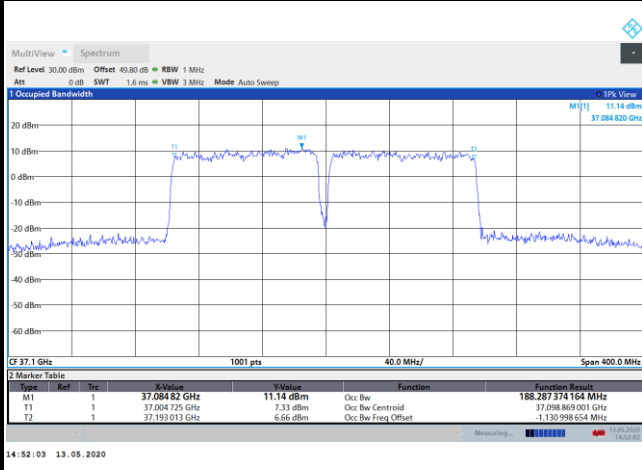

intentionally blank

Middle Channel / 200MHz / 64QAM

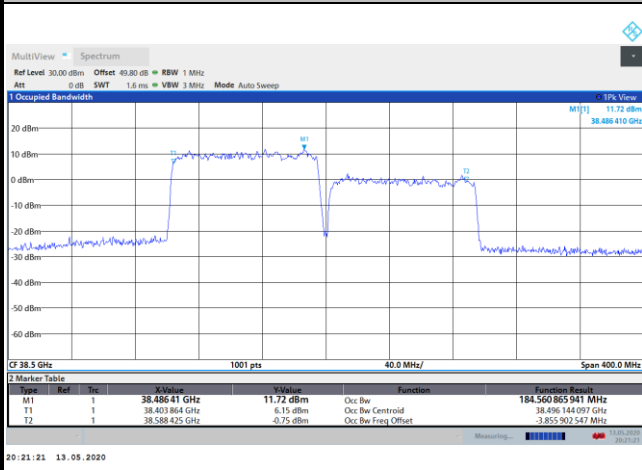

intentionally blank

Highest Channel / 200MHz / 64QAM

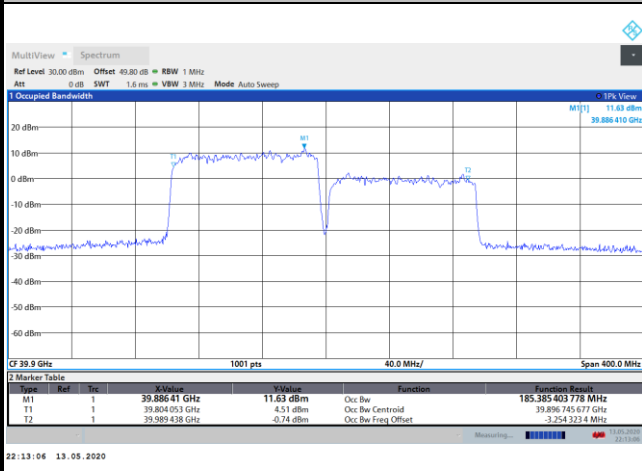

intentionally blank



DFT-s-OFDM Module 1

NR Band n260

Lowest Channel / 50MHz / QPSK

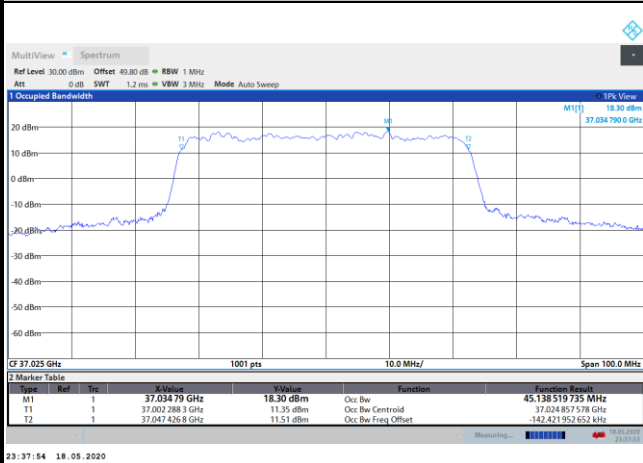

Lowest Channel / 50MHz / 16QAM

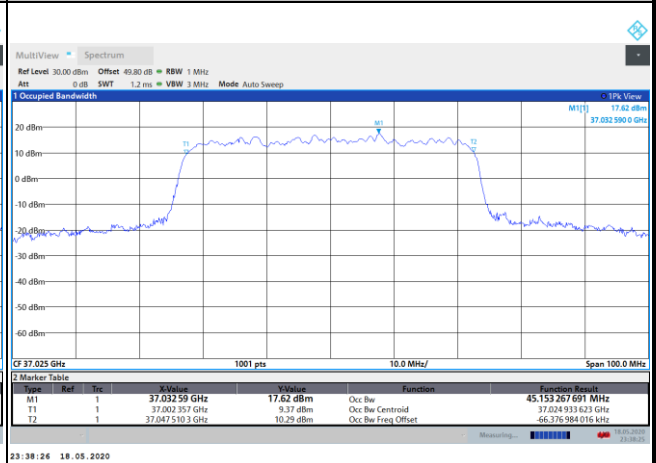

Middle Channel / 50MHz / QPSK

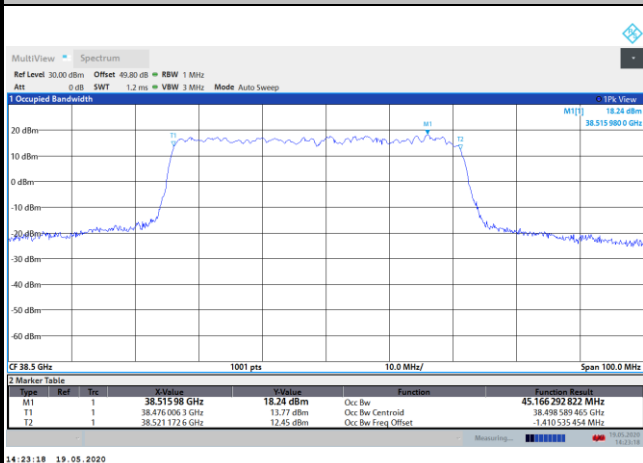

Middle Channel / 50MHz / 16QAM

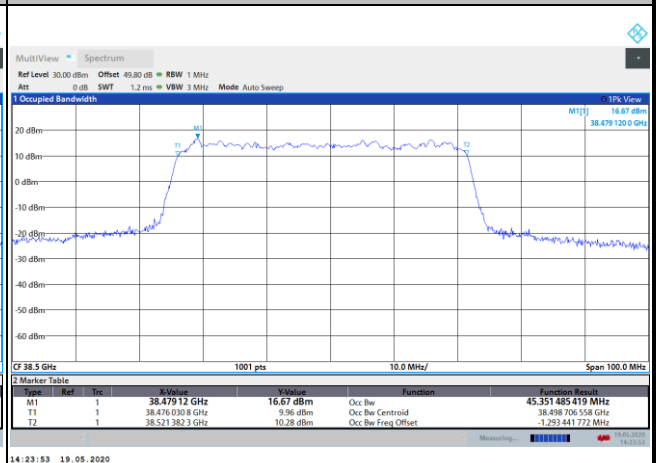

Highest Channel / 50MHz / QPSK

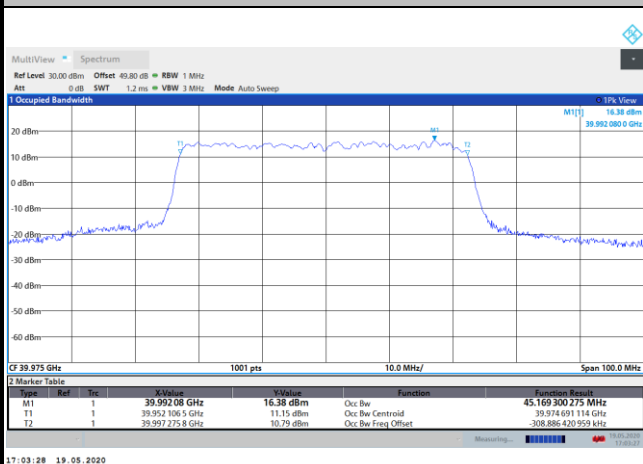

Highest Channel / 50MHz / 16QAM

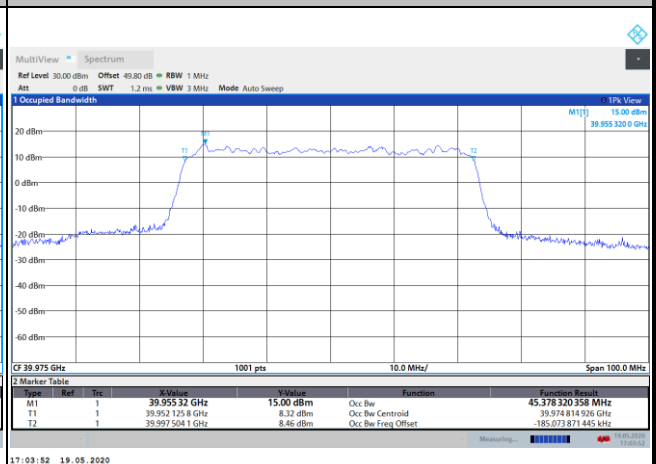



DFT-s-OFDM Module 1

NR Band n260

Lowest Channel / 50MHz / 64QAM

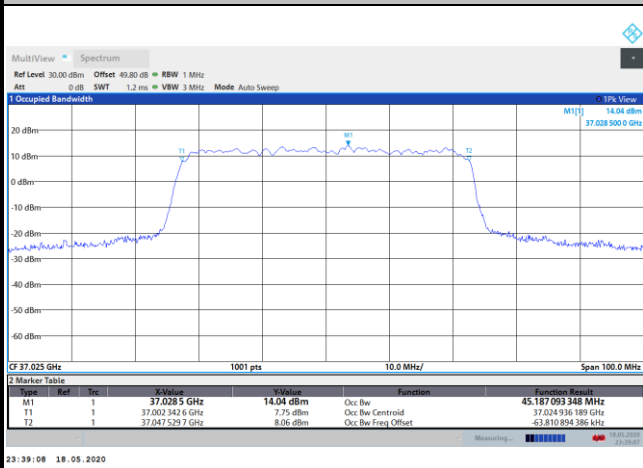

Lowest Channel / 100MHz / QPSK

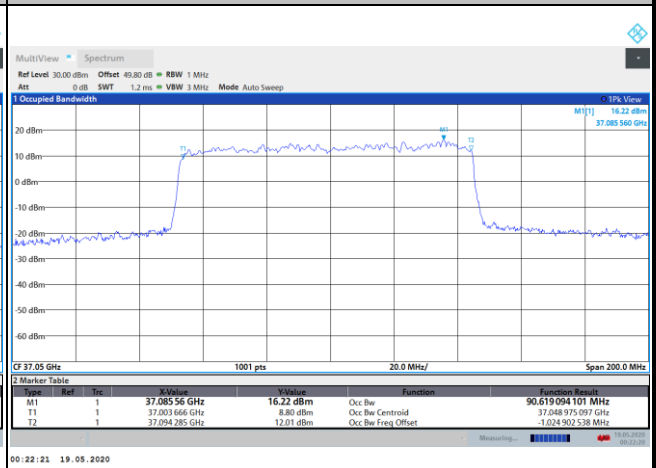

Middle Channel / 50MHz / 64QAM

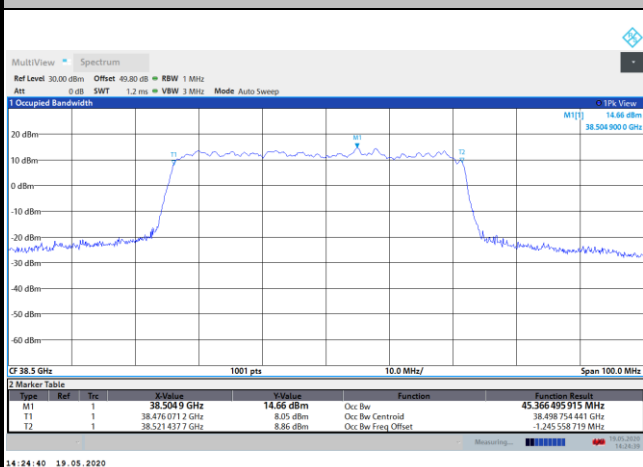

Middle Channel / 100MHz / QPSK

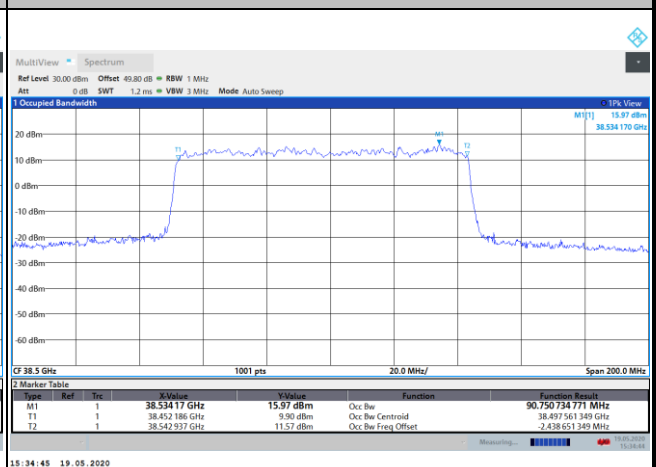

Highest Channel / 50MHz / 64QAM

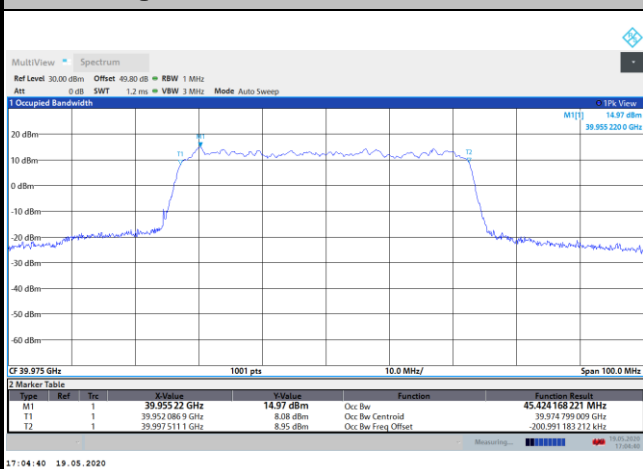

Highest Channel / 100MHz / QPSK

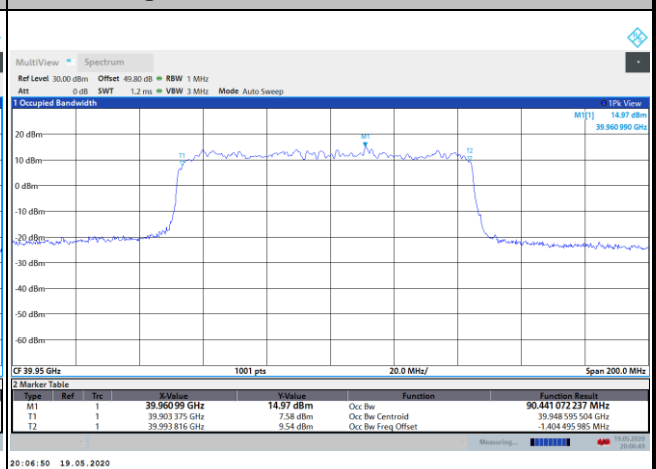



DFT-s-OFDM Module 1

NR Band n260

Lowest Channel / 100MHz / 16QAM

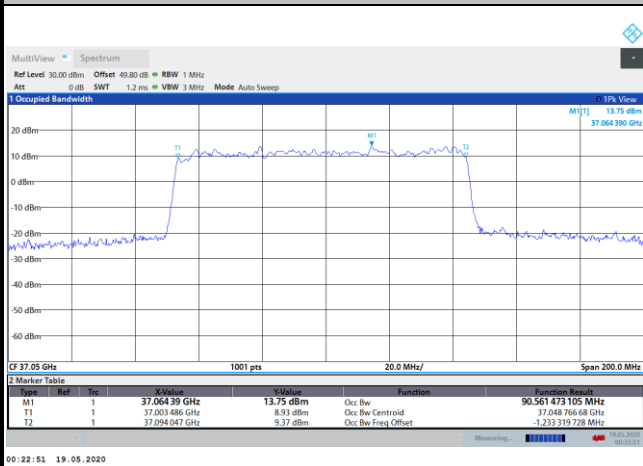

Lowest Channel / 100MHz / 64QAM

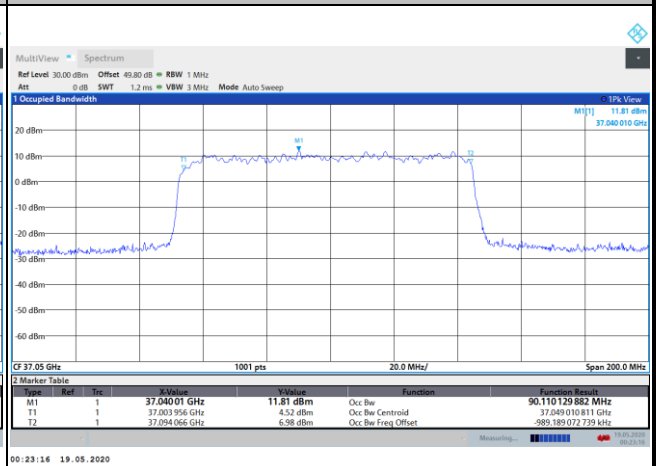

Middle Channel / 100MHz / 16QAM

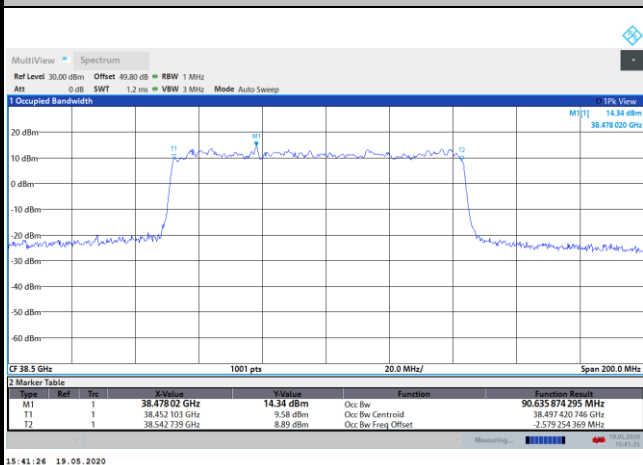

Middle Channel / 100MHz / 64QAM

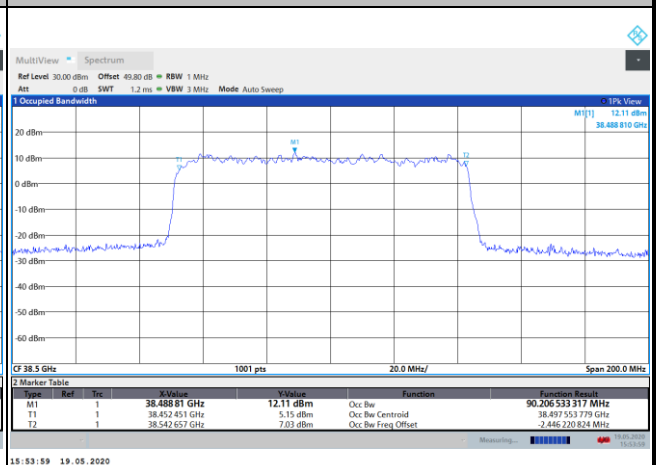

Highest Channel / 100MHz / 16QAM

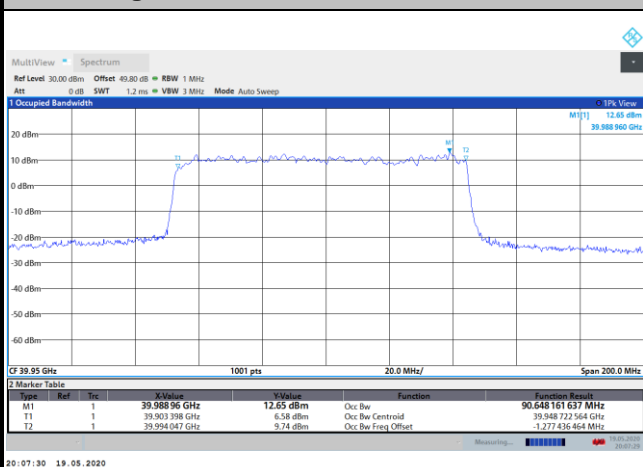

Highest Channel / 100MHz / 64QAM

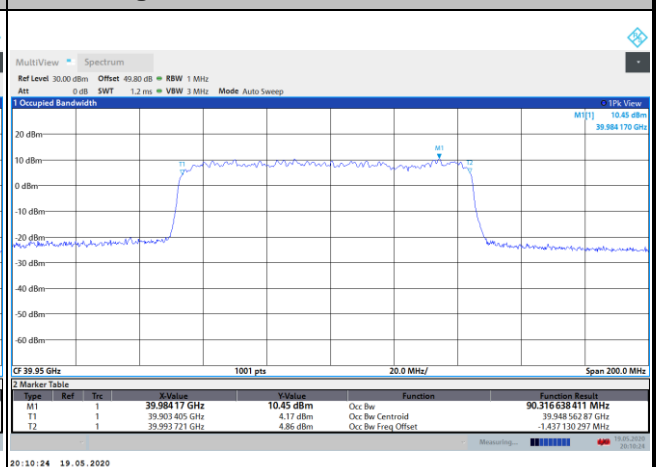



DFT-s-OFDM Module 1

NR Band n260

Lowest Channel / 200MHz / QPSK

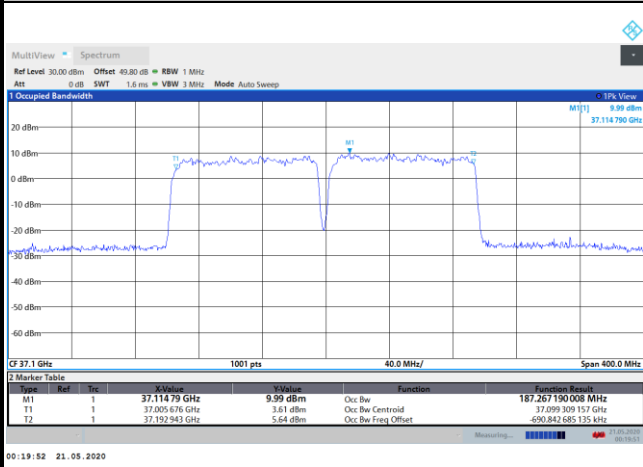

Lowest Channel / 200MHz / 16QAM

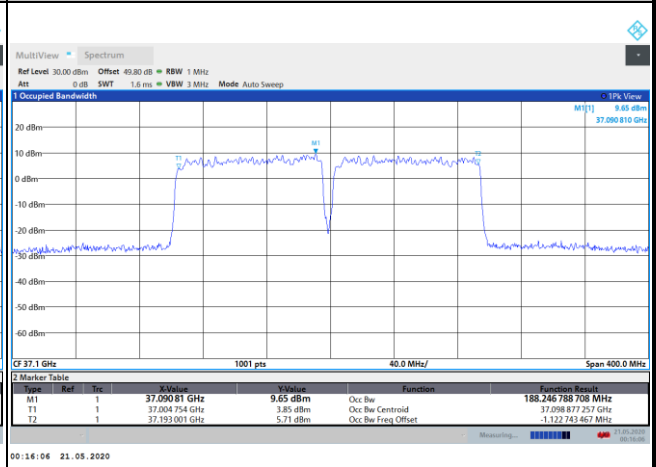

Middle Channel / 200MHz / QPSK

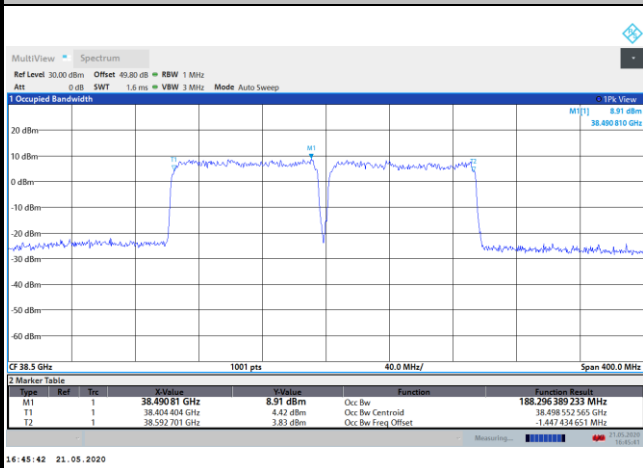

Middle Channel / 200MHz / 16QAM

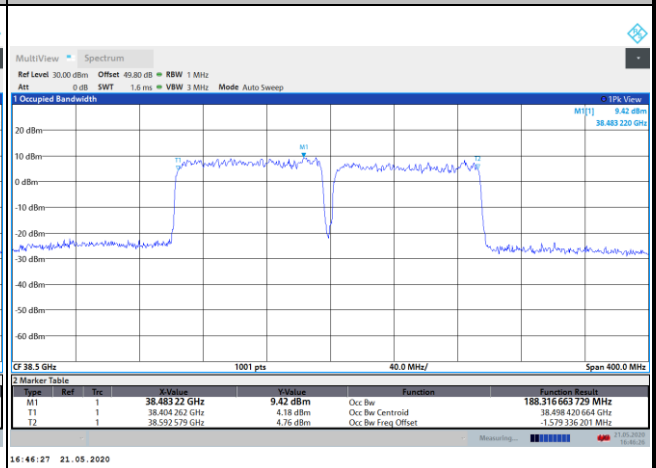

Highest Channel / 200MHz / QPSK

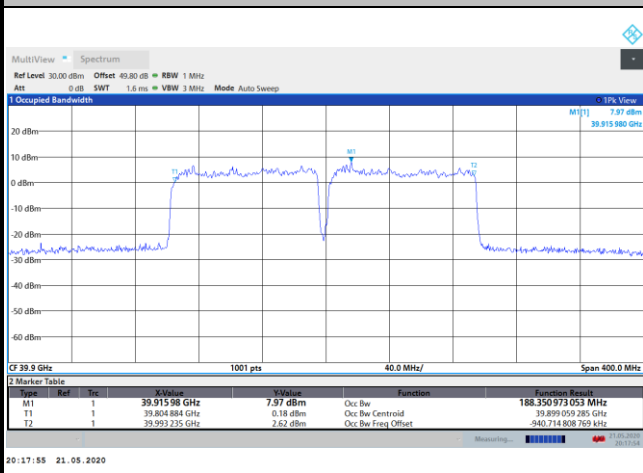

Highest Channel / 200MHz / 16QAM

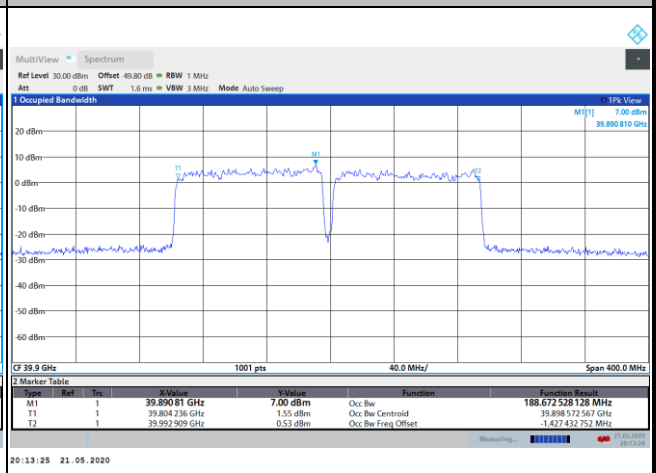



DFT-s-OFDM Module 1

NR Band n260

Lowest Channel / 200MHz / 64QAM

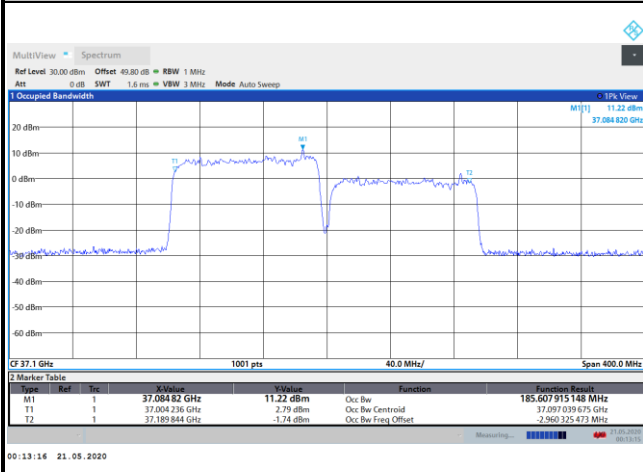

intentionally blank

Middle Channel / 200MHz / 64QAM

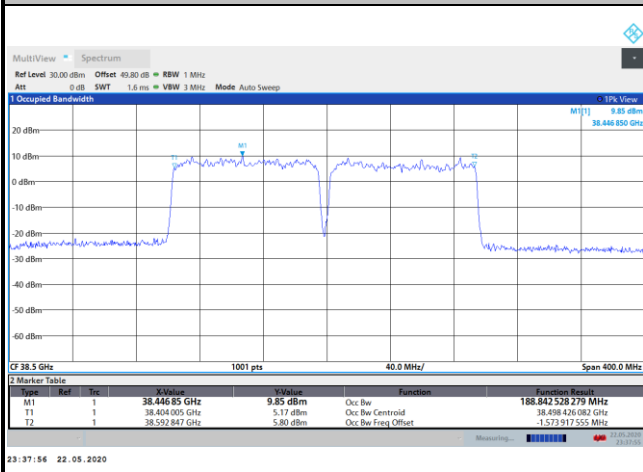

intentionally blank

Highest Channel / 200MHz / 64QAM

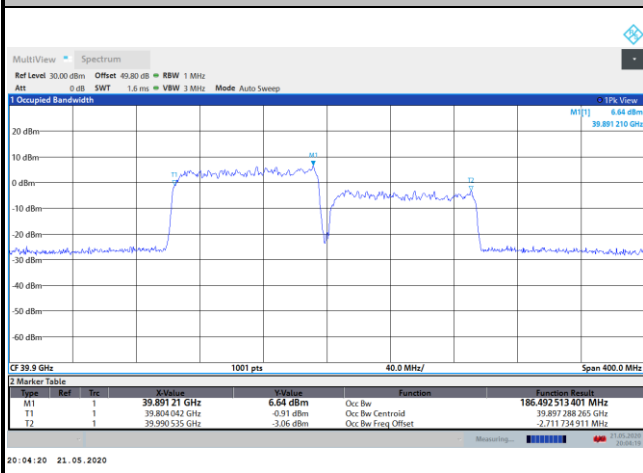

intentionally blank



CP-OFDM Module 0

NR Band n260

Lowest Channel / 50MHz / QPSK

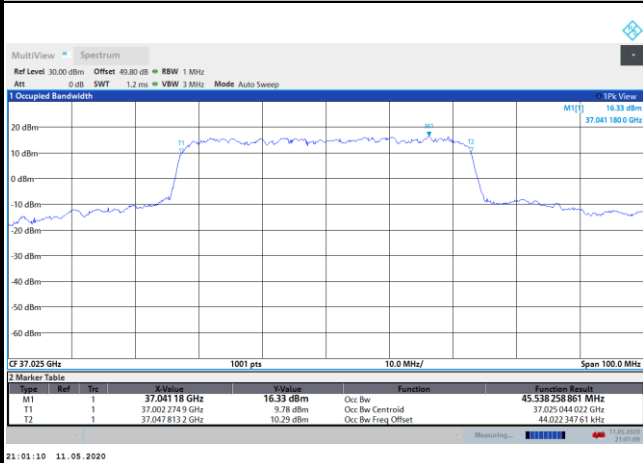

Lowest Channel / 50MHz / 16QAM

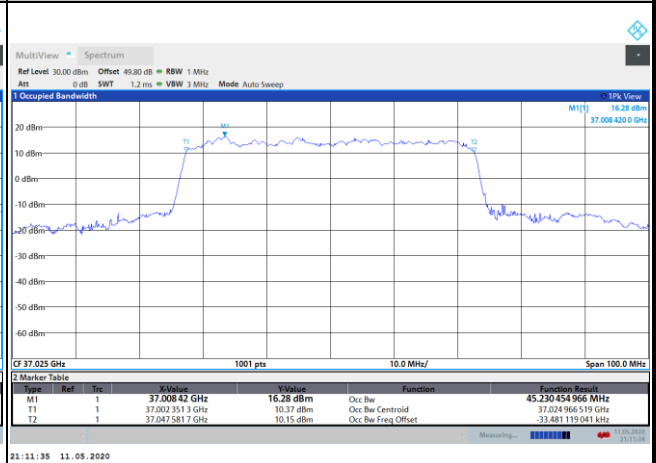

Middle Channel / 50MHz / QPSK

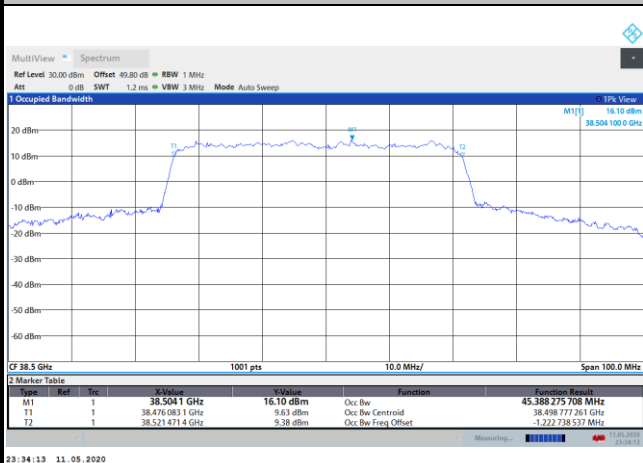

Middle Channel / 50MHz / 16QAM

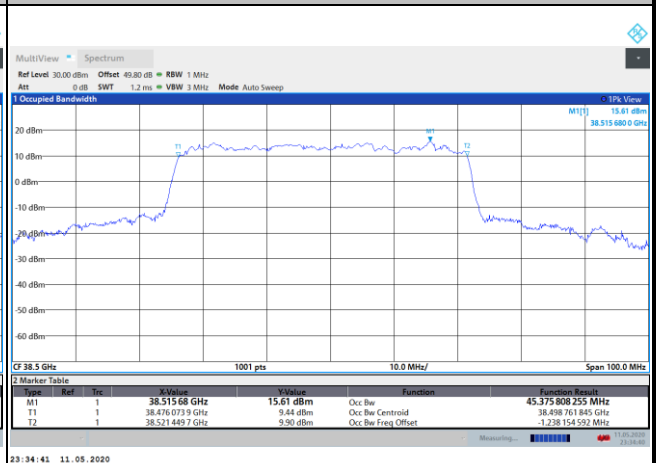

Highest Channel / 50MHz / QPSK

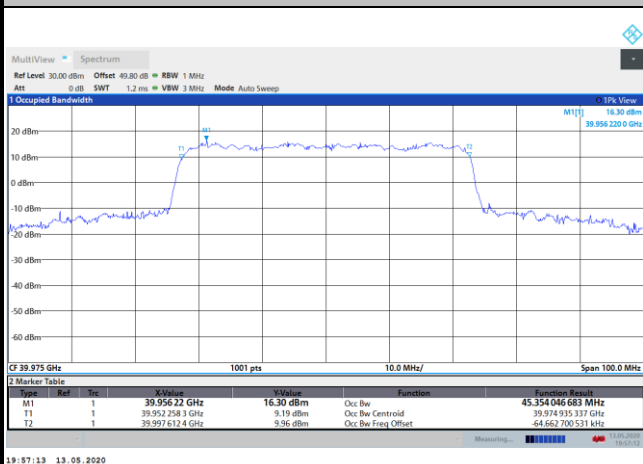

Highest Channel / 50MHz / 16QAM

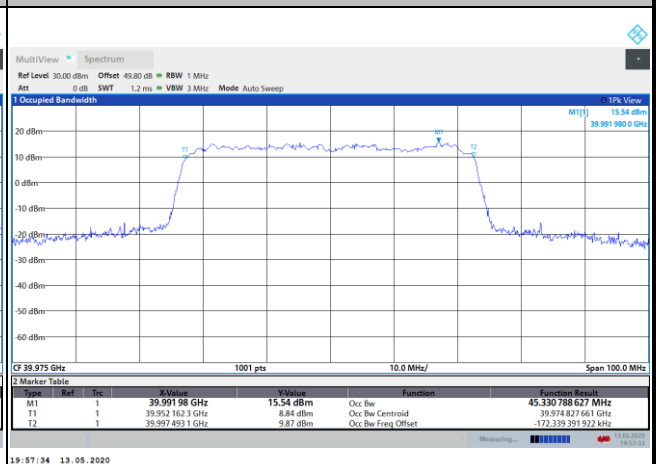



CP-OFDM Module 0

NR Band n260

Lowest Channel / 50MHz / 64QAM

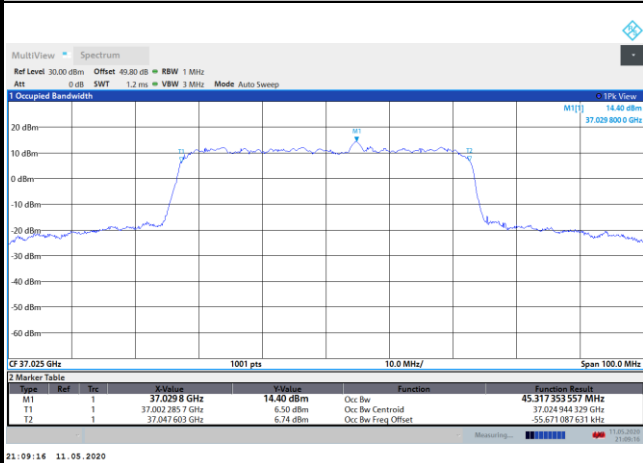

Lowest Channel / 100MHz / QPSK

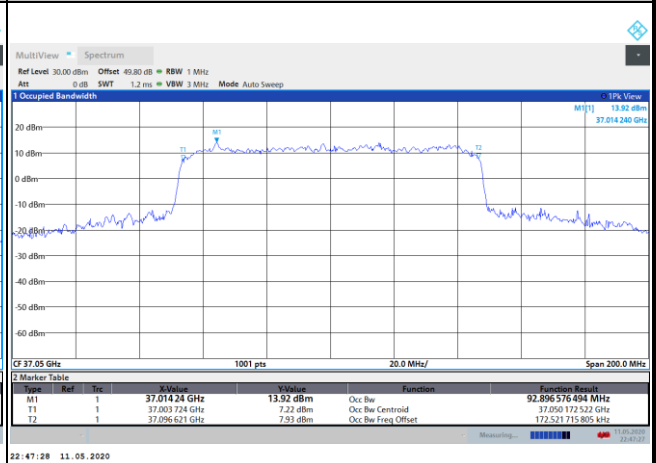

Middle Channel / 50MHz / 64QAM

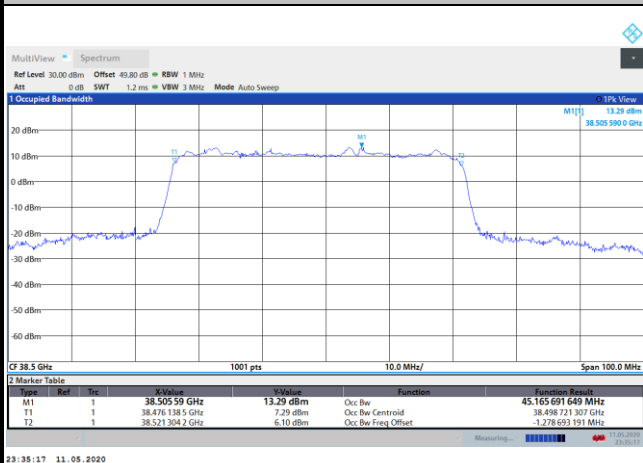

Middle Channel / 100MHz / QPSK

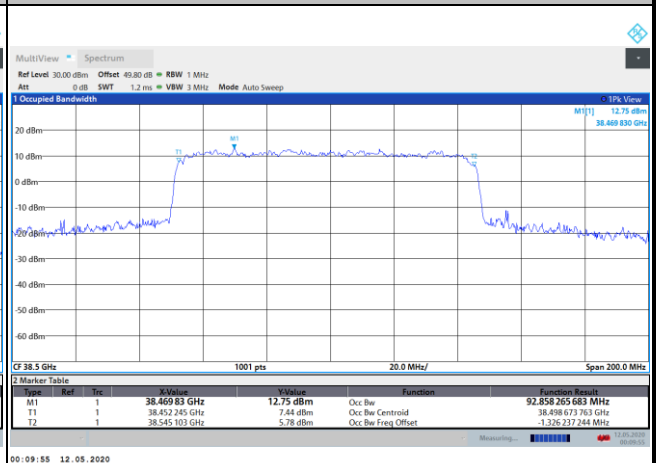

Highest Channel / 50MHz / 64QAM

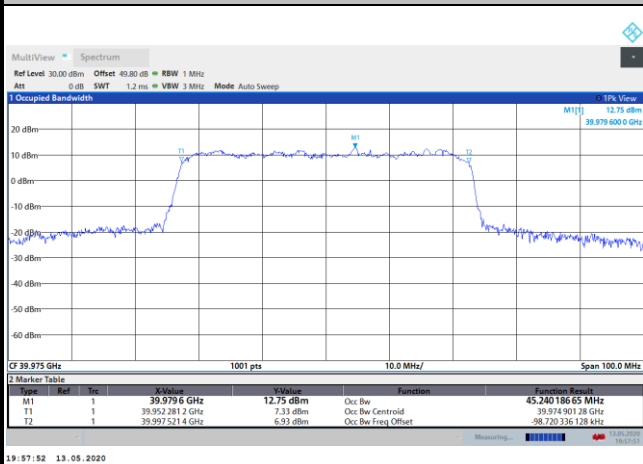

Highest Channel / 100MHz / QPSK

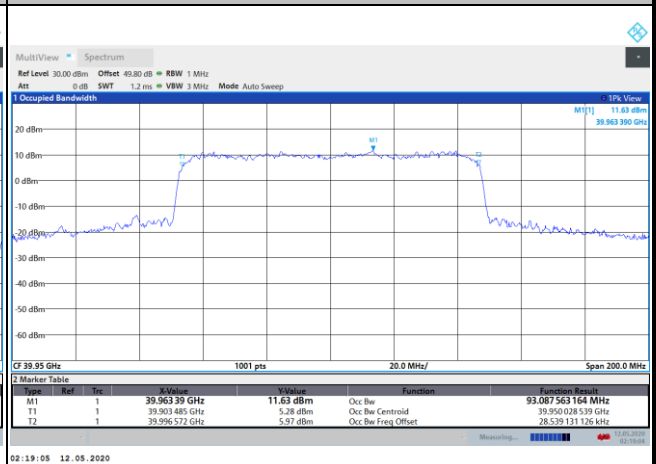



CP-OFDM Module 0

NR Band n260

Lowest Channel / 100MHz / 16QAM

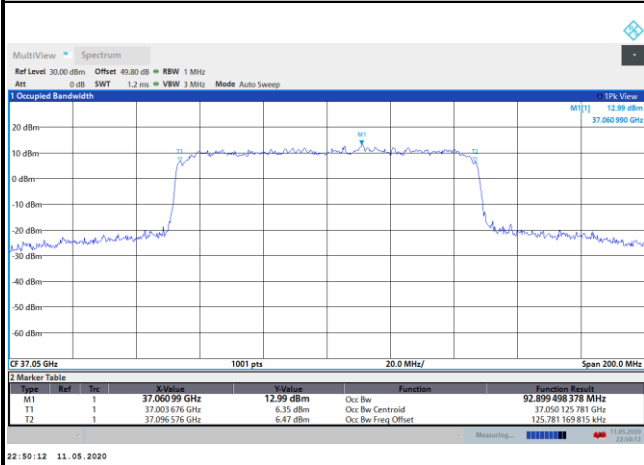

Lowest Channel / 100MHz / 64QAM

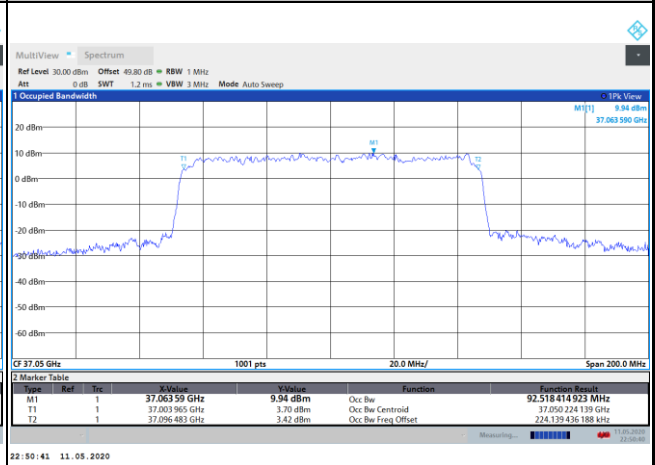

Middle Channel / 100MHz / 16QAM

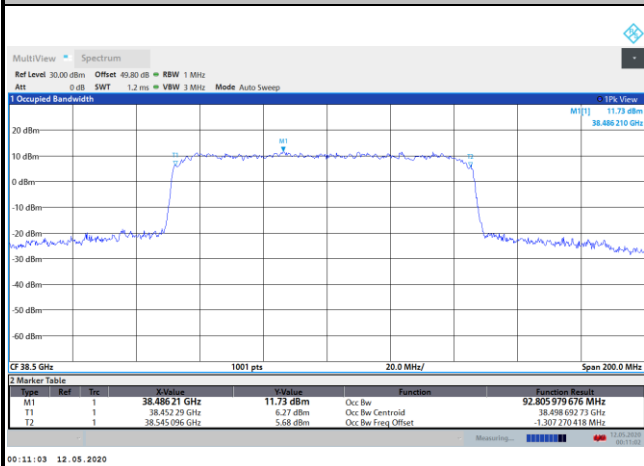

Middle Channel / 100MHz / 64QAM

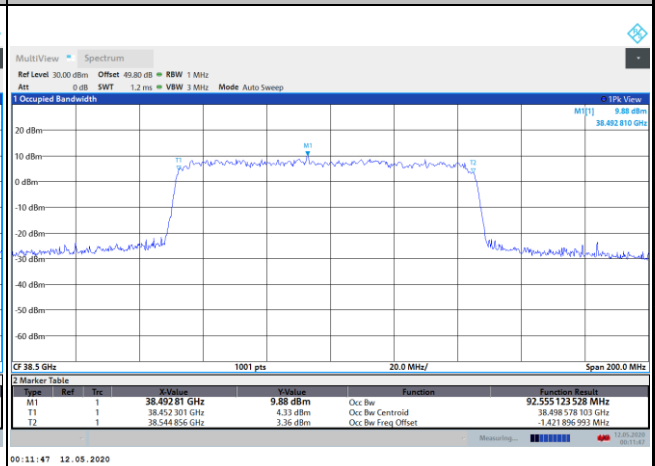

Highest Channel / 100MHz / 16QAM

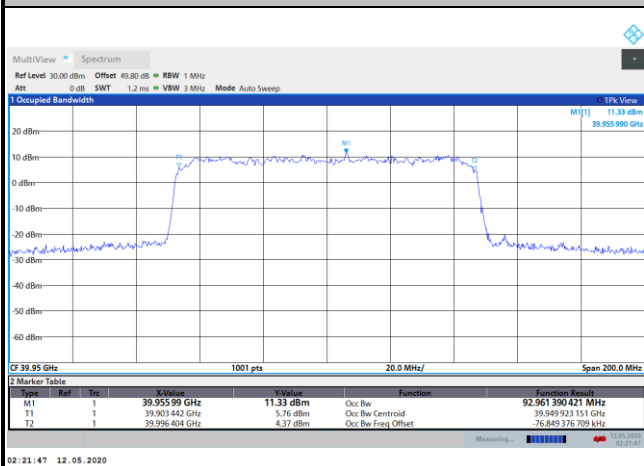

Highest Channel / 100MHz / 64QAM

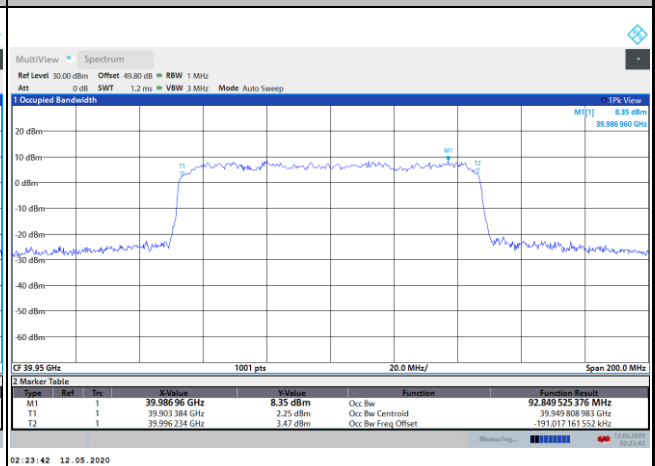



CP-OFDM Module 0

NR Band n260

Lowest Channel / 200MHz / QPSK

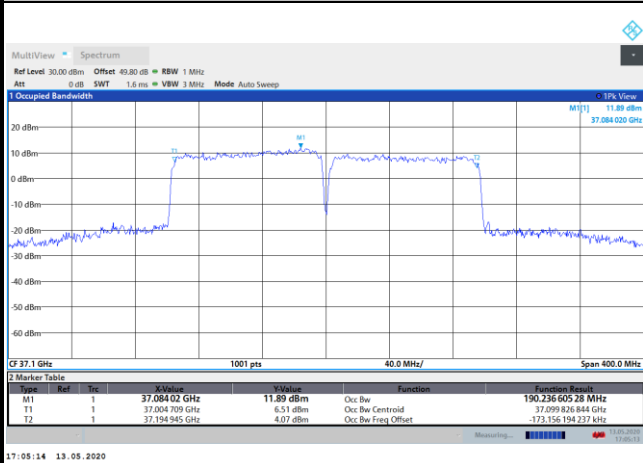

Lowest Channel / 200MHz / 16QAM

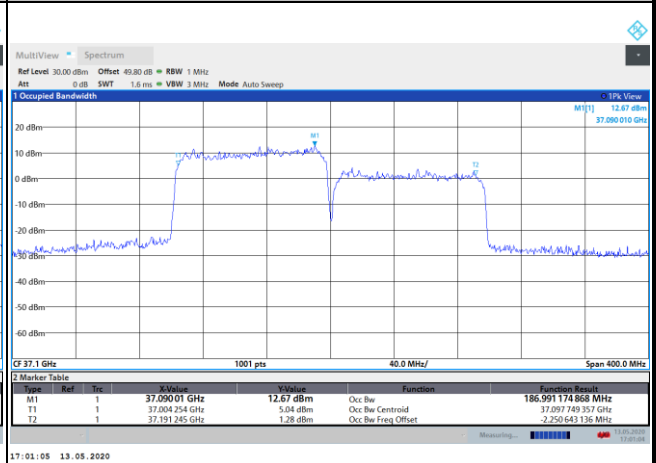

Middle Channel / 200MHz / QPSK

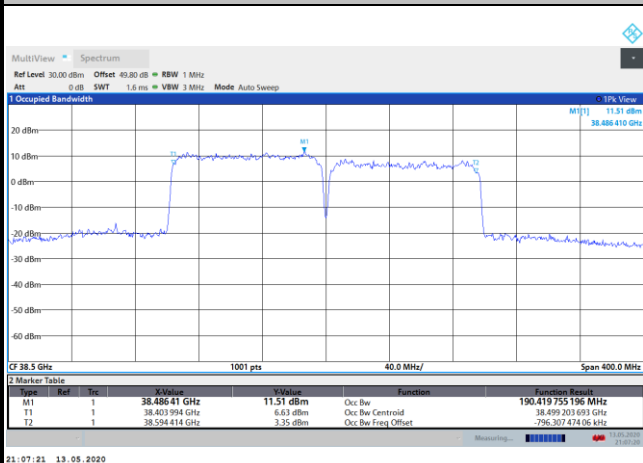

Middle Channel / 200MHz / 16QAM

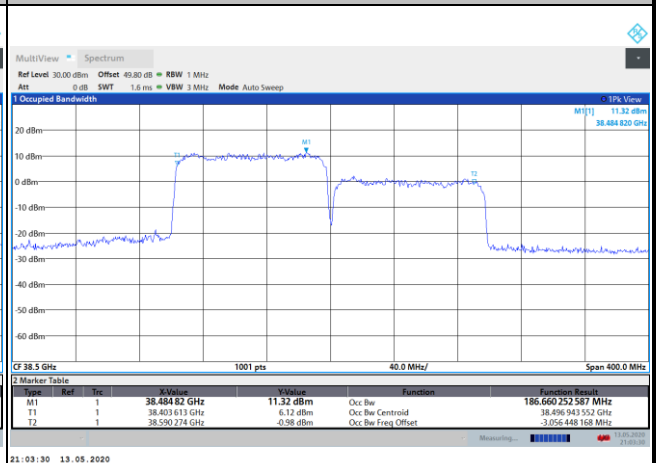

Highest Channel / 200MHz / QPSK

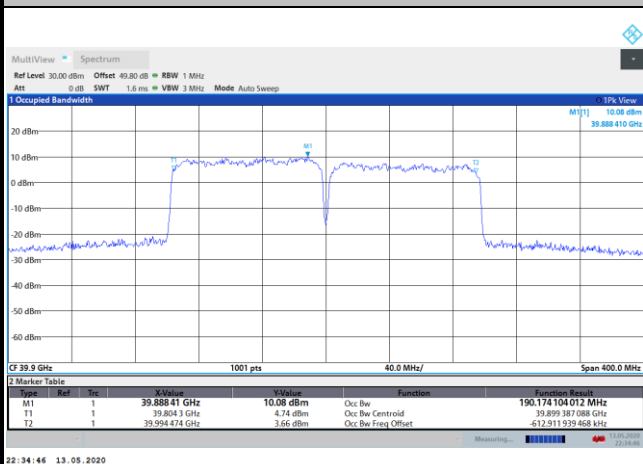

Highest Channel / 200MHz / 16QAM

