



# FCC RADIO TEST REPORT

FCC ID : A4RG6QU3  
Equipment : Phone  
Model Name : G6QU3  
Applicant : Google LLC  
1600 Amphitheatre Parkway,  
Mountain View, California, 94043 USA  
Standard : FCC 47 CFR Part 2, 96

The product was received on Jun. 01, 2020 and testing was started from Jun. 05, 2020 and completed on Jul. 30, 2020. We, SPORTON INTERNATIONAL INC. EMC & Wireless Communications Laboratory, would like to declare that the tested sample has been evaluated in accordance with the test procedures given in ANSI / TIA-603-E and has been in compliance with the applicable technical standards.

The test results in this report apply exclusively to the tested model / sample. Without written approval of SPORTON INTERNATIONAL INC. EMC & Wireless Communications Laboratory, the test report shall not be reproduced except in full.

Approved by: Louis Wu

**SPORTON INTERNATIONAL INC. EMC & Wireless Communications Laboratory**

No. 52, Huaya 1st Rd., Guishan Dist., Taoyuan City, Taiwan (R.O.C.)



## Table of Contents

**History of this test report..... 3**

**Summary of Test Result..... 4**

**1 General Description ..... 5**

    1.1 Product Feature of Equipment Under Test ..... 5

    1.2 Product Specification of Equipment Under Test ..... 5

    1.3 Modification of EUT ..... 6

    1.4 Testing Location ..... 6

    1.5 Applied Standards ..... 7

**2 Test Configuration of Equipment Under Test ..... 8**

    2.1 Test Mode..... 8

    2.2 Connection Diagram of Test System ..... 10

    2.3 Support Unit used in test configuration ..... 10

    2.4 Measurement Results Explanation Example ..... 10

    2.5 Frequency List of Low/Middle/High Channels..... 11

**3 Conducted Test Items..... 13**

    3.1 Measuring Instruments..... 13

    3.2 Conducted Output Power ..... 14

    3.3 Peak-to-Average Ratio ..... 15

    3.4 EIRP ..... 16

    3.5 Occupied Bandwidth ..... 17

    3.6 Conducted Band Edge ..... 18

    3.7 Conducted Spurious Emission ..... 19

    3.8 Frequency Stability..... 20

**4 Radiated Test Items ..... 21**

    4.1 Measuring Instruments..... 21

    4.2 Test Setup ..... 21

    4.3 Test Result of Radiated Test..... 22

    4.4 Radiated Spurious Emission ..... 23

**5 List of Measuring Equipment..... 24**

**6 Uncertainty of Evaluation ..... 26**

**Appendix A. Test Results of Conducted Test**

**Appendix B. Test Results of EIRP and Radiated Test**



### History of this test report

Report No.	Version	Description	Issued Date
FG050515H	01	Initial issue of report	Aug. 05, 2020
FG050515H	02	Add description for EIRP measurement	Aug. 14, 2020



### Summary of Test Result

Report Clause	Ref Std. Clause	Test Items	Result (PASS/FAIL)	Remark
3.2	§2.1046	Conducted Output Power	Reporting only	-
3.3	§96.41	Peak-to-Average Ratio	Pass	
3.4	§96.41	Effective Isotropic Radiated Power	Pass	-
3.5	§2.1049 §96.41	Occupied Bandwidth	Reporting only	-
3.6	§2.1051 §96.41	Conducted Band Edge Measurement	Pass	-
3.7	§2.1051 §96.41	Conducted Spurious Emission	Pass	
3.8	§2.1055	Frequency Stability for Temperature & Voltage	Pass	-
4.4	§2.1051 §96.41	Radiated Spurious Emission	Pass	Under limit 3.08 dB at 28929.000 MHz for Primary Antenna Under limit 3.34 dB at 7100.000 MHz for ASDIV Antenna

**Declaration of Conformity:**

The test results with all measurement uncertainty excluded are presented in accordance with the regulation limits or requirements declared by manufacturers.

**Comments and Explanations:**

The declared of product specification for EUT presented in the report are provided by the manufacturer, and the manufacturer takes all the responsibilities for the accuracy of product specification.

**Reviewed by: Wii Chang**

**Report Producer: Yimin Ho**



# 1 General Description

## 1.1 Product Feature of Equipment Under Test

Product Feature	
Equipment	Phone
Model Name	G6QU3
FCC ID	A4RG6QU3
EUT supports Radios application	CDMA/EV-DO/GSM/EGPRS/WCDMA/HSPA/LTE/5G NR/ NFC/GNSS WLAN 11b/g/n HT20 WLAN 11a/n HT20/HT40 WLAN 11ac VHT20/VHT40/VHT80 Bluetooth BR/EDR/LE

Remark: The above EUT's information was declared by manufacturer.

EUT Information List	
S/N	Performed Test Item
05211FQCB00030	Conducted Measurement EIRP
05151FQCB00141	Radiated Spurious Emission

## 1.2 Product Specification of Equipment Under Test

Product Specification subjective to this standard	
Tx Frequency	3552.5 MHz ~ 3697.5 MHz
Rx Frequency	3552.5 MHz ~ 3697.5 MHz
Bandwidth	5 MHz / 10 MHz / 15 MHz / 20 MHz
Maximum Output Power to Antenna	<Primary Antenna> LTE Band 48: 24.21 dBm LTE Band 48_CA: 15.23 dBm <ASDIV Antenna> LTE Band 48: 20.85 dBm LTE Band 48_CA: 13.57 dBm
Antenna Type	<Primary Antenna>: Monopole Antenna type <ASDIV Antenna>: Monopole Antenna type
Type of Modulation	QPSK / 16QAM / 64QAM

### <Primary Antenna>

Radio Tech	Band Number	Antenna name	Gain
LTE	B48	Ant 7	-2.8

### <ASDIV Antenna>

Radio Tech	Band Number	Antenna name	Gain
LTE	B48	Ant 2	-0.5



### 1.3 Modification of EUT

No modifications are made to the EUT during all test items.

### 1.4 Testing Location

<b>Test Site</b>	SPORTON INTERNATIONAL INC. EMC & Wireless Communications Laboratory
<b>Test Site Location</b>	No.52, Huaya 1st Rd., Guishan Dist., Taoyuan City, Taiwan (R.O.C.) TEL: +886-3-327-3456 FAX: +886-3-328-4978
<b>Test Site No.</b>	<b>Sporton Site No.</b>
	TH05-HY
<b>Test Engineer</b>	Luffy Lin
<b>Temperature</b>	22~24°C
<b>Relative Humidity</b>	51~55%

<b>Test Site</b>	SPORTON INTERNATIONAL INC. EMC & Wireless Communications Laboratory
<b>Test Site Location</b>	No.58, Aly. 75, Ln. 564, Wenhua 3rd, Rd., Guishan Dist., Taoyuan City, Taiwan (R.O.C.) TEL: +886-3-327-0868 FAX: +886-3-327-0855
<b>Test Site No.</b>	<b>Sporton Site No.</b>
	03CH12-HY
<b>Test Engineer</b>	Jack Cheng, Lance Chiang, and Chuan Chu
<b>Temperature</b>	24.3~26.4°C
<b>Relative Humidity</b>	56.1~68.1%

**Note:** The test site complies with ANSI C63.4 2014 requirement.

FCC Designation No.: TW1190 and TW0007



## **1.5 Applied Standards**

According to the specifications of the manufacturer, the EUT must comply with the requirements of the following standards:

- ♦ ANSI C63.26-2015
- ♦ ANSI / TIA-603-E
- ♦ FCC 47 CFR Part 2, 96
- ♦ FCC KDB 971168 D01 Power Meas. License Digital Systems v03r01
- ♦ FCC KDB 940660 D01 Part 96 CBRS Eqpt v01
- ♦ FCC KDB 412172 D01 Determining ERP and EIRP v01r01
- ♦ FCC KDB 414788 D01 Radiated Test Site v01r01

**Remark:**

1. All test items were verified and recorded according to the standards and without any deviation during the test.
2. This EUT has also been tested and complied with the requirements of FCC Part 15, Subpart B, recorded in a separate test report.
3. The TAF code is not including all the FCC KDB listed without accreditation.



## 2 Test Configuration of Equipment Under Test

### 2.1 Test Mode

Antenna port conducted and radiated test items listed below are performed according to KDB 971168 D01 Power Meas. License Digital Systems v03r01 with maximum output power.

For radiated measurement, pre-scanned in three orthogonal panels, X, Y, Z and Accessory. The worst cases (Primary Antenna: Y plane for Band 48 and Z plane for Band 48C; ASDIV Antenna: Y plane) were recorded in this report.

Test Items	Band	Bandwidth (MHz)						Modulation			RB #			Test Channel		
		1.4	3	5	10	15	20	QPSK	16QAM	64QAM	1	Half	Full	L	M	H
Max. Output Power	48	-	-	v	v	v	v	v	v	v	v	v	v	v	v	v
26dB and 99% Bandwidth	48	-	-	v	v	v	v	v	v	v			v	v	v	v
Conducted Band Edge	48	-	-	v	v	v	v	v	v	v	v		v	v		v
Peak-to-Average Ratio	48	-	-				v	v	v	v	v		v	v	v	v
Conducted Spurious Emission	48	-	-	v	v	v	v	v	v	v	v		v	v	v	v
E.I.R.P	48	-	-	v	v	v	v	v	v	v	v			v	v	v
Frequency Stability	48	-	-		v			v			v				v	
Radiated Spurious Emission	48	<b>Worst Case</b>											v	v	v	
Remark	<ol style="list-style-type: none"> <li>The mark "v" means that this configuration is chosen for testing</li> <li>The mark "-" means that this bandwidth is not supported.</li> <li>The device is investigated from 30MHz to 10 times of fundamental signal for radiated spurious emission test under different RB size/offset and modulations in exploratory test. Subsequently, only the worst case emissions are reported.</li> <li>All the radiated test cases were performed with Adapter 1 and USB Cable 1.</li> </ol>															





Test Items	Band	Bandwidth (MHz)										Modulation			RB #			Test Channel		
		20+20	20+15	15+20	20+10	10+20	20+5	5+20	15+15	15+10	10+15	QPSK	16QAM	64QAM	1	Half	Full	L	M	H
Max. Output Power	48_CA	v	v	v	v	v	v	v	-	-	-	v	v	v	v	v	v	v	v	v
26dB and 99% Bandwidth	48_CA	v	v	v	v	v	v	v	-	-	-	v	v	v			v	v	v	v
Conducted Band Edge	48_CA	v	v	v	v	v	v	v	-	-	-	v	v	v	v		v	v		v
Conducted Spurious Emission	48_CA	v	v	v	v	v	v	v	-	-	-	v	v	v	v			v	v	v
E.I.R.P.	48_CA	v	v	v	v	v	v	v	-	-	-	v	v	v	v			v	v	v
Radiated Spurious Emission	48_CA	Worst Case															v	v	v	
Remark	<ol style="list-style-type: none"> <li>The mark "v" means that this configuration is chosen for testing</li> <li>The mark "-" means that this bandwidth is not supported.</li> <li>The device is investigated from 30MHz to 10 times of fundamental signal for radiated spurious emission test under different RB size/offset and modulations in exploratory test. Subsequently, only the worst case emissions are reported.</li> <li>All the radiated test cases were performed with Adapter 1 and USB Cable 1.</li> </ol>																			

## 2.2 Connection Diagram of Test System

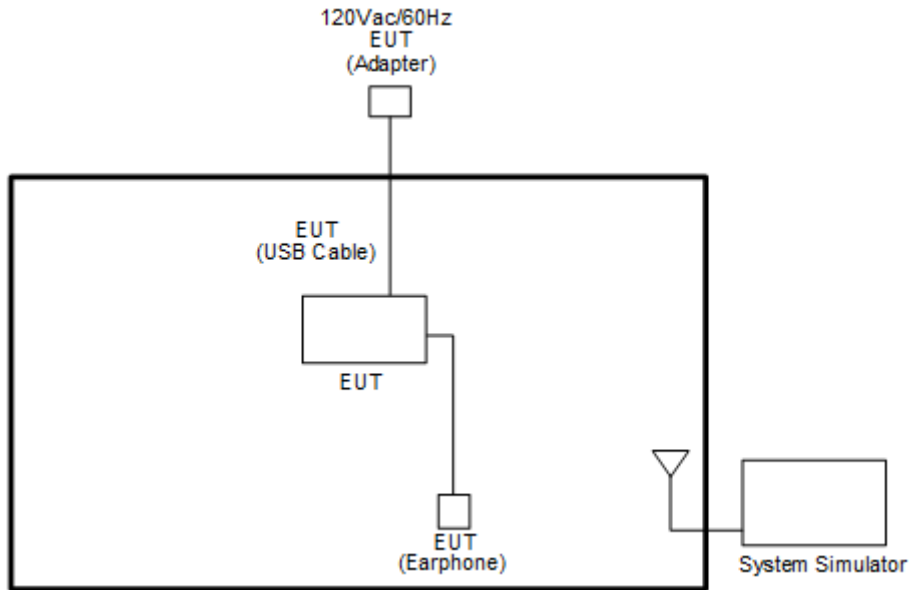

## 2.3 Support Unit used in test configuration

Item	Equipment	Trade Name	Model No.	FCC ID	Data Cable	Power Cord
1.	System Simulator	Anritsu	MT8821C	N/A	N/A	Unshielded, 1.8 m

## 2.4 Measurement Results Explanation Example

For all conducted test items:

The offset level is set in the spectrum analyzer to compensate the RF cable loss and attenuator factor between EUT conducted output port and spectrum analyzer. With the offset compensation, the spectrum analyzer reading level is exactly the EUT RF output level.

The spectrum analyzer offset is derived from RF cable loss and attenuator factor.

$Offset = RF\ cable\ loss + attenuator\ factor.$

Following shows an offset computation example with cable loss 4.2 dB and 10dB attenuator.

Example :

$$Offset(dB) = RF\ cable\ loss(dB) + attenuator\ factor(dB).$$

$$= 4.2 + 10 = 14.2\ (dB)$$



## 2.5 Frequency List of Low/Middle/High Channels

LTE Band 48 Channel and Frequency List				
BW [MHz]	Channel/Frequency(MHz)	Lowest	Middle	Highest
20	Channel	55340	55990	56640
	Frequency	3560.0	3625.0	3690.0
15	Channel	55315	55990	56665
	Frequency	3557.5	3625.0	3692.5
10	Channel	55290	55990	56690
	Frequency	3555.0	3625.0	3695.0
5	Channel	55265	55990	56715
	Frequency	3552.5	3625.0	3697.5



LTE Band 48 Channel and Frequency List_CA					
BW [MHz]	Channel/Frequency(MHz)		Lowest	Middle	Highest
20 + 20	PCC	Channel	55340	55891	56442
		Frequency	3560.0	3565.1	3570.2
	SCC	Channel	55538	56089	56640
		Frequency	3579.8	3634.9	3690
20 + 15	PCC	Channel	55340	55916	56491
		Frequency	3560.0	3617.6	3675.1
	SCC	Channel	55511	56087	56662
		Frequency	3577.1	3634.7	3692.2
15 + 20	PCC	Channel	55318	55893	56469
		Frequency	3557.8	3615.3	3672.9
	SCC	Channel	55489	56064	56640
		Frequency	3574.9	3632.4	3690
20 + 10	PCC	Channel	55340	55941	56541
		Frequency	3560	3620.1	3680.1
	SCC	Channel	55484	56085	56685
		Frequency	3574.4	3634.5	3694.5
10 + 20	PCC	Channel	55295	55896	56496
		Frequency	3555.5	3615.6	3675.6
	SCC	Channel	55439	56040	56640
		Frequency	3569.9	3630	3690
20 + 5	PCC	Channel	55340	55965	56590
		Frequency	3560	3622.5	3685
	SCC	Channel	55457	56082	56707
		Frequency	3571.7	3634.2	3696.7
5 + 20	PCC	Channel	55273	55898	56523
		Frequency	3553.3	3615.8	3678.3
	SCC	Channel	55390	56015	56640
		Frequency	3565	3627.5	3690

### 3 Conducted Test Items

#### 3.1 Measuring Instruments

See list of measuring instruments of this test report.

##### 3.1.1 Test Setup

##### 3.1.2 Conducted Output Power

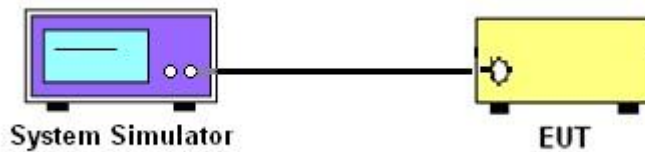

##### 3.1.3 EIRP, Peak-to-Average Ratio, Occupied Bandwidth, Conducted Band-Edge and Conducted Spurious Emission

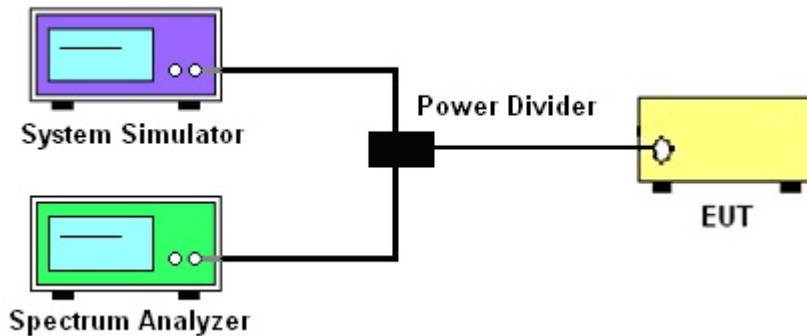

##### 3.1.4 Frequency Stability

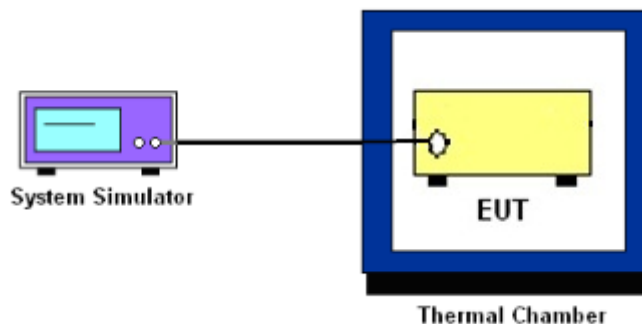

##### 3.1.5 Test Result of Conducted Test

Please refer to Appendix A.



## **3.2 Conducted Output Power**

### **3.2.1 Description of the Conducted Output Power Measurement**

A system simulator was used to establish communication with the EUT. Its parameters were set to force the EUT transmitting at maximum output power. The measured power in the radio frequency on the transmitter output terminals shall be reported.

### **3.2.2 Test Procedures**

1. The transmitter output port was connected to the system simulator.
2. Set EUT at maximum power through the system simulator.
3. Select lowest, middle, and highest channels for each band and different modulation.
4. Measure and record the power level from the system simulator.



### **3.3 Peak-to-Average Ratio**

#### **3.3.1 Description of the PAR Measurement**

Power Complementary Cumulative Distribution Function (CCDF) curves provide a means for characterizing the power peaks of a digitally modulated signal on a statistical basis. A CCDF curve depicts the probability of the peak signal amplitude exceeding the average power level. Most contemporary measurement instrumentation include the capability to produce CCDF curves for an input signal provided that the instrument's resolution bandwidth can be set wide enough to accommodate the entire input signal bandwidth. In measuring transmissions in this band using an average power technique, the peak-to-average ratio (PAR) of the transmission may not exceed 13 dB.

#### **3.3.2 Test Procedures**

The testing follows ANSI C63.26-2015 Section 5.2.6

1. The EUT was connected to spectrum and system simulator via a power divider.
2. Set the CCDF (Complementary Cumulative Distribution Function) option in spectrum analyzer.
3. The highest RF powers were measured and recorded the maximum PAPR level associated with a probability of 0.1 %.
4. Record the deviation as Peak to Average Ratio



### 3.4 EIRP

#### 3.4.1 Description of the EIRP Measurement

The EIRP of mobile transmitters must not exceed 23 dBm /10 megahertz for LTE Band 48.

The testing follows ANSI C63.26-2015 Section 5.2.5.5

According to KDB 412172 D01 Power Approach,

$EIRP = P_T + G_T - L_C$ , where

$P_T$  = transmitter output power in dBm

$G_T$  = gain of the transmitting antenna in dBi

$L_C$  = signal attenuation in the connecting cable between the transmitter and antenna in dB

Device	Maximum EIRP (dBm/10 MHz)
End User Device	23

**Remark:** The total power is larger than the integrated power across 10MHz portion. Hence, total channel power is complied with EIRP limit 23dBm/10MHz.

#### 3.4.1 Test Procedures

The testing follows procedure in Section 5.2 of ANSI C63.26-2015 and KDB 940660 D01 Part 96 Eqpt v02 Section 3.2(b)(2)

Determine the EIRP by adding the effective antenna gain to the measured average conducted power level.





## 3.5 Occupied Bandwidth

### 3.5.1 Description of Occupied Bandwidth Measurement

The occupied bandwidth is the width of a frequency band such that, below the lower and above the upper frequency limits, the mean powers emitted are each equal to a specified percentage 0.5% of the total mean transmitted power.

The 26 dB emission bandwidth is defined as the frequency range between two points, one above and one below the carrier frequency, at which the spectral density of the emission is attenuated 26 dB below the maximum in-band spectral density of the modulated signal. Spectral density (power per unit bandwidth) is to be measured with a detector of resolution bandwidth equal to approximately 1.0% of the emission bandwidth.

### 3.5.2 Test Procedures

The testing follows ANSI C63.26-2015 Section 5.4.3 (26dB) and Section 5.4.4 (99OB)

1. The EUT was connected to spectrum analyzer and system simulator via a power divider.
2. The spectrum analyzer center frequency is set to the nominal EUT channel center frequency. The span range for the spectrum analyzer shall be between two and five times the anticipated OBW.
3. The nominal resolution bandwidth (RBW) shall be in the range of 1 to 5 % of the anticipated OBW, and the VBW shall be at least 3 times the RBW.
4. Set the detection mode to peak, and the trace mode to max hold.
5. Determine the reference value: Set the EUT to transmit a modulated signal. Allow the trace to stabilize. Set the spectrum analyzer marker to the highest level of the displayed trace.  
(this is the reference value)
6. Determine the “-26 dB down amplitude” as equal to (Reference Value – X).
7. Place two markers, one at the lowest and the other at the highest frequency of the envelope of the spectral display such that each marker is at or slightly below the “-X dB down amplitude” determined in step 6. If a marker is below this “-X dB down amplitude” value it shall be placed as close as possible to this value. The OBW is the positive frequency difference between the two markers.
8. Use the 99 % power bandwidth function of the spectrum analyzer and report the measured bandwidth.



## 3.6 Conducted Band Edge

### 3.6.1 Description of Conducted Band Edge Measurement

The conducted power of any End User Device emission outside the fundamental emission (whether in or outside of the authorized band) shall not exceed  $-13$  dBm/MHz within 0 to B megahertz (where B is the bandwidth in megahertz of the assigned channel or multiple contiguous channels of the End User Device) above the upper CBSD-assigned channel edge and within 0 to B megahertz below the lower CBSD-assigned channel edge. At all frequencies greater than B megahertz above the upper CBSD assigned channel edge and less than B megahertz below the lower CBSD-assigned channel edge, the conducted power of any End User Device emission shall not exceed  $-25$  dBm/MHz. Notwithstanding the emission limits in this paragraph, the Adjacent Channel Leakage Ratio for End User Devices shall be at least 30 dB.

### 3.6.2 Test Procedures

The testing follows FCC KDB 971168 D01 v03r01 Section 6.1.

1. The EUT was connected to spectrum analyzer and system simulator via a power divider.
2. The band edges of low and high channels for the highest RF powers were measured.
3. Set RBW  $\geq$  1% EBW in the 1MHz band immediately outside and adjacent to the band edge.
4. Beyond the 1 MHz band from the band edge, RBW=1MHz was used
5. Set spectrum analyzer with RMS detector.
6. The RF fundamental frequency should be excluded against the limit line in the operating frequency band.

For Adjacent Channel Leakage Ratio (ACLR) measurement,

1. The Adjacent Channel Leakage Ratio (ACLR) is the ratio of the average power in the assigned aggregated channel bandwidth to the average power over the equivalent adjacent channel bandwidth.
2. The option ACLR of spectrum analyzer is used and measures the ACLR ratio by setting equivalent channel bandwidth.
3. The measured ACLR ratio shall be at least 30 dB.



## 3.7 Conducted Spurious Emission

### 3.7.1 Description of Conducted Spurious Emission Measurement

Emission and interference limits: the device satisfies the emission limits specified in Section FCC Part 96.41 e) 1) ii) & e) 2) at the lowest and highest edges of the band, and in the middle of the band.

### 3.7.2 Test Procedures

The testing follows FCC KDB 971168 D01 v03r01 Section 6.1.

1. The EUT was connected to spectrum analyzer and system simulator via a power divider.
2. The RF output of EUT was connected to the spectrum analyzer by RF cable and attenuator. The path loss was compensated to the results for each measurement.
3. The middle channel for the highest RF power within the transmitting frequency was measured.
4. The conducted spurious emission for the whole frequency range was taken.
5. Make the measurement with the spectrum analyzer's RBW = 1MHz, VBW = 3MHz.
6. Set spectrum analyzer with RMS detector.
7. Taking the record of maximum spurious emission.
8. The RF fundamental frequency should be excluded against the limit line in the operating frequency band.
9. The limit line is -40dBm/MHz.



## 3.8 Frequency Stability

### 3.8.1 Description of Frequency Stability Measurement

The frequency stability shall be measured by variation of ambient temperature and variation of primary supply voltage to ensure that the fundamental emission stays within the authorized frequency block. The frequency stability of the transmitter shall be maintained within  $\pm 0.00025\%$  ( $\pm 2.5\text{ppm}$ ) of the center frequency

### 3.8.2 Test Procedures for Temperature Variation

The testing follows FCC KDB 971168 D01 v03r01 Section 9.0.

1. The EUT was set up in the thermal chamber and connected with the system simulator.
2. With power OFF, the temperature was decreased to  $-30^{\circ}\text{C}$  and the EUT was stabilized before testing. Power was applied and the maximum change in frequency was recorded within one minute.
3. With power OFF, the temperature was raised in  $10^{\circ}\text{C}$  step up to  $50^{\circ}\text{C}$ . The EUT was stabilized at each step for at least half an hour. Power was applied and the maximum frequency change was recorded within one minute.

### 3.8.3 Test Procedures for Voltage Variation

The testing follows FCC KDB 971168 D01 v03r01 Section 9.0.

1. The EUT was placed in a temperature chamber at  $25\pm 5^{\circ}\text{C}$  and connected with the system simulator.
2. The power supply voltage to the EUT was varied from 85% to 115% of the nominal value measured at the input to the EUT.
3. The variation in frequency was measured for the worst case.

## 4 Radiated Test Items

### 4.1 Measuring Instruments

See list of measuring instruments of this test report.

### 4.2 Test Setup

For radiated emissions below 30MHz

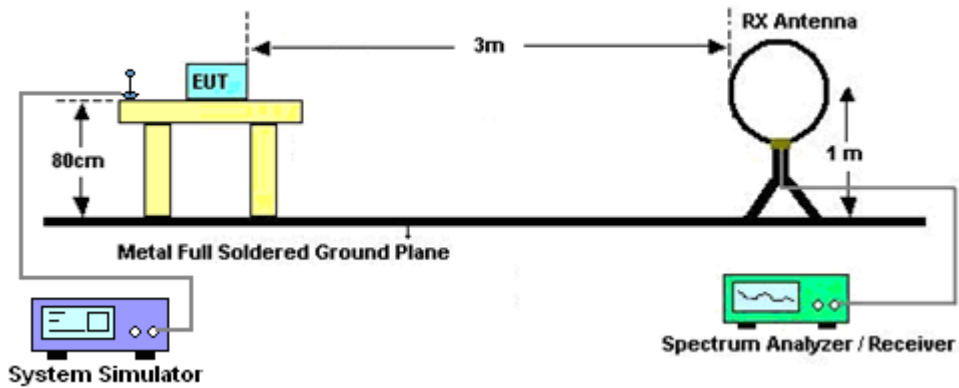

For radiated emissions from 30MHz to 1GHz

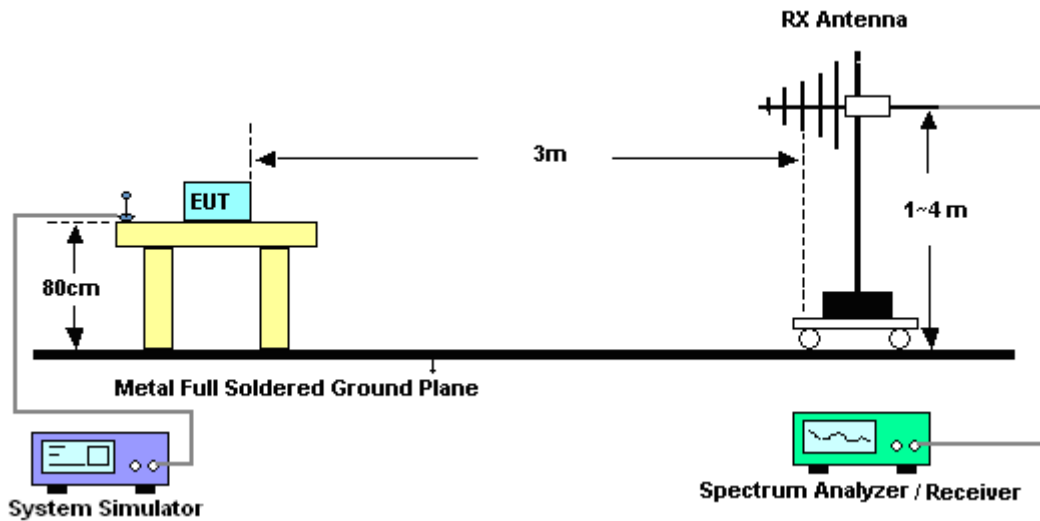

For radiated emissions above 1GHz

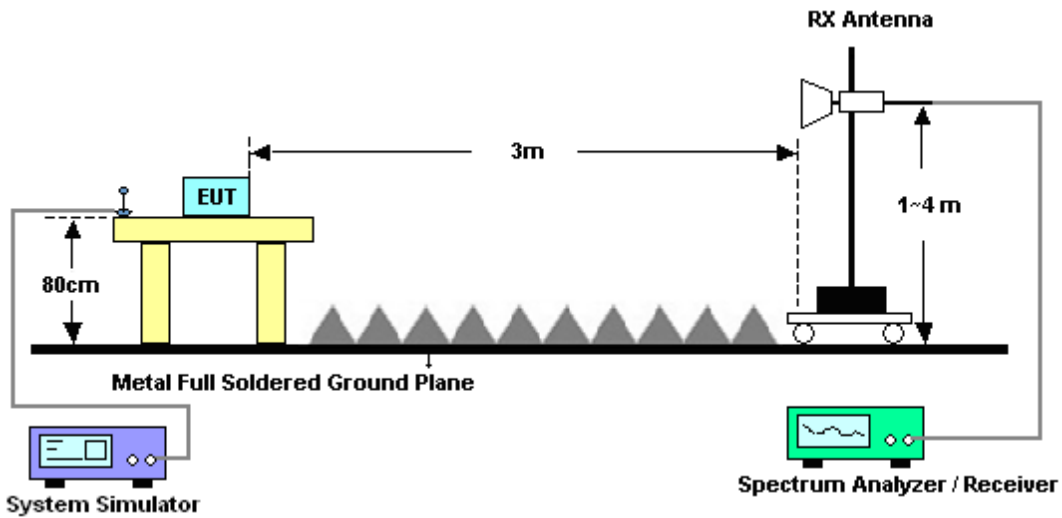

For radiated emissions above 18GHz

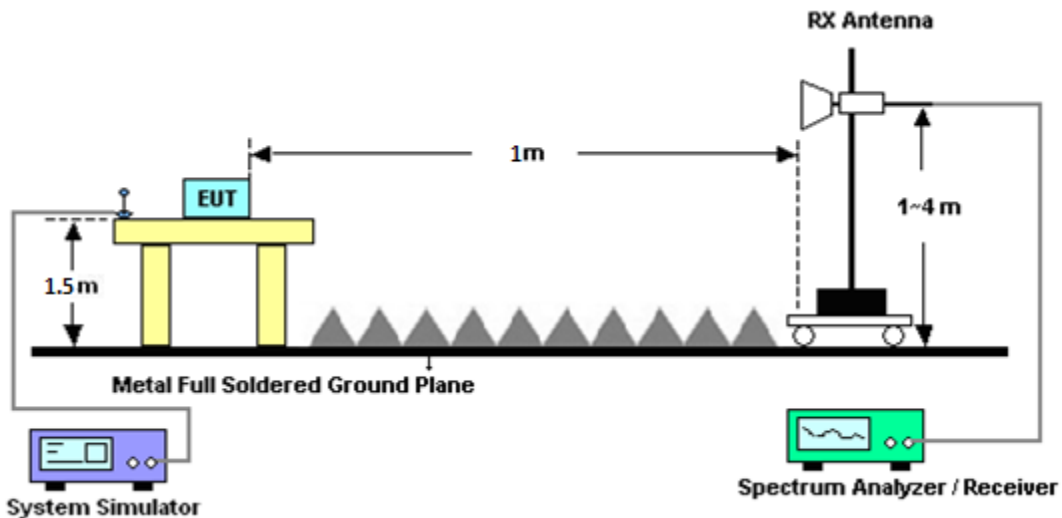

### 4.3 Test Result of Radiated Test

Please refer to Appendix B.

**Note:**

The low frequency, which started from 9 kHz to 30MHz, was pre-scanned and the result which was 20dB lower than the limit line was not reported.

There is a comparison data of both open-field test site and alternative test site - semi-Anechoic chamber according to 414788 D01 Radiated Test Site v01r01, and the result came out very similar.



## 4.4 Radiated Spurious Emission

### 4.4.1 Description of Radiated Spurious Emission Measurement

The radiated spurious emission was measured by substitution method according to ANSI / TIA-603-E. The power of any emission outside of the authorized operating frequency ranges must be attenuated below the transmitter power (P) by a factor of at least -40dBm / MHz. The spectrum is scanned from 30 MHz up to a frequency including its 10th harmonic.

### 4.4.2 Test Procedures

The testing follows FCC KDB 971168 D01 v03r01 Section 7 and ANSI / TIA-603-E Section 2.2.12.

1. The EUT was placed on a turntable with 0.8 meter height for frequency below 1GHz and 1.5 meter height for frequency above 1GHz respectively above ground.
2. The EUT was set 3 meters from the receiving antenna mounted on the antenna tower.
3. The table was rotated 360 degrees to determine the position of the highest spurious emission.
4. The height of the receiving antenna is varied between 1m to 4m to search the maximum spurious emission for both horizontal and vertical polarizations.
5. During the measurement, the system simulator parameters were set to force the EUT transmitting at maximum output power.
6. Make the measurement with the spectrum analyzer's RBW = 1MHz, VBW = 3MHz, taking the record of maximum spurious emission.
7. A horn antenna was substituted in place of the EUT and was driven by a signal generator. Tune the output power of signal generator to the same emission level with EUT maximum spurious emission.  
$$\text{EIRP (dBm)} = \text{S.G. Power} - \text{Tx Cable Loss} + \text{Tx Antenna Gain}$$
$$\text{ERP (dBm)} = \text{EIRP} - 2.15$$
8. The RF fundamental frequency should be excluded against the limit line in the operating frequency band.  
The limit line is -40dBm/MHz



## 5 List of Measuring Equipment

Instrument	Manufacturer	Model No.	Serial No.	Characteristics	Calibration Date	Test Date	Due Date	Remark
Loop Antenna	Rohde & Schwarz	HFH2-Z2	100315	9 kHz~30 MHz	Dec. 26, 2019	Jul. 01, 2020~ Jul. 10, 2020	Dec. 25, 2020	Radiation (03CH12-HY)
Bilog Antenna	TESEQ	CBL 6111D & 00800N1D01 N-06	37059 & 01	30MHz~1GHz	Oct. 12, 2019	Jul. 01, 2020~ Jul. 10, 2020	Oct. 11, 2020	Radiation (03CH12-HY)
Horn Antenna	SCHWARZBE CK	BBHA 9120D	9120D-132 8	1GHz ~ 18GHz	Nov. 14, 2019	Jul. 01, 2020~ Jul. 10, 2020	Nov. 13, 2020	Radiation (03CH12-HY)
Horn Antenna	SCHWARZBE CK	BBHA 9120D	9120D-152 2	1GHz ~ 18GHz	Sep. 19, 2019	Jul. 01, 2020~ Jul. 10, 2020	Sep. 18, 2020	Radiation (03CH12-HY)
SHF-EHF Horn Antenna	SCHWARZBE CK	BBHA 9170	BBHA9170 584	18GHz ~ 40GHz	Dec. 10, 2019	Jul. 01, 2020~ Jul. 10, 2020	Dec. 09, 2020	Radiation (03CH12-HY)
SHF-EHF Horn Antenna	SCHWARZBE CK	BBHA 9170	BBHA9170 980	18GHz ~ 40GHz	Jan. 10, 2019	Jul. 01, 2020~ Jul. 10, 2020	Jan. 09, 2021	Radiation (03CH12-HY)
Preamplifier	COM-POWER	PA-103	161075	10MHz~1GHz	Mar. 25, 2020	Jul. 01, 2020~ Jul. 10, 2020	Mar. 24, 2021	Radiation (03CH12-HY)
Preamplifier	Jet-Power	JPA00101800 -30-10P	160118000 2	1GHz~18GHz	Feb. 07, 2020	Jul. 01, 2020~ Jul. 10, 2020	Feb. 06, 2021	Radiation (03CH12-HY)
Preamplifier	EMEC	EM18G40G	060715	18GHz ~ 40GHz	Dec. 13, 2019	Jul. 01, 2020~ Jul. 10, 2020	Dec. 12, 2020	Radiation (03CH12-HY)
Preamplifier	Keysight	83017A	MY532701 48	1GHz~26.5GHz	Dec. 20, 2019	Jul. 01, 2020~ Jul. 10, 2020	Dec. 19, 2020	Radiation (03CH12-HY)
Signal Analyzer	Agilent	N9010A	MY534701 18	10Hz~44GHz	Mar. 12, 2020	Jul. 01, 2020~ Jul. 10, 2020	Mar. 11, 2021	Radiation (03CH12-HY)
Signal Generator	Rohde & Schwarz	SMB100A	101107	100kHz~40GHz	Aug. 27, 2019	Jul. 01, 2020~ Jul. 10, 2020	Aug. 26, 2020	Radiation (03CH12-HY)
Hygrometer	TECEPEL	DTM-303B	TP161243	N/A	May 11, 2020	Jul. 01, 2020~ Jul. 10, 2020	May 10, 2021	Radiation (03CH12-HY)
RF Cable	HUBER + SUHNER	SUCOFLEX 126E	0058/126E	30M-18G	Dec. 12, 2019	Jul. 01, 2020~ Jul. 10, 2020	Dec. 11, 2020	Radiation (03CH12-HY)
RF Cable	HUBER + SUHNER	SUCOFLEX 102	505134/2	30M~40GHz	Feb. 25, 2020	Jul. 01, 2020~ Jul. 10, 2020	Feb. 24, 2021	Radiation (03CH12-HY)
RF Cable	HUBER + SUHNER	SUCOFLEX 102	800740/2	30M~40GHz	Feb. 25, 2020	Jul. 01, 2020~ Jul. 10, 2020	Feb. 24, 2021	Radiation (03CH12-HY)
Controller	EMEC	EM1000	N/A	Control Turn table & Ant Mast	N/A	Jul. 01, 2020~ Jul. 10, 2020	N/A	Radiation (03CH12-HY)
Antenna Mast	EMEC	AM-BS-4500- B	N/A	1m~4m	N/A	Jul. 01, 2020~ Jul. 10, 2020	N/A	Radiation (03CH12-HY)
Turn Table	EMEC	TT2000	N/A	0~360 Degree	N/A	Jul. 01, 2020~ Jul. 10, 2020	N/A	Radiation (03CH12-HY)
Software	Audix	E3 6.2009-8-24	RK-00098 9	N/A	N/A	Jul. 01, 2020~ Jul. 10, 2020	N/A	Radiation (03CH12-HY)





Instrument	Manufacturer	Model No.	Serial No.	Characteristics	Calibration Date	Test Date	Due Date	Remark
LTE Base Station	Anritsu	MT8821C	626200253 41	-	Oct. 24, 2019	Jun. 05, 2020~ Jul. 30, 2020	Oct. 23, 2020	Conducted (TH05-HY)
Spectrum Analyzer	Rohde & Schwarz	FSV40	101397	10Hz~40GHz	Nov. 15, 2019	Jun. 05, 2020~ Jul. 30, 2020	Nov. 14, 2020	Conducted (TH05-HY)
Temperature Chamber	ESPEC	SH-641	92013720	-40°C~90°C	Sep. 02, 2019	Jun. 05, 2020~ Jul. 30, 2020	Sep. 01, 2020	Conducted (TH05-HY)
Programmable Power Supply	GW Instek	PSS-2005	EL890094	1V~20V 0.5A~5A	Oct. 09, 2019	Jun. 05, 2020~ Jul. 30, 2020	Oct. 08, 2020	Conducted (TH05-HY)
Coupler	Warison	20dB 25W SMA Directional Coupler	#A	1-18GHz	Jan. 13, 2020	Jun. 05, 2020~ Jul. 30, 2020	Jan. 12, 2021	Conducted (TH05-HY)



## 6 Uncertainty of Evaluation

### Uncertainty of Radiated Emission Measurement (30 MHz ~ 1000 MHz)

Measuring Uncertainty for a Level of Confidence of 95% ( $U = 2Uc(y)$ )	3.24
---	------

### Uncertainty of Radiated Emission Measurement (1 GHz ~ 18 GHz)

Measuring Uncertainty for a Level of Confidence of 95% ( $U = 2Uc(y)$ )	3.62
---	------

### Uncertainty of Radiated Emission Measurement (18 GHz ~ 40 GHz)

Measuring Uncertainty for a Level of Confidence of 95% ( $U = 2Uc(y)$ )	4.06
---	------



## Appendix A. Test Results of Conducted Test

### Conducted Output Power(Average power)

<Primary Antenna>

LTE Band 48 Maximum Average Power [dBm]						
BW [MHz]	RB Size	RB Offset	Mod	Lowest	Middle	Highest
20	1	0	QPSK	24.21	24.10	24.13
20	1	49		24.02	23.82	23.89
20	1	99		23.99	23.90	23.82
20	50	0		23.24	22.98	23.16
20	50	24		23.21	22.94	23.07
20	50	50		23.05	22.95	22.94
20	100	0		23.15	22.99	23.10
20	1	0	16-QAM	23.33	23.22	23.28
20	1	49		23.12	23.10	22.98
20	1	99		23.10	23.02	22.96
20	50	0		22.27	22.05	22.20
20	50	24		22.23	21.89	22.14
20	50	50		22.08	22.03	21.97
20	100	0		22.21	21.96	22.10
20	1	0	64-QAM	22.04	22.05	22.00
20	1	49		21.86	21.63	21.75
20	1	99		21.83	21.77	21.68
20	50	0		21.27	21.05	21.19
20	50	24		21.23	20.99	21.14
20	50	50		21.09	20.98	20.98
20	100	0		21.21	21.04	21.12
15	1	0	QPSK	24.20	23.91	24.07
15	1	37		23.95	23.91	23.84
15	1	74		23.98	23.72	23.81
15	36	0		23.23	23.13	23.10
15	36	20		23.14	22.99	23.04
15	36	39		23.03	22.87	22.90
15	75	0		23.09	22.78	23.04
15	1	0	16-QAM	23.29	23.05	23.24
15	1	37		23.08	23.09	22.92
15	1	74		23.06	22.77	22.91
15	36	0		22.18	21.95	22.13
15	36	20		22.18	22.08	22.13
15	36	39		22.04	21.88	21.91
15	75	0		22.18	21.98	22.03
15	1	0	64-QAM	21.97	21.80	21.97
15	1	37		21.82	21.58	21.70
15	1	74		21.80	21.68	21.67
15	36	0		21.20	21.17	21.13
15	36	20		21.21	20.96	21.05
15	36	39		21.05	21.07	20.88
15	75	0		21.21	21.03	21.11



LTE Band 48 Maximum Average Power [dBm]						
BW [MHz]	RB Size	RB Offset	Mod	Lowest	Middle	Highest
10	1	0	QPSK	24.11	23.92	24.12
10	1	25		24.02	23.90	23.79
10	1	49		23.94	23.72	23.72
10	25	0		23.14	23.06	23.13
10	25	12		23.11	22.82	22.97
10	25	25		22.97	22.90	22.85
10	50	0		23.17	22.75	23.05
10	1	0	16-QAM	23.27	23.14	23.28
10	1	25		23.06	23.01	22.90
10	1	49		23.00	22.71	22.86
10	25	0		22.21	22.15	22.11
10	25	12		22.18	22.10	22.14
10	25	25		22.08	22.01	21.88
10	50	0		22.12	22.02	22.00
10	1	0	64-QAM	22.02	22.05	21.90
10	1	25		21.86	21.69	21.71
10	1	49		21.80	21.54	21.65
10	25	0		21.18	21.04	21.10
10	25	12		21.23	21.07	21.08
10	25	25		21.06	20.95	20.94
10	50	0		21.13	20.83	21.05
5	1	0	QPSK	24.12	24.19	24.10
5	1	12		23.99	23.96	23.79
5	1	24		23.99	23.73	23.80
5	12	0		23.17	22.98	23.09
5	12	7		23.11	22.85	23.00
5	12	13		22.95	22.91	22.87
5	25	0		23.09	23.04	23.00
5	1	0	16-QAM	23.32	23.18	23.18
5	1	12		23.04	22.91	22.93
5	1	24		23.10	23.05	22.87
5	12	0		22.25	22.09	22.20
5	12	7		22.16	21.91	22.12
5	12	13		22.01	21.83	21.88
5	25	0		22.15	21.83	22.10
5	1	0	64-QAM	21.96	22.05	21.90
5	1	12		21.86	21.57	21.67
5	1	24		21.77	21.55	21.64
5	12	0		21.19	20.97	21.15
5	12	7		21.15	21.00	21.07
5	12	13		21.06	20.86	20.97
5	25	0		21.16	20.86	21.02



LTE Band 48C_CA Maximum Average Power [dBm]								
BW [MHz]	PCC		SCC		Mod	Lowest	Middle	Highest
	RB Size	RB Offset	RB Size	RB Offset				
20+20	100	0	100	0	QPSK	6.11	14.79	6.32
20+20	1	0	1	99		6.12	14.72	6.25
20+20	1	99	1	0		5.91	14.44	6.02
20+20	100	0	100	0	16-QAM	6.13	14.76	6.32
20+20	1	0	1	99		6.52	<b>15.23</b>	6.79
20+20	1	99	1	0		6.33	14.98	6.55
20+20	100	0	100	0	64-QAM	6.18	14.81	6.31
20+20	1	0	1	99		6.26	14.92	6.43
20+20	1	99	1	0		5.99	14.75	6.21
20+15	100	0	75	0	QPSK	6.12	14.62	6.30
20+15	1	0	1	74		6.27	14.98	6.05
20+15	1	74	1	0		5.94	14.40	6.26
20+15	100	0	75	0	16-QAM	6.24	14.93	6.15
20+15	1	0	1	74		6.49	15.13	7.02
20+15	1	74	1	0		6.27	15.11	6.83
20+15	100	0	75	0	64-QAM	6.16	14.87	6.46
20+15	1	0	1	74		6.34	15.05	6.25
20+15	1	74	1	0		5.90	14.58	5.95
15+20	75	0	100	0	QPSK	5.85	14.72	6.11
15+20	1	0	1	99		5.90	14.48	6.53
15+20	1	74	1	0		5.88	14.21	6.27
15+20	75	0	100	0	16-QAM	6.13	14.47	6.59
15+20	1	0	1	99		6.76	15.22	6.74
15+20	1	74	1	0		6.10	14.91	6.80
15+20	75	0	100	0	64-QAM	6.19	14.75	6.40
15+20	1	0	1	99		6.16	15.05	6.31
15+20	1	74	1	0		5.84	14.69	6.03



LTE Band 48C_CA Maximum Average Power [dBm]								
BW [MHz]	PCC		SCC		Mod	Lowest	Middle	Highest
	RB Size	RB Offset	RB Size	RB Offset				
20+10	100	0	50	0	QPSK	6.40	14.89	6.24
20+10	1	0	1	49		5.92	15.00	6.15
20+10	1	99	1	0		5.72	14.46	5.72
20+10	100	0	50	0	16-QAM	6.41	14.69	6.09
20+10	1	0	1	49		6.64	15.07	6.50
20+10	1	99	1	0		6.29	15.22	6.81
20+10	100	0	50	0	64-QAM	6.46	14.57	6.16
20+10	1	0	1	49		6.22	14.89	6.65
20+10	1	99	1	0		5.75	14.84	5.98
10+20	50	0	100	0	QPSK	6.22	14.57	6.29
10+20	1	0	1	99		5.98	14.43	6.12
10+20	1	49	1	0		6.08	14.17	5.96
10+20	50	0	100	0	16-QAM	5.96	14.95	6.30
10+20	1	0	1	99		6.29	15.15	6.59
10+20	1	49	1	0		6.34	14.71	6.54
10+20	50	0	100	0	64-QAM	6.43	15.00	6.13
10+20	1	0	1	99		6.06	15.22	6.52
10+20	1	49	1	0		5.79	14.70	6.44
20+5	100	0	25	0	QPSK	6.10	14.56	6.04
20+5	1	0	1	24		6.32	14.78	6.44
20+5	1	99	1	0		6.16	14.70	6.24
20+5	100	0	25	0	16-QAM	6.38	14.89	6.62
20+5	1	0	1	24		6.73	15.09	6.71
20+5	1	99	1	0		6.31	15.14	6.83
20+5	100	0	25	0	64-QAM	6.17	15.11	6.43
20+5	1	0	1	24		6.45	15.05	6.13
20+5	1	99	1	0		5.90	14.45	6.45
5+20	25	0	100	0	QPSK	5.95	14.69	6.51
5+20	1	0	1	99		6.21	14.88	6.44
5+20	1	24	1	0		6.11	14.43	6.13
5+20	25	0	100	0	16-QAM	5.91	14.59	6.02
5+20	1	0	1	99		6.58	15.08	6.90
5+20	1	24	1	0		6.12	14.69	6.42
5+20	25	0	100	0	64-QAM	6.12	14.51	6.30
5+20	1	0	1	99		6.07	15.15	6.20
5+20	1	24	1	0		5.83	14.83	6.36



<ASDIV Antenna>

LTE Band 48 Maximum Average Power [dBm]						
BW [MHz]	RB Size	RB Offset	Mod	Lowest	Middle	Highest
20	1	0	QPSK	20.81	20.85	20.73
20	1	49		20.66	20.47	20.50
20	1	99		20.59	20.59	20.44
20	50	0		20.65	20.40	20.55
20	50	24		20.60	20.33	20.48
20	50	50		20.48	20.31	20.32
20	100	0		20.58	20.28	20.49
20	1	0	16-QAM	20.69	20.67	20.68
20	1	49		20.51	20.47	20.39
20	1	99		20.52	20.41	20.36
20	50	0		19.69	19.58	19.57
20	50	24		19.64	19.39	19.52
20	50	50		19.52	19.35	19.36
20	100	0		19.64	19.54	19.51
20	1	0	64-QAM	19.42	19.26	19.41
20	1	49		19.31	19.12	19.33
20	1	99		19.30	19.10	19.35
20	50	0		18.67	18.61	18.58
20	50	24		18.67	18.35	18.53
20	50	50		18.52	18.50	18.37
20	100	0		18.64	18.38	18.51
15	1	0	QPSK	20.72	20.73	20.34
15	1	37		20.63	20.54	20.31
15	1	74		20.62	20.63	20.30
15	36	0		20.61	20.48	20.34
15	36	20		20.59	20.53	20.30
15	36	39		20.47	20.19	20.31
15	75	0		20.52	20.55	20.33
15	1	0	16-QAM	20.64	20.43	20.32
15	1	37		20.42	20.25	20.31
15	1	74		20.55	20.26	20.33
15	36	0		19.60	19.59	19.19
15	36	20		19.55	19.41	19.12
15	36	39		19.44	19.21	19.06
15	75	0		19.53	19.47	19.18
15	1	0	64-QAM	19.36	19.36	19.06
15	1	37		19.28	19.10	18.88
15	1	74		19.25	19.06	18.80
15	36	0		18.64	18.64	18.27
15	36	20		18.61	18.32	18.16
15	36	39		18.50	18.18	18.09
15	75	0		18.53	18.54	18.19



LTE Band 48 Maximum Average Power [dBm]						
BW [MHz]	RB Size	RB Offset	Mod	Lowest	Middle	Highest
10	1	0	QPSK	20.67	20.50	20.32
10	1	25		20.55	20.42	20.31
10	1	49		20.60	20.60	20.32
10	25	0		20.60	20.58	20.38
10	25	12		20.59	20.34	20.35
10	25	25		20.44	20.34	20.33
10	50	0		20.47	20.48	20.31
10	1	0	16-QAM	20.61	20.65	20.30
10	1	25		20.36	20.20	20.33
10	1	49		20.50	20.43	20.32
10	25	0		19.54	19.32	19.12
10	25	12		19.45	19.53	19.11
10	25	25		19.34	19.24	19.04
10	50	0		19.44	19.44	19.08
10	1	0	64-QAM	19.32	19.28	19.03
10	1	25		19.27	19.17	18.87
10	1	49		19.16	19.02	18.81
10	25	0		18.56	18.39	18.17
10	25	12		18.52	18.27	18.09
10	25	25		18.40	18.24	18.07
10	50	0		18.49	18.43	18.12
5	1	0	QPSK	20.70	20.57	20.34
5	1	12		20.59	20.42	20.31
5	1	24		20.54	20.32	20.32
5	12	0		20.54	20.61	20.36
5	12	7		20.59	20.42	20.33
5	12	13		20.38	20.20	20.34
5	25	0		20.50	20.49	20.32
5	1	0	16-QAM	20.63	20.41	20.32
5	1	12		20.42	20.15	20.30
5	1	24		20.50	20.29	20.31
5	12	0		19.51	19.40	19.18
5	12	7		19.45	19.30	19.09
5	12	13		19.37	19.23	19.04
5	25	0		19.52	19.27	19.10
5	1	0	64-QAM	19.28	19.42	18.98
5	1	12		19.19	19.12	18.83
5	1	24		19.17	19.00	18.81
5	12	0		18.60	18.53	18.24
5	12	7		18.53	18.43	18.14
5	12	13		18.42	18.46	18.00
5	25	0		18.43	18.31	18.15





LTE Band 48C_CA Maximum Average Power [dBm]								
BW [MHz]	PCC		SCC		Mod	Lowest	Middle	Highest
	RB Size	RB Offset	RB Size	RB Offset				
20+20	100	0	100	0	QPSK	4.54	13.23	4.63
20+20	1	0	1	99		4.48	13.02	4.64
20+20	1	99	1	0		4.15	12.87	4.48
20+20	100	0	100	0	16-QAM	4.59	13.07	4.80
20+20	1	0	1	99		4.89	13.57	5.22
20+20	1	99	1	0		4.74	13.38	4.75
20+20	100	0	100	0	64-QAM	4.65	13.20	4.65
20+20	1	0	1	99		4.76	13.32	4.65
20+20	1	99	1	0		4.49	13.17	4.47
20+15	100	0	75	0	QPSK	4.24	13.15	4.48
20+15	1	0	1	74		4.53	13.10	4.54
20+15	1	74	1	0		4.19	13.03	4.61
20+15	100	0	75	0	16-QAM	4.88	13.04	4.89
20+15	1	0	1	74		4.82	13.32	5.47
20+15	1	74	1	0		4.68	13.11	4.67
20+15	100	0	75	0	64-QAM	4.93	12.96	4.75
20+15	1	0	1	74		4.96	13.10	4.59
20+15	1	74	1	0		4.47	12.94	4.41
15+20	75	0	100	0	QPSK	4.61	13.51	4.67
15+20	1	0	1	99		4.20	12.82	4.88
15+20	1	74	1	0		4.31	13.09	4.78
15+20	75	0	100	0	16-QAM	4.58	12.85	4.73
15+20	1	0	1	99		5.09	13.46	5.29
15+20	1	74	1	0		4.48	13.47	4.82
15+20	75	0	100	0	64-QAM	4.74	12.93	4.73
15+20	1	0	1	99		4.94	13.14	4.84
15+20	1	74	1	0		4.61	13.46	4.73



LTE Band 48C_CA Maximum Average Power [dBm]								
BW [MHz]	PCC		SCC		Mod	Lowest	Middle	Highest
	RB Size	RB Offset	RB Size	RB Offset				
20+10	100	0	50	0	QPSK	4.52	13.39	4.62
20+10	1	0	1	49		4.71	13.18	4.78
20+10	1	99	1	0		4.03	12.72	4.23
20+10	100	0	50	0	16-QAM	4.69	13.32	4.88
20+10	1	0	1	49		5.18	13.34	4.93
20+10	1	99	1	0		4.47	13.25	4.64
20+10	100	0	50	0	64-QAM	4.86	13.48	4.95
20+10	1	0	1	49		4.68	13.29	4.52
20+10	1	99	1	0		4.50	13.08	4.44
10+20	50	0	100	0	QPSK	4.61	13.50	4.39
10+20	1	0	1	99		4.66	13.23	4.64
10+20	1	49	1	0		3.97	12.65	4.42
10+20	50	0	100	0	16-QAM	4.73	12.99	5.02
10+20	1	0	1	99		4.71	13.47	5.22
10+20	1	49	1	0		4.71	13.14	4.88
10+20	50	0	100	0	64-QAM	4.44	13.48	4.56
10+20	1	0	1	99		4.52	13.28	4.35
10+20	1	49	1	0		4.31	13.01	4.69
20+5	100	0	25	0	QPSK	4.33	13.27	4.50
20+5	1	0	1	24		4.24	13.21	4.72
20+5	1	99	1	0		4.42	13.16	4.35
20+5	100	0	25	0	16-QAM	4.86	13.01	4.61
20+5	1	0	1	24		4.83	13.38	5.45
20+5	1	99	1	0		5.04	13.30	4.74
20+5	100	0	25	0	64-QAM	4.42	13.43	4.75
20+5	1	0	1	24		4.78	13.24	4.57
20+5	1	99	1	0		4.46	13.11	4.75
5+20	25	0	100	0	QPSK	4.56	13.41	4.77
5+20	1	0	1	99		4.64	13.27	4.46
5+20	1	24	1	0		4.44	12.96	4.33
5+20	25	0	100	0	16-QAM	4.36	13.31	4.76
5+20	1	0	1	99		4.89	13.33	4.94
5+20	1	24	1	0		4.64	13.54	4.50
5+20	25	0	100	0	64-QAM	4.54	13.50	4.62
5+20	1	0	1	99		4.97	13.04	4.62
5+20	1	24	1	0		4.52	13.38	4.63



# LTE Band 48

## Peak-to-Average Ratio

Mode	LTE Band 48 / 20MHz				
Mod.	QPSK		16QAM		Limit: 13dB
RB Size	1RB	Full RB	1RB	Full RB	Result
Lowest CH	3.71	4.99	5.59	5.88	PASS
Middle CH	3.68	5.07	5.36	5.91	
Highest CH	3.71	5.07	5.45	5.86	
Mode	LTE Band 48 / 20MHz				
Mod.	64QAM				Limit: 13dB
RB Size	1RB	Full RB			Result
Lowest CH	6.46	6.41	-	-	PASS
Middle CH	6.41	6.38	-	-	
Highest CH	6.55	6.32	-	-	



LTE Band 48 / 20MHz / QPSK

Lowest Channel / 1RB

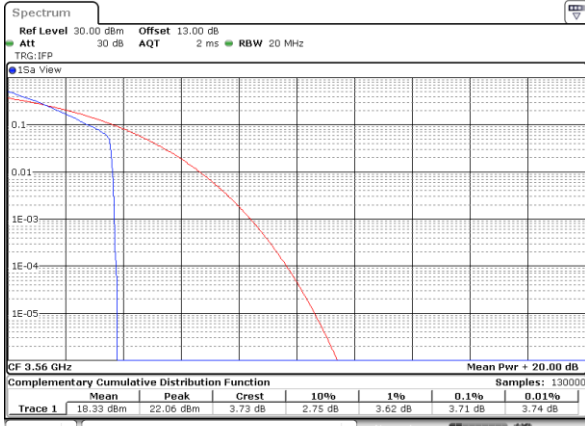

Date: 15\_JUL\_2020 01:23:53

Lowest Channel / Full RB

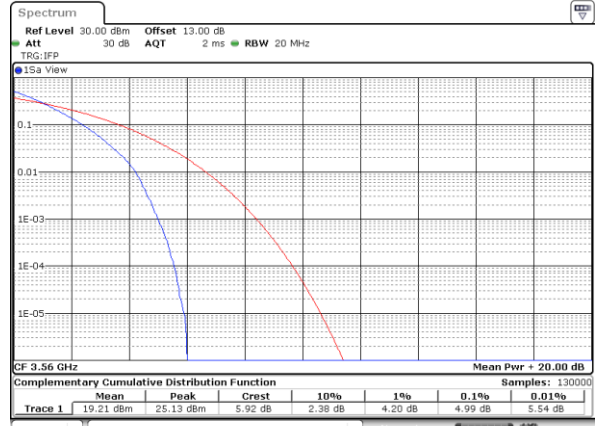

Date: 15\_JUL\_2020 01:24:12

Middle Channel / 1RB

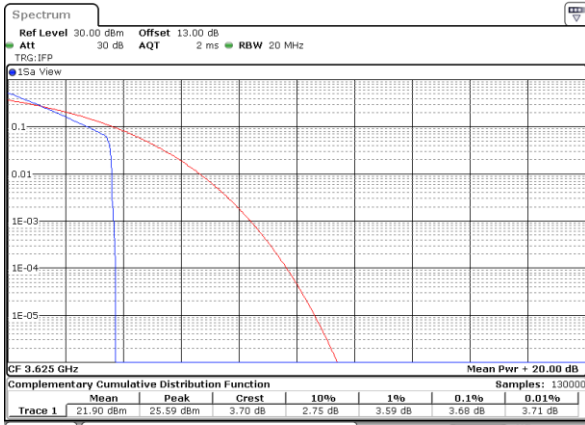

Date: 15\_JUL\_2020 01:24:45

Middle Channel / Full RB

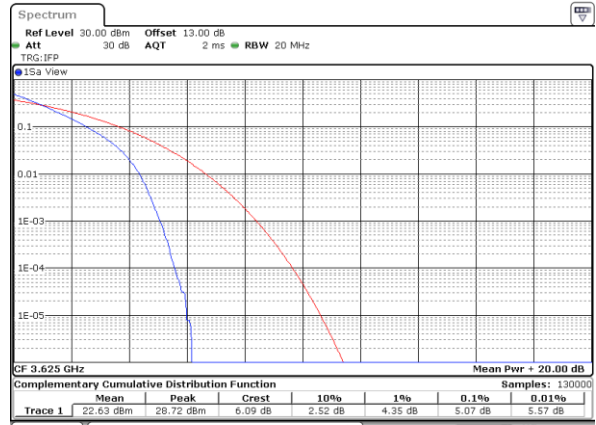

Date: 15\_JUL\_2020 01:25:03

Highest Channel / 1RB

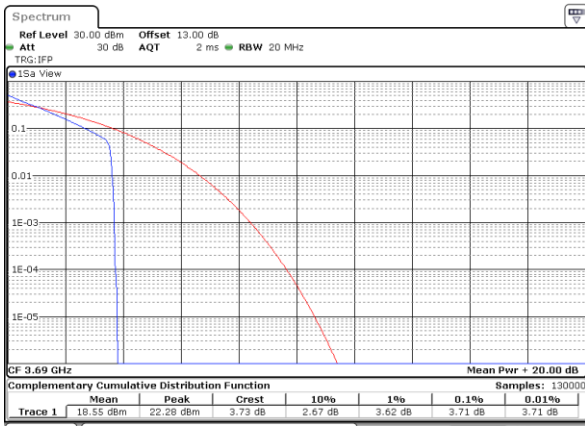

Date: 15\_JUL\_2020 01:25:21

Highest Channel / Full RB

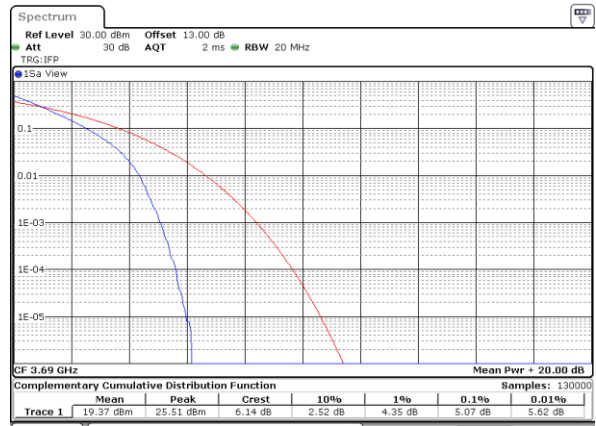

Date: 15\_JUL\_2020 01:25:41



LTE Band 48 / 20MHz / 16QAM

Lowest Channel / 1RB

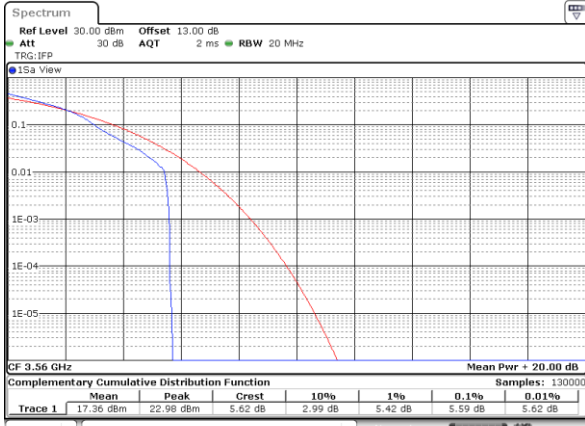

Date: 15\_JUL\_2020 01:21:46

Lowest Channel / Full RB

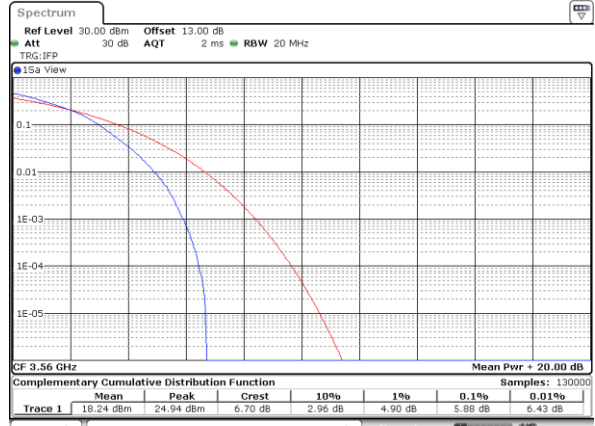

Date: 15\_JUL\_2020 01:22:18

Middle Channel / 1RB

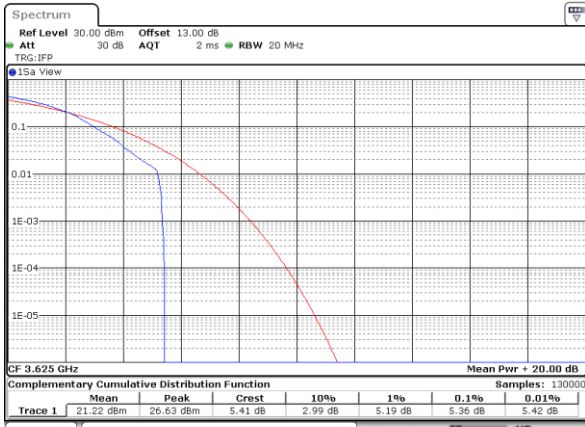

Date: 15\_JUL\_2020 01:22:05

Middle Channel / Full RB

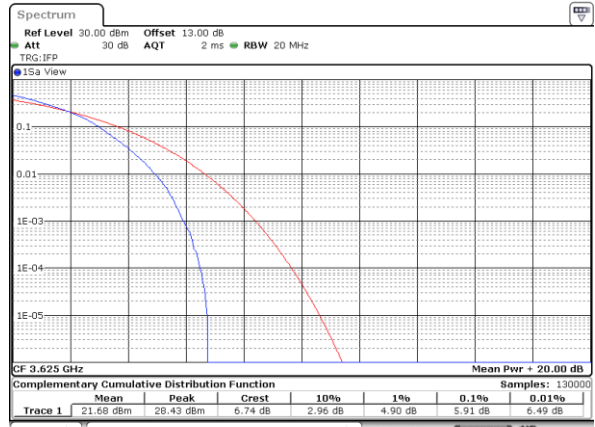

Date: 15\_JUL\_2020 01:22:54

Highest Channel / 1RB

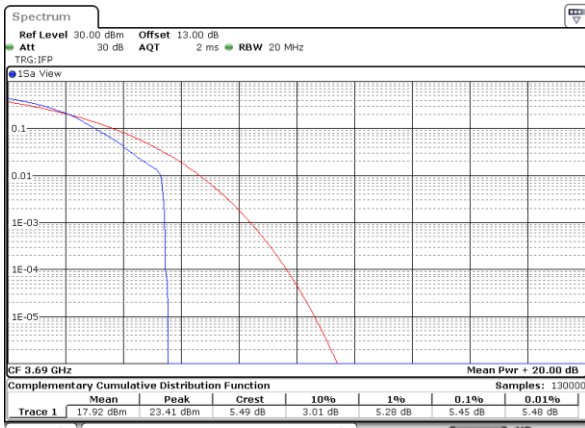

Date: 15\_JUL\_2020 01:23:12

Highest Channel / Full RB

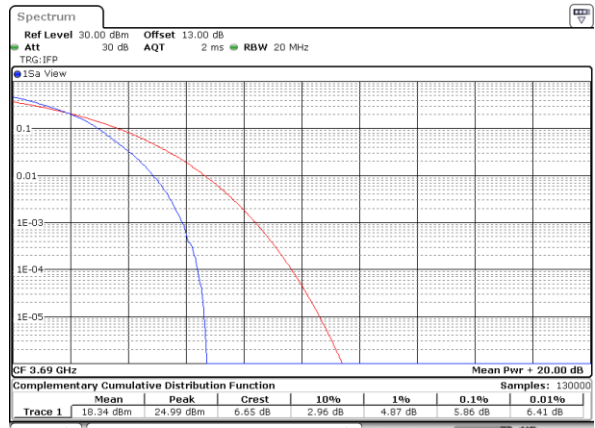

Date: 15\_JUL\_2020 01:23:30



LTE Band 48 / 20MHz / 64QAM

Lowest Channel / 1RB

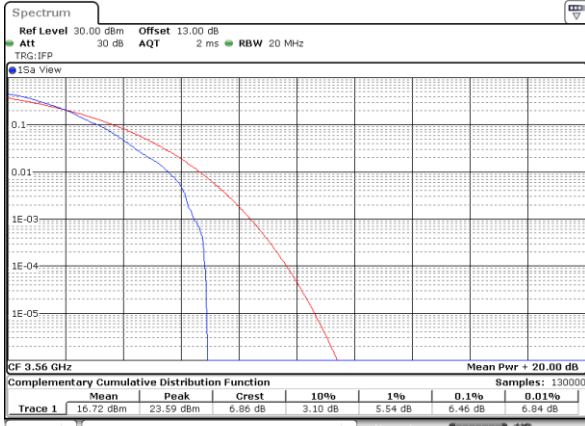

Date: 15\_JUL\_2020 01:18:44

Lowest Channel / Full RB

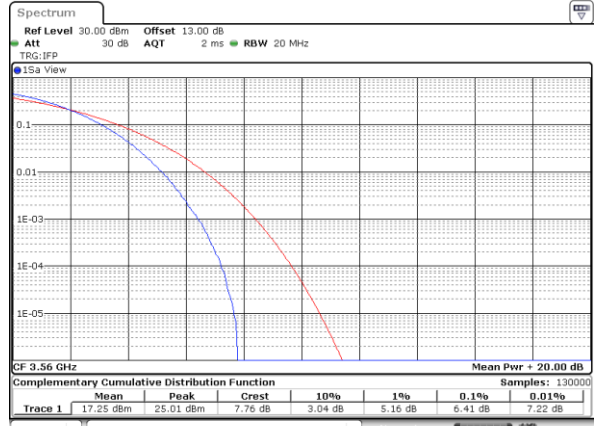

Date: 15\_JUL\_2020 01:19:45

Middle Channel / 1RB

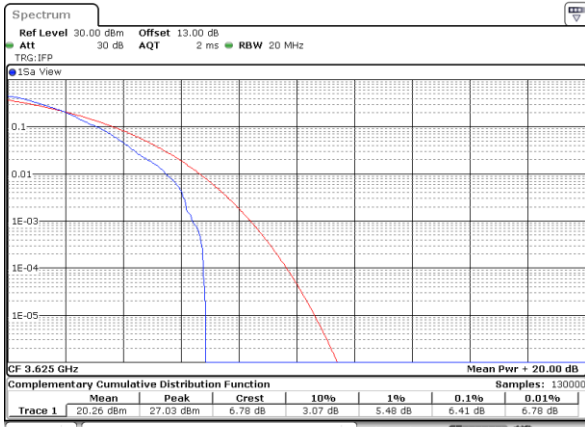

Date: 15\_JUL\_2020 01:20:03

Middle Channel / Full RB

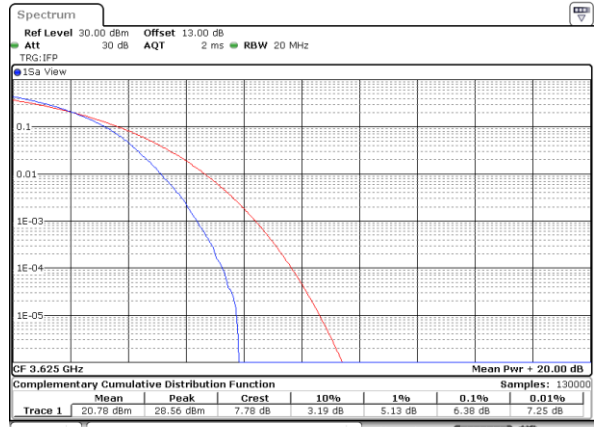

Date: 15\_JUL\_2020 01:20:40

Highest Channel / 1RB

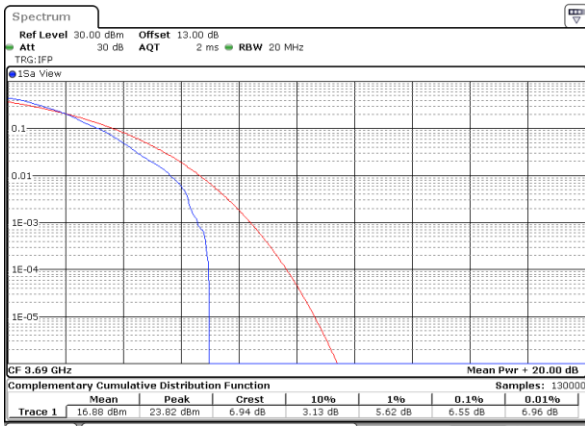

Date: 15\_JUL\_2020 01:21:05

Highest Channel / Full RB

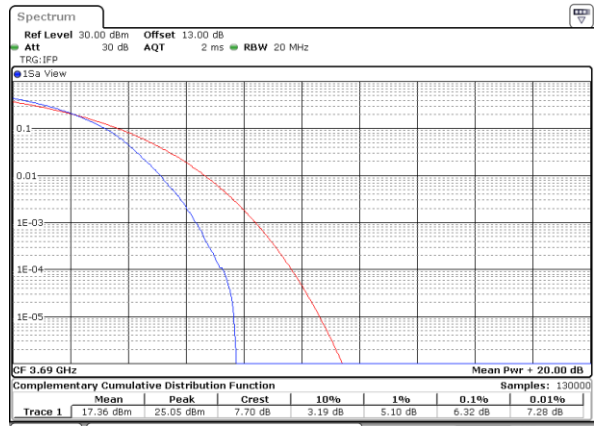

Date: 15\_JUL\_2020 01:21:22



**26dB Bandwidth**

Mode	LTE Band 48 : 26dB BW(MHz)											
BW	1.4MHz		3MHz		5MHz		10MHz		15MHz		20MHz	
Mod.	QPSK	16QAM	QPSK	16QAM	QPSK	16QAM	QPSK	16QAM	QPSK	16QAM	QPSK	16QAM
Lowest CH	-	-	-	-	4.95	4.89	9.79	9.73	14.36	14.51	18.82	18.66
Middle CH	-	-	-	-	4.84	4.86	9.79	9.65	14.45	14.27	18.90	18.70
Highest CH	-	-	-	-	4.89	4.78	9.81	9.69	14.42	14.45	19.18	18.62
Mode	LTE Band 48 : 26dB BW(MHz)											
BW	1.4MHz		3MHz		5MHz		10MHz		15MHz		20MHz	
Mod.	64QAM		64QAM		64QAM		64QAM		64QAM		64QAM	
Lowest CH	-	-	-	-	4.80	-	9.67	-	14.15	-	18.86	-
Middle CH	-	-	-	-	4.75	-	9.85	-	14.21	-	18.70	-
Highest CH	-	-	-	-	4.82	-	9.79	-	14.54	-	18.86	-



LTE Band 48

Lowest Channel / 5MHz / QPSK

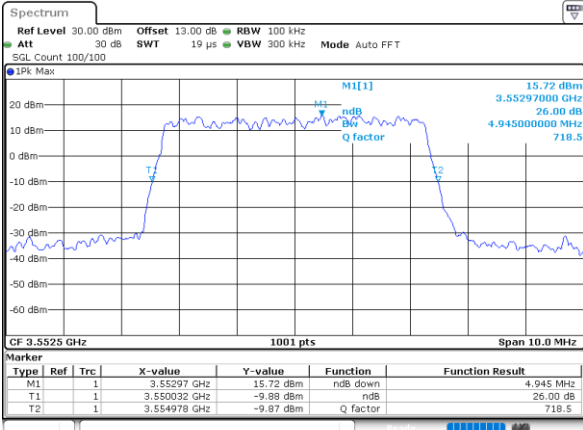

Date: 15\_JUL\_2020 01:02:06

Lowest Channel / 5MHz / 16QAM

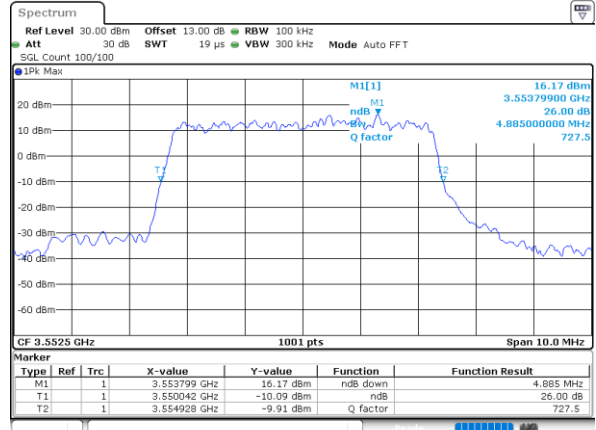

Date: 15\_JUL\_2020 01:02:18

9.81Middle Channel / 5MHz / QPSK

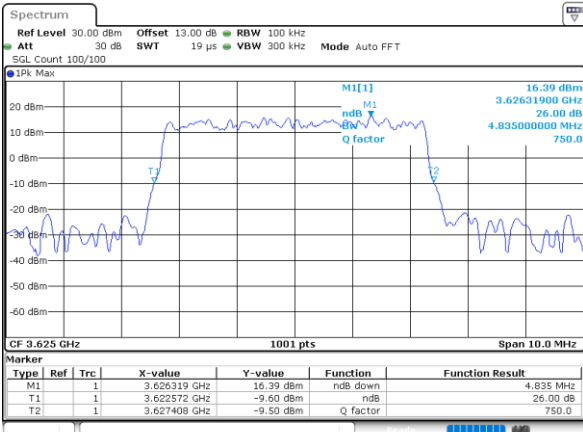

Date: 15\_JUL\_2020 01:02:52

Middle Channel / 5MHz / 16QAM

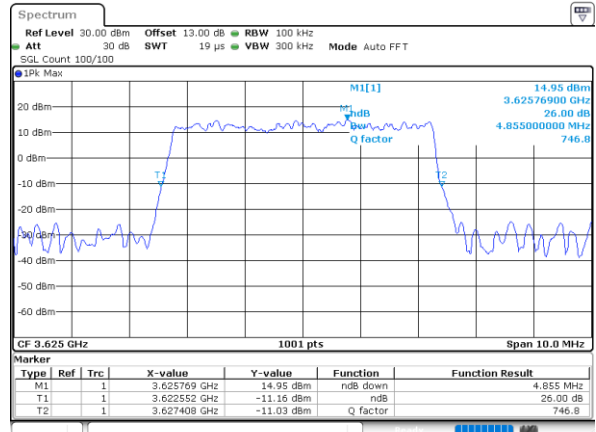

Date: 15\_JUL\_2020 01:03:04

Highest Channel / 5MHz / QPSK

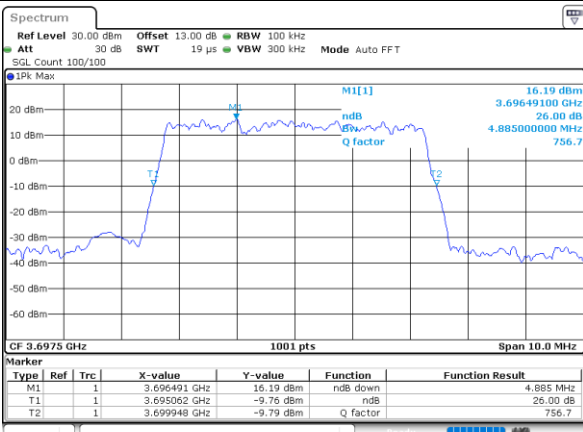

Date: 15\_JUL\_2020 01:03:39

Highest Channel / 5MHz / 16QAM

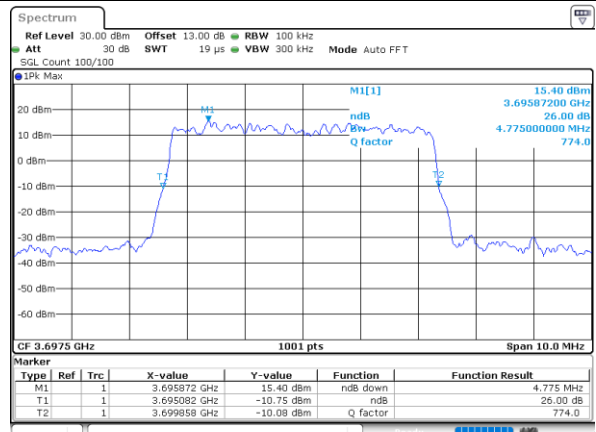

Date: 15\_JUL\_2020 01:03:51





LTE Band 48

Lowest Channel / 10MHz / QPSK

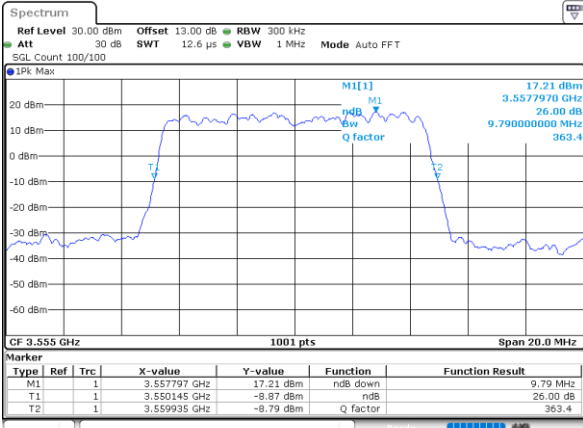

Date: 15\_JUL\_2020 01:04:27

Lowest Channel / 10MHz / 16QAM

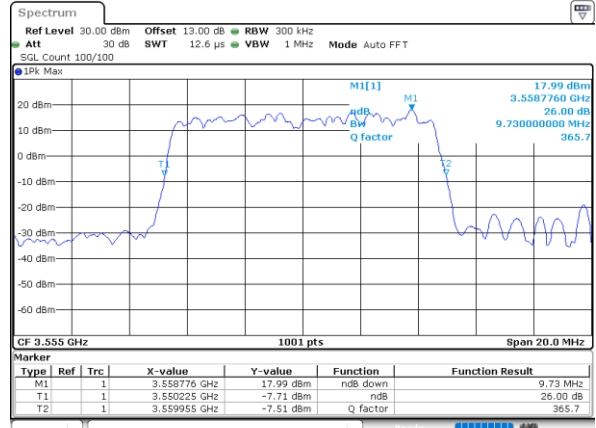

Date: 15\_JUL\_2020 01:04:38

Middle Channel / 10MHz / QPSK

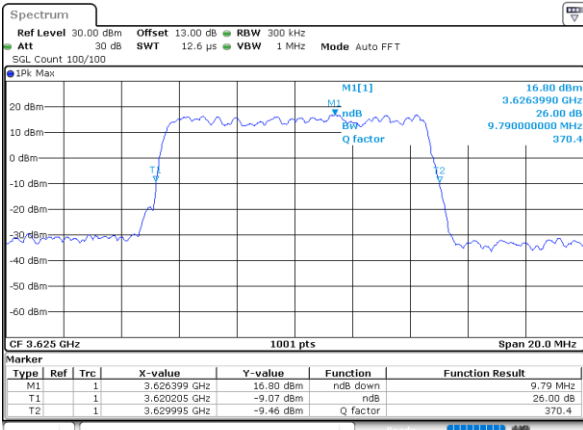

Date: 15\_JUL\_2020 01:05:12

Middle Channel / 10MHz / 16QAM

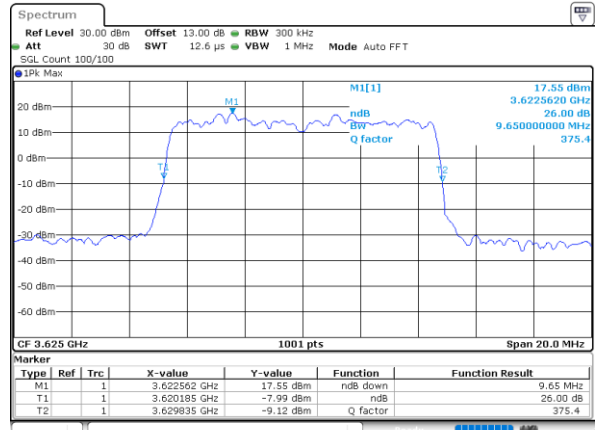

Date: 15\_JUL\_2020 01:05:24

Highest Channel / 10MHz / QPSK

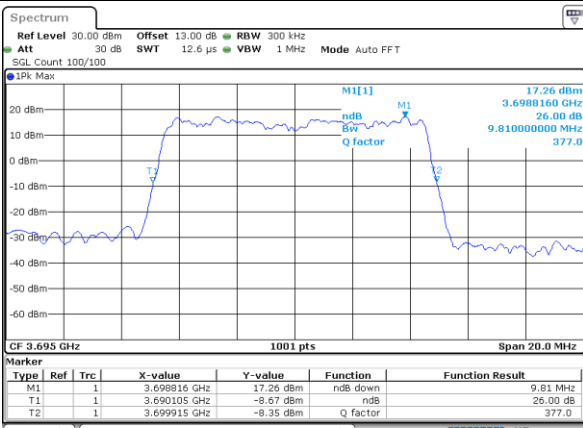

Date: 15\_JUL\_2020 01:05:59

Highest Channel / 10MHz / 16QAM

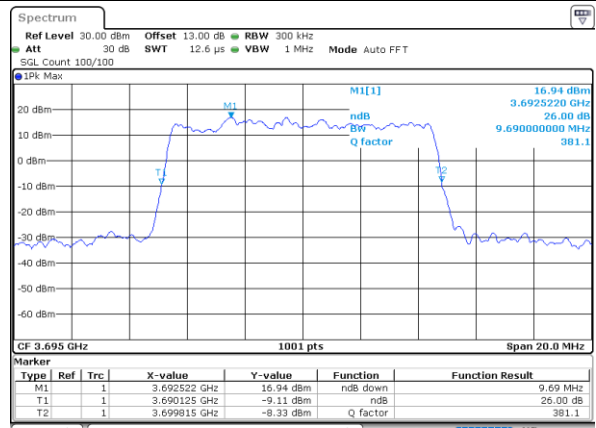

Date: 15\_JUL\_2020 01:06:10



LTE Band 48

Lowest Channel / 15MHz / QPSK

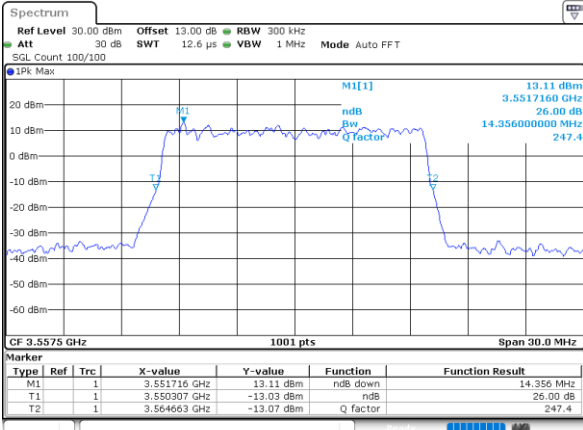

Date: 15\_JUL\_2020 01:06:46

Lowest Channel / 15MHz / 16QAM

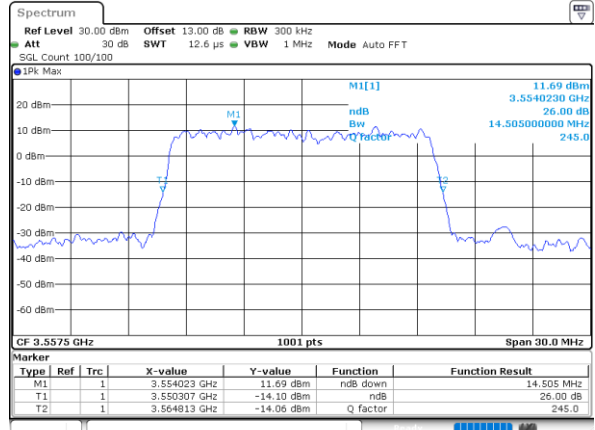

Date: 15\_JUL\_2020 01:06:58

Middle Channel / 15MHz / QPSK

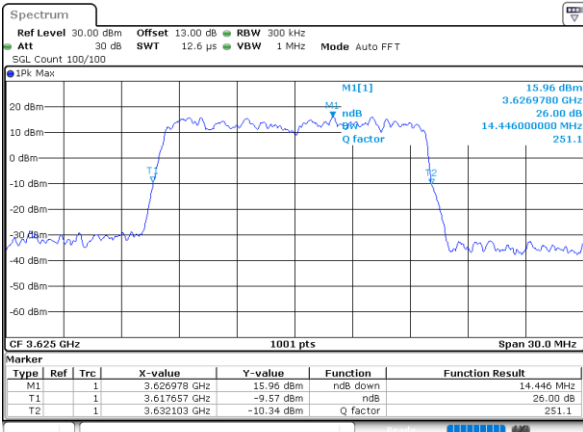

Date: 15\_JUL\_2020 01:07:32

Middle Channel / 15MHz / 16QAM

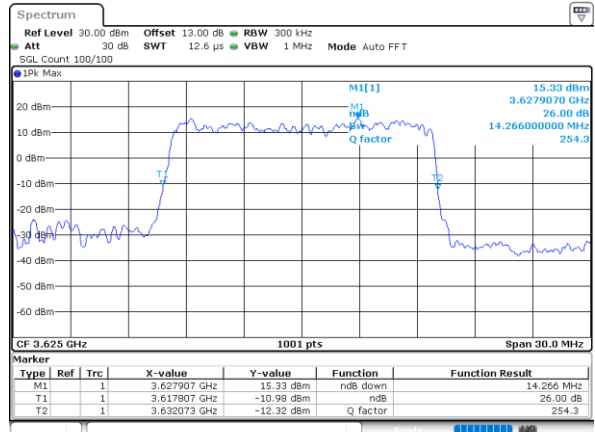

Date: 15\_JUL\_2020 01:07:44

Highest Channel / 15MHz / QPSK

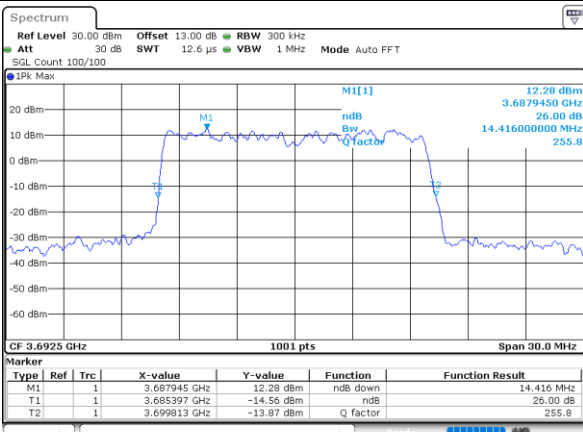

Date: 15\_JUL\_2020 01:08:19

Highest Channel / 15MHz / 16QAM

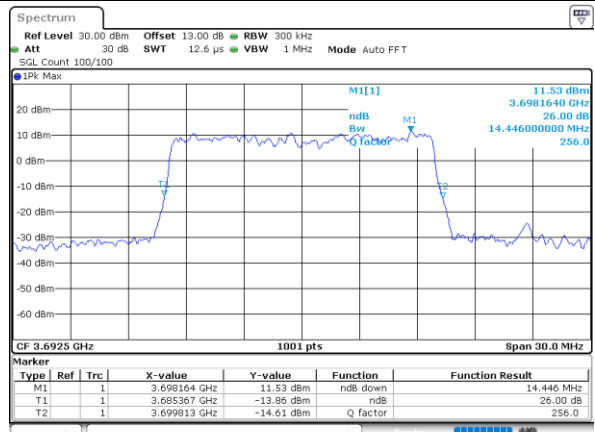

Date: 15\_JUL\_2020 01:08:30



LTE Band 48

Lowest Channel / 20MHz / QPSK

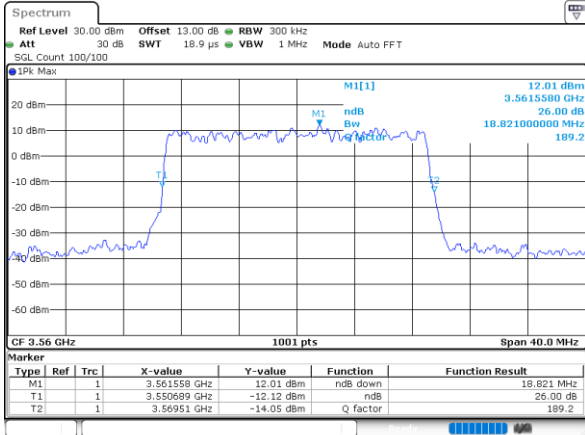

Date: 15\_JUL\_2020 01:09:07

Lowest Channel / 20MHz / 16QAM

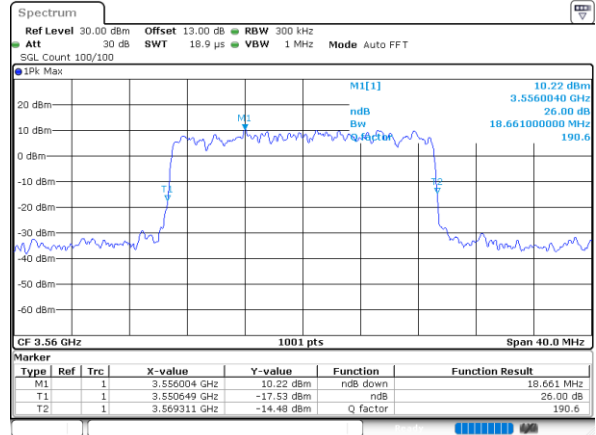

Date: 15\_JUL\_2020 01:09:18

Middle Channel / 20MHz / QPSK

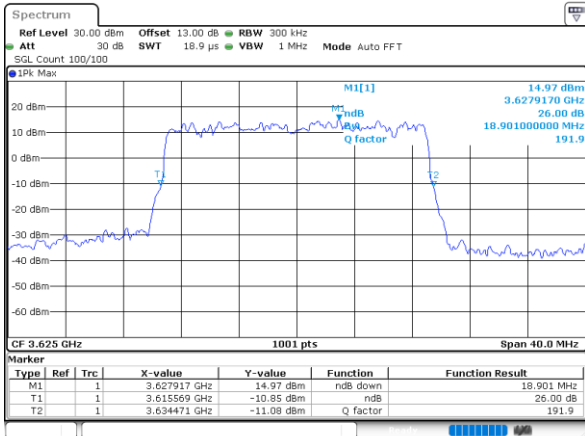

Date: 15\_JUL\_2020 01:09:52

Middle Channel / 20MHz / 16QAM

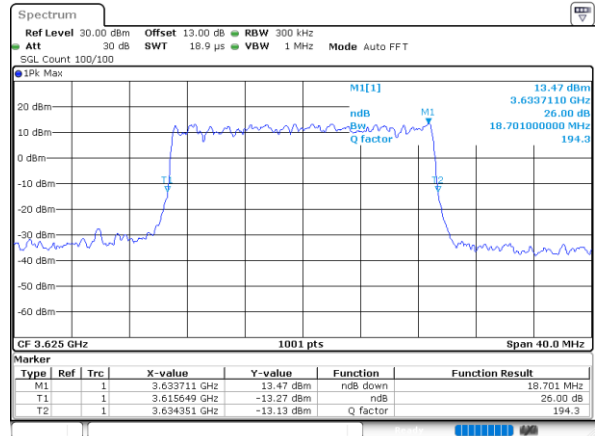

Date: 15\_JUL\_2020 01:10:04

Highest Channel / 20MHz / QPSK

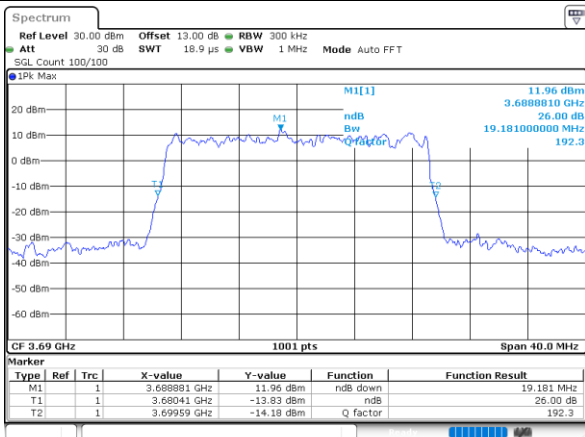

Date: 15\_JUL\_2020 01:10:39

Highest Channel / 20MHz / 16QAM

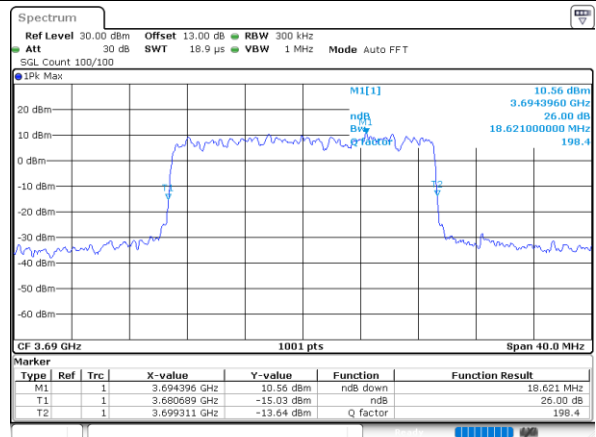

Date: 15\_JUL\_2020 01:10:51



LTE Band 48

Lowest Channel / 5MHz / 64QAM

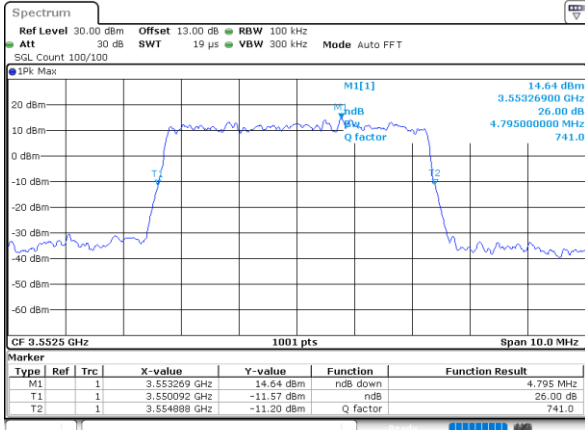

Date: 15\_JUL\_2020 01:11:15

Lowest Channel / 10MHz / 64QAM

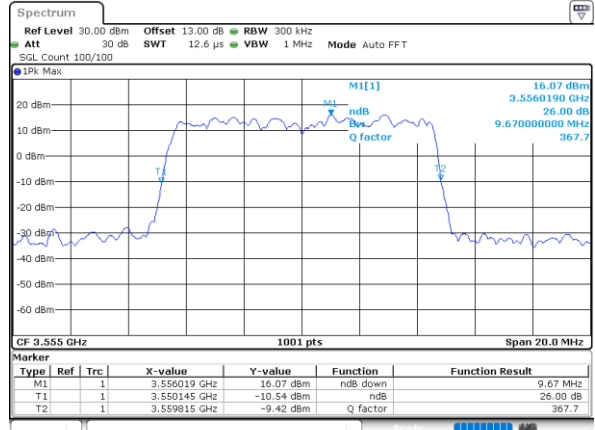

Date: 15\_JUL\_2020 01:12:24

Middle Channel / 5MHz / 64QAM

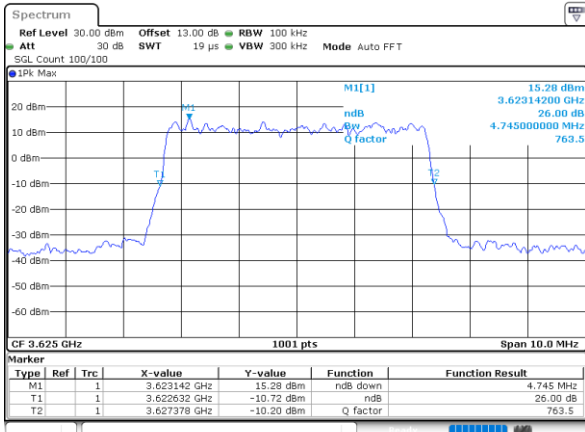

Date: 15\_JUL\_2020 01:11:37

Middle Channel / 10MHz / 64QAM

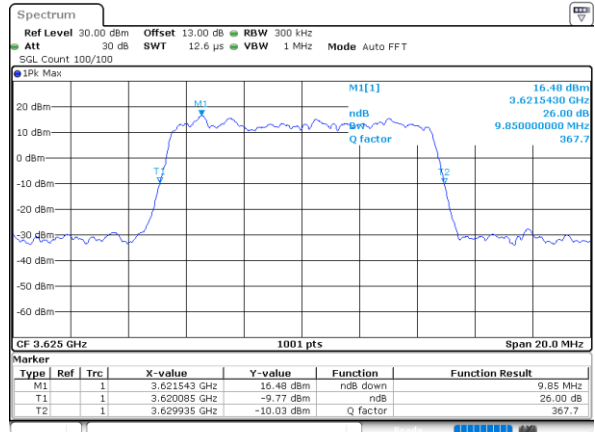

Date: 15\_JUL\_2020 01:12:47

Highest Channel / 5MHz / 64QAM

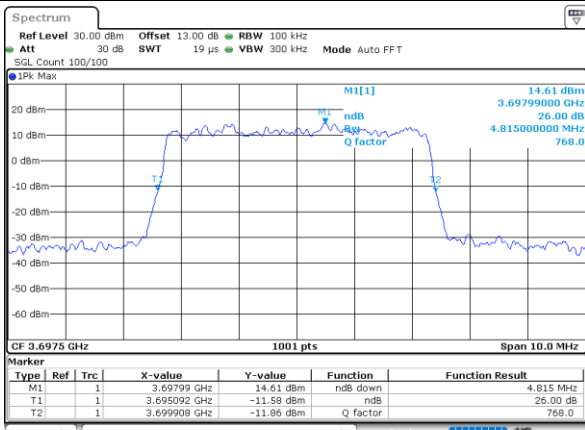

Date: 15\_JUL\_2020 01:12:00

Highest Channel / 10MHz / 64QAM

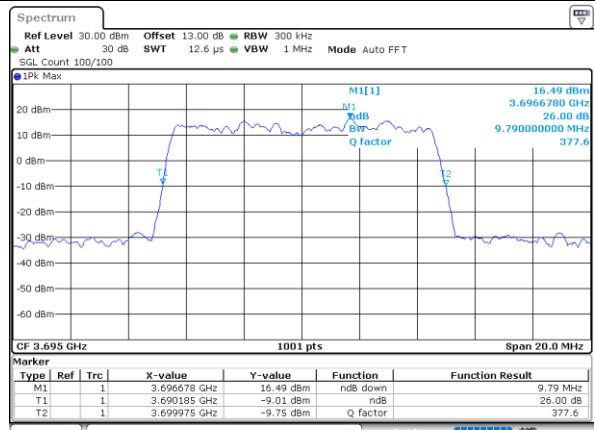

Date: 15\_JUL\_2020 01:13:11



LTE Band 48

Lowest Channel / 15MHz / 64QAM

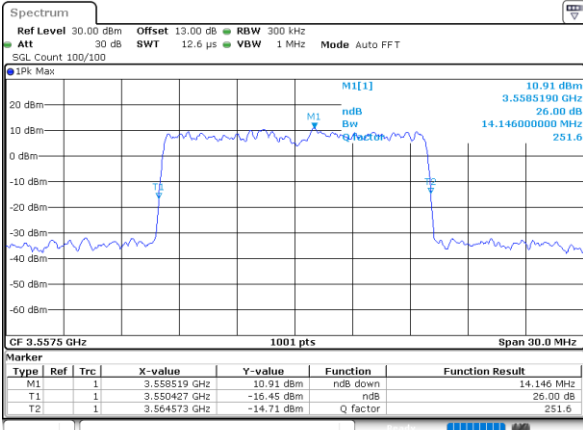

Date: 15\_JUL\_2020 01:13:35

Lowest Channel / 20MHz / 64QAM

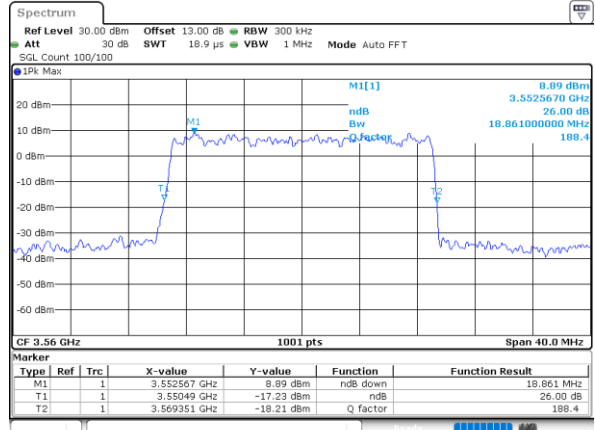

Date: 15\_JUL\_2020 01:14:44

Middle Channel / 15MHz / 64QAM

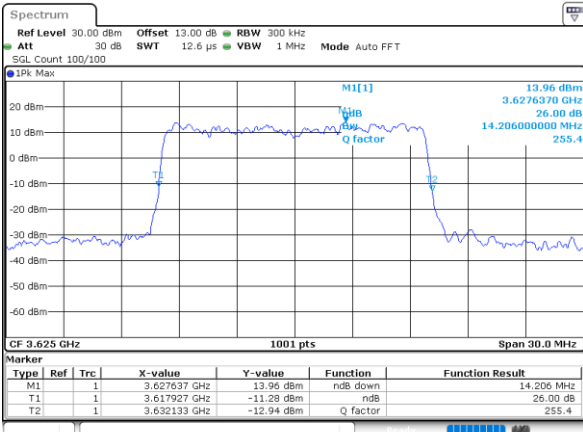

Date: 15\_JUL\_2020 01:13:57

Middle Channel / 20MHz / 64QAM

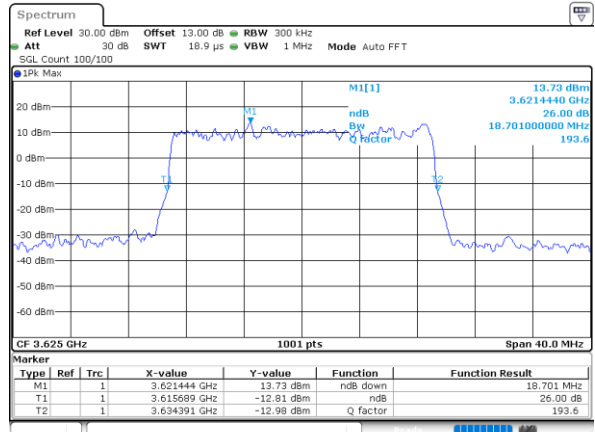

Date: 15\_JUL\_2020 01:15:07

Highest Channel / 15MHz / 64QAM

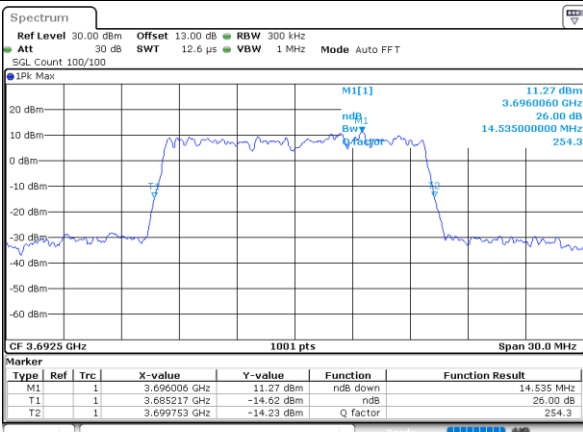

Date: 15\_JUL\_2020 01:14:20

Highest Channel / 20MHz / 64QAM

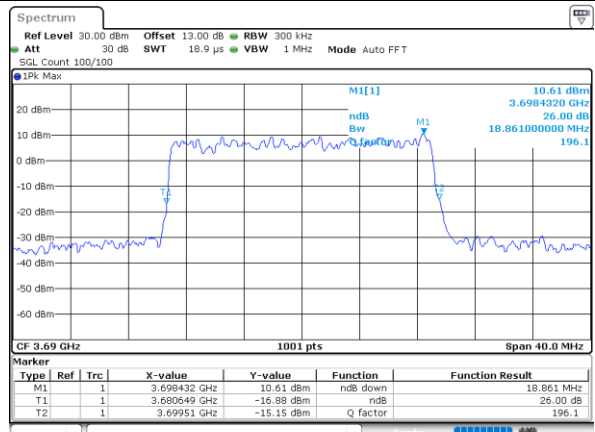

Date: 15\_JUL\_2020 01:15:30



**Occupied Bandwidth**

Mode	LTE Band 48 : 99%OBW(MHz)											
BW	1.4MHz		3MHz		5MHz		10MHz		15MHz		20MHz	
Mod.	QPSK	16QAM	QPSK	16QAM	QPSK	16QAM	QPSK	16QAM	QPSK	16QAM	QPSK	16QAM
Lowest CH	-	-	-	-	4.47	4.48	9.01	9.07	13.49	13.46	17.86	17.78
Middle CH	-	-	-	-	4.46	4.51	9.03	9.07	13.55	13.43	17.90	17.86
Highest CH	-	-	-	-	4.51	4.51	9.03	9.07	13.46	13.40	17.86	17.82
Mode	LTE Band 48 : 99%OBW(MHz)											
BW	1.4MHz		3MHz		5MHz		10MHz		15MHz		20MHz	
Mod.	64QAM		64QAM		64QAM		64QAM		64QAM		64QAM	
Lowest CH	-	-	-	-	4.48	-	9.01	-	13.46	-	17.90	-
Middle CH	-	-	-	-	4.51	-	9.03	-	13.43	-	17.90	-
Highest CH	-	-	-	-	4.49	-	9.03	-	13.43	-	17.94	-



LTE Band 48

Lowest Channel / 5MHz / QPSK

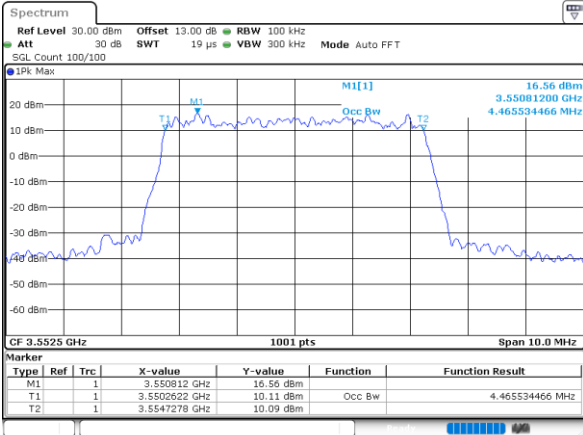

Date: 15\_JUL\_2020 01:01:43

Lowest Channel / 5MHz / 16QAM

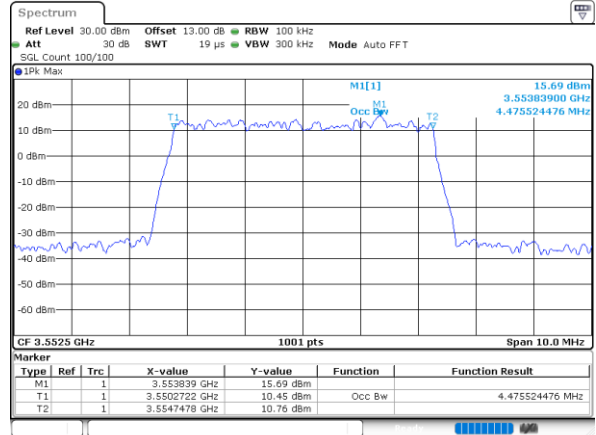

Date: 15\_JUL\_2020 01:01:55

Middle Channel / 5MHz / QPSK

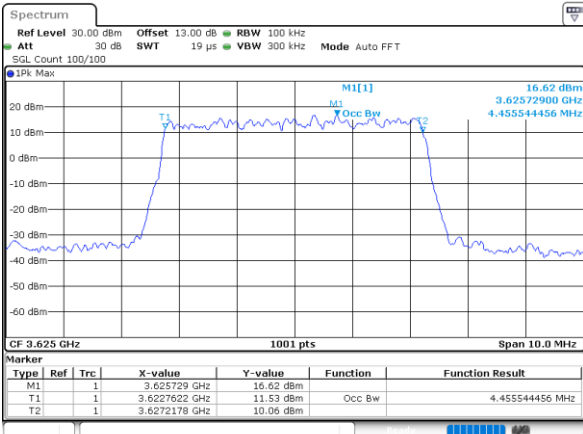

Date: 15\_JUL\_2020 01:02:30

Middle Channel / 5MHz / 16QAM

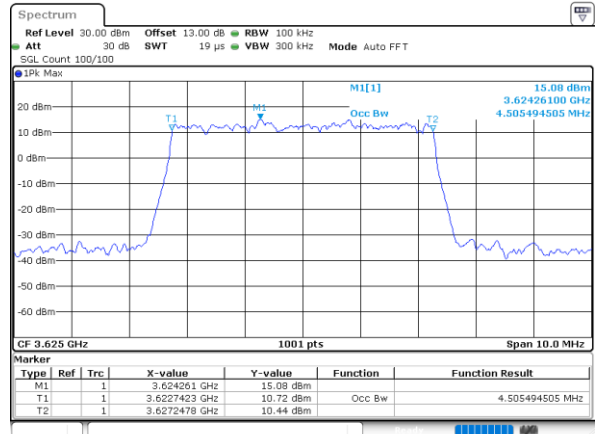

Date: 15\_JUL\_2020 01:02:41

Highest Channel / 5MHz / QPSK

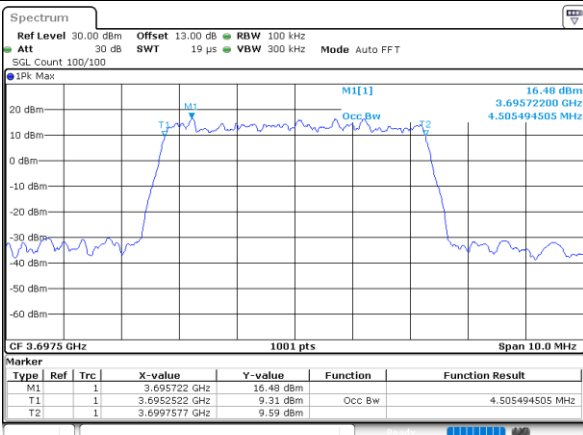

Date: 15\_JUL\_2020 01:03:15

Highest Channel / 5MHz / 16QAM

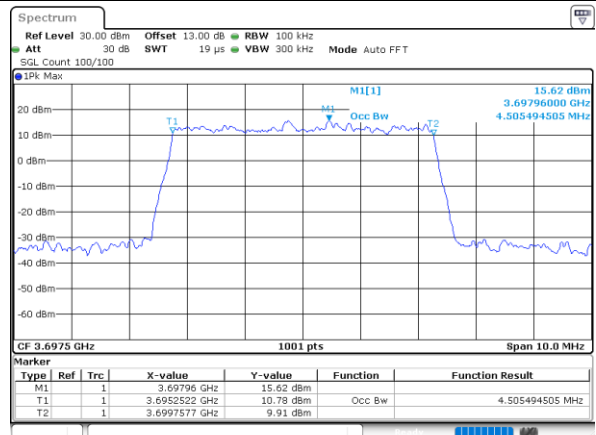

Date: 15\_JUL\_2020 01:03:27



LTE Band 48

Lowest Channel / 10MHz / QPSK

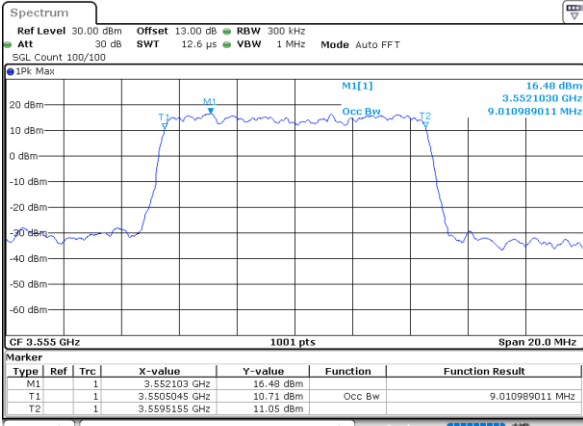

Date: 15\_JUL\_2020 01:04:03

Lowest Channel / 10MHz / 16QAM

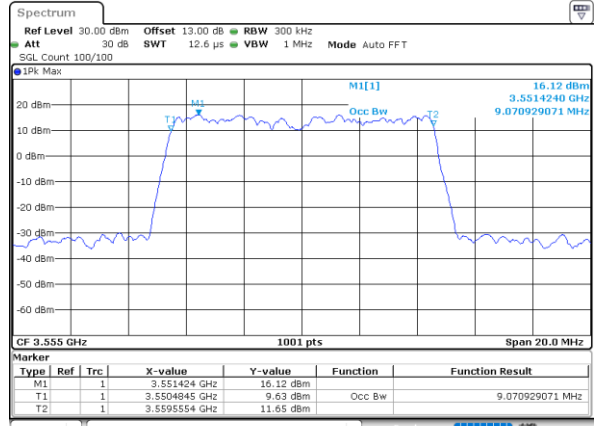

Date: 15\_JUL\_2020 01:04:15

Middle Channel / 10MHz / QPSK

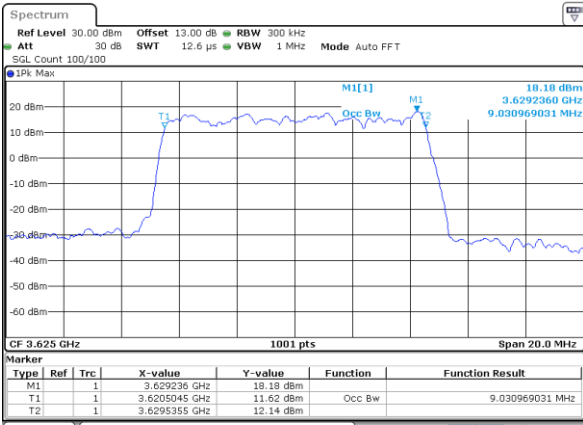

Date: 15\_JUL\_2020 01:04:50

Middle Channel / 10MHz / 16QAM

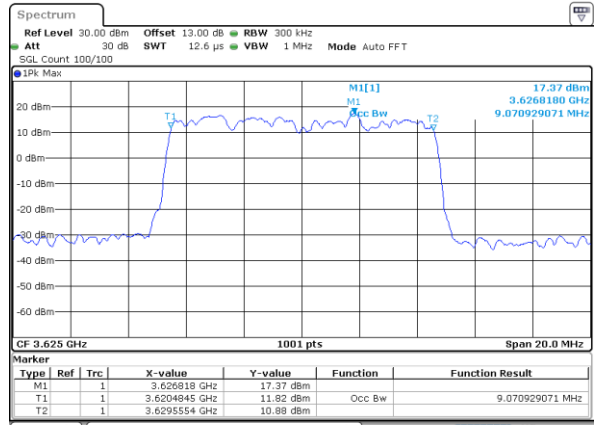

Date: 15\_JUL\_2020 01:05:01

Highest Channel / 10MHz / QPSK

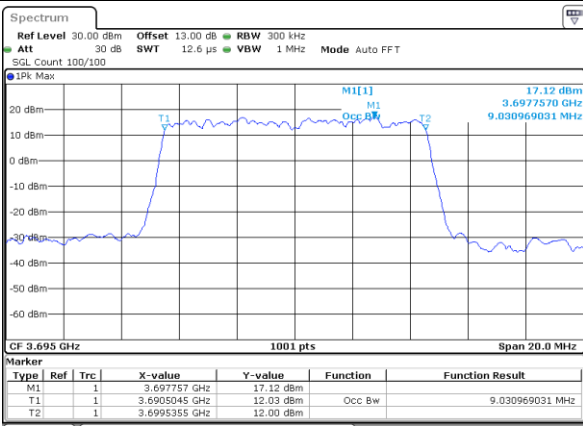

Date: 15\_JUL\_2020 01:05:35

Highest Channel / 10MHz / 16QAM

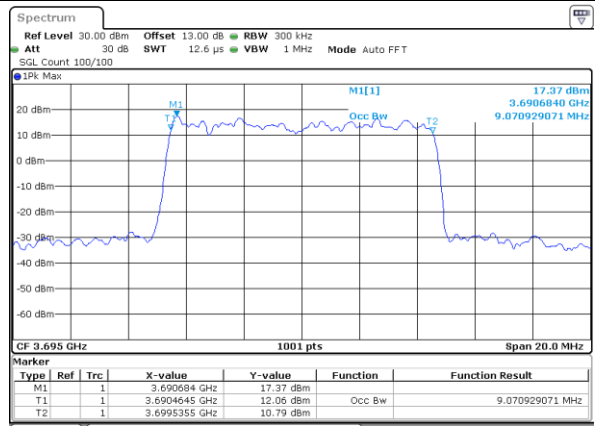

Date: 15\_JUL\_2020 01:05:47





LTE Band 48

Lowest Channel / 15MHz / QPSK

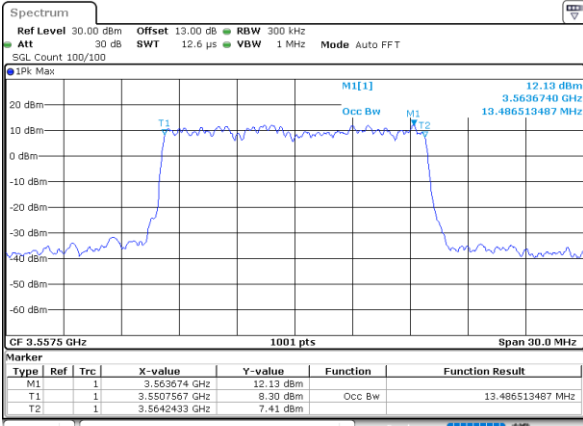

Lowest Channel / 15MHz / 16QAM

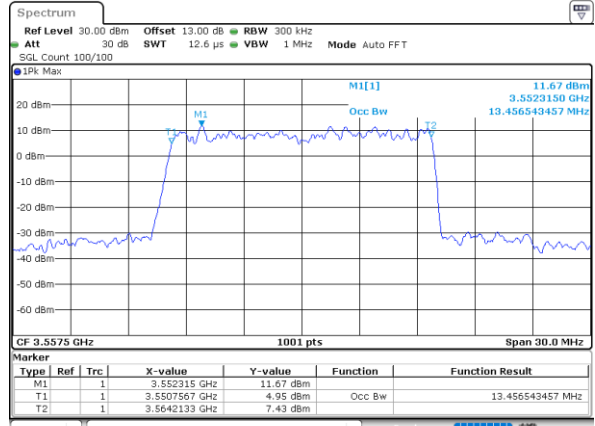

Middle Channel / 15MHz / QPSK

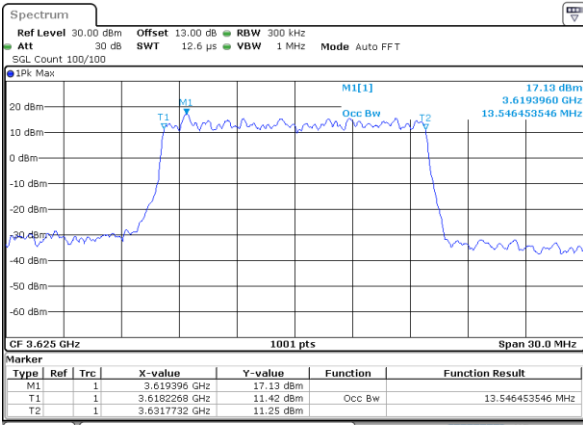

Middle Channel / 15MHz / 16QAM

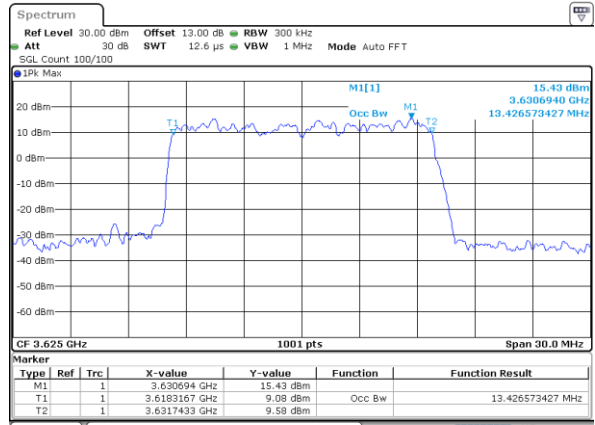

Highest Channel / 15MHz / QPSK

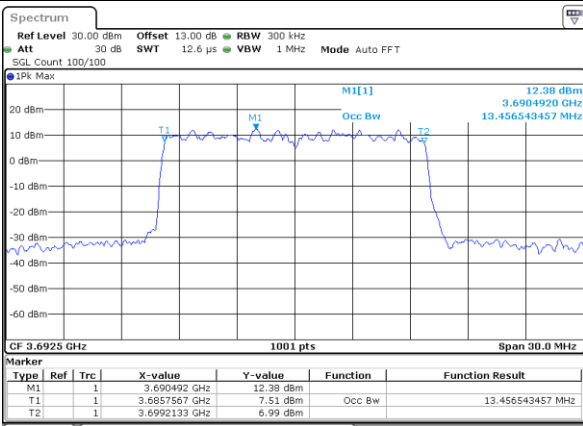

Highest Channel / 15MHz / 16QAM

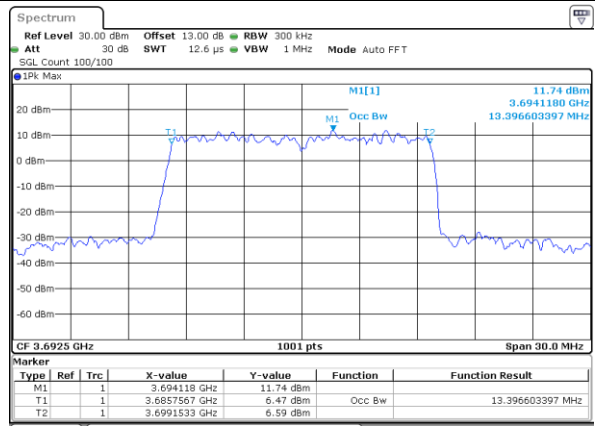



LTE Band 48

Lowest Channel / 20MHz / QPSK

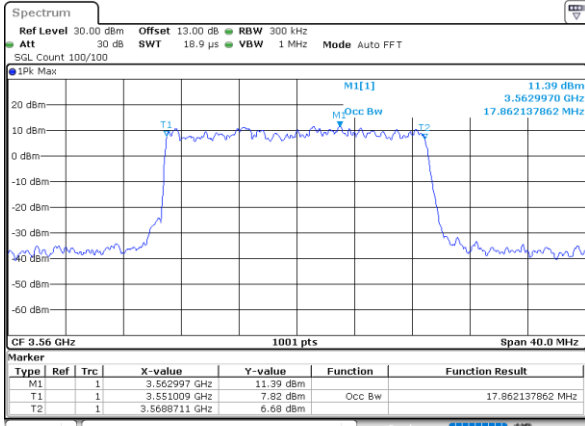

Date: 15\_JUL\_2020 01:08:43

Lowest Channel / 20MHz / 16QAM

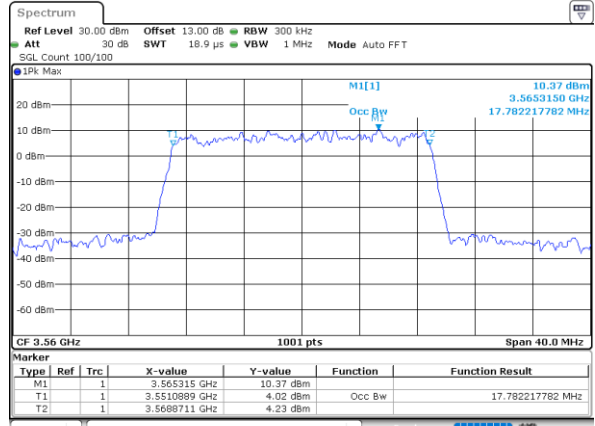

Date: 15\_JUL\_2020 01:08:55

Middle Channel / 20MHz / QPSK

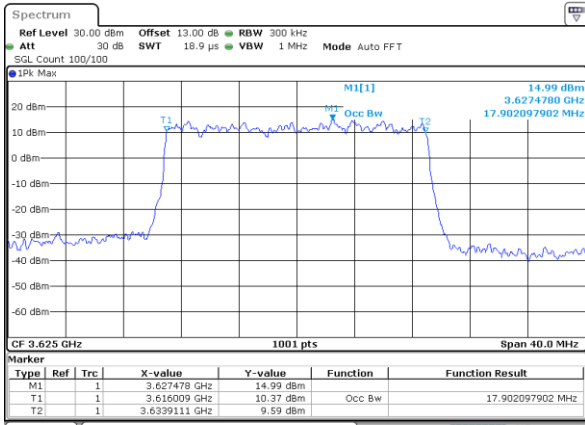

Date: 15\_JUL\_2020 01:09:30

Middle Channel / 20MHz / 16QAM

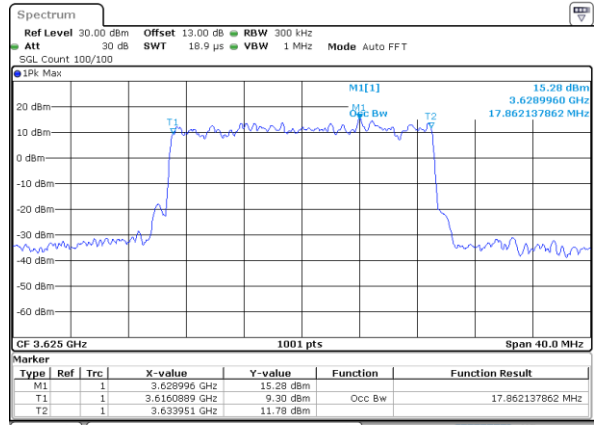

Date: 15\_JUL\_2020 01:09:41

Highest Channel / 20MHz / QPSK

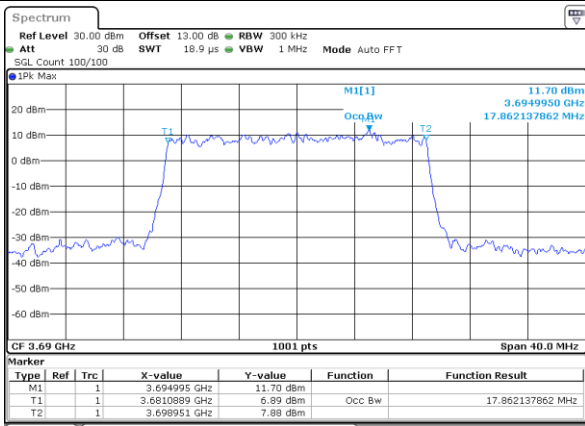

Date: 15\_JUL\_2020 01:10:15

Highest Channel / 20MHz / 16QAM

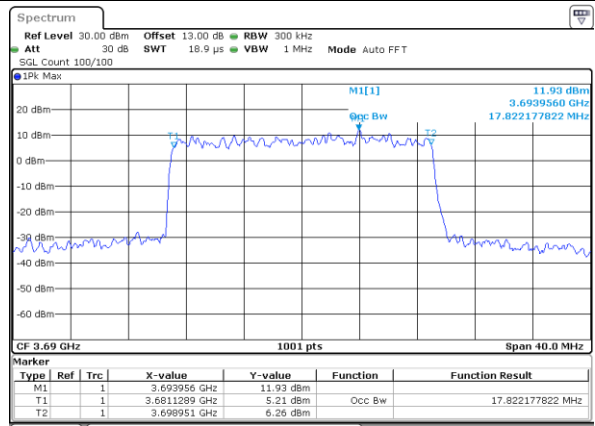

Date: 15\_JUL\_2020 01:10:27



LTE Band 48

Lowest Channel / 5MHz / 64QAM

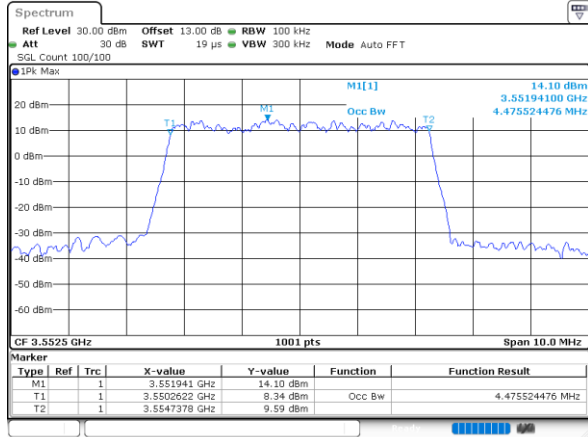

Lowest Channel / 10MHz / 64QAM

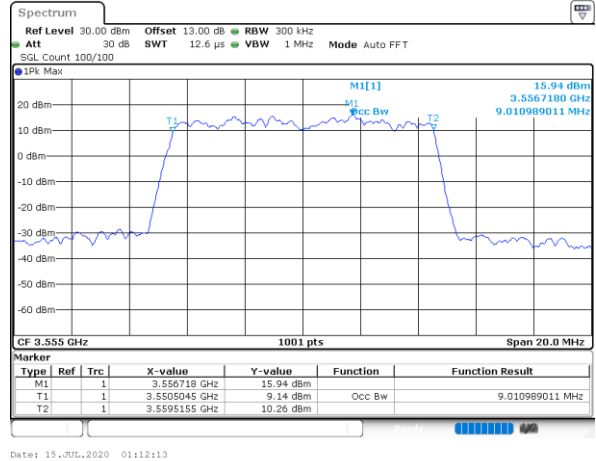

Middle Channel / 5MHz / 64QAM

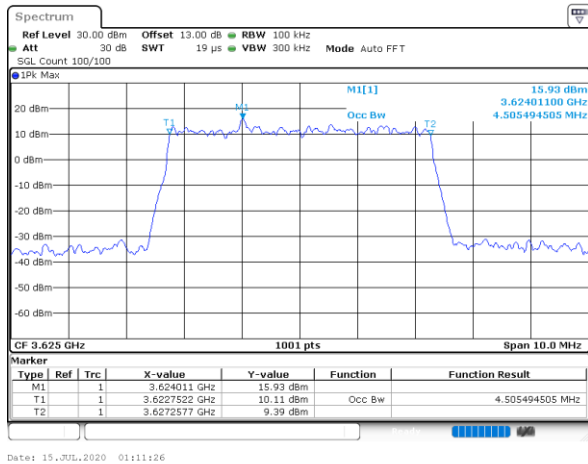

Middle Channel / 10MHz / 64QAM

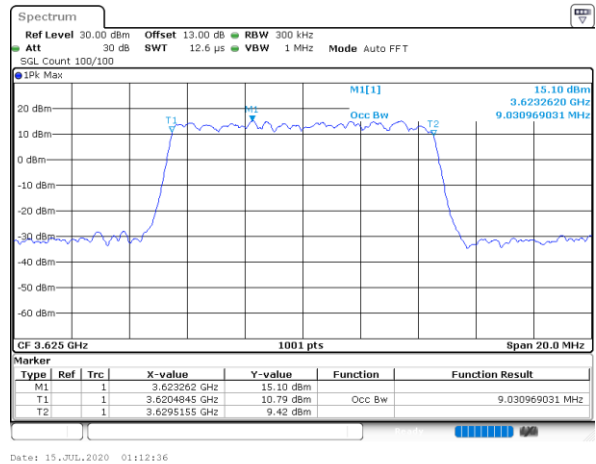

Highest Channel / 5MHz / 64QAM

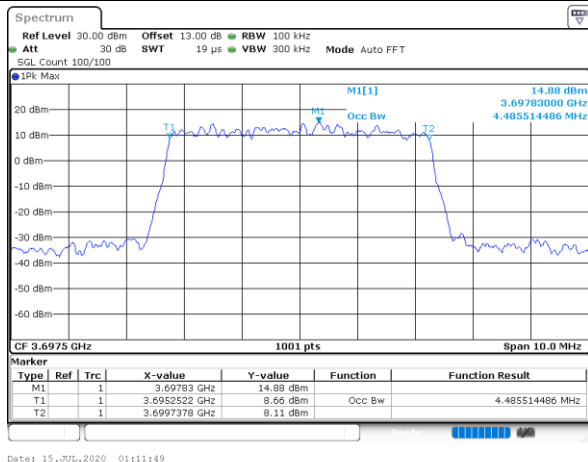

Highest Channel / 10MHz / 64QAM

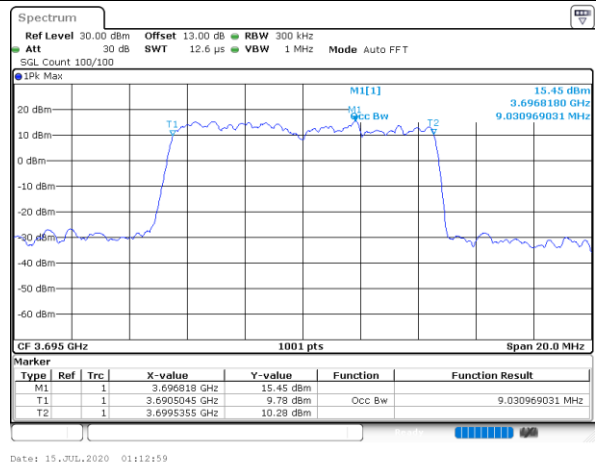



LTE Band 48

Lowest Channel / 15MHz / 64QAM

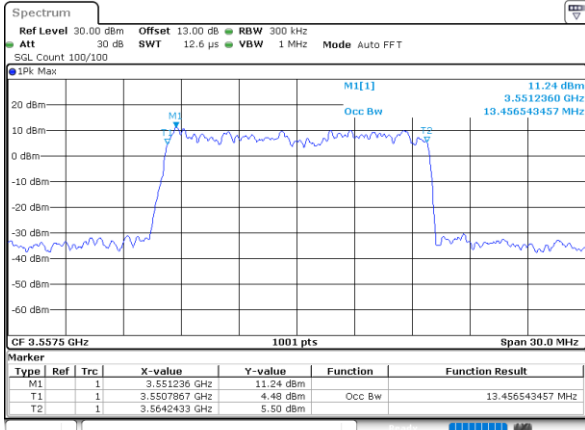

Date: 15\_JUL\_2020 01:13:23

Lowest Channel / 20MHz / 64QAM

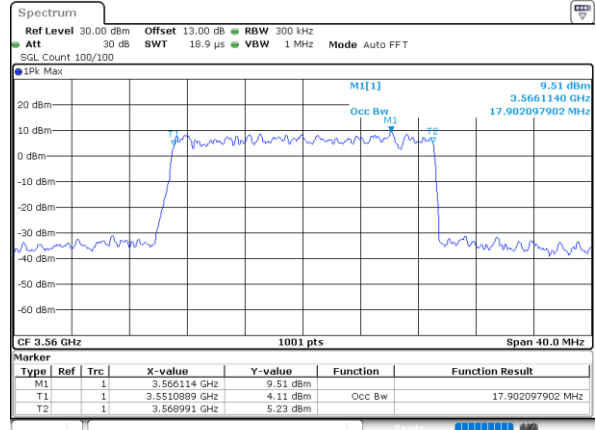

Date: 15\_JUL\_2020 01:14:33

Middle Channel / 15MHz / 64QAM

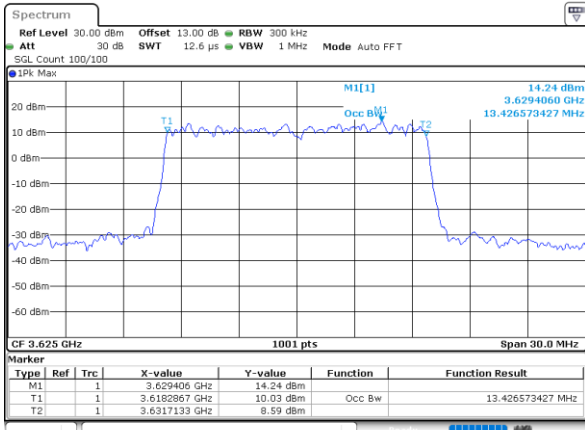

Date: 15\_JUL\_2020 01:13:46

Middle Channel / 20MHz / 64QAM

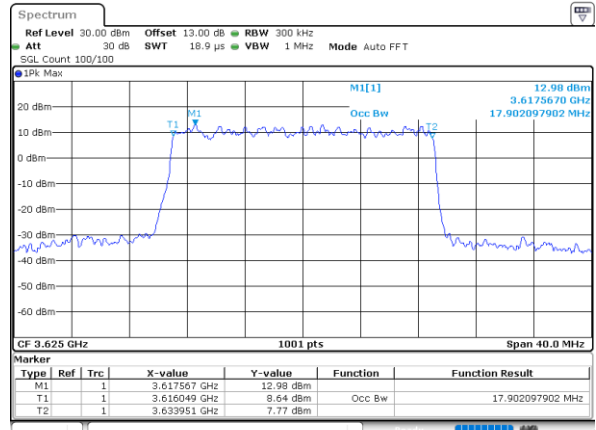

Date: 15\_JUL\_2020 01:14:56

Highest Channel / 15MHz / 64QAM

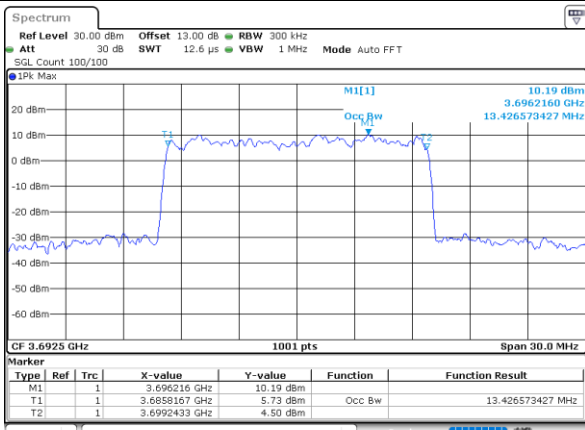

Date: 15\_JUL\_2020 01:14:09

Highest Channel / 20MHz / 64QAM

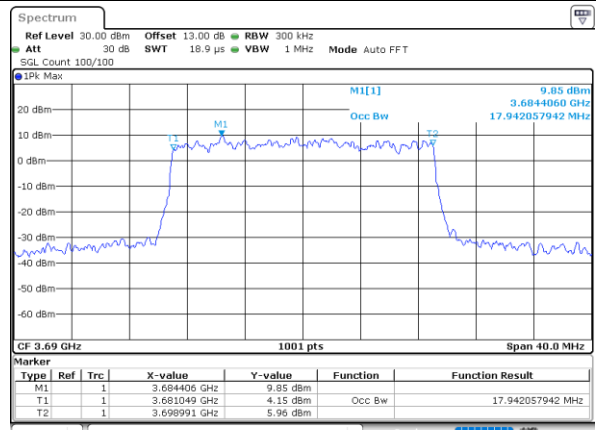

Date: 15\_JUL\_2020 01:15:19



**ACLR**

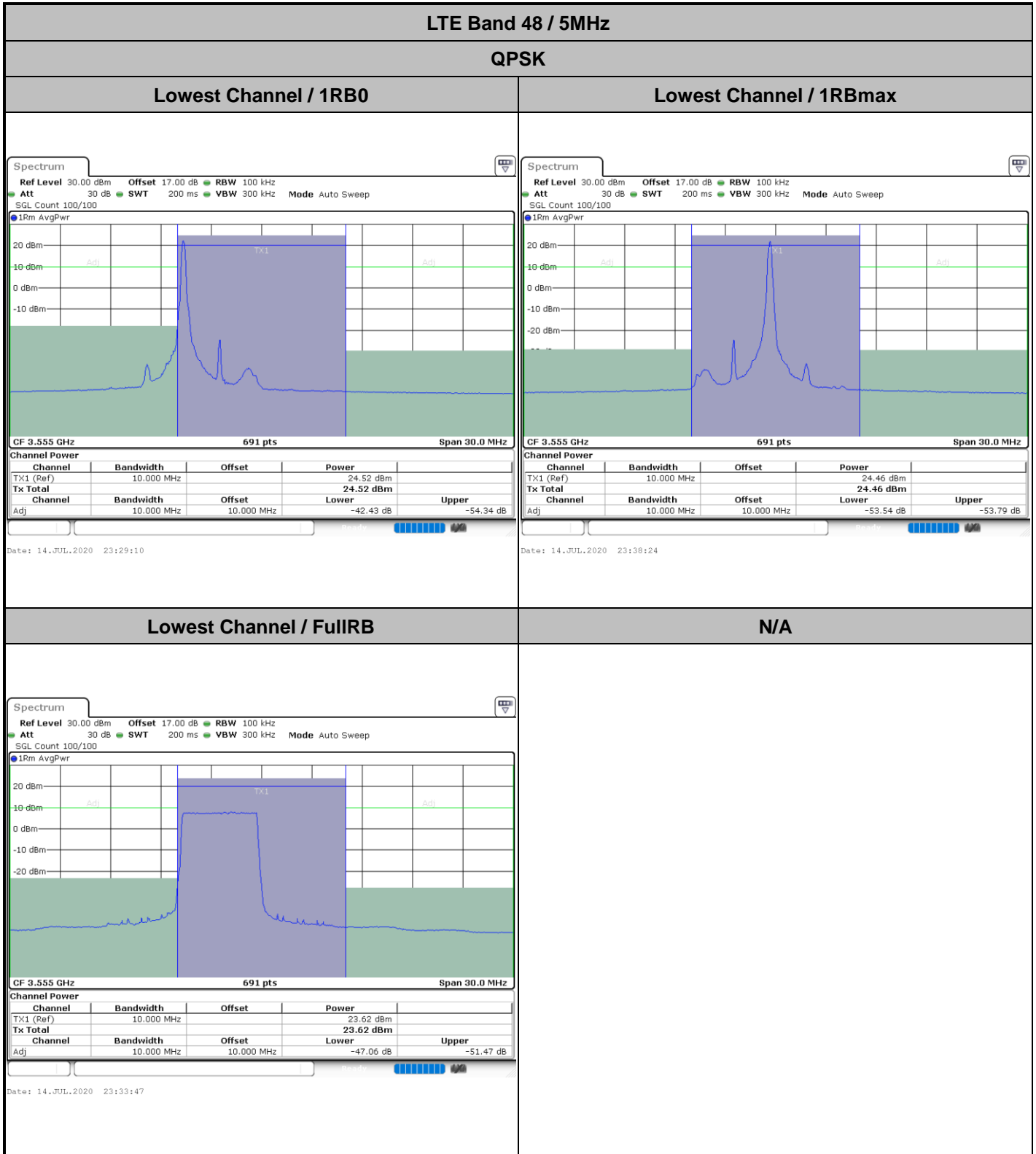



LTE Band 48 / 5MHz

QPSK

Middle Channel / 1RB0

Middle Channel / 1RBmax

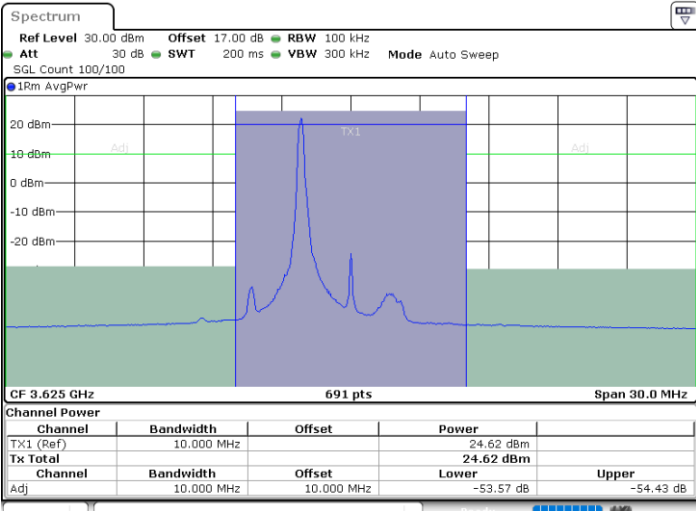

Date: 14.JUL.2020 23:31:43

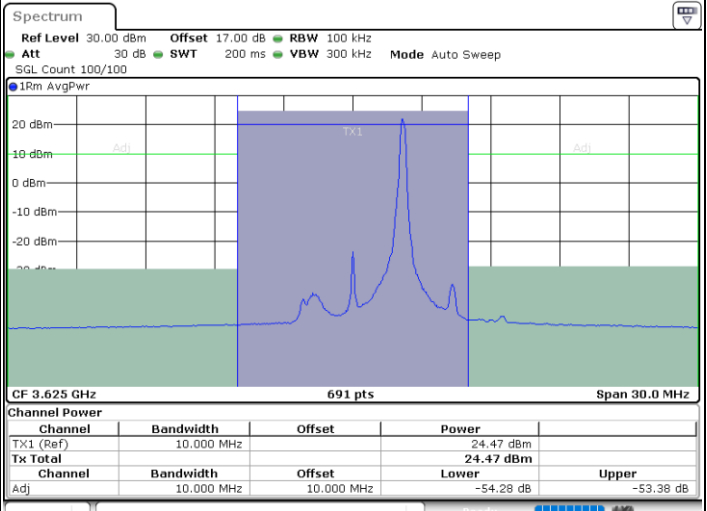

Date: 14.JUL.2020 23:40:56

Middle Channel / FullIRB

N/A

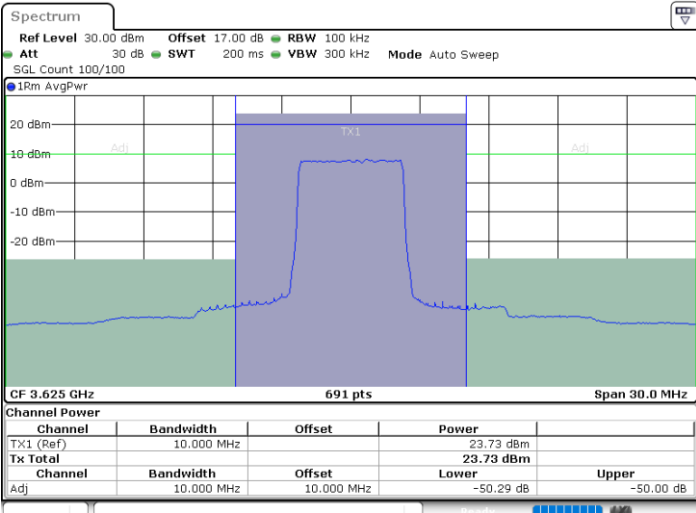

Date: 14.JUL.2020 23:36:19



LTE Band 48 / 5MHz

QPSK

Highest Channel / 1RB0

Highest Channel / 1RBmax

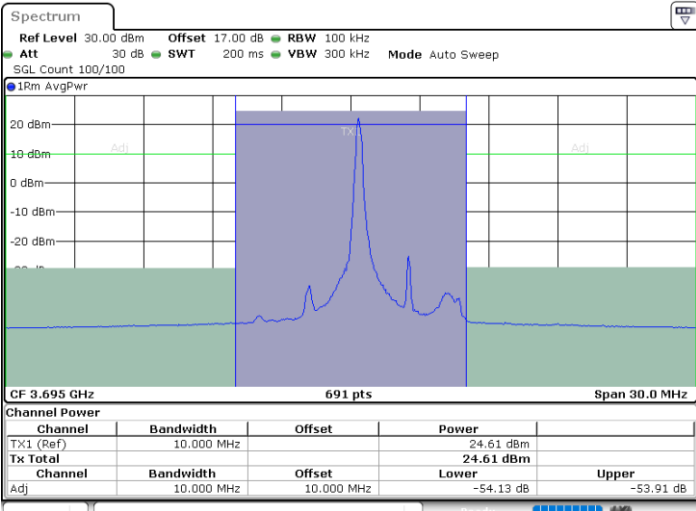

Date: 14.JUL.2020 23:32:13

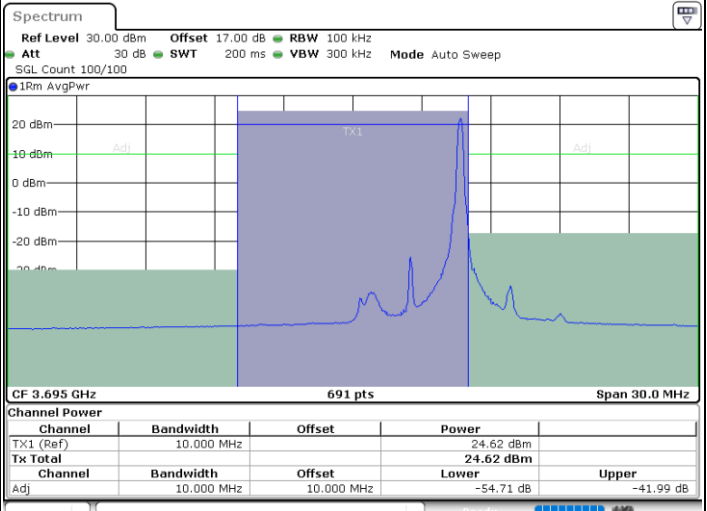

Date: 14.JUL.2020 23:41:27

Highest Channel / FullIRB

N/A

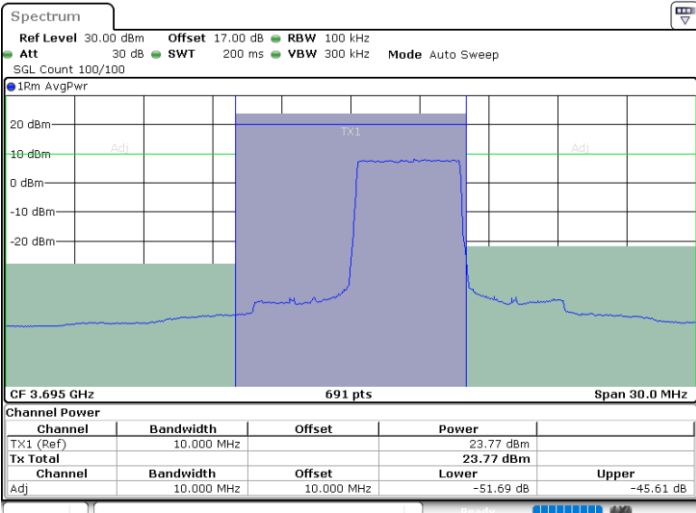

Date: 14.JUL.2020 23:36:50



LTE Band 48 / 10MHz

QPSK

Lowest Channel / 1RB0

Lowest Channel / 1RBmax

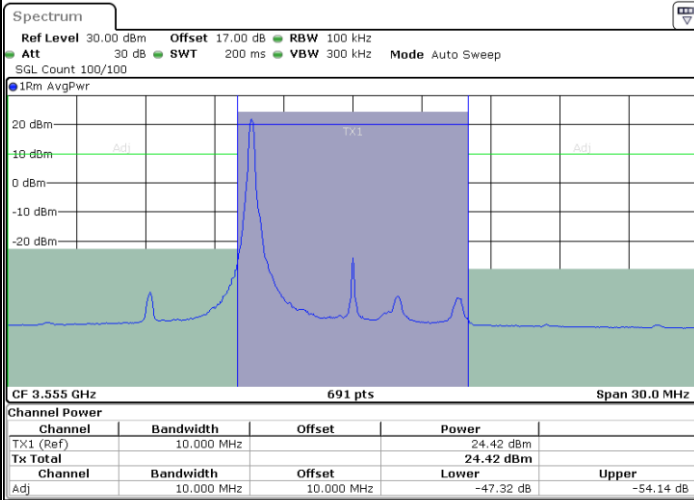

Date: 14.JUL.2020 23:44:02

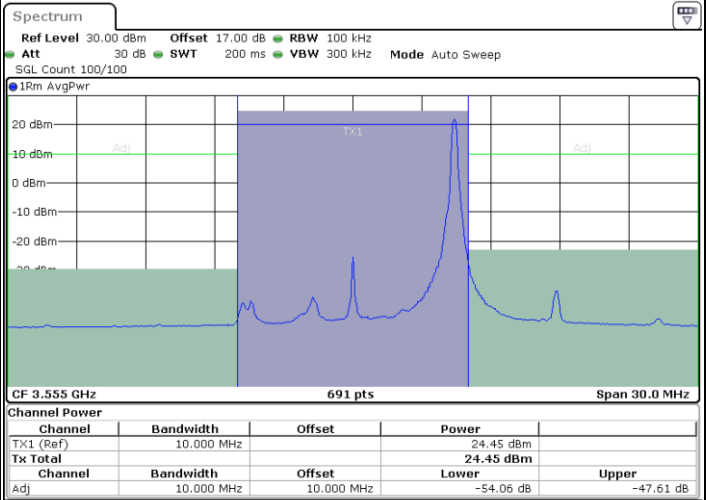

Date: 15.JUL.2020 00:14:23

Lowest Channel / FullIRB

N/A

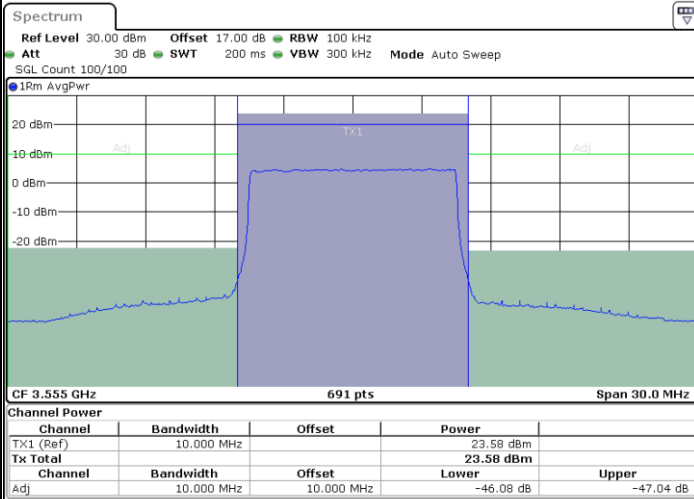

Date: 15.JUL.2020 00:09:45





LTE Band 48 / 10MHz

QPSK

MiddleChannel / 1RB0

Middle Channel / 1RBmax

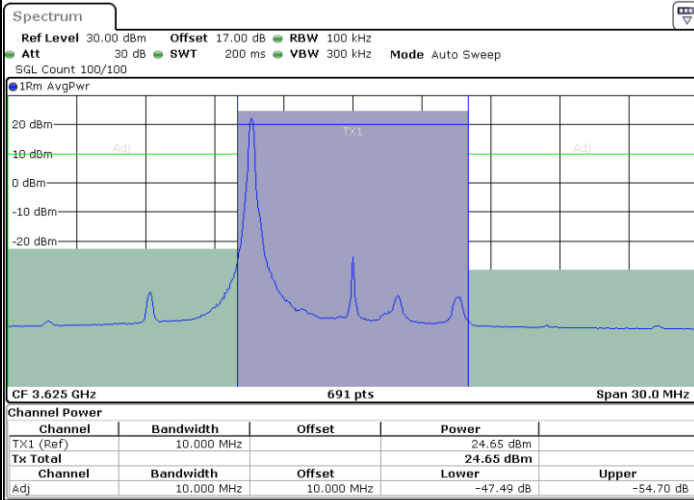

Date: 14.JUL.2020 23:44:33

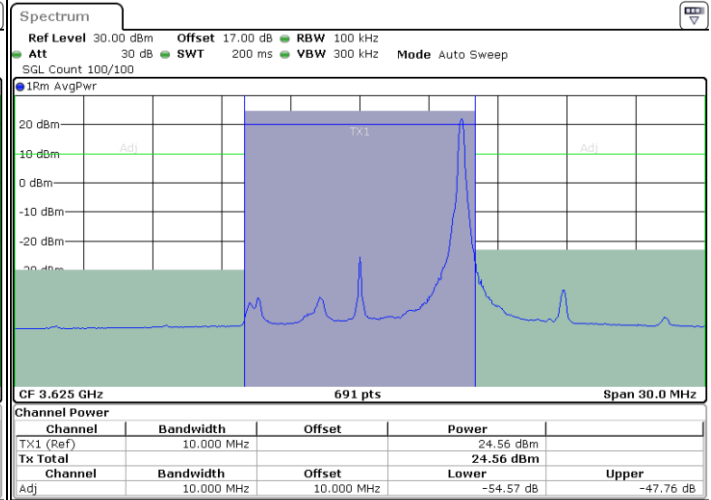

Date: 15.JUL.2020 00:14:53

Middle Channel / FullIRB

N/A

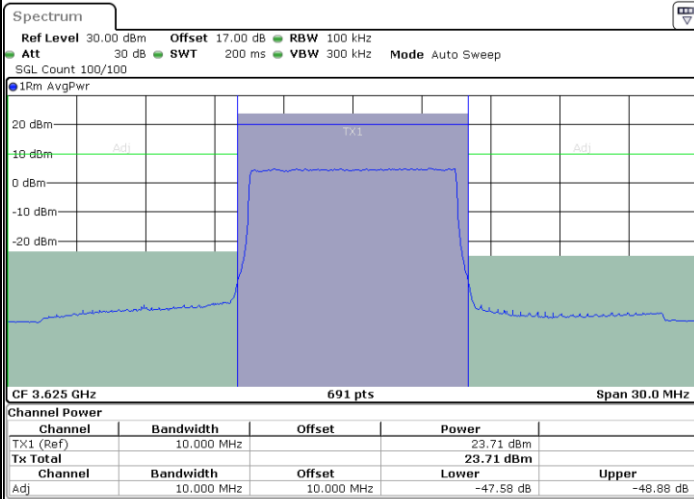

Date: 15.JUL.2020 00:10:16



LTE Band 48 / 10MHz

QPSK

Highest Channel / 1RB0

Highest Channel / 1RBmax

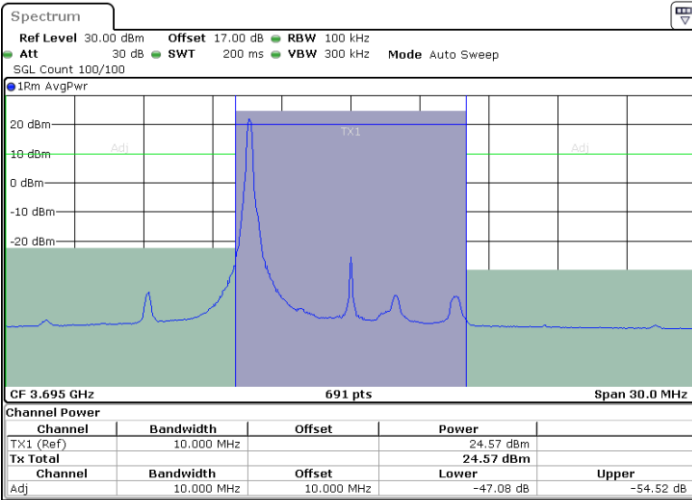

Date: 15.JUL.2020 00:08:13

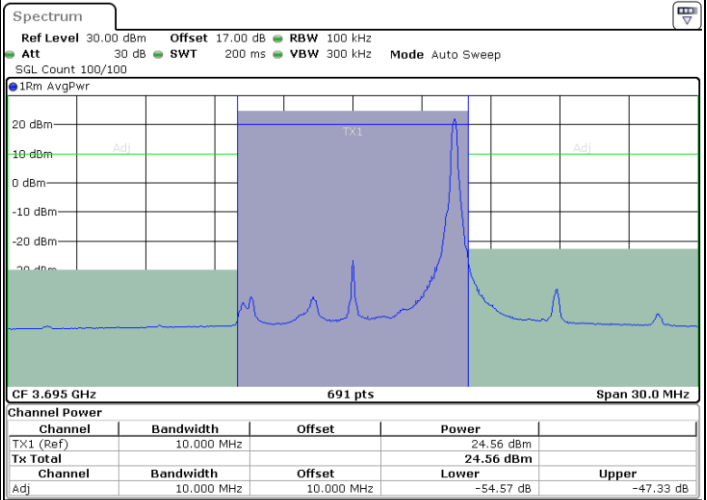

Date: 15.JUL.2020 00:17:28

Highest Channel / FullIRB

N/A

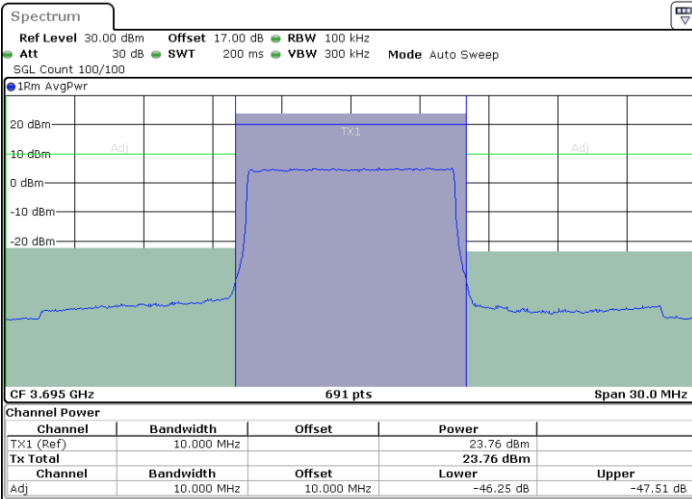

Date: 15.JUL.2020 00:12:51



LTE Band 48 / 15MHz

QPSK

Lowest Channel / 1RB0

Lowest Channel / 1RBmax

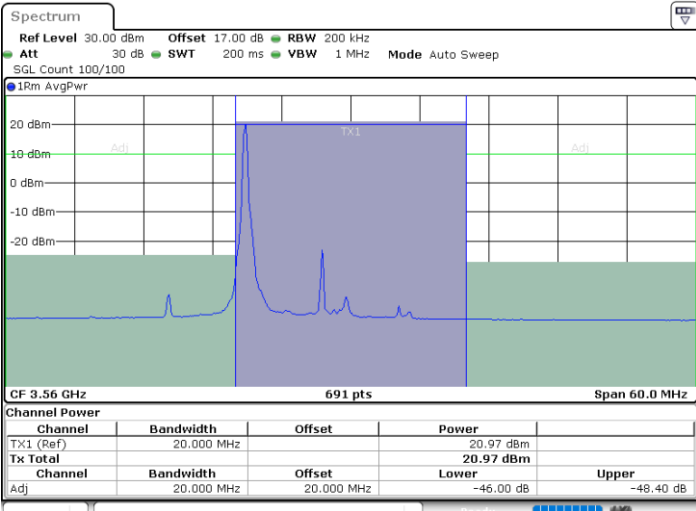

Date: 15.JUL.2020 00:17:58

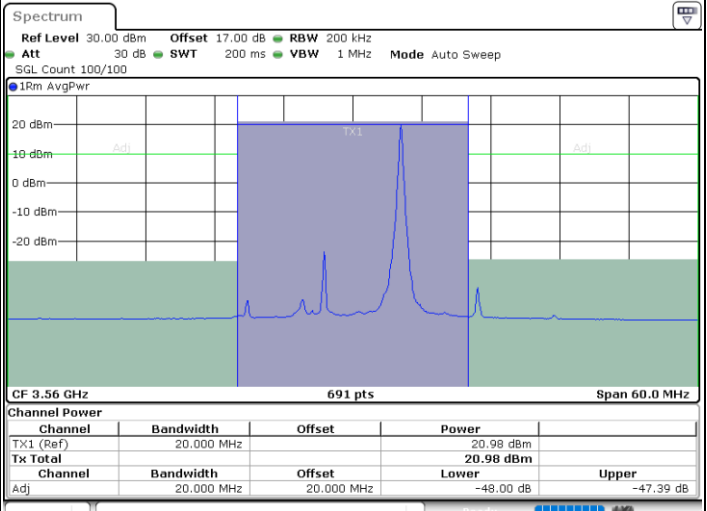

Date: 15.JUL.2020 00:26:52

Lowest Channel / FullIRB

N/A

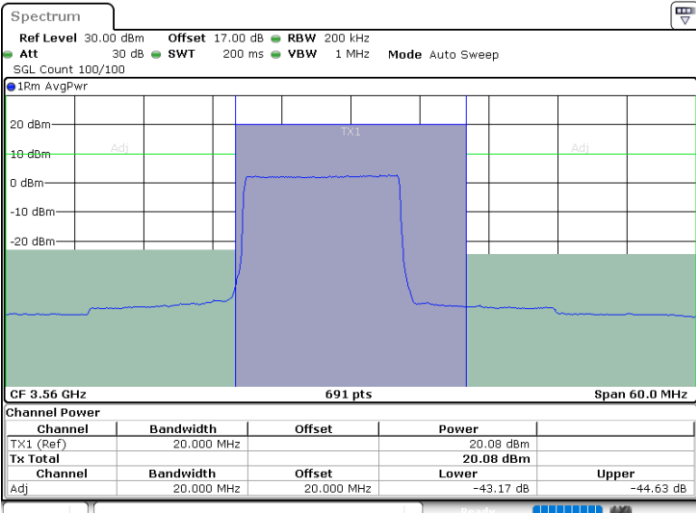

Date: 15.JUL.2020 00:22:25



LTE Band 48 / 15MHz

QPSK

Middle Channel / 1RB0

Middle Channel / 1RBmax

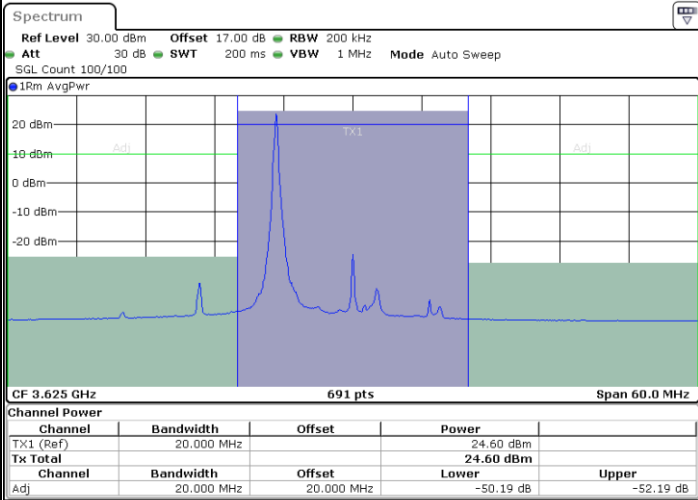

Date: 15.JUL.2020 00:20:26

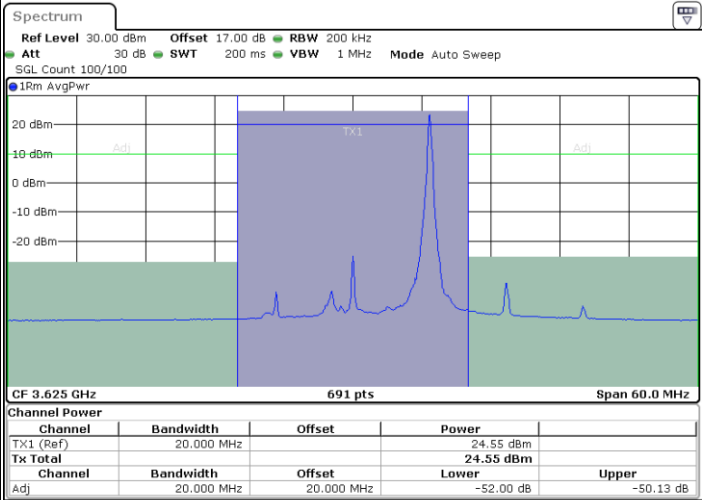

Date: 15.JUL.2020 00:29:20

Middle Channel / FullIRB

N/A

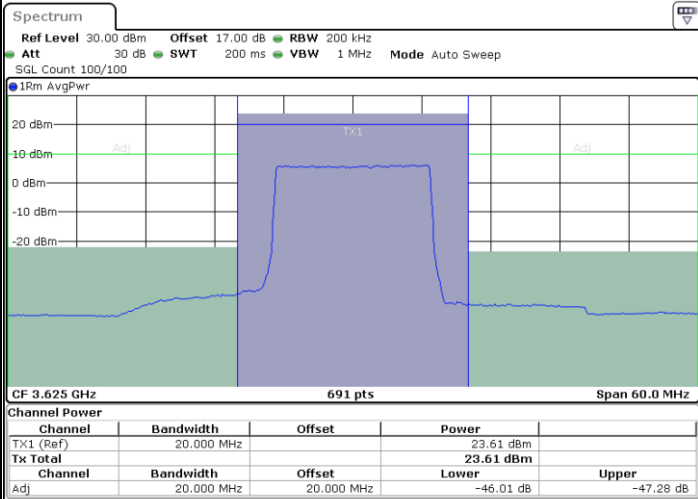

Date: 15.JUL.2020 00:24:53