



FCC RADIO TEST REPORT

FCC ID : A4RG6QU3
Equipment : Phone
Model Name : G6QU3
Applicant : Google LLC
1600 Amphitheatre Parkway,
Mountain View, California, 94043 USA
Standard : FCC Part 15 Subpart C §15.247

The product was received on Jun. 05, 2020 and testing was started from Jun. 19, 2020 and completed on Jul. 30, 2020. We, SPORTON INTERNATIONAL INC., EMC & Wireless Communications Laboratory, would like to declare that the tested sample has been evaluated in accordance with the test procedures and has been in compliance with the applicable technical standards.

The test results in this report apply exclusively to the tested model / sample. Without written approval of SPORTON INTERNATIONAL INC. EMC & Wireless Communications Laboratory, the test report shall not be reproduced except in full.

Approved by: Louis Wu

SPORTON INTERNATIONAL INC. EMC & Wireless Communications Laboratory

No. 52, Huaya 1st Rd., Guishan Dist., Taoyuan City, Taiwan (R.O.C.)



Table of Contents

History of this test report.....	3
Summary of Test Result.....	4
1 General Description	5
1.1 Product Feature of Equipment Under Test.....	5
1.2 Product Specification of Equipment Under Test.....	6
1.3 Modification of EUT	6
1.4 Testing Location	7
1.5 Applicable Standards.....	7
2 Test Configuration of Equipment Under Test	8
2.1 Carrier Frequency and Channel	8
2.2 Test Mode.....	9
2.3 Connection Diagram of Test System.....	10
2.4 Support Unit used in test configuration and system	11
2.5 EUT Operation Test Setup	11
2.6 Measurement Results Explanation Example.....	11
3 Test Result	12
3.1 6dB and 99% Bandwidth Measurement	12
3.2 Output Power Measurement.....	14
3.3 Power Spectral Density Measurement	15
3.4 Conducted Band Edges and Spurious Emission Measurement	17
3.5 Radiated Band Edges and Spurious Emission Measurement	36
3.6 AC Conducted Emission Measurement.....	41
3.7 Antenna Requirements	43
4 List of Measuring Equipment.....	44
5 Uncertainty of Evaluation	46
Appendix A. Conducted Test Results	
Appendix B. AC Conducted Emission Test Result	
Appendix C. Radiated Spurious Emission	
Appendix D. Radiated Spurious Emission Plots	
Appendix E. Duty Cycle Plots	



History of this test report

Report No.	Version	Description	Issued Date
FR050515C	01	Initial issue of report	Aug. 06, 2020



Summary of Test Result

Report Clause	Ref Std. Clause	Test Items	Result (PASS/FAIL)	Remark
3.1	15.247(a)(2)	6dB Bandwidth	Pass	-
3.1	2.1049	99% Occupied Bandwidth	Reporting only	-
3.2	15.247(b)	Power Output Measurement	Pass	-
3.3	15.247(e)	Power Spectral Density	Pass	-
3.4	15.247(d)	Conducted Band Edges	Pass	-
		Conducted Spurious Emission	Pass	-
3.5	15.247(d)	Radiated Band Edges and Radiated Spurious Emission	Pass	Under limit 1.54 dB at 2390.000 MHz
3.6	15.207	AC Conducted Emission	Pass	Under limit 10.72 dB at 0.209 MHz
3.7	15.203 & 15.247(b)	Antenna Requirement	Pass	-

Declaration of Conformity:

The test results with all measurement uncertainty excluded are presented in accordance with the regulation limits or requirements declared by manufacturers.

Comments and Explanations:

The declared of product specification for EUT presented in the report are provided by the manufacturer, and the manufacturer takes all the responsibilities for the accuracy of product specification.

Reviewed by: Wii Chang**Report Producer: Amy Chen**



1 General Description

1.1 Product Feature of Equipment Under Test

Product Feature	
Equipment	Phone
Model Name	G6QU3
FCC ID	A4RG6QU3
EUT supports Radios application	CDMA/EV-DO/GSM/EGPRS/WCDM/HSPA/LTE/5G NR /NFC/GNSS WLAN 11b/g/n HT20 WLAN 11a/n HT20/HT40 WLAN 11ac VHT20/VHT40/VHT80 Bluetooth BR/EDR/LE

Remark: The above EUT's information was declared by manufacturer.

EUT Information List	
S/N	Performed Test Item
05211FQCB00019	RF Conducted Measurement
05281FQCB00016	Radiated Spurious Emission
05281FQCB00035	Conducted Emission

1.2 Product Specification of Equipment Under Test

Standards-related Product Specification										
Tx/Rx Channel Frequency Range	2412 MHz ~ 2462 MHz									
Maximum (Average) Output Power to antenna	<p><Ant. 4> 802.11b : 19.10 dBm (0.0813 W) 802.11g : 19.00 dBm (0.0794 W) 802.11n HT20 : 18.90 dBm (0.0776 W) 802.11ac VHT20 : 18.80 dBm (0.0759 W)</p> <p><Ant. 3> 802.11b : 19.20 dBm (0.0832 W) 802.11g : 18.60 dBm (0.0724 W) 802.11n HT20 : 18.50 dBm (0.0708 W) 802.11ac VHT20 : 18.40 dBm (0.0692 W)</p> <p>MIMO <Ant. 4+3> 802.11b : 22.46 dBm (0.1762 W) 802.11g : 22.21 dBm (0.1663 W) 802.11n HT20 : 22.11 dBm (0.1626 W) 802.11ac VHT20 : 22.01 dBm (0.1589 W)</p>									
99% Occupied Bandwidth	<p>MIMO <Ant. 4> 802.11b : 14.20MHz 802.11g : 16.80MHz 802.11n HT20 : 18.00MHz</p> <p><MIMO <Ant. 3> 802.11b : 14.00MHz 802.11g : 16.80MHz 802.11n HT20 : 18.00MHz</p>									
Antenna Type / Gain	<p><Ant. 4> Monopole Antenna type with gain 0.30 dBi <Ant. 3> PIFA Antenna type with gain -0.30 dBi</p>									
Type of Modulation	802.11b : DSSS (DBPSK / DQPSK / CCK) 802.11g/n : OFDM (BPSK / QPSK / 16QAM / 64QAM) 802.11ac : OFDM (BPSK / QPSK / 16QAM / 64QAM / 256QAM)									
Antenna Function for Transmitter	<table border="1"> <thead> <tr> <th></th> <th>Ant. 4</th> <th>Ant. 3</th> </tr> </thead> <tbody> <tr> <td>802.11 b/g/n/ac</td> <td>V</td> <td>V</td> </tr> <tr> <td>802.11 b/g/n/ac MIMO</td> <td>V</td> <td>V</td> </tr> </tbody> </table>		Ant. 4	Ant. 3	802.11 b/g/n/ac	V	V	802.11 b/g/n/ac MIMO	V	V
	Ant. 4	Ant. 3								
802.11 b/g/n/ac	V	V								
802.11 b/g/n/ac MIMO	V	V								

Note: MIMO Ant. 4+3 is a calculated result from sum of the power MIMO Ant. 4 and MIMO Ant. 3.

1.3 Modification of EUT

No modifications are made to the EUT during all test items.



1.4 Testing Location

Test Site	SPORTON INTERNATIONAL INC. EMC & Wireless Communications Laboratory	
Test Site Location	No.52, Huaya 1st Rd., Guishan Dist., Taoyuan City, Taiwan (R.O.C.) TEL: +886-3-327-3456 FAX: +886-3-328-4978	
Test Site No.	Sporton Site No.	
	TH05-HY	CO05-HY

Note: The test site complies with ANSI C63.4 2014 requirement.

Test Site	SPORTON INTERNATIONAL INC. EMC & Wireless Communications Laboratory	
Test Site Location	No.58, Aly. 75, Ln. 564, Wenhua 3rd, Rd., Guishan Dist., Taoyuan City, Taiwan (R.O.C.) TEL: +886-3-327-0868 FAX: +886-3-327-0855	
Test Site No.	Sporton Site No.	
	03CH16-HY	

Note: The test site complies with ANSI C63.4 2014 requirement.

FCC designation No.: TW1190 and TW0007

1.5 Applicable Standards

According to the specifications of the manufacturer, the EUT must comply with the requirements of the following standards:

- ♦ FCC Part 15 Subpart C §15.247
- ♦ FCC KDB Publication No. 558074 D01 DTS Meas. Guidance v05r02
- ♦ FCC KDB 414788 D01 Radiated Test Site v01r01.
- ♦ FCC KDB 662911 D01 Multiple Transmitter Output v02r01.
- ♦ ANSI C63.10-2013

Remark:

1. All test items were verified and recorded according to the standards and without any deviation during the test.
2. The TAF code is not including all the FCC KDB listed without accreditation.
3. This EUT has also been tested and complied with the requirements of FCC Part 15, Subpart B, recorded in a separate test report.



2 Test Configuration of Equipment Under Test

- a. The EUT has been associated with peripherals and configuration operated in a manner tended to maximize its emission characteristics in a typical application. Frequency range investigated: conduction emission (150 kHz to 30 MHz), radiation emission (9 kHz to the 10th harmonic of the highest fundamental frequency or to 40 GHz, whichever is lower). For radiated measurement, pre-scanned in three orthogonal panels, X, Y, Z. The worst cases (Z plane) were recorded in this report.

- b. AC power line Conducted Emission was tested under maximum output power.

2.1 Carrier Frequency and Channel

Frequency Band	Channel	Freq. (MHz)	Channel	Freq. (MHz)
2400-2483.5 MHz	1	2412	7	2442
	2	2417	8	2447
	3	2422	9	2452
	4	2427	10	2457
	5	2432	11	2462
	6	2437		



2.2 Test Mode

Final test modes are considering the modulation and worse data rates as below table.

Modulation	Data Rate
802.11b	1 Mbps
802.11g	6 Mbps
802.11n HT20	MCS0
802.11ac VHT20 (Covered by HT20)	MCS0

Test Cases	
AC Conducted Emission	Mode 1 : GSM850 Idle + WLAN (2.4GHz) Link + Bluetooth Link + 3.5 mm Headset + USB Cable 2 (Charging from AC Adapter 2)
Remark: For Radiated Test Cases, the tests were performed with Adapter 1, USB Cable 1.	

Ch. #	2400-2483.5 MHz		
	802.11b	802.11g	802.11n HT20
Low	01	01	01
	-	02	02
Middle	06	06	06
High	-	10	10
	11	11	11

Remark: For radiation spurious emission, the final modulation and the worst data rate was reference the max RF conducted power.

2.3 Connection Diagram of Test System

<AC Conducted Emission Mode>

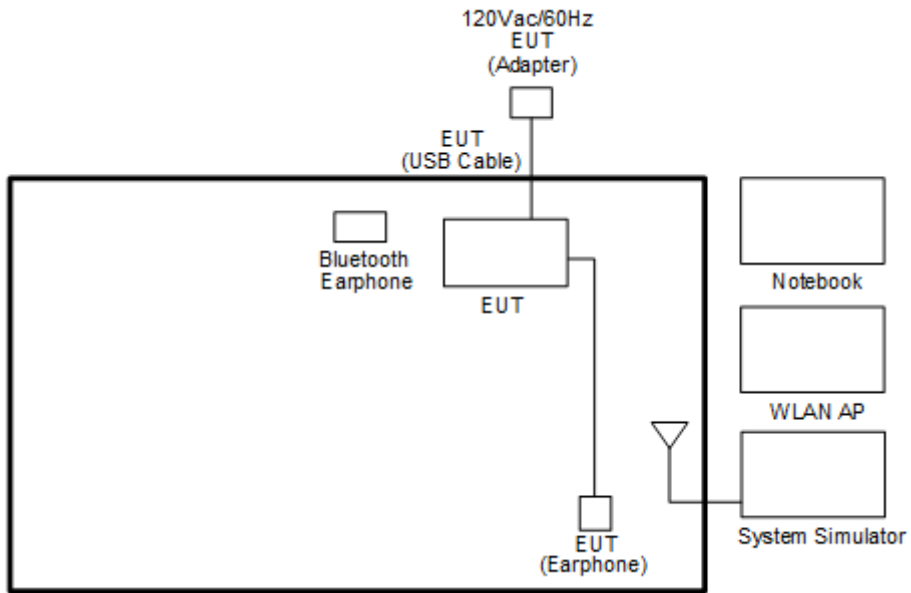

<WLAN Tx Mode>

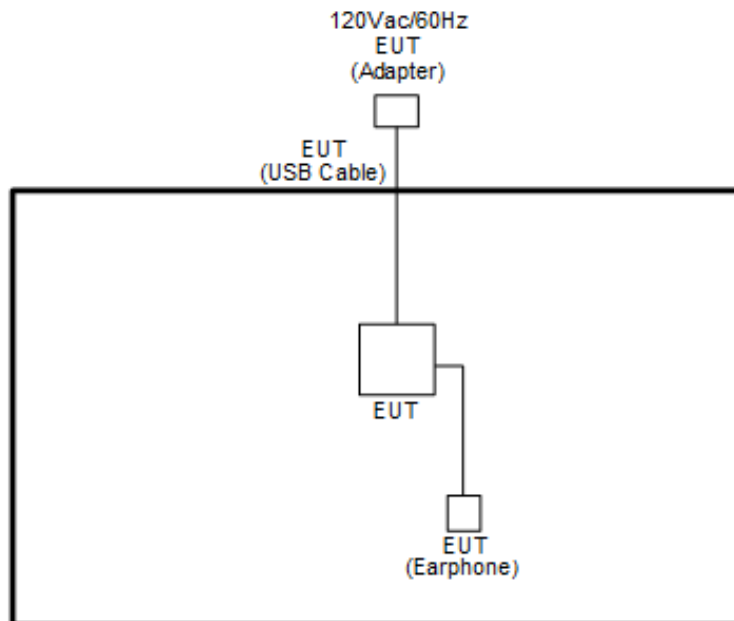



2.4 Support Unit used in test configuration and system

Item	Equipment	Trade Name	Model Name	FCC ID	Data Cable	Power Cord
1.	System Simulator	R&S	CMU 200	N/A	N/A	Unshielded, 1.8 m
2.	Wireless Earphone	Google	G1007 / G1008	A4RG1007 / A4RG1008	N/A	N/A
3.	WLAN AP	ASUS	RT-AC66U	MSQ-RTAC66U	N/A	Unshielded, 1.8 m
4.	Notebook	DELL	Latitude 3400	FCC DoC	N/A	AC I/P: Unshielded, 1.2m DC O/P: Shielded, 1.8m

2.5 EUT Operation Test Setup

The RF test items, utility “QRCT V.4.0.00147.0” was installed in Notebook which was programmed in order to make the EUT get into the engineering modes to provide channel selection, power level, data rate and the application type and for continuous transmitting signals.

2.6 Measurement Results Explanation Example

For all conducted test items:

The offset level is set in the spectrum analyzer to compensate the RF cable loss and attenuator factor between EUT conducted output port and spectrum analyzer. With the offset compensation, the spectrum analyzer reading level is exactly the EUT RF output level.

Example:

The spectrum analyzer offset is derived from RF cable loss and attenuator factor.

Offset = RF cable loss + attenuator factor.

Following shows an offset computation example with cable loss 4.2 dB and 10dB attenuator.

$$\begin{aligned} \text{Offset}(dB) &= \text{RF cable loss}(dB) + \text{attenuator factor}(dB). \\ &= 4.2 + 10 = 14.2 \text{ (dB)} \end{aligned}$$

3 Test Result

3.1 6dB and 99% Bandwidth Measurement

3.1.1 Limit of 6dB and 99% Bandwidth

The minimum 6 dB bandwidth shall be at least 500 kHz.

3.1.2 Measuring Instruments

See list of measuring equipment of this test report.

3.1.3 Test Procedures

1. The testing follows the ANSI C63.10 Section 6.9.3 (OBW) and 11.8.1 (6dB BW).
2. The RF output of EUT was connected to the spectrum analyzer by RF cable and attenuator. The path loss was compensated to the results for each measurement.
3. Set to the maximum power setting and enable the EUT transmit continuously.
4. Make the measurement with the spectrum analyzer's resolution bandwidth (RBW) = 100 kHz. Set the Video bandwidth (VBW) = 300 kHz. In order to make an accurate measurement. The 6 dB bandwidth must be greater than 500 kHz.
5. For 99% Bandwidth Measurement, the spectrum analyzer's resolution bandwidth (RBW) is set 1-5% of the emission bandwidth and set the Video bandwidth (VBW) $\geq 3 * RBW$.
6. Measure and record the results in the test report.

3.1.4 Test Setup





3.1.5 Test Result of 6dB and 99% Occupied Bandwidth

Please refer to Appendix A.

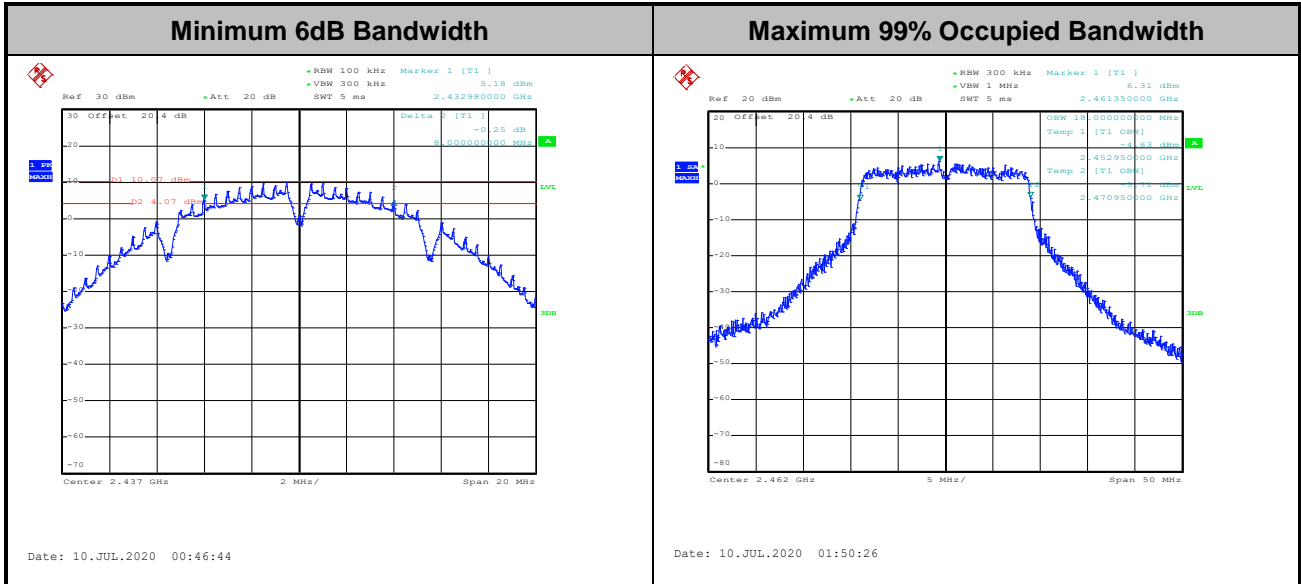

Note: The occupied channel bandwidth is maintained within the band of operation for all of the modulations.

3.2 Output Power Measurement

3.2.1 Limit of Output Power

For systems using digital modulation in the 2400-2483.5MHz, the limit for output power is 30dBm. If transmitting antenna with directional gain greater than 6dBi is used, the peak output power from the intentional radiator shall be reduced below the above stated value by the amount in dB that the directional gain of the antenna exceeds 6 dBi. In case of point-to-point operation, the limit has to be reduced by 1dB for every 3dB that the directional gain of the antenna exceeds 6dBi.

3.2.2 Measuring Instruments

See list of measuring equipment of this test report.

3.2.3 Test Procedures

1. For Average Power, the testing follows ANSI C63.10 Section 11.9.2.3.2 Method AVGPM-G
2. The RF output of EUT was connected to the power meter by RF cable and attenuator. The path loss was compensated to the results for each measurement.
3. Set to the maximum power setting and enable the EUT transmit continuously.
4. Measure the conducted output power and record the results in the test report.
5. For MIMO mode, calculation method follows FCC KDB 662911 D01 Multiple Transmitter Output v02r01.

3.2.4 Test Setup

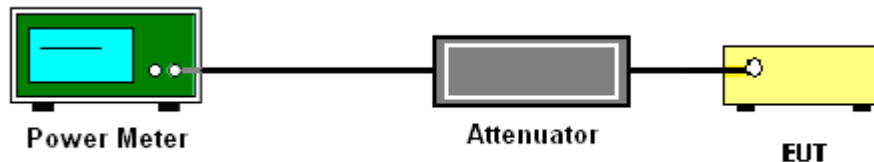

3.2.5 Test Result of Average Output Power

Please refer to Appendix A.

3.3 Power Spectral Density Measurement

3.3.1 Limit of Power Spectral Density

The peak power spectral density shall not be greater than 8dBm in any 3kHz band at any time interval of continuous transmission.

3.3.2 Measuring Instruments

See list of measuring equipment of this test report.

3.3.3 Test Procedures

1. The testing follows the ANSI C63.10 Section 11.10.2 Method PKPSD.
2. The RF output of EUT was connected to the spectrum analyzer by RF cable and attenuator. The path loss was compensated to the results for each measurement.
3. Set to the maximum power setting and enable the EUT transmit continuously.
4. Make the measurement with the spectrum analyzer's resolution bandwidth (RBW) = 3 kHz. Video bandwidth VBW = 10 kHz In order to make an accurate measurement, set the span to 1.5 times DTS Channel Bandwidth. (6dB BW)
5. Detector = peak, Sweep time = auto couple, Trace mode = max hold, Allow trace to fully stabilize. Use the peak marker function to determine the maximum power level.
6. Measure and record the results in the test report.
7. For MIMO mode, calculation method follows FCC KDB 662911 D01 Multiple Transmitter Output v02r01.

If measurements performed using method (2) plus $10 \log(N)$ exceeds the emission limit, the test should choose method (1) before declaring that the device fails the emission limit.

Method (1): Measure and sum the spectra across the outputs.

The total final Power Spectral Density is from a device with 2 transmitter outputs. The spectrum measurements of the individual outputs are all performed with the same span and number of points, the spectrum value in the first spectral bin of output 1 is summed with that in the first spectral bin of output 2 to obtain the value for the first frequency bin of the summed spectrum.

Method (2): Measure and add $10 \log(N)$ dB, where N is the number of outputs. (N=2)

3.3.4 Test Setup

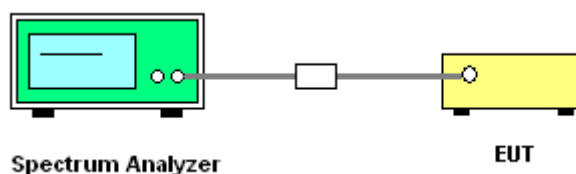



3.3.5 Test Result of Power Spectral Density

Please refer to Appendix A.

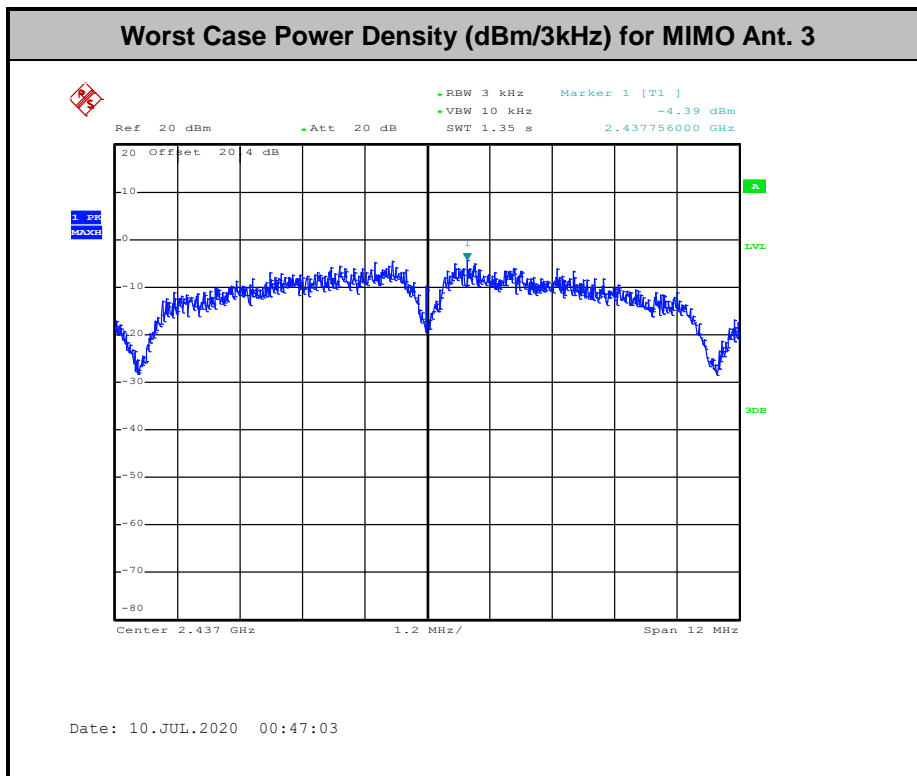
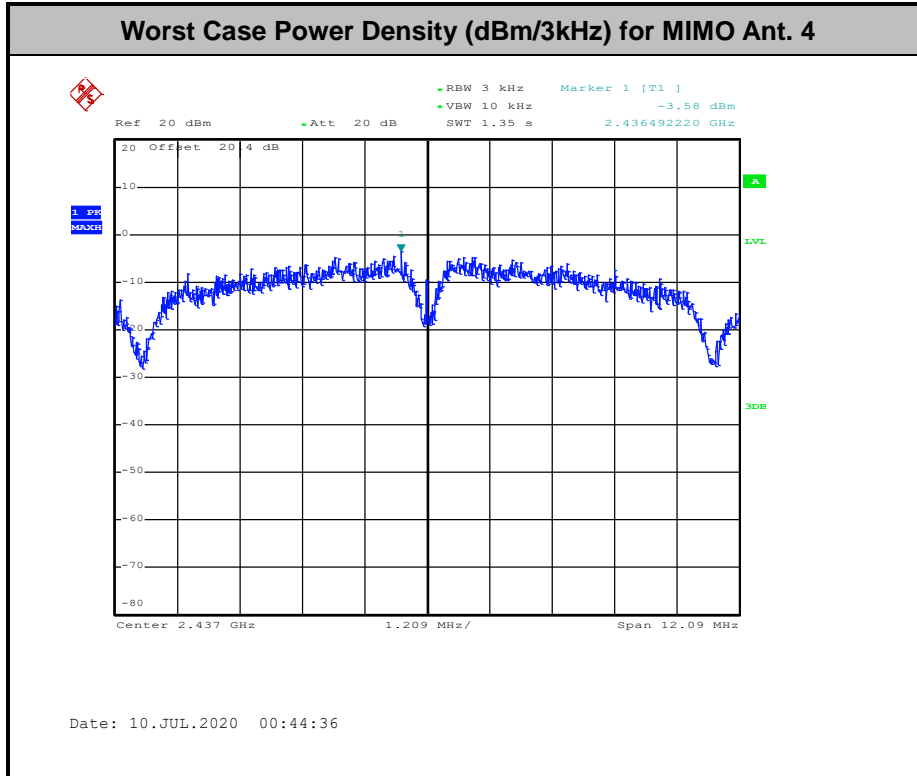

3.4 Conducted Band Edges and Spurious Emission Measurement

3.4.1 Limit of Conducted Band Edges and Spurious Emission Measurement

In any 100 kHz bandwidth outside of the authorized frequency band, the emissions which fall in the non-restricted bands shall be attenuated at least 20 dB / 30dB relative to the maximum PSD level in 100 kHz by RF conducted measurement.

3.4.2 Measuring Instruments

See list of measuring equipment of this test report.

3.4.3 Test Procedures

1. The testing follows the ANSI C63.10 Section 11.11.3 Emission level measurement.
2. The RF output of EUT was connected to the spectrum analyzer by RF cable and attenuator. The path loss was compensated to the results for each measurement.
3. Set to the maximum power setting and enable the EUT transmit continuously.
4. Set RBW = 100 kHz, VBW=300 kHz, Peak Detector. Unwanted Emissions measured in any 100 kHz bandwidth outside of the authorized frequency band shall be attenuated by at least 20 dB relative to the maximum in-band peak PSD level in 100 kHz when maximum peak conducted output power procedure is used. If the transmitter complies with the conducted power limits based on the use of RMS averaging over a time interval, the attenuation required under this paragraph shall be 30 dB instead of 20 dB per 15.247(d).
5. Measure and record the results in the test report.
6. The RF fundamental frequency should be excluded against the limit line in the operating frequency band.

3.4.4 Test Setup

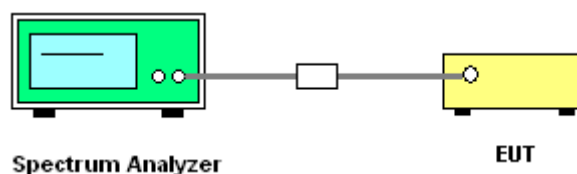



3.4.5 Test Result of Conducted Band Edges and Spurious Emission

Test Engineer :	Jacob Yu and Hank Hsu	Temperature :	21~25°C
		Relative Humidity :	51~54%

Number of TX = 2, Ant. 4 (Measured)

Test Mode :	802.11b	Test Channel :	01
-------------	---------	----------------	----

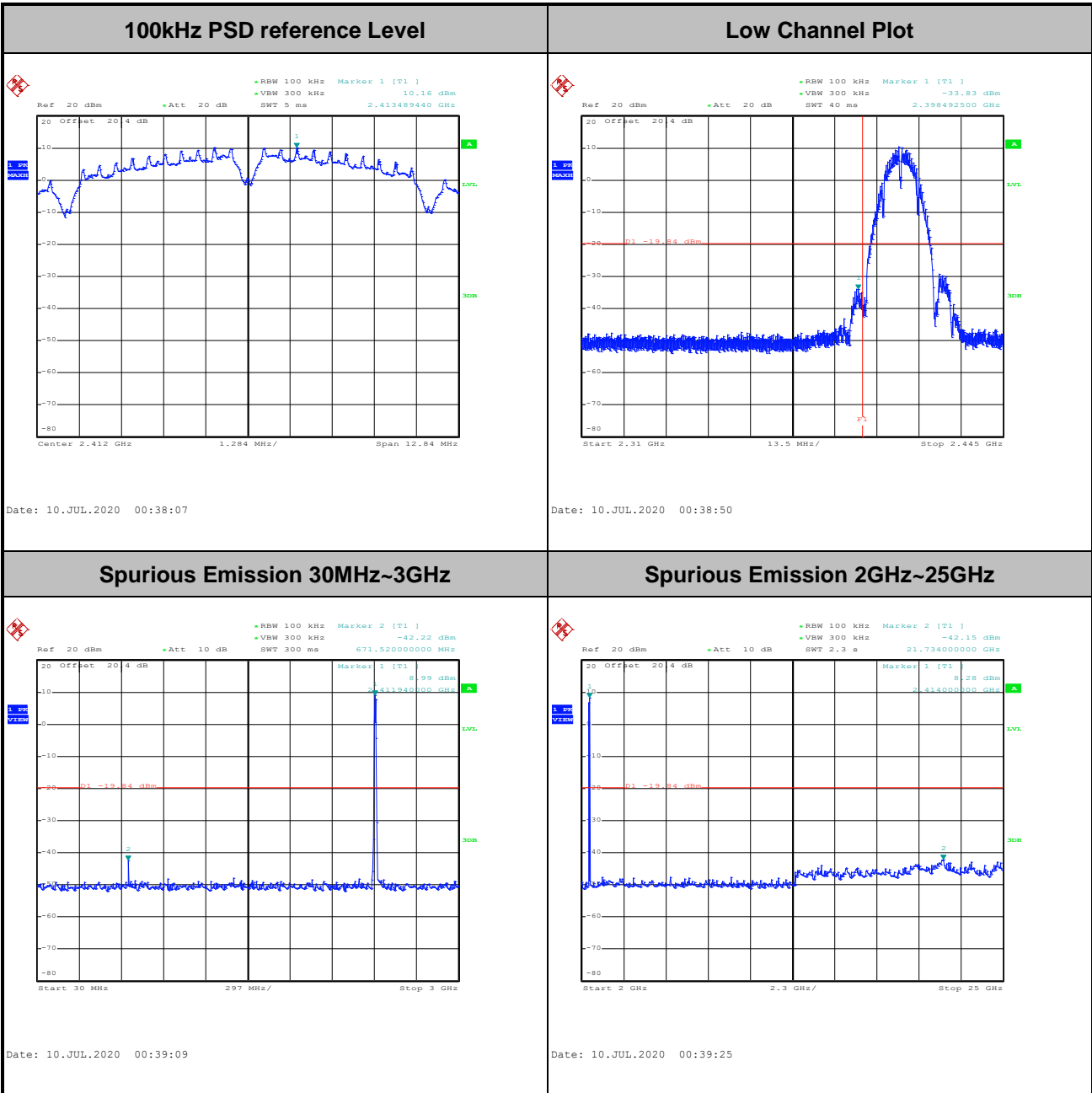



Test Mode :	802.11b	Test Channel :	06
-------------	---------	----------------	----

100kHz PSD reference Level	Mid Channel Plot
-----------------------------------	-------------------------

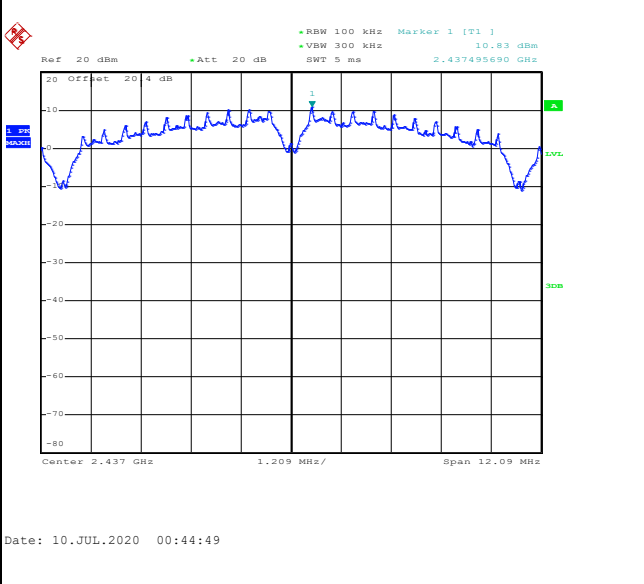

Spurious Emission 30MHz~3GHz	Spurious Emission 2GHz~25GHz
-------------------------------------	-------------------------------------

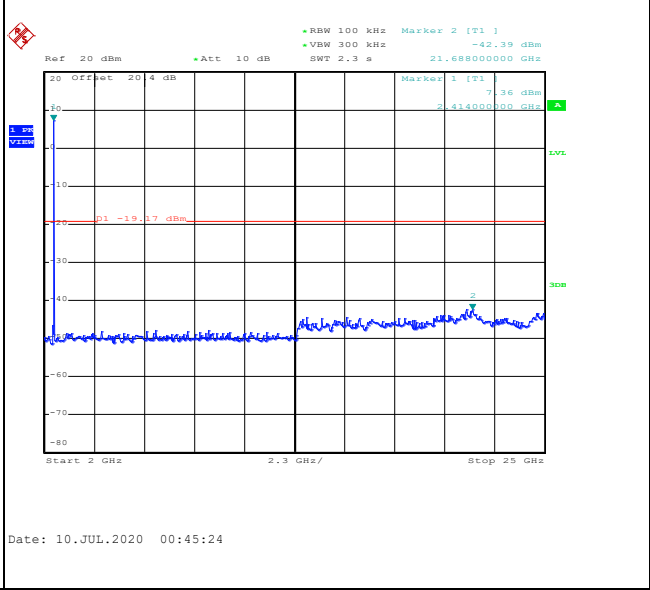
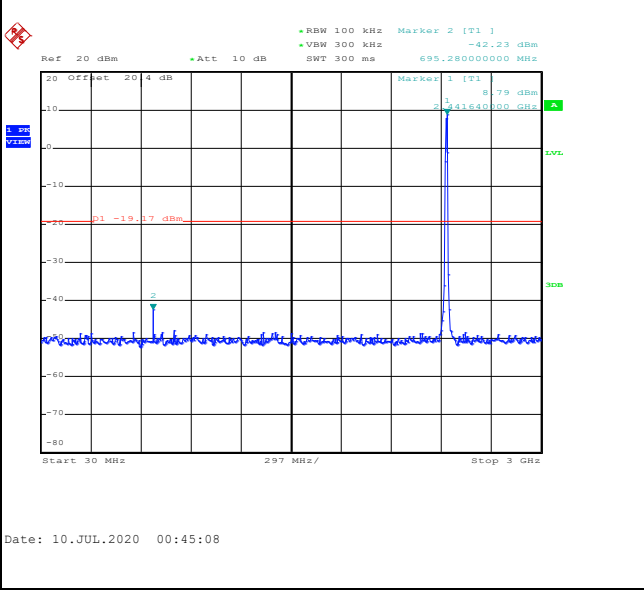



Test Mode :	802.11b	Test Channel :	11
-------------	---------	----------------	----

100kHz PSD reference Level	High Channel Plot
-----------------------------------	--------------------------

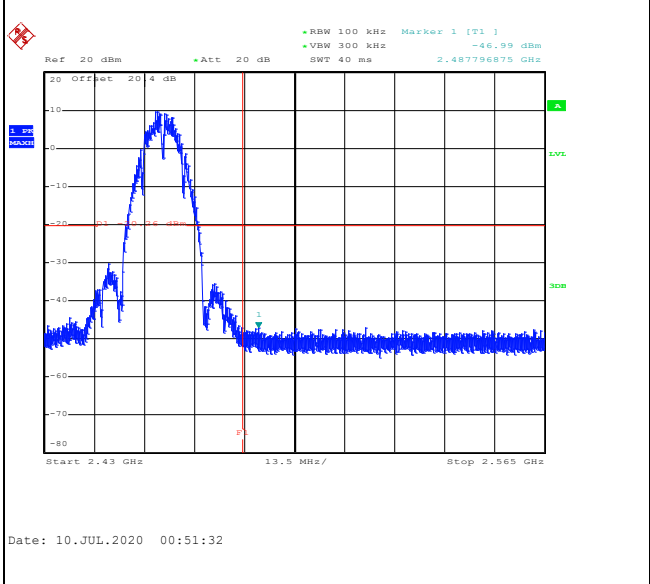
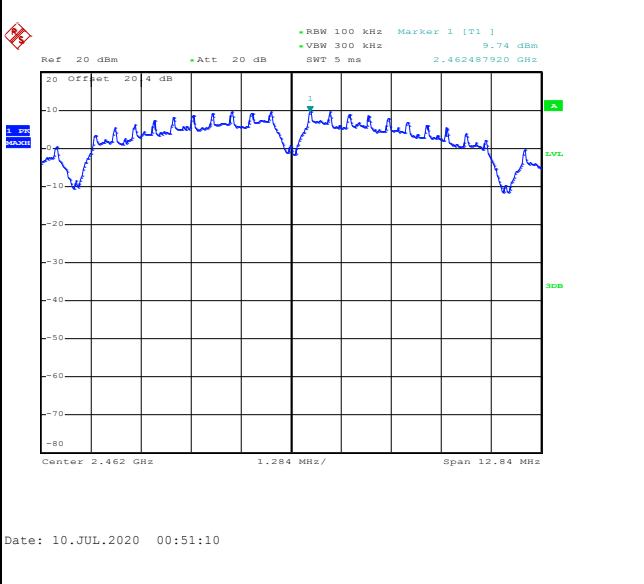

Spurious Emission 30MHz~3GHz	Spurious Emission 2GHz~25GHz
-------------------------------------	-------------------------------------

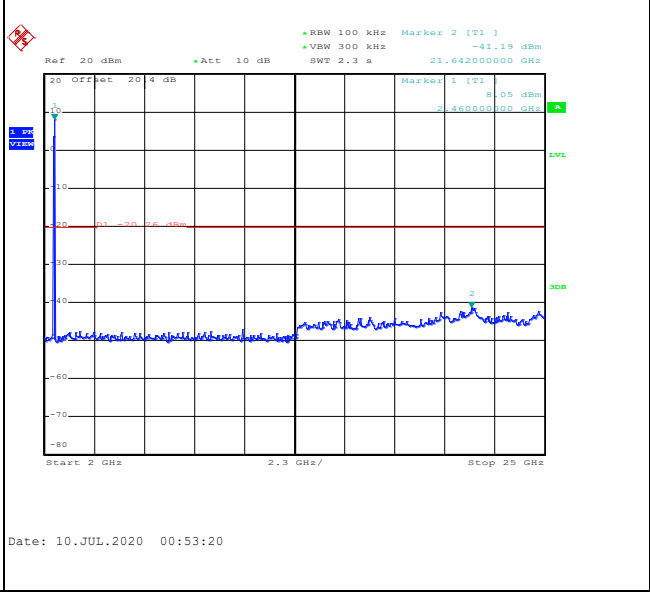
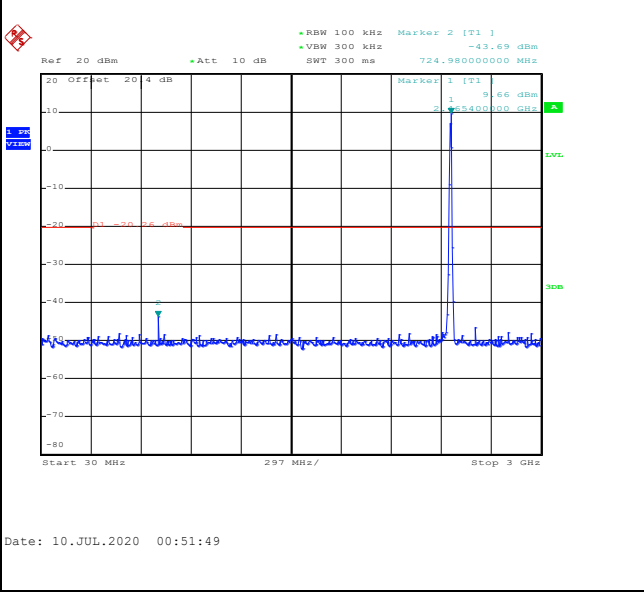



Test Mode :	802.11g	Test Channel :	01
-------------	---------	----------------	----

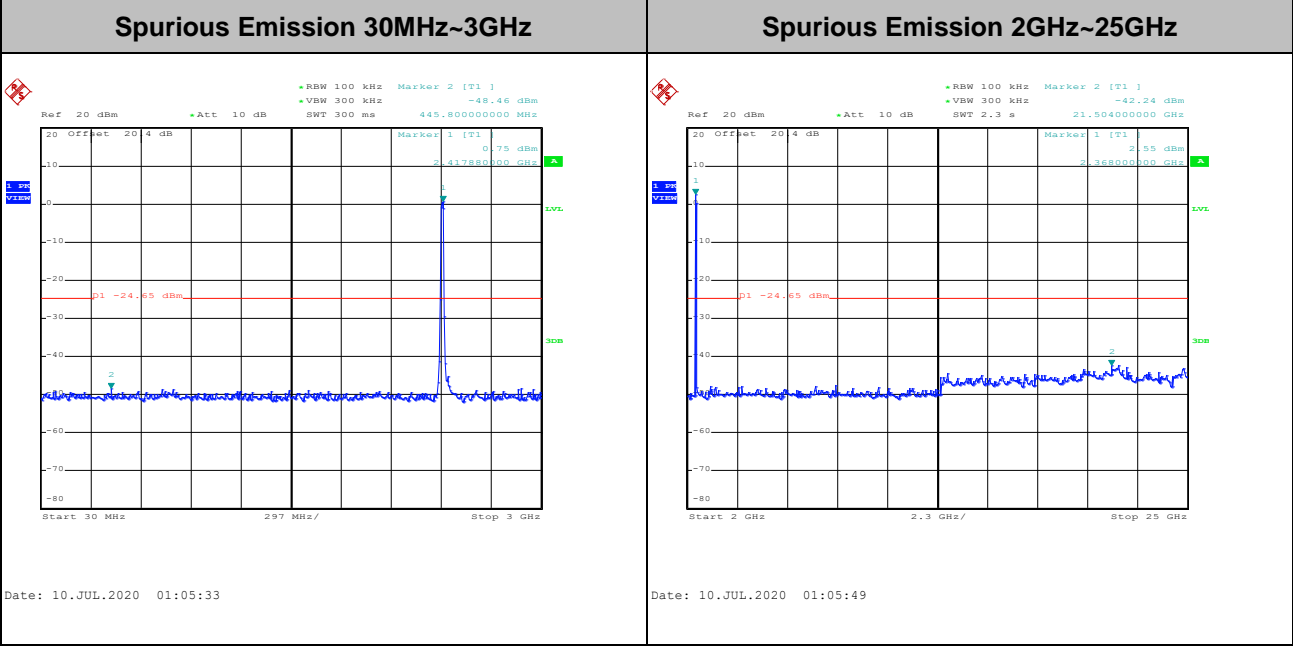
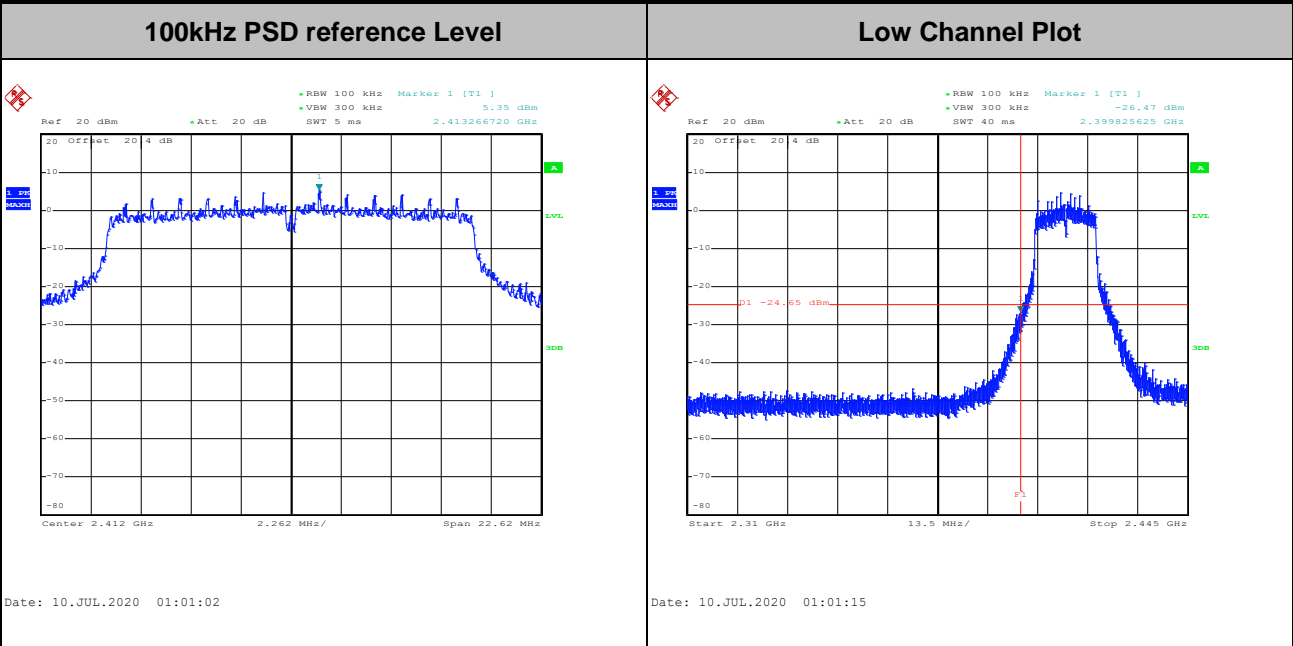



Test Mode :	802.11g	Test Channel :	06
-------------	---------	----------------	----

100kHz PSD reference Level	Mid Channel Plot
-----------------------------------	-------------------------

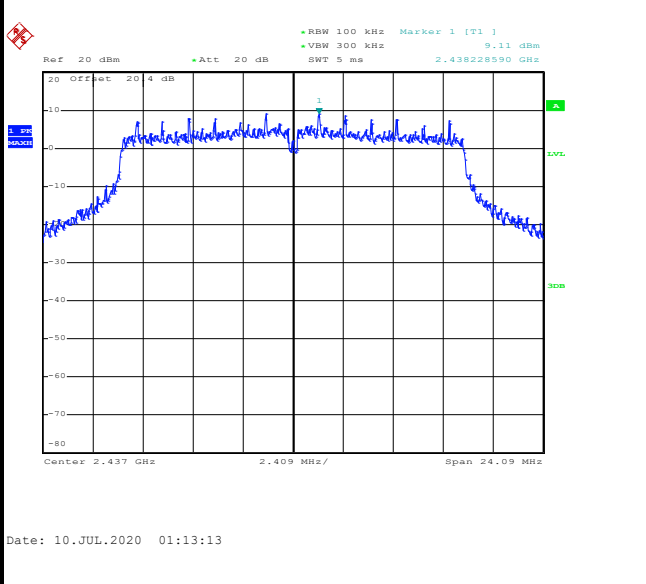

Spurious Emission 30MHz~3GHz	Spurious Emission 2GHz~25GHz
-------------------------------------	-------------------------------------

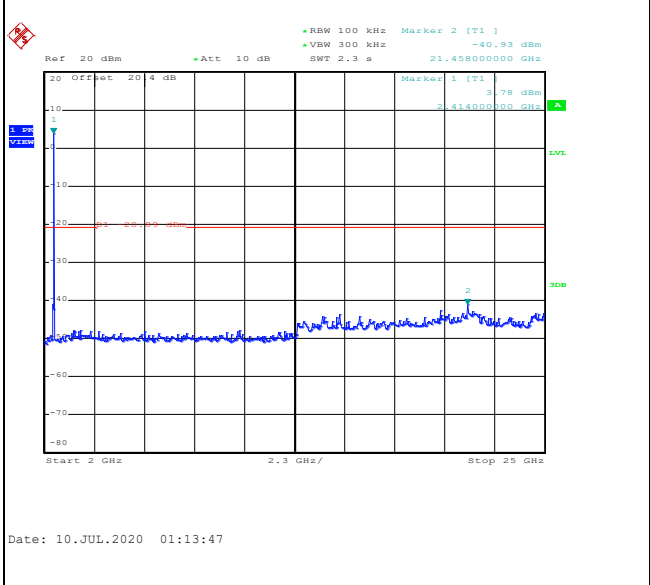
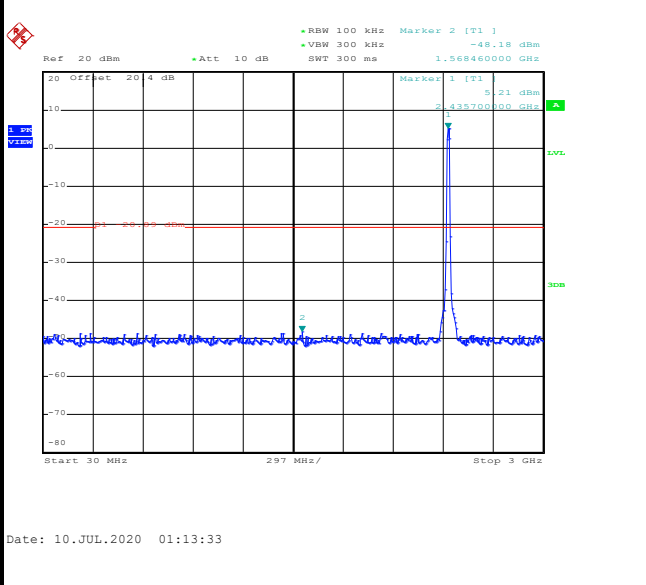



Test Mode :	802.11g	Test Channel :	11
-------------	---------	----------------	----

100kHz PSD reference Level	High Channel Plot
-----------------------------------	--------------------------

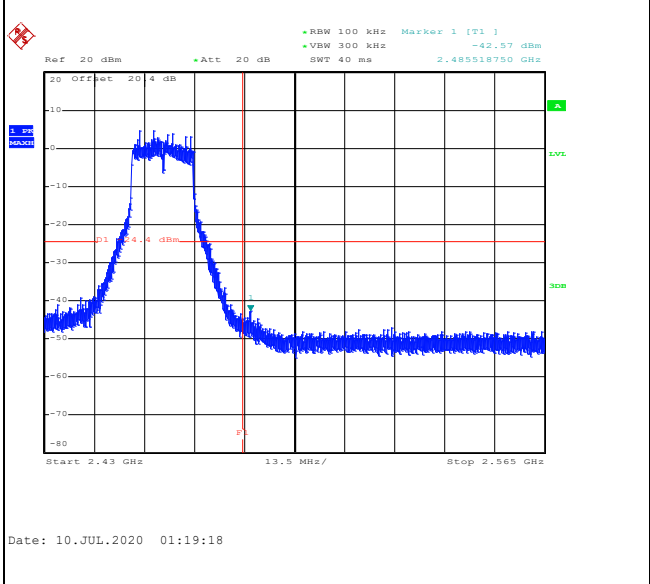
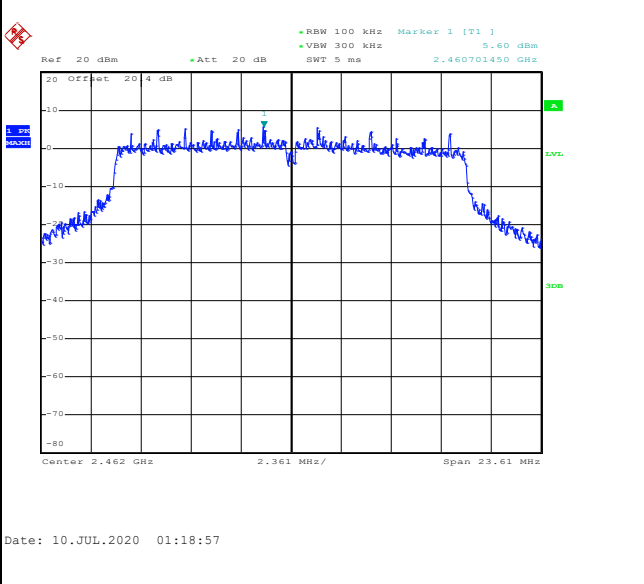

Spurious Emission 30MHz~3GHz	Spurious Emission 2GHz~25GHz
-------------------------------------	-------------------------------------

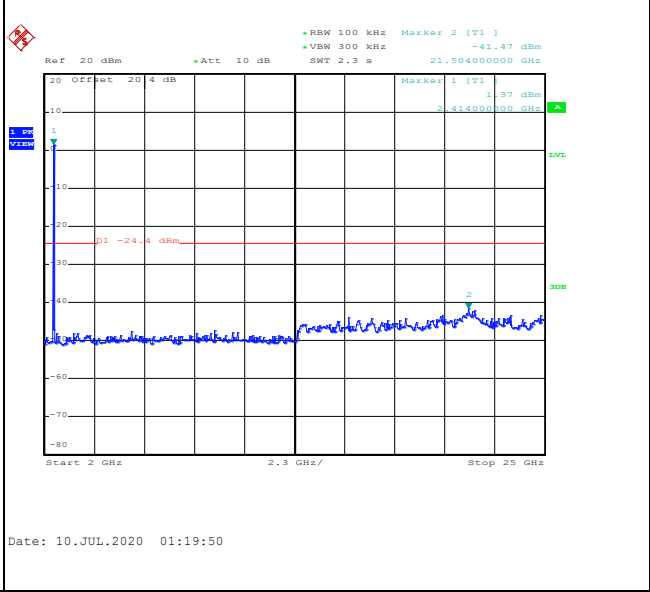
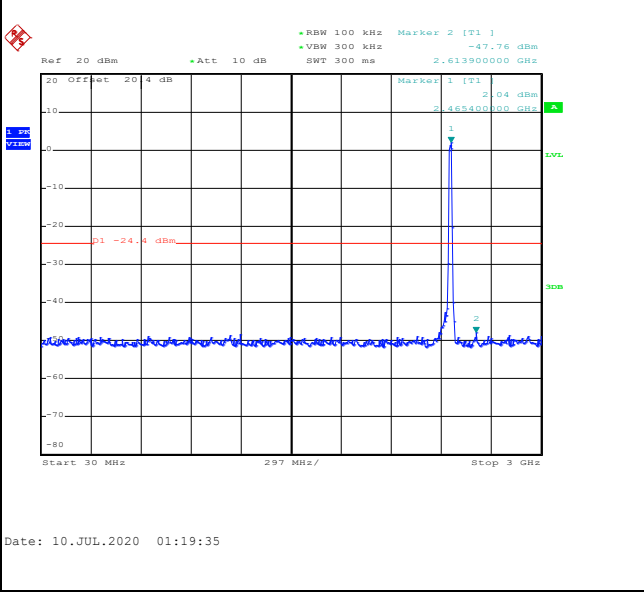



Test Mode :	802.11n HT20	Test Channel :	01
-------------	--------------	----------------	----

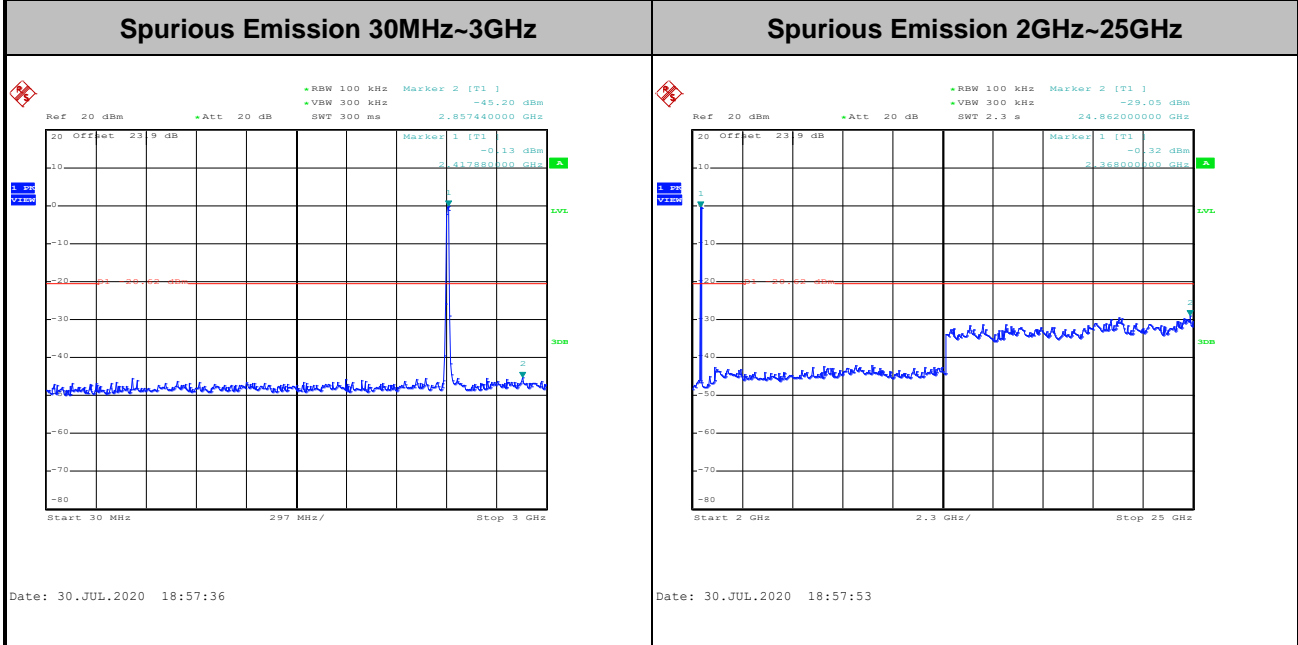
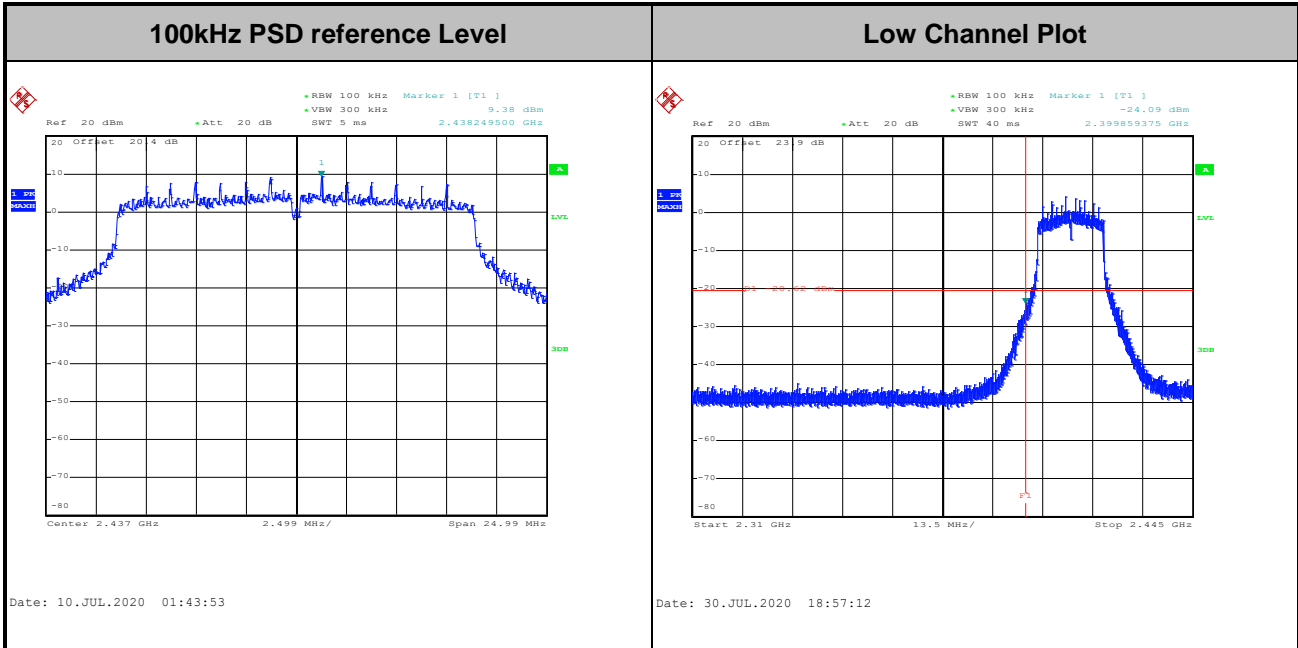



Test Mode :	802.11n HT20	Test Channel :	06
-------------	--------------	----------------	----

100kHz PSD reference Level	Mid Channel Plot
-----------------------------------	-------------------------

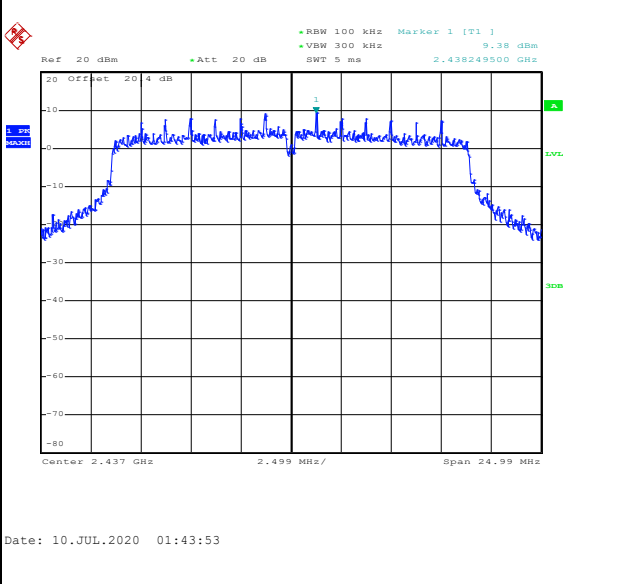

Spurious Emission 30MHz~3GHz	Spurious Emission 2GHz~25GHz
-------------------------------------	-------------------------------------

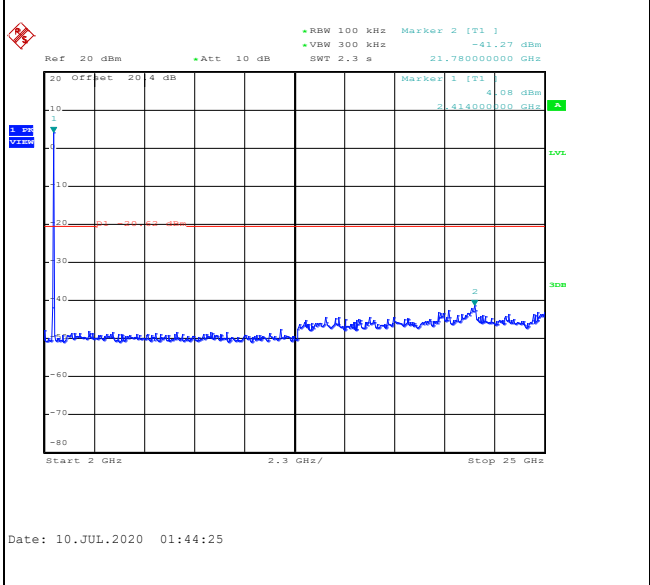
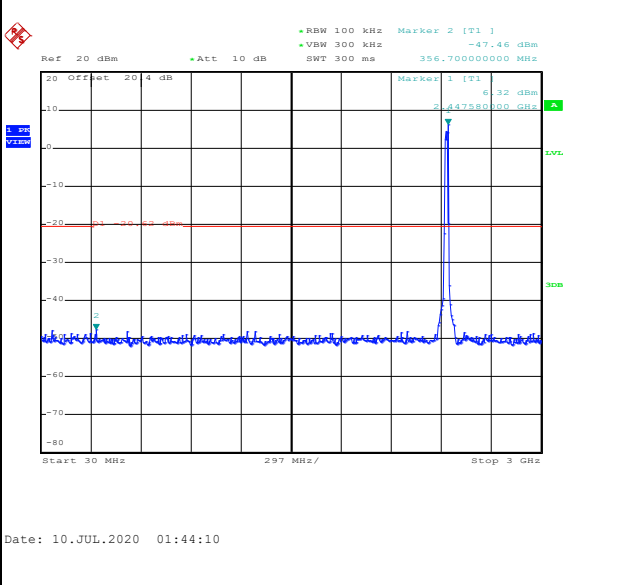



Test Mode :	802.11n HT20	Test Channel :	11
-------------	--------------	----------------	----

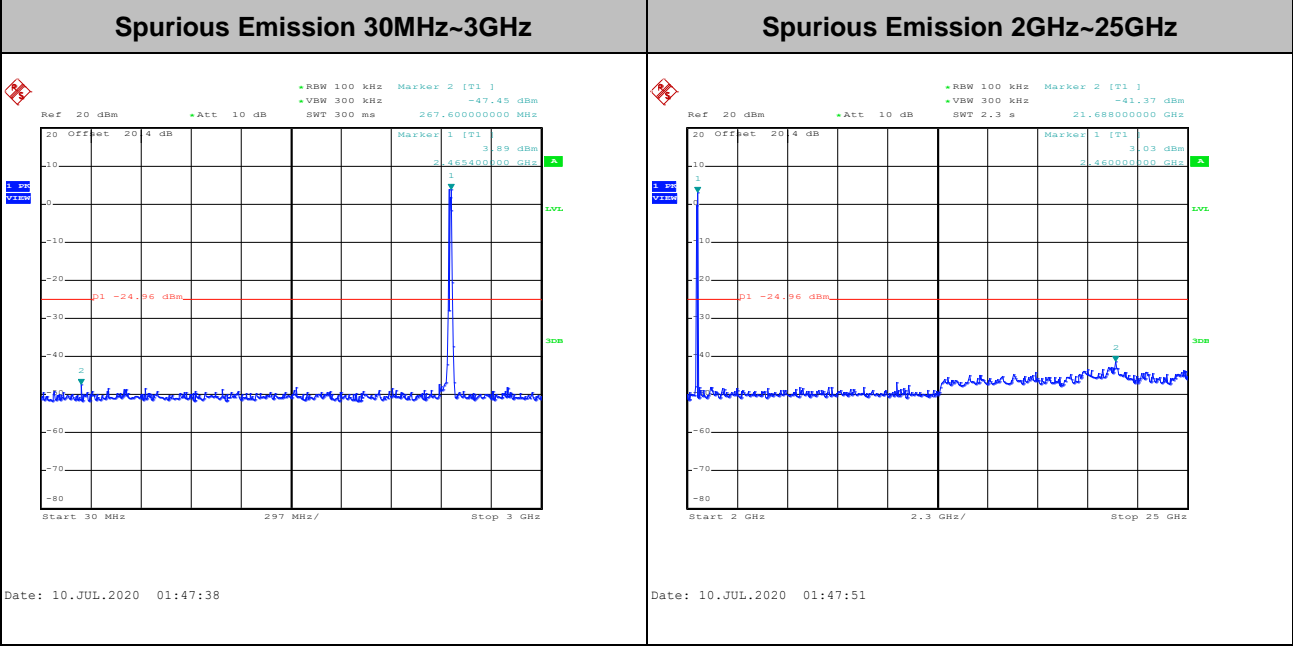
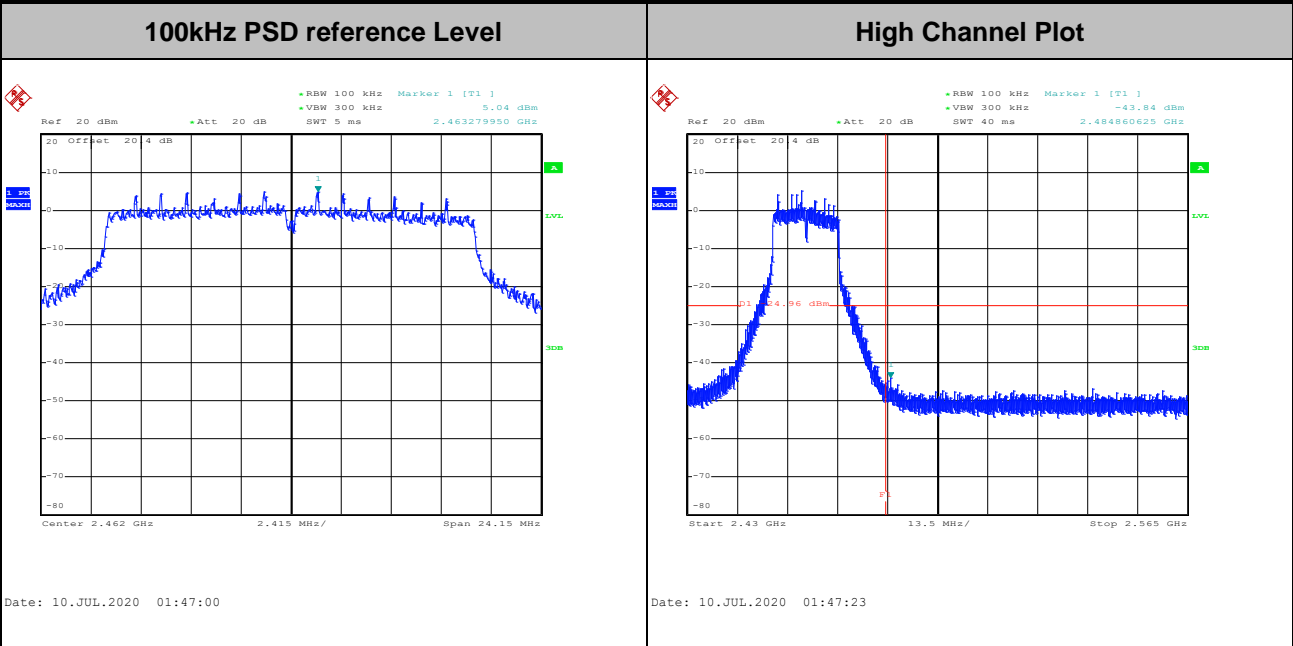



Number of TX = 2, Ant. 3 (Measured)

Test Mode :	802.11b	Test Channel :	01
-------------	---------	----------------	----

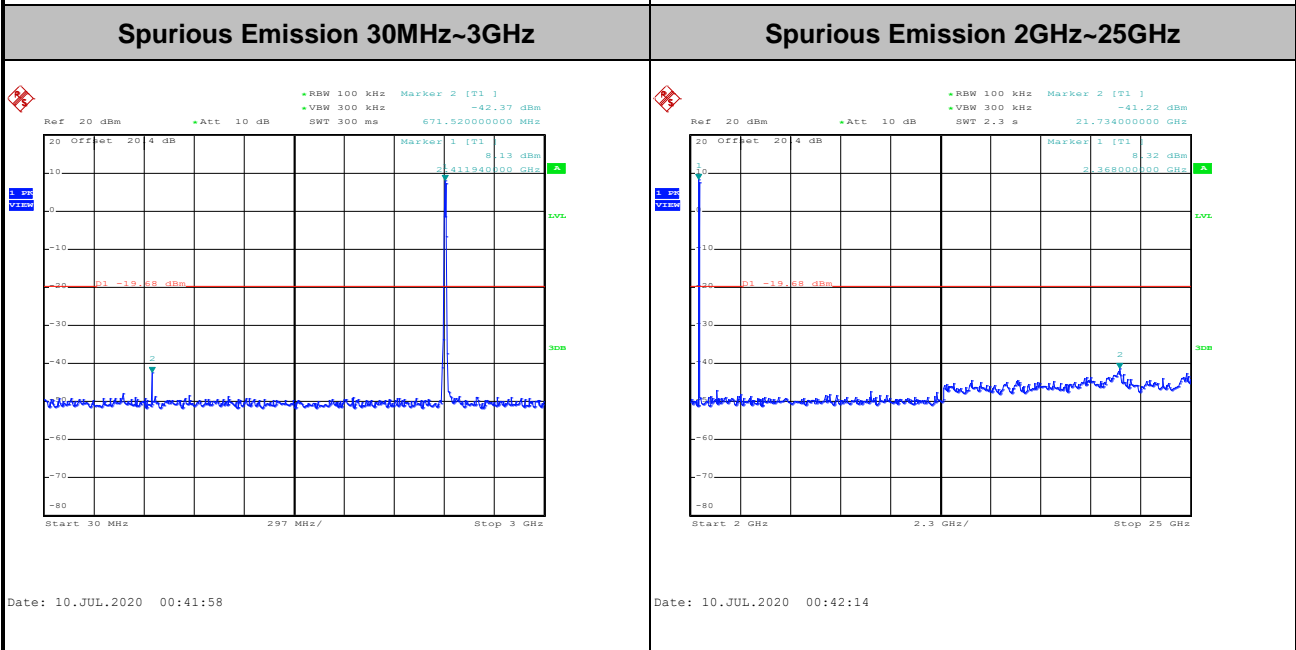
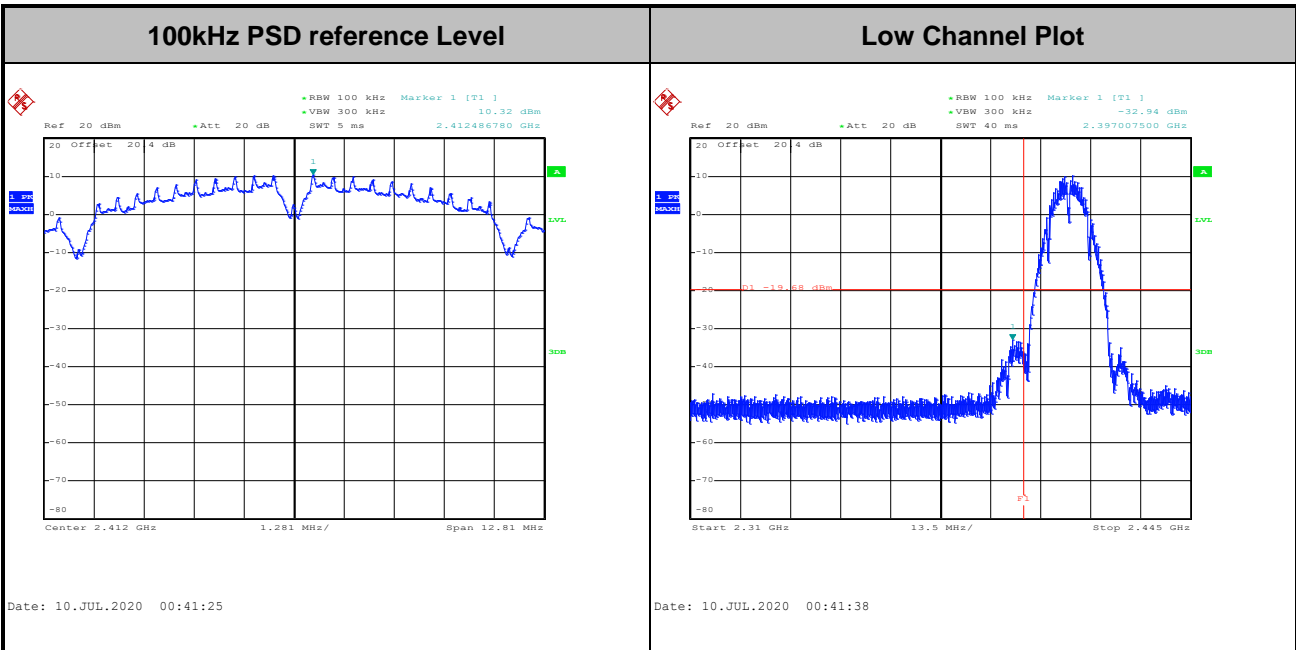



Test Mode :	802.11b	Test Channel :	06
-------------	---------	----------------	----

100kHz PSD reference Level	Mid Channel Plot
-----------------------------------	-------------------------

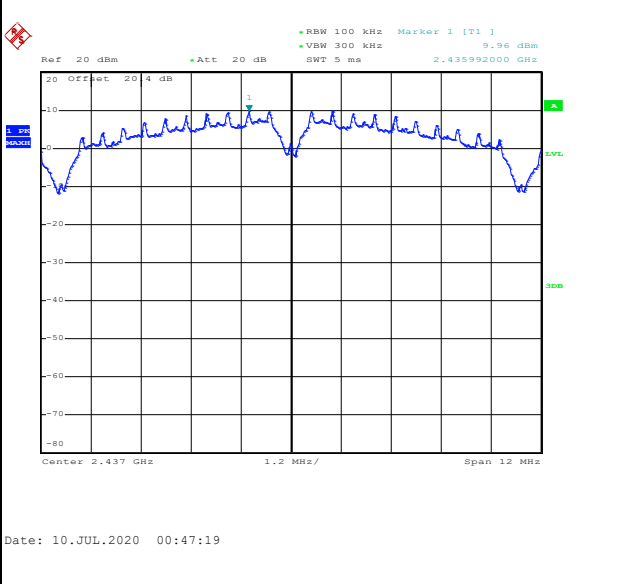

Spurious Emission 30MHz~3GHz	Spurious Emission 2GHz~25GHz
-------------------------------------	-------------------------------------

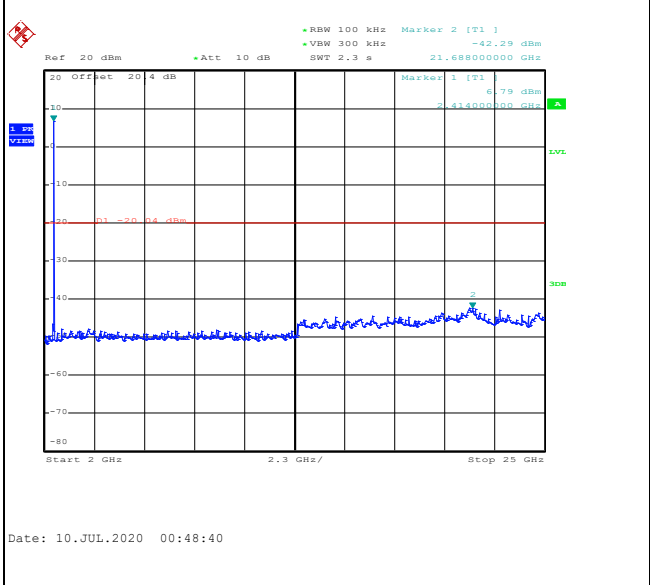
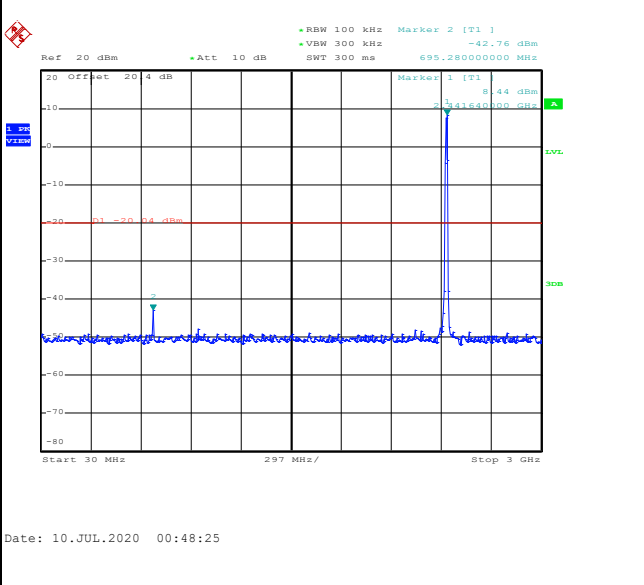



Test Mode :	802.11b	Test Channel :	11
-------------	---------	----------------	----

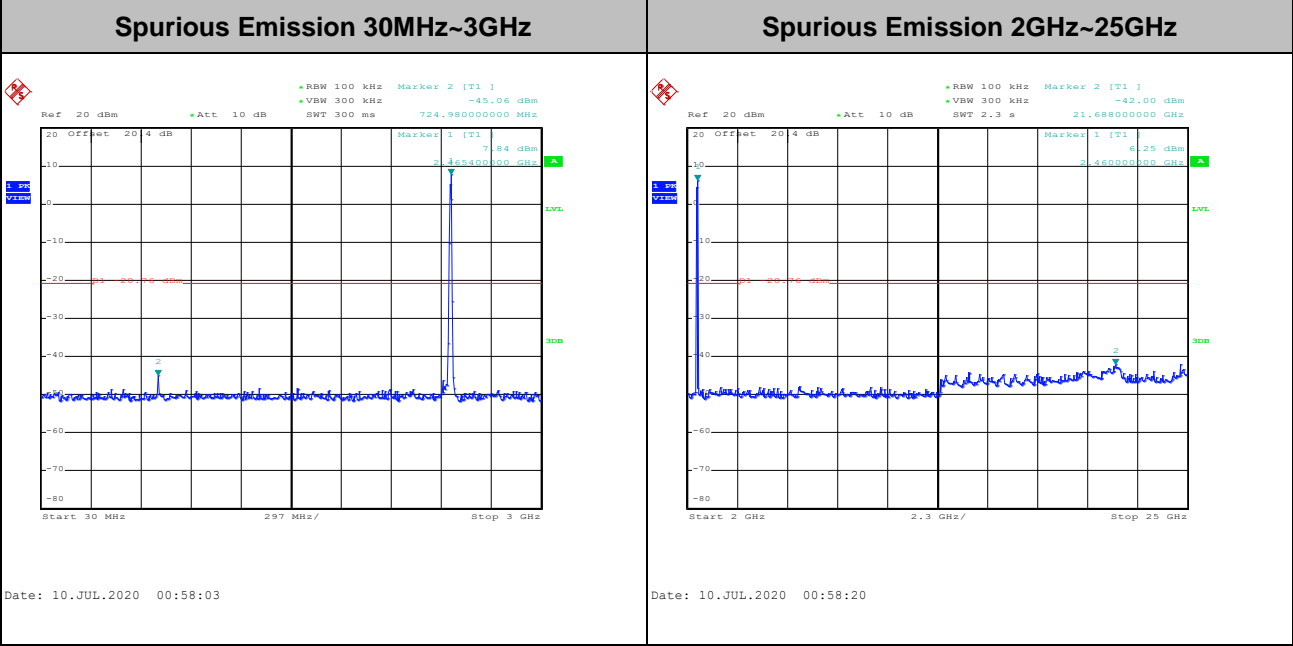
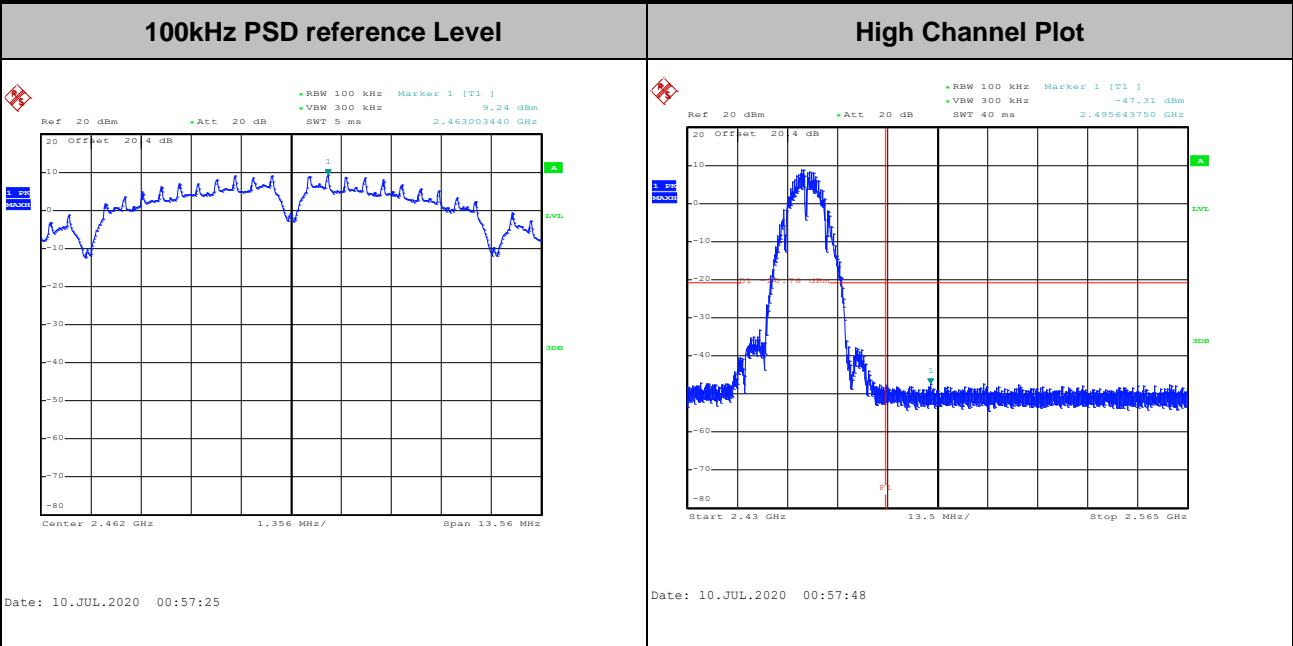



Test Mode :	802.11g	Test Channel :	01
-------------	---------	----------------	----

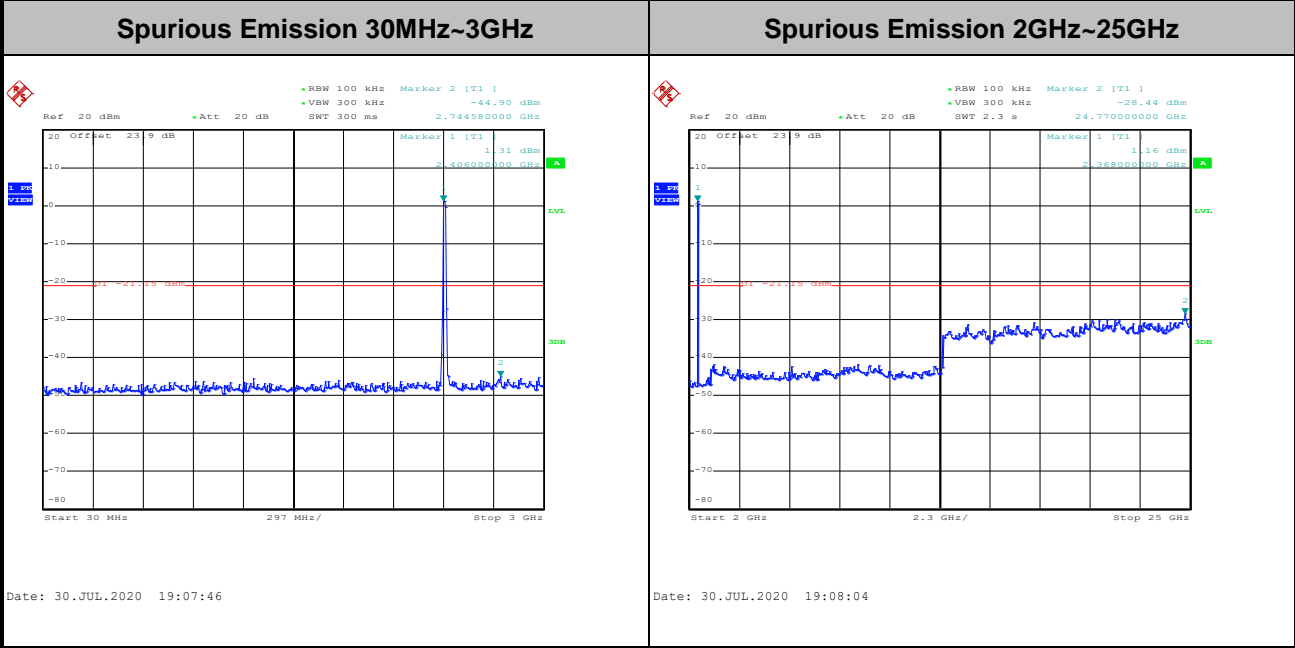
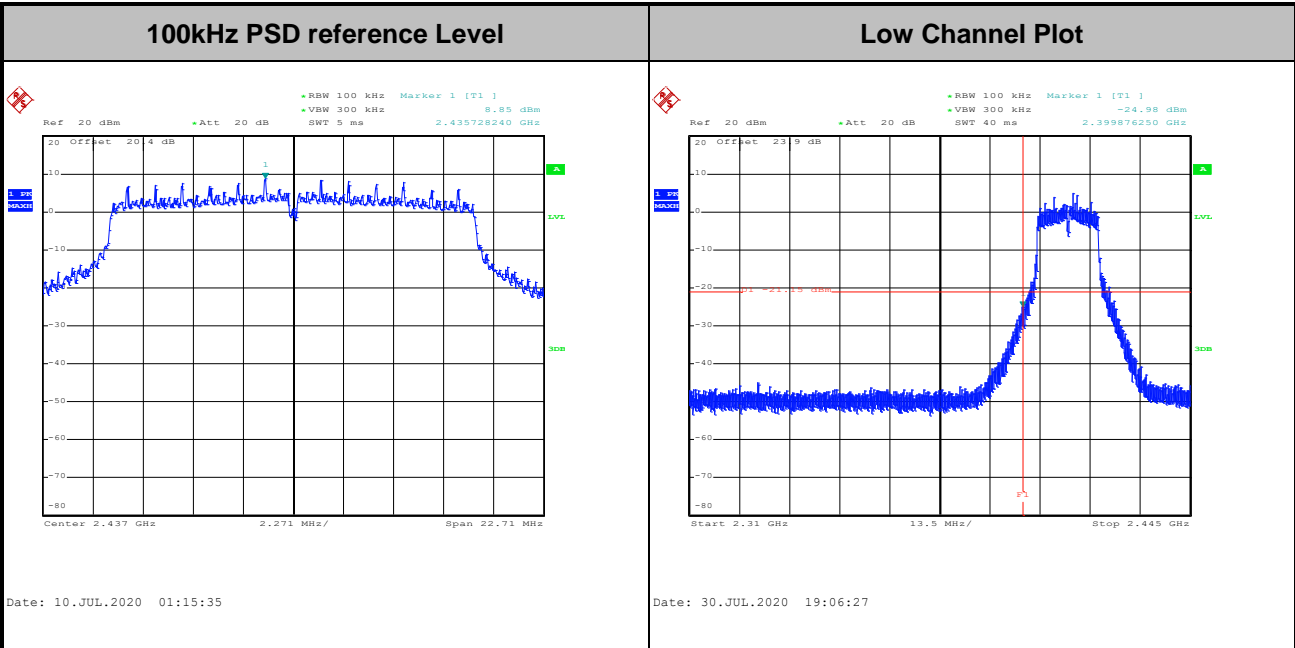



Test Mode :	802.11g	Test Channel :	06
-------------	---------	----------------	----

100kHz PSD reference Level	Mid Channel Plot
-----------------------------------	-------------------------

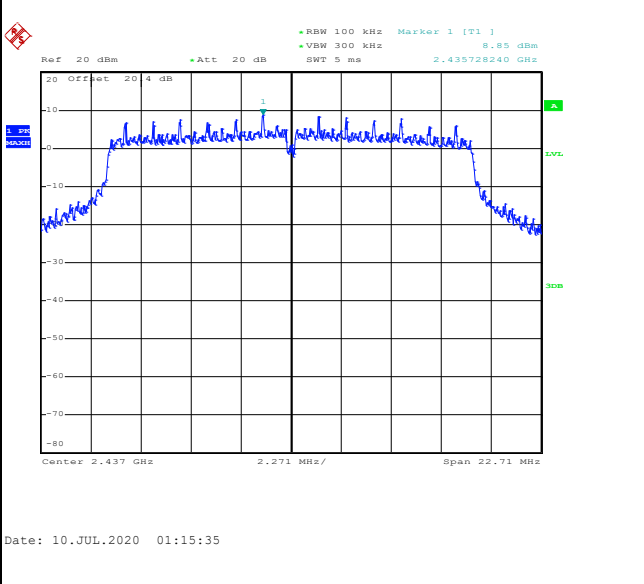

Spurious Emission 30MHz~3GHz	Spurious Emission 2GHz~25GHz
-------------------------------------	-------------------------------------

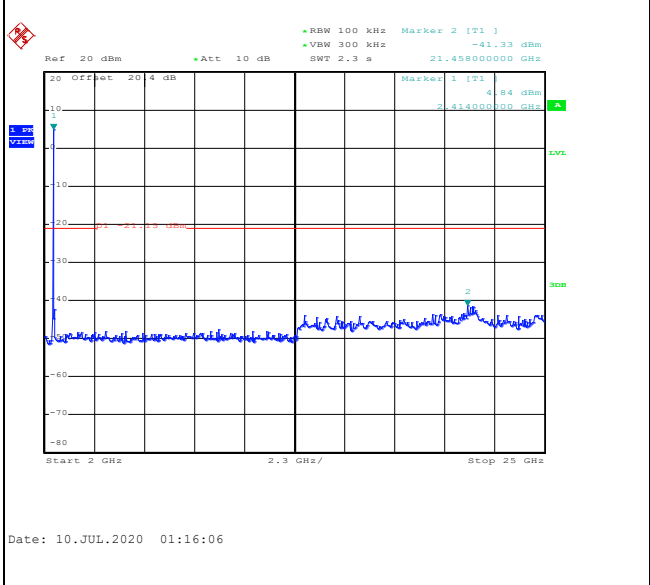
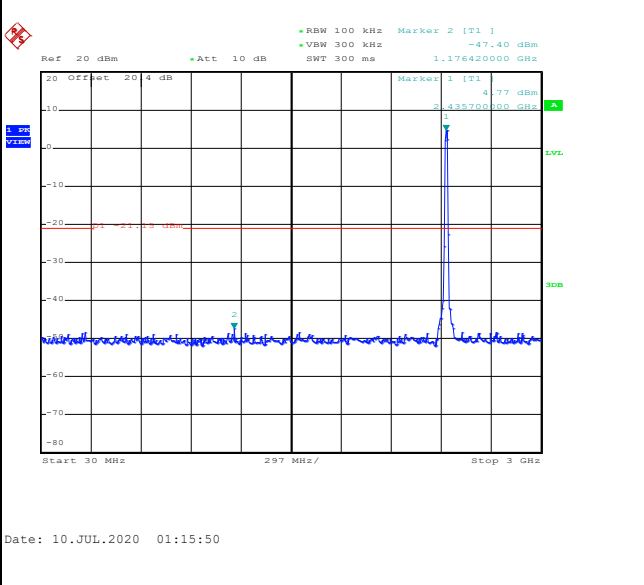



Test Mode :	802.11g	Test Channel :	11
-------------	---------	----------------	----

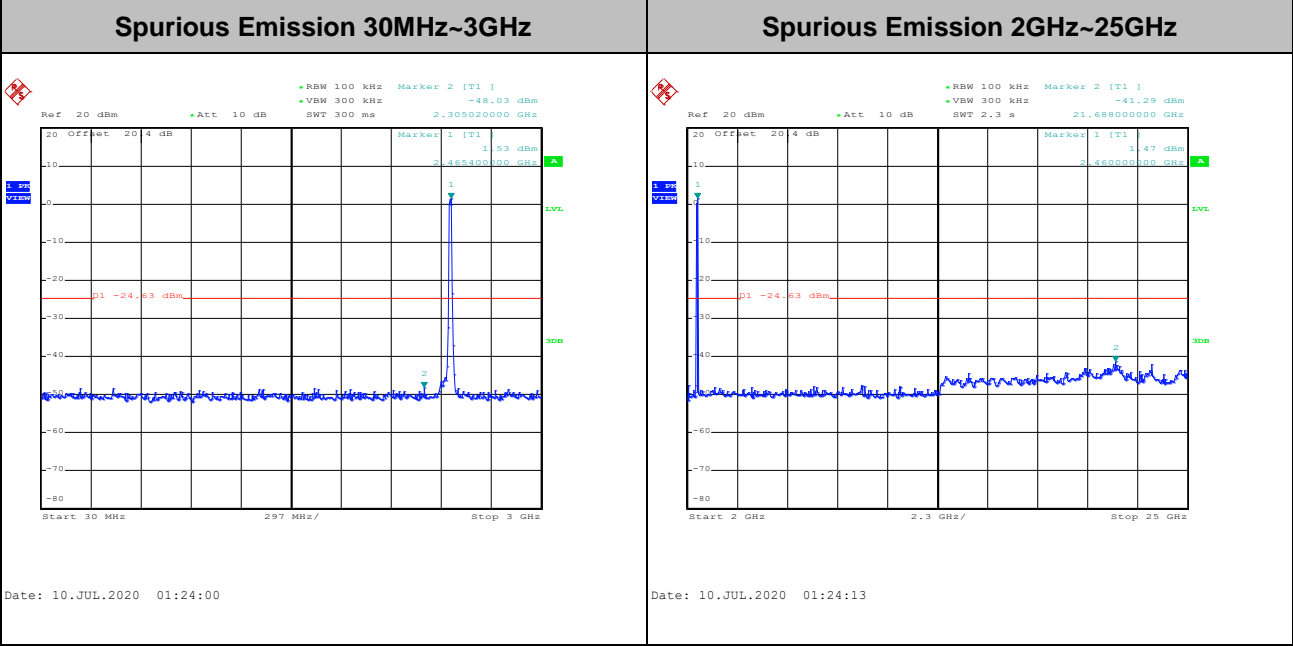
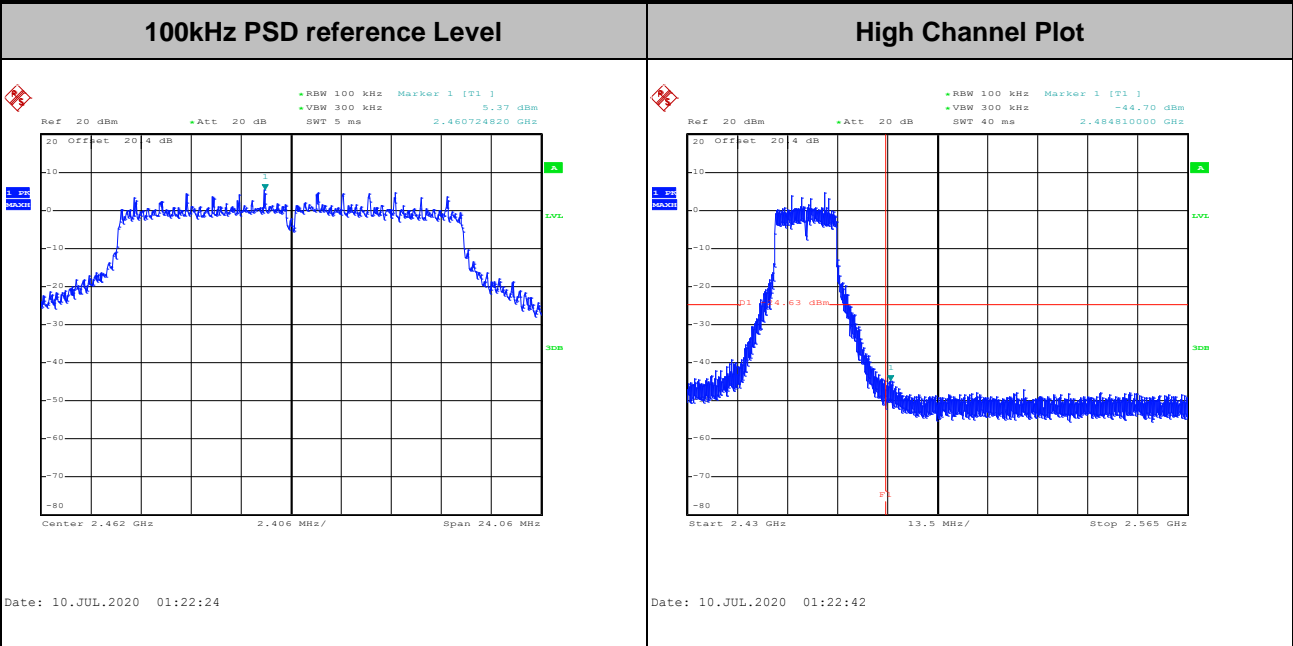



Test Mode :	802.11n HT20	Test Channel :	01
-------------	--------------	----------------	----

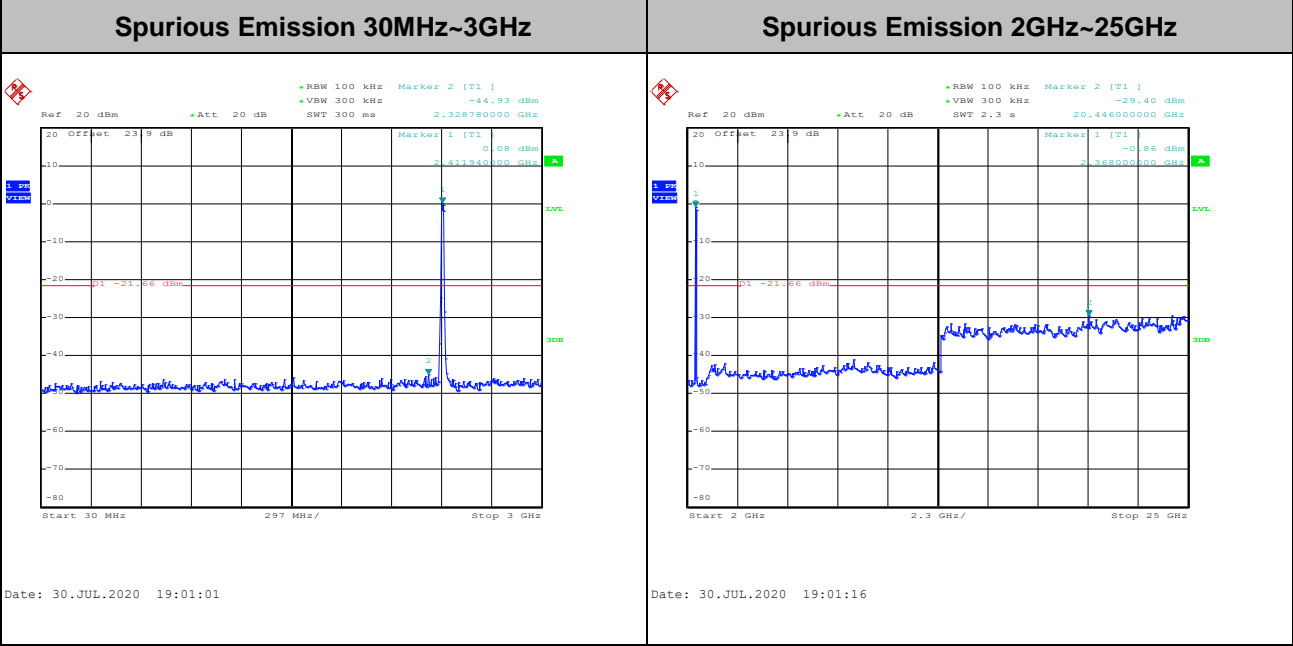
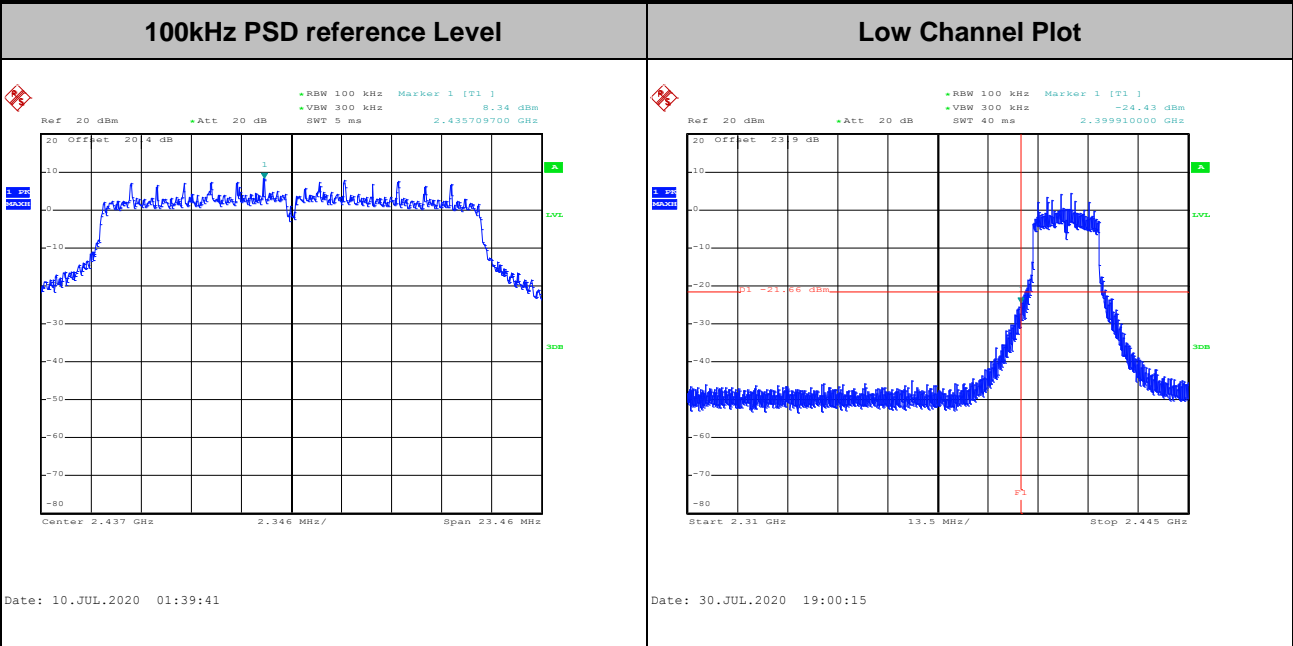



Test Mode :	802.11n HT20	Test Channel :	06
-------------	--------------	----------------	----

100kHz PSD reference Level	Mid Channel Plot
-----------------------------------	-------------------------

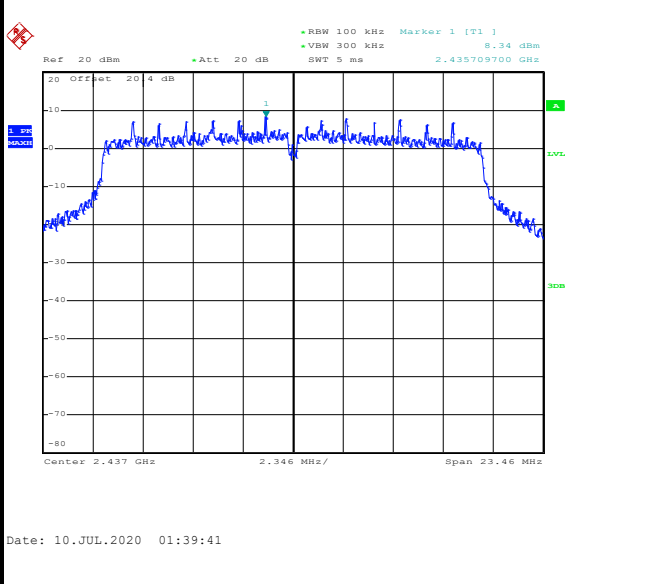

Spurious Emission 30MHz~3GHz	Spurious Emission 2GHz~25GHz
-------------------------------------	-------------------------------------

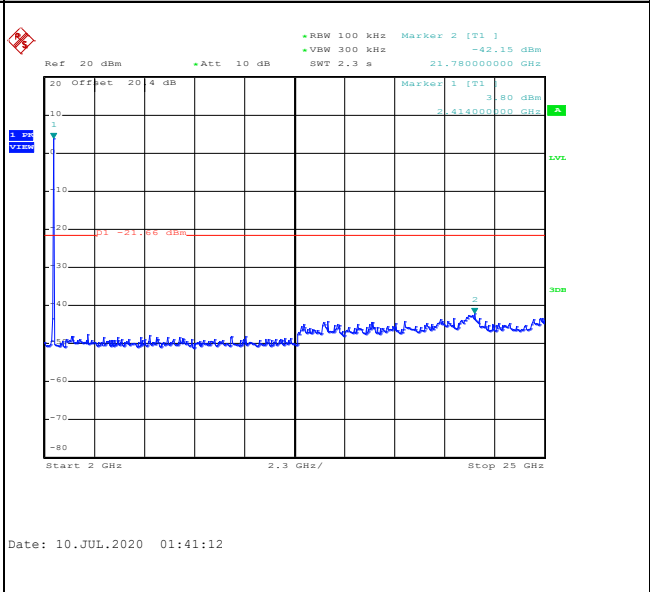
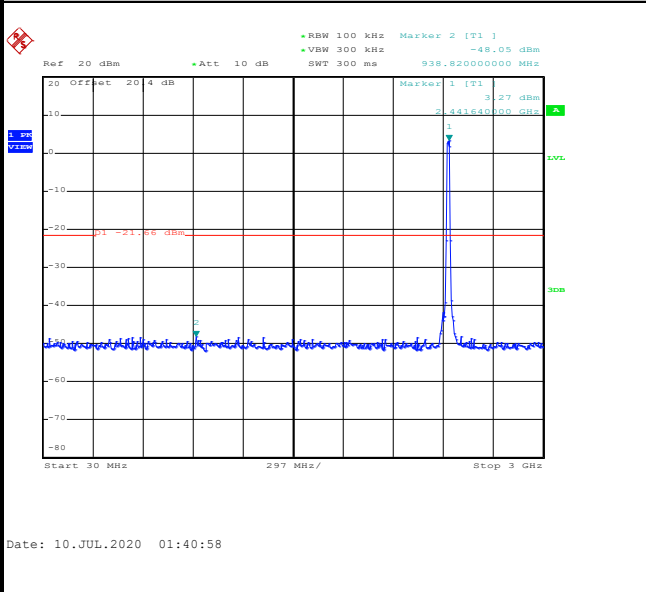



Test Mode :	802.11n HT20	Test Channel :	11
-------------	--------------	----------------	----

100kHz PSD reference Level	High Channel Plot
-----------------------------------	--------------------------

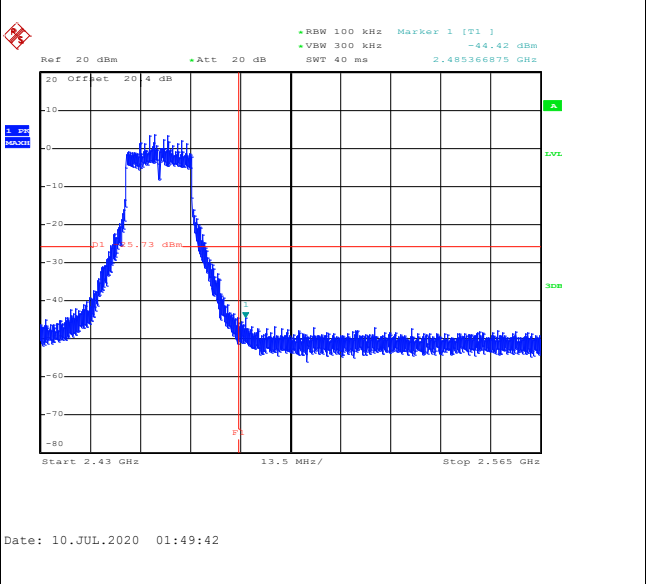
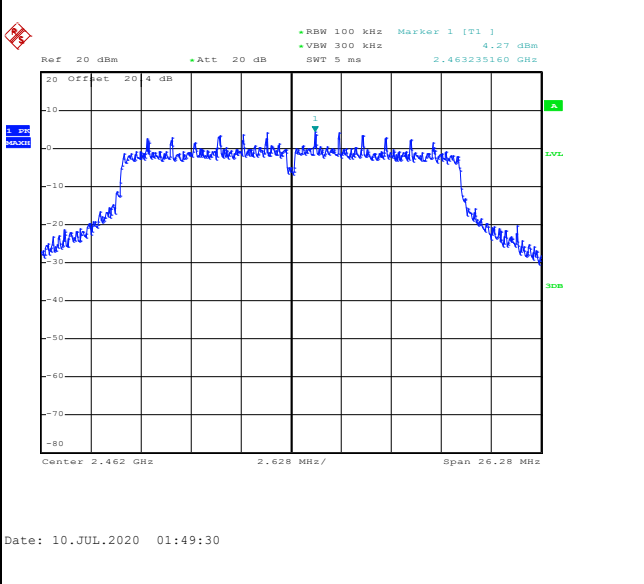

Spurious Emission 30MHz~3GHz	Spurious Emission 2GHz~25GHz
-------------------------------------	-------------------------------------

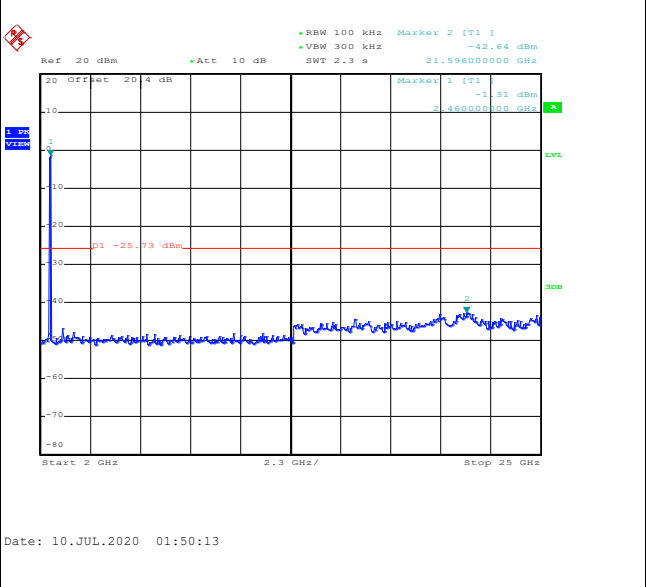
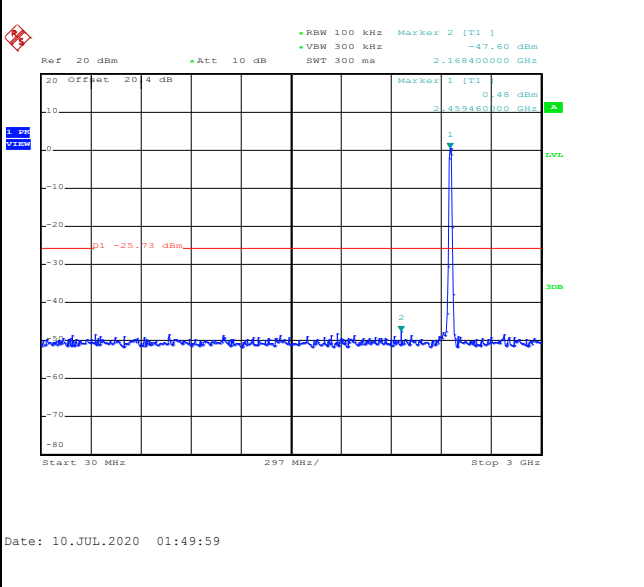



3.5 Radiated Band Edges and Spurious Emission Measurement

3.5.1 Limit of Radiated band edge and Spurious Emission Measurement

In any 100 kHz bandwidth outside the intentional radiator frequency band, all harmonics/spurious must be at least 20 dB below the highest emission level within the authorized band. If the output power of this device was measured by spectrum analyzer, the attenuation under this paragraph shall be 30 dB instead of 20 dB. In addition, radiated emissions which fall in the restricted bands must also comply with the limits as below.

Frequency (MHz)	Field Strength (microvolts/meter)	Measurement Distance (meters)
0.009 – 0.490	2400/F(kHz)	300
0.490 – 1.705	24000/F(kHz)	30
1.705 – 30.0	30	30
30 – 88	100	3
88 – 216	150	3
216 - 960	200	3
Above 960	500	3

3.5.2 Measuring Instruments

See list of measuring equipment of this test report.



3.5.3 Test Procedures

1. The testing follows the ANSI C63.10 Section 11.12.1 Radiated emission measurements.
2. The EUT was arranged to its worst case and then tune the antenna tower (from 1 m to 4 m) and turntable (from 0 degree to 360 degrees) to find the maximum reading. A pre-amp and a high pass filter are used for the test in order to get better signal level.
3. The EUT was placed on a turntable with 0.8 meter for frequency below 1GHz and 1.5 meter for frequency above 1GHz respectively above ground.
4. The EUT was set 3 meters from the interference receiving antenna, which was mounted on the top of a variable height antenna tower.
5. Corrected Reading: Antenna Factor + Cable Loss + Read Level - Preamp Factor = Level
6. For testing below 1GHz, if the emission level of the EUT in peak mode was 3 dB lower than the limit specified, then peak values of EUT will be reported, otherwise, the emissions will be repeated one by one using the CISPR quasi-peak method and reported.
7. For testing above 1GHz, the emission level of the EUT in peak mode was 20dB lower than average limit (that means the emission level in average mode also complies with the limit in average mode), then peak values of EUT will be reported, otherwise, the emissions will be measured in average mode again and reported.
8. Use the following spectrum analyzer settings:
 - (1) Span shall wide enough to fully capture the emission being measured;
 - (2) Set RBW=100 kHz for $f < 1$ GHz; $VBW \geq RBW$; Sweep = auto; Detector function = peak; Trace = max hold;
 - (3) Set RBW = 1 MHz, VBW= 3MHz for $f \geq 1$ GHz for peak measurement.
For average measurement:
 - $VBW = 10$ Hz, when duty cycle is no less than 98 percent.
 - $VBW \geq 1/T$, when duty cycle is less than 98 percent where T is the minimum transmission duration over which the transmitter is on and is transmitting at its maximum power control level for the tested mode of operation.

3.5.4 Test Setup

For radiated emissions below 30MHz

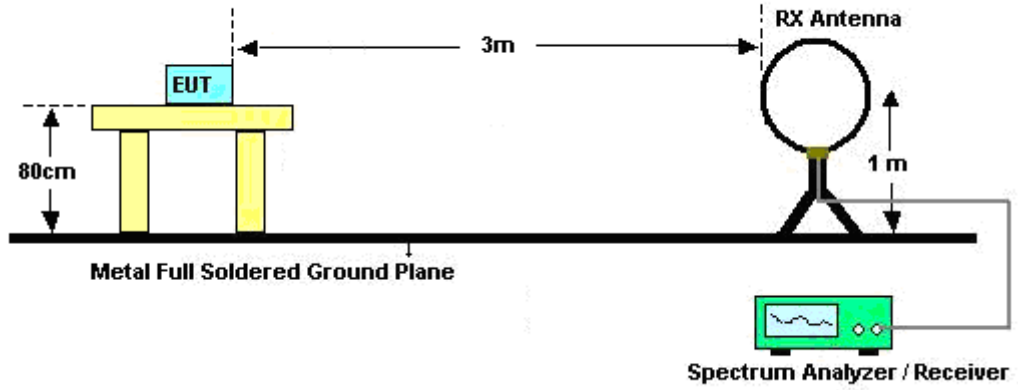

For radiated emissions from 30MHz to 1GHz

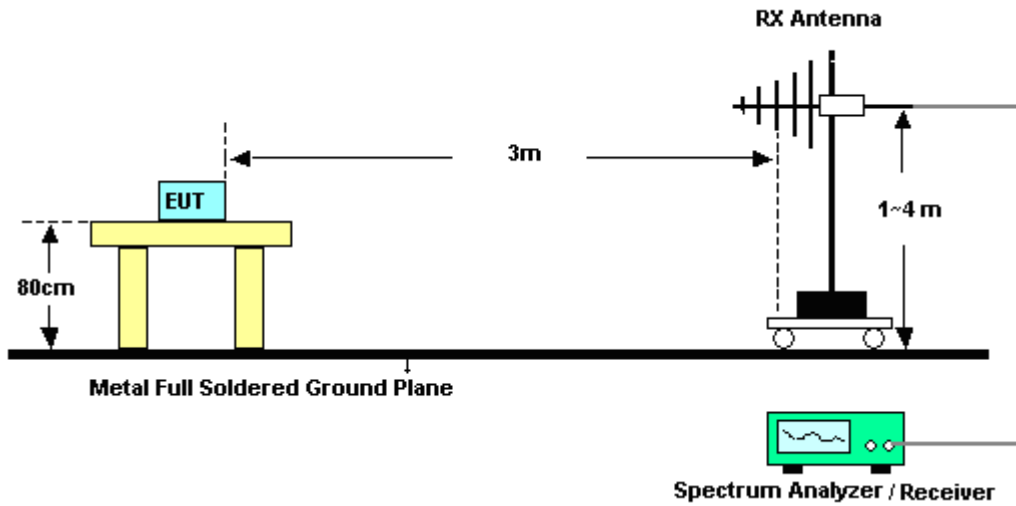

For radiated emissions above 1GHz

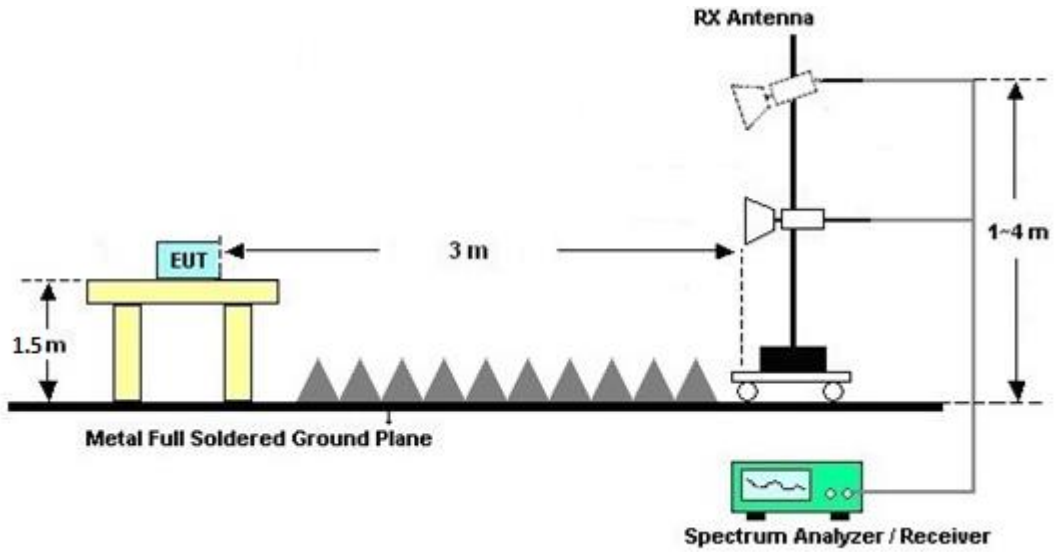

For radiated emissions above 18GHz

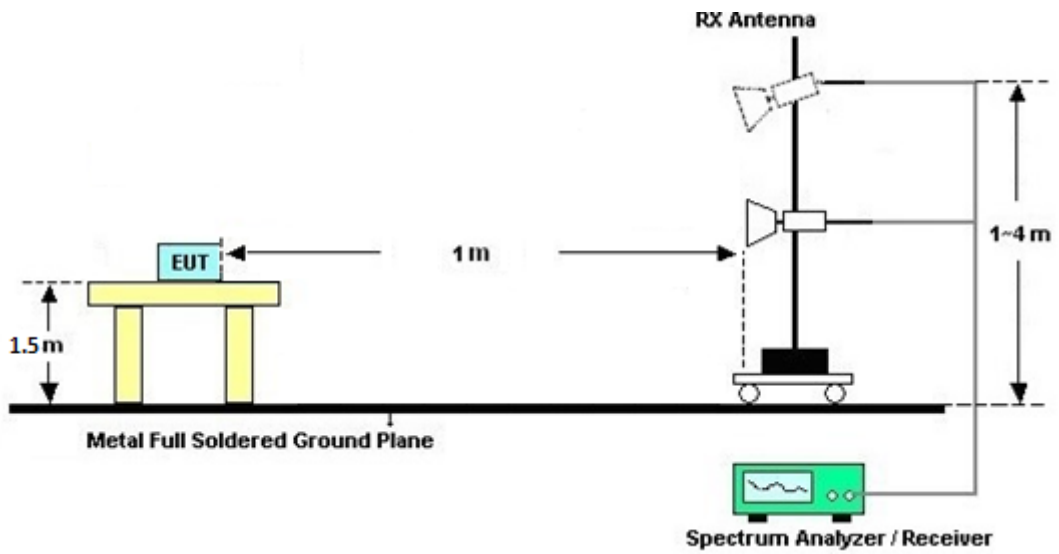



3.5.5 Test Results of Radiated Spurious Emissions (9kHz ~ 30MHz)

The low frequency, which started from 9 kHz to 30MHz, was pre-scanned and the result which was 20dB lower than the limit line was not reported.

There is a comparison data of both open-field test site and alternative test site - semi-Anechoic chamber according to 414788 D01 Radiated Test Site v01r01, and the result came out very similar.

3.5.6 Test Result of Radiated Spurious at Band Edges

Please refer to Appendix C and D.

3.5.7 Duty Cycle

Please refer to Appendix E.

3.5.8 Test Result of Radiated Spurious Emission (30MHz ~ 10th Harmonic)

Please refer to Appendix C and D.



3.6 AC Conducted Emission Measurement

3.6.1 Limit of AC Conducted Emission

For equipment that is designed to be connected to the public utility (AC) power line, the radio frequency voltage that is conducted back onto the AC power line on any frequency or frequencies within the band 150 kHz to 30 MHz shall not exceed the limits in the following table.

Frequency of Emission (MHz)	Conducted Limit (dB μ V)	
	Quasi-Peak	Average
0.15-0.5	66 to 56*	56 to 46*
0.5-5	56	46
5-30	60	50

*Decreases with the logarithm of the frequency.

3.6.2 Measuring Instruments

See list of measuring equipment of this test report.

3.6.3 Test Procedures

1. The EUT was placed 0.4 meter from the conducting wall of the shielding room, and it was kept at least 80 centimeters from any other grounded conducting surface.
2. Connect EUT to the power mains through a line impedance stabilization network (LISN).
3. All the support units are connecting to the other LISN.
4. The LISN provides 50 ohm coupling impedance for the measuring instrument.
5. The FCC states that a 50 ohm, 50 microhenry LISN should be used.
6. Both sides of AC line were checked for maximum conducted interference.
7. The frequency range from 150 kHz to 30 MHz was searched.
8. Set the test-receiver system to Peak Detect Function and specified bandwidth (IF bandwidth = 9kHz) with Maximum Hold Mode.

3.6.4 Test Setup



3.6.5 Test Result of AC Conducted Emission

Please refer to Appendix B.



3.7 Antenna Requirements

3.7.1 Standard Applicable

If directional gain of transmitting Antennas is greater than 6dBi, the power shall be reduced by the same level in dB comparing to gain minus 6dBi. The use of a permanently attached Antenna or of an Antenna that uses a unique coupling to the intentional radiator shall be considered sufficient to comply with the rule.

3.7.2 Antenna Anti-Replacement Construction

An embedded-in antenna design is used.

3.7.3 Antenna Gain

<CDD Modes >

FCC KDB 662911 D01 Multiple Transmitter Output v02r01

For CDD transmissions, directional gain is calculated as

Directional gain = G_{ANT} + Array Gain, where Array Gain is as follows.

For power spectral density (PSD) measurements on all devices,

Array Gain = $10 \log(N_{ANT}/N_{SS}=1)$ dB.

For power measurements on IEEE 802.11 devices,

Array Gain = 0 dB (i.e., no array gain) for $N_{ANT} \leq 4$.

Directional gain may be calculated by using the formulas applicable to equal gain antennas with G_{ANT} set equal to the gain of the antenna having the highest gain;

The EUT supports CDD mode.

For power, the directional gain G_{ANT} is set equal to the antenna having the highest gain, i.e., F)2)f)i).

For PSD, the directional gain calculation is following F)2)f)ii) of KDB 662911 D01 v02r01.

The power and PSD limit should be modified if the directional gain of EUT is over 6 dBi,

The directional gain "DG" is calculated as following table.

<CDD Modes>						
			DG	DG	Power	PSD
	Ant. 1	Ant. 2	for	for	Limit	Limit
	(dBi)	(dBi)	Power	PSD	Reduction	Reduction
			(dBi)	(dBi)	(dB)	(dB)
2.4 GHz	0.30	-0.30	0.30	3.02	0.00	0.00

$Power\ Limit\ Reduction = DG(Power) - 6dBi, (min = 0)$

$PSD\ Limit\ Reduction = DG(PSD) - 6dBi, (min = 0)$



4 List of Measuring Equipment

Instrument	Manufacturer	Model No.	Serial No.	Characteristics	Calibration Date	Test Date	Due Date	Remark
Loop Antenna	Rohde & Schwarz	HFH2-Z2	100488	9 kHz~30 MHz	Jan. 09, 2020	Jun. 19, 2020~ Jul. 16, 2020	Jan. 08, 2021	Radiation (03CH16-HY)
Bilog Antenna	TESEQ	CBL6111D&008 02N1D01N-06	47020&06	30MHz to 1GHz	Oct. 12, 2019	Jun. 19, 2020~ Jul. 16, 2020	Oct. 11, 2020	Radiation (03CH16-HY)
Horn Antenna	SCHWARZBE CK	BBHA 9120 D	9120D-152 2	1G~18GHz	Sep. 19, 2019	Jun. 19, 2020~ Jul. 16, 2020	Sep. 18, 2020	Radiation (03CH16-HY)
SHF-EHF Horn Antenna	SCHWARZBE CK	BBHA 9170	BBHA9170 980	18GHz~40GHz	Jan. 10, 2020	Jun. 19, 2020~ Jul. 16, 2020	Jan. 09, 2021	Radiation (03CH16-HY)
Amplifier	SONOMA	310N	371607	9kHz~1G	Oct. 01, 2019	Jun. 19, 2020~ Jul. 16, 2020	Sep. 30, 2020	Radiation (03CH16-HY)
Preamplifier	Jet-Power	JPA0118-55-303	171000180 0055006	1GHz~18GHz	May 07, 2020	Jun. 19, 2020~ Jul. 16, 2020	May 06, 2021	Radiation (03CH16-HY)
Preamplifier	EMEC	EM18G40G	060715	18GHz ~40GHz	Dec. 13, 2019	Jun. 19, 2020~ Jul. 16, 2020	Dec. 12, 2020	Radiation (03CH16-HY)
Preamplifier	Keysight	83017A	MY532702 64	1GHz~26.5GHz	Dec. 11, 2019	Jun. 19, 2020~ Jul. 16, 2020	Dec.10, 2020	Radiation (03CH16-HY)
EMI Test Receiver	Keysight	N9038A (MXE)	MY572901 11	3Hz~26.5GHz	Dec. 05, 2019	Jun. 19, 2020~ Jul. 16, 2020	Dec. 04, 2020	Radiation (03CH16-HY)
RF Cable	HUBER + SUHNER	SUCOFLEX 104	MY11680/4 PE	NA	Aug. 30, 2019	Jun. 19, 2020~ Jul. 16, 2020	Aug. 29, 2020	Radiation (03CH16-HY)
RF Cable	HUBER + SUHNER	SUCOFLEX 104	MY11688/4 PE	NA	Aug. 30, 2019	Jun. 19, 2020~ Jul. 16, 2020	Aug. 29, 2020	Radiation (03CH16-HY)
RF Cable	HUBER + SUHNER	SUCOFLEX 102	EC-A5-300 -5757	NA	Aug. 30, 2019	Jun. 19, 2020~ Jul. 16, 2020	Aug. 29, 2020	Radiation (03CH16-HY)
Hygrometer	TECPEL	DTM-303B	TP162965	N/A	Oct. 25, 2019	Jun. 19, 2020~ Jul. 16, 2020	Oct. 24, 2020	Radiation (03CH16-HY)
Software	Audix	E3 6.2009-8-24	RK-001136	N/A	N/A	Jun. 19, 2020~ Jul. 16, 2020	N/A	Radiation (03CH16-HY)
Controller	ChainTek	3000-1	N/A	Control Turn table & Ant Mast	N/A	Jun. 19, 2020~ Jul. 16, 2020	N/A	Radiation (03CH16-HY)
Antenna Mast	ChainTek	MBS-520-1	N/A	1m~4m	N/A	Jun. 19, 2020~ Jul. 16, 2020	N/A	Radiation (03CH16-HY)
Turn Table	ChainTek	T-200-S-1	N/A	0~360 Degree	N/A	Jun. 19, 2020~ Jul. 16, 2020	N/A	Radiation (03CH16-HY)



Instrument	Manufacturer	Model No.	Serial No.	Characteristics	Calibration Date	Test Date	Due Date	Remark
Hygrometer	Ji Zhan	HTC-1	2	N/A	Mar. 02, 2020	Jun. 21, 2020~ Jul. 30, 2020	Mar. 01, 2021	Conducted (TH05-HY)
Power Sensor	DARE	RPR3006W	16I00054SN O10	10MHz~6GHz	Dec. 23, 2019	Jun. 21, 2020~ Jul. 30, 2020	Dec. 22, 2020	Conducted (TH05-HY)
Spectrum Analyzer	Rohde & Schwarz	FSP40	100055	9kHz-40GHz	Aug. 14, 2019	Jun. 21, 2020~ Jul. 30, 2020	Aug. 13, 2020	Conducted (TH05-HY)
Switch Control Manframe	Burgeon	ETF-058	EC1300484	N/A	Aug. 22, 2019	Jun. 21, 2020~ Jul. 30, 2020	Aug. 21, 2020	Conducted (TH05-HY)
AC Power Source	ChainTek	APC-1000W	N/A	N/A	N/A	Jun. 19, 2020	N/A	Conduction (CO05-HY)
EMI Test Receiver	Rohde & Schwarz	ESR3	102388	9kHz~3.6GHz	Nov. 15, 2019	Jun. 19, 2020	Nov. 14, 2020	Conduction (CO05-HY)
Hygrometer	Testo	608-H1	34913912	N/A	Nov. 07, 2019	Jun. 19, 2020	Nov. 06, 2020	Conduction (CO05-HY)
LISN	Rohde & Schwarz	ENV216	100081	9kHz~30MHz	Nov. 15, 2019	Jun. 19, 2020	Nov. 14, 2020	Conduction (CO05-HY)
LISN	Rohde & Schwarz	ENV216	100081	9kHz~30MHz	Nov. 15, 2019	Jun. 19, 2020	Nov. 14, 2020	Conduction (CO05-HY)
Software	Rohde & Schwarz	EMC32 V10.30	N/A	N/A	N/A	Jun. 19, 2020	N/A	Conduction (CO05-HY)
LF Cable	HUBER + SUHNER	RG-214/U	LF01	N/A	Jan. 02, 2020	Jun. 19, 2020	Jan. 01, 2021	Conduction (CO05-HY)
Pulse Limiter	Rohde & Schwarz	ESH3-Z2	100851	N/A	Jan. 02, 2020	Jun. 19, 2020	Jan. 01, 2021	Conduction (CO05-HY)



5 Uncertainty of Evaluation

Uncertainty of Conducted Emission Measurement (150kHz ~ 30MHz)

Measuring Uncertainty for a Level of Confidence of 95% ($U = 2Uc(y)$)	2.3
---	-----

Uncertainty of Radiated Emission Measurement (30 MHz ~ 1000 MHz)

Measuring Uncertainty for a Level of Confidence of 95% ($U = 2Uc(y)$)	4.9
---	-----

Uncertainty of Radiated Emission Measurement (1000 MHz ~ 18000 MHz)

Measuring Uncertainty for a Level of Confidence of 95% ($U = 2Uc(y)$)	6.7
---	-----

Uncertainty of Radiated Emission Measurement (18000 MHz ~ 40000 MHz)

Measuring Uncertainty for a Level of Confidence of 95% ($U = 2Uc(y)$)	3.9
---	-----

Appendix A. Test Result of Conducted Test Items

Test Engineer:	Jacob Yu/Hank Hsu	Temperature:	21~25	°C
Test Date:	2020/6/21~7/30	Relative Humidity:	51~54	%

TEST RESULTS DATA
6dB and 99% Occupied Bandwidth

2.4GHz Band MIMO										
Mod.	Data Rate	N _{TX}	CH.	Freq. (MHz)	99% Occupied BW (MHz)		6dB BW (MHz)		6dB BW Limit (MHz)	Pass/Fail
					Ant 4	Ant 3	Ant 4	Ant 3		
11b	1Mbps	2	1	2412	14.10	13.80	8.56	8.54	0.50	Pass
11b	1Mbps	2	6	2437	14.10	13.90	8.06	8.00	0.50	Pass
11b	1Mbps	2	11	2462	14.20	14.00	8.56	9.04	0.50	Pass
11g	6Mbps	2	1	2412	16.80	16.75	15.08	15.42	0.50	Pass
11g	6Mbps	2	6	2437	16.80	16.70	16.06	15.14	0.50	Pass
11g	6Mbps	2	11	2462	16.80	16.80	15.74	16.04	0.50	Pass
HT20	MCS0	2	1	2412	17.95	17.90	15.28	15.12	0.50	Pass
HT20	MCS0	2	6	2437	17.95	17.90	16.66	15.64	0.50	Pass
HT20	MCS0	2	11	2462	18.00	18.00	16.10	17.52	0.50	Pass

TEST RESULTS DATA
Average Output Power

2.4GHz Band Single Antenna																
Mod.	Data Rate	N _{TX}	CH.	Freq. (MHz)	Average Conducted Power (dBm)			Conducted Power Limit (dBm)		DG (dBi)		EIRP Power (dBm)		EIRP Power Limit (dBm)		Pass /Fail
					Ant 4	Ant 3	SUM	Ant 4	Ant 3	Ant 4	Ant 3	Ant 4	Ant 3	Ant 4	Ant 3	
11b	1Mbps	1	1	2412	19.10	19.20		30.00	30.00	0.30	-0.30	19.40	18.90	36.00	36.00	Pass
11b	1Mbps	1	6	2437	19.00	18.70		30.00	30.00	0.30	-0.30	19.30	18.40	36.00	36.00	Pass
11b	1Mbps	1	11	2462	18.80	17.90		30.00	30.00	0.30	-0.30	19.10	17.60	36.00	36.00	Pass
11g	6Mbps	1	1	2412	15.20	15.20		30.00	30.00	0.30	-0.30	15.50	14.90	36.00	36.00	Pass
11g	6Mbps	1	2	2417	16.80	16.90		30.00	30.00	0.30	-0.30	17.10	16.60	36.00	36.00	Pass
11g	6Mbps	1	6	2437	19.00	18.60		30.00	30.00	0.30	-0.30	19.30	18.30	36.00	36.00	Pass
11g	6Mbps	1	10	2457	18.60	17.70		30.00	30.00	0.30	-0.30	18.90	17.40	36.00	36.00	Pass
11g	6Mbps	1	11	2462	16.20	15.80		30.00	30.00	0.30	-0.30	16.50	15.50	36.00	36.00	Pass
HT20	MCS0	1	1	2412	14.20	14.00		30.00	30.00	0.30	-0.30	14.50	13.70	36.00	36.00	Pass
HT20	MCS0	1	2	2417	16.60	16.70		30.00	30.00	0.30	-0.30	16.90	16.40	36.00	36.00	Pass
HT20	MCS0	1	6	2437	18.90	18.50		30.00	30.00	0.30	-0.30	19.20	18.20	36.00	36.00	Pass
HT20	MCS0	1	10	2457	18.40	17.40		30.00	30.00	0.30	-0.30	18.70	17.10	36.00	36.00	Pass
HT20	MCS0	1	11	2462	15.50	15.10		30.00	30.00	0.30	-0.30	15.80	14.80	36.00	36.00	Pass
VHT20	MCS0	1	1	2412	14.10	13.90		30.00	30.00	0.30	-0.30	14.40	13.60	36.00	36.00	Pass
VHT20	MCS0	1	2	2417	16.50	16.60		30.00	30.00	0.30	-0.30	16.80	16.30	36.00	36.00	Pass
VHT20	MCS0	1	6	2437	18.80	18.40		30.00	30.00	0.30	-0.30	19.10	18.10	36.00	36.00	Pass
VHT20	MCS0	1	10	2457	18.30	17.30		30.00	30.00	0.30	-0.30	18.60	17.00	36.00	36.00	Pass
VHT20	MCS0	1	11	2462	15.40	15.00		30.00	30.00	0.30	-0.30	15.70	14.70	36.00	36.00	Pass

2.4GHz Band MIMO																
Mod.	Data Rate	N _{TX}	CH.	Freq. (MHz)	Average Conducted Power (dBm)			Conducted Power Limit (dBm)		DG (dBi)		EIRP Power (dBm)		EIRP Power Limit (dBm)		Pass /Fail
					Ant 4	Ant 3	SUM	Ant 4	Ant 3	Ant 4	Ant 3	Ant 4	Ant 3	Ant 4	Ant 3	
11b	1Mbps	2	1	2412	19.50	19.40	22.46	30.00	30.00	0.30	0.30	22.76	22.51	36.00	36.00	Pass
11b	1Mbps	2	6	2437	19.40	19.00	22.21	30.00	30.00	0.30	0.30	22.51	22.02	36.00	36.00	Pass
11b	1Mbps	2	11	2462	19.00	18.40	21.72	30.00	30.00	0.30	0.30	22.02	21.43	36.00	36.00	Pass
11g	6Mbps	2	1	2412	15.50	15.60	18.56	30.00	30.00	0.30	0.30	18.86	18.37	36.00	36.00	Pass
11g	6Mbps	2	2	2417	17.20	17.30	20.26	30.00	30.00	0.30	0.30	20.56	20.07	36.00	36.00	Pass
11g	6Mbps	2	6	2437	19.40	19.00	22.21	30.00	30.00	0.30	0.30	22.51	22.02	36.00	36.00	Pass
11g	6Mbps	2	10	2457	18.80	18.00	21.43	30.00	30.00	0.30	0.30	21.73	21.24	36.00	36.00	Pass
11g	6Mbps	2	11	2462	16.30	15.90	19.11	30.00	30.00	0.30	0.30	19.41	19.11	36.00	36.00	Pass
HT20	MCS0	2	1	2412	14.60	14.50	17.56	30.00	30.00	0.30	0.30	17.86	17.76	36.00	36.00	Pass
HT20	MCS0	2	2	2417	17.00	17.10	20.06	30.00	30.00	0.30	0.30	20.36	20.26	36.00	36.00	Pass
HT20	MCS0	2	6	2437	19.30	18.90	22.11	30.00	30.00	0.30	0.30	22.41	22.31	36.00	36.00	Pass
HT20	MCS0	2	10	2457	18.60	17.80	21.23	30.00	30.00	0.30	0.30	21.53	21.43	36.00	36.00	Pass
HT20	MCS0	2	11	2462	15.50	15.20	18.36	30.00	30.00	0.30	0.30	18.66	18.56	36.00	36.00	Pass
VHT20	MCS0	2	1	2412	14.50	14.40	17.46	30.00	30.00	0.30	0.30	17.76	17.66	36.00	36.00	Pass
VHT20	MCS0	2	2	2417	16.90	17.00	19.96	30.00	30.00	0.30	0.30	20.26	20.16	36.00	36.00	Pass
VHT20	MCS0	2	6	2437	19.20	18.80	22.01	30.00	30.00	0.30	0.30	22.31	22.21	36.00	36.00	Pass
VHT20	MCS0	2	10	2457	18.50	17.70	21.13	30.00	30.00	0.30	0.30	21.43	21.33	36.00	36.00	Pass
VHT20	MCS0	2	11	2462	15.40	15.10	18.26	30.00	30.00	0.30	0.30	18.56	18.46	36.00	36.00	Pass

Note: Measured power (dBm) has offset with cable loss.

TEST RESULTS DATA
Peak Power Spectral Density

2.4GHz Band MIMO												
Mod.	Data Rate	N _{TX}	CH.	Freq. (MHz)	Peak PSD (dBm/3kHz)			DG (dBi)		Peak PSD Limit (dBm/3kHz)		Pass/Fail
					Ant 4	Ant 3	Worse + 3.01	Ant 4	Ant 3	Ant 4	Ant 3	
11b	1Mbps	2	1	2412	-4.13	-4.22	-1.12	3.02		8.00		Pass
11b	1Mbps	2	6	2437	-3.58	-4.39	-0.57	3.02		8.00		Pass
11b	1Mbps	2	11	2462	-5.19	-5.71	-2.18	3.02		8.00		Pass
11g	6Mbps	2	1	2412	-8.98	-9.98	-5.97	3.02		8.00		Pass
11g	6Mbps	2	2	2417	-6.79	-7.54	-3.78	3.02		8.00		Pass
11g	6Mbps	2	6	2437	-4.02	-6.83	-1.01	3.02		8.00		Pass
11g	6Mbps	2	10	2457	-6.64	-7.13	-3.63	3.02		8.00		Pass
11g	6Mbps	2	11	2462	-6.47	-9.70	-3.46	3.02		8.00		Pass
HT20	MCS0	2	1	2412	-8.34	-11.36	-5.33	3.02		8.00		Pass
HT20	MCS0	2	2	2417	-5.39	-6.56	-2.38	3.02		8.00		Pass
HT20	MCS0	2	6	2437	-5.62	-7.12	-2.61	3.02		8.00		Pass
HT20	MCS0	2	10	2457	-4.02	-7.09	-1.01	3.02		8.00		Pass
HT20	MCS0	2	11	2462	-8.90	-10.53	-5.89	3.02		8.00		Pass

Measured power density (dBm) has offset with cable loss.



Appendix B. AC Conducted Emission Test Results

Test Engineer :	Tom Lee	Temperature :	21~25°C
		Relative Humidity :	42~45%

EUT Information

Report NO : 050515
 Test Mode : Mode 1
 Test Voltage : 120Vac/60Hz
 Phase : Line

Full Spectrum

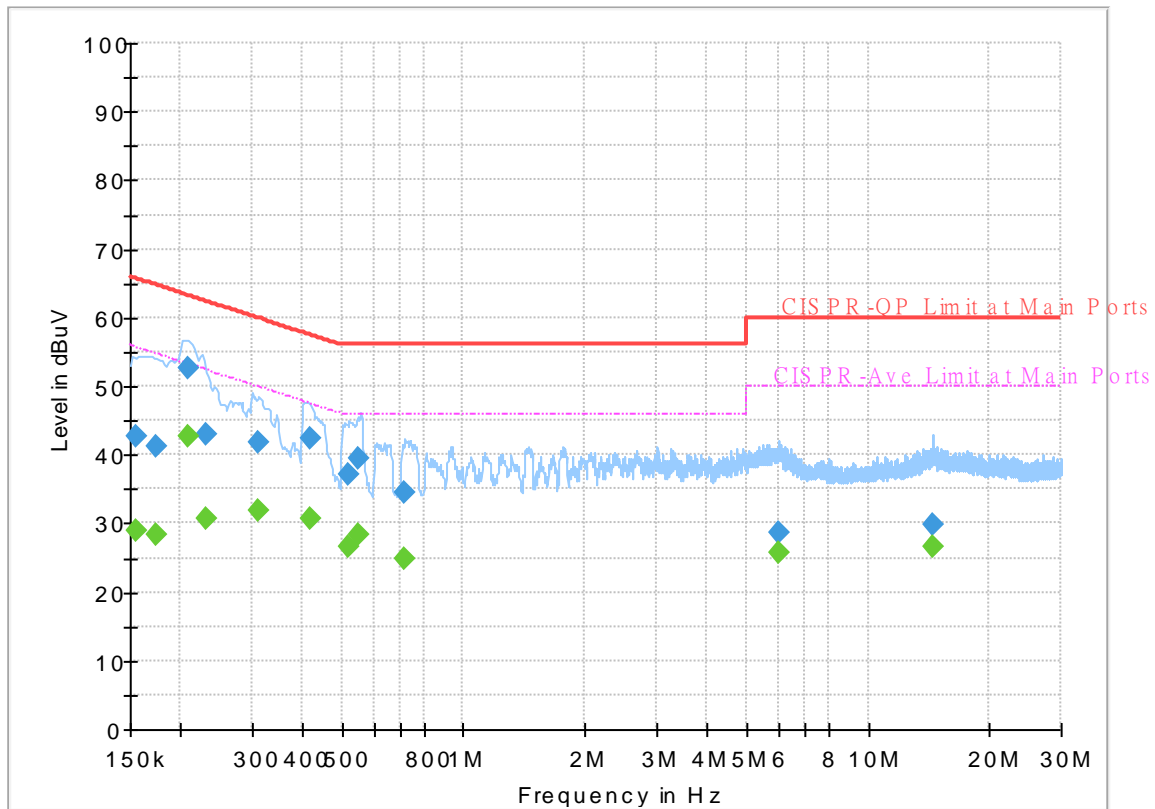

Final Result

Frequency (MHz)	QuasiPeak (dBuV)	CAverage (dBuV)	Limit (dBuV)	Margin (dB)	Line	Filter	Corr. (dB)
0.155760	---	28.93	55.69	26.76	L1	OFF	19.6
0.155760	42.58	---	65.69	23.11	L1	OFF	19.6
0.174750	---	28.46	54.73	26.27	L1	OFF	19.6
0.174750	41.28	---	64.73	23.45	L1	OFF	19.6
0.208500	---	42.55	53.27	10.72	L1	OFF	19.6
0.208500	52.49	---	63.27	10.78	L1	OFF	19.6
0.231000	---	30.75	52.41	21.66	L1	OFF	19.6
0.231000	42.88	---	62.41	19.53	L1	OFF	19.6
0.312360	---	31.74	49.91	18.17	L1	OFF	19.6
0.312360	41.75	---	59.91	18.16	L1	OFF	19.6
0.420000	---	30.84	47.45	16.61	L1	OFF	19.6
0.420000	42.39	---	57.45	15.06	L1	OFF	19.6
0.519000	---	26.63	46.00	19.37	L1	OFF	19.6
0.519000	37.09	---	56.00	18.91	L1	OFF	19.6
0.552750	---	28.50	46.00	17.50	L1	OFF	19.6
0.552750	39.43	---	56.00	16.57	L1	OFF	19.6
0.714030	---	24.78	46.00	21.22	L1	OFF	19.6
0.714030	34.40	---	56.00	21.60	L1	OFF	19.6
6.021060	---	25.73	50.00	24.27	L1	OFF	19.9
6.021060	28.69	---	60.00	31.31	L1	OFF	19.9
14.430750	---	26.48	50.00	23.52	L1	OFF	20.2
14.430750	29.90	---	60.00	30.10	L1	OFF	20.2

EUT Information

Report NO : 050515
 Test Mode : Mode 1
 Test Voltage : 120Vac/60Hz
 Phase : Neutral

Full Spectrum

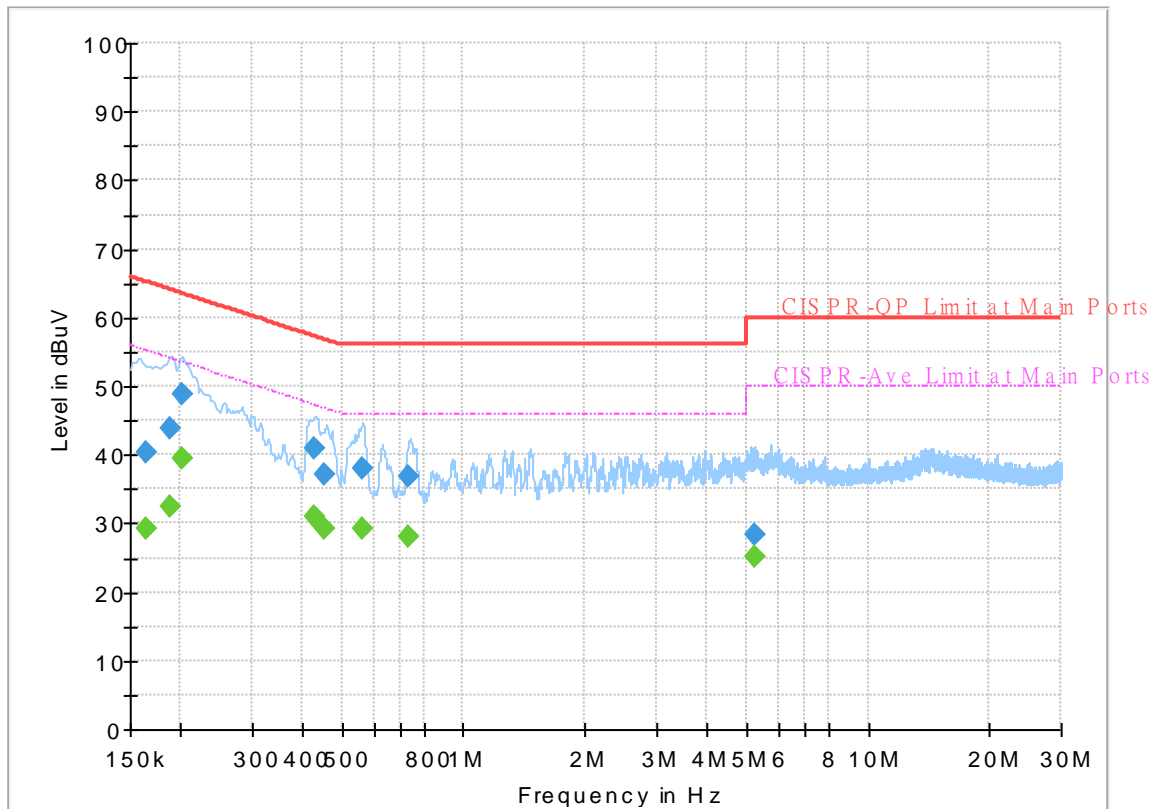

Final_Result

Frequency (MHz)	QuasiPeak (dBuV)	CAverage (dBuV)	Limit (dBuV)	Margin (dB)	Line	Filter	Corr. (dB)
0.163500	---	29.29	55.28	25.99	N	OFF	19.5
0.163500	40.32	---	65.28	24.96	N	OFF	19.5
0.188555	---	32.48	54.10	21.62	N	OFF	19.5
0.188555	43.88	---	64.10	20.22	N	OFF	19.5
0.201300	---	39.45	53.56	14.11	N	OFF	19.5
0.201300	48.87	---	63.56	14.69	N	OFF	19.5
0.429000	---	31.02	47.27	16.25	N	OFF	19.5
0.429000	41.02	---	57.27	16.25	N	OFF	19.5
0.453750	---	29.26	46.81	17.55	N	OFF	19.5
0.453750	37.07	---	56.81	19.74	N	OFF	19.5
0.561390	---	29.13	46.00	16.87	N	OFF	19.5
0.561390	37.93	---	56.00	18.07	N	OFF	19.5
0.735000	---	27.98	46.00	18.02	N	OFF	19.5
0.735000	36.90	---	56.00	19.10	N	OFF	19.5
5.241930	---	25.25	50.00	24.75	N	OFF	19.7
5.241930	28.31	---	60.00	31.69	N	OFF	19.7



Appendix C. Radiated Spurious Emission

Test Engineer :	Andy Yang, Karl Hou, and CR Laio	Temperature :	20~25°C
		Relative Humidity :	50~65%

2.4GHz 2400~2483.5MHz

WIFI 802.11b (Band Edge @ 3m)

WIFI Ant.	Note	Frequency (MHz)	Level (dBμV/m)	Over Limit (dB)	Limit Line (dBμV/m)	Read Level (dBμV)	Antenna Factor (dB/m)	Path Loss (dB)	Preamp Factor (dB)	Ant Pos (cm)	Table Pos (deg)	Peak Avg. (P/A)	Pol. (H/V)	
802.11b CH 01 2412MHz		2315.145	57.01	-16.99	74	40.85	27.94	17.97	29.75	101	59	P	H	
		2390	46.17	-7.83	54	30.22	27.64	18.09	29.78	101	59	A	H	
	*	2412	113.97	-	-	98.03	27.6	18.13	29.79	101	59	P	H	
	*	2412	111	-	-	95.06	27.6	18.13	29.79	101	59	A	H	
													H	
			2313.78	57.79	-16.21	74	41.63	27.94	17.97	29.75	100	59	P	V
			2387.49	47.42	-6.58	54	31.46	27.65	18.09	29.78	100	59	A	V
	*		2412	111.67	-	-	95.73	27.6	18.13	29.79	100	59	P	V
	*		2412	108.52	-	-	92.58	27.6	18.13	29.79	100	59	A	V
														V
802.11b CH 06 2437MHz		2334.22	56.66	-17.34	74	40.56	27.86	18	29.76	105	55	P	H	
		2389.94	45.65	-8.35	54	29.7	27.64	18.09	29.78	105	55	A	H	
	*	2437	114.9	-	-	98.93	27.6	18.17	29.8	105	55	P	H	
	*	2437	111.89	-	-	95.92	27.6	18.17	29.8	105	55	A	H	
			2490.06	56.84	-17.16	74	40.9	27.52	18.25	29.83	105	55	P	H
			2483.76	45.74	-8.26	54	29.79	27.53	18.24	29.82	105	55	A	H
			2312.8	56.35	-17.65	74	40.18	27.95	17.97	29.75	100	115	P	V
			2389.94	45.62	-8.38	54	29.67	27.64	18.09	29.78	100	115	A	V
	*		2437	110.22	-	-	94.25	27.6	18.17	29.8	100	115	P	V
	*		2437	106.91	-	-	90.94	27.6	18.17	29.8	100	115	A	V
			2492.93	56.29	-17.71	74	40.35	27.51	18.26	29.83	100	115	P	V
			2483.69	45.28	-8.72	54	29.33	27.53	18.24	29.82	100	115	A	V



802.11b CH 11 2462MHz	*	2462	114.58	-	-	98.6	27.58	18.21	29.81	100	57	P	H
	*	2462	111.5	-	-	95.52	27.58	18.21	29.81	100	57	A	H
		2484.04	57.18	-16.82	74	41.23	27.53	18.24	29.82	100	57	P	H
		2483.52	46.29	-7.71	54	30.34	27.53	18.24	29.82	100	57	A	H
													H
													H
	*	2462	110.62	-	-	94.64	27.58	18.21	29.81	100	121	P	V
	*	2462	107.2	-	-	91.22	27.58	18.21	29.81	100	121	A	V
		2484.32	56.87	-17.13	74	40.92	27.53	18.24	29.82	100	121	P	V
		2483.52	45.76	-8.24	54	29.81	27.53	18.24	29.82	100	121	A	V
													V
													V
Remark	1. No other spurious found. 2. All results are PASS against Peak and Average limit line.												



2.4GHz 2400~2483.5MHz

WIFI 802.11b (Harmonic @ 3m)

WIFI Ant.	Note	Frequency	Level	Over Limit	Limit Line	Read Level	Antenna Factor	Path Loss	Preamp Factor	Ant Pos	Table Pos	Peak Avg.	Pol.	
4+3		(MHz)	(dBμV/m)	(dB)	(dBμV/m)	(dBμV)	(dB/m)	(dB)	(dB)	(cm)	(deg)	(P/A)	(H/V)	
802.11b CH 01 2412MHz		4824	45.31	-28.69	74	60.82	31.15	12.43	59.09	100	0	P	H	
													H	
													H	
													H	
			4824	43.15	-30.85	74	58.66	31.15	12.43	59.09	100	0	P	V
														V
														V
802.11b CH 06 2437MHz		4874	44.61	-29.39	74	60.15	31.1	12.48	59.12	100	0	P	H	
		7311	51.36	-22.64	74	57.8	36.44	15.68	58.56	100	231	P	H	
		7311	44.37	-9.63	54	50.81	36.44	15.68	58.56	100	231	A	H	
													H	
			4874	44.77	-29.23	74	60.31	31.1	12.48	59.12	100	0	P	V
			7311	52.04	-21.96	74	58.48	36.44	15.68	58.56	100	78	P	V
			7311	46.04	-7.96	54	52.48	36.44	15.68	58.56	100	78	A	V
802.11b CH 11 2462MHz		4924	44.94	-29.06	74	60.47	31.1	12.52	59.15	100	0	P	H	
		7386	50.03	-23.97	74	56.3	36.53	15.66	58.46	100	230	P	H	
		7386	42.87	-11.13	54	49.14	36.53	15.66	58.46	100	230	A	H	
													H	
			4924	45.44	-28.56	74	60.97	31.1	12.52	59.15	100	0	P	V
			7386	50.61	-23.39	74	56.88	36.53	15.66	58.46	100	78	P	V
			7386	44.25	-9.75	54	50.52	36.53	15.66	58.46	100	78	A	V
Remark	1. No other spurious found.													
	2. All results are PASS against Peak and Average limit line.													



2.4GHz 2400~2483.5MHz

WIFI 802.11g (Band Edge @ 3m)

WIFI Ant.	Note	Frequency	Level	Over Limit	Limit Line	Read Level	Antenna Factor	Path Loss	Preamp Factor	Ant Pos	Table Pos	Peak Avg.	Pol.	
4+3		(MHz)	(dBµV/m)	(dB)	(dBµV/m)	(dBµV)	(dB/m)	(dB)	(dB)	(cm)	(deg)	(P/A)	(H/V)	
802.11g CH 01 2412MHz		2388.96	63.07	-10.93	74	47.12	27.64	18.09	29.78	100	58	P	H	
		2389.065	52.35	-1.65	54	36.4	27.64	18.09	29.78	100	58	A	H	
	*	2412	112.31	-	-	96.37	27.6	18.13	29.79	100	58	P	H	
	*	2414	104.39	-	-	88.45	27.6	18.13	29.79	100	58	A	H	
													H	
													H	
			2390	61.86	-12.14	74	45.91	27.64	18.09	29.78	159	110	P	V
			2390	52.46	-1.54	54	36.51	27.64	18.09	29.78	159	110	A	V
	*		2412	112.46	-	-	96.52	27.6	18.13	29.79	159	110	P	V
	*		2412	104.06	-	-	88.12	27.6	18.13	29.79	159	110	A	V
														V
														V
802.11g CH 06 2437MHz		2389.94	57.86	-16.14	74	41.91	27.64	18.09	29.78	100	64	P	H	
		2389.66	47.93	-6.07	54	31.98	27.64	18.09	29.78	100	64	A	H	
	*	2437	115.65	-	-	99.68	27.6	18.17	29.8	100	64	P	H	
	*	2437	107.65	-	-	91.68	27.6	18.17	29.8	100	64	A	H	
			2496.85	56.98	-17.02	74	41.04	27.51	18.26	29.83	100	64	P	H
			2483.9	47.48	-6.52	54	31.53	27.53	18.24	29.82	100	64	A	H
			2387.98	57.51	-16.49	74	41.55	27.65	18.09	29.78	100	110	P	V
			2389.24	47.98	-6.02	54	32.03	27.64	18.09	29.78	100	110	A	V
	*		2437	114.77	-	-	98.8	27.6	18.17	29.8	100	110	P	V
	*		2437	107.53	-	-	91.56	27.6	18.17	29.8	100	110	A	V
			2484.88	58.1	-15.9	74	42.14	27.53	18.25	29.82	100	110	P	V
			2483.76	47.5	-6.5	54	31.55	27.53	18.24	29.82	100	110	A	V



802.11g CH 11 2462MHz	*	2462	113.44	-	-	97.46	27.58	18.21	29.81	100	56	P	H
	*	2462	105.93	-	-	89.95	27.58	18.21	29.81	100	56	A	H
		2485.44	61.48	-12.52	74	45.52	27.53	18.25	29.82	100	56	P	H
		2483.52	52.14	-1.86	54	36.19	27.53	18.24	29.82	100	56	A	H
													H
													H
	*	2462	112.78	-	-	96.8	27.58	18.21	29.81	100	112	P	V
	*	2462	105.53	-	-	89.55	27.58	18.21	29.81	100	112	A	V
		2484.4	63.76	-10.24	74	47.8	27.53	18.25	29.82	100	112	P	V
		2483.92	52.17	-1.83	54	36.22	27.53	18.24	29.82	100	112	A	V
													V
													V
Remark	1. No other spurious found. 2. All results are PASS against Peak and Average limit line.												



WIFI Ant.	Note	Frequency	Level	Over Limit	Limit Line	Read Level	Antenna Factor	Path Loss	Preamp Factor	Ant Pos	Table Pos	Peak Avg.	Pol.	
4+3		(MHz)	(dBμV/m)	(dB)	(dBμV/m)	(dBμV)	(dB/m)	(dB)	(dB)	(cm)	(deg)	(P/A)	(H/V)	
802.11g CH 02 2417MHz		2389.91	60.49	-13.51	74	44.54	27.64	18.09	29.78	111	54	P	H	
		2389.8	51.2	-2.8	54	35.25	27.64	18.09	29.78	111	54	A	H	
	*	2417	114.25	-	-	98.31	27.6	18.14	29.8	111	54	P	H	
	*	2417	106.76	-	-	90.82	27.6	18.14	29.8	111	54	A	H	
													H	
													H	
			2389.28	61.17	-12.83	74	45.22	27.64	18.09	29.78	100	97	P	V
			2389.17	51.23	-2.77	54	35.28	27.64	18.09	29.78	100	97	A	V
	*		2417	113.02	-	-	97.08	27.6	18.14	29.8	100	97	P	V
	*		2417	105.73	-	-	89.79	27.6	18.14	29.8	100	97	A	V
													V	
													V	
802.11g CH 10 2457MHz	*	2457	115.01	-	-	99.03	27.59	18.20	29.81	100	55	P	H	
	*	2457	107.68	-	-	91.7	27.59	18.20	29.81	100	55	A	H	
		2483.8	61.39	-12.61	74	45.44	27.53	18.24	29.82	100	55	P	H	
		2483.5	51.52	-2.48	54	35.57	27.53	18.24	29.82	100	55	A	H	
													H	
													H	
	*	2457	115.69	-	-	99.71	27.59	18.20	29.81	100	110	P	V	
	*	2457	107.79	-	-	91.81	27.59	18.20	29.81	100	110	A	V	
		2485.18	60.95	-13.05	74	44.99	27.53	18.25	29.82	100	110	P	V	
		2484.28	50.82	-3.18	54	34.87	27.53	18.24	29.82	100	110	A	V	
												V		
												V		
Remark	1. No other spurious found. 2. All results are PASS against Peak and Average limit line.													



2.4GHz 2400~2483.5MHz

WIFI 802.11g (Harmonic @ 3m)

WIFI Ant.	Note	Frequency	Level	Over Limit	Limit Line	Read Level	Antenna Factor	Path Loss	Preamp Factor	Ant Pos	Table Pos	Peak Avg.	Pol.	
4+3		(MHz)	(dBμV/m)	(dB)	(dBμV/m)	(dBμV)	(dB/m)	(dB)	(dB)	(cm)	(deg)	(P/A)	(H/V)	
802.11g CH 01 2412MHz		4824	40.75	-33.25	74	56.26	31.15	12.43	59.09	100	0	P	H	
													H	
													H	
													H	
			4824	41.12	-32.88	74	56.63	31.15	12.43	59.09	100	0	P	V
														V
														V
802.11g CH 06 2437MHz		4874	41.19	-32.81	74	56.73	31.1	12.48	59.12	100	0	P	H	
		7311	52.13	-21.87	74	58.57	36.44	15.68	58.56	100	228	P	H	
		7311	40.53	-13.47	54	46.97	36.44	15.68	58.56	100	228	A	H	
													H	
			4874	43.66	-30.34	74	59.2	31.1	12.48	59.12	100	0	P	V
			7311	52.1	-21.9	74	58.54	36.44	15.68	58.56	100	198	P	V
			7311	41.58	-12.42	54	48.02	36.44	15.68	58.56	100	198	A	V
802.11g CH 11 2462MHz		4924	41.47	-32.53	74	57	31.1	12.52	59.15	100	0	P	H	
		7386	46.79	-27.21	74	53.06	36.53	15.66	58.46	100	0	P	H	
													H	
													H	
			4924	40.7	-33.3	74	56.23	31.1	12.52	59.15	100	0	P	V
			7386	45.61	-28.39	74	51.88	36.53	15.66	58.46	100	0	P	V
														V
Remark	1. No other spurious found.													
	2. All results are PASS against Peak and Average limit line.													



2.4GHz 2400~2483.5MHz

WIFI 802.11n HT20 (Band Edge @ 3m)

WIFI Ant.	Note	Frequency	Level	Over Limit	Limit Line	Read Level	Antenna Factor	Path Loss	Preamp Factor	Ant Pos	Table Pos	Peak Avg.	Pol.	
4+3		(MHz)	(dBμV/m)	(dB)	(dBμV/m)	(dBμV)	(dB/m)	(dB)	(dB)	(cm)	(deg)	(P/A)	(H/V)	
802.11n HT20 CH 01 2412MHz		2387.07	57.99	-16.01	74	42.03	27.65	18.09	29.78	100	53	P	H	
		2390	49.04	-4.96	54	33.09	27.64	18.09	29.78	100	53	A	H	
	*	2412	110.99	-	-	95.05	27.6	18.13	29.79	100	53	P	H	
	*	2412	102.87	-	-	86.93	27.6	18.13	29.79	100	53	A	H	
													H	
													H	
			2389.905	63.11	-10.89	74	47.16	27.64	18.09	29.78	100	110	P	V
			2390	52.2	-1.8	54	36.25	27.64	18.09	29.78	100	110	A	V
	*		2412	109.28	-	-	93.34	27.6	18.13	29.79	100	110	P	V
	*		2412	101.22	-	-	85.28	27.6	18.13	29.79	100	110	A	V
													V	
													V	
802.11n HT20 CH 06 2437MHz		2387.28	58.36	-15.64	74	42.4	27.65	18.09	29.78	102	55	P	H	
		2389.38	48.72	-5.28	54	32.77	27.64	18.09	29.78	102	55	A	H	
	*	2437	116.77	-	-	100.8	27.6	18.17	29.8	102	55	P	H	
	*	2437	109.23	-	-	93.26	27.6	18.17	29.8	102	55	A	H	
			2483.9	58.74	-15.26	74	42.79	27.53	18.24	29.82	102	55	P	H
			2483.5	48.5	-5.5	54	32.55	27.53	18.24	29.82	102	55	A	H
			2386.16	57.92	-16.08	74	41.95	27.66	18.09	29.78	124	88	P	V
			2389.1	48.04	-5.96	54	32.09	27.64	18.09	29.78	124	88	A	V
	*		2437	114.55	-	-	98.58	27.6	18.17	29.8	124	88	P	V
	*		2437	106.9	-	-	90.93	27.6	18.17	29.8	124	88	A	V
		2484.18	57.75	-16.25	74	41.8	27.53	18.24	29.82	124	88	P	V	
		2483.5	48.14	-5.86	54	32.19	27.53	18.24	29.82	124	88	A	V	



802.11n HT20 CH 11 2462MHz	*	2462	112.54	-	-	96.56	27.58	18.21	29.81	100	56	P	H
	*	2462	104.87	-	-	88.89	27.58	18.21	29.81	100	56	A	H
		2484.64	59.2	-14.8	74	43.24	27.53	18.25	29.82	100	56	P	H
		2483.64	50.11	-3.89	54	34.16	27.53	18.24	29.82	100	56	A	H
													H
													H
	*	2462	112.08	-	-	96.1	27.58	18.21	29.81	100	112	P	V
	*	2462	104.71	-	-	88.73	27.58	18.21	29.81	100	112	A	V
		2484.08	61.74	-12.26	74	45.79	27.53	18.24	29.82	100	112	P	V
		2483.52	51.71	-2.29	54	35.76	27.53	18.24	29.82	100	112	A	V
													V
													V
Remark	1. No other spurious found. 2. All results are PASS against Peak and Average limit line.												



WIFI	Note	Frequency	Level	Over	Limit	Read	Antenna	Path	Preamp	Ant	Table	Peak	Pol.	
Ant. 4+3		(MHz)	(dBµV/m)	(dB)	(dBµV/m)	(dBµV)	Factor (dB/m)	Loss (dB)	Factor (dB)	Pos (cm)	Pos (deg)	Avg. (P/A)	(H/V)	
802.11n HT20 CH 02 2417MHz		2389.7	62.17	-11.83	74	46.22	27.64	18.09	29.78	111	57	P	H	
		2390	50.92	-3.08	54	34.97	27.64	18.09	29.78	111	57	A	H	
	*	2417	112.02	-	-	96.08	27.6	18.14	29.8	111	57	P	H	
	*	2417	104.12	-	-	88.18	27.6	18.14	29.8	111	57	A	H	
													H	
													H	
			2388.44	57.92	-16.08	74	41.96	27.65	18.09	29.78	101	101	P	V
			2388.65	48.62	-5.38	54	32.66	27.65	18.09	29.78	101	101	A	V
		*	2417	112.36	-	-	96.42	27.6	18.14	29.8	101	101	P	V
		*	2417	105.03	-	-	89.09	27.6	18.14	29.8	101	101	A	V
													V	
													V	
802.11n HT20 CH 10 2457MHz	*	2457	114.56	-	-	98.58	27.59	18.20	29.81	109	57	P	H	
	*	2457	107.15	-	-	91.17	27.59	18.20	29.81	109	57	A	H	
		2483.64	61.93	-12.07	74	45.98	27.53	18.24	29.82	109	57	P	H	
		2483.56	52.01	-1.99	54	36.06	27.53	18.24	29.82	109	57	A	H	
													H	
													H	
		*	2457	114.18	-	-	98.2	27.59	18.20	29.81	100	95	P	V
		*	2457	106.92	-	-	90.94	27.59	18.20	29.81	100	95	A	V
			2484.24	60.9	-13.1	74	44.95	27.53	18.24	29.82	100	95	P	V
			2483.64	50.47	-3.53	54	34.52	27.53	18.24	29.82	100	95	A	V
													V	
													V	
Remark	1. No other spurious found. 2. All results are PASS against Peak and Average limit line.													



2.4GHz 2400~2483.5MHz

WIFI 802.11n HT20 (Harmonic @ 3m)

WIFI Ant.	Note	Frequency	Level	Over Limit	Limit Line	Read Level	Antenna Factor	Path Loss	Preamp Factor	Ant Pos	Table Pos	Peak Avg.	Pol.	
4+3		(MHz)	(dBμV/m)	(dB)	(dBμV/m)	(dBμV)	(dB/m)	(dB)	(dB)	(cm)	(deg)	(P/A)	(H/V)	
802.11n HT20 CH 01 2412MHz		4824	40.8	-33.2	74	56.31	31.15	12.43	59.09	100	0	P	H	
													H	
													H	
													H	
			4824	41.35	-32.65	74	56.86	31.15	12.43	59.09	100	0	P	V
														V
														V
802.11n HT20 CH 06 2437MHz		4874	41.24	-32.76	74	56.78	31.1	12.48	59.12	100	0	P	H	
		7311	52.52	-21.48	74	58.96	36.44	15.68	58.56	100	233	P	H	
		7311	39.78	-14.22	54	46.22	36.44	15.68	58.56	100	233	A	H	
													H	
			4874	44.46	-29.54	74	60	31.1	12.48	59.12	100	0	P	V
			7311	52.57	-21.43	74	59.01	36.44	15.68	58.56	100	189	P	V
			7311	40.48	-13.52	54	46.92	36.44	15.68	58.56	100	189	A	V
802.11n HT20 CH 11 2462MHz		4924	41.05	-32.95	74	56.58	31.1	12.52	59.15	100	0	P	H	
		7386	45.4	-28.6	74	51.67	36.53	15.66	58.46	100	0	P	H	
													H	
													H	
			4924	40.38	-33.62	74	55.91	31.1	12.52	59.15	100	0	P	V
			7386	45.98	-28.02	74	52.25	36.53	15.66	58.46	100	0	P	V
														V
Remark	1. No other spurious found.													
	2. All results are PASS against Peak and Average limit line.													



Emission above 18GHz

2.4GHz WIFI 802.11g (SHF)

WIFI Ant.	Note	Frequency	Level	Over Limit	Limit Line	Read Level	Antenna Factor	Path Loss	Preamp Factor	Ant Pos	Table Pos	Peak Avg.	Pol.	
4+3		(MHz)	(dBμV/m)	(dB)	(dBμV/m)	(dBμV)	(dB/m)	(dB)	(dB)	(cm)	(deg)	(P/A)	(H/V)	
2.4GHz 802.11g SHF		19113	39.28	-34.72	74	44.58	38.01	11.02	54.33	150	0	P	H	
													H	
													H	
													H	
													H	
													H	
			20954	40.38	-33.62	74	43.38	38.36	12.05	53.41	150	0	P	V
														V
														V
														V
														V
Remark	1. No other spurious found. 2. All results are PASS against limit line.													



Emission below 1GHz
2.4GHz WIFI 802.11g (LF)

WIFI Ant.	Note	Frequency	Level	Over Limit	Limit Line	Read Level	Antenna Factor	Path Loss	Preamp Factor	Ant Pos	Table Pos	Peak Avg.	Pol.	
4+3		(MHz)	(dBμV/m)	(dB)	(dBμV/m)	(dBμV)	(dB/m)	(dB)	(dB)	(cm)	(deg)	(P/A)	(H/V)	
2.4GHz 802.11g LF		33.88	24.64	-15.36	40	33.26	22.65	0.97	32.24	-	-	P	H	
		163.86	24.52	-18.98	43.5	38.44	16.1	2.27	32.29	-	-	P	H	
		193.93	28.17	-15.33	43.5	43.38	14.7	2.41	32.32	-	-	P	H	
		260.86	23.76	-22.24	46	33.18	20.09	2.83	32.34	-	-	P	H	
		563.5	28.28	-17.72	46	30.05	26.14	4.07	31.98	-	-	P	H	
		824.43	33.84	-12.16	46	32.95	28.2	4.95	32.26	100	0	P	H	
														H
														H
														H
														H
														H
														H
			32.91	31.93	-8.07	40	40.21	22.99	0.96	32.23	100	0	P	V
			76.56	24.43	-15.57	40	42.49	12.8	1.47	32.33	-	-	P	V
			181.32	26.53	-16.97	43.5	41.65	14.84	2.35	32.31	-	-	P	V
			264.74	20.91	-25.09	46	30.37	20.04	2.85	32.35	-	-	P	V
			736.16	30.63	-15.37	46	30.32	27.88	4.66	32.23	-	-	P	V
			824.43	35.13	-10.87	46	34.24	28.2	4.95	32.26	-	-	P	V
														V
														V
													V	
													V	
													V	
													V	
Remark	1. No other spurious found. 2. All results are PASS against limit line.													



Note symbol

*	Fundamental Frequency which can be ignored. However, the level of any unwanted emissions shall not exceed the level of the fundamental frequency.
!	Test result is over limit line.
P/A	Peak or Average
H/V	Horizontal or Vertical



A calculation example for radiated spurious emission is shown as below:

WIFI	Note	Frequency	Level	Over	Limit	Read	Antenna	Path	Preamp	Ant	Table	Peak	Pol.
Ant.				Limit	Line	Level	Factor	Loss	Factor	Pos	Pos	Avg.	
4+3		(MHz)	(dBμV/m)	(dB)	(dBμV/m)	(dBμV)	(dB/m)	(dB)	(dB)	(cm)	(deg)	(P/A)	(H/V)
802.11b		2390	55.45	-18.55	74	54.51	32.22	4.58	35.86	103	308	P	H
CH 01		2390	43.54	-10.46	54	42.6	32.22	4.58	35.86	103	308	A	H
2412MHz													

1. Path Loss(dB) = Cable loss(dB) + Filter loss(dB) + Attenuator loss(dB)
2. Level(dBμV/m) =
Antenna Factor(dB/m) + Path Loss(dB) + Read Level(dBμV) - Preamp Factor(dB)
3. Over Limit(dB) = Level(dBμV/m) – Limit Line(dBμV/m)

For Peak Limit @ 2390MHz:

1. Level(dBμV/m)
= Antenna Factor(dB/m) + Path Loss(dB) + Read Level(dBμV) - Preamp Factor(dB)
= 32.22(dB/m) + 4.58(dB) + 54.51(dBμV) – 35.86 (dB)
= 55.45 (dBμV/m)
2. Over Limit(dB)
= Level(dBμV/m) – Limit Line(dBμV/m)
= 55.45(dBμV/m) – 74(dBμV/m)
= -18.55(dB)

For Average Limit @ 2390MHz:

1. Level(dBμV/m)
= Antenna Factor(dB/m) + Path Loss(dB) + Read Level(dBμV) - Preamp Factor(dB)
= 32.22(dB/m) + 4.58(dB) + 42.6(dBμV) – 35.86 (dB)
= 43.54 (dBμV/m)
2. Over Limit(dB)
= Level(dBμV/m) – Limit Line(dBμV/m)
= 43.54(dBμV/m) – 54(dBμV/m)
= -10.46(dB)

Both peak and average measured complies with the limit line, so test result is “PASS”.



Appendix D. Radiated Spurious Emission Plots

Test Engineer :	Andy Yang, Karl Hou, and CR Laio	Temperature :	20~25°C
		Relative Humidity :	50~65%

Note symbol

-L	Low channel location
-R	High channel location



2.4GHz 2400~2483.5MHz
WIFI 802.11b (Band Edge @ 3m)

WIFI	2.4GHz 2400~2483.5MHz Band Edge @ 3m	
ANT	802.11b CH01 2412MHz	
4+3	Horizontal	Fundamental
Peak	<p>Site : 03CH16-HY Condition : PEAK_BE_74 3m 91200_1522 HORIZONTAL RBW:1000.000KHz VBW:3000.000KHz SWT:Auto Detector : Peak Project : 050515</p>	<p>Site : 03CH16-HY Condition : PEAK_74 3m 91200_1522 HORIZONTAL RBW:1000.000KHz VBW:3000.000KHz SWT:Auto Detector : Peak Project : 050515</p>
Avg.	<p>Site : 03CH16-HY Condition : AVG_BE_54 3m 91200_1522 HORIZONTAL RBW:1000.000KHz VBW:0.010KHz SWT:Auto Detector : Peak Project : 050515</p>	<p>Site : 03CH16-HY Condition : AVG_54 3m 91200_1522 HORIZONTAL RBW:1000.000KHz VBW:0.010KHz SWT:Auto Detector : Peak Project : 050515</p>

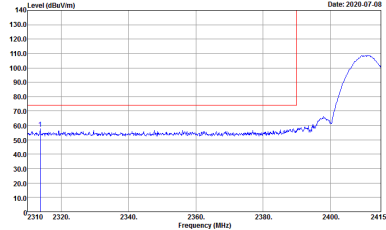
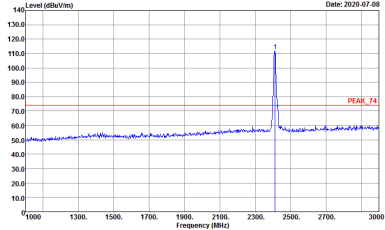
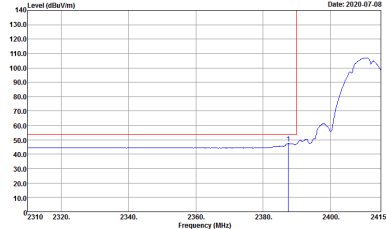
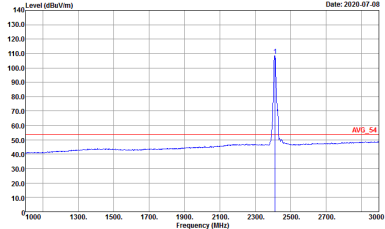

WIFI	2.4GHz 2400~2483.5MHz Band Edge @ 3m	
ANT	802.11b CH01 2412MHz	
4+3	Vertical	Fundamental
<p>Peak</p>	 <p>Site : 03CH16-HY Condition : PEAK_BE_74 3m 91200_1522 VERTICAL RBW:1000.000kHz VBW:3000.000kHz SWT:Auto Detector : Peak Project : 050515</p>	 <p>Site : 03CH16-HY Condition : PEAK_74 3m 91200_1522 VERTICAL RBW:1000.000kHz VBW:3000.000kHz SWT:Auto Detector : Peak Project : 050515</p>
<p>Avg.</p>	 <p>Site : 03CH16-HY Condition : AVG_BE_54 3m 91200_1522 VERTICAL RBW:1000.000kHz VBW:0.010kHz SWT:Auto Detector : Peak Project : 050515</p>	 <p>Site : 03CH16-HY Condition : AVG_54 3m 91200_1522 VERTICAL RBW:1000.000kHz VBW:0.010kHz SWT:Auto Detector : Peak Project : 050515</p>

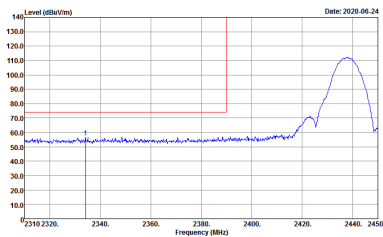
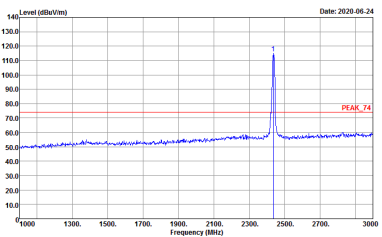
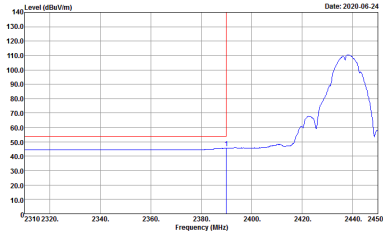
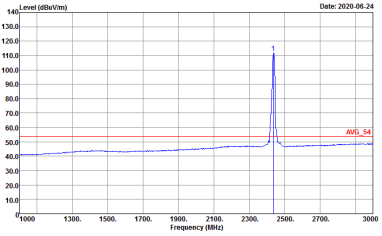

WIFI	2.4GHz 2400~2483.5MHz Band Edge @ 3m	
ANT	802.11b CH06 2437MHz - L	
4+3	Horizontal	Fundamental
Peak	 <p>Site : 03CH16-HY Condition : PEAK_BE_74 3m 91200_1522 HORIZONTAL : RBW:1000.000kHz VBW:3000.000kHz SWT:Auto Detector : Peak Project : 050515</p>	 <p>Site : 03CH16-HY Condition : PEAK_74 3m 91200_1522 HORIZONTAL : RBW:1000.000kHz VBW:3000.000kHz SWT:Auto Detector : Peak Project : 050515</p>
Avg.	 <p>Site : 03CH16-HY Condition : AVG_BE_54 3m 91200_1522 HORIZONTAL : RBW:1000.000kHz VBW:0.010kHz SWT:Auto Detector : Peak Project : 050515</p>	 <p>Site : 03CH16-HY Condition : AVG_54 3m 91200_1522 HORIZONTAL : RBW:1000.000kHz VBW:0.010kHz SWT:Auto Detector : Peak Project : 050515</p>

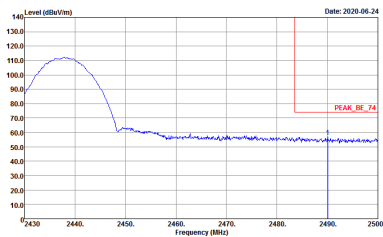
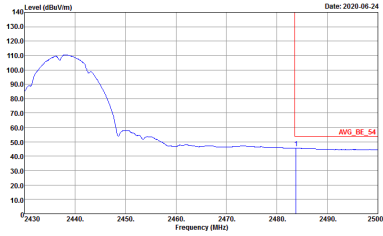

WIFI	2.4GHz 2400~2483.5MHz Band Edge @ 3m	
ANT	802.11b CH06 2437MHz - R	
4+3	Horizontal	Fundamental
Peak	 <p>Site : 03CH16-HY Condition : PEAK_BE_74 3m 91200_1522 HORIZONTAL Detector : Peak Project : 050515</p>	Left blank
Avg.	 <p>Site : 03CH16-HY Condition : AVG_BE_54 3m 91200_1522 HORIZONTAL Detector : Peak Project : 050515</p>	Left blank



WIFI	2.4GHz 2400~2483.5MHz Band Edge @ 3m	
ANT	802.11b CH06 2437MHz - L	
4+3	Vertical	Fundamental
Peak	<p>Site : 03CH16-HY Condition : PEAK_BE_74 3m 91200_1522 VERTICAL Detector : Peak Project : 050515</p>	<p>Site : 03CH16-HY Condition : PEAK_74 3m 91200_1522 VERTICAL Detector : Peak Project : 050515</p>
Avg.	<p>Site : 03CH16-HY Condition : AVG_BE_54 3m 91200_1522 VERTICAL Detector : Peak Project : 050515</p>	<p>Site : 03CH16-HY Condition : AVG_54 3m 91200_1522 VERTICAL Detector : Peak Project : 050515</p>

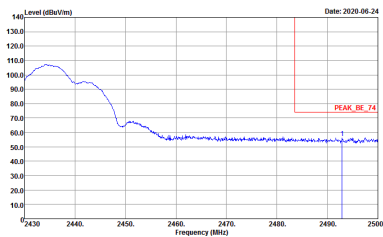
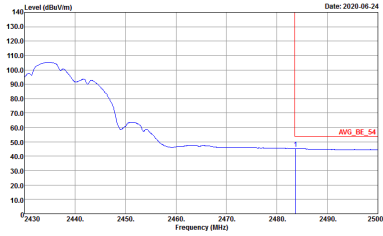

WIFI	2.4GHz 2400~2483.5MHz Band Edge @ 3m	
ANT	802.11b CH06 2437MHz - R	
4+3	Vertical	Fundamental
Peak	 <p>Site : 03CH16-HY Condition : PEAK_BE_74 3m 91200_1522 VERTICAL Detector : RBW:1000.000kHz VBW:3000.000kHz SWF:Auto Project : 050515</p>	Left blank
Avg.	 <p>Site : 03CH16-HY Condition : AVG_BE_54 3m 91200_1522 VERTICAL Detector : RBW:1000.000kHz VBW:3.010kHz SWF:Auto Project : 050515</p>	Left blank

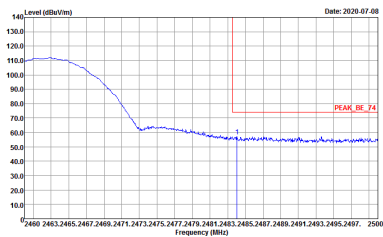
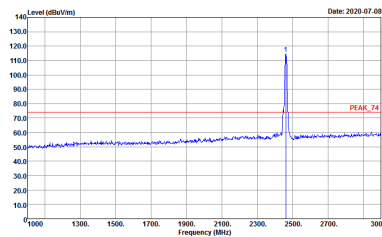
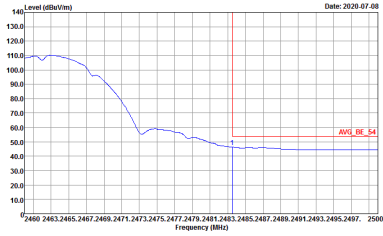
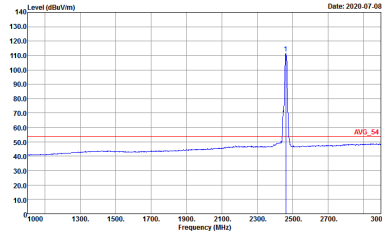

WIFI	2.4GHz 2400~2483.5MHz Band Edge @ 3m	
ANT	802.11b CH11 2462MHz	
4+3	Horizontal	Fundamental
<p>Peak</p>	 <p>Site : 03CH16-HY Condition : PEAK_BE_74 3m 91200_1522 HORIZONTAL Detector : Peak Project : 050515</p>	 <p>Site : 03CH16-HY Condition : PEAK_74 3m 91200_1522 HORIZONTAL Detector : Peak Project : 050515</p>
<p>Avg.</p>	 <p>Site : 03CH16-HY Condition : AVG_BE_54 3m 91200_1522 HORIZONTAL Detector : Peak Project : 050515</p>	 <p>Site : 03CH16-HY Condition : AVG_54 3m 91200_1522 HORIZONTAL Detector : Peak Project : 050515</p>

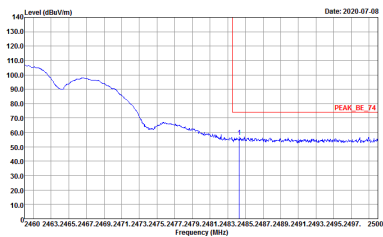
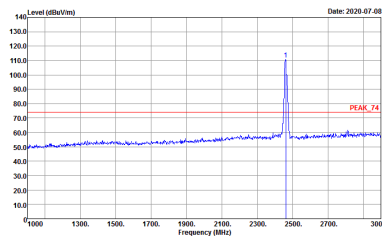
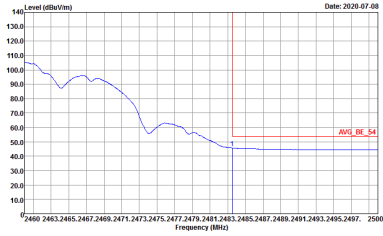
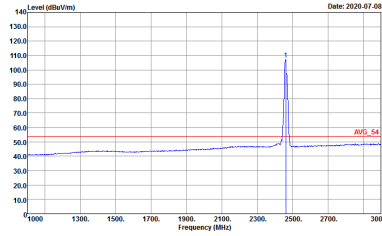

WIFI	2.4GHz 2400~2483.5MHz Band Edge @ 3m	
ANT	802.11b CH11 2462MHz	
4+3	Vertical	Fundamental
<p>Peak</p>	 <p>Site : 03CH16-HY Condition : PEAK_BE_74 3m 91200_1522 VERTICAL : RBW:1000.000KHz VBW:3000.000KHz SWT:Auto Detector : Peak Project : 050515</p>	 <p>Site : 03CH16-HY Condition : PEAK_74 3m 91200_1522 VERTICAL : RBW:1000.000KHz VBW:3000.000KHz SWT:Auto Detector : Peak Project : 050515</p>
<p>Avg.</p>	 <p>Site : 03CH16-HY Condition : AVG_BE_54 3m 91200_1522 VERTICAL : RBW:1000.000KHz VBW:0.010KHz SWT:Auto Detector : Peak Project : 050515</p>	 <p>Site : 03CH16-HY Condition : AVG_54 3m 91200_1522 VERTICAL : RBW:1000.000KHz VBW:0.010KHz SWT:Auto Detector : Peak Project : 050515</p>

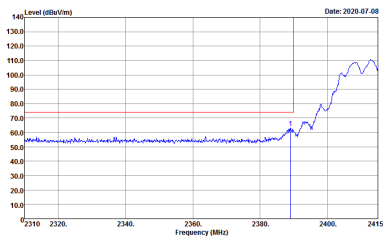
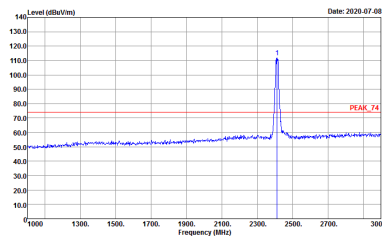
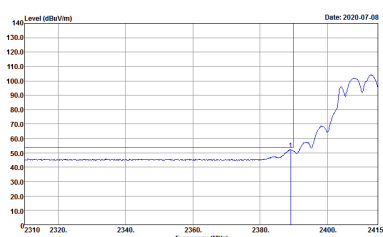
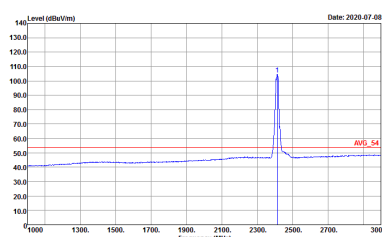

2.4GHz 2400~2483.5MHz
WIFI 802.11g (Band Edge @ 3m)

WIFI	2.4GHz 2400~2483.5MHz Band Edge @ 3m	
ANT	802.11g CH01 2412MHz	
4+3	Horizontal	Fundamental
Peak	 <p>Site : 03CH16-HY Condition : PEAK_BE_74 3m 91200_1522 HORIZONTAL RBW:1000.000KHz VBW:3000.000KHz SWT:Auto Detector : Peak Project : 050515</p>	 <p>Site : 03CH16-HY Condition : PEAK_74 3m 91200_1522 HORIZONTAL RBW:1000.000KHz VBW:3000.000KHz SWT:Auto Detector : Peak Project : 050515</p>
Avg.	 <p>Site : 03CH16-HY Condition : AVG_BE_54 3m 91200_1522 HORIZONTAL RBW:1000.000KHz VBW:1.000KHz SWT:Auto Detector : Peak Project : 050515</p>	 <p>Site : 03CH16-HY Condition : AVG_54 3m 91200_1522 HORIZONTAL RBW:1000.000KHz VBW:1.000KHz SWT:Auto Detector : Peak Project : 050515</p>

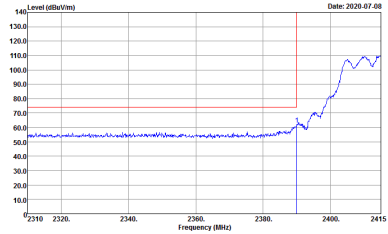
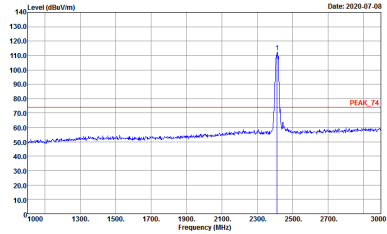
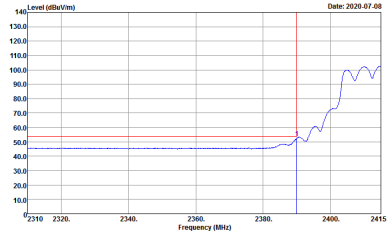
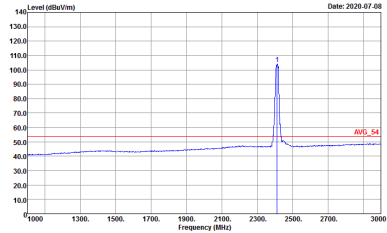

WIFI	2.4GHz 2400~2483.5MHz Band Edge @ 3m	
ANT	802.11g CH01 2412MHz	
4+3	Vertical	Fundamental
<p>Peak</p>	 <p>Site : 03CH16-HY Condition : PEAK_BE_74 3m 91200_1522 VERTICAL : RBW:1000.000kHz VBW:3000.000kHz SWT:Auto Detector : Peak Project : 050515</p>	 <p>Site : 03CH16-HY Condition : PEAK_74 3m 91200_1522 VERTICAL : RBW:1000.000kHz VBW:3000.000kHz SWT:Auto Detector : Peak Project : 050515</p>
<p>Avg.</p>	 <p>Site : 03CH16-HY Condition : AVG_BE_54 3m 91200_1522 VERTICAL : RBW:1000.000kHz VBW:1.000kHz SWT:Auto Detector : Peak Project : 050515</p>	 <p>Site : 03CH16-HY Condition : AVG_54 3m 91200_1522 VERTICAL : RBW:1000.000kHz VBW:1.000kHz SWT:Auto Detector : Peak Project : 050515</p>

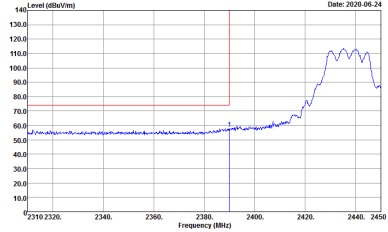
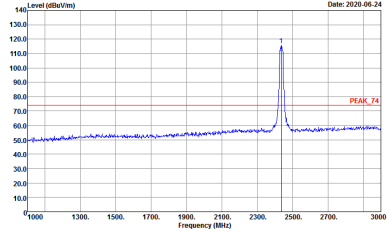
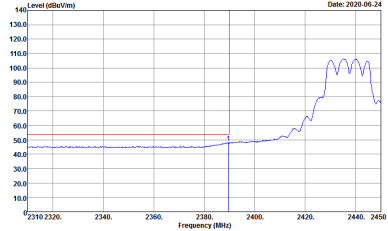
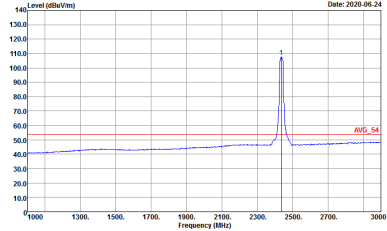

WIFI	2.4GHz 2400~2483.5MHz Band Edge @ 3m	
ANT	802.11g CH06 2437MHz - L	
4+3	Horizontal	Fundamental
<p>Peak</p>	 <p>Site : 03CH16-HY Condition : PEAK_BE_74 3m 91200_1522 HORIZONTAL RBW:1000.000KHz VBW:3000.000KHz SWT:Auto Detector : Peak Project : 050515</p>	 <p>Site : 03CH16-HY Condition : PEAK_74 3m 91200_1522 HORIZONTAL RBW:1000.000KHz VBW:3000.000KHz SWT:Auto Detector : Peak Project : 050515</p>
<p>Avg.</p>	 <p>Site : 03CH16-HY Condition : AVG_BE_54 3m 91200_1522 HORIZONTAL RBW:1000.000KHz VBW:1000KHz SWT:Auto Detector : Peak Project : 050515</p>	 <p>Site : 03CH16-HY Condition : AVG_54 3m 91200_1522 HORIZONTAL RBW:1000.000KHz VBW:1000KHz SWT:Auto Detector : Peak Project : 050515</p>

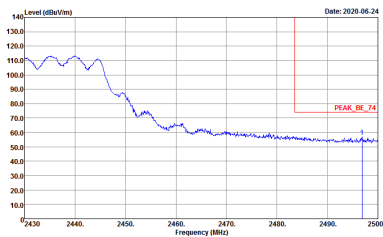
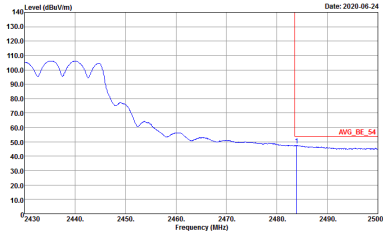

WIFI	2.4GHz 2400~2483.5MHz Band Edge @ 3m	
ANT	802.11g CH06 2437MHz - R	
4+3	Horizontal	Fundamental
Peak	 <p>Site : 03CH16-HY Condition : PEAK_BE_74 3m 91200_1522 HORIZONTAL Detector : Peak Project : 050515</p>	Left blank
Avg.	 <p>Site : 03CH16-HY Condition : AVG_BE_54 3m 91200_1522 HORIZONTAL Detector : Peak Project : 050515</p>	Left blank

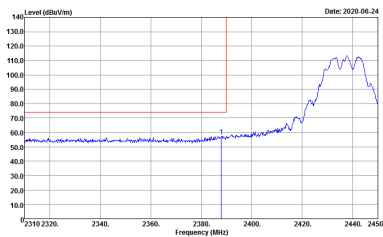
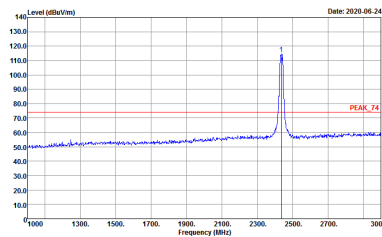
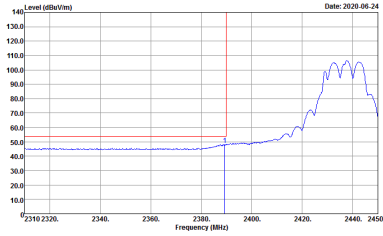
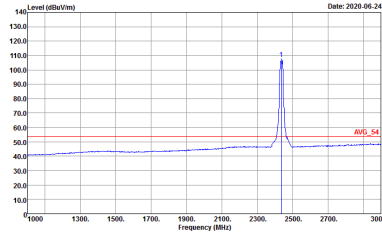

WIFI	2.4GHz 2400~2483.5MHz Band Edge @ 3m	
ANT	802.11g CH06 2437MHz - L	
4+3	Vertical	Fundamental
Peak	 <p>Site : 03CH16-HY Condition : PEAK_BE_74 3m 91200_1522 VERTICAL RBW:1000.000kHz VBW:3000.000kHz SWT:Auto Detector : Peak Project : 050515</p>	 <p>Site : 03CH16-HY Condition : PEAK_74 3m 91200_1522 VERTICAL RBW:1000.000kHz VBW:3000.000kHz SWT:Auto Detector : Peak Project : 050515</p>
Avg.	 <p>Site : 03CH16-HY Condition : AVG_BE_54 3m 91200_1522 VERTICAL RBW:1000.000kHz VBW:1000kHz SWT:Auto Detector : Peak Project : 050515</p>	 <p>Site : 03CH16-HY Condition : AVG_54 3m 91200_1522 VERTICAL RBW:1000.000kHz VBW:1000kHz SWT:Auto Detector : Peak Project : 050515</p>

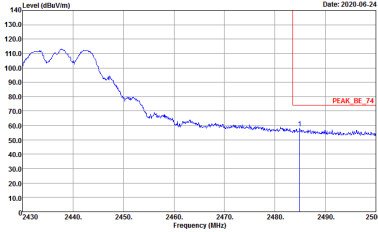
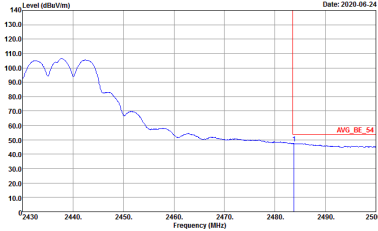

WIFI	2.4GHz 2400~2483.5MHz Band Edge @ 3m	
ANT	802.11g CH06 2437MHz - R	
4+3	Vertical	Fundamental
Peak	 <p>Site : 03CH16-HY Condition : PEAK_BE_74 3m 91200_1522 VERTICAL Detector : RBW:1000.000KHz VBW:3000.000KHz SWT:Auto Project : 050515</p>	Left Blank
Avg.	 <p>Site : 03CH16-HY Condition : AVG_BE_54 3m 91200_1522 VERTICAL Detector : RBW:1000.000KHz VBW:1.000KHz SWT:Auto Project : 050515</p>	Left Blank

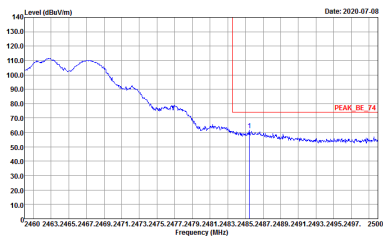
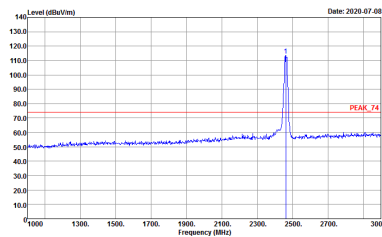
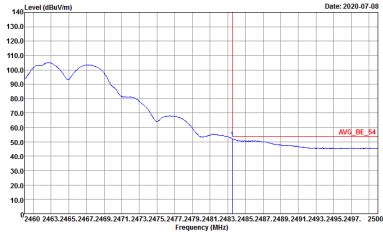
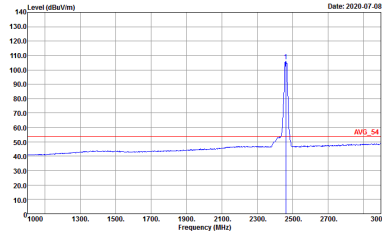

WIFI	2.4GHz 2400~2483.5MHz Band Edge @ 3m	
ANT	802.11g CH11 2462MHz	
4+3	Horizontal	Fundamental
Peak	 <p>Site : 03CH16-HY Condition : PEAK_BE_74 3m 91200_1522 HORIZONTAL Detector : Peak Project : 050515</p>	 <p>Site : 03CH16-HY Condition : PEAK_74 3m 91200_1522 HORIZONTAL Detector : Peak Project : 050515</p>
Avg.	 <p>Site : 03CH16-HY Condition : AVG_BE_54 3m 91200_1522 HORIZONTAL Detector : Peak Project : 050515</p>	 <p>Site : 03CH16-HY Condition : AVG_54 3m 91200_1522 HORIZONTAL Detector : Peak Project : 050515</p>

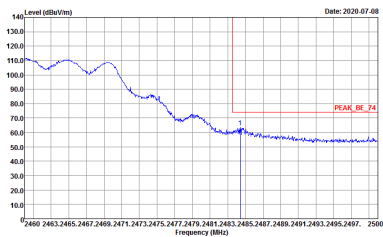
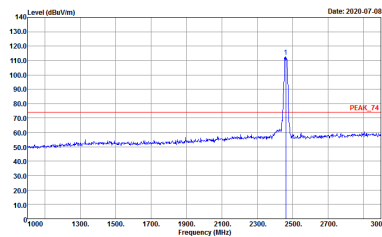
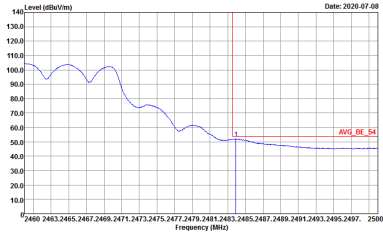
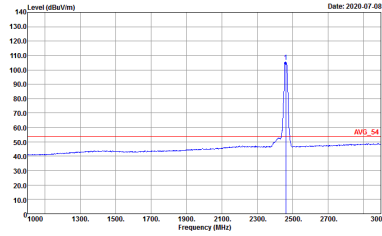

WIFI	2.4GHz 2400~2483.5MHz Band Edge @ 3m	
ANT	802.11g CH11 2462MHz	
4+3	Vertical	Fundamental
<p>Peak</p>	 <p>Site : 03CH16-HY Condition : PEAK_BE_74 3m 91200_1522 VERTICAL RBW:1000.000kHz VBW:3000.000kHz SWT:Auto Detector : Peak Project : 050515</p>	 <p>Site : 03CH16-HY Condition : PEAK_74 3m 91200_1522 VERTICAL RBW:1000.000kHz VBW:3000.000kHz SWT:Auto Detector : Peak Project : 050515</p>
<p>Avg.</p>	 <p>Site : 03CH16-HY Condition : AVG_BE_54 3m 91200_1522 VERTICAL RBW:1000.000kHz VBW:1.000kHz SWT:Auto Detector : Peak Project : 050515</p>	 <p>Site : 03CH16-HY Condition : AVG_54 3m 91200_1522 VERTICAL RBW:1000.000kHz VBW:1.000kHz SWT:Auto Detector : Peak Project : 050515</p>

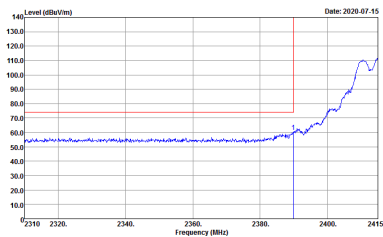
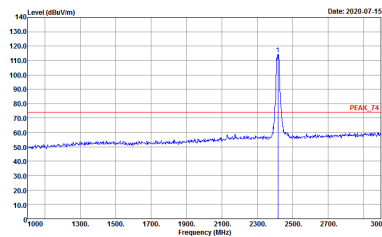
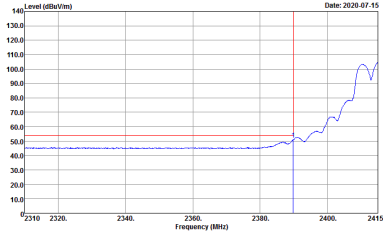
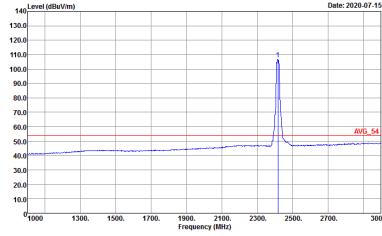

WIFI	2.4GHz 2400~2483.5MHz Band Edge @ 3m	
ANT	802.11g CH02 2417MHz	
4+3	Horizontal	Fundamental
<p>Peak</p>	 <p>Site : 03CH16-HY Condition : PEAK_BE_74 3m 91200_1522 HORIZONTAL RBW:1000.000KHz VBW:3000.000KHz SWT:Auto Detector : Peak Project : 050515</p>	 <p>Site : 03CH16-HY Condition : PEAK_74 3m 91200_1522 HORIZONTAL RBW:1000.000KHz VBW:3000.000KHz SWT:Auto Detector : Peak Project : 050515</p>
<p>Avg.</p>	 <p>Site : 03CH16-HY Condition : AVG_BE_54 3m 91200_1522 HORIZONTAL RBW:1000.000KHz VBW:1000KHz SWT:Auto Detector : Peak Project : 050515</p>	 <p>Site : 03CH16-HY Condition : AVG_54 3m 91200_1522 HORIZONTAL RBW:1000.000KHz VBW:1000KHz SWT:Auto Detector : Peak Project : 050515</p>

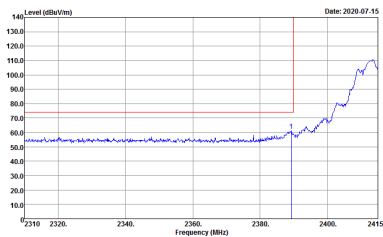
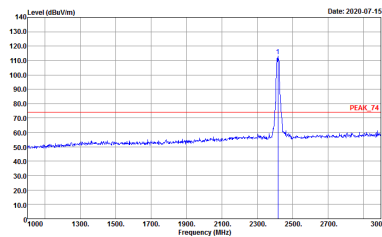
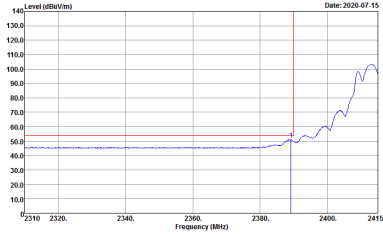
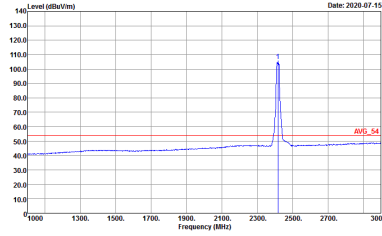

WIFI	2.4GHz 2400~2483.5MHz Band Edge @ 3m	
ANT	802.11g CH02 2417MHz	
4+3	Vertical	Fundamental
<p>Peak</p>	 <p>Site : 03CH16-HY Condition : PEAK_BE_74 3m 91200_1522 VERTICAL Detector : Peak Project : 050515</p>	 <p>Site : 03CH16-HY Condition : PEAK_74 3m 91200_1522 VERTICAL Detector : Peak Project : 050515</p>
<p>Avg.</p>	 <p>Site : 03CH16-HY Condition : AVG_BE_54 3m 91200_1522 VERTICAL Detector : Peak Project : 050515</p>	 <p>Site : 03CH16-HY Condition : AVG_54 3m 91200_1522 VERTICAL Detector : Peak Project : 050515</p>

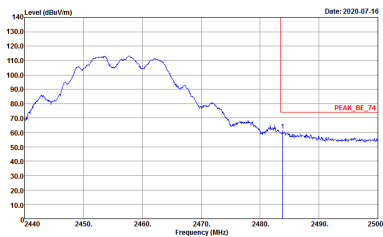
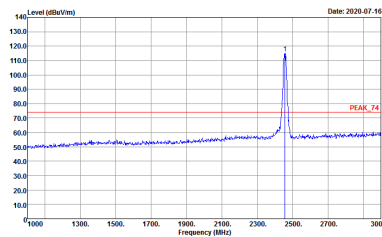
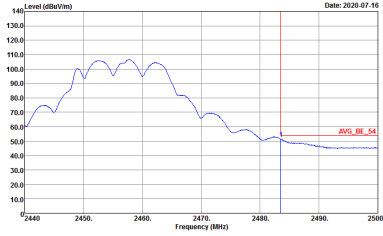
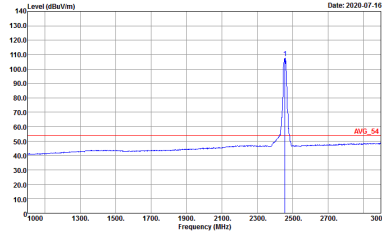

WIFI	2.4GHz 2400~2483.5MHz Band Edge @ 3m	
ANT	802.11g CH10 2457MHz	
4+3	Horizontal	Fundamental
Peak	 <p>Level (dBm/Vm) vs Frequency (MHz) graph showing a peak at 2483.5 MHz. The y-axis ranges from 10.0 to 140.0 dBm/Vm, and the x-axis ranges from 2440 to 2500 MHz. A red vertical line marks the peak at 2483.5 MHz, labeled 'PEAK_BE_74'.</p> <p>Site : 03CH16-HY Condition : PEAK_BE_74 3m 91200_1522 HORIZONTAL RBW:1000.000KHz VBW:3000.000KHz SWT:Auto Detector : Peak Project : 050515</p>	 <p>Level (dBm/Vm) vs Frequency (MHz) graph showing a peak at 2457 MHz. The y-axis ranges from 10.0 to 140.0 dBm/Vm, and the x-axis ranges from 1000 to 3000 MHz. A red vertical line marks the peak at 2457 MHz, labeled 'PEAK_74'.</p> <p>Site : 03CH16-HY Condition : PEAK_74 3m 91200_1522 HORIZONTAL RBW:1000.000KHz VBW:3000.000KHz SWT:Auto Detector : Peak Project : 050515</p>
Avg.	 <p>Level (dBm/Vm) vs Frequency (MHz) graph showing an average level at 2483.5 MHz. The y-axis ranges from 10.0 to 140.0 dBm/Vm, and the x-axis ranges from 2440 to 2500 MHz. A red vertical line marks the average level at 2483.5 MHz, labeled 'AVG_BE_54'.</p> <p>Site : 03CH16-HY Condition : AVG_BE_54 3m 91200_1522 HORIZONTAL RBW:1000.000KHz VBW:1000KHz SWT:Auto Detector : Peak Project : 050515</p>	 <p>Level (dBm/Vm) vs Frequency (MHz) graph showing an average level at 2457 MHz. The y-axis ranges from 10.0 to 140.0 dBm/Vm, and the x-axis ranges from 1000 to 3000 MHz. A red vertical line marks the average level at 2457 MHz, labeled 'AVG_54'.</p> <p>Site : 03CH16-HY Condition : AVG_54 3m 91200_1522 HORIZONTAL RBW:1000.000KHz VBW:1000KHz SWT:Auto Detector : Peak Project : 050515</p>



WIFI	2.4GHz 2400~2483.5MHz Band Edge @ 3m	
ANT	802.11g CH10 2457MHz	
4+3	Vertical	Fundamental
Peak	<p>Site : 03CH16-HY Condition : PEAK_BE_74 3m 91200_1522 VERTICAL : RBW:1000.000KHz VBW:3000.000KHz SWT:Auto Detector : Peak Project : 050515</p>	<p>Site : 03CH16-HY Condition : PEAK_74 3m 91200_1522 VERTICAL : RBW:1000.000KHz VBW:3000.000KHz SWT:Auto Detector : Peak Project : 050515</p>
Avg.	<p>Site : 03CH16-HY Condition : AVG_BE_54 3m 91200_1522 VERTICAL : RBW:1000.000KHz VBW:1000KHz SWT:Auto Detector : Peak Project : 050515</p>	<p>Site : 03CH16-HY Condition : AVG_54 3m 91200_1522 VERTICAL : RBW:1000.000KHz VBW:1000KHz SWT:Auto Detector : Peak Project : 050515</p>

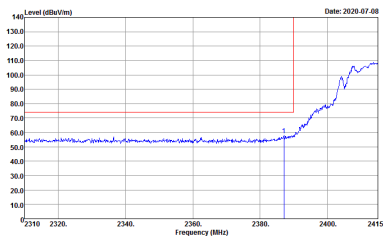
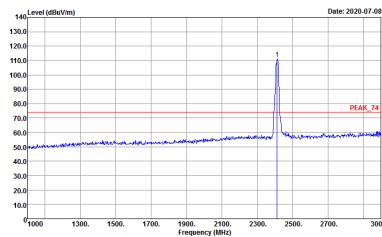
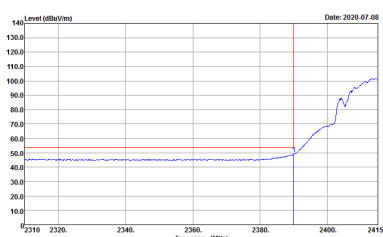
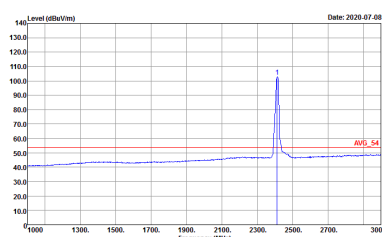

2.4GHz 2400~2483.5MHz
WIFI 802.11n HT20 (Band Edge @ 3m)

WIFI	2.4GHz 2400~2483.5MHz Band Edge @ 3m	
ANT	802.11n HT20 CH01 2412MHz	
4+3	Horizontal	Fundamental
Peak	 <p>Site : 03CH16-HY Condition : PEAK_BE_74 3m 91200_1522 HORIZONTAL RBW:1000.000KHz VBW:3000.000KHz SWT:Auto Detector : Peak Project : 050515</p>	 <p>Site : 03CH16-HY Condition : PEAK_74 3m 91200_1522 HORIZONTAL RBW:1000.000KHz VBW:3000.000KHz SWT:Auto Detector : Peak Project : 050515</p>
Avg.	 <p>Site : 03CH16-HY Condition : AVG_BE_54 3m 91200_1522 HORIZONTAL RBW:1000.000KHz VBW:1.000KHz SWT:Auto Detector : Peak Project : 050515</p>	 <p>Site : 03CH16-HY Condition : AVG_54 3m 91200_1522 HORIZONTAL RBW:1000.000KHz VBW:1.000KHz SWT:Auto Detector : Peak Project : 050515</p>

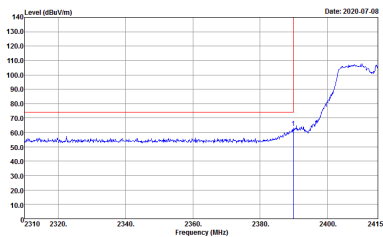
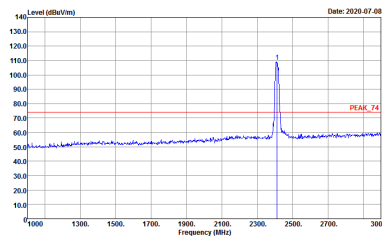
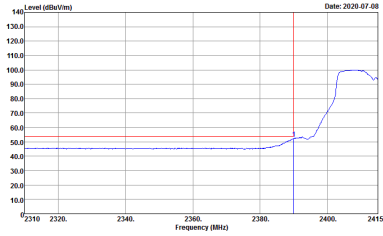
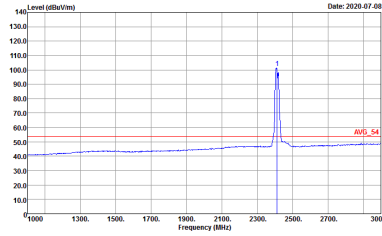

WIFI	2.4GHz 2400~2483.5MHz Band Edge @ 3m	
ANT	802.11n HT20 CH01 2412MHz	
4+3	Vertical	Fundamental
Peak	 <p>Site : 03CH16-HY Condition : PEAK_BE_74 3m 91200_1522 VERTICAL RBW:1000.000KHz VBW:3000.000KHz SWT:Auto Detector : Peak Project : 050515</p>	 <p>Site : 03CH16-HY Condition : PEAK_74 3m 91200_1522 VERTICAL RBW:1000.000KHz VBW:3000.000KHz SWT:Auto Detector : Peak Project : 050515</p>
Avg.	 <p>Site : 03CH16-HY Condition : AVG_BE_54 3m 91200_1522 VERTICAL RBW:1000.000KHz VBW:1.000KHz SWT:Auto Detector : Peak Project : 050515</p>	 <p>Site : 03CH16-HY Condition : AVG_54 3m 91200_1522 VERTICAL RBW:1000.000KHz VBW:1.000KHz SWT:Auto Detector : Peak Project : 050515</p>

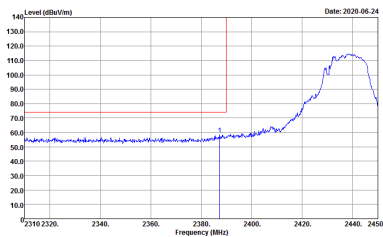
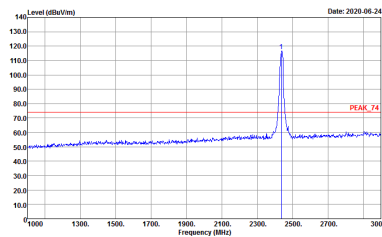
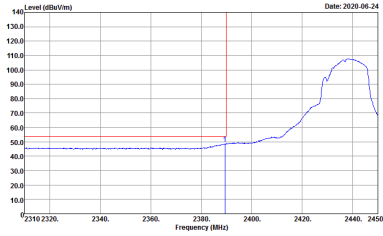
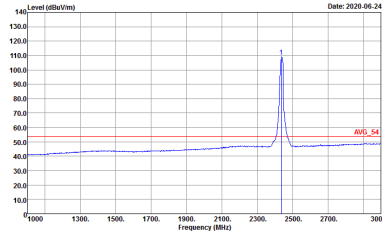

WIFI	2.4GHz 2400~2483.5MHz Band Edge @ 3m	
ANT	802.11n HT20 CH06 2437MHz - L	
4+3	Horizontal	Fundamental
Peak	 <p>Site : 03CH16-HY Condition : PEAK_BE_74 3m 91200_1522 HORIZONTAL : RBW:1000.000KHz VBW:3000.000KHz SWT:Auto Detector : Peak Project : 050515</p>	 <p>Site : 03CH16-HY Condition : PEAK_74 3m 91200_1522 HORIZONTAL : RBW:1000.000KHz VBW:3000.000KHz SWT:Auto Detector : Peak Project : 050515</p>
Avg.	 <p>Site : 03CH16-HY Condition : AVG_BE_54 3m 91200_1522 HORIZONTAL : RBW:1000.000KHz VBW:1000KHz SWT:Auto Detector : Peak Project : 050515</p>	 <p>Site : 03CH16-HY Condition : AVG_54 3m 91200_1522 HORIZONTAL : RBW:1000.000KHz VBW:1000KHz SWT:Auto Detector : Peak Project : 050515</p>

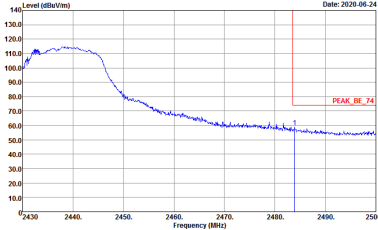
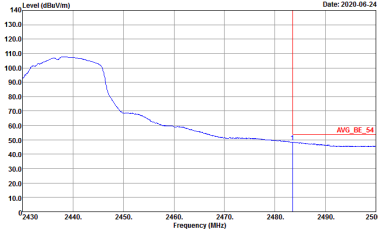

WIFI	2.4GHz 2400~2483.5MHz Band Edge @ 3m	
ANT	802.11n HT20 CH06 2437MHz - R	
4+3	Horizontal	Fundamental
Peak	 <p>Site : 03CH16-HY Condition : PEAK_BE_74 3m 91200_1522 HORIZONTAL Detector : Peak Project : 050515</p>	Left blank
Avg.	 <p>Site : 03CH16-HY Condition : AVG_BE_54 3m 91200_1522 HORIZONTAL Detector : Peak Project : 050515</p>	Left blank

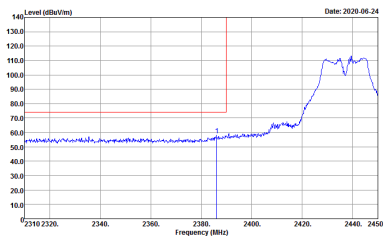
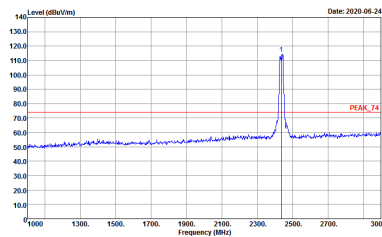
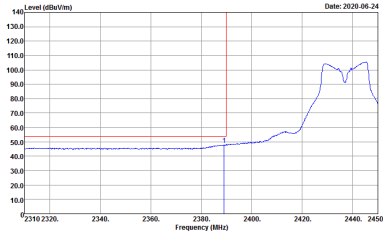
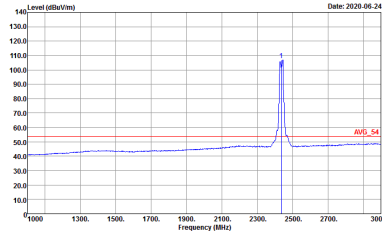

WIFI	2.4GHz 2400~2483.5MHz Band Edge @ 3m	
ANT	802.11n HT20 CH06 2437MHz - L	
4+3	Vertical	Fundamental
Peak	 <p>Site : 03CH16-HY Condition : PEAK_BE_74 3m 91200_1522 VERTICAL Detector : Peak Project : 050515</p>	 <p>Site : 03CH16-HY Condition : PEAK_74 3m 91200_1522 VERTICAL Detector : Peak Project : 050515</p>
Avg.	 <p>Site : 03CH16-HY Condition : AVG_BE_54 3m 91200_1522 VERTICAL Detector : Peak Project : 050515</p>	 <p>Site : 03CH16-HY Condition : AVG_54 3m 91200_1522 VERTICAL Detector : Peak Project : 050515</p>



WIFI	2.4GHz 2400~2483.5MHz Band Edge @ 3m	
ANT	802.11n HT20 CH06 2437MHz - R	
4+3	Vertical	Fundamental
Peak	<p>Site : 03CH16-HY Condition : PEAK_BE_74 3m 91200_1522 VERTICAL Detector : RBW:1000.000kHz VBW:3000.000kHz SWT:Auto Project : 050515</p>	Left Blank
Avg.	<p>Site : 03CH16-HY Condition : AVG_BE_54 3m 91200_1522 VERTICAL Detector : RBW:1000.000kHz VBW:1.000kHz SWT:Auto Project : 050515</p>	Left Blank

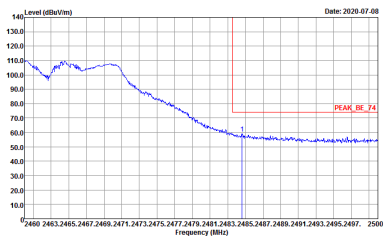
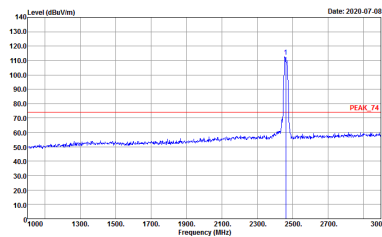
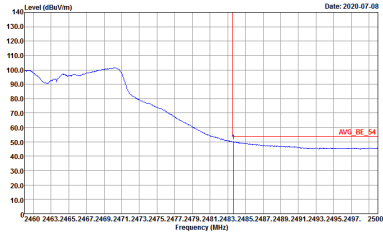
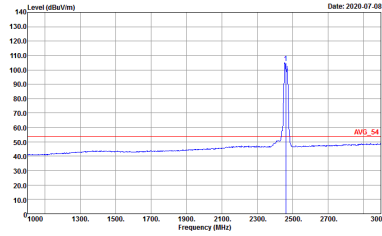

WIFI	2.4GHz 2400~2483.5MHz Band Edge @ 3m	
ANT	802.11n HT20 CH11 2462MHz	
4+3	Horizontal	Fundamental
<p>Peak</p>	 <p>Site : 03CH16-HY Condition : PEAK_BE_74 3m 91200_1522 HORIZONTAL Detector : Peak Project : 050515</p>	 <p>Site : 03CH16-HY Condition : PEAK_74 3m 91200_1522 HORIZONTAL Detector : Peak Project : 050515</p>
<p>Avg.</p>	 <p>Site : 03CH16-HY Condition : AVG_BE_54 3m 91200_1522 HORIZONTAL Detector : Peak Project : 050515</p>	 <p>Site : 03CH16-HY Condition : AVG_54 3m 91200_1522 HORIZONTAL Detector : Peak Project : 050515</p>

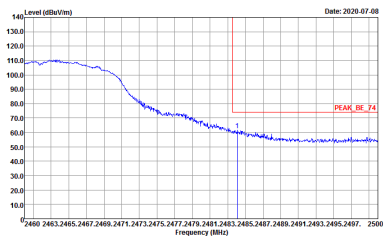
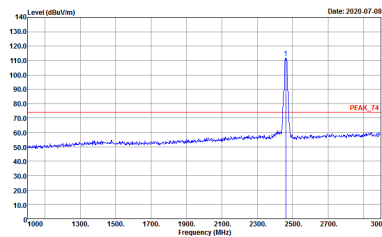
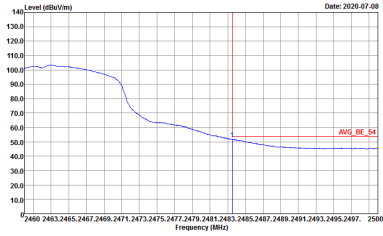
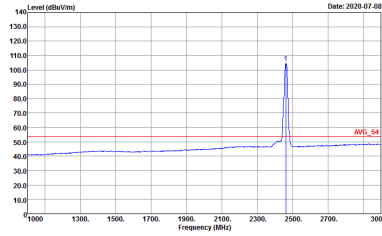

WIFI	2.4GHz 2400~2483.5MHz Fundamental @ 3m	
ANT	802.11n HT20 CH11 2462MHz	
4+3	Vertical	Fundamental
Peak	 <p>Site : 03CH16-HY Condition : PEAK_BE_74 3m 91200_1522 VERTICAL RBW:1000.000KHz VBW:3000.000KHz SWT:Auto Detector : Peak Project : 050515</p>	 <p>Site : 03CH16-HY Condition : PEAK_74 3m 91200_1522 VERTICAL RBW:1000.000KHz VBW:3000.000KHz SWT:Auto Detector : Peak Project : 050515</p>
Avg.	 <p>Site : 03CH16-HY Condition : AVG_BE_54 3m 91200_1522 VERTICAL RBW:1000.000KHz VBW:1.000KHz SWT:Auto Detector : Peak Project : 050515</p>	 <p>Site : 03CH16-HY Condition : AVG_54 3m 91200_1522 VERTICAL RBW:1000.000KHz VBW:1.000KHz SWT:Auto Detector : Peak Project : 050515</p>

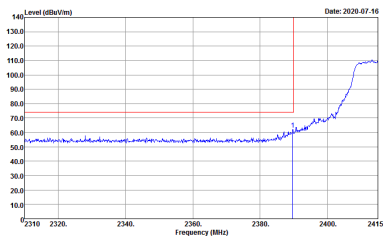
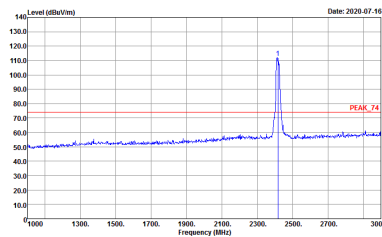
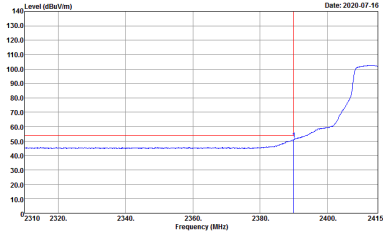
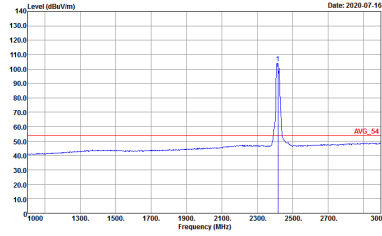

WIFI	2.4GHz 2400~2483.5MHz Band Edge @ 3m	
ANT	802.11n HT20 CH02 2417MHz	
4+3	Horizontal	Fundamental
Peak	 <p>Site : 03CH16-HY Condition : PEAK_BE_74 3m 91200_1522 HORIZONTAL Detector : Peak Project : 050515</p>	 <p>Site : 03CH16-HY Condition : PEAK_74 3m 91200_1522 HORIZONTAL Detector : Peak Project : 050515</p>
Avg.	 <p>Site : 03CH16-HY Condition : AVG_BE_54 3m 91200_1522 HORIZONTAL Detector : Peak Project : 050515</p>	 <p>Site : 03CH16-HY Condition : AVG_54 3m 91200_1522 HORIZONTAL Detector : Peak Project : 050515</p>

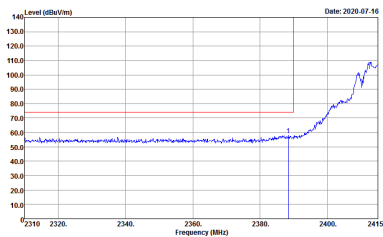
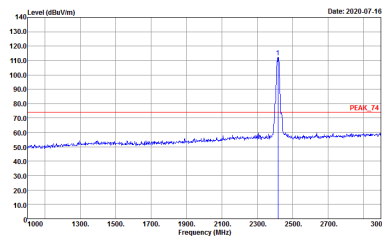
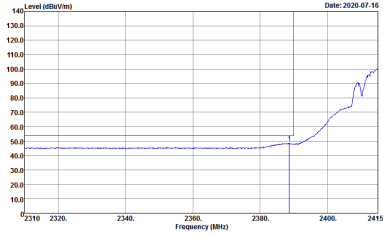
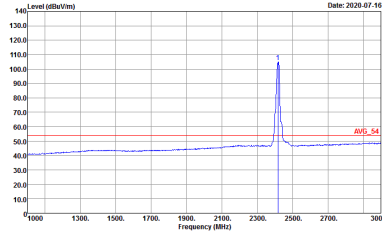

WIFI	2.4GHz 2400~2483.5MHz Band Edge @ 3m	
ANT	802.11n HT20 CH02 2417MHz	
4+3	Vertical	Fundamental
Peak	 <p>Site : 03CH16-HY Condition : PEAK_BE_74 3m 91200_1522 VERTICAL Detector : Peak Project : 050515</p>	 <p>Site : 03CH16-HY Condition : PEAK_74 3m 91200_1522 VERTICAL Detector : Peak Project : 050515</p>
Avg.	 <p>Site : 03CH16-HY Condition : AVG_BE_54 3m 91200_1522 VERTICAL Detector : Peak Project : 050515</p>	 <p>Site : 03CH16-HY Condition : AVG_54 3m 91200_1522 VERTICAL Detector : Peak Project : 050515</p>

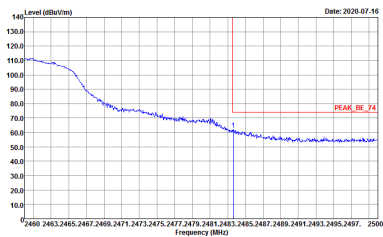
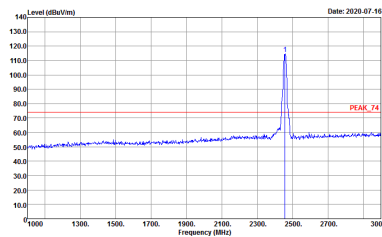
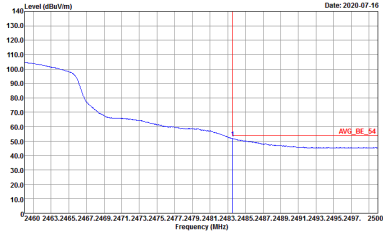
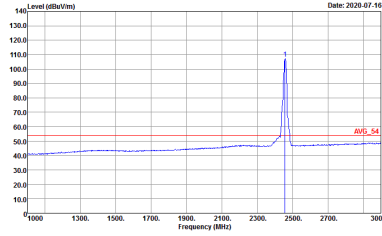

WIFI	2.4GHz 2400~2483.5MHz Band Edge @ 3m	
ANT	802.11n HT20 CH10 2457MHz	
4+3	Horizontal	Fundamental
Peak	 <p>Site : 03CH16-HY Condition : PEAK_BE_74 3m 91200_1522 HORIZONTAL : RBW:1000.000KHz VBW:3000.000KHz SWT:Auto Detector : Peak Project : 050515</p>	 <p>Site : 03CH16-HY Condition : PEAK_74 3m 91200_1522 HORIZONTAL : RBW:1000.000KHz VBW:3000.000KHz SWT:Auto Detector : Peak Project : 050515</p>
Avg.	 <p>Site : 03CH16-HY Condition : AVG_BE_54 3m 91200_1522 HORIZONTAL : RBW:1000.000KHz VBW:1000KHz SWT:Auto Detector : Peak Project : 050515</p>	 <p>Site : 03CH16-HY Condition : AVG_54 3m 91200_1522 HORIZONTAL : RBW:1000.000KHz VBW:1000KHz SWT:Auto Detector : Peak Project : 050515</p>

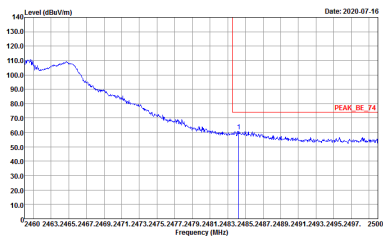
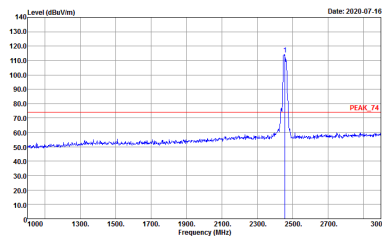
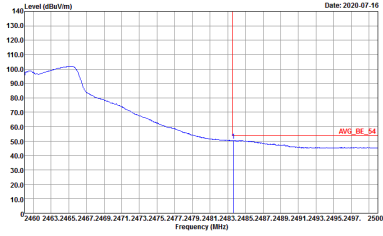
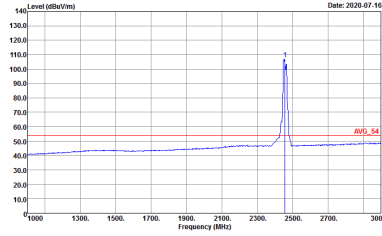

WIFI	2.4GHz 2400~2483.5MHz Band Edge @ 3m	
ANT	802.11n HT20 CH10 2457MHz	
4+3	Vertical	Fundamental
<p>Peak</p>	 <p>Site : 03CH16-HY Condition : PEAK_BE_74 3m 91200_1522 VERTICAL RBW:1000.000KHz VBW:3000.000KHz SWT:Auto Detector : Peak Project : 050515</p>	 <p>Site : 03CH16-HY Condition : PEAK_74 3m 91200_1522 VERTICAL RBW:1000.000KHz VBW:3000.000KHz SWT:Auto Detector : Peak Project : 050515</p>
<p>Avg.</p>	 <p>Site : 03CH16-HY Condition : AVG_BE_54 3m 91200_1522 VERTICAL RBW:1000.000KHz VBW:1000KHz SWT:Auto Detector : Peak Project : 050515</p>	 <p>Site : 03CH16-HY Condition : AVG_54 3m 91200_1522 VERTICAL RBW:1000.000KHz VBW:1000KHz SWT:Auto Detector : Peak Project : 050515</p>



2.4GHz 2400~2483.5MHz

WIFI 802.11b (Harmonic @ 3m)

WIFI	2.4GHz 2400~2483.5MHz Harmonic @ 3m	
ANT	802.11b CH01 2412MHz	
4+3	Horizontal	Vertical
Peak Avg.	<p>Site : 03CH16-HY Condition : PEAK_74 3m 9120D_1522 HORIZONTAL Detector : Peak Project : 050515</p>	<p>Site : 03CH16-HY Condition : PEAK_74 3m 9120D_1522 VERTICAL Detector : Peak Project : 050515</p>



WIFI	2.4GHz 2400~2483.5MHz Harmonic @ 3m	
ANT	802.11b CH06 2437MHz	
4+3	Horizontal	Vertical
Peak Avg.	<p>Site : 03CH16-11Y Condition : PEAK_74 3m 91200_1522 HORIZONTAL Detector : Peak Project : 050515</p>	<p>Site : 03CH16-11Y Condition : PEAK_74 3m 91200_1522 VERTICAL Detector : Peak Project : 050515</p>



WIFI	2.4GHz 2400~2483.5MHz Harmonic @ 3m	
ANT	802.11b CH11 2462MHz	
4+3	Horizontal	Vertical
Peak Avg.	<p>Site : 03CH16-11Y Condition : PEAK_74 3m 91200_1522 HORIZONTAL Detector : Peak Project : 050515</p>	<p>Site : 03CH16-11Y Condition : PEAK_74 3m 91200_1522 VERTICAL Detector : Peak Project : 050515</p>



2.4GHz 2400~2483.5MHz
WIFI 802.11g (Harmonic @ 3m)

Table with 2 columns: Horizontal and Vertical. Each column contains a spectral plot of Level (dBuV/m) vs Frequency (MHz) with Peak and Avg markers. Includes metadata like Site, Condition, Detector, and Project.



WIFI	2.4GHz 2400~2483.5MHz Harmonic @ 3m	
ANT	802.11g CH06 2437MHz	
4+3	Horizontal	Vertical
<p>Peak</p> <p>Avg.</p>		

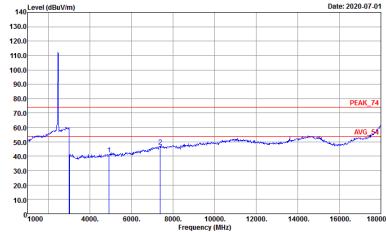
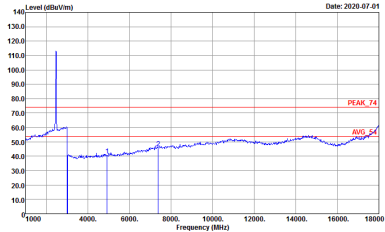

WIFI	2.4GHz 2400~2483.5MHz Harmonic @ 3m	
ANT	802.11g CH11 2462MHz	
4+3	Horizontal	Vertical
<p>Peak</p> <p>Avg.</p>	 <p>Site : 03CH16-11Y Condition : PEAK_74 3m 91200_1522 HORIZONTAL Detector : Peak Project : 050515</p>	 <p>Site : 03CH16-11Y Condition : PEAK_74 3m 91200_1522 VERTICAL Detector : Peak Project : 050515</p>



2.4GHz 2400~2483.5MHz
WIFI 802.11n HT20 (Harmonic @ 3m)

WIFI	2.4GHz 2400~2483.5MHz Harmonic @ 3m	
ANT	802.11n HT20 CH01 2412MHz	
4+3	Horizontal	Vertical
Peak Avg.	<p>Site : 03CH16-HY Condition : PEAK_74 3m 9120D_1522 HORIZONTAL Detector : Peak Project : 050515</p>	<p>Site : 03CH16-HY Condition : PEAK_74 3m 9120D_1522 VERTICAL Detector : Peak Project : 050515</p>



WIFI	2.4GHz 2400~2483.5MHz Harmonic @ 3m	
ANT	802.11n HT20 CH06 2437MHz	
4+3	Horizontal	Vertical
Peak Avg.	<p>Site : 03CH16-11Y Condition : PEAK_74 3m 91200_1522 HORIZONTAL Detector : Peak Project : 050515</p>	<p>Site : 03CH16-11Y Condition : PEAK_74 3m 91200_1522 VERTICAL Detector : Peak Project : 050515</p>



WIFI	2.4GHz 2400~2483.5MHz Harmonic @ 3m	
ANT	802.11n HT20 CH11 2462MHz	
4+3	Horizontal	Vertical
Peak Avg.	<p>Site : 03CH16-11Y Condition : PEAK_74 3m 91200_1522 HORIZONTAL Detector : Peak Project : 050515</p>	<p>Site : 03CH16-11Y Condition : PEAK_74 3m 91200_1522 VERTICAL Detector : Peak Project : 050515</p>



Emission above 18GHz
2.4GHz WIFI 802.11g (SHF)

WIFI	2.4GHz 2400~2483.5MHz	
ANT	802.11g SHF	
4+3	Horizontal	Vertical
Peak Avg.	<p>Site : 03CH16-HY Condition : PEAK_74 1m SHF HORN BBHA9170584 HORIZONTAL Detector : Peak Project : 050515</p>	<p>Site : 03CH16-HY Condition : PEAK_74 1m SHF HORN BBHA9170584 VERTICAL Detector : Peak Project : 050515</p>



Emission below 1GHz
2.4GHz WIFI 802.11g (LF)

Table with 3 columns: WIFI (2.4GHz 2400~2483.5MHz), ANT (802.11g LF), and 4+3 (Horizontal/Vertical). It contains two spectral plots showing Level (dBuV/m) vs Frequency (MHz) for QP/ Peak.



Appendix E. Duty Cycle Plots

Antenna	Band	Duty Cycle(%)	T(us)	1/T(kHz)	VBW Setting	Duty Factor(dB)
4+3	802.11b for Ant 4	100.00	-	-	10Hz	0.00
4+3	802.11b for Ant 3	100.00	-	-	10Hz	0.00
4+3	802.11g for Ant 4	97.84	2040	0.49	1kHz	0.09
4+3	802.11g for Ant 3	97.83	2025	0.49	1kHz	0.10
4+3	2.4GHz 802.11n HT20 for Ant 4	97.94	1900	0.53	1kHz	0.09
4+3	2.4GHz 802.11n HT20 for Ant 3	97.42	1885	0.53	1kHz	0.11
4+3	2.4GHz 802.11ac20 for Ant 4	97.95	1910	0.52	1kHz	0.09
4+3	2.4GHz 802.11ac20 for Ant 3	97.95	1910	0.52	1kHz	0.09



MIMO <Ant. 4>

802.11b

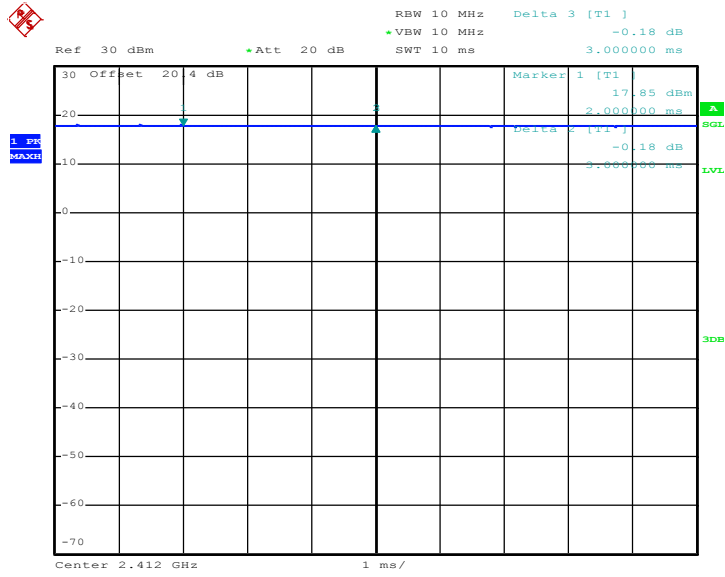

Date: 21.JUN.2020 11:03:37

802.11g

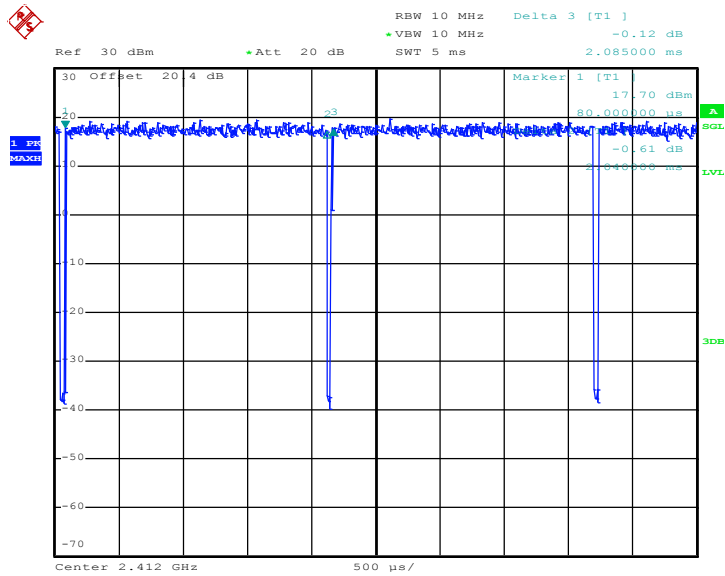

Date: 21.JUN.2020 11:21:05



802.11n HT20

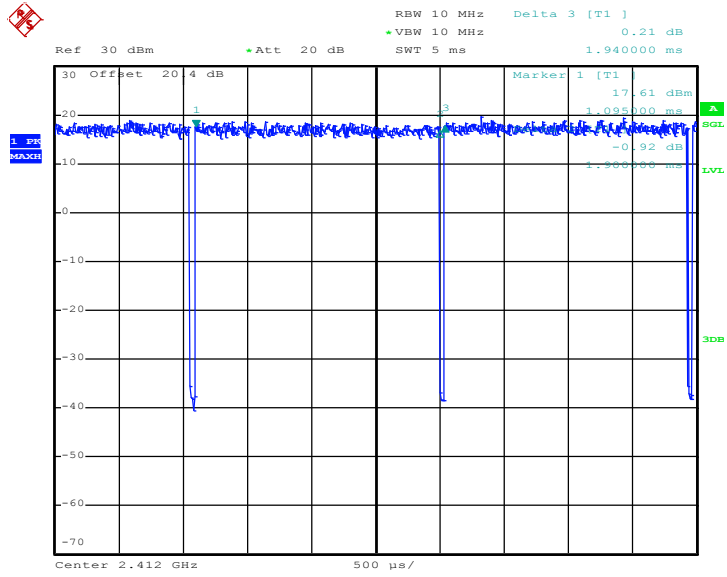

Date: 21.JUN.2020 11:29:54

802.11ac VHT20

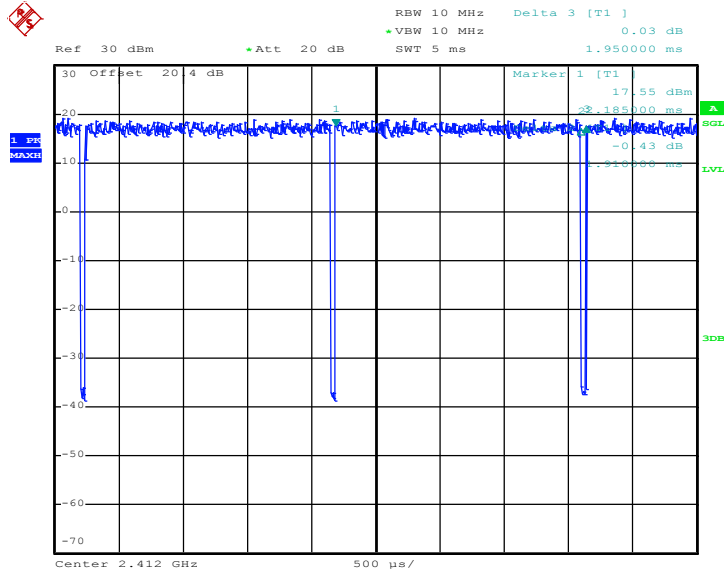

Date: 21.JUN.2020 11:36:46



MIMO <Ant. 3>

802.11b

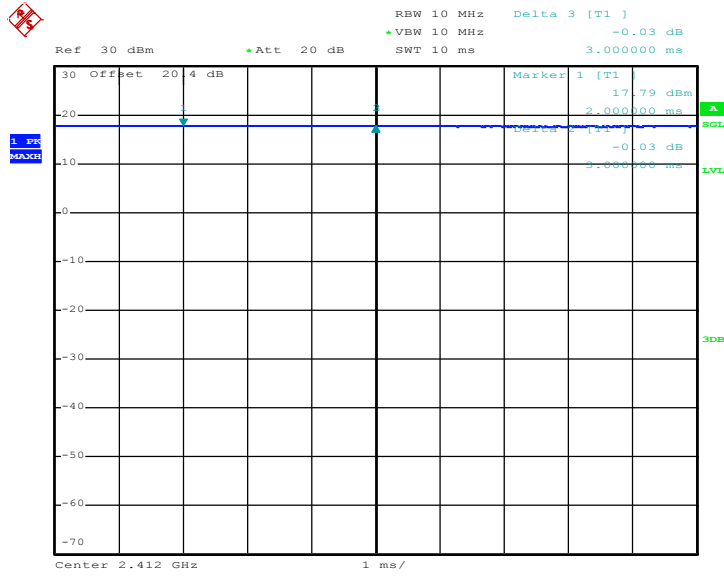

Date: 21.JUN.2020 11:07:15

802.11g

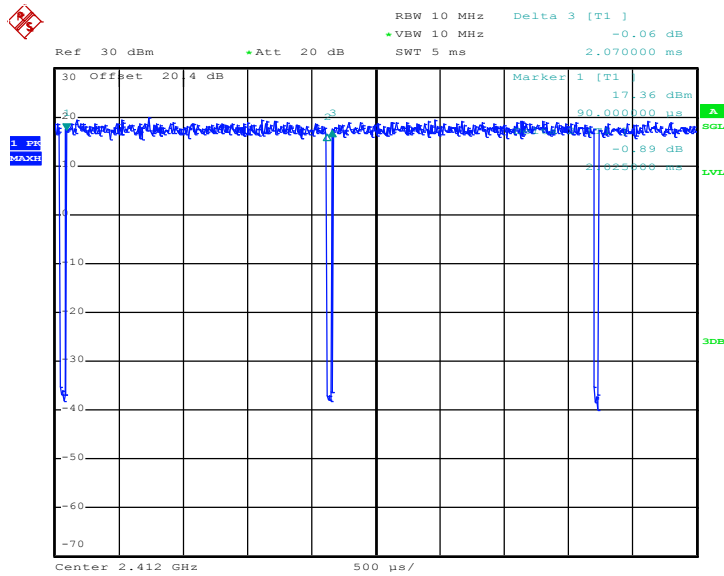

Date: 21.JUN.2020 11:23:57



802.11n HT20

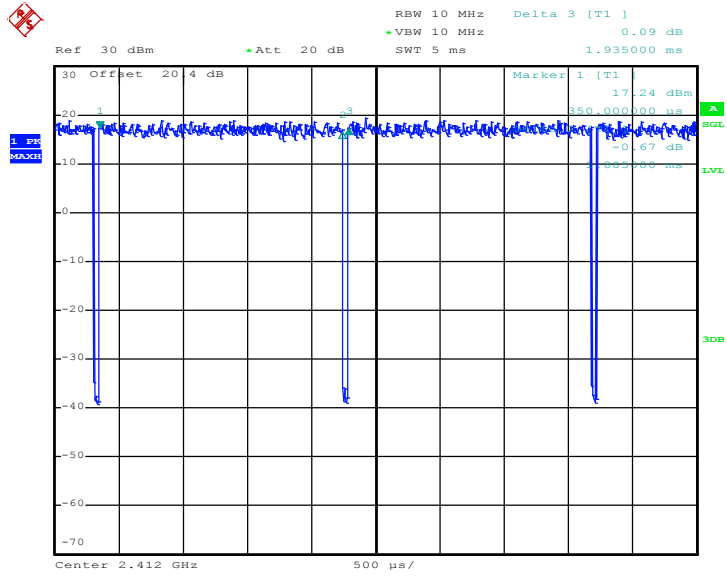

Date: 21.JUN.2020 11:31:11

802.11ac VHT20

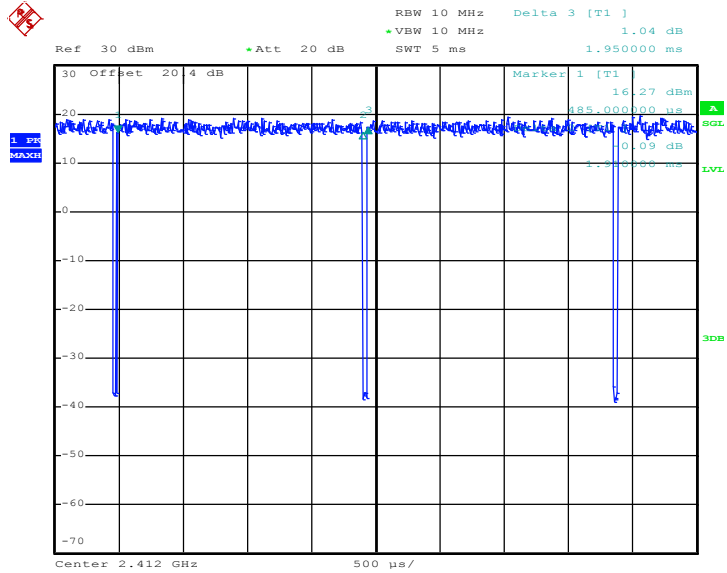

Date: 21.JUN.2020 11:37:37

—THE END—