



FCC RADIO TEST REPORT

FCC ID : A4RGKV4X
Equipment : Phone
Model Name : GKV4X
Applicant : Google LLC
1600 Amphitheatre Parkway,
Mountain View, California, 94043 USA
Standard : FCC Part 15 Subpart E §15.407

The product was received on Jul. 11, 2023 and testing was performed from Jul. 27, 2023 to Dec. 07, 2023. We, Sporton International Inc. Wensan Laboratory, would like to declare that the tested sample has been evaluated in accordance with the test procedures and has been in compliance with the applicable technical standards.

The test results in this report apply exclusively to the tested model / sample. Without written approval from Sporton International Inc. Wensan Laboratory, the test report shall not be reproduced except in full.

Approved by: Louis Wu

Sporton International Inc. Wensan Laboratory

No.58, Aly. 75, Ln. 564, Wenhua 3rd, Rd., Guishan Dist., Taoyuan City 333010, Taiwan (R.O.C.)



Table of Contents

History of this test report.....	3
Summary of Test Result.....	4
1 General Description	5
1.1 Product Feature of Equipment Under Test.....	5
1.2 Modification of EUT	7
1.3 Testing Location	7
1.4 Applicable Standards.....	7
2 Test Configuration of Equipment Under Test	8
2.1 Carrier Frequency and Channel	8
2.2 Test Mode.....	10
2.3 Connection Diagram of Test System.....	12
2.4 Support Unit used in test configuration and system	13
2.5 EUT Operation Test Setup	13
2.6 Measurement Results Explanation Example.....	13
3 Test Result	14
3.1 26dB & 99% Occupied Bandwidth Measurement	14
3.2 Fundamental Maximum EIRP Measurement	18
3.3 Fundamental Power Spectral Density Measurement.....	19
3.4 In-Band Emissions (Channel Mask)	25
3.5 Unwanted Emissions Measurement.....	61
3.6 AC Conducted Emission Measurement.....	65
3.7 Antenna Requirements.....	67
4 List of Measuring Equipment.....	68
5 Measurement Uncertainty	70
Appendix A. Conducted Test Results	
Appendix B. AC Conducted Emission Test Result	
Appendix C. Radiated Spurious Emission	
Appendix D. Radiated Spurious Emission Plots	
Appendix E. Duty Cycle Plots	
Appendix F. Setup Photographs	



History of this test report

Report No.	Version	Description	Issue Date
FR380307G	01	Initial issue of report	Dec. 12, 2023



Summary of Test Result

Report Clause	Ref Std. Clause	Test Items	Result (PASS/FAIL)	Remark
3.1	15.407(a)(10)	26dB Emission Bandwidth	Pass	-
3.1	2.1049	99% Occupied Bandwidth	Reporting only	-
3.2	15.407(a)(7)	Fundamental Maximum EIRP	Pass	-
3.3	15.407(a)(7)	Fundamental Power Spectral Density	Pass	-
3.4	15.407(b)(6)	In-Band Emissions (Channel Mask)	Pass	-
-	15.407(d)(6)	Contention Based Protocol	Not Required	Dual Client Standard Client
-	15.407 KDB 987594 D02 Section II. K.	Dual Client Test	Not Required	Dual Client EIRP < 24dBm
3.5	15.407(b)	Unwanted Emissions	Pass	2.72 dB under the limit at 5925.00 MHz
3.6	15.207	AC Conducted Emission	Pass	22.19 dB under the limit at 0.47 MHz
3.7	15.203 15.407(a)	Antenna Requirement	Pass	-
Note: Not required means after assessing, test items are not necessary to carry out.				

Conformity Assessment Condition:	
1. The test results (PASS/FAIL) with all measurement uncertainty excluded are presented against the regulation limits or in accordance with the requirements stipulated by the applicant/manufacture who shall bear all the risks of non-compliance that may potentially occur if measurement uncertainty is taken into account.	
2. The measurement uncertainty please refer to each test result in the section "Measurement Uncertainty".	
Disclaimer:	
The product specifications of the EUT presented in the test report that may affect the test assessments are declared by the manufacturer who shall take full responsibility for the authenticity.	

Reviewed by: William Chen
Report Producer: Michelle Chen



1 General Description

1.1 Product Feature of Equipment Under Test

Product Feature
<p>General Specs GSM/WCDMA/LTE/5G NR, Bluetooth, BLE, BLE channel sounding, Wi-Fi 2.4GHz 802.11b/g/n/ac/ax, Wi-Fi 5GHz 802.11a/n/ac/ax, Wi-Fi 6GHz 802.11a/ax, NFC, WPC Rx and GNSS Rx.</p> <p>Antenna Type WLAN: <Ant. 4>: ILA Antenna <Ant. 3>: IFA Antenna</p>

EUT Information List	
S/N	Performed Test Item
38011JEKB00290	RF Conducted Measurement
38011JEKB00050	Radiated Spurious Emission
38011JEKB00085	Conducted Emission

Antenna information		
5925 MHz ~ 6425 MHz	Peak Gain (dBi)	Ant. 4: -2.7 Ant. 3: -3.8
6525 MHz ~ 6875 MHz	Peak Gain (dBi)	Ant. 4: -4.1 Ant. 3: -4.1

Remark: The EUT's information above is declared by manufacturer. Please refer to Disclaimer in report summary.

1.1.1 Antenna Directional Gain

<For CDD Mode>

Follows FCC KDB 662911 D01 Multiple Transmitter Output v02r01 F)2)f)ii)

Directional gain = G_{ANT} + Array Gain, where Array Gain is as follows:

For power measurements on IEEE 802.11 devices,

Array Gain = 0 dB (i.e., no array gain) for $N_{ANT} \leq 4$.

G_{ANT} is set equal to the gain of the antenna having the highest gain.

For PSD measurements, the directional gain calculation.

$$DirectionalGain = 10 \cdot \log \left[\frac{\sum_{j=1}^{N_{SS}} \left\{ \sum_{k=1}^{N_{ANT}} g_{j,k} \right\}^2}{N_{ANT}} \right]$$

where

Each antenna is driven by no more than one spatial stream;

N_{SS} = the number of independent spatial streams of data;

N_{ANT} = the total number of antennas

$g_{j,k} = 10^{G_k / 20}$ if the k th antenna is being fed by spatial stream j , or zero if it is not;
 G_k is the gain in dBi of the k th antenna.

As minimum $N_{SS}=1$ is supported by EUT, the formula can be simplified as:

Directional gain = $10 \cdot \log \left[\left(10^{G_1 / 20} + 10^{G_2 / 20} + \dots + 10^{G_N / 20} \right)^2 / N_{ANT} \right]$ dBi

Where G_1, G_2, \dots, G_N denote single antenna gain.

The directional gain "DG" is calculated as following table.

			DG	DG
			for	for
	Ant 4	Ant 3	Power	PSD
	(dBi)	(dBi)	(dBi)	(dBi)
5925 MHz ~ 6425 MHz	-2.70	-3.80	-2.70	-0.22
6525 MHz ~ 6875 MHz	-4.10	-4.10	-4.10	-1.09

Calculation example:

If a device has two antenna, $G_{ANT4} = -2.7$ dBi; $G_{ANT3} = -3.8$ dBi

Directional gain of power measurement = $\max(-2.7, -3.8) + 0 = -2.7$ dBi

Directional gain of PSD derived from formula which is

$$10 \times \log \left\{ \left[\left(10^{(-2.7 \text{ dBi} / 20)} + 10^{(-3.8 \text{ dBi} / 20)} \right)^2 / 2 \right] \right\}$$

= -0.22 dBi



1.2 Modification of EUT

No modifications made to the EUT during the testing.

1.3 Testing Location

Test Site	Sporton International Inc. Wensan Laboratory
Test Site Location	No.58, Aly. 75, Ln. 564, Wenhua 3rd, Rd., Guishan Dist., Taoyuan City 333010, Taiwan (R.O.C.) TEL: +886-3-327-0868 FAX: +886-3-327-0855
Test Site No.	Sporton Site No. TH05-HY, CO07-HY, 03CH15-HY

Note: The test site complies with ANSI C63.4 2014 requirement.

FCC designation No.: TW3786

1.4 Applicable Standards

According to the specifications declared by the manufacturer, the EUT must comply with the requirements of the following standards:

- ♦ FCC Part 15 Subpart E
- ♦ FCC KDB 789033 D02 General UNII Test Procedures New Rules v02r01.
- ♦ FCC KDB 987594 D02 U-NII 6 GHz EMC Measurement v02r01
- ♦ FCC KDB 414788 D01 Radiated Test Site v01r01.
- ♦ FCC KDB 662911 D01 Multiple Transmitter Output v02r01.
- ♦ ANSI C63.10-2013

Remark:

1. All the test items were validated and recorded in accordance with the standards without any modification during the testing.
2. The TAF code is not including all the FCC KDB listed without accreditation.



2 Test Configuration of Equipment Under Test

- a. The EUT has been associated with peripherals and configuration operated in a manner tended to maximize its emission characteristics in a typical application. Frequency range investigated: conduction emission (150 kHz to 30 MHz), radiation emission (9 kHz to the 10th harmonic of the highest fundamental frequency or to 40 GHz, whichever is lower). For radiated measurement, the measured emission level of the EUT was maximized by rotating the EUT on a turntable, adjusting the orientation of the EUT antenna in three orthogonal axis (X: flat, Y: portrait, Z: landscape) and accessory (Adapter or Earphone), and adjusting the measurement antenna orientation, following C63.10 exploratory test procedures and find X plane with Adapter as worst plane.
- b. AC power line Conducted Emission was tested under maximum output power.

2.1 Carrier Frequency and Channel

BW 20M	Channel	1	5	9	13	17	21	25	29
	Freq. (MHz)	5955	5975	5995	6015	6035	6055	6075	6095
BW 40M	Channel	3		11		19		27	
	Freq. (MHz)	5965		6005		6045		6085	
BW 80M	Channel	7				23			
	Freq. (MHz)	5985				6065			

BW 20M	Channel	33	37	41	45	49	53	57	61
	Freq. (MHz)	6115	6135	6155	6175	6195	6215	6235	6255
BW 40M	Channel	35		43		51		59	
	Freq. (MHz)	6125		6165		6205		6245	
BW 80M	Channel	39				55			
	Freq. (MHz)	6145				6225			

BW 20M	Channel	65	69	73	77	81	85	89	93
	Freq. (MHz)	6275	6295	6315	6335	6355	6375	6395	6415
BW 40M	Channel	67		75		83		91	
	Freq. (MHz)	6285		6325		6365		6405	
BW 80M	Channel	71				87			
	Freq. (MHz)	6305				6385			



BW 20M	Channel	117	121	125
	Freq. (MHz)	6535	6555	6575
BW 40M	Channel	-		123
	Freq. (MHz)	-		6565
BW 80M	Channel	-		
	Freq. (MHz)	-		

BW 20M	Channel	129	133	137	141	145	149	153	157
	Freq. (MHz)	6595	6615	6635	6655	6675	6695	6715	6735
BW 40M	Channel	131		139		147		155	
	Freq. (MHz)	6605		6645		6685		6725	
BW 80M	Channel	135				151			
	Freq. (MHz)	6625				6705			

BW 20M	Channel	161	165	169	173	177	181
	Freq. (MHz)	6755	6775	6795	6815	6835	6855
BW 40M	Channel	163		171		179	
	Freq. (MHz)	6765		6805		6845	
BW 80M	Channel	167				-	
	Freq. (MHz)	6785				-	



2.2 Test Mode

This device support 26/52/106/242/484/996-tone RU channel.

The PSD of partial RU is reduced to be smaller than full RU according to TCB workshop interim guidance Oct. 2022.

The 802.11ax mode is investigated among different tones, full resource units (RU), partial resource units. The partial RU has no higher power than full RU's, thus the full RU is chosen as main test configuration.

The partial RU modes in HE40/HE80 are covered by modes in HE20 because the power setting is identical

The 242-tone RU is covered by 20MHz channel, 484-tone RU is covered by 40MHz channel and 996-tone RU is covered by 80MHz channel.

The SISO mode conducted power is covered by MIMO mode per chain, so only the MIMO mode is tested.

The final test modes include the worst data rates for each modulation shown in the table below.

MIMO Mode

Modulation	Data Rate
802.11a	6Mbps
802.11ax HE20	MCS0
802.11ax HE40	MCS0
802.11ax HE80	MCS0

Remark: The conducted power level of each chain in MIMO mode is equal or higher than SISO mode.



Test Cases	
AC Conducted Emission	Mode 1 : 5G NR n5 Link + WLAN (6GHz) Link + Bluetooth on + NFC on + USB Cable 3 (Charging from AC Adapter 2) + Handset mode ; Battery < 50%
Remark:	
<ol style="list-style-type: none"> For Radiated Test Cases, the tests were performed with Adapter 1 and USB Cable 3. During the preliminary test, both charging modes (Adapter mode and WPC Rx mode) were verified. It is determined that the adaptor mode is the worst case for official test. 	

Ch. #		UNII-5 (5925-6425 MHz)	UNII-7 (6525-6875 MHz)
		802.11a	802.11a
L	Low	001	117
M	Middle	049	149
H	High	093	181

Ch. #		UNII-5 (5925-6425 MHz)	UNII-7 (6525-6875 MHz)
		802.11ax HE20	802.11ax HE20
L	Low	001	117
M	Middle	049	149
H	High	093	181

Ch. #		UNII-5 (5925-6425 MHz)	UNII-7 (6525-6875 MHz)
		802.11ax HE40	802.11ax HE40
L	Low	003	123
M	Middle	051	147
H	High	091	179

Ch. #		UNII-5 (5925-6425 MHz)	UNII-7 (6525-6875 MHz)
		802.11ax HE80	802.11ax HE80
L	Low	007	135
M	Middle	055	151
H	High	087	167

Remark: For radiation spurious emission, the modulation and the data rate picked for testing are determined by the Max. RF conducted power.

2.3 Connection Diagram of Test System

<AC Conducted Emission Mode>

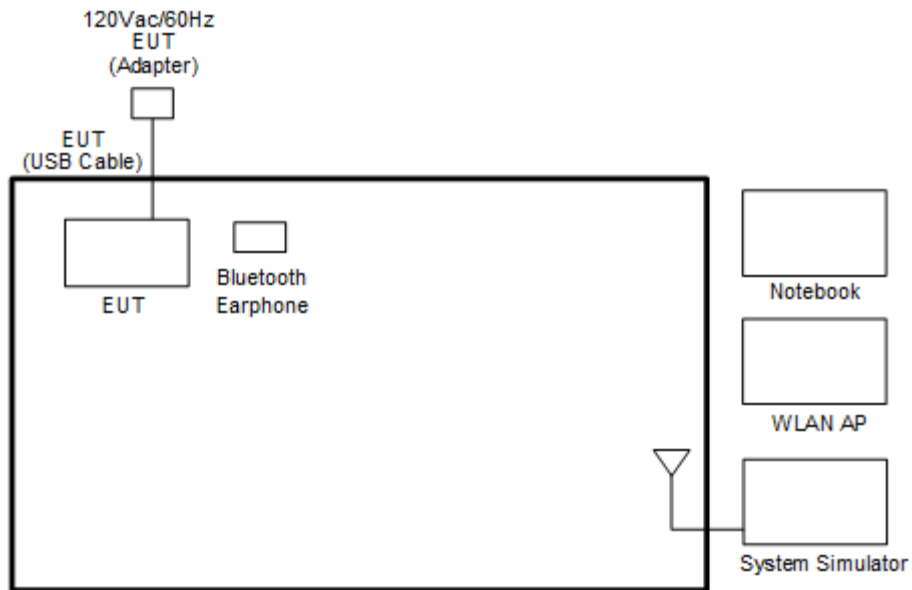

<WLAN Tx Mode>

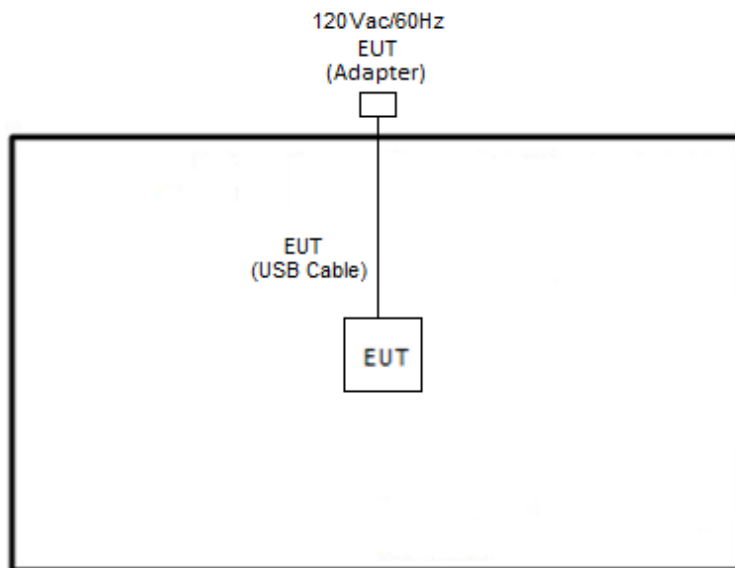



2.4 Support Unit used in test configuration and system

Item	Equipment	Brand Name	Model Name	FCC ID	Data Cable	Power Cord
1.	System Simulator	Anritsu	MT8820C	N/A	N/A	Unshielded, 1.8m
2.	Bluetooth Earphone	Sony Ericsson	MW600	PY700A2029	N/A	N/A
3.	WLAN AP	Netgear	RAXE500	PY320300508	N/A	Unshielded, 1.8m
4.	Notebook	Dell	Latitude 3400	FCC DoC	N/A	AC I/P: Unshielded, 1.2 m DC O/P: Shielded, 1.8 m

2.5 EUT Operation Test Setup

The RF test items, utility “cmd Ver.10.0.17134.1304” was installed in Notebook which was programmed in order to make the EUT get into the engineering modes to provide channel selection, power level, data rate and the application type and for continuous transmitting signals.

2.6 Measurement Results Explanation Example

For all conducted test items:

The offset level is set in the spectrum analyzer to compensate the RF cable loss and attenuator factor between EUT conducted output port and spectrum analyzer. With the offset compensation, the spectrum analyzer reading level is exactly the EUT RF output level.

Example :

The spectrum analyzer offset is derived from RF cable loss and attenuator factor.

Offset = RF cable loss + attenuator factor.

Following shows an offset computation example with cable loss 4.2 dB and 10dB attenuator.

$$\begin{aligned} \text{Offset(dB)} &= \text{RF cable loss(dB)} + \text{attenuator factor(dB)}. \\ &= 4.2 + 10 = 14.2 \text{ (dB)} \end{aligned}$$

3 Test Result

3.1 26dB & 99% Occupied Bandwidth Measurement

3.1.1 Limit of 26dB & 99% Occupied Bandwidth

<FCC 14-30 CFR 15.407>

(a)(10) The maximum transmitter channel bandwidth for U-NII devices in the 5.925-7.125 GHz band is 320 megahertz.

3.1.2 Measuring Instruments

Please refer to the measuring equipment list in this test report.

3.1.3 Test Procedures

1. The testing follows FCC KDB 789033 D02 General UNII Test Procedures New Rules v02r01. Section C) Emission bandwidth
2. Set RBW = approximately 1% of the emission bandwidth.
3. Set the VBW > RBW.
4. Detector = Peak.
5. Trace mode = max hold
6. Measure the maximum width of the emission that is 26 dB down from the peak of the emission. Compare this with the RBW setting of the analyzer. Readjust RBW and repeat measurement as needed until the RBW/EBW ratio is approximately 1%.
7. For 99% Bandwidth Measurement, the spectrum analyzer's resolution bandwidth (RBW) is set 1-5% of the emission bandwidth and set the Video bandwidth (VBW) $\geq 3 * RBW$.
8. Measure and record the results in the test report.

3.1.4 Test Setup

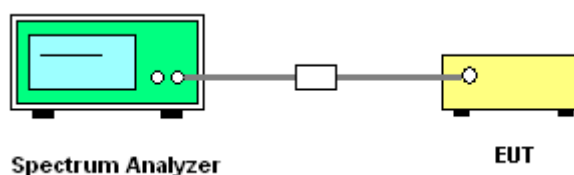

3.1.5 Test Result of 26dB & 99% Occupied Bandwidth

Please refer to Appendix A.



MIMO <Ant. 4+3>

<802.11a>

Channel 001

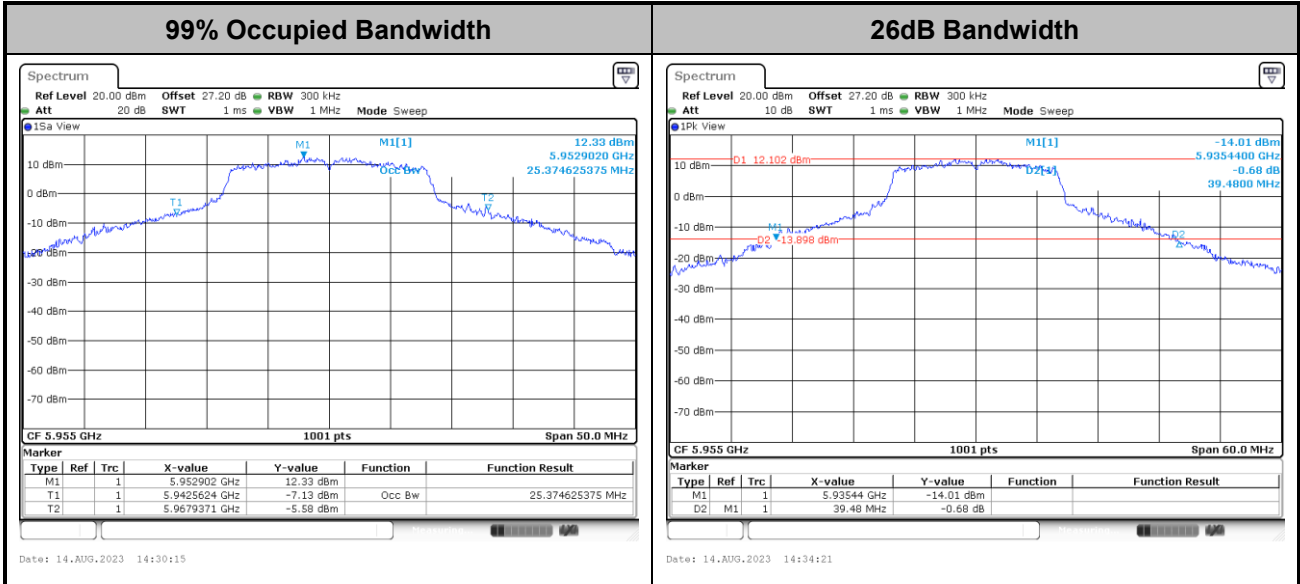

Channel 117

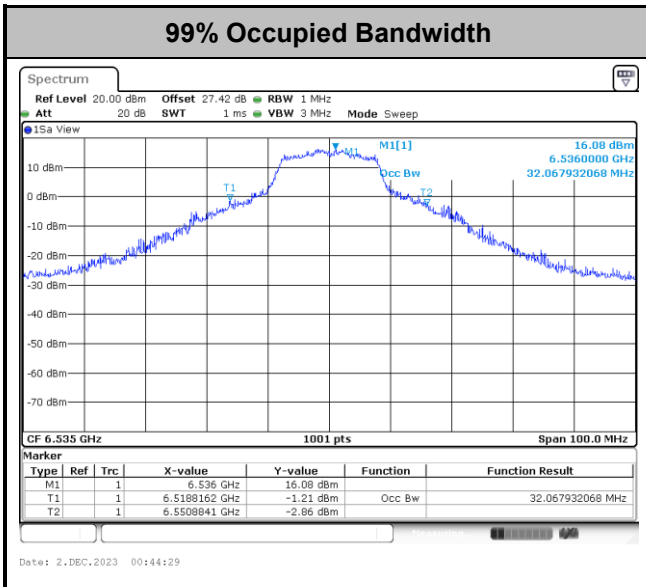

Note: The occupied channel bandwidth is maintained within the band of operation for all of the modulations.



<802.11ax HE20>

Channel 001

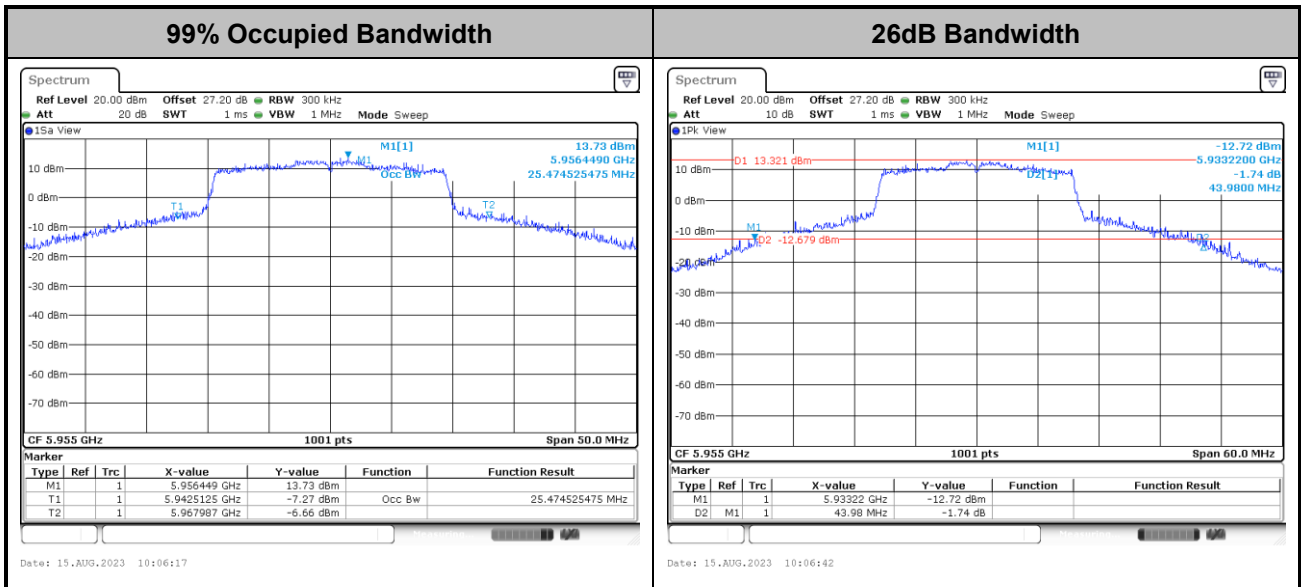

Channel 117

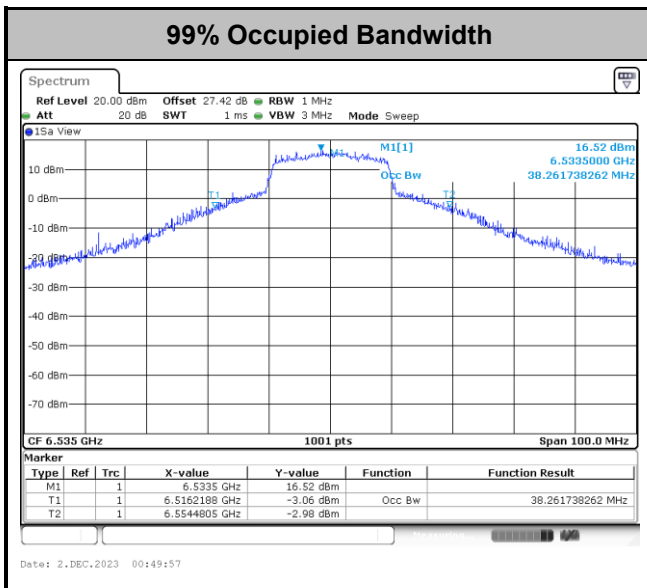

Note: The occupied channel bandwidth is maintained within the band of operation for all of the modulations.



<802.11ax HE40>

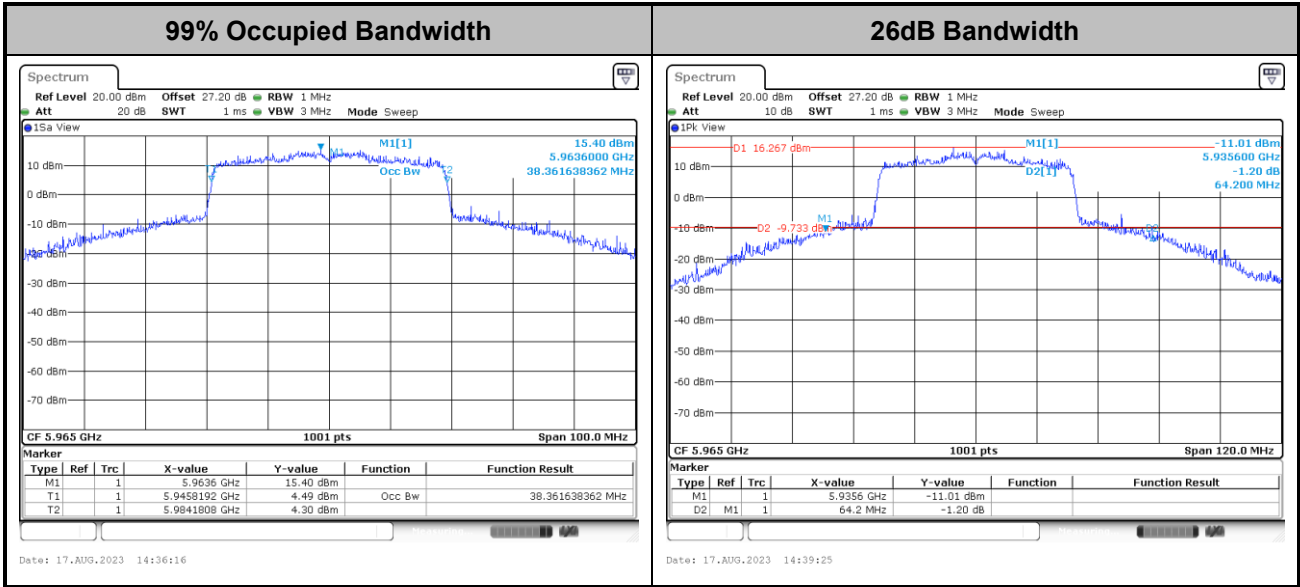

Note: The occupied channel bandwidth is maintained within the band of operation for all of the modulations.

<802.11ax HE80>

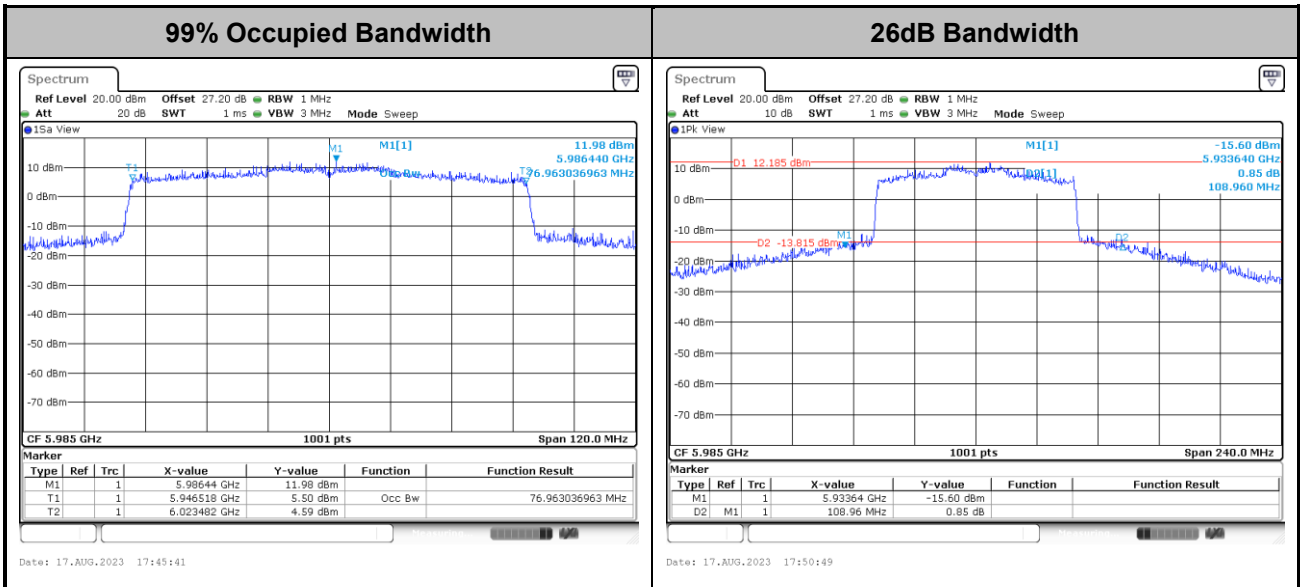

Note: The occupied channel bandwidth is maintained within the band of operation for all of the modulations.

3.2 Fundamental Maximum EIRP Measurement

3.2.1 Limit of Fundamental Maximum EIRP

<FCC 14-30 CFR 15.407>

(a)(7) For client devices, except for fixed client devices as defined in this subpart, operating under the control of a standard power access

point in 5.925-6.425 GHz and 6.525-6.875 GHz bands, the maximum power spectral density must not exceed 17 dBm e.i.r.p. in any 1-megahertz band, and the maximum e.i.r.p. over the frequency band of operation must not exceed 30 dBm and the device must limit its power to no more than 6 dB below its associated standard power access point's authorized transmit power.

3.2.2 Measuring Instruments

Please refer to the measuring equipment list in this test report.

3.2.3 Test Procedures

The testing follows Method PM-G of FCC KDB 789033 D02 General UNII Test Procedures New Rules v02r01.

Method PM-G (Measurement using a gated RF average power meter):

1. Measurement is performed using a wideband RF power meter.
2. The EUT is configured to transmit at its maximum power control level.
3. Measure the average power of the transmitter.
4. Since the measurement is made only during the ON time of the transmitter, no duty cycle correction factor is required.
5. For MIMO mode, calculation method follows FCC KDB 662911 D01 Multiple Transmitter Output v02r01.

3.2.4 Test Setup

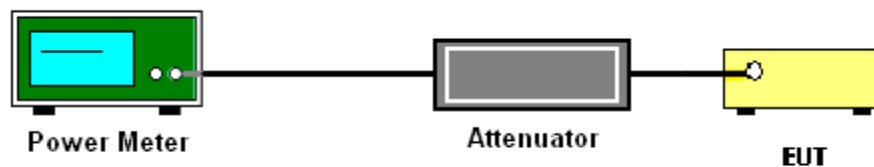

3.2.5 Test Result of Fundamental Maximum EIRP

Please refer to Appendix A.



3.3 Fundamental Power Spectral Density Measurement

3.3.1 Limit of Fundamental Power Spectral Density

<FCC 14-30 CFR 15.407>

(a)(7) For client devices, except for fixed client devices as defined in this subpart, operating under the control of a standard power access point in 5.925-6.425 GHz and 6.525-6.875 GHz bands, the maximum power spectral density must not exceed 17 dBm e.i.r.p. in any 1-megahertz band.

3.3.2 Measuring Instruments

Please refer to the measuring equipment list in this test report.

3.3.3 Test Procedures

The testing follows FCC KDB 789033 D02 General UNII Test Procedures New Rules v02r01.

Section F) Maximum power spectral density.

Method SA-2

(trace averaging across on and off times of the EUT transmissions, followed by duty cycle correction).

- Measure the duty cycle.
 - Set span to encompass the entire emission bandwidth (EBW) of the signal.
 - Set RBW = 1 MHz.
 - Set VBW \geq 3 MHz.
 - Number of points in sweep \geq 2 Span / RBW.
 - Sweep time = auto.
 - Detector = RMS
 - Trace average at least 100 traces in power averaging mode.
 - Add $10 \log(1/x)$, where x is the duty cycle, to the measured power in order to compute the average power during the actual transmission times. For example, add $10 \log(1/0.25) = 6$ dB if the duty cycle is 25 percent.
1. The RF output of EUT was connected to the spectrum analyzer by a low loss cable.
 2. Each plot has already offset with cable loss, and attenuator loss. Measure the PPSD and record it.
 3. For MIMO mode, calculation method follows FCC KDB 662911 D01 Multiple Transmitter Output v02r01.

Method (a): Measure and sum the spectra across the outputs.

The total final Power Spectral Density is from a device with 2 transmitter outputs. The spectrum measurements of the individual outputs are all performed with the same span and number of points; the spectrum value in the first spectral bin of output 1 is summed with that in the first spectral bin of output 2 to obtain the value for the first frequency bin of the summed spectrum.

3.3.4 Test Setup

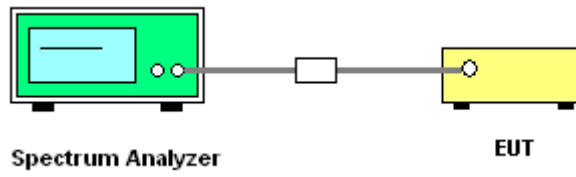

3.3.5 Test Result of Power Spectral Density

Please refer to Appendix A.



<802.11a>

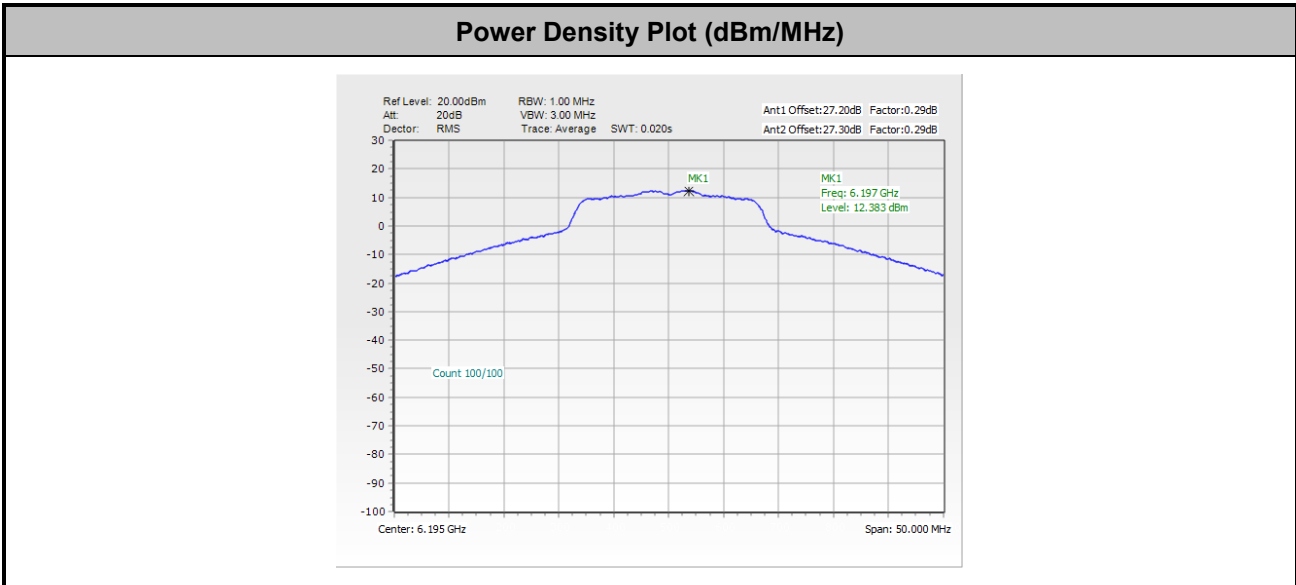

Note:

1. EIRP Power Density (dBm/MHz) = Measured value+ Duty Factor + Directional Gain
2. The test plot is showing a bin by bin combined result mathematically adds two traces.

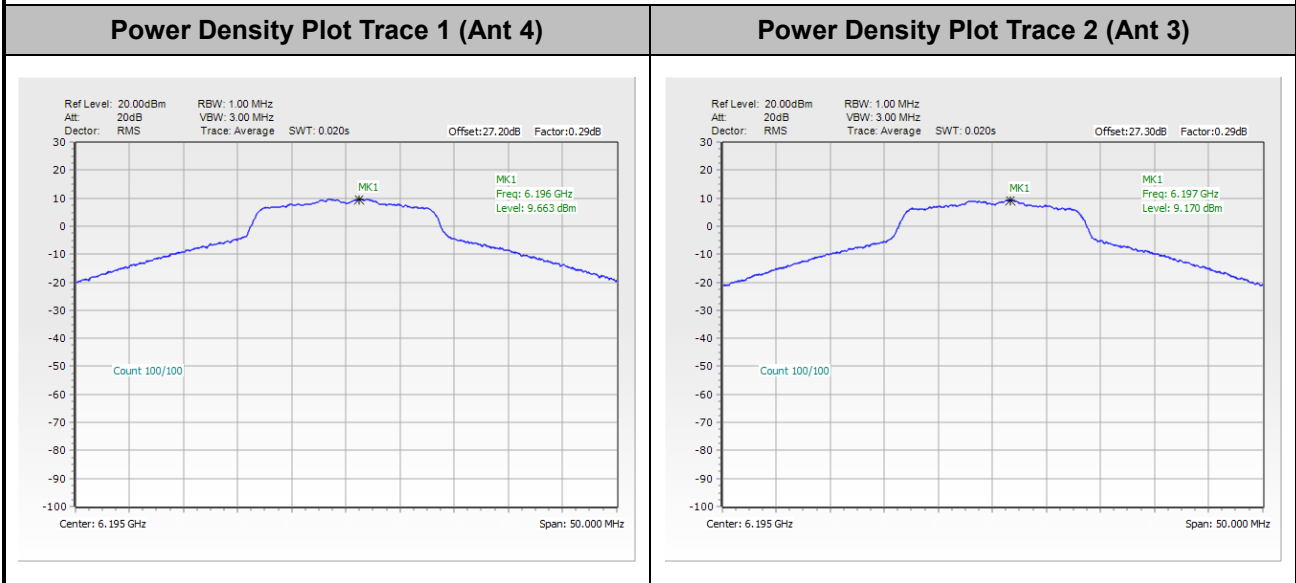



<802.11ax HE20 Full RU>

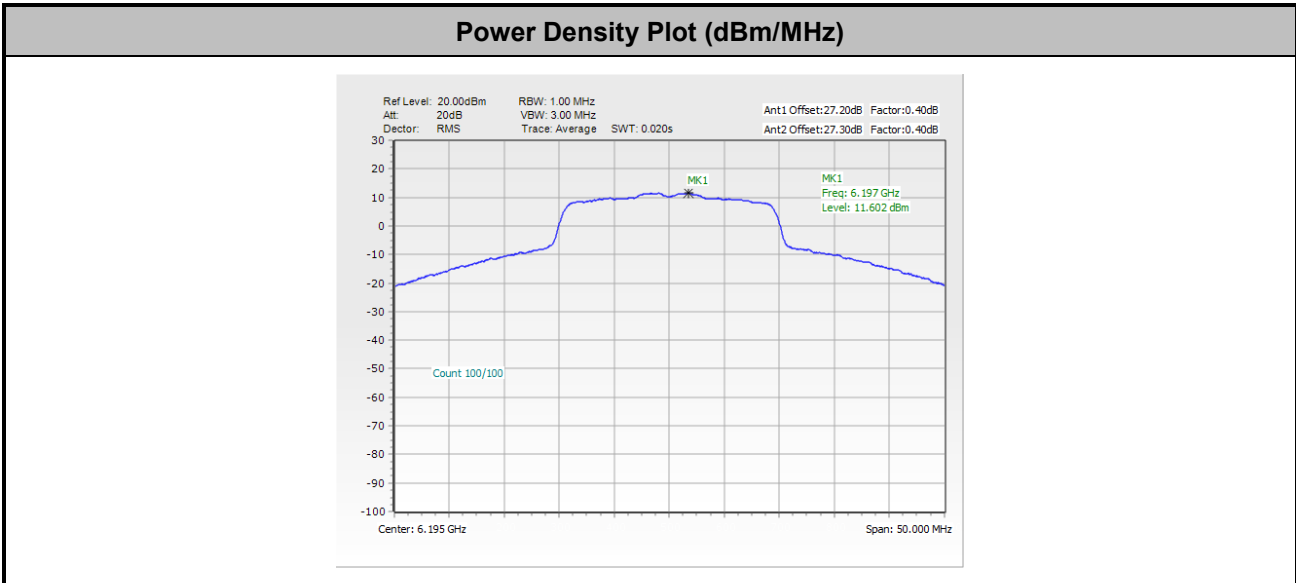

Note:

1. EIRP Power Density (dBm/MHz) = Measured value+ Duty Factor + Directional Gain
2. The test plot is showing a bin by bin combined result mathematically adds two traces.

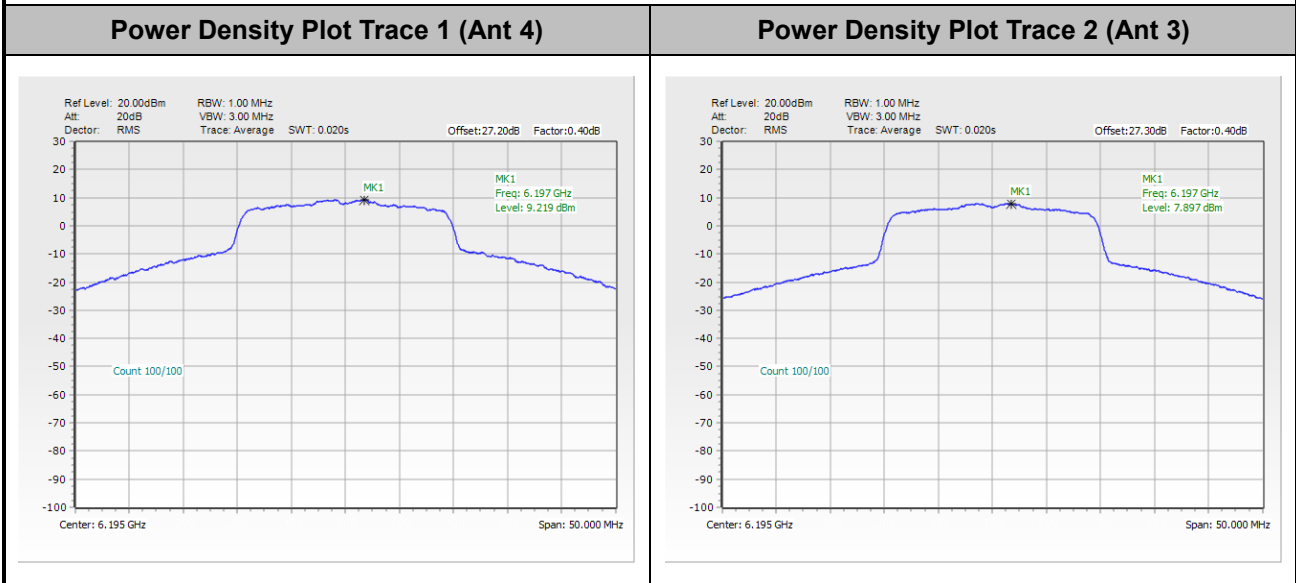



<802.11ax HE40 Full RU>

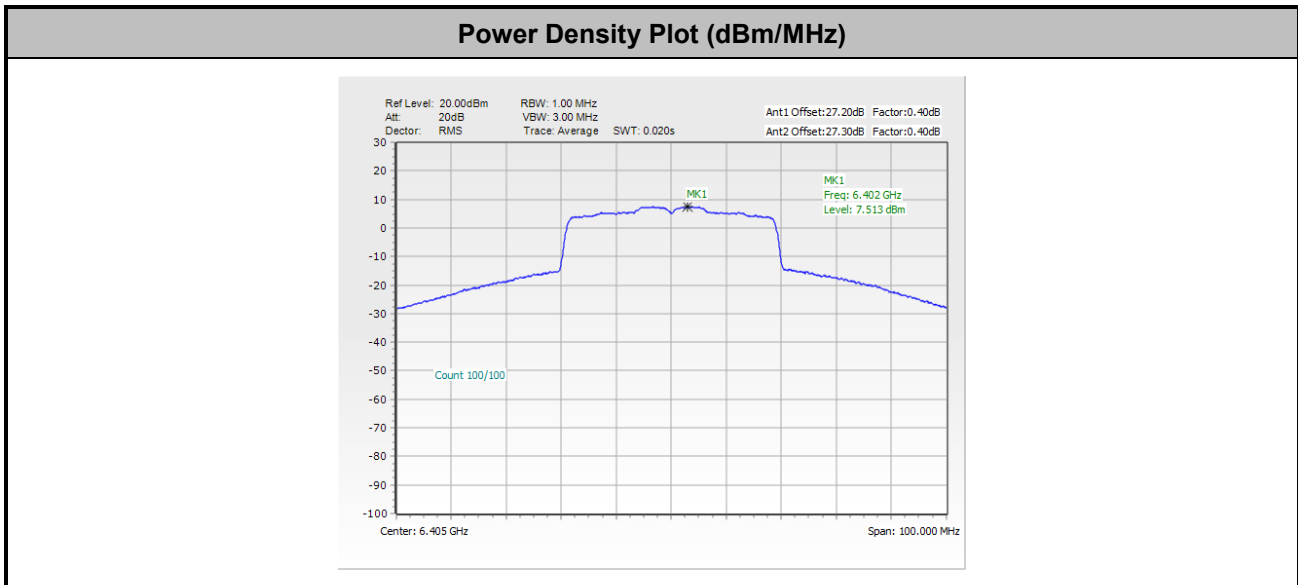

Note:

1. EIRP Power Density (dBm/MHz) = Measured value+ Duty Factor + Directional Gain
2. The test plot is showing a bin by bin combined result mathematically adds two traces.

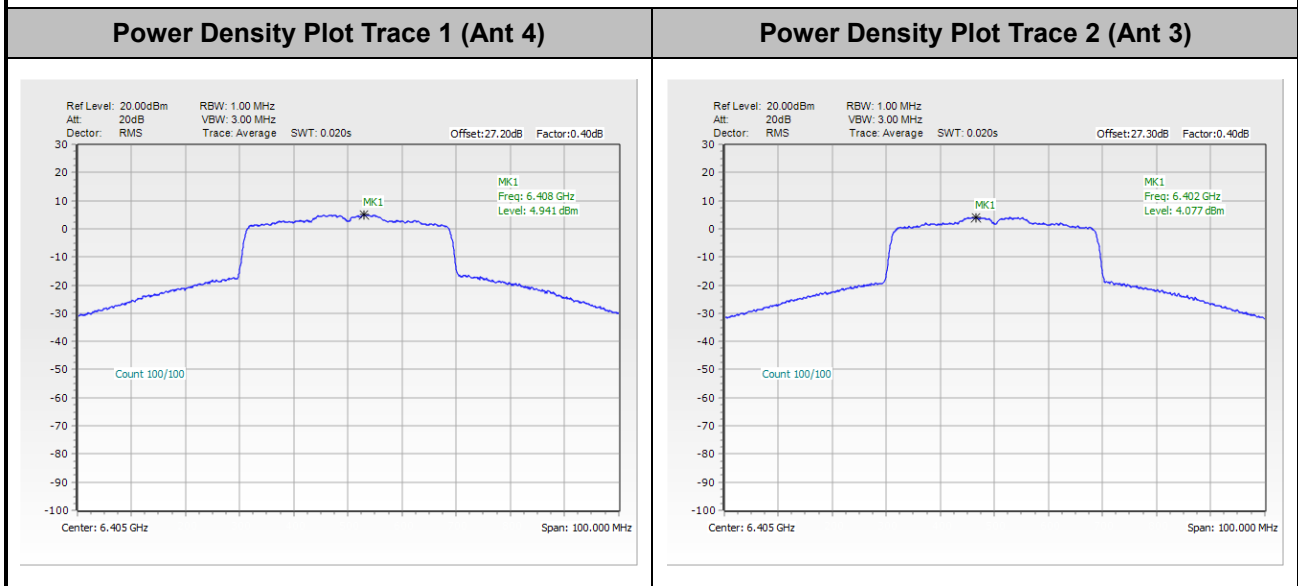



<802.11ax HE80 Full RU>

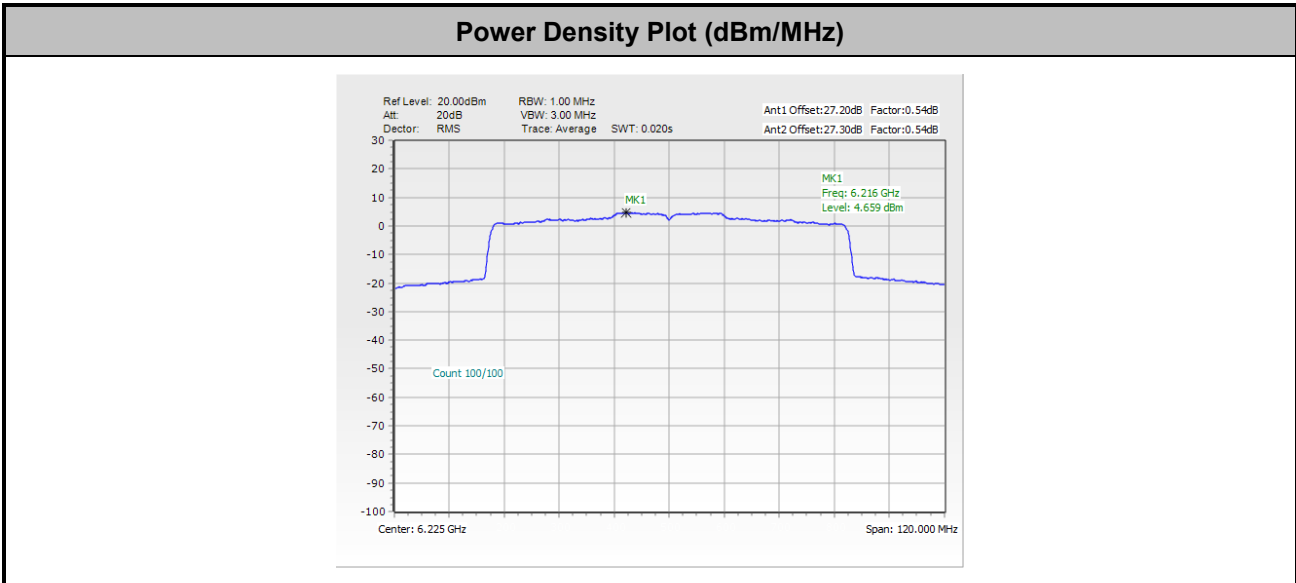

Note:

1. EIRP Power Density (dBm/MHz) = Measured value+ Duty Factor + Directional Gain
2. The test plot is showing a bin by bin combined result mathematically adds two traces.

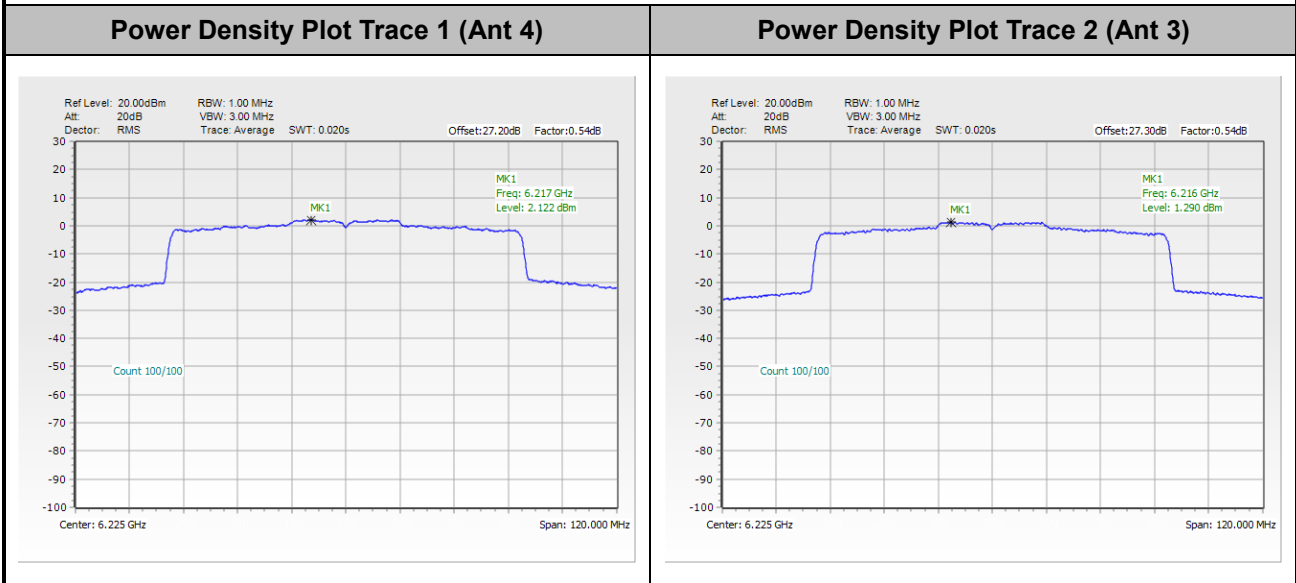



3.4 In-Band Emissions (Channel Mask)

3.4.1 Limit of Unwanted Emissions

<FCC 14-30 CFR 15.407>

(a)(6) For transmitters operating within the 5.925-7.125 GHz bands: Power spectral density must be suppressed by 20 dB at 1 MHz outside of channel edge, by 28 dB at one channel bandwidth from the channel center, and by 40 dB at one- and one-half times the channel bandwidth away from channel center. At frequencies between one megahertz outside an unlicensed device's channel edge and one channel bandwidth from the center of the channel, the limits must be linearly interpolated between 20 dB and 28 dB suppression, and at frequencies between one and one- and one-half times an unlicensed device's channel bandwidth, the limits must be linearly interpolated between 28 dB and 40 dB suppression. Emissions removed from the channel center by more than one- and one-half times the channel bandwidth must be suppressed by at least 40 dB.

3.4.2 Measuring Instruments

Please refer to the measuring equipment list in this test report.

3.4.3 Test Procedures

The testing follows FCC KDB 987594 D02 U-NII 6GHz EMC Measurement v01.

Section J) In-Band Emissions.

1. Take nominal bandwidth as reference channel bandwidth provided that 26 dB emission bandwidth is always larger than nominal bandwidth
2. Measure the power spectral density (which will be used for emissions mask reference) using the following procedure:
 - a) Set the span to encompass the entire 26 dB EBW of the signal.
 - b) Set RBW = same RBW used for 26 dB EBW measurement.
 - c) Set VBW $\geq 3 \times$ RBW
 - d) Number of points in sweep $\geq [2 \times \text{span} / \text{RBW}]$.
 - e) Sweep time = auto.
 - f) Detector = RMS (i.e., power averaging)
 - g) Trace average at least 100 traces in power averaging (rms) mode.
 - h) Use the peak search function on the instrument to find the peak of the spectrum.
3. Using the measuring equipment limit line function, develop the emissions mask based on the following requirements. The emissions power spectral density must be reduced below the peak power spectral density (in dB) as follows:
 - a. Suppressed by 20 dB at 1 MHz outside of the channel edge.
 - b. Suppressed by 28 dB at one channel bandwidth from the channel center.
 - c. Suppressed by 40 dB at one- and one-half times the channel bandwidth from the channel center.
4. Adjust the span to encompass the entire mask as necessary.
5. Clear trace.
6. Trace average at least 100 traces in power averaging (rms) mode.
7. Adjust the reference level as necessary so that the crest of the channel touches the top of the emission mask.

3.4.4 Test Setup

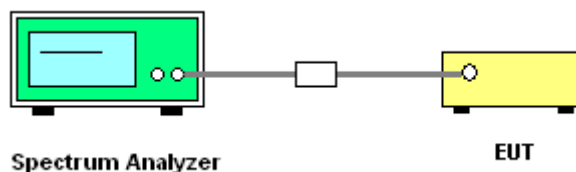



3.4.5 Test Result

MIMO <Ant. 4+3(4)>

EUT Mode : 802.11a

Plot on Channel 5955 MHz

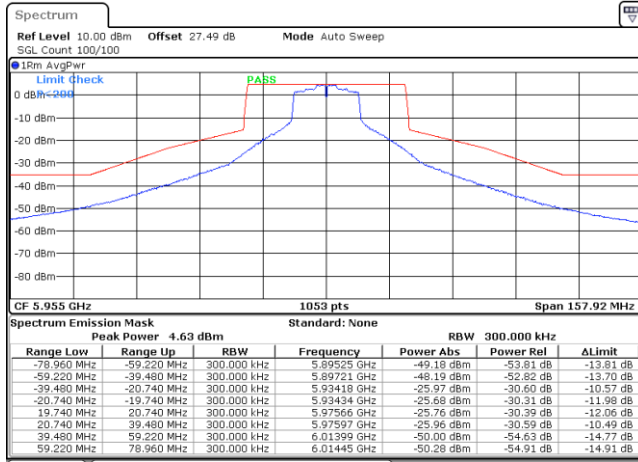

Date: 14.AUG.2023 14:35:15

Plot on Channel 6195 MHz

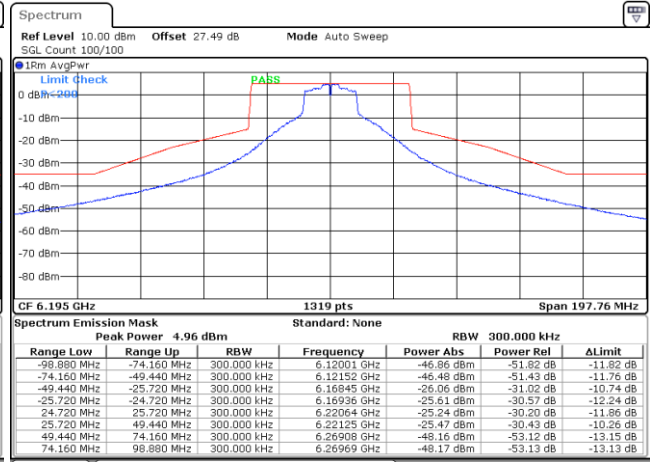

Date: 14.AUG.2023 14:51:13

Plot on Channel 6415 MHz

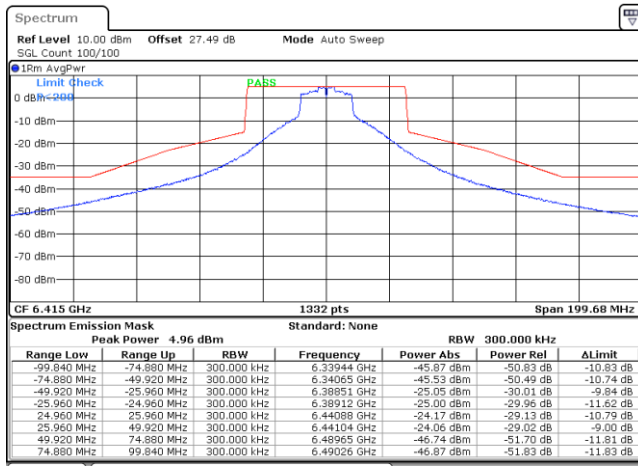

Date: 14.AUG.2023 15:53:43

Plot on Channel 6535 MHz

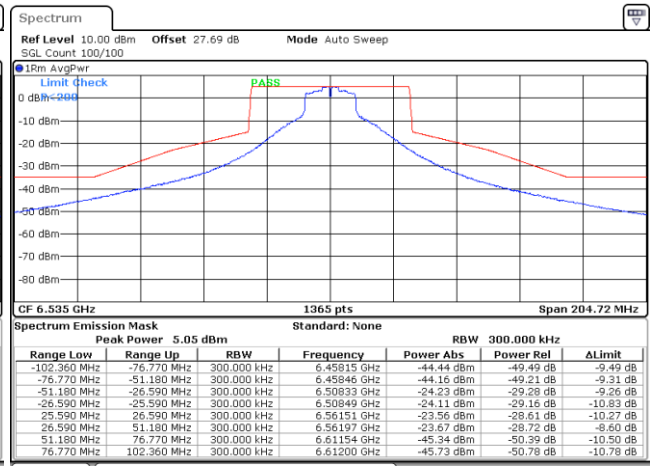

Date: 14.AUG.2023 16:15:29



Plot on Channel 6695 MHz

Plot on Channel 6855 MHz

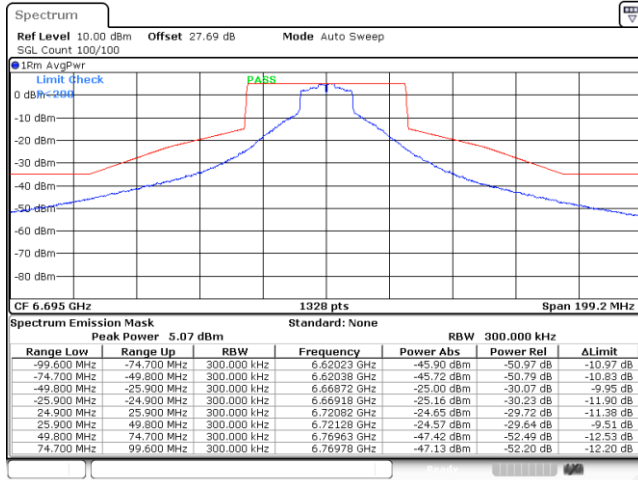

Date: 14.AUG.2023 16:40:49

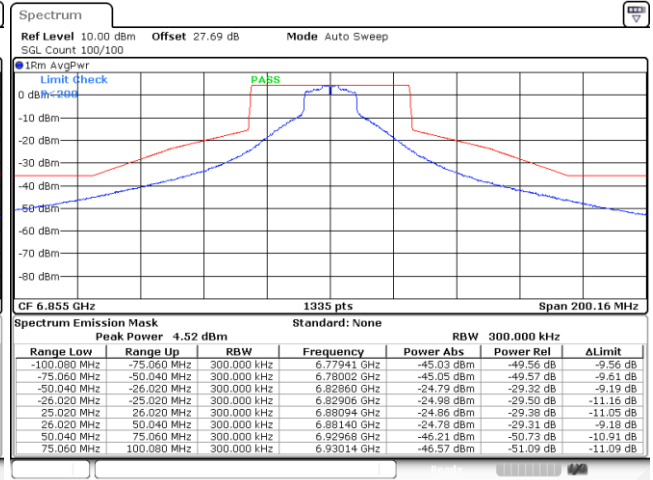

Date: 14.AUG.2023 17:05:45



EUT Mode : 802.11ax HE20 Full RU

Plot on Channel 5955 MHz

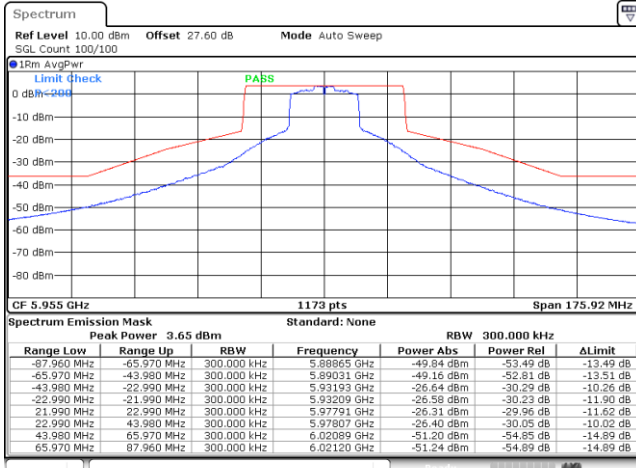

Date: 15.AUG.2023 10:07:48

Plot on Channel 6195 MHz

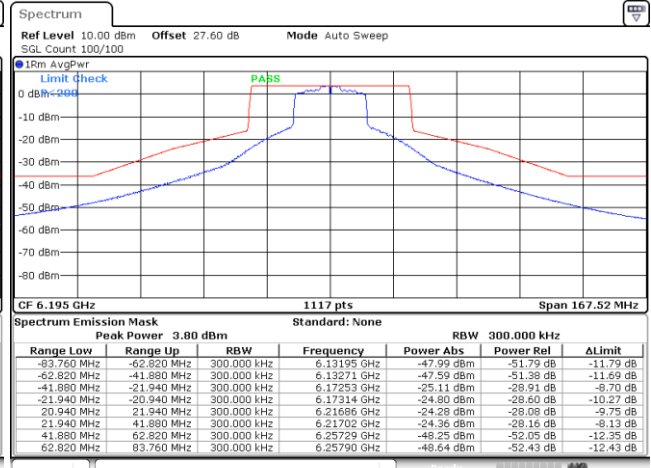

Date: 15.AUG.2023 12:02:50

Plot on Channel 6415 MHz

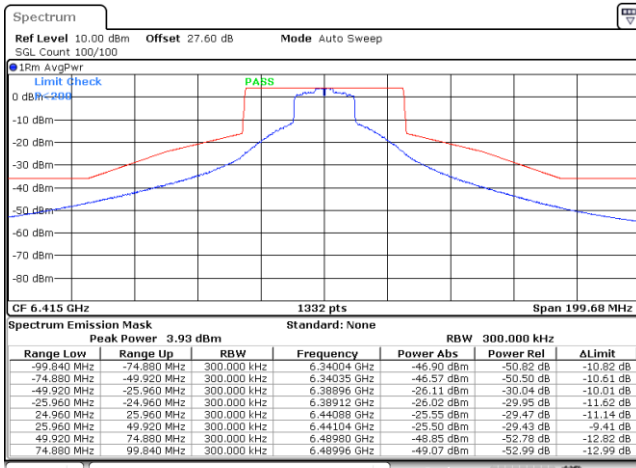

Date: 15.AUG.2023 14:46:11

Plot on Channel 6535 MHz

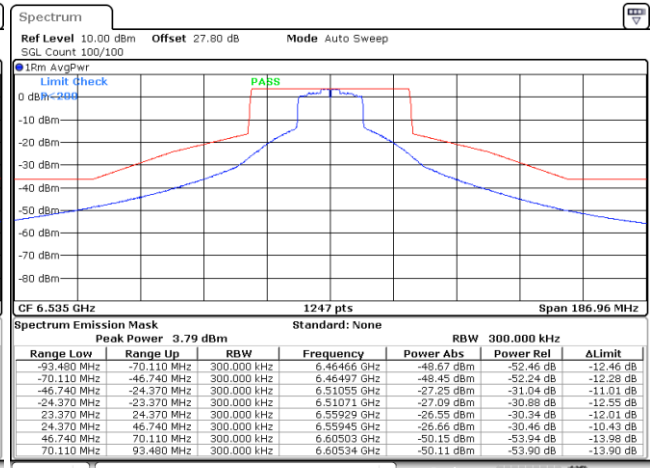

Date: 16.AUG.2023 16:56:49



Plot on Channel 6695 MHz

Plot on Channel 6855 MHz

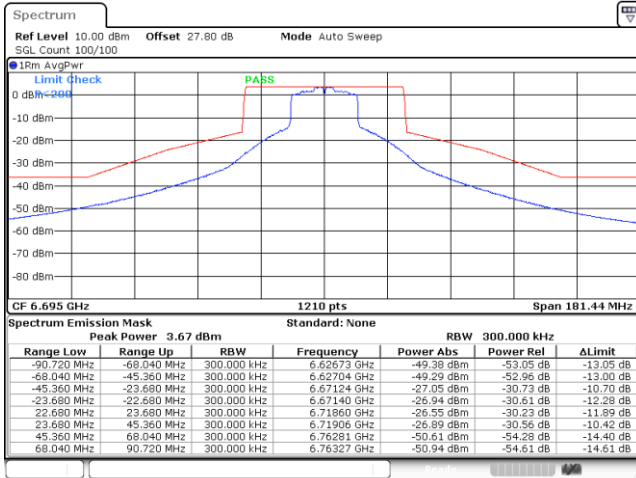

Date: 16.AUG.2023 18:01:25

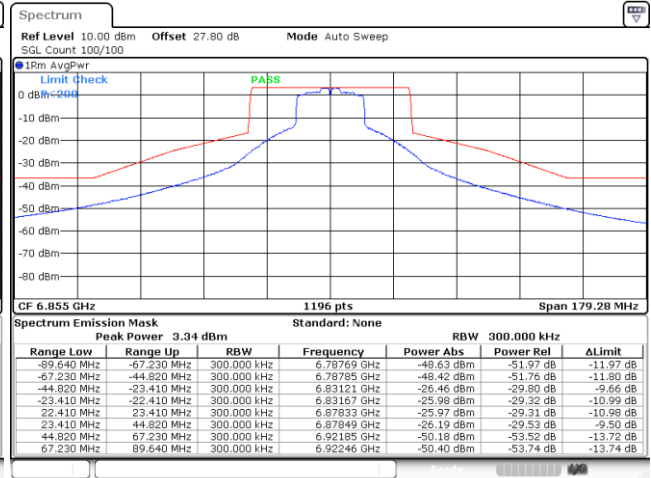

Date: 17.AUG.2023 11:55:28



EUT Mode : 802.11ax HE20 26RU0

Plot on Channel 5955 MHz

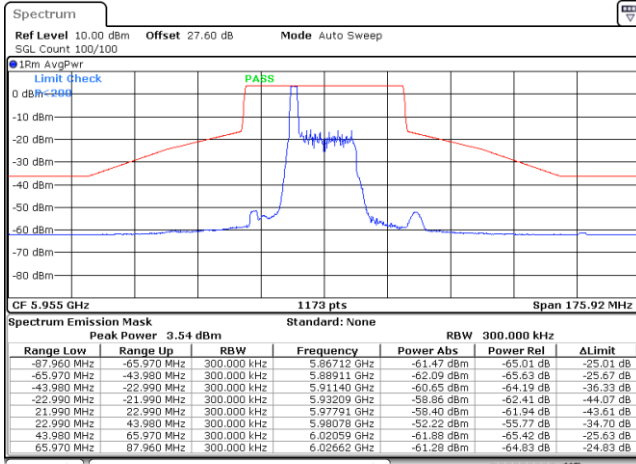

Date: 15.AUG.2023 10:43:37

Plot on Channel 6535 MHz

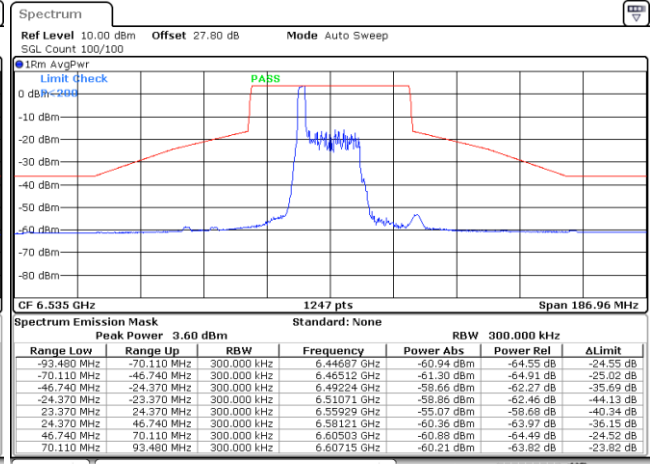

Date: 16.AUG.2023 17:26:11

EUT Mode : 802.11ax HE20 26RU4

Plot on Channel 6195 MHz

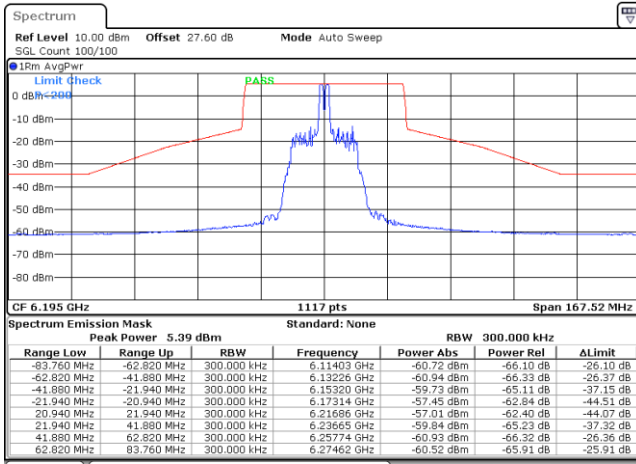

Date: 15.AUG.2023 14:09:10

Plot on Channel 6695 MHz

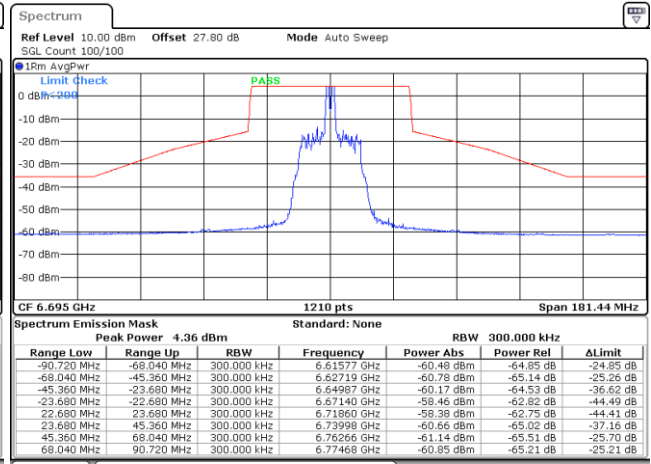

Date: 17.AUG.2023 10:32:32



EUT Mode : 802.11ax HE20 26RU8

Plot on Channel 6415 MHz

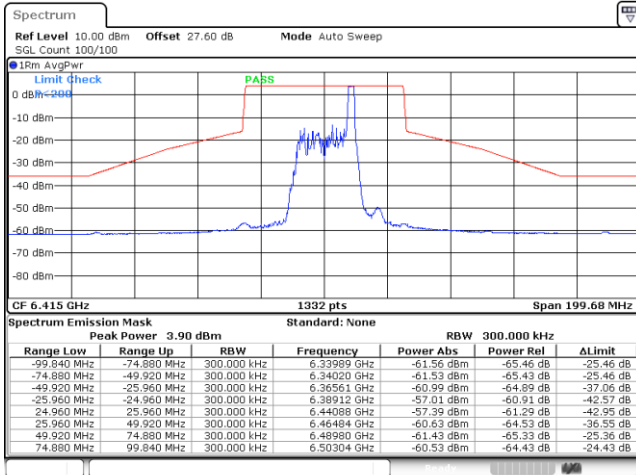

Date: 15.AUG.2023 15:58:50

Plot on Channel 6855 MHz

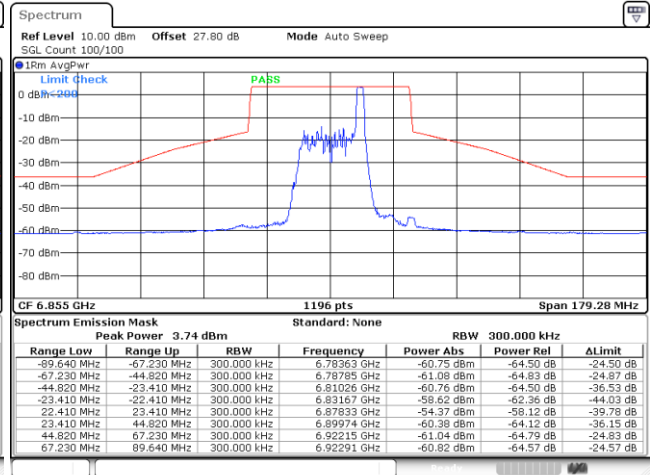

Date: 17.AUG.2023 12:06:11

EUT Mode : 802.11ax HE20 52RU37

Plot on Channel 5955 MHz

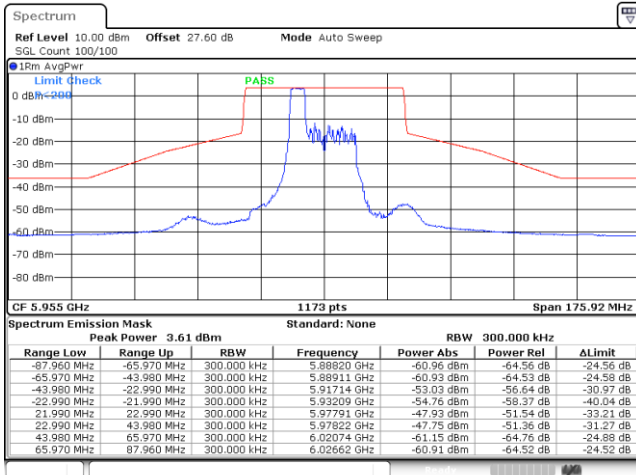

Date: 15.AUG.2023 10:56:46

Plot on Channel 6535 MHz

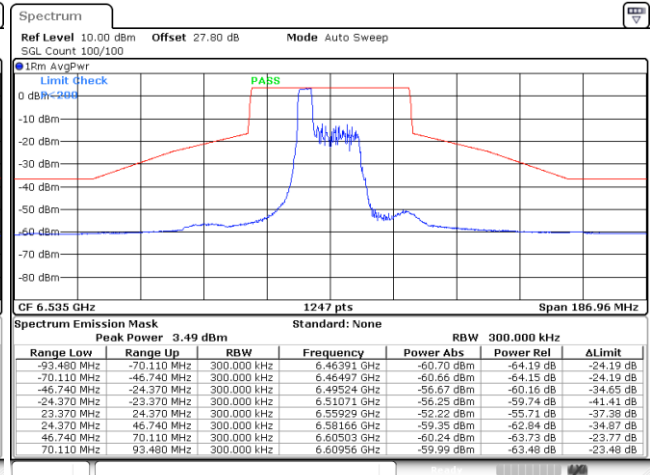

Date: 16.AUG.2023 17:45:55



EUT Mode : 802.11ax HE20 52RU38

Plot on Channel 6195 MHz

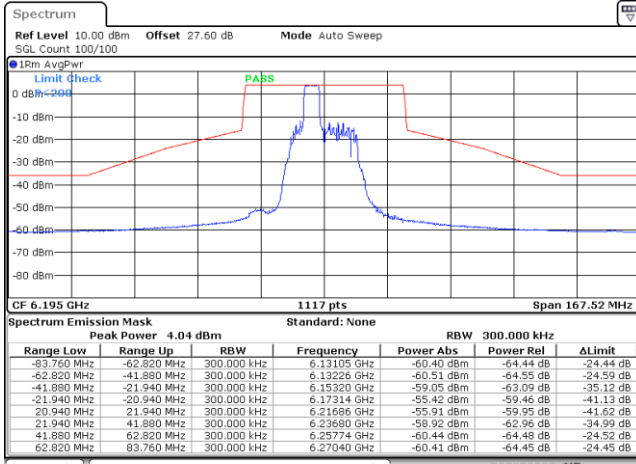

Date: 15.AUG.2023 14:23:15

Plot on Channel 6695 MHz

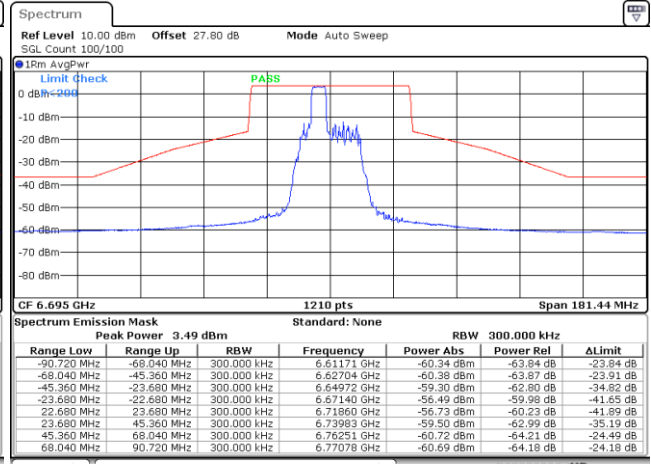

Date: 17.AUG.2023 10:55:02

EUT Mode : 802.11be EHT20 52RU40

Plot on Channel 6415 MHz

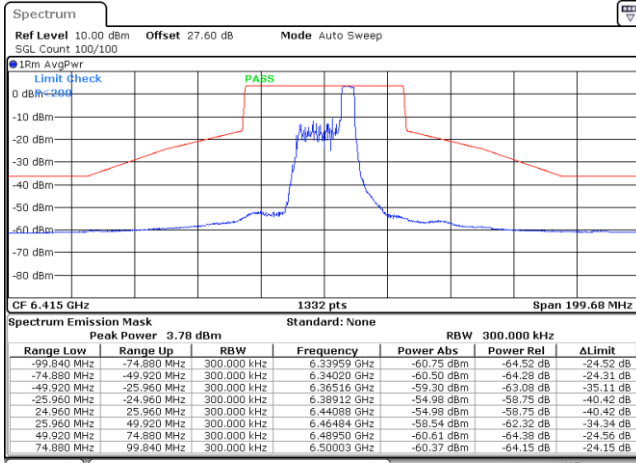

Date: 15.AUG.2023 16:11:41

Plot on Channel 6855 MHz

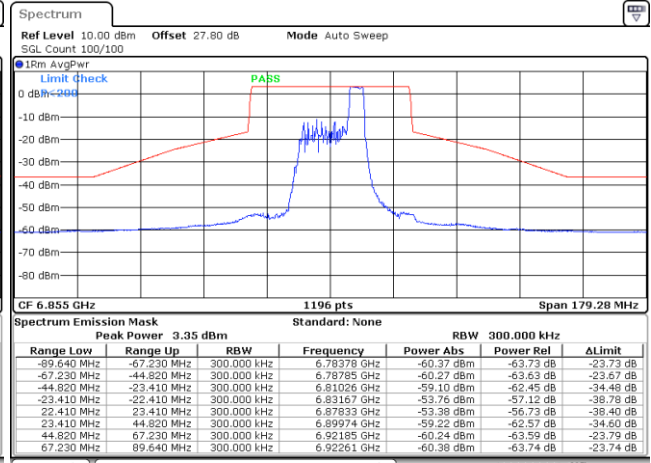

Date: 17.AUG.2023 14:06:54



EUT Mode : 802.11ax HE20 106RU53

Plot on Channel 5955 MHz

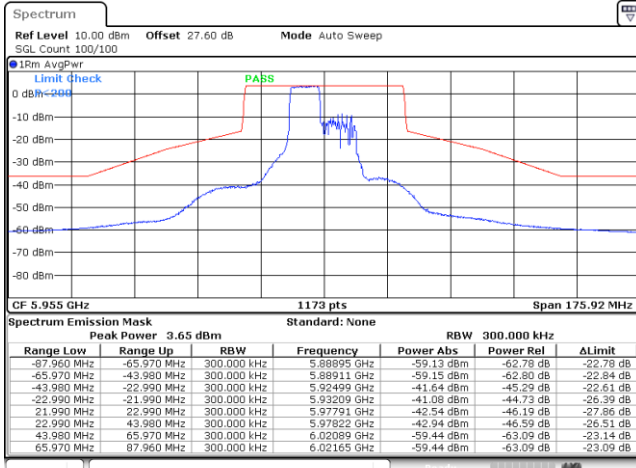

Date: 15.AUG.2023 11:50:13

Plot on Channel 6195 MHz

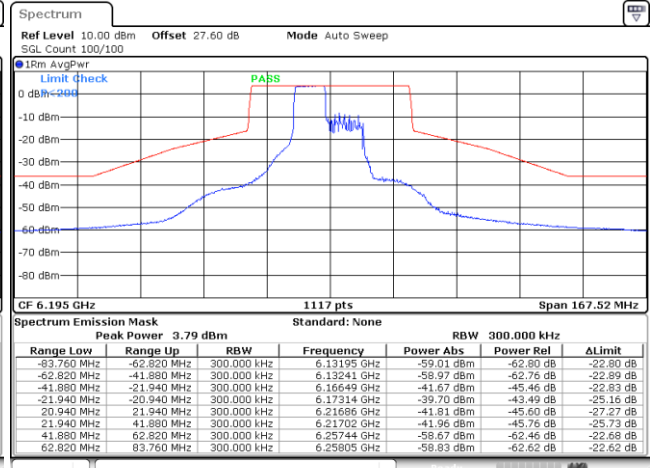

Date: 15.AUG.2023 14:37:00

Plot on Channel 6535 MHz

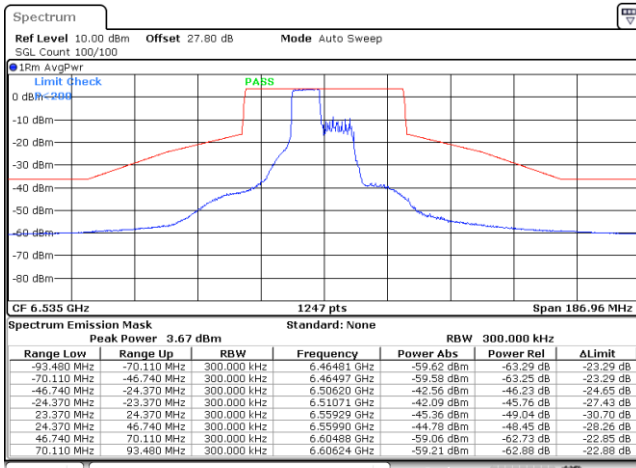

Date: 16.AUG.2023 17:56:03

Plot on Channel 6695 MHz

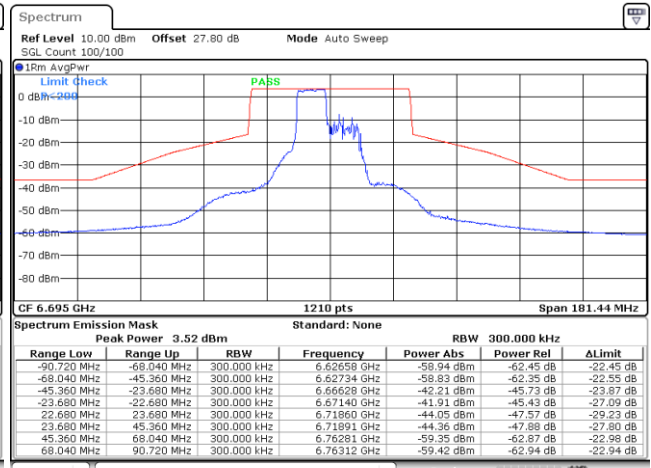

Date: 17.AUG.2023 11:15:27



EUT Mode : 802.11ax HE20 106RU54

Plot on Channel 6415 MHz

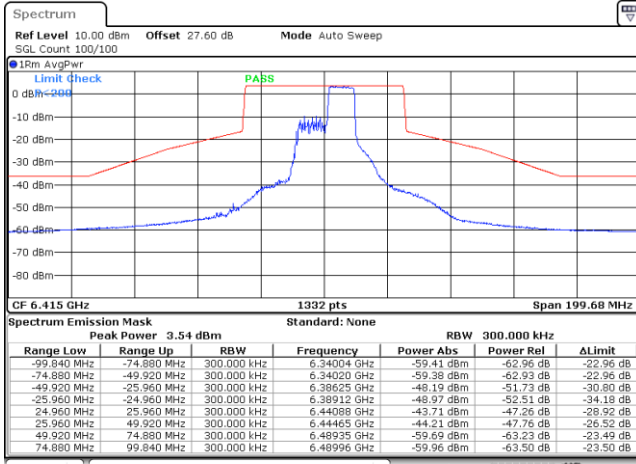

Date: 15.AUG.2023 16:39:49

Plot on Channel 6855 MHz

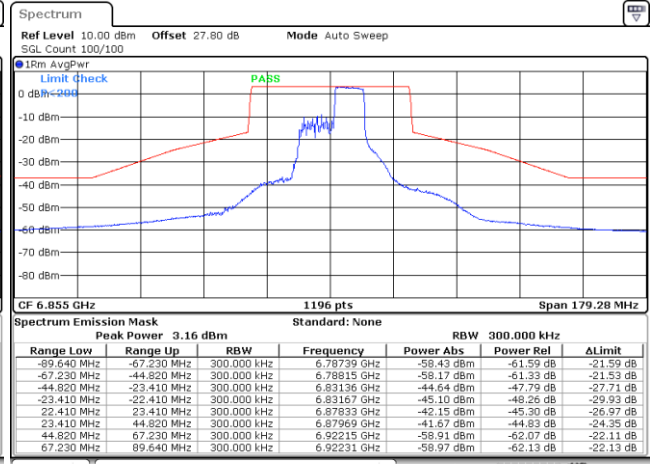

Date: 17.AUG.2023 14:21:18



EUT Mode : 802.11ax HE40 Full RU

Plot on Channel 5965 MHz

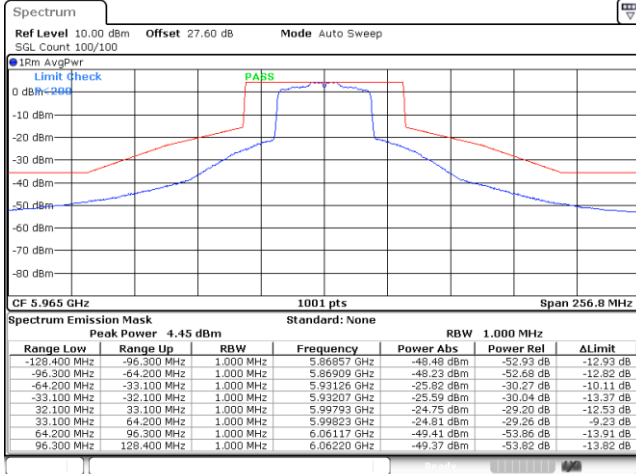

Date: 17.AUG.2023 14:40:10

Plot on Channel 6205 MHz

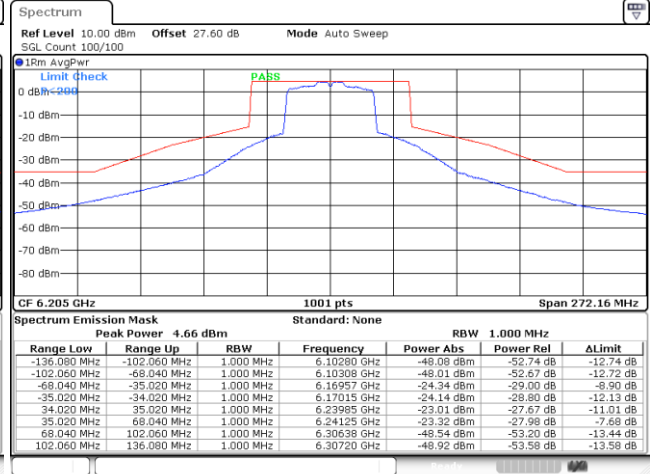

Date: 17.AUG.2023 14:55:03

Plot on Channel 6405 MHz

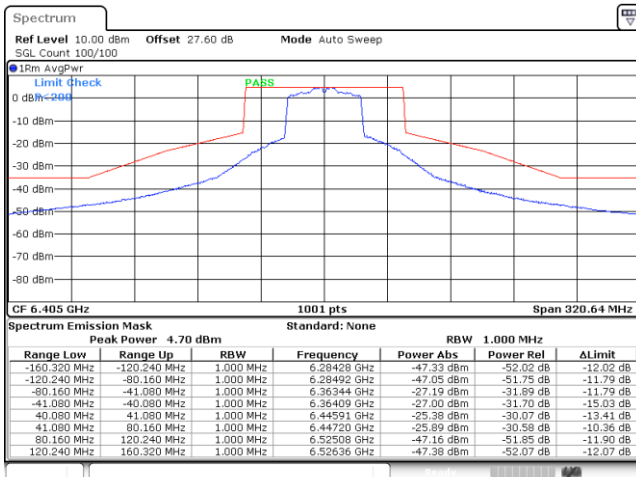

Date: 17.AUG.2023 15:02:32

Plot on Channel 6565 MHz

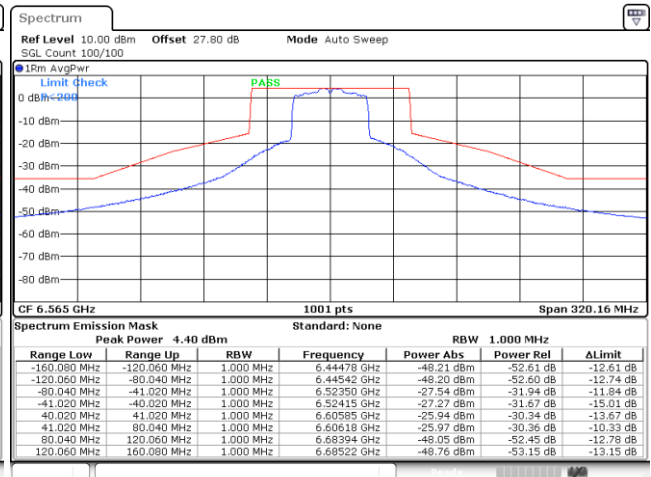

Date: 17.AUG.2023 16:53:48



Plot on Channel 6685 MHz

Plot on Channel 6845 MHz

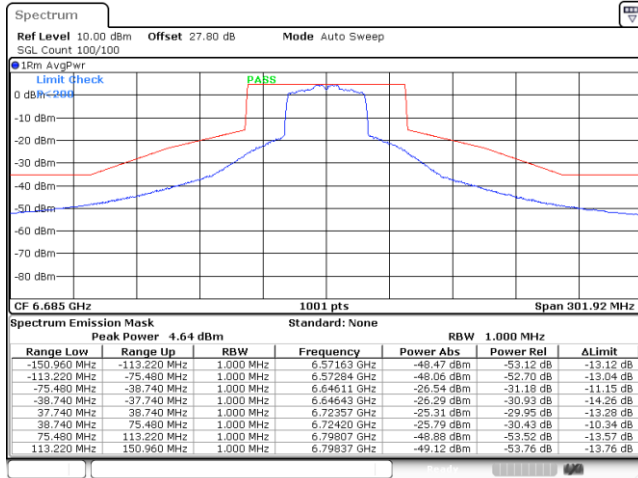

Date: 17.AUG.2023 17:06:02

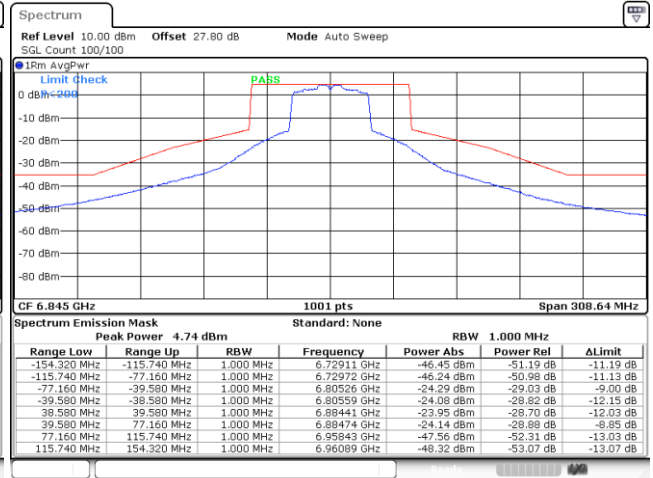

Date: 17.AUG.2023 17:26:34



EUT Mode : 802.11ax HE40 242RU61

Plot on Channel 5965 MHz

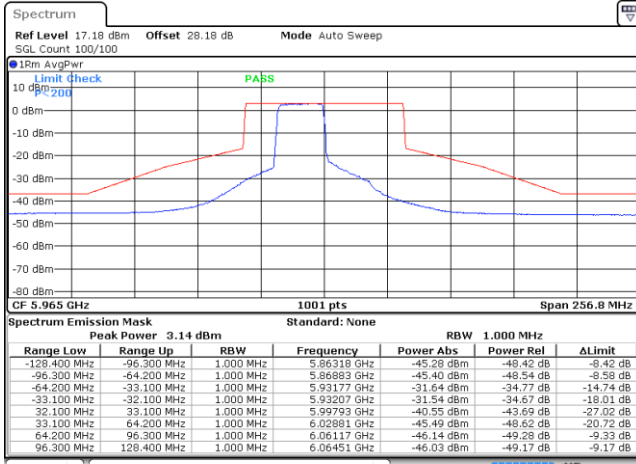

Date: 28 SEP 2023 10:30:25

Plot on Channel 6205 MHz

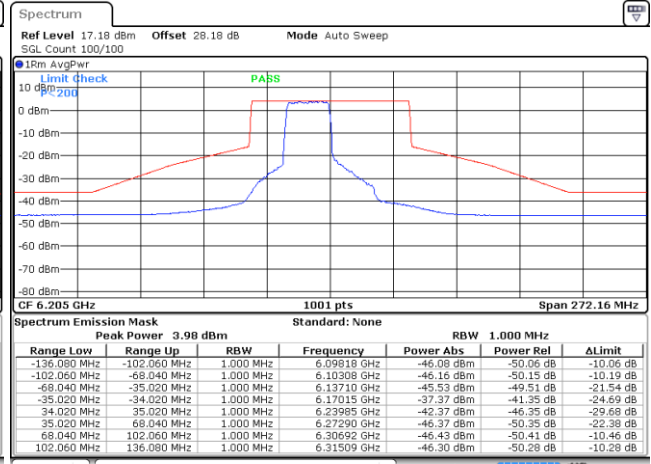

Date: 28 SEP 2023 10:47:34

Plot on Channel 6565 MHz

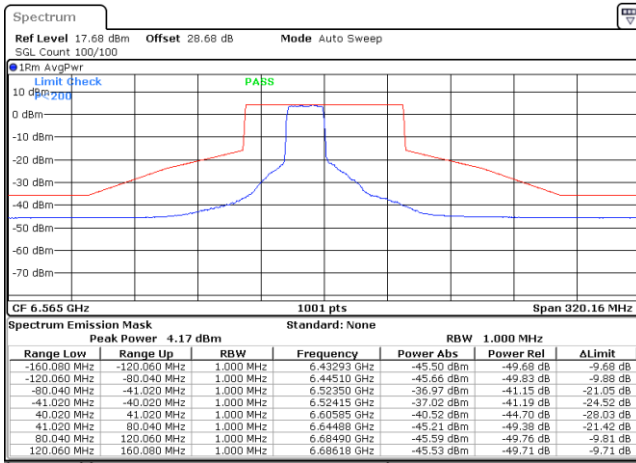

Date: 28 SEP 2023 11:09:45

Plot on Channel 6685 MHz

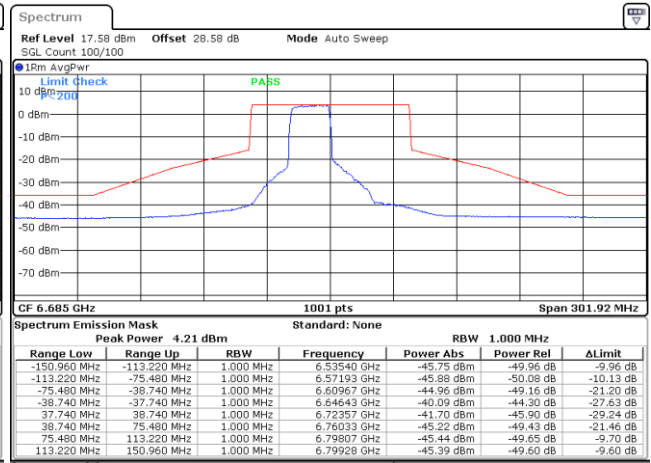

Date: 28 SEP 2023 11:17:15



EUT Mode : 802.11ax HE40 242RU62

Plot on Channel 6405 MHz

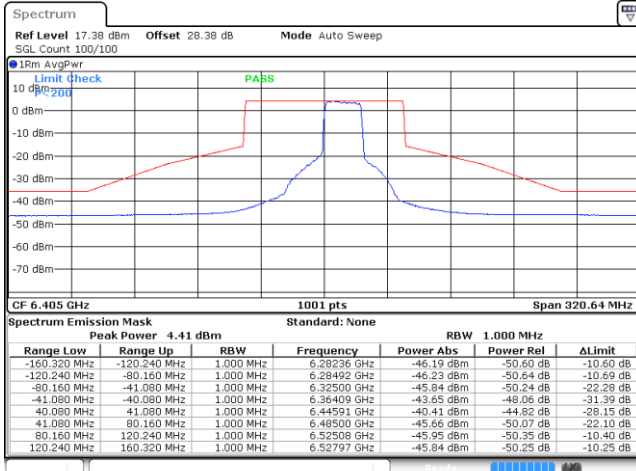

Date: 28 SEP.2023 10:59:26

Plot on Channel 6845 MHz

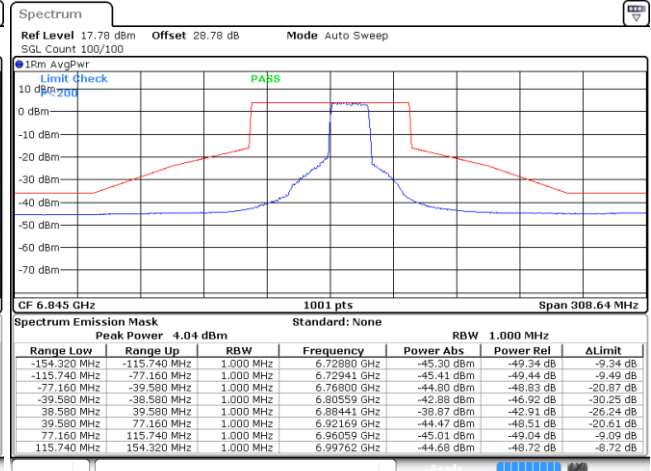

Date: 28 SEP.2023 11:44:43



EUT Mode : 802.11ax HE80 Full RU

Plot on Channel 5985 MHz

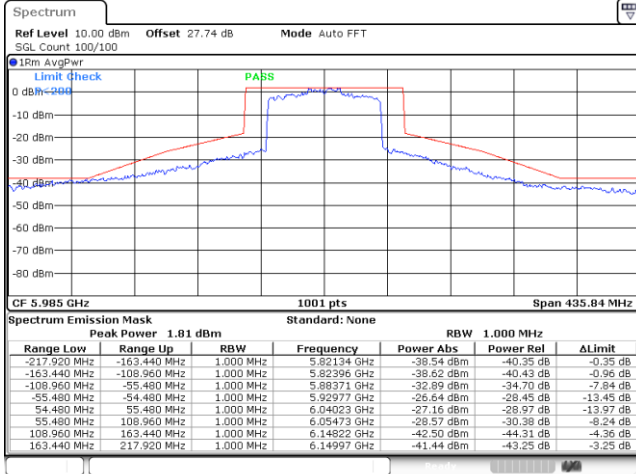

Date: 17.AUG.2023 17:51:25

Plot on Channel 6225 MHz

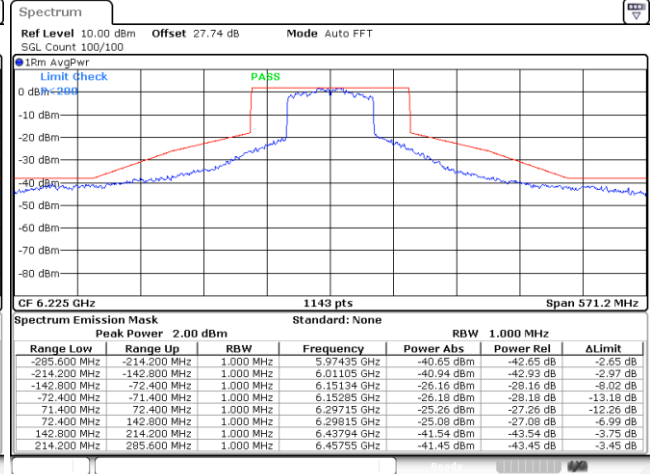

Date: 17.AUG.2023 17:57:31

Plot on Channel 6385 MHz

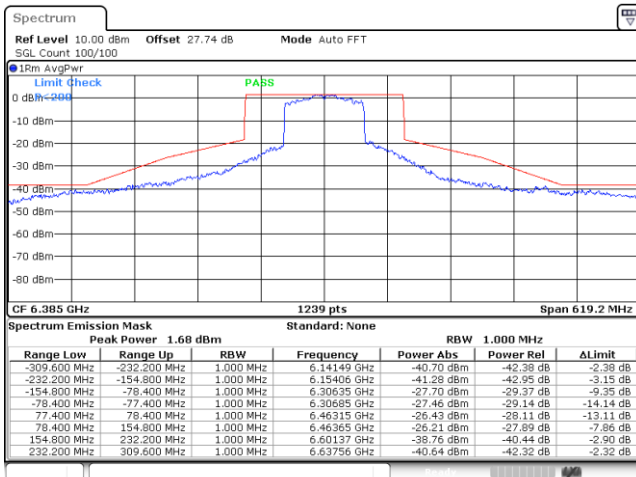

Date: 18.AUG.2023 10:29:02

Plot on Channel 6625 MHz

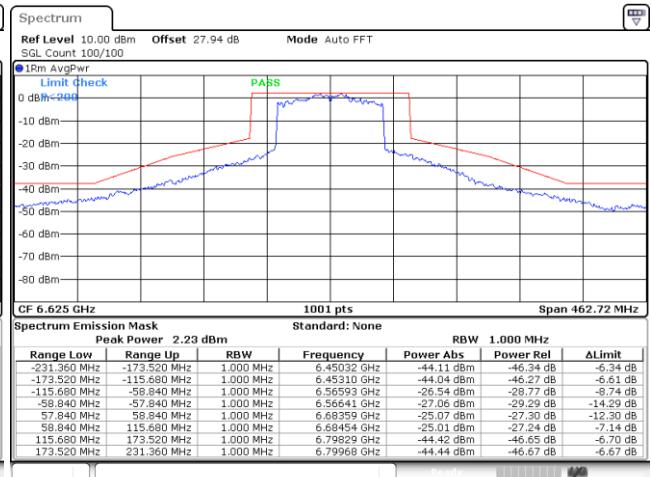

Date: 18.AUG.2023 11:30:33



Plot on Channel 6705 MHz

Plot on Channel 6785 MHz

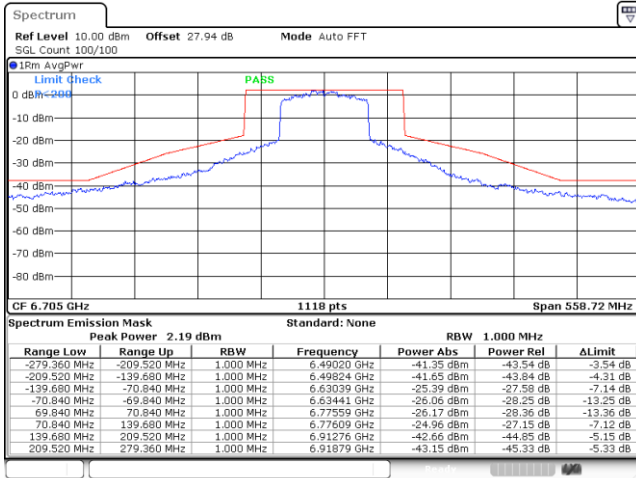

Date: 18.AUG.2023 11:43:06

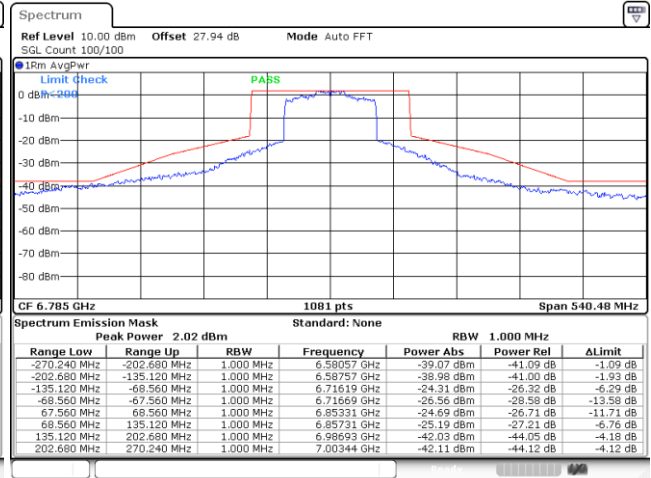

Date: 18.AUG.2023 11:47:27



EUT Mode 802.11ax HE80 484RU65

Plot on Channel 5985 MHz

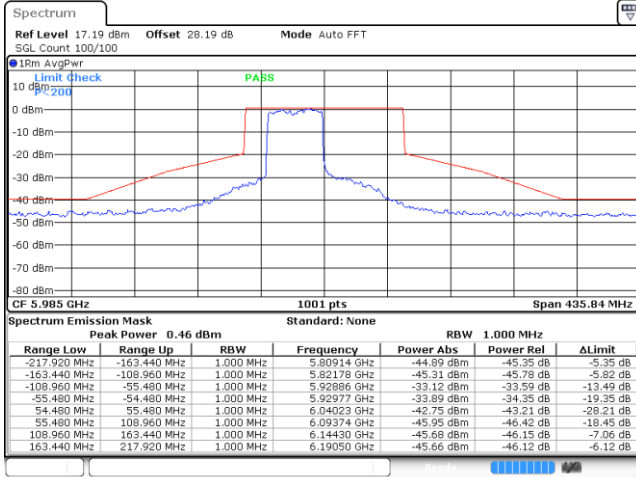

Date: 28 SEP.2023 11:54:47

Plot on Channel 6225 MHz

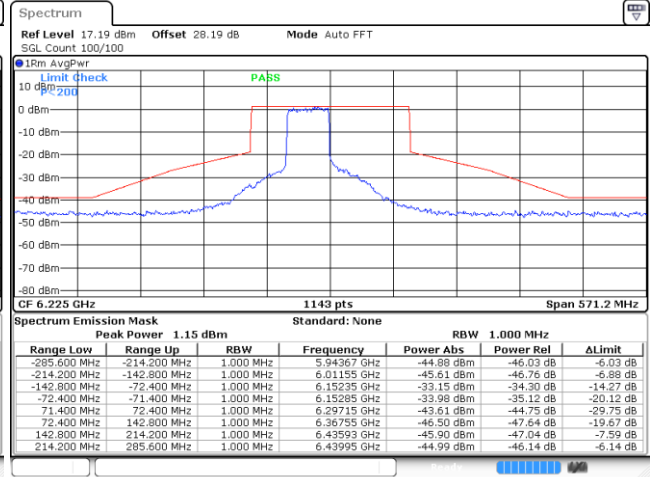

Date: 28 SEP.2023 13:47:56

Plot on Channel 6625 MHz

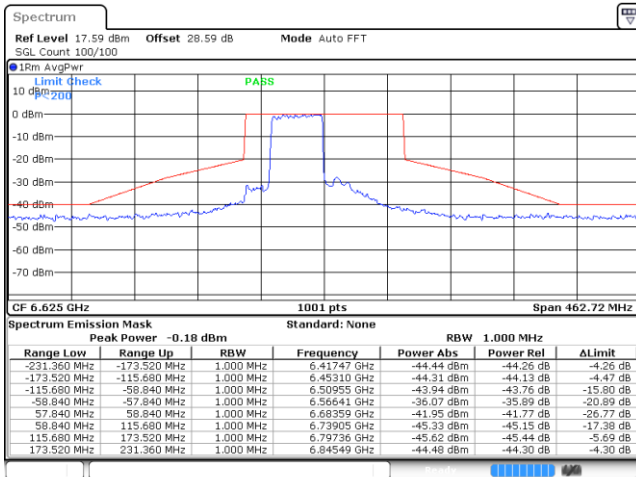

Date: 28 SEP.2023 14:19:28

Plot on Channel 6705 MHz

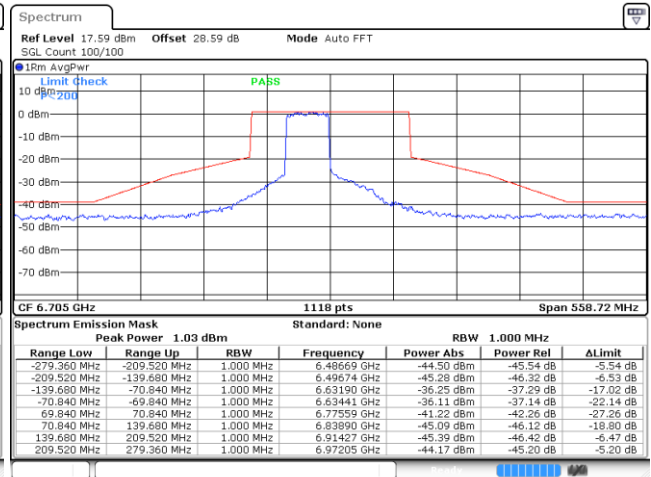

Date: 28 SEP.2023 14:33:34



EUT Mode

802.11ax HE80 484RU66

Plot on Channel 6385 MHz

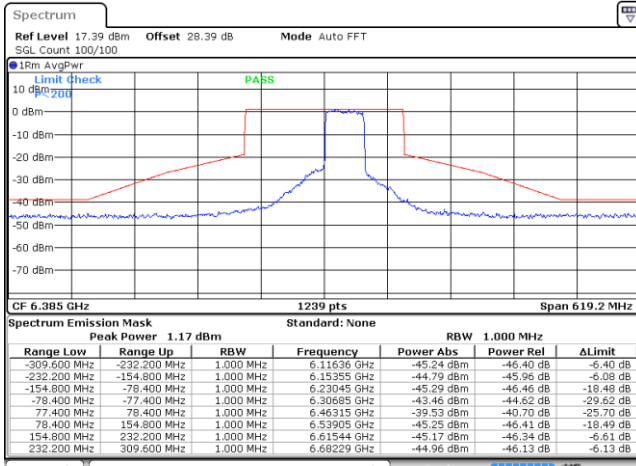

Date: 28 SEP.2023 14:07:50

Plot on Channel 6785 MHz

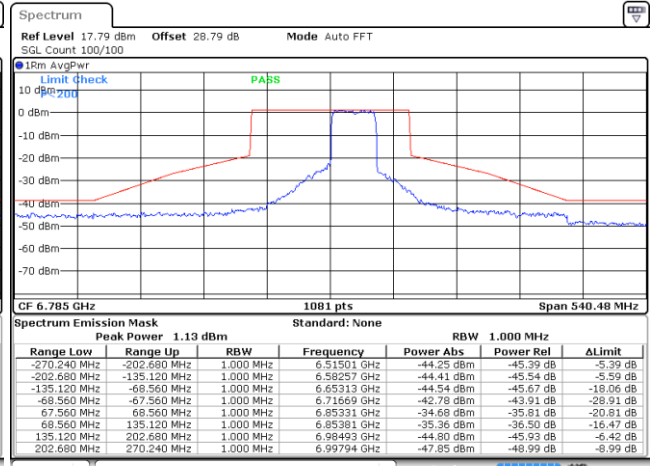

Date: 28 SEP.2023 14:42:48



MIMO <Ant. 4+3(3)>

EUT Mode : 802.11a

Plot on Channel 5955 MHz

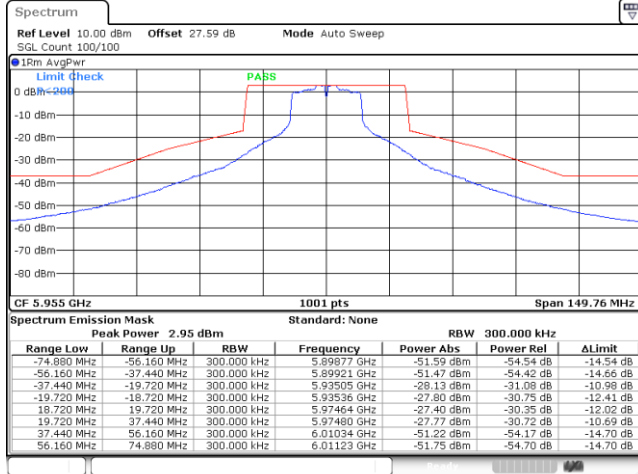

Date: 14.AUG.2023 14:37:18

Plot on Channel 6195 MHz

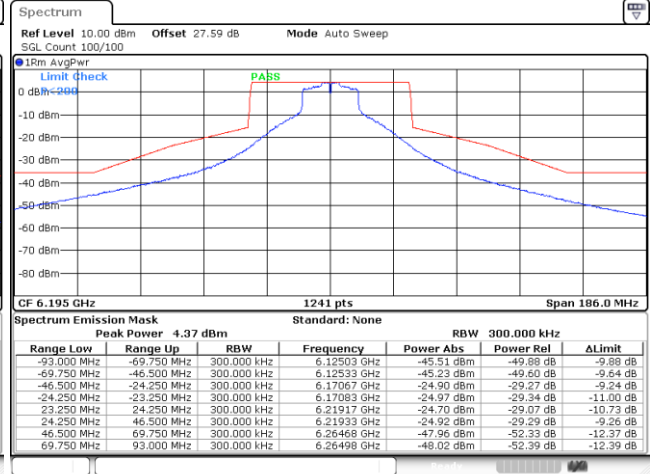

Date: 14.AUG.2023 15:10:10

Plot on Channel 6415 MHz

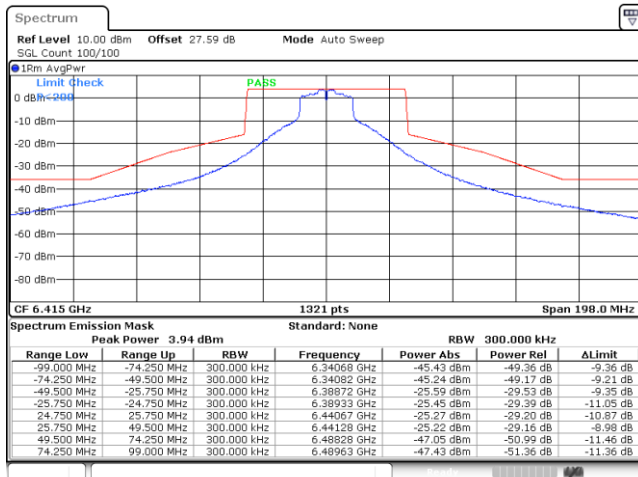

Date: 14.AUG.2023 15:55:39

Plot on Channel 6535 MHz

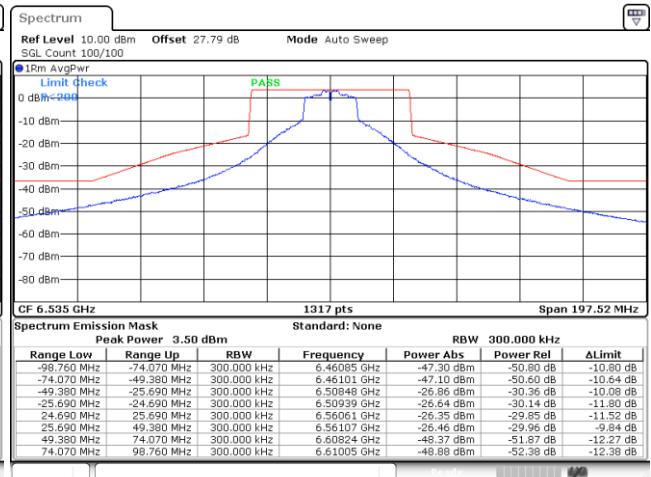

Date: 14.AUG.2023 16:33:28



Plot on Channel 6695 MHz

Plot on Channel 6855 MHz

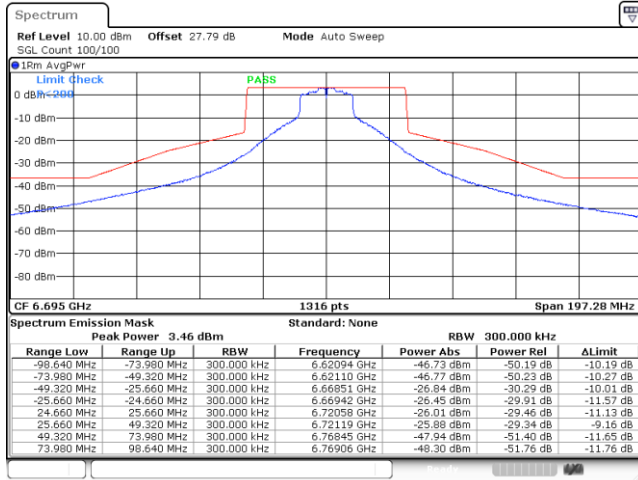

Date: 14.AUG.2023 16:43:58

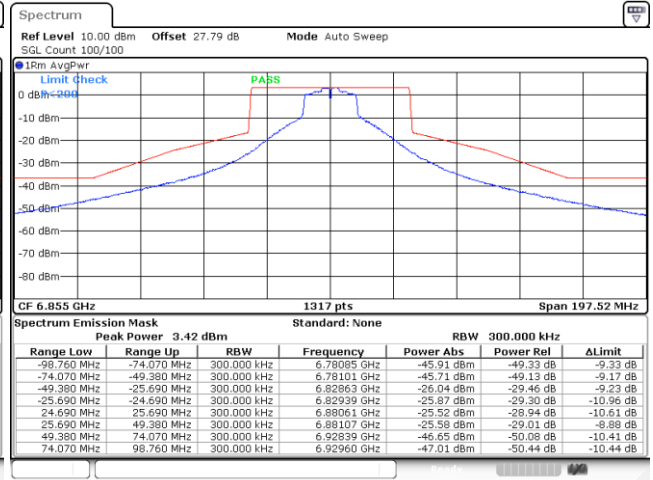

Date: 14.AUG.2023 17:09:33



EUT Mode : 802.11ax HE20 Full RU

Plot on Channel 5955 MHz

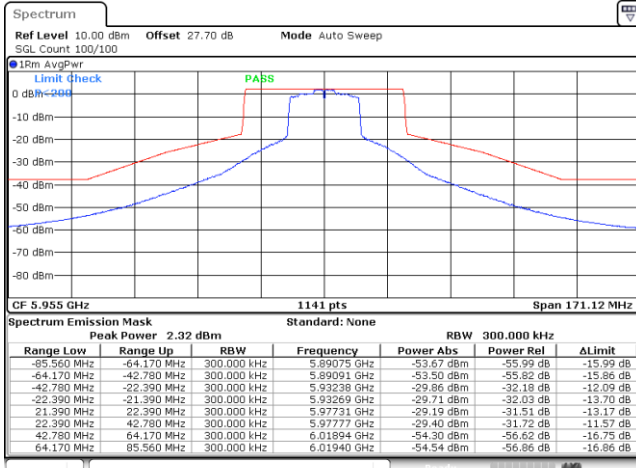

Date: 15.AUG.2023 10:09:32

Plot on Channel 6195 MHz

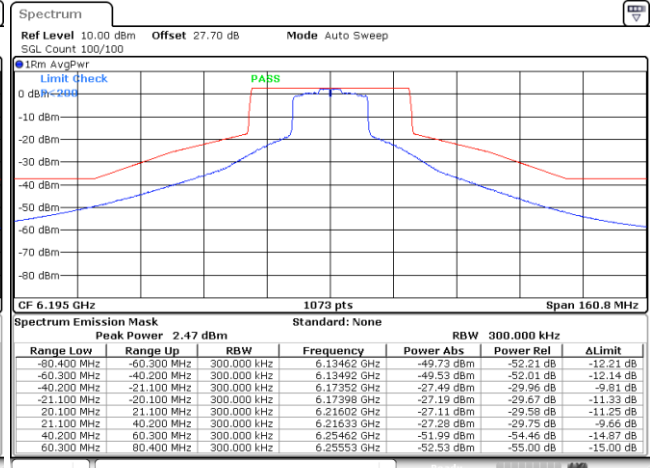

Date: 15.AUG.2023 12:06:45

Plot on Channel 6415 MHz

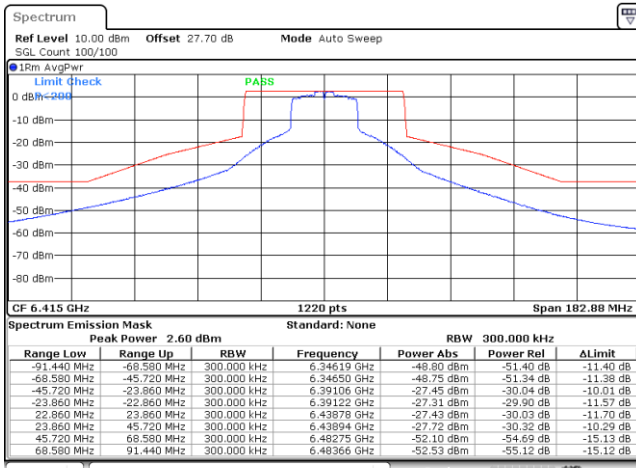

Date: 15.AUG.2023 14:50:09

Plot on Channel 6535 MHz

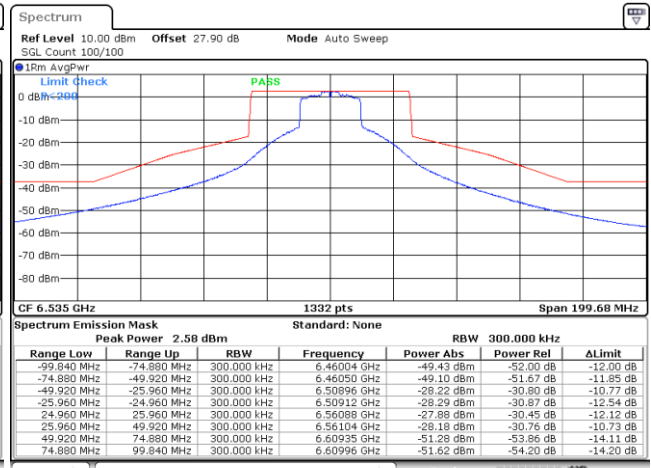

Date: 16.AUG.2023 17:01:57



Plot on Channel 6695 MHz

Plot on Channel 6855 MHz

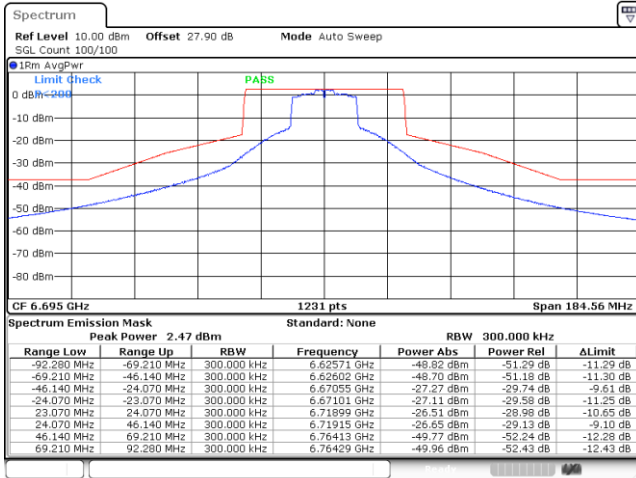

Date: 16.AUG.2023 18:03:03

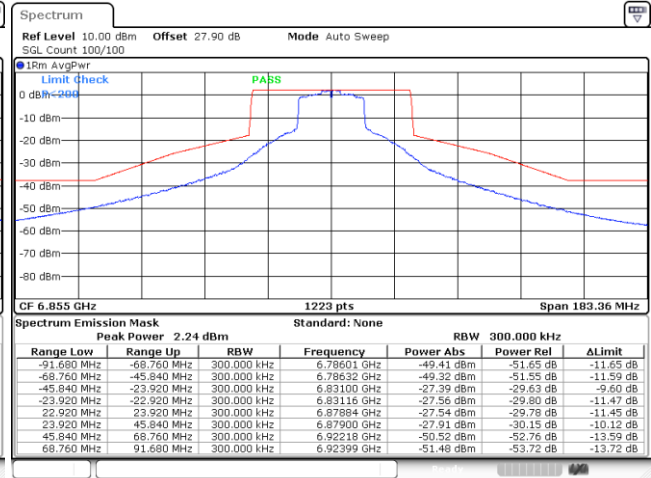

Date: 17.AUG.2023 11:57:21