



Accredited by the Swiss Accreditation Service (SAS)  
The Swiss Accreditation Service is one of the signatories to the EA  
Multilateral Agreement for the recognition of calibration certificates

Accreditation No.: **SCS 0108**

Client **Sporton**

Certificate No: **D750V3-1107\_Jun22**

## CALIBRATION CERTIFICATE

Object: **D750V3 - SN:1107**

Calibration procedure(s): **QA CAL-05.v11  
Calibration Procedure for SAR Validation Sources between 0.7-3 GHz**

Calibration date: **June 22, 2022**

This calibration certificate documents the traceability to national standards, which realize the physical units of measurements (SI).  
The measurements and the uncertainties with confidence probability are given on the following pages and are part of the certificate.

All calibrations have been conducted in the closed laboratory facility: environment temperature ( $22 \pm 3$ )°C and humidity < 70%.

Calibration Equipment used (M&TE critical for calibration)

| Primary Standards               | ID #               | Cal Date (Certificate No.)        | Scheduled Calibration  |
|---------------------------------|--------------------|-----------------------------------|------------------------|
| Power meter NRP                 | SN: 104778         | 04-Apr-22 (No. 217-03525/03524)   | Apr-23                 |
| Power sensor NRP-Z91            | SN: 103244         | 04-Apr-22 (No. 217-03524)         | Apr-23                 |
| Power sensor NRP-Z91            | SN: 103245         | 04-Apr-22 (No. 217-03525)         | Apr-23                 |
| Reference 20 dB Attenuator      | SN: BH9394 (20k)   | 04-Apr-22 (No. 217-03527)         | Apr-23                 |
| Type-N mismatch combination     | SN: 310982 / 06327 | 04-Apr-22 (No. 217-03528)         | Apr-23                 |
| Reference Probe EX3DV4          | SN: 7349           | 31-Dec-21 (No. EX3-7349_Dec21)    | Dec-22                 |
| DAE4                            | SN: 601            | 02-May-22 (No. DAE4-601_May22)    | May-23                 |
| Secondary Standards             | ID #               | Check Date (in house)             | Scheduled Check        |
| Power meter E4419B              | SN: GB39512475     | 30-Oct-14 (in house check Oct-20) | In house check: Oct-22 |
| Power sensor HP 8481A           | SN: US37292783     | 07-Oct-15 (in house check Oct-20) | In house check: Oct-22 |
| Power sensor HP 8481A           | SN: MY41093315     | 07-Oct-15 (in house check Oct-20) | In house check: Oct-22 |
| RF generator R&S SMT-06         | SN: 100972         | 15-Jun-15 (in house check Oct-20) | In house check: Oct-22 |
| Network Analyzer Agilent E8358A | SN: US41080477     | 31-Mar-14 (in house check Oct-20) | In house check: Oct-22 |

|                |                       |                                   |               |
|----------------|-----------------------|-----------------------------------|---------------|
| Calibrated by: | Name<br>Michael Weber | Function<br>Laboratory Technician | Signature<br> |
| Approved by:   | Sven Kühn             | Technical Manager                 |               |

Issued: June 24, 2022

This calibration certificate shall not be reproduced except in full without written approval of the laboratory.



Accredited by the Swiss Accreditation Service (SAS)  
The Swiss Accreditation Service is one of the signatories to the EA  
Multilateral Agreement for the recognition of calibration certificates

Accreditation No.: **SCS 0108**

**Glossary:**

|       |                                 |
|-------|---------------------------------|
| TSL   | tissue simulating liquid        |
| ConvF | sensitivity in TSL / NORM x,y,z |
| N/A   | not applicable or not measured  |

**Calibration is Performed According to the Following Standards:**

- a) IEC/IEEE 62209-1528, "Measurement Procedure For The Assessment Of Specific Absorption Rate Of Human Exposure To Radio Frequency Fields From Hand-Held And Body-Worn Wireless Communication Devices - Part 1528: Human Models, Instrumentation And Procedures (Frequency Range of 4 MHz to 10 GHz)", October 2020.
- b) KDB 865664, "SAR Measurement Requirements for 100 MHz to 6 GHz"

**Additional Documentation:**

- c) DASY System Handbook

**Methods Applied and Interpretation of Parameters:**

- *Measurement Conditions:* Further details are available from the Validation Report at the end of the certificate. All figures stated in the certificate are valid at the frequency indicated.
- *Antenna Parameters with TSL:* The source is mounted in a touch configuration below the center marking of the flat phantom.
- *Return Loss:* This parameter is measured with the source positioned under the liquid filled phantom (as described in the measurement condition clause). The Return Loss ensures low reflected power. No uncertainty required.
- *SAR measured:* SAR measured at the stated antenna input power.
- *SAR normalized:* SAR as measured, normalized to an input power of 1 W at the antenna connector.
- *SAR for nominal TSL parameters:* The measured TSL parameters are used to calculate the nominal SAR result.

The reported uncertainty of measurement is stated as the standard uncertainty of measurement multiplied by the coverage factor  $k=2$ , which for a normal distribution corresponds to a coverage probability of approximately 95%.

## Measurement Conditions

DASY system configuration, as far as not given on page 1.

|                              |                        |             |
|------------------------------|------------------------|-------------|
| DASY Version                 | DASY52                 | V52.10.4    |
| Extrapolation                | Advanced Extrapolation |             |
| Phantom                      | Modular Flat Phantom   |             |
| Distance Dipole Center - TSL | 15 mm                  | with Spacer |
| Zoom Scan Resolution         | dx, dy, dz = 5 mm      |             |
| Frequency                    | 750 MHz $\pm$ 1 MHz    |             |

## Head TSL parameters

The following parameters and calculations were applied.

|   | Temperature         | Permittivity   | Conductivity         |
|---|---------------------|----------------|----------------------|
| Nominal Head TSL parameters             | 22.0 °C             | 41.9           | 0.89 mho/m           |
| Measured Head TSL parameters            | (22.0 $\pm$ 0.2) °C | 40.6 $\pm$ 6 % | 0.89 mho/m $\pm$ 6 % |
| Head TSL temperature change during test | < 0.5 °C            | ----           | ----                 |

## SAR result with Head TSL

| SAR averaged over 1 cm <sup>3</sup> (1 g) of Head TSL | Condition          |  |
|---|--------------------|--|
| SAR measured  | 250 mW input power | 2.15 W/kg                                      |
| SAR for nominal Head TSL parameters                   | normalized to 1W   | <b>8.54 W/kg <math>\pm</math> 17.0 % (k=2)</b> |

| SAR averaged over 10 cm <sup>3</sup> (10 g) of Head TSL | condition          |  |
|---|--------------------|--|
| SAR measured  | 250 mW input power | 1.40 W/kg                                      |
| SAR for nominal Head TSL parameters                     | normalized to 1W   | <b>5.57 W/kg <math>\pm</math> 16.5 % (k=2)</b> |

## Appendix (Additional assessments outside the scope of SCS 0108)

### Antenna Parameters with Head TSL

|                                      |                                |
|--------------------------------------|--------------------------------|
| Impedance, transformed to feed point | 55.1 $\Omega$ - 0.6 j $\Omega$ |
| Return Loss                          | - 26.2 dB                      |

### General Antenna Parameters and Design

|                                  |          |
|----------------------------------|----------|
| Electrical Delay (one direction) | 1.031 ns |
|----------------------------------|----------|

After long term use with 100W radiated power, only a slight warming of the dipole near the feedpoint can be measured.

The dipole is made of standard semirigid coaxial cable. The center conductor of the feeding line is directly connected to the second arm of the dipole. The antenna is therefore short-circuited for DC-signals. On some of the dipoles, small end caps are added to the dipole arms in order to improve matching when loaded according to the position as explained in the "Measurement Conditions" paragraph. The SAR data are not affected by this change. The overall dipole length is still according to the Standard.

No excessive force must be applied to the dipole arms, because they might bend or the soldered connections near the feedpoint may be damaged.

### Additional EUT Data

|                 |       |
|-----------------|-------|
| Manufactured by | SPEAG |
|-----------------|-------|

## DASY5 Validation Report for Head TSL

Date: 22.06.2022

Test Laboratory: SPEAG, Zurich, Switzerland

**DUT: Dipole 750 MHz; Type: D750V3; Serial: D750V3 - SN:1107**

Communication System: UID 0 - CW; Frequency: 750 MHz

Medium parameters used:  $f = 750$  MHz;  $\sigma = 0.89$  S/m;  $\epsilon_r = 40.6$ ;  $\rho = 1000$  kg/m<sup>3</sup>

Phantom section: Flat Section

Measurement Standard: DASY5 (IEEE/IEC/ANSI C63.19-2011)

DASY52 Configuration:

- Probe: EX3DV4 - SN7349; ConvF(10.11, 10.11, 10.11) @ 750 MHz; Calibrated: 31.12.2021
- Sensor-Surface: 1.4mm (Mechanical Surface Detection)
- Electronics: DAE4 Sn601; Calibrated: 02.05.2022
- Phantom: Flat Phantom 4.9 (front); Type: QD 00L P49 AA; Serial: 1001
- DASY52 52.10.4(1535); SEMCAD X 14.6.14(7501)

### Dipole Calibration for Head Tissue/Pin=250 mW, d=15mm/Zoom Scan (7x7x7)/Cube 0:

Measurement grid: dx=5mm, dy=5mm, dz=5mm

Reference Value = 60.31 V/m; Power Drift = 0.01 dB

Peak SAR (extrapolated) = 3.29 W/kg

**SAR(1 g) = 2.15 W/kg; SAR(10 g) = 1.4 W/kg**

Smallest distance from peaks to all points 3 dB below: Larger than measurement grid (> 15 mm)

Ratio of SAR at M2 to SAR at M1 = 64.9%

Maximum value of SAR (measured) = 2.90 W/kg

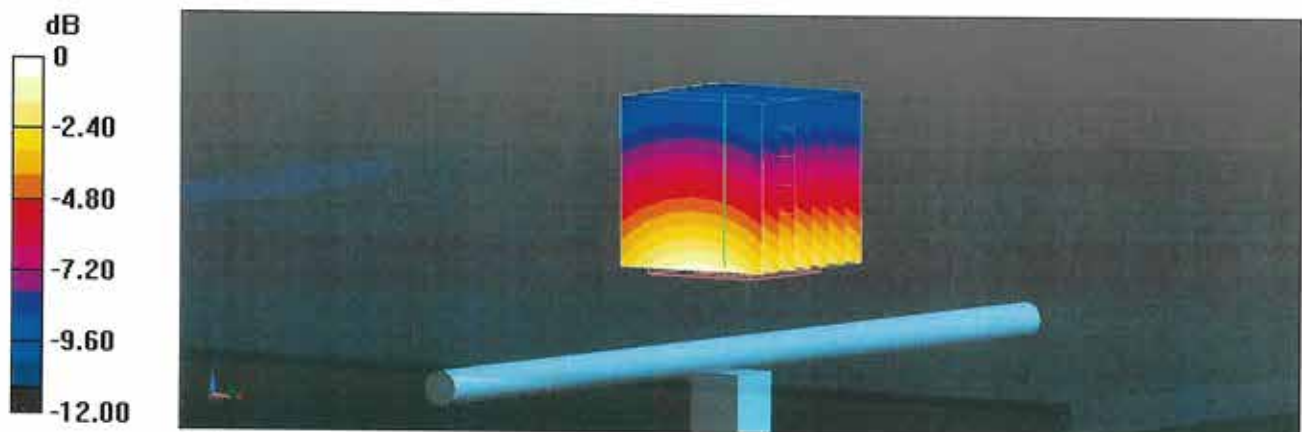

# Impedance Measurement Plot for Head TSL

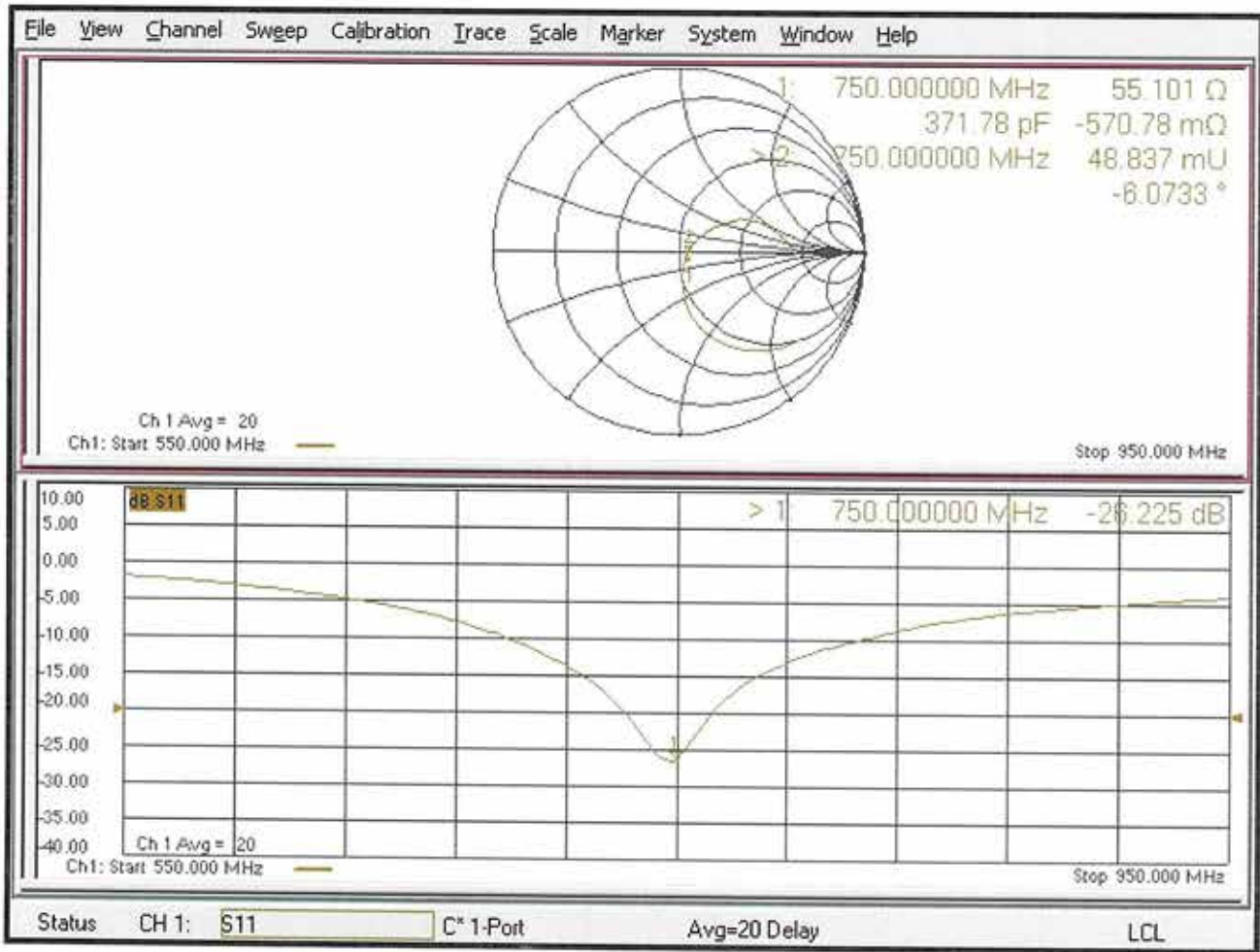



## D750V3, serial no. 1107 Extended Dipole Calibrations

If dipoles are verified in return loss (<-20dB, within 20% of prior calibration), and in impedance (within 5 ohm of prior calibration), the annual calibration is not necessary and the calibration interval can be extended.

### <Justification of the extended calibration>

| D750V3 – serial no. 1107    |                  |           |                      |             |                           |             |
|-----------------------------|------------------|-----------|----------------------|-------------|---------------------------|-------------|
| 750MHZ                      |                  |           |                      |             |                           |             |
| Date of Measurement         | Return-Loss (dB) | Delta (%) | Real Impedance (ohm) | Delta (ohm) | Imaginary Impedance (ohm) | Delta (ohm) |
| 06.22.2022<br>(Cal. Report) | -26.225          |           | 55.101               |             | -570.78                   |             |
| 06.21.2023<br>(extended)    | -27.043          | -3.12     | 55.002               | -0.099      | 1.8842                    | 2.45498     |

The return loss is <-20dB, within 20% of prior calibration; the impedance is within 5 ohm of prior calibration. Therefore the verification result should support extended calibration.

<Dipole Verification Data> - D750 V3, serial no. 1107(Data of Measurement : 06.21.2023)

750MHz - Head

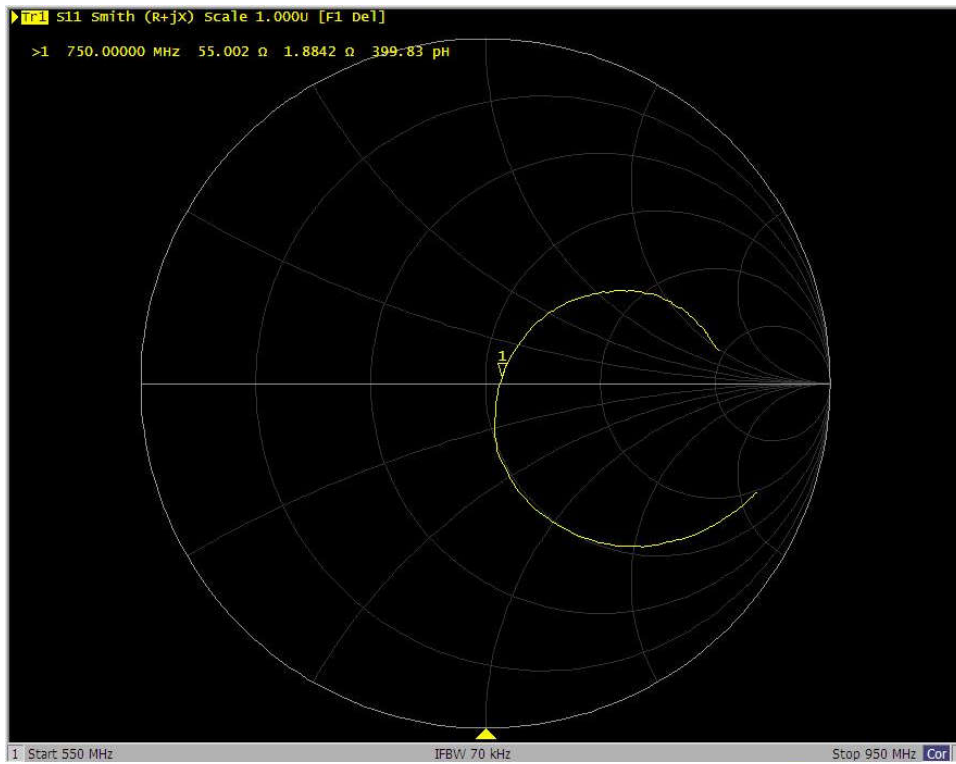
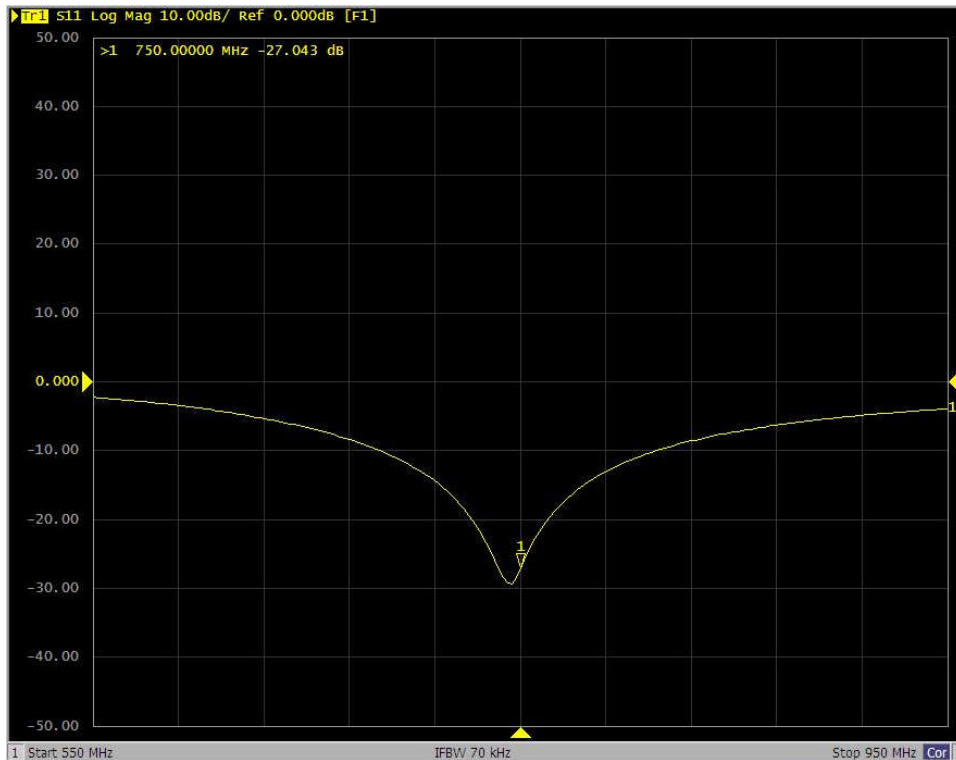





Accredited by the Swiss Accreditation Service (SAS)  
The Swiss Accreditation Service is one of the signatories to the EA  
Multilateral Agreement for the recognition of calibration certificates

Accreditation No.: **SCS 0108**

Client **Sporton**

Certificate No: **D835V2-4d167\_Nov22/2**

## CALIBRATION CERTIFICATE (Replacement of No: D835V2-4d167\_Nov22)

Object: **D835V2 - SN:4d167**

Calibration procedure(s): **QA CAL-05.v11  
Calibration Procedure for SAR Validation Sources between 0.7-3 GHz**

Calibration date: **November 24, 2022**

This calibration certificate documents the traceability to national standards, which realize the physical units of measurements (SI).  
The measurements and the uncertainties with confidence probability are given on the following pages and are part of the certificate.

All calibrations have been conducted in the closed laboratory facility: environment temperature ( $22 \pm 3$ )°C and humidity < 70%.

Calibration Equipment used (M&TE critical for calibration)

| Primary Standards           | ID #               | Cal Date (Certificate No.)      | Scheduled Calibration |
|-----------------------------|--------------------|---------------------------------|-----------------------|
| Power meter NRP             | SN: 104778         | 04-Apr-22 (No. 217-03525/03524) | Apr-23                |
| Power sensor NRP-Z91        | SN: 103244         | 04-Apr-22 (No. 217-03524)       | Apr-23                |
| Power sensor NRP-Z91        | SN: 103245         | 04-Apr-22 (No. 217-03525)       | Apr-23                |
| Reference 20 dB Attenuator  | SN: BH9394 (20k)   | 04-Apr-22 (No. 217-03527)       | Apr-23                |
| Type-N mismatch combination | SN: 310982 / 06327 | 04-Apr-22 (No. 217-03528)       | Apr-23                |
| Reference Probe EX3DV4      | SN: 7349           | 31-Dec-21 (No. EX3-7349_Dec21)  | Dec-22                |
| DAE4                        | SN: 601            | 31-Aug-22 (No. DAE4-601_Aug22)  | Aug-23                |

| Secondary Standards             | ID #           | Check Date (in house)             | Scheduled Check        |
|---------------------------------|----------------|-----------------------------------|------------------------|
| Power meter E4419B              | SN: GB39512475 | 30-Oct-14 (in house check Oct-22) | In house check: Oct-24 |
| Power sensor HP 8481A           | SN: US37292783 | 07-Oct-15 (in house check Oct-22) | In house check: Oct-24 |
| Power sensor HP 8481A           | SN: MY41093315 | 07-Oct-15 (in house check Oct-22) | In house check: Oct-24 |
| RF generator R&S SMT-06         | SN: 100972     | 15-Jun-15 (in house check Oct-22) | In house check: Oct-24 |
| Network Analyzer Agilent E8358A | SN: US41080477 | 31-Mar-14 (in house check Oct-22) | In house check: Oct-24 |

|                |                |                       |           |
|----------------|----------------|-----------------------|-----------|
|                | Name           | Function              | Signature |
| Calibrated by: | Jeton Kastrati | Laboratory Technician |           |
| Approved by:   | Sven Kühn      | Technical Manager     |           |

Issued: January 18, 2023

This calibration certificate shall not be reproduced except in full without written approval of the laboratory.



Accredited by the Swiss Accreditation Service (SAS)

The Swiss Accreditation Service is one of the signatories to the EA Multilateral Agreement for the recognition of calibration certificates

Accreditation No.: **SCS 0108**

### Glossary:

|       |                                 |
|-------|---------------------------------|
| TSL   | tissue simulating liquid        |
| ConvF | sensitivity in TSL / NORM x,y,z |
| N/A   | not applicable or not measured  |

### Calibration is Performed According to the Following Standards:

- IEC/IEEE 62209-1528, "Measurement Procedure For The Assessment Of Specific Absorption Rate Of Human Exposure To Radio Frequency Fields From Hand-Held And Body-Worn Wireless Communication Devices - Part 1528: Human Models, Instrumentation And Procedures (Frequency Range of 4 MHz to 10 GHz)", October 2020.
- KDB 865664, "SAR Measurement Requirements for 100 MHz to 6 GHz"

### Additional Documentation:

- DASY System Handbook

### Methods Applied and Interpretation of Parameters:

- Measurement Conditions:* Further details are available from the Validation Report at the end of the certificate. All figures stated in the certificate are valid at the frequency indicated.
- Antenna Parameters with TSL:* The source is mounted in a touch configuration below the center marking of the flat phantom.
- Return Loss:* This parameter is measured with the source positioned under the liquid filled phantom (as described in the measurement condition clause). The Return Loss ensures low reflected power. No uncertainty required.
- SAR measured:* SAR measured at the stated antenna input power.
- SAR normalized:* SAR as measured, normalized to an input power of 1 W at the antenna connector.
- SAR for nominal TSL parameters:* The measured TSL parameters are used to calculate the nominal SAR result.

The reported uncertainty of measurement is stated as the standard uncertainty of measurement multiplied by the coverage factor  $k=2$ , which for a normal distribution corresponds to a coverage probability of approximately 95%.

## Measurement Conditions

DASY system configuration, as far as not given on page 1.

|                              |                        |             |
|------------------------------|------------------------|-------------|
| DASY Version                 | DASY52                 | V52.10.4    |
| Extrapolation                | Advanced Extrapolation |             |
| Phantom                      | Modular Flat Phantom   |             |
| Distance Dipole Center - TSL | 15 mm                  | with Spacer |
| Zoom Scan Resolution         | dx, dy, dz = 5 mm      |             |
| Frequency                    | 835 MHz $\pm$ 1 MHz    |             |

## Head TSL parameters

The following parameters and calculations were applied.

|   | Temperature         | Permittivity   | Conductivity         |
|---|---------------------|----------------|----------------------|
| Nominal Head TSL parameters             | 22.0 °C             | 41.5           | 0.90 mho/m           |
| Measured Head TSL parameters            | (22.0 $\pm$ 0.2) °C | 40.7 $\pm$ 6 % | 0.91 mho/m $\pm$ 6 % |
| Head TSL temperature change during test | < 0.5 °C            | ---            | ---                  |

## SAR result with Head TSL

| SAR averaged over 1 cm <sup>3</sup> (1 g) of Head TSL | Condition          |                              |
|---|--------------------|------------------------------|
| SAR measured  | 250 mW input power | 2.48 W/kg                    |
| SAR for nominal Head TSL parameters                   | normalized to 1W   | 9.80 W/kg $\pm$ 17.0 % (k=2) |

| SAR averaged over 10 cm <sup>3</sup> (10 g) of Head TSL | condition          |                              |
|---|--------------------|------------------------------|
| SAR measured  | 250 mW input power | 1.81 W/kg                    |
| SAR for nominal Head TSL parameters                     | normalized to 1W   | 6.38 W/kg $\pm$ 16.5 % (k=2) |

## Appendix (Additional assessments outside the scope of SCS 0108)

### Antenna Parameters with Head TSL

|                                      |                               |
|--------------------------------------|-------------------------------|
| Impedance, transformed to feed point | 51.9 $\Omega$ - 2.8 $j\Omega$ |
| Return Loss                          | - 29.5 dB                     |

### General Antenna Parameters and Design

|                                  |          |
|----------------------------------|----------|
| Electrical Delay (one direction) | 1.392 ns |
|----------------------------------|----------|

After long term use with 100W radiated power, only a slight warming of the dipole near the feedpoint can be measured.

The dipole is made of standard semirigid coaxial cable. The center conductor of the feeding line is directly connected to the second arm of the dipole. The antenna is therefore short-circuited for DC-signals. On some of the dipoles, small end caps are added to the dipole arms in order to improve matching when loaded according to the position as explained in the "Measurement Conditions" paragraph. The SAR data are not affected by this change. The overall dipole length is still according to the Standard.

No excessive force must be applied to the dipole arms, because they might bend or the soldered connections near the feedpoint may be damaged.

### Additional EUT Data

|                 |       |
|-----------------|-------|
| Manufactured by | SPEAG |
|-----------------|-------|

## DASY5 Validation Report for Head TSL

Date: 24.11.2022

Test Laboratory: SPEAG, Zurich, Switzerland

**DUT: Dipole 835 MHz; Type: D835V2; Serial: D835V2 - SN:4d167**

Communication System: UID 0 - CW; Frequency: 835 MHz

Medium parameters used:  $f = 835$  MHz;  $\sigma = 0.91$  S/m;  $\epsilon_r = 40.7$ ;  $\rho = 1000$  kg/m<sup>3</sup>

Phantom section: Flat Section

Measurement Standard: DASY5 (IEEE/IEC/ANSI C63.19-2011)

DASY52 Configuration:

- Probe: EX3DV4 - SN7349; ConvF(9.69, 9.69, 9.69) @ 835 MHz; Calibrated: 31.12.2021
- Sensor-Surface: 1.4mm (Mechanical Surface Detection)
- Electronics: DAE4 Sn601; Calibrated: 31.08.2022
- Phantom: Flat Phantom 4.9 (front); Type: QD 00L P49 AA; Serial: 1001
- DASY52 52.10.4(1535); SEMCAD X 14.6.14(7501)

### Dipole Calibration for Head Tissue/Pin=250 mW, d=15mm/Zoom Scan (7x7x7)/Cube 0:

Measurement grid: dx=5mm, dy=5mm, dz=5mm

Reference Value = 64.02 V/m; Power Drift = -0.03 dB

Peak SAR (extrapolated) = 3.69 W/kg

**SAR(1 g) = 2.48 W/kg; SAR(10 g) = 1.61 W/kg**

Smallest distance from peaks to all points 3 dB below = 17 mm

Ratio of SAR at M2 to SAR at M1 = 66.8%

Maximum value of SAR (measured) = 3.28 W/kg

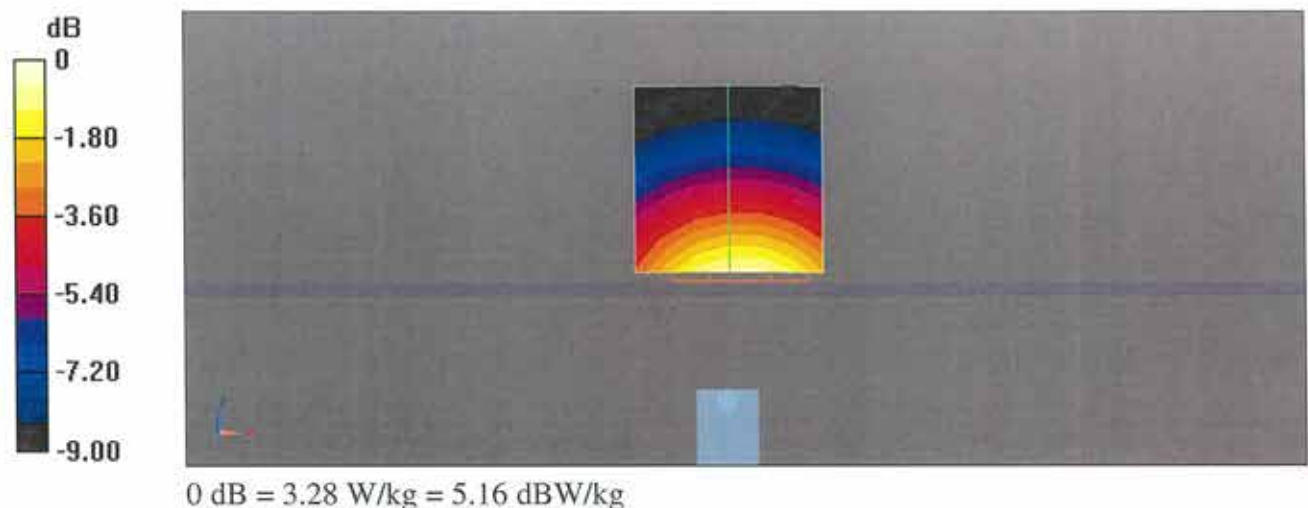

# Impedance Measurement Plot for Head TSL

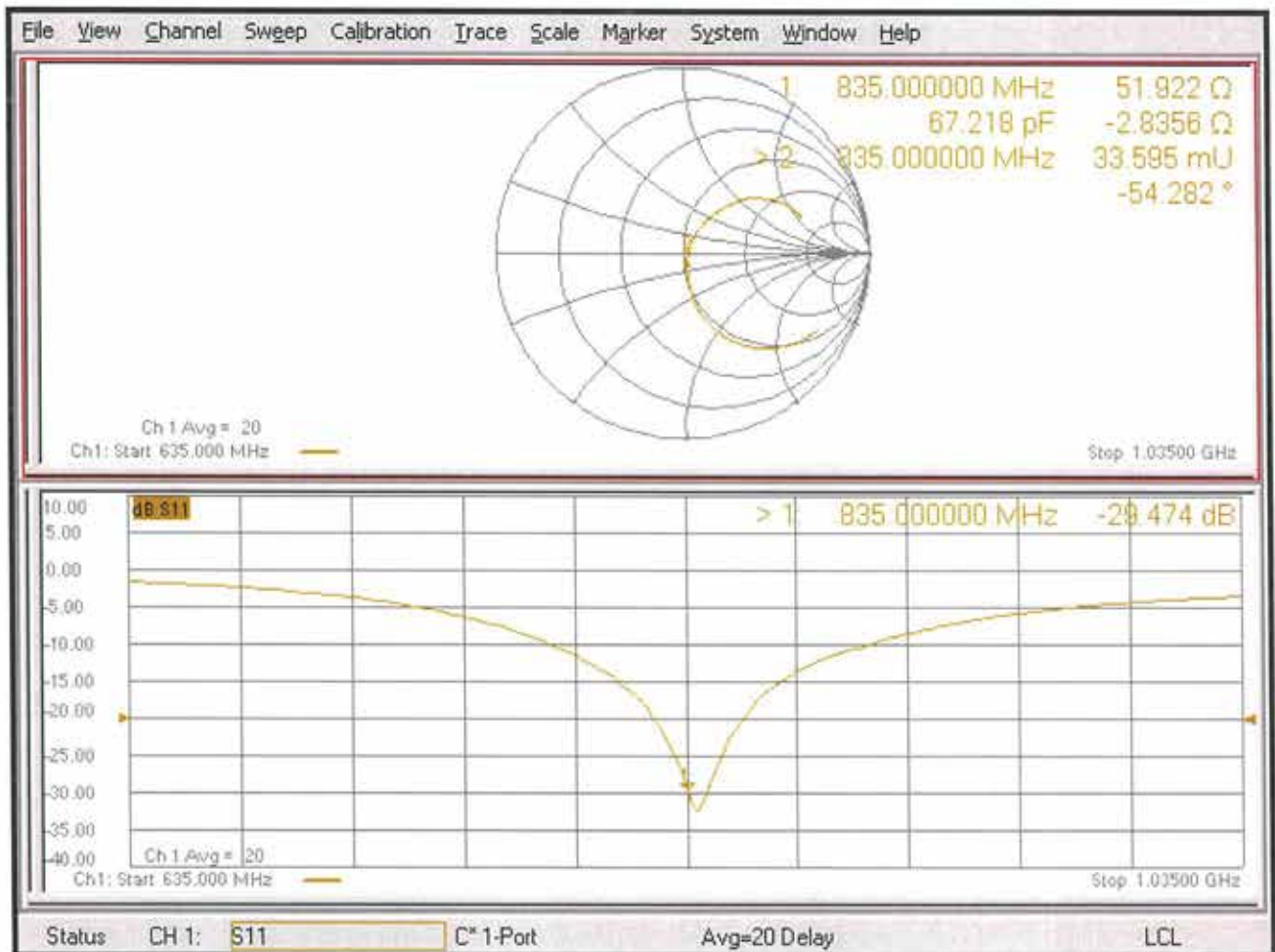

## Appendix: Transfer Calibration at Four Validation Locations on SAM Head<sup>1</sup>

### Evaluation Condition

|         |                  |                             |
|---------|------------------|-----------------------------|
| Phantom | SAM Head Phantom | For usage with cSAR3DV2-R/L |
|---------|------------------|-----------------------------|

### SAR result with SAM Head (Top $\cong$ C0)

|   |                  |                              |
|---|------------------|------------------------------|
| SAR averaged over 1 cm <sup>3</sup> (1 g) of Head TSL | Condition        |                              |
| SAR for nominal Head TSL parameters                   | normalized to 1W | 9.31 W/kg $\pm$ 17.5 % (k=2) |

|   |                  |                              |
|---|------------------|------------------------------|
| SAR averaged over 10 cm <sup>3</sup> (10 g) of Head TSL | condition        |                              |
| SAR for nominal Head TSL parameters                     | normalized to 1W | 6.16 W/kg $\pm$ 16.9 % (k=2) |

### SAR result with SAM Head (Mouth $\cong$ F90)

|   |                  |                              |
|---|------------------|------------------------------|
| SAR averaged over 1 cm <sup>3</sup> (1 g) of Head TSL | Condition        |                              |
| SAR for nominal Head TSL parameters                   | normalized to 1W | 9.77 W/kg $\pm$ 17.5 % (k=2) |

|   |                  |                              |
|---|------------------|------------------------------|
| SAR averaged over 10 cm <sup>3</sup> (10 g) of Head TSL | condition        |                              |
| SAR for nominal Head TSL parameters                     | normalized to 1W | 6.57 W/kg $\pm$ 16.9 % (k=2) |

### SAR result with SAM Head (Neck $\cong$ H0)

|   |                  |                              |
|---|------------------|------------------------------|
| SAR averaged over 1 cm <sup>3</sup> (1 g) of Head TSL | Condition        |                              |
| SAR for nominal Head TSL parameters                   | normalized to 1W | 9.29 W/kg $\pm$ 17.5 % (k=2) |

|   |                  |                              |
|---|------------------|------------------------------|
| SAR averaged over 10 cm <sup>3</sup> (10 g) of Head TSL | condition        |                              |
| SAR for nominal Head TSL parameters                     | normalized to 1W | 6.28 W/kg $\pm$ 16.9 % (k=2) |

### SAR result with SAM Head (Ear $\cong$ D90)

|   |                  |                              |
|---|------------------|------------------------------|
| SAR averaged over 1 cm <sup>3</sup> (1 g) of Head TSL | Condition        |                              |
| SAR for nominal Head TSL parameters                   | normalized to 1W | 7.98 W/kg $\pm$ 17.5 % (k=2) |

|   |                  |                              |
|---|------------------|------------------------------|
| SAR averaged over 10 cm <sup>3</sup> (10 g) of Head TSL | condition        |                              |
| SAR for nominal Head TSL parameters                     | normalized to 1W | 5.38 W/kg $\pm$ 16.9 % (k=2) |

<sup>1</sup> Additional assessments outside the current scope of SCS 0108



Accredited by the Swiss Accreditation Service (SAS)  
The Swiss Accreditation Service is one of the signatories to the EA  
Multilateral Agreement for the recognition of calibration certificates

Accreditation No.: **SCS 0108**

Client **Sporton**

Certificate No: **D1750V2-1112\_Jun22**

## CALIBRATION CERTIFICATE

Object **D1750V2 - SN:1112**

Calibration procedure(s) **QA CAL-05.v11  
Calibration Procedure for SAR Validation Sources between 0.7-3 GHz**

Calibration date: **June 22, 2022**

This calibration certificate documents the traceability to national standards, which realize the physical units of measurements (SI).  
The measurements and the uncertainties with confidence probability are given on the following pages and are part of the certificate.

All calibrations have been conducted in the closed laboratory facility: environment temperature ( $22 \pm 3$ )°C and humidity < 70%.

Calibration Equipment used (M&TE critical for calibration)

| Primary Standards               | ID #               | Cal Date (Certificate No.)        | Scheduled Calibration  |
|---------------------------------|--------------------|-----------------------------------|------------------------|
| Power meter NRP                 | SN: 104778         | 04-Apr-22 (No. 217-03525/03524)   | Apr-23                 |
| Power sensor NRP-Z91            | SN: 103244         | 04-Apr-22 (No. 217-03524)         | Apr-23                 |
| Power sensor NRP-Z91            | SN: 103245         | 04-Apr-22 (No. 217-03525)         | Apr-23                 |
| Reference 20 dB Attenuator      | SN: BH9394 (20k)   | 04-Apr-22 (No. 217-03527)         | Apr-23                 |
| Type-N mismatch combination     | SN: 310982 / 06327 | 04-Apr-22 (No. 217-03528)         | Apr-23                 |
| Reference Probe EX3DV4          | SN: 7349           | 31-Dec-21 (No. EX3-7349_Dec21)    | Dec-22                 |
| DAE4                            | SN: 601            | 02-May-22 (No. DAE4-601_May22)    | May-23                 |
| Secondary Standards             | ID #               | Check Date (in house)             | Scheduled Check        |
| Power meter E4419B              | SN: GB39512475     | 30-Oct-14 (in house check Oct-20) | In house check: Oct-22 |
| Power sensor HP 8481A           | SN: US37292783     | 07-Oct-15 (in house check Oct-20) | In house check: Oct-22 |
| Power sensor HP 8481A           | SN: MY41093315     | 07-Oct-15 (in house check Oct-20) | In house check: Oct-22 |
| RF generator R&S SMT-06         | SN: 100972         | 15-Jun-15 (in house check Oct-20) | In house check: Oct-22 |
| Network Analyzer Agilent E8358A | SN: US41080477     | 31-Mar-14 (in house check Oct-20) | In house check: Oct-22 |

|                |                                   |  |               |
|----------------|-----------------------------------|--|---------------|
| Calibrated by: | Name<br><b>Aidonia Georgiadou</b> | Function<br><b>Laboratory Technician</b> | Signature<br> |
| Approved by:   | Name<br><b>Sven Kühn</b>          | Function<br><b>Technical Manager</b>     | Signature<br> |

Issued: June 24, 2022

This calibration certificate shall not be reproduced except in full without written approval of the laboratory.





Accredited by the Swiss Accreditation Service (SAS)

The Swiss Accreditation Service is one of the signatories to the EA  
Multilateral Agreement for the recognition of calibration certificates

Accreditation No.: **SCS 0108**

### Glossary:

|       |                                 |
|-------|---------------------------------|
| TSL   | tissue simulating liquid        |
| ConvF | sensitivity in TSL / NORM x,y,z |
| N/A   | not applicable or not measured  |

### Calibration is Performed According to the Following Standards:

- IEC/IEEE 62209-1528, "Measurement Procedure For The Assessment Of Specific Absorption Rate Of Human Exposure To Radio Frequency Fields From Hand-Held And Body-Worn Wireless Communication Devices - Part 1528: Human Models, Instrumentation And Procedures (Frequency Range of 4 MHz to 10 GHz)", October 2020.
- KDB 865664, "SAR Measurement Requirements for 100 MHz to 6 GHz"

### Additional Documentation:

- DASY System Handbook

### Methods Applied and Interpretation of Parameters:

- Measurement Conditions:** Further details are available from the Validation Report at the end of the certificate. All figures stated in the certificate are valid at the frequency indicated.
- Antenna Parameters with TSL:** The source is mounted in a touch configuration below the center marking of the flat phantom.
- Return Loss:** This parameter is measured with the source positioned under the liquid filled phantom (as described in the measurement condition clause). The Return Loss ensures low reflected power. No uncertainty required.
- SAR measured:** SAR measured at the stated antenna input power.
- SAR normalized:** SAR as measured, normalized to an input power of 1 W at the antenna connector.
- SAR for nominal TSL parameters:** The measured TSL parameters are used to calculate the nominal SAR result.

The reported uncertainty of measurement is stated as the standard uncertainty of measurement multiplied by the coverage factor  $k=2$ , which for a normal distribution corresponds to a coverage probability of approximately 95%.

## Measurement Conditions

DASY system configuration, as far as not given on page 1.

|                              |                        |             |
|------------------------------|------------------------|-------------|
| DASY Version                 | DASY52                 | V52.10.4    |
| Extrapolation                | Advanced Extrapolation |             |
| Phantom                      | Modular Flat Phantom   |             |
| Distance Dipole Center - TSL | 10 mm                  | with Spacer |
| Zoom Scan Resolution         | dx, dy, dz = 5 mm      |             |
| Frequency                    | 1750 MHz $\pm$ 1 MHz   |             |

## Head TSL parameters

The following parameters and calculations were applied.

|   | Temperature         | Permittivity   | Conductivity         |
|---|---------------------|----------------|----------------------|
| Nominal Head TSL parameters             | 22.0 °C             | 40.1           | 1.37 mho/m           |
| Measured Head TSL parameters            | (22.0 $\pm$ 0.2) °C | 38.6 $\pm$ 6 % | 1.34 mho/m $\pm$ 6 % |
| Head TSL temperature change during test | < 0.5 °C            | ----           | ----                 |

## SAR result with Head TSL

| SAR averaged over 1 cm <sup>3</sup> (1 g) of Head TSL | Condition          |  |
|---|--------------------|--|
| SAR measured  | 250 mW input power | 9.18 W/kg                                      |
| SAR for nominal Head TSL parameters                   | normalized to 1W   | <b>36.9 W/kg <math>\pm</math> 17.0 % (k=2)</b> |

| SAR averaged over 10 cm <sup>3</sup> (10 g) of Head TSL | condition          |  |
|---|--------------------|--|
| SAR measured  | 250 mW input power | 4.83 W/kg                                      |
| SAR for nominal Head TSL parameters                     | normalized to 1W   | <b>19.4 W/kg <math>\pm</math> 16.5 % (k=2)</b> |

## Appendix (Additional assessments outside the scope of SCS 0108)

### Antenna Parameters with Head TSL

|                                      |                                |
|--------------------------------------|--------------------------------|
| Impedance, transformed to feed point | 51.4 $\Omega$ + 0.0 j $\Omega$ |
| Return Loss                          | - 37.3 dB                      |

### General Antenna Parameters and Design

|                                  |          |
|----------------------------------|----------|
| Electrical Delay (one direction) | 1.216 ns |
|----------------------------------|----------|

After long term use with 100W radiated power, only a slight warming of the dipole near the feedpoint can be measured.

The dipole is made of standard semirigid coaxial cable. The center conductor of the feeding line is directly connected to the second arm of the dipole. The antenna is therefore short-circuited for DC-signals. On some of the dipoles, small end caps are added to the dipole arms in order to improve matching when loaded according to the position as explained in the "Measurement Conditions" paragraph. The SAR data are not affected by this change. The overall dipole length is still according to the Standard.

No excessive force must be applied to the dipole arms, because they might bend or the soldered connections near the feedpoint may be damaged.

### Additional EUT Data

|                 |       |
|-----------------|-------|
| Manufactured by | SPEAG |
|-----------------|-------|

## DASY5 Validation Report for Head TSL

Date: 22.06.2022

Test Laboratory: SPEAG, Zurich, Switzerland

**DUT: Dipole 1750 MHz; Type: D1750V2; Serial: D1750V2 - SN:1112**

Communication System: UID 0 - CW; Frequency: 1750 MHz

Medium parameters used:  $f = 1750$  MHz;  $\sigma = 1.34$  S/m;  $\epsilon_r = 38.6$ ;  $\rho = 1000$  kg/m<sup>3</sup>

Phantom section: Flat Section

Measurement Standard: DASY5 (IEEE/IEC/ANSI C63.19-2011)

DASY52 Configuration:

- Probe: EX3DV4 - SN7349; ConvF(8.67, 8.67, 8.67) @ 1750 MHz; Calibrated: 31.12.2021
- Sensor-Surface: 1.4mm (Mechanical Surface Detection)
- Electronics: DAE4 Sn601; Calibrated: 02.05.2022
- Phantom: Flat Phantom 5.0 (front); Type: QD 000 P50 AA; Serial: 1001
- DASY52 52.10.4(1535); SEMCAD X 14.6.14(7501)

### **Dipole Calibration for Head Tissue/Pin=250 mW, d=10mm/Zoom Scan (7x7x7)/Cube 0:**

Measurement grid: dx=5mm, dy=5mm, dz=5mm

Reference Value = 107.3 V/m; Power Drift = 0.05 dB

Peak SAR (extrapolated) = 17.2 W/kg

**SAR(1 g) = 9.18 W/kg; SAR(10 g) = 4.83 W/kg**

Smallest distance from peaks to all points 3 dB below = 10 mm

Ratio of SAR at M2 to SAR at M1 = 53.6%

Maximum value of SAR (measured) = 14.3 W/kg

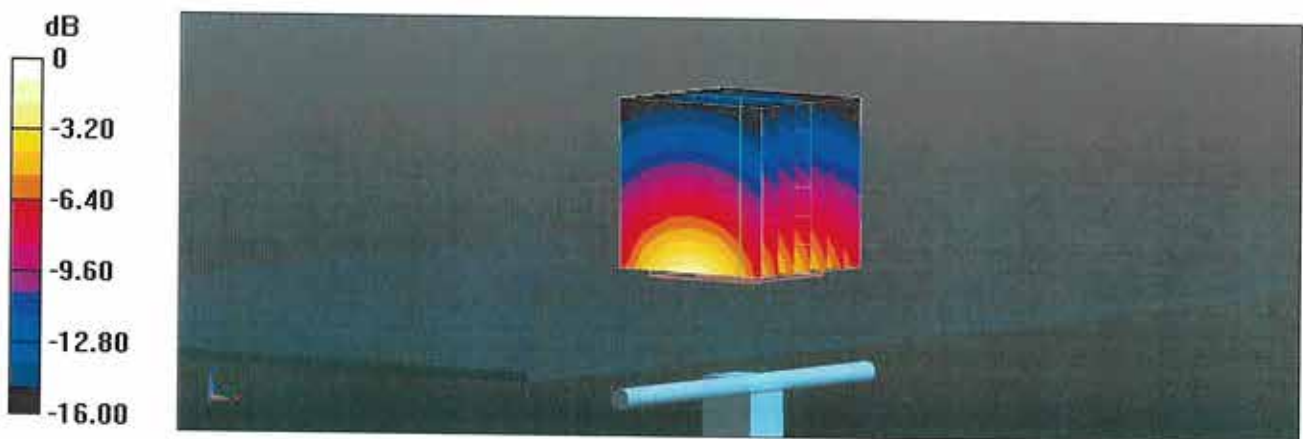

# Impedance Measurement Plot for Head TSL

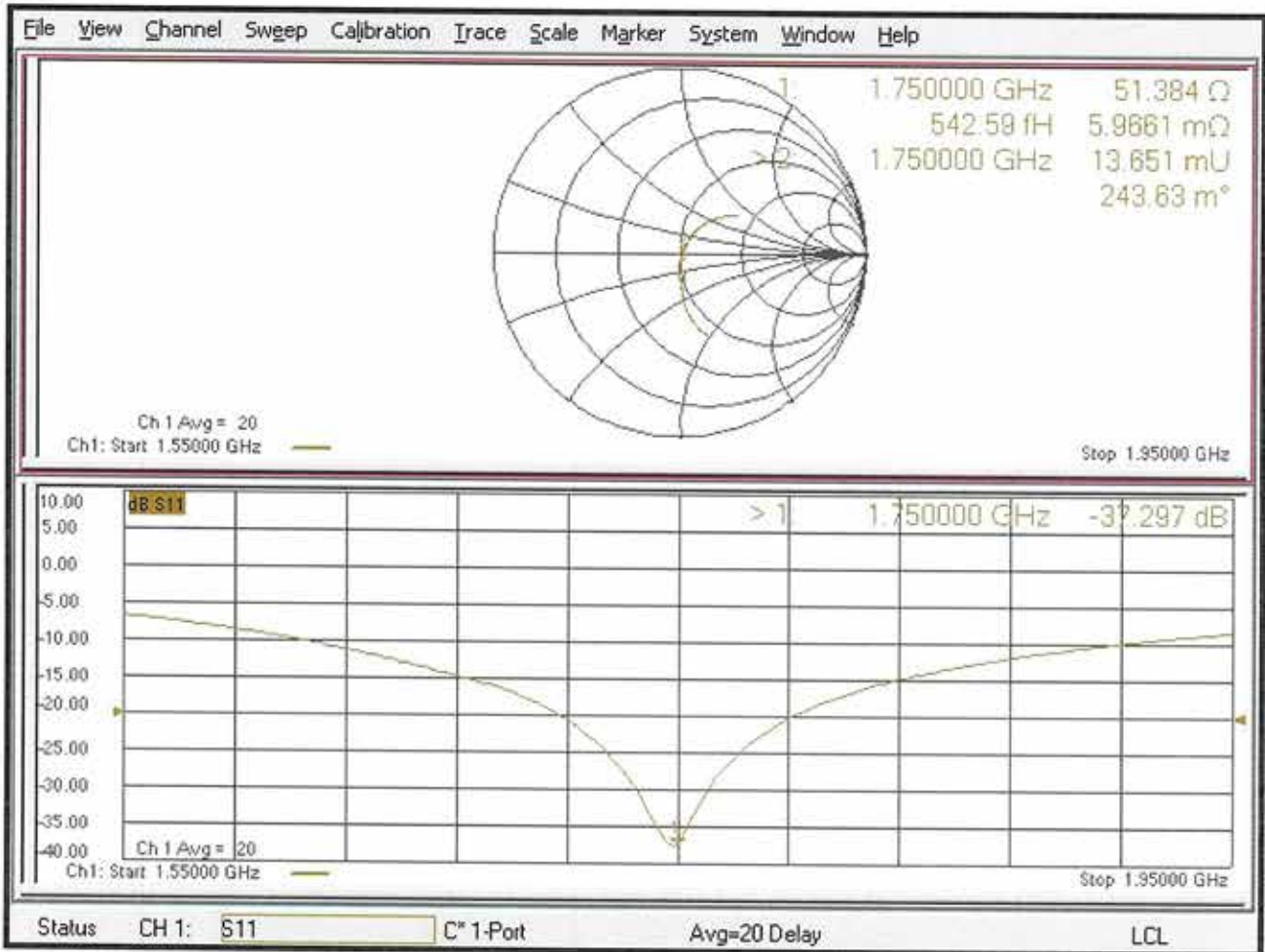



## D1750V2, serial no. 1112 Extended Dipole Calibrations

If dipoles are verified in return loss (<-20dB, within 20% of prior calibration), and in impedance (within 5 ohm of prior calibration), the annual calibration is not necessary and the calibration interval can be extended.

### <Justification of the extended calibration>

| D1750V2 – serial no. 1112   |                  |           |                      |             |                           |             |
|-----------------------------|------------------|-----------|----------------------|-------------|---------------------------|-------------|
| 1750MHZ                     |                  |           |                      |             |                           |             |
| Date of Measurement         | Return-Loss (dB) | Delta (%) | Real Impedance (ohm) | Delta (ohm) | Imaginary Impedance (ohm) | Delta (ohm) |
| 06.22.2022<br>(Cal. Report) | -37.297          |           | 51.384               |             | 5.9661                    |             |
| 06.21.2023<br>(extended)    | -36.659          | 1.71      | 52.830               | 1.446       | 4.1453                    | -1.8208     |

The return loss is <-20dB, within 20% of prior calibration; the impedance is within 5 ohm of prior calibration. Therefore the verification result should support extended calibration.



<Dipole Verification Data> - D1750 V2, serial no. 1112(Data of Measurement : 06.21.2023)  
1750MHz - Head

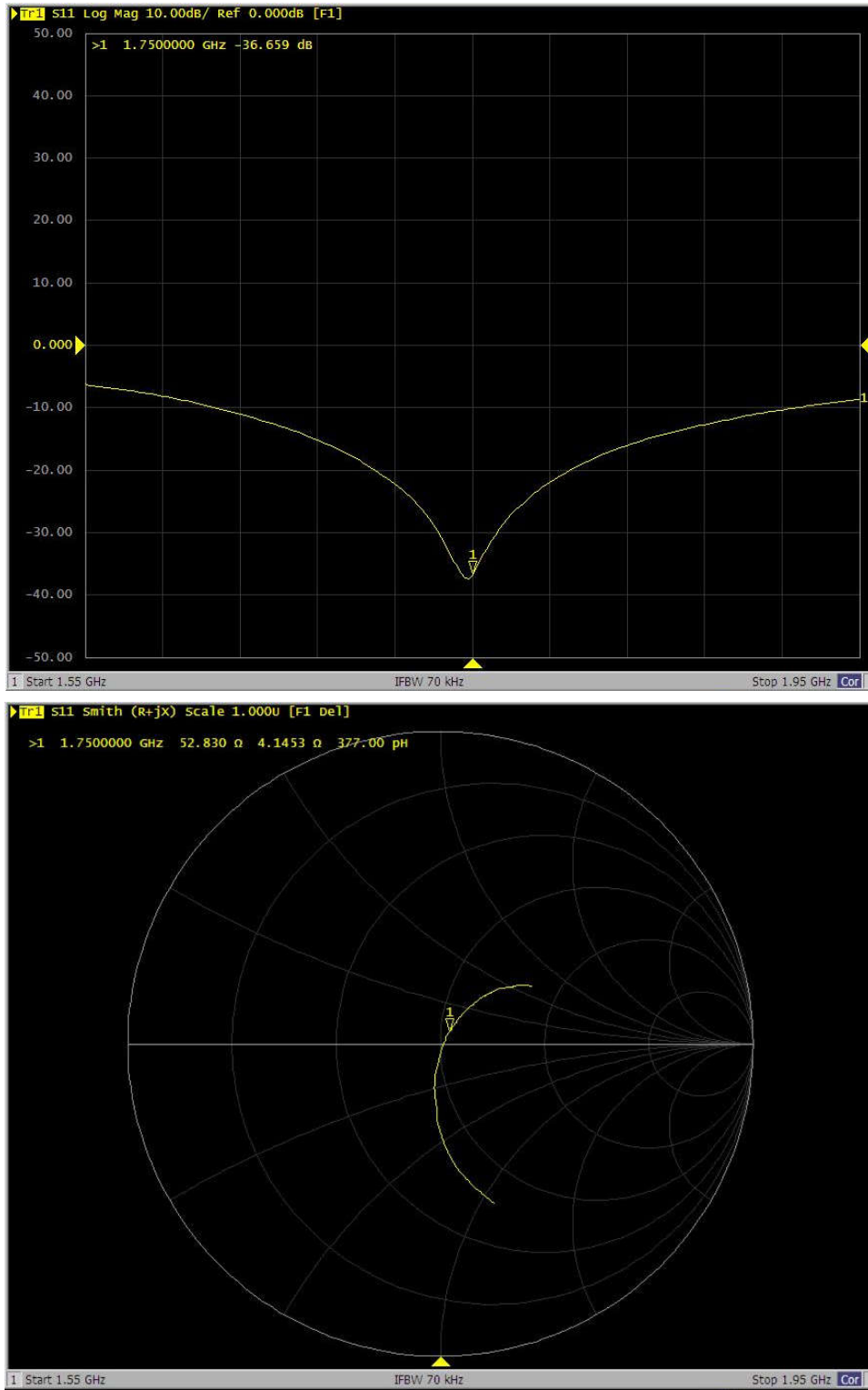



Accredited by the Swiss Accreditation Service (SAS)  
The Swiss Accreditation Service is one of the signatories to the EA  
Multilateral Agreement for the recognition of calibration certificates

Accreditation No.: **SCS 0108**

Client **Sporton**

Certificate No: **D1900V2-5d185\_Jun22**

## CALIBRATION CERTIFICATE

Object: **D1900V2 - SN:5d185**

Calibration procedure(s): **QA CAL-05.v11  
Calibration Procedure for SAR Validation Sources between 0.7-3 GHz**

Calibration date: **June 17, 2022**

This calibration certificate documents the traceability to national standards, which realize the physical units of measurements (SI).  
The measurements and the uncertainties with confidence probability are given on the following pages and are part of the certificate.

All calibrations have been conducted in the closed laboratory facility: environment temperature ( $22 \pm 3$ )°C and humidity < 70%.

Calibration Equipment used (M&TE critical for calibration)

| Primary Standards           | ID #               | Cal Date (Certificate No.)      | Scheduled Calibration |
|-----------------------------|--------------------|---------------------------------|-----------------------|
| Power meter NRP             | SN: 104778         | 04-Apr-22 (No. 217-03525/03524) | Apr-23                |
| Power sensor NRP-Z91        | SN: 103244         | 04-Apr-22 (No. 217-03524)       | Apr-23                |
| Power sensor NRP-Z91        | SN: 103245         | 04-Apr-22 (No. 217-03525)       | Apr-23                |
| Reference 20 dB Attenuator  | SN: BH9394 (20k)   | 04-Apr-22 (No. 217-03527)       | Apr-23                |
| Type-N mismatch combination | SN: 310982 / 06327 | 04-Apr-22 (No. 217-03528)       | Apr-23                |
| Reference Probe EX3DV4      | SN: 7349           | 31-Dec-21 (No. EX3-7349_Dec21)  | Dec-22                |
| DAE4                        | SN: 601            | 02-May-22 (No. DAE4-601_May22)  | May-23                |

| Secondary Standards             | ID #           | Check Date (in house)             | Scheduled Check        |
|---------------------------------|----------------|-----------------------------------|------------------------|
| Power meter E4419B              | SN: GB39512475 | 30-Oct-14 (in house check Oct-20) | In house check: Oct-22 |
| Power sensor HP 8481A           | SN: US37292783 | 07-Oct-15 (in house check Oct-20) | In house check: Oct-22 |
| Power sensor HP 8481A           | SN: MY41093315 | 07-Oct-15 (in house check Oct-20) | In house check: Oct-22 |
| RF generator R&S SMT-06         | SN: 100972     | 15-Jun-15 (in house check Oct-20) | In house check: Oct-22 |
| Network Analyzer Agilent E8358A | SN: US41080477 | 31-Mar-14 (in house check Oct-20) | In house check: Oct-22 |

|                |                                |  |               |
|----------------|--------------------------------|--|---------------|
| Calibrated by: | Name<br><b>Jeffrey Katzman</b> | Function<br><b>Laboratory Technician</b> | Signature<br> |
| Approved by:   | Name<br><b>Sven Kühn</b>       | Technical Manager                        |               |

Issued: June 20, 2022

This calibration certificate shall not be reproduced except in full without written approval of the laboratory.





Accredited by the Swiss Accreditation Service (SAS)  
The Swiss Accreditation Service is one of the signatories to the EA  
Multilateral Agreement for the recognition of calibration certificates

**Glossary:**

|       |                                 |
|-------|---------------------------------|
| TSL   | tissue simulating liquid        |
| ConvF | sensitivity in TSL / NORM x,y,z |
| N/A   | not applicable or not measured  |

**Calibration is Performed According to the Following Standards:**

- a) IEC/IEEE 62209-1528, "Measurement Procedure For The Assessment Of Specific Absorption Rate Of Human Exposure To Radio Frequency Fields From Hand-Held And Body-Worn Wireless Communication Devices - Part 1528: Human Models, Instrumentation And Procedures (Frequency Range of 4 MHz to 10 GHz)", October 2020.
- b) KDB 865664, "SAR Measurement Requirements for 100 MHz to 6 GHz"

**Additional Documentation:**

- c) DASY System Handbook

**Methods Applied and Interpretation of Parameters:**

- *Measurement Conditions:* Further details are available from the Validation Report at the end of the certificate. All figures stated in the certificate are valid at the frequency indicated.
- *Antenna Parameters with TSL:* The source is mounted in a touch configuration below the center marking of the flat phantom.
- *Return Loss:* This parameter is measured with the source positioned under the liquid filled phantom (as described in the measurement condition clause). The Return Loss ensures low reflected power. No uncertainty required.
- *SAR measured:* SAR measured at the stated antenna input power.
- *SAR normalized:* SAR as measured, normalized to an input power of 1 W at the antenna connector.
- *SAR for nominal TSL parameters:* The measured TSL parameters are used to calculate the nominal SAR result.

The reported uncertainty of measurement is stated as the standard uncertainty of measurement multiplied by the coverage factor  $k=2$ , which for a normal distribution corresponds to a coverage probability of approximately 95%.

## Measurement Conditions

DASY system configuration, as far as not given on page 1.

|                              |                        |             |
|------------------------------|------------------------|-------------|
| DASY Version                 | DASY52                 | V52.10.4    |
| Extrapolation                | Advanced Extrapolation |             |
| Phantom                      | Modular Flat Phantom   |             |
| Distance Dipole Center - TSL | 10 mm                  | with Spacer |
| Zoom Scan Resolution         | dx, dy, dz = 5 mm      |             |
| Frequency                    | 1900 MHz $\pm$ 1 MHz   |             |

## Head TSL parameters

The following parameters and calculations were applied.

|   | Temperature         | Permittivity   | Conductivity         |
|---|---------------------|----------------|----------------------|
| Nominal Head TSL parameters             | 22.0 °C             | 40.0           | 1.40 mho/m           |
| Measured Head TSL parameters            | (22.0 $\pm$ 0.2) °C | 38.6 $\pm$ 6 % | 1.40 mho/m $\pm$ 6 % |
| Head TSL temperature change during test | < 0.5 °C            | ----           | ----                 |

## SAR result with Head TSL

| SAR averaged over 1 cm <sup>3</sup> (1 g) of Head TSL | Condition          |  |
|---|--------------------|--|
| SAR measured  | 250 mW input power | 9.82 W/kg                                      |
| SAR for nominal Head TSL parameters                   | normalized to 1W   | <b>39.0 W/kg <math>\pm</math> 17.0 % (k=2)</b> |

| SAR averaged over 10 cm <sup>3</sup> (10 g) of Head TSL | condition          |  |
|---|--------------------|--|
| SAR measured  | 250 mW input power | 5.12 W/kg                                      |
| SAR for nominal Head TSL parameters                     | normalized to 1W   | <b>20.4 W/kg <math>\pm</math> 16.5 % (k=2)</b> |

## Appendix (Additional assessments outside the scope of SCS 0108)

### Antenna Parameters with Head TSL

|                                      |                                |
|--------------------------------------|--------------------------------|
| Impedance, transformed to feed point | 52.7 $\Omega$ + 3.9 j $\Omega$ |
| Return Loss                          | - 26.7 dB                      |

### General Antenna Parameters and Design

|                                  |          |
|----------------------------------|----------|
| Electrical Delay (one direction) | 1.203 ns |
|----------------------------------|----------|

After long term use with 100W radiated power, only a slight warming of the dipole near the feedpoint can be measured.

The dipole is made of standard semirigid coaxial cable. The center conductor of the feeding line is directly connected to the second arm of the dipole. The antenna is therefore short-circuited for DC-signals. On some of the dipoles, small end caps are added to the dipole arms in order to improve matching when loaded according to the position as explained in the "Measurement Conditions" paragraph. The SAR data are not affected by this change. The overall dipole length is still according to the Standard.

No excessive force must be applied to the dipole arms, because they might bend or the soldered connections near the feedpoint may be damaged.

### Additional EUT Data

|                 |       |
|-----------------|-------|
| Manufactured by | SPEAG |
|-----------------|-------|

# DASY5 Validation Report for Head TSL

Date: 17.06.2022

Test Laboratory: SPEAG, Zurich, Switzerland

**DUT: Dipole 1900 MHz; Type: D1900V2; Serial: D1900V2 - SN: 5d185**

Communication System: UID 0 - CW; Frequency: 1900 MHz

Medium parameters used:  $f = 1900$  MHz;  $\sigma = 1.4$  S/m;  $\epsilon_r = 38.6$ ;  $\rho = 1000$  kg/m<sup>3</sup>

Phantom section: Flat Section

Measurement Standard: DASY5 (IEEE/IEC/ANSI C63.19-2011)

DASY52 Configuration:

- Probe: EX3DV4 - SN7349; ConvF(8.43, 8.43, 8.43) @ 1900 MHz; Calibrated: 31.12.2021
- Sensor-Surface: 1.4mm (Mechanical Surface Detection)
- Electronics: DAE4 Sn601; Calibrated: 02.05.2022
- Phantom: Flat Phantom 5.0 (front); Type: QD 000 P50 AA; Serial: 1001
- DASY52 52.10.4(1535); SEMCAD X 14.6.14(7501)

## Dipole Calibration for Head Tissue/Pin=250 mW, d=10mm/Zoom Scan (7x7x7)/Cube 0:

Measurement grid: dx=5mm, dy=5mm, dz=5mm

Reference Value = 108.9 V/m; Power Drift = 0.08 dB

Peak SAR (extrapolated) = 18.1 W/kg

**SAR(1 g) = 9.82 W/kg; SAR(10 g) = 5.12 W/kg**

Smallest distance from peaks to all points 3 dB below = 10 mm

Ratio of SAR at M2 to SAR at M1 = 54.7%

Maximum value of SAR (measured) = 15.2 W/kg

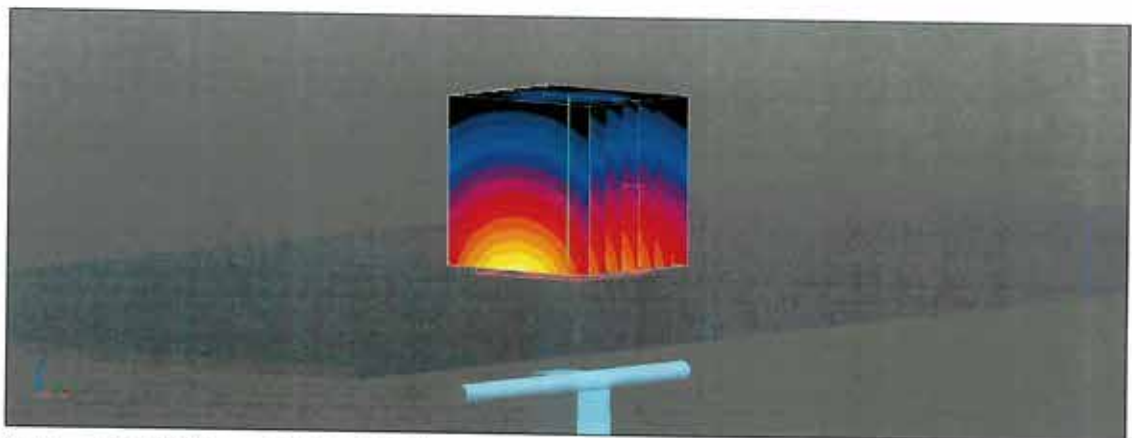
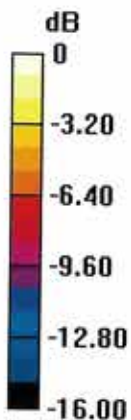

0 dB = 15.2 W/kg = 11.82 dBW/kg

# Impedance Measurement Plot for Head TSL

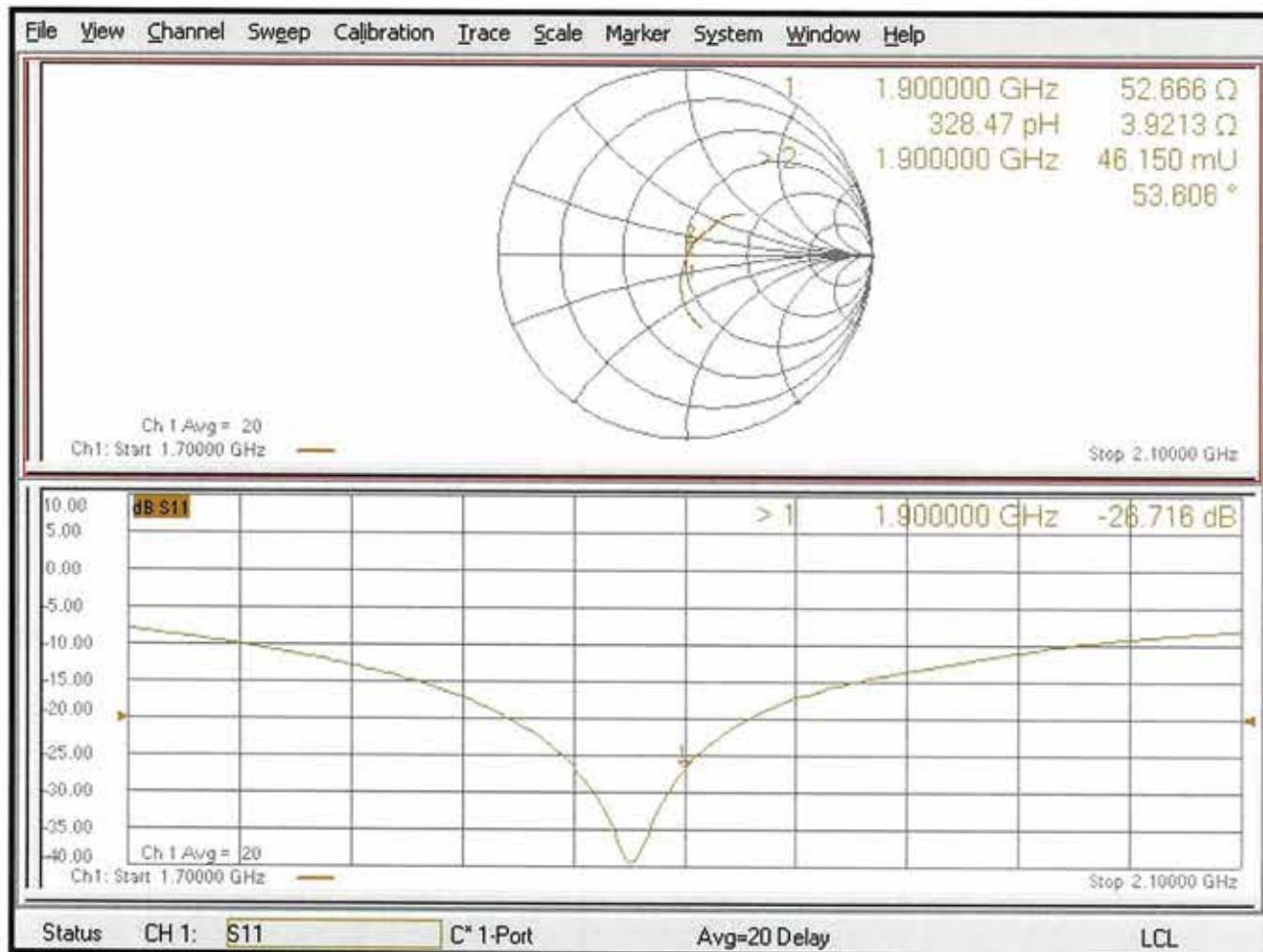



## D1900V2, serial no. 5d185 Extended Dipole Calibrations

If dipoles are verified in return loss (<-20dB, within 20% of prior calibration), and in impedance (within 5 ohm of prior calibration), the annual calibration is not necessary and the calibration interval can be extended.

### <Justification of the extended calibration>

| D1900V2 – serial no. 5d185  |                  |           |                      |             |                           |             |
|-----------------------------|------------------|-----------|----------------------|-------------|---------------------------|-------------|
| 1900MHZ                     |                  |           |                      |             |                           |             |
| Date of Measurement         | Return-Loss (dB) | Delta (%) | Real Impedance (ohm) | Delta (ohm) | Imaginary Impedance (ohm) | Delta (ohm) |
| 06.17.2022<br>(Cal. Report) | -26.716          |           | 52.666               |             | 3.9213                    |             |
| 06.16.2023<br>(extended)    | -26.908          | -0.072    | 53.715               | 1.049       | 3.9028                    | -0.0185     |

The return loss is <-20dB, within 20% of prior calibration; the impedance is within 5 ohm of prior calibration. Therefore the verification result should support extended calibration.



<Dipole Verification Data> - D1900 V2, serial no. 5d185(Data of Measurement : 06.16.2023)

1900MHz - Head

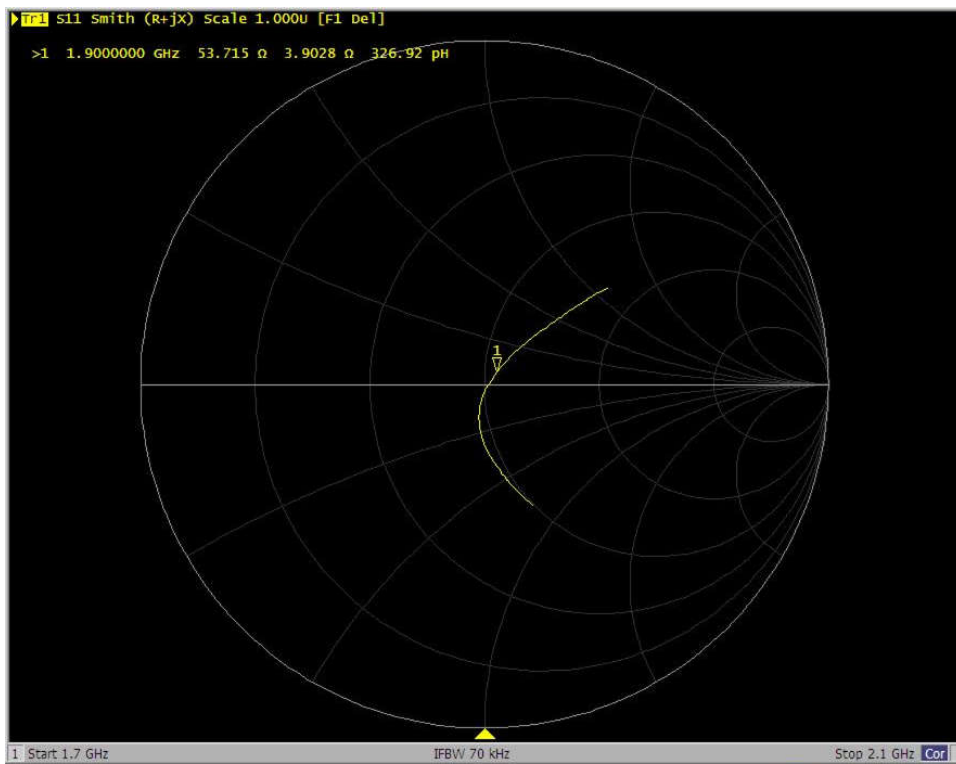
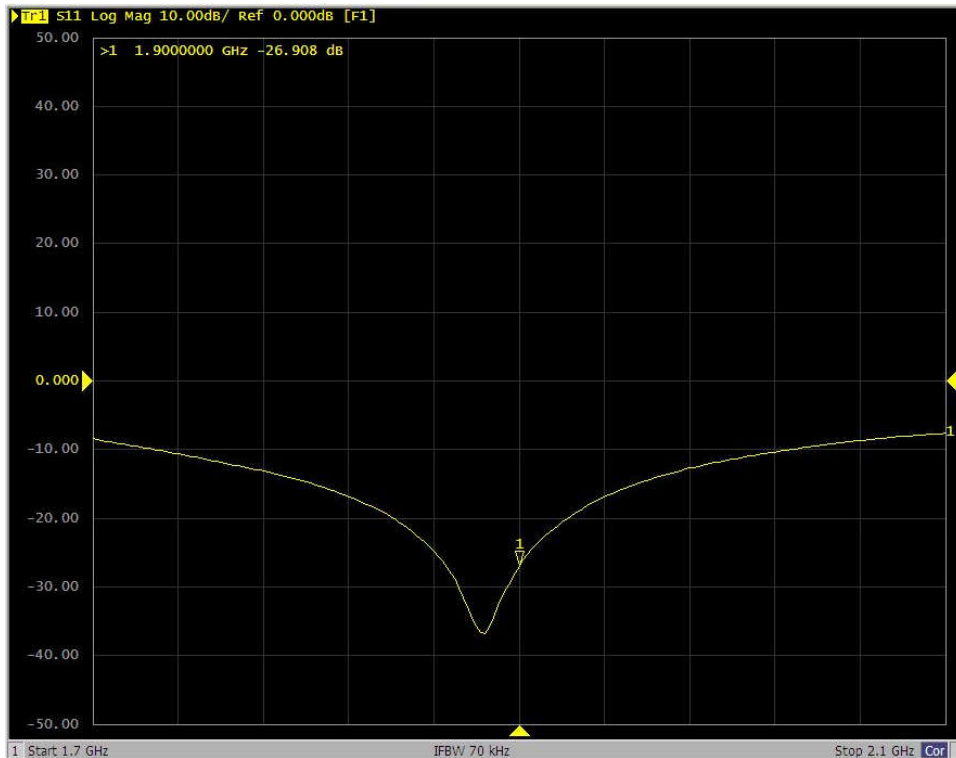



Accredited by the Swiss Accreditation Service (SAS)  
The Swiss Accreditation Service is one of the signatories to the EA  
Multilateral Agreement for the recognition of calibration certificates

Accreditation No.: **SCS 0108**

Client **Sporton**

Certificate No: **D2300V2-1006\_Jan22**

## CALIBRATION CERTIFICATE

Object: **D2300V2 - SN:1006**

Calibration procedure(s): **QA CAL-05.v11  
Calibration Procedure for SAR Validation Sources between 0.7-3 GHz**

Calibration date: **January 18, 2022**

This calibration certificate documents the traceability to national standards, which realize the physical units of measurements (SI).  
The measurements and the uncertainties with confidence probability are given on the following pages and are part of the certificate.

All calibrations have been conducted in the closed laboratory facility: environment temperature ( $22 \pm 3$ )°C and humidity < 70%.

Calibration Equipment used (M&TE critical for calibration)

| Primary Standards           | ID #               | Cal Date (Certificate No.)      | Scheduled Calibration |
|-----------------------------|--------------------|---------------------------------|-----------------------|
| Power meter NRP             | SN: 104778         | 09-Apr-21 (No. 217-03291/03292) | Apr-22                |
| Power sensor NRP-Z91        | SN: 103244         | 09-Apr-21 (No. 217-03291)       | Apr-22                |
| Power sensor NRP-Z91        | SN: 103245         | 09-Apr-21 (No. 217-03292)       | Apr-22                |
| Reference 20 dB Attenuator  | SN: BH9394 (20k)   | 09-Apr-21 (No. 217-03343)       | Apr-22                |
| Type-N mismatch combination | SN: 310982 / 06327 | 09-Apr-21 (No. 217-03344)       | Apr-22                |
| Reference Probe EX3DV4      | SN: 7349           | 31-Dec-21 (No. EX3-7349_Dec21)  | Dec-22                |
| DAE4                        | SN: 601            | 01-Nov-21 (No. DAE4-601_Nov21)  | Nov-22                |

| Secondary Standards             | ID #           | Check Date (in house)             | Scheduled Check        |
|---------------------------------|----------------|-----------------------------------|------------------------|
| Power meter E4419B              | SN: GB39512475 | 30-Oct-14 (in house check Oct-20) | In house check: Oct-22 |
| Power sensor HP 8481A           | SN: US37292783 | 07-Oct-15 (in house check Oct-20) | In house check: Oct-22 |
| Power sensor HP 8481A           | SN: MY41093315 | 07-Oct-15 (in house check Oct-20) | In house check: Oct-22 |
| RF generator R&S SMT-06         | SN: 100972     | 15-Jun-15 (in house check Oct-20) | In house check: Oct-22 |
| Network Analyzer Agilent E8358A | SN: US41080477 | 31-Mar-14 (in house check Oct-20) | In house check: Oct-22 |

|                |                    |                       |           |
|----------------|--------------------|-----------------------|-----------|
|                | Name               | Function              | Signature |
| Calibrated by: | Aidonia Georgiadou | Laboratory Technician |           |

|              |           |                |  |
|--------------|-----------|----------------|--|
| Approved by: | Sven Kühn | Deputy Manager |  |
|--------------|-----------|----------------|--|

Issued: January 19, 2022

This calibration certificate shall not be reproduced except in full without written approval of the laboratory.





Accredited by the Swiss Accreditation Service (SAS)  
The Swiss Accreditation Service is one of the signatories to the EA  
Multilateral Agreement for the recognition of calibration certificates

Accreditation No.: **SCS 0108**

**Glossary:**

|       |                                 |
|-------|---------------------------------|
| TSL   | tissue simulating liquid        |
| ConvF | sensitivity in TSL / NORM x,y,z |
| N/A   | not applicable or not measured  |

**Calibration is Performed According to the Following Standards:**

- IEC/IEEE 62209-1528, "Measurement Procedure For The Assessment Of Specific Absorption Rate Of Human Exposure To Radio Frequency Fields From Hand-Held And Body-Worn Wireless Communication Devices - Part 1528: Human Models, Instrumentation And Procedures (Frequency Range of 4 MHz to 10 GHz)", October 2020.
- KDB 865664, "SAR Measurement Requirements for 100 MHz to 6 GHz"

**Additional Documentation:**

- DASY System Handbook

**Methods Applied and Interpretation of Parameters:**

- Measurement Conditions:* Further details are available from the Validation Report at the end of the certificate. All figures stated in the certificate are valid at the frequency indicated.
- Antenna Parameters with TSL:* The source is mounted in a touch configuration below the center marking of the flat phantom.
- Return Loss:* This parameter is measured with the source positioned under the liquid filled phantom (as described in the measurement condition clause). The Return Loss ensures low reflected power. No uncertainty required.
- SAR measured:* SAR measured at the stated antenna input power.
- SAR normalized:* SAR as measured, normalized to an input power of 1 W at the antenna connector.
- SAR for nominal TSL parameters:* The measured TSL parameters are used to calculate the nominal SAR result.

The reported uncertainty of measurement is stated as the standard uncertainty of measurement multiplied by the coverage factor  $k=2$ , which for a normal distribution corresponds to a coverage probability of approximately 95%.

## Measurement Conditions

DASY system configuration, as far as not given on page 1.

|                              |                        |             |
|------------------------------|------------------------|-------------|
| DASY Version                 | DASY52                 | V52.10.4    |
| Extrapolation                | Advanced Extrapolation |             |
| Phantom                      | Modular Flat Phantom   |             |
| Distance Dipole Center - TSL | 10 mm                  | with Spacer |
| Zoom Scan Resolution         | dx, dy, dz = 5 mm      |             |
| Frequency                    | 2300 MHz $\pm$ 1 MHz   |             |

## Head TSL parameters

The following parameters and calculations were applied.

|   | Temperature         | Permittivity   | Conductivity         |
|---|---------------------|----------------|----------------------|
| Nominal Head TSL parameters             | 22.0 °C             | 39.5           | 1.67 mho/m           |
| Measured Head TSL parameters            | (22.0 $\pm$ 0.2) °C | 38.8 $\pm$ 6 % | 1.69 mho/m $\pm$ 6 % |
| Head TSL temperature change during test | < 0.5 °C            | ----           | ----                 |

## SAR result with Head TSL

| SAR averaged over 1 cm <sup>3</sup> (1 g) of Head TSL | Condition          |  |
|---|--------------------|--|
| SAR measured  | 250 mW input power | 12.2 W/kg                                      |
| SAR for nominal Head TSL parameters                   | normalized to 1W   | <b>48.3 W/kg <math>\pm</math> 17.0 % (k=2)</b> |

| SAR averaged over 10 cm <sup>3</sup> (10 g) of Head TSL | condition          |  |
|---|--------------------|--|
| SAR measured  | 250 mW input power | 5.90 W/kg                                      |
| SAR for nominal Head TSL parameters                     | normalized to 1W   | <b>23.5 W/kg <math>\pm</math> 16.5 % (k=2)</b> |

## Appendix (Additional assessments outside the scope of SCS 0108)

### Antenna Parameters with Head TSL

|                                      |                                |
|--------------------------------------|--------------------------------|
| Impedance, transformed to feed point | 49.4 $\Omega$ - 2.4 j $\Omega$ |
| Return Loss                          | - 31.9 dB                      |

### General Antenna Parameters and Design

|                                  |          |
|----------------------------------|----------|
| Electrical Delay (one direction) | 1.168 ns |
|----------------------------------|----------|

After long term use with 100W radiated power, only a slight warming of the dipole near the feedpoint can be measured.

The dipole is made of standard semirigid coaxial cable. The center conductor of the feeding line is directly connected to the second arm of the dipole. The antenna is therefore short-circuited for DC-signals. On some of the dipoles, small end caps are added to the dipole arms in order to improve matching when loaded according to the position as explained in the "Measurement Conditions" paragraph. The SAR data are not affected by this change. The overall dipole length is still according to the Standard.

No excessive force must be applied to the dipole arms, because they might bend or the soldered connections near the feedpoint may be damaged.

### Additional EUT Data

|                 |       |
|-----------------|-------|
| Manufactured by | SPEAG |
|-----------------|-------|

## DASY5 Validation Report for Head TSL

Date: 18.01.2022

Test Laboratory: SPEAG, Zurich, Switzerland

**DUT: Dipole 2300 MHz; Type: D2300V2; Serial: D2300V2 - SN:1006**

Communication System: UID 0 - CW; Frequency: 2300 MHz

Medium parameters used:  $f = 2300$  MHz;  $\sigma = 1.69$  S/m;  $\epsilon_r = 38.8$ ;  $\rho = 1000$  kg/m<sup>3</sup>

Phantom section: Flat Section

Measurement Standard: DASY5 (IEEE/IEC/ANSI C63.19-2011)

DASY52 Configuration:

- Probe: EX3DV4 - SN7349; ConvF(7.98, 7.98, 7.98) @ 2300 MHz; Calibrated: 31.12.2021
- Sensor-Surface: 1.4mm (Mechanical Surface Detection)
- Electronics: DAE4 Sn601; Calibrated: 01.11.2021
- Phantom: Flat Phantom 5.0 (front); Type: QD 000 P50 AA; Serial: 1001
- DASY52 52.10.4(1535); SEMCAD X 14.6.14(7501)

### Dipole Calibration for Head Tissue/**Pin=250 mW, d=10mm/Zoom Scan (7x7x7)/Cube 0:**

Measurement grid:  $dx=5$ mm,  $dy=5$ mm,  $dz=5$ mm

Reference Value = 116.5 V/m; Power Drift = 0.05 dB

Peak SAR (extrapolated) = 22.3 W/kg

**SAR(1 g) = 12.2 W/kg; SAR(10 g) = 5.9 W/kg**

Smallest distance from peaks to all points 3 dB below = 9 mm

Ratio of SAR at M2 to SAR at M1 = 55.1%

Maximum value of SAR (measured) = 19.2 W/kg

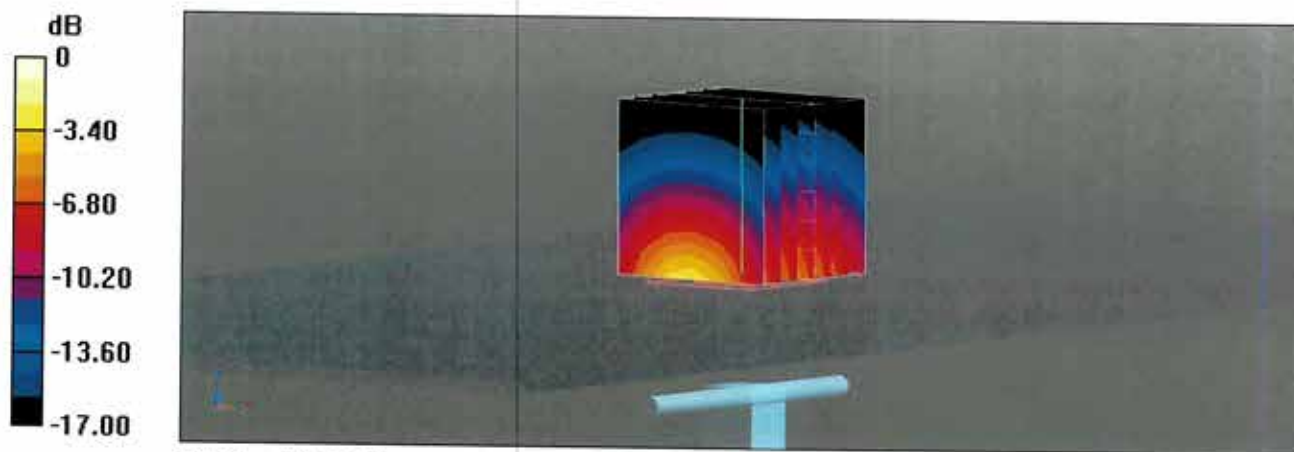

0 dB = 19.2 W/kg = 12.83 dBW/kg

# Impedance Measurement Plot for Head TSL

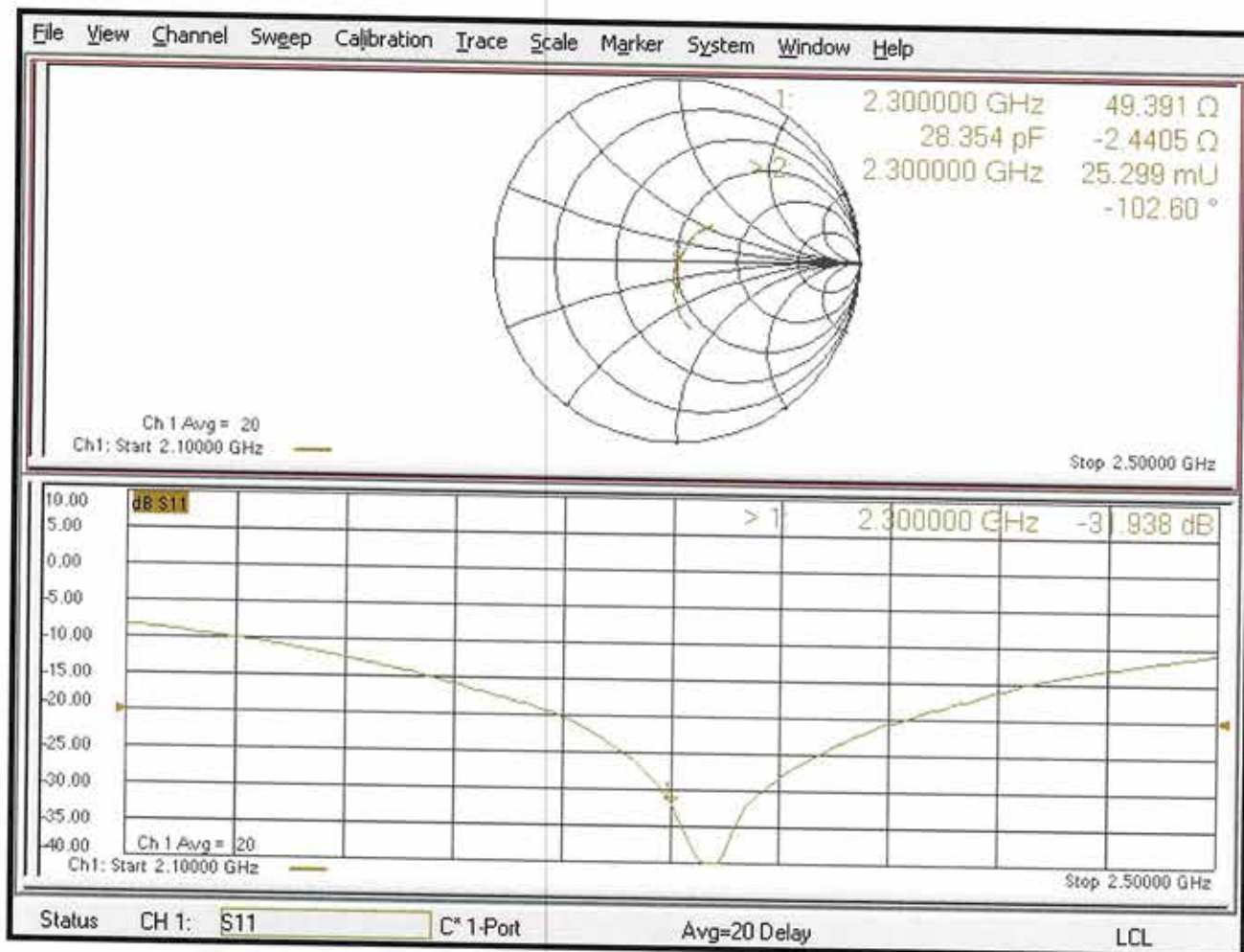



## D2300V2, serial no. 1006 Extended Dipole Calibrations

If dipoles are verified in return loss (<-20dB, within 20% of prior calibration), and in impedance (within 5 ohm of prior calibration), the annual calibration is not necessary and the calibration interval can be extended.

### <Justification of the extended calibration>

| D2300V2 – serial no. 1006   |                  |           |                      |             |                           |             |
|-----------------------------|------------------|-----------|----------------------|-------------|---------------------------|-------------|
| 2300MHZ                     |                  |           |                      |             |                           |             |
| Date of Measurement         | Return-Loss (dB) | Delta (%) | Real Impedance (ohm) | Delta (ohm) | Imaginary Impedance (ohm) | Delta (ohm) |
| 01.18.2022<br>(Cal. Report) | -31.938          |           | 49.391               |             | -2.4405                   |             |
| 01.17.2023<br>(extended)    | -32.11           | 0.539     | 46.957               | -2.434      | -3.2857                   | -0.8452     |

The return loss is <-20dB, within 20% of prior calibration; the impedance is within 5 ohm of prior calibration. Therefore the verification result should support extended calibration.

<Dipole Verification Data> - D2300V2, serial no. 1006 (Data of Measurement : 01.17.2023)  
2300MHz - Head

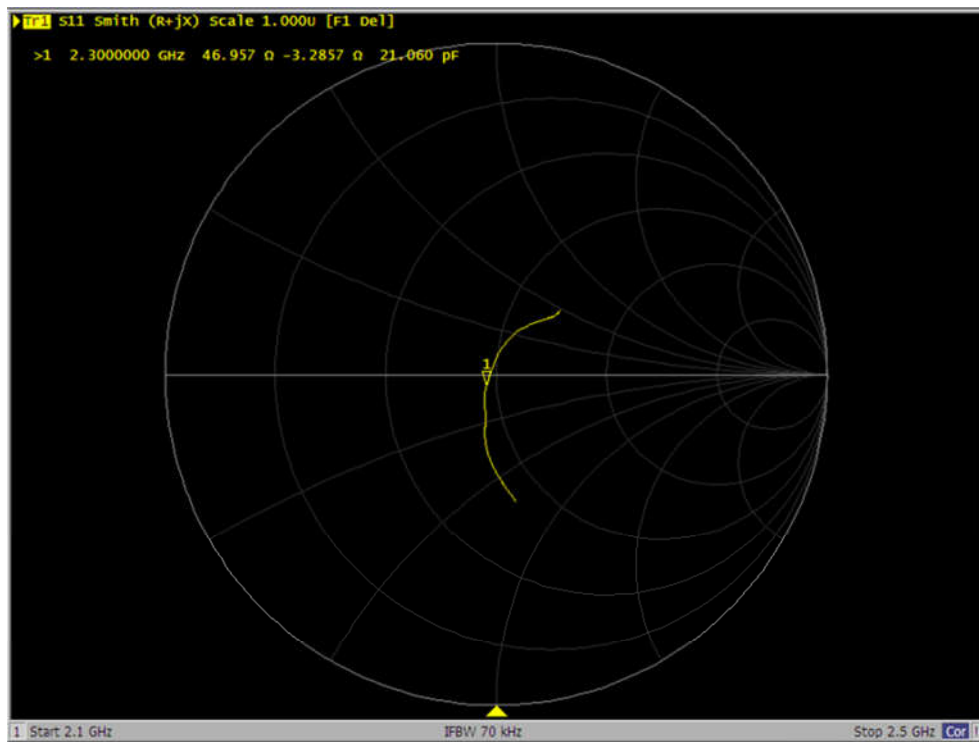
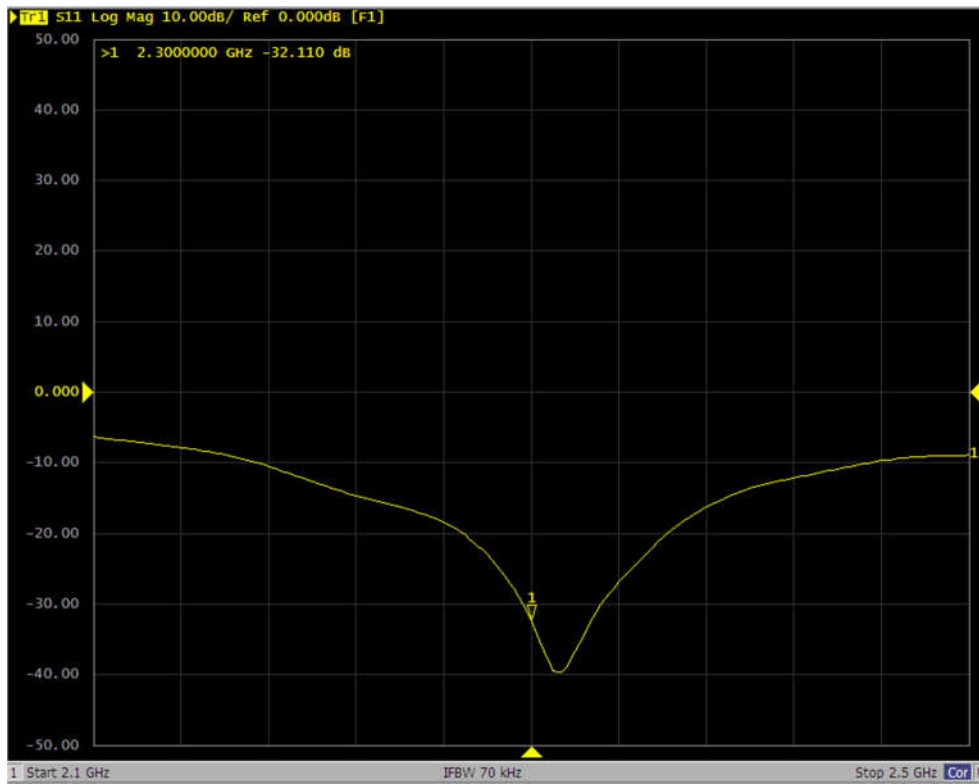



Accredited by the Swiss Accreditation Service (SAS)  
The Swiss Accreditation Service is one of the signatories to the EA  
Multilateral Agreement for the recognition of calibration certificates

Accreditation No.: **SCS 0108**

Client **Sporton**

Certificate No: **D2450V2-929\_Nov22**

## CALIBRATION CERTIFICATE

Object **D2450V2 - SN:929**

Calibration procedure(s) **QA CAL-05.v11  
Calibration Procedure for SAR Validation Sources between 0.7-3 GHz**

Calibration date: **November 21, 2022**

This calibration certificate documents the traceability to national standards, which realize the physical units of measurements (SI).  
The measurements and the uncertainties with confidence probability are given on the following pages and are part of the certificate.

All calibrations have been conducted in the closed laboratory facility; environment temperature ( $22 \pm 3$ )°C and humidity < 70%.

Calibration Equipment used (M&TE critical for calibration)

| Primary Standards               | ID #               | Cal Date (Certificate No.)        | Scheduled Calibration  |
|---------------------------------|--------------------|-----------------------------------|------------------------|
| Power meter NRP                 | SN: 104778         | 04-Apr-22 (No. 217-03525/03524)   | Apr-23                 |
| Power sensor NRP-Z91            | SN: 103244         | 04-Apr-22 (No. 217-03524)         | Apr-23                 |
| Power sensor NRP-Z91            | SN: 103245         | 04-Apr-22 (No. 217-03525)         | Apr-23                 |
| Reference 20 dB Attenuator      | SN: BH9394 (20k)   | 04-Apr-22 (No. 217-03527)         | Apr-23                 |
| Type-N mismatch combination     | SN: 310982 / 06327 | 04-Apr-22 (No. 217-03528)         | Apr-23                 |
| Reference Probe EX3DV4          | SN: 7349           | 31-Dec-21 (No. EX3-7349_Dec21)    | Dec-22                 |
| DAE4                            | SN: 601            | 31-Aug-22 (No. DAE4-601_Aug22)    | Aug-23                 |
| Secondary Standards             | ID #               | Check Date (in house)             | Scheduled Check        |
| Power meter E4419B              | SN: GB39512475     | 30-Oct-14 (in house check Oct-22) | In house check: Oct-24 |
| Power sensor HP 8481A           | SN: US37292783     | 07-Oct-15 (in house check Oct-22) | In house check: Oct-24 |
| Power sensor HP 8481A           | SN: MY41093315     | 07-Oct-15 (in house check Oct-22) | In house check: Oct-24 |
| RF generator R&S SMT-06         | SN: 100972         | 15-Jun-15 (in house check Oct-22) | In house check: Oct-24 |
| Network Analyzer Agilent E8358A | SN: US41080477     | 31-Mar-14 (in house check Oct-22) | In house check: Oct-24 |

|                |                               |                                   |               |
|----------------|-------------------------------|-----------------------------------|---------------|
| Calibrated by: | Name<br><b>Jeton Kastrati</b> | Function<br>Laboratory Technician | Signature<br> |
| Approved by:   | Name<br><b>Sven Kühn</b>      | Technical Manager                 |               |

Issued: November 22, 2022

This calibration certificate shall not be reproduced except in full without written approval of the laboratory.





Accredited by the Swiss Accreditation Service (SAS)  
The Swiss Accreditation Service is one of the signatories to the EA  
Multilateral Agreement for the recognition of calibration certificates

Accreditation No.: **SCS 0108**

### Glossary:

|       |                                 |
|-------|---------------------------------|
| TSL   | tissue simulating liquid        |
| ConvF | sensitivity in TSL / NORM x,y,z |
| N/A   | not applicable or not measured  |

### Calibration is Performed According to the Following Standards:

- IEC/IEEE 62209-1528, "Measurement Procedure For The Assessment Of Specific Absorption Rate Of Human Exposure To Radio Frequency Fields From Hand-Held And Body-Worn Wireless Communication Devices - Part 1528: Human Models, Instrumentation And Procedures (Frequency Range of 4 MHz to 10 GHz)", October 2020.
- KDB 865664, "SAR Measurement Requirements for 100 MHz to 6 GHz"

### Additional Documentation:

- DASY System Handbook

### Methods Applied and Interpretation of Parameters:

- Measurement Conditions:* Further details are available from the Validation Report at the end of the certificate. All figures stated in the certificate are valid at the frequency indicated.
- Antenna Parameters with TSL:* The source is mounted in a touch configuration below the center marking of the flat phantom.
- Return Loss:* This parameter is measured with the source positioned under the liquid filled phantom (as described in the measurement condition clause). The Return Loss ensures low reflected power. No uncertainty required.
- SAR measured:* SAR measured at the stated antenna input power.
- SAR normalized:* SAR as measured, normalized to an input power of 1 W at the antenna connector.
- SAR for nominal TSL parameters:* The measured TSL parameters are used to calculate the nominal SAR result.

The reported uncertainty of measurement is stated as the standard uncertainty of measurement multiplied by the coverage factor  $k=2$ , which for a normal distribution corresponds to a coverage probability of approximately 95%.

## Measurement Conditions

DASY system configuration, as far as not given on page 1.

|                                     |                        |             |
|-------------------------------------|------------------------|-------------|
| <b>DASY Version</b>                 | DASY52                 | V52.10.4    |
| <b>Extrapolation</b>                | Advanced Extrapolation |             |
| <b>Phantom</b>                      | Modular Flat Phantom   |             |
| <b>Distance Dipole Center - TSL</b> | 10 mm                  | with Spacer |
| <b>Zoom Scan Resolution</b>         | dx, dy, dz = 5 mm      |             |
| <b>Frequency</b>                    | 2450 MHz $\pm$ 1 MHz   |             |

## Head TSL parameters

The following parameters and calculations were applied.

|  | Temperature         | Permittivity   | Conductivity         |
|--|---------------------|----------------|----------------------|
| <b>Nominal Head TSL parameters</b>             | 22.0 °C             | 39.2           | 1.80 mho/m           |
| <b>Measured Head TSL parameters</b>            | (22.0 $\pm$ 0.2) °C | 38.4 $\pm$ 6 % | 1.87 mho/m $\pm$ 6 % |
| <b>Head TSL temperature change during test</b> | < 0.5 °C            | ----           | ----                 |

## SAR result with Head TSL

| <b>SAR averaged over 1 cm<sup>3</sup> (1 g) of Head TSL</b> | Condition          |  |
|---|--------------------|--|
| SAR measured  | 250 mW input power | 13.4 W/kg                                      |
| SAR for nominal Head TSL parameters                         | normalized to 1W   | <b>52.4 W/kg <math>\pm</math> 17.0 % (k=2)</b> |

| <b>SAR averaged over 10 cm<sup>3</sup> (10 g) of Head TSL</b> | condition          |  |
|---|--------------------|--|
| SAR measured  | 250 mW input power | 6.25 W/kg                                      |
| SAR for nominal Head TSL parameters                           | normalized to 1W   | <b>24.7 W/kg <math>\pm</math> 16.5 % (k=2)</b> |

## Appendix (Additional assessments outside the scope of SCS 0108)

### Antenna Parameters with Head TSL

|                                      |                                |
|--------------------------------------|--------------------------------|
| Impedance, transformed to feed point | 52.9 $\Omega$ + 4.7 j $\Omega$ |
| Return Loss                          | - 25.5 dB                      |

### General Antenna Parameters and Design

|                                  |          |
|----------------------------------|----------|
| Electrical Delay (one direction) | 1.162 ns |
|----------------------------------|----------|

After long term use with 100W radiated power, only a slight warming of the dipole near the feedpoint can be measured.

The dipole is made of standard semirigid coaxial cable. The center conductor of the feeding line is directly connected to the second arm of the dipole. The antenna is therefore short-circuited for DC-signals. On some of the dipoles, small end caps are added to the dipole arms in order to improve matching when loaded according to the position as explained in the "Measurement Conditions" paragraph. The SAR data are not affected by this change. The overall dipole length is still according to the Standard.

No excessive force must be applied to the dipole arms, because they might bend or the soldered connections near the feedpoint may be damaged.

### Additional EUT Data

|                 |       |
|-----------------|-------|
| Manufactured by | SPEAG |
|-----------------|-------|

# DASY5 Validation Report for Head TSL

Date: 21.11.2022

Test Laboratory: SPEAG, Zurich, Switzerland

**DUT: Dipole 2450 MHz; Type: D2450V2; Serial: D2450V2 - SN:929**

Communication System: UID 0 - CW; Frequency: 2450 MHz

Medium parameters used:  $f = 2450$  MHz;  $\sigma = 1.87$  S/m;  $\epsilon_r = 38.4$ ;  $\rho = 1000$  kg/m<sup>3</sup>

Phantom section: Flat Section

Measurement Standard: DASY5 (IEEE/IEC/ANSI C63.19-2011)

DASY52 Configuration:

- Probe: EX3DV4 - SN7349; ConvF(7.96, 7.96, 7.96) @ 2450 MHz; Calibrated: 31.12.2021
- Sensor-Surface: 1.4mm (Mechanical Surface Detection)
- Electronics: DAE4 Sn601; Calibrated: 31.08.2022
- Phantom: Flat Phantom 5.0 (front); Type: QD 000 P50 AA; Serial: 1001
- DASY52 52.10.4(1535); SEMCAD X 14.6.14(7501)

## Dipole Calibration for Head Tissue/Pin=250 mW, d=10mm/Zoom Scan (7x7x7)/Cube 0:

Measurement grid: dx=5mm, dy=5mm, dz=5mm

Reference Value = 115.9 V/m; Power Drift = 0.01 dB

Peak SAR (extrapolated) = 26.1 W/kg

**SAR(1 g) = 13.4 W/kg; SAR(10 g) = 6.25 W/kg**

Smallest distance from peaks to all points 3 dB below = 9 mm

Ratio of SAR at M2 to SAR at M1 = 51.5%

Maximum value of SAR (measured) = 21.8 W/kg

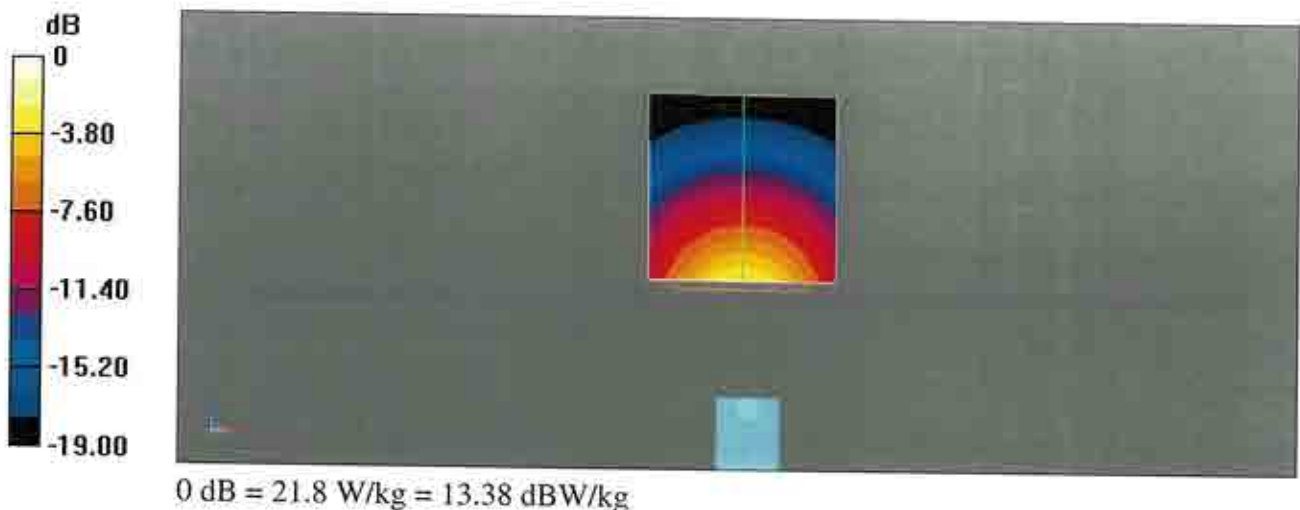

# Impedance Measurement Plot for Head TSL

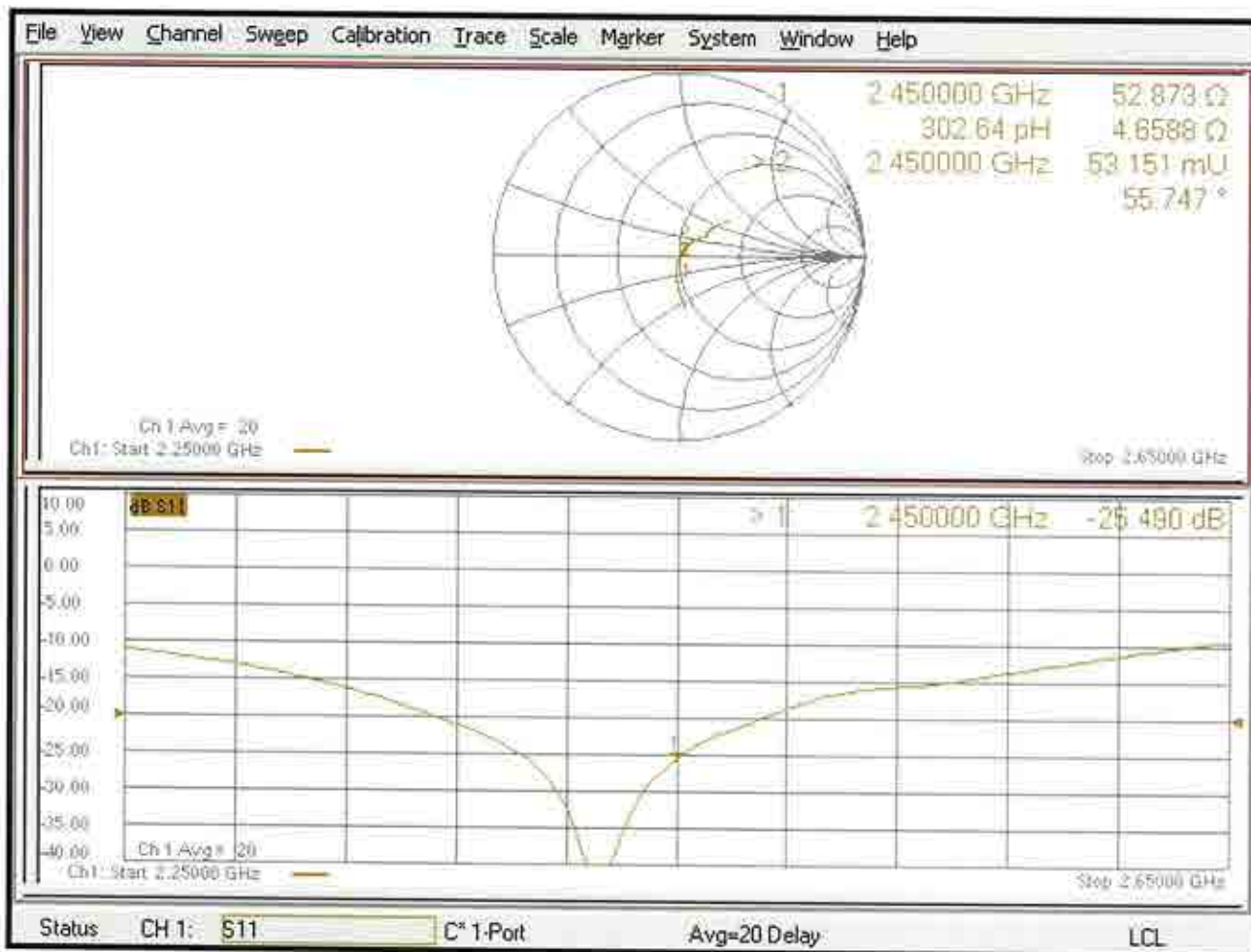



Accredited by the Swiss Accreditation Service (SAS)  
The Swiss Accreditation Service is one of the signatories to the EA  
Multilateral Agreement for the recognition of calibration certificates

Accreditation No.: **SCS 0108**

Client **Sporton**

Certificate No: **D2600V2-1078\_Jun22**

## CALIBRATION CERTIFICATE

Object **D2600V2 - SN:1078**

Calibration procedure(s) **QA CAL-05.v11  
Calibration Procedure for SAR Validation Sources between 0.7-3 GHz**

Calibration date: **June 23, 2022**

This calibration certificate documents the traceability to national standards, which realize the physical units of measurements (SI).  
The measurements and the uncertainties with confidence probability are given on the following pages and are part of the certificate.

All calibrations have been conducted in the closed laboratory facility: environment temperature ( $22 \pm 3$ )°C and humidity < 70%.

Calibration Equipment used (M&TE critical for calibration)

| Primary Standards           | ID #               | Cal Date (Certificate No.)      | Scheduled Calibration |
|-----------------------------|--------------------|---------------------------------|-----------------------|
| Power meter NRP             | SN: 104778         | 04-Apr-22 (No. 217-03525/03524) | Apr-23                |
| Power sensor NRP-Z91        | SN: 103244         | 04-Apr-22 (No. 217-03524)       | Apr-23                |
| Power sensor NRP-Z91        | SN: 103245         | 04-Apr-22 (No. 217-03525)       | Apr-23                |
| Reference 20 dB Attenuator  | SN: BH9394 (20k)   | 04-Apr-22 (No. 217-03527)       | Apr-23                |
| Type-N mismatch combination | SN: 310982 / 06327 | 04-Apr-22 (No. 217-03528)       | Apr-23                |
| Reference Probe EX3DV4      | SN: 7349           | 31-Dec-21 (No. EX3-7349_Dec21)  | Dec-22                |
| DAE4                        | SN: 601            | 02-May-22 (No. DAE4-601_May22)  | May-23                |

| Secondary Standards             | ID #           | Check Date (in house)             | Scheduled Check        |
|---------------------------------|----------------|-----------------------------------|------------------------|
| Power meter E4419B              | SN: GB39512475 | 30-Oct-14 (in house check Oct-20) | In house check: Oct-22 |
| Power sensor HP 8481A           | SN: US37292783 | 07-Oct-15 (in house check Oct-20) | In house check: Oct-22 |
| Power sensor HP 8481A           | SN: MY41093315 | 07-Oct-15 (in house check Oct-20) | In house check: Oct-22 |
| RF generator R&S SMT-06         | SN: 100972     | 15-Jun-15 (in house check Oct-20) | In house check: Oct-22 |
| Network Analyzer Agilent E8358A | SN: US41080477 | 31-Mar-14 (in house check Oct-20) | In house check: Oct-22 |

|                |                |                       |                  |
|----------------|----------------|-----------------------|------------------|
|                | <b>Name</b>    | <b>Function</b>       | <b>Signature</b> |
| Calibrated by: | Joanna Lleshaj | Laboratory Technician |                  |

|              |             |                   |                  |
|--------------|-------------|-------------------|------------------|
|              | <b>Name</b> | <b>Function</b>   | <b>Signature</b> |
| Approved by: | Sven Kühn   | Technical Manager |                  |

Issued: June 24, 2022

This calibration certificate shall not be reproduced except in full without written approval of the laboratory.



Accredited by the Swiss Accreditation Service (SAS)  
The Swiss Accreditation Service is one of the signatories to the EA  
Multilateral Agreement for the recognition of calibration certificates

Accreditation No.: **SCS 0108**

### Glossary:

|       |                                 |
|-------|---------------------------------|
| TSL   | tissue simulating liquid        |
| ConvF | sensitivity in TSL / NORM x,y,z |
| N/A   | not applicable or not measured  |

### Calibration is Performed According to the Following Standards:

- IEC/IEEE 62209-1528, "Measurement Procedure For The Assessment Of Specific Absorption Rate Of Human Exposure To Radio Frequency Fields From Hand-Held And Body-Worn Wireless Communication Devices - Part 1528: Human Models, Instrumentation And Procedures (Frequency Range of 4 MHz to 10 GHz)", October 2020.
- KDB 865664, "SAR Measurement Requirements for 100 MHz to 6 GHz"

### Additional Documentation:

- DASY System Handbook

### Methods Applied and Interpretation of Parameters:

- Measurement Conditions:* Further details are available from the Validation Report at the end of the certificate. All figures stated in the certificate are valid at the frequency indicated.
- Antenna Parameters with TSL:* The source is mounted in a touch configuration below the center marking of the flat phantom.
- Return Loss:* This parameter is measured with the source positioned under the liquid filled phantom (as described in the measurement condition clause). The Return Loss ensures low reflected power. No uncertainty required.
- SAR measured:* SAR measured at the stated antenna input power.
- SAR normalized:* SAR as measured, normalized to an input power of 1 W at the antenna connector.
- SAR for nominal TSL parameters:* The measured TSL parameters are used to calculate the nominal SAR result.

The reported uncertainty of measurement is stated as the standard uncertainty of measurement multiplied by the coverage factor  $k=2$ , which for a normal distribution corresponds to a coverage probability of approximately 95%.

## Measurement Conditions

DASY system configuration, as far as not given on page 1.

|                              |                        |             |
|------------------------------|------------------------|-------------|
| DASY Version                 | DASY52                 | V52.10.4    |
| Extrapolation                | Advanced Extrapolation |             |
| Phantom                      | Modular Flat Phantom   |             |
| Distance Dipole Center - TSL | 10 mm                  | with Spacer |
| Zoom Scan Resolution         | dx, dy, dz = 5 mm      |             |
| Frequency                    | 2600 MHz $\pm$ 1 MHz   |             |

## Head TSL parameters

The following parameters and calculations were applied.

|   | Temperature         | Permittivity   | Conductivity         |
|---|---------------------|----------------|----------------------|
| Nominal Head TSL parameters             | 22.0 °C             | 39.0           | 1.96 mho/m           |
| Measured Head TSL parameters            | (22.0 $\pm$ 0.2) °C | 37.8 $\pm$ 6 % | 2.01 mho/m $\pm$ 6 % |
| Head TSL temperature change during test | < 0.5 °C            | ----           | ----                 |

## SAR result with Head TSL

| SAR averaged over 1 cm <sup>3</sup> (1 g) of Head TSL | Condition          |  |
|---|--------------------|--|
| SAR measured  | 250 mW input power | 14.1 W/kg                                      |
| SAR for nominal Head TSL parameters                   | normalized to 1W   | <b>55.4 W/kg <math>\pm</math> 17.0 % (k=2)</b> |

| SAR averaged over 10 cm <sup>3</sup> (10 g) of Head TSL | condition          |  |
|---|--------------------|--|
| SAR measured  | 250 mW input power | 6.29 W/kg                                      |
| SAR for nominal Head TSL parameters                     | normalized to 1W   | <b>24.9 W/kg <math>\pm</math> 16.5 % (k=2)</b> |



## Appendix (Additional assessments outside the scope of SCS 0108)

### Antenna Parameters with Head TSL

|                                      |                               |
|--------------------------------------|-------------------------------|
| Impedance, transformed to feed point | 49.2 $\Omega$ - 7.3 $j\Omega$ |
| Return Loss                          | - 22.6 dB                     |

### General Antenna Parameters and Design

|                                  |          |
|----------------------------------|----------|
| Electrical Delay (one direction) | 1.153 ns |
|----------------------------------|----------|

After long term use with 100W radiated power, only a slight warming of the dipole near the feedpoint can be measured.

The dipole is made of standard semirigid coaxial cable. The center conductor of the feeding line is directly connected to the second arm of the dipole. The antenna is therefore short-circuited for DC-signals. On some of the dipoles, small end caps are added to the dipole arms in order to improve matching when loaded according to the position as explained in the "Measurement Conditions" paragraph. The SAR data are not affected by this change. The overall dipole length is still according to the Standard.

No excessive force must be applied to the dipole arms, because they might bend or the soldered connections near the feedpoint may be damaged.

### Additional EUT Data

|                 |       |
|-----------------|-------|
| Manufactured by | SPEAG |
|-----------------|-------|

# DASY5 Validation Report for Head TSL

Date: 23.06.2022

Test Laboratory: SPEAG, Zurich, Switzerland

**DUT: Dipole 2600 MHz; Type: D2600V2; Serial: D2600V2 - SN:1078**

Communication System: UID 0 - CW; Frequency: 2600 MHz

Medium parameters used:  $f = 2600$  MHz;  $\sigma = 2.01$  S/m;  $\epsilon_r = 37.8$ ;  $\rho = 1000$  kg/m<sup>3</sup>

Phantom section: Flat Section

Measurement Standard: DASY5 (IEEE/IEC/ANSI C63.19-2011)

DASY52 Configuration:

- Probe: EX3DV4 - SN7349; ConvF(7.84, 7.84, 7.84) @ 2600 MHz; Calibrated: 31.12.2021
- Sensor-Surface: 1.4mm (Mechanical Surface Detection)
- Electronics: DAE4 Sn601; Calibrated: 02.05.2022
- Phantom: Flat Phantom 5.0 (front); Type: QD 000 P50 AA; Serial: 1001
- DASY52 52.10.4(1535); SEMCAD X 14.6.14(7501)

## Dipole Calibration for Head Tissue/Pin=250 mW, d=10mm/Zoom Scan (7x7x7)/Cube 0:

Measurement grid: dx=5mm, dy=5mm, dz=5mm

Reference Value = 117.7 V/m; Power Drift = 0.07 dB

Peak SAR (extrapolated) = 28.0 W/kg

**SAR(1 g) = 14.1 W/kg; SAR(10 g) = 6.29 W/kg**

Smallest distance from peaks to all points 3 dB below = 9 mm

Ratio of SAR at M2 to SAR at M1 = 50.5%

Maximum value of SAR (measured) = 23.5 W/kg

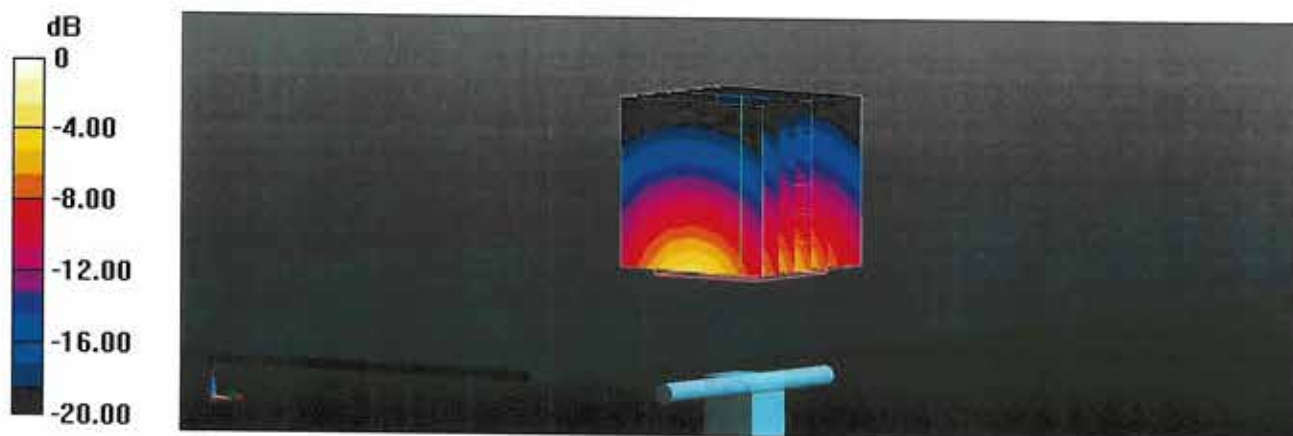

0 dB = 23.5 W/kg = 13.71 dBW/kg

# Impedance Measurement Plot for Head TSL

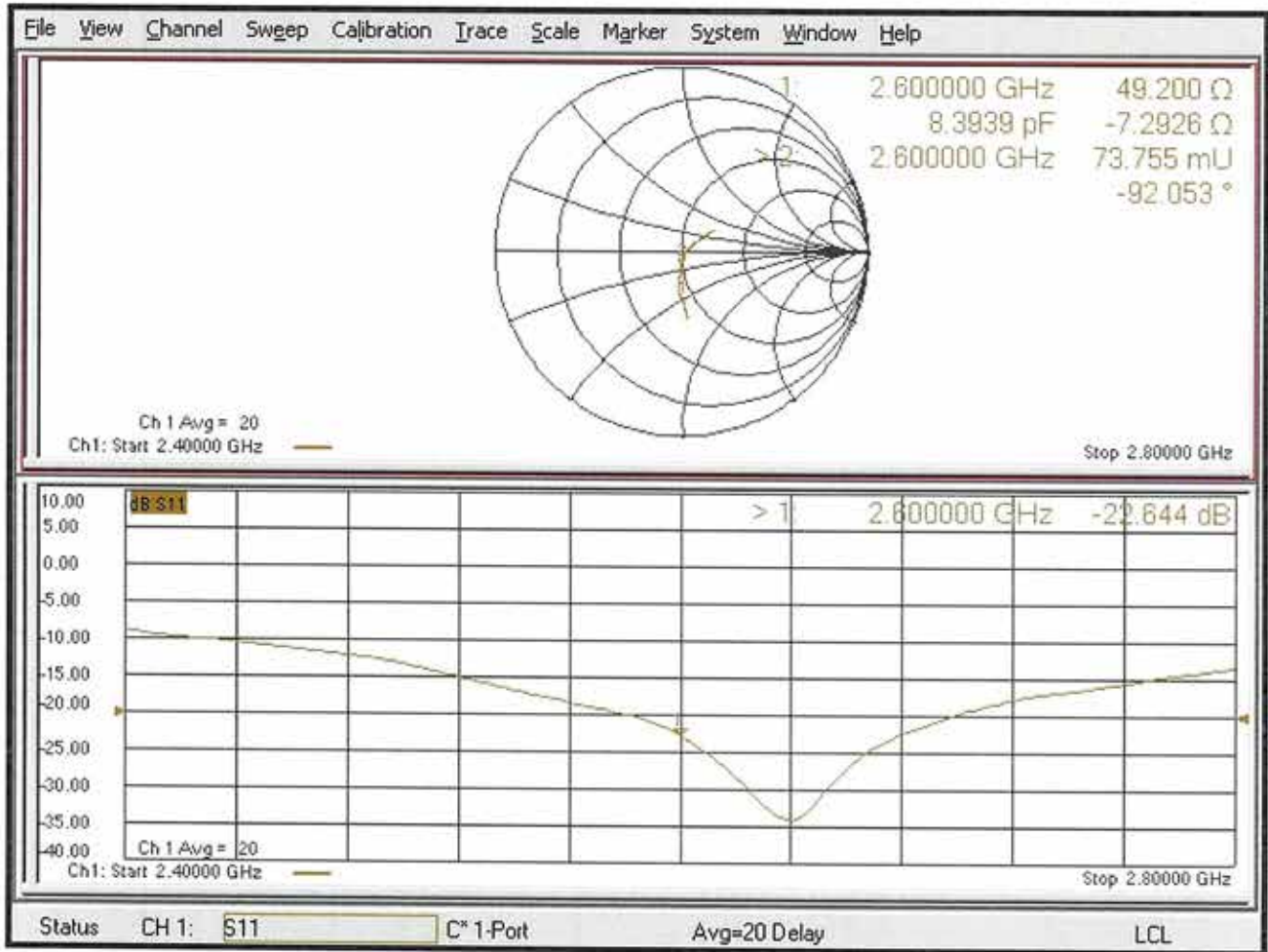



## D2600V2, serial no. 1078 Extended Dipole Calibrations

If dipoles are verified in return loss (<-20dB, within 20% of prior calibration), and in impedance (within 5 ohm of prior calibration), the annual calibration is not necessary and the calibration interval can be extended.

### <Justification of the extended calibration>

| D2600V2 – serial no. 1078   |                  |           |                      |             |                           |             |
|-----------------------------|------------------|-----------|----------------------|-------------|---------------------------|-------------|
| 2600MHZ                     |                  |           |                      |             |                           |             |
| Date of Measurement         | Return-Loss (dB) | Delta (%) | Real Impedance (ohm) | Delta (ohm) | Imaginary Impedance (ohm) | Delta (ohm) |
| 06.23.2022<br>(Cal. Report) | -22.644          |           | 49.200               |             | -7.2926                   |             |
| 06.22.2023<br>(extended)    | -22.964          | -1.41     | 53.527               | 4.327       | -8.0936                   | -0.801      |

The return loss is <-20dB, within 20% of prior calibration; the impedance is within 5 ohm of prior calibration. Therefore the verification result should support extended calibration.

<Dipole Verification Data> - D2600 V2, serial no. 1078(Data of Measurement : 06.22.2023)

2600MHz - Head

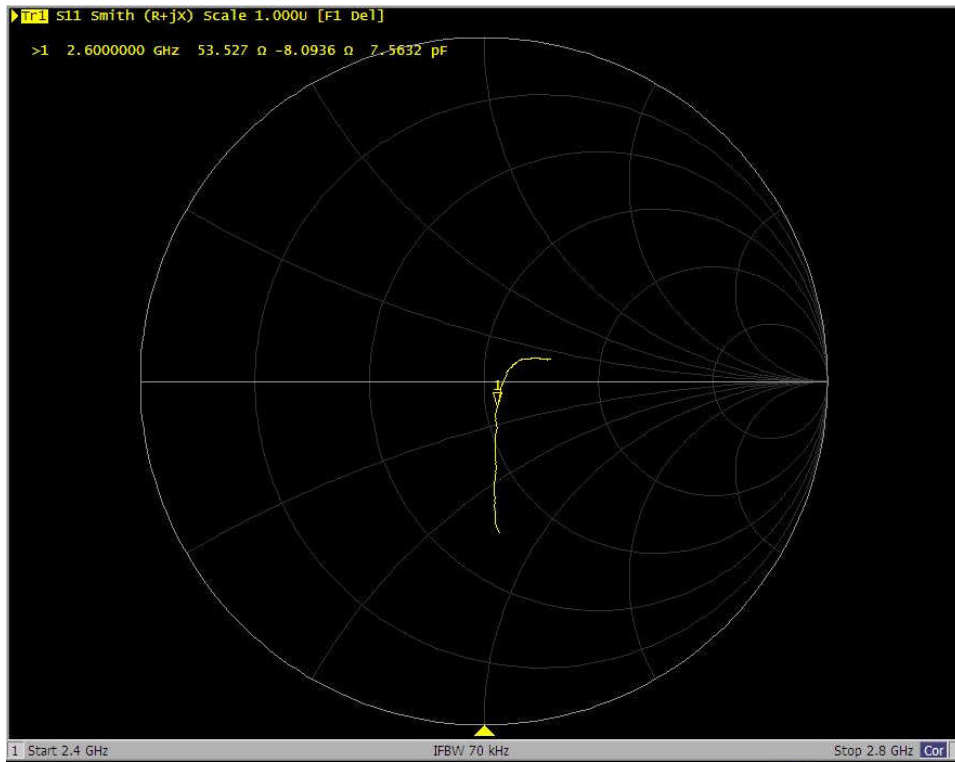
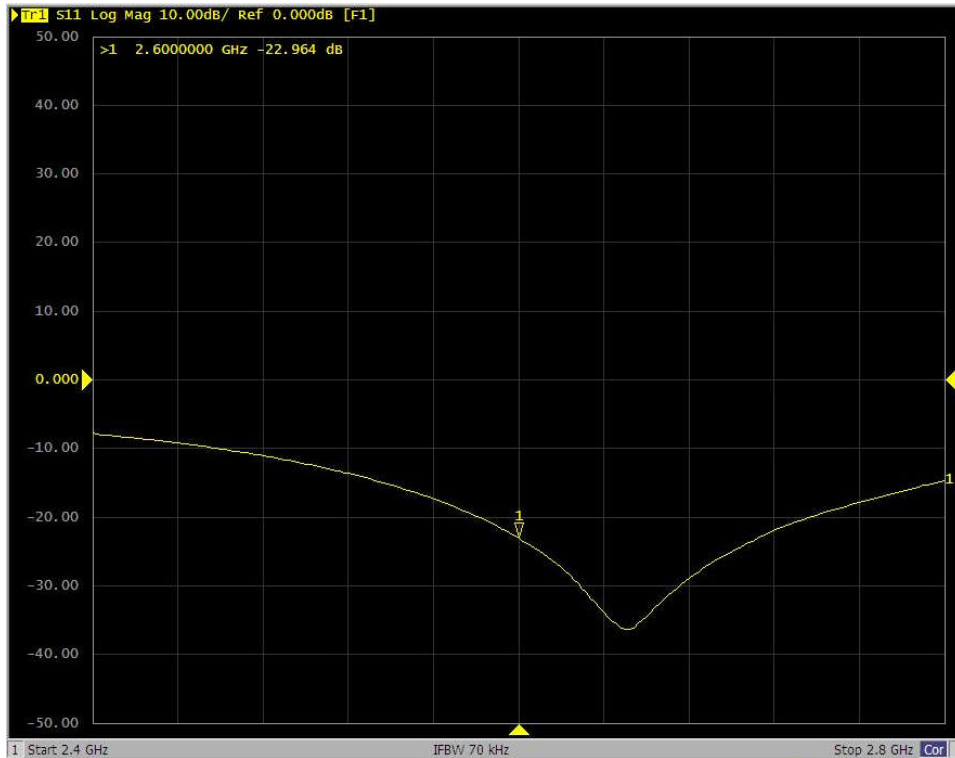



Accredited by the Swiss Accreditation Service (SAS)  
The Swiss Accreditation Service is one of the signatories to the EA  
Multilateral Agreement for the recognition of calibration certificates

Accreditation No.: **SCS 0108**

Client **Sporton**

Certificate No: **D3500V2-1014\_Jan22**

## CALIBRATION CERTIFICATE

Object **D3500V2 - SN:1014**

Calibration procedure(s) **QA CAL-22.v6  
Calibration Procedure for SAR Validation Sources between 3-10 GHz**

Calibration date: **January 17, 2022**

This calibration certificate documents the traceability to national standards, which realize the physical units of measurements (SI).  
The measurements and the uncertainties with confidence probability are given on the following pages and are part of the certificate.

All calibrations have been conducted in the closed laboratory facility: environment temperature (22 ± 3)°C and humidity < 70%.

Calibration Equipment used (M&TE critical for calibration)

| Primary Standards           | ID #               | Cal Date (Certificate No.)      | Scheduled Calibration |
|-----------------------------|--------------------|---------------------------------|-----------------------|
| Power meter NRP             | SN: 104778         | 09-Apr-21 (No. 217-03291/03292) | Apr-22                |
| Power sensor NRP-Z91        | SN: 103244         | 09-Apr-21 (No. 217-03291)       | Apr-22                |
| Power sensor NRP-Z91        | SN: 103245         | 09-Apr-21 (No. 217-03292)       | Apr-22                |
| Reference 20 dB Attenuator  | SN: BH9394 (20k)   | 09-Apr-21 (No. 217-03343)       | Apr-22                |
| Type-N mismatch combination | SN: 310982 / 06327 | 09-Apr-21 (No. 217-03344)       | Apr-22                |
| Reference Probe EX3DV4      | SN: 3503           | 31-Dec-21 (No. EX3-3503_Dec21)  | Dec-22                |
| DAE4                        | SN: 601            | 01-Nov-21 (No. DAE4-601_Nov21)  | Nov-22                |

| Secondary Standards             | ID #           | Check Date (in house)             | Scheduled Check        |
|---------------------------------|----------------|-----------------------------------|------------------------|
| Power meter E4419B              | SN: GB39512475 | 30-Oct-14 (in house check Oct-20) | In house check: Oct-22 |
| Power sensor HP 8481A           | SN: US37292783 | 07-Oct-15 (in house check Oct-20) | In house check: Oct-22 |
| Power sensor HP 8481A           | SN: MY41093315 | 07-Oct-15 (in house check Oct-20) | In house check: Oct-22 |
| RF generator R&S SMT-06         | SN: 100972     | 15-Jun-15 (in house check Oct-20) | In house check: Oct-22 |
| Network Analyzer Agilent E8358A | SN: US41080477 | 31-Mar-14 (in house check Oct-20) | In house check: Oct-22 |

|                |                              |                                   |               |
|----------------|------------------------------|-----------------------------------|---------------|
| Calibrated by: | Name<br><b>Michael Weber</b> | Function<br>Laboratory Technician | Signature<br> |
| Approved by:   | Name<br><b>Sven Kühn</b>     | Deputy Manager                    |               |

Issued: January 20, 2022

This calibration certificate shall not be reproduced except in full without written approval of the laboratory.



Accredited by the Swiss Accreditation Service (SAS)  
The Swiss Accreditation Service is one of the signatories to the EA  
Multilateral Agreement for the recognition of calibration certificates

Accreditation No.: **SCS 0108**

**Glossary:**

|       |                                 |
|-------|---------------------------------|
| TSL   | tissue simulating liquid        |
| ConvF | sensitivity in TSL / NORM x,y,z |
| N/A   | not applicable or not measured  |

**Calibration is Performed According to the Following Standards:**

- a) IEC/IEEE 62209-1528, "Measurement Procedure For The Assessment Of Specific Absorption Rate Of Human Exposure To Radio Frequency Fields From Hand-Held And Body-Worn Wireless Communication Devices - Part 1528: Human Models, Instrumentation And Procedures (Frequency Range of 4 MHz to 10 GHz)", October 2020.
- b) KDB 865664, "SAR Measurement Requirements for 100 MHz to 6 GHz"

**Additional Documentation:**

- c) DASY System Handbook

**Methods Applied and Interpretation of Parameters:**

- *Measurement Conditions:* Further details are available from the Validation Report at the end of the certificate. All figures stated in the certificate are valid at the frequency indicated.
- *Antenna Parameters with TSL:* The source is mounted in a touch configuration below the center marking of the flat phantom.
- *Return Loss:* This parameter is measured with the source positioned under the liquid filled phantom (as described in the measurement condition clause). The Return Loss ensures low reflected power. No uncertainty required.
- *SAR measured:* SAR measured at the stated antenna input power.
- *SAR normalized:* SAR as measured, normalized to an input power of 1 W at the antenna connector.
- *SAR for nominal TSL parameters:* The measured TSL parameters are used to calculate the nominal SAR result.

The reported uncertainty of measurement is stated as the standard uncertainty of measurement multiplied by the coverage factor  $k=2$ , which for a normal distribution corresponds to a coverage probability of approximately 95%.

## Measurement Conditions

DASY system configuration, as far as not given on page 1.

|                              |                            |                                  |
|------------------------------|----------------------------|----------------------------------|
| DASY Version                 | DASY52                     | V52.10.4                         |
| Extrapolation                | Advanced Extrapolation     |                                  |
| Phantom                      | Modular Flat Phantom       |                                  |
| Distance Dipole Center - TSL | 10 mm                      | with Spacer                      |
| Zoom Scan Resolution         | dx, dy = 4 mm, dz = 1.4 mm | Graded Ratio = 1.4 (Z direction) |
| Frequency                    | 3500 MHz $\pm$ 1 MHz       |                                  |

## Head TSL parameters

The following parameters and calculations were applied.

|   | Temperature         | Permittivity   | Conductivity         |
|---|---------------------|----------------|----------------------|
| Nominal Head TSL parameters             | 22.0 °C             | 37.9           | 2.91 mho/m           |
| Measured Head TSL parameters            | (22.0 $\pm$ 0.2) °C | 37.2 $\pm$ 6 % | 2.91 mho/m $\pm$ 6 % |
| Head TSL temperature change during test | < 0.5 °C            | ---            | ---                  |

## SAR result with Head TSL

| SAR averaged over 1 cm <sup>3</sup> (1 g) of Head TSL | Condition          |  |
|---|--------------------|--|
| SAR measured  | 100 mW input power | 6.75 W/kg                                      |
| SAR for nominal Head TSL parameters                   | normalized to 1W   | <b>67.2 W/kg <math>\pm</math> 19.9 % (k=2)</b> |

| SAR averaged over 10 cm <sup>3</sup> (10 g) of Head TSL | condition          |  |
|---|--------------------|--|
| SAR measured  | 100 mW input power | 2.52 W/kg                                      |
| SAR for nominal Head TSL parameters                     | normalized to 1W   | <b>25.1 W/kg <math>\pm</math> 19.5 % (k=2)</b> |



## Appendix (Additional assessments outside the scope of SCS 0108)

### Antenna Parameters with Head TSL

|                                      |                                |
|--------------------------------------|--------------------------------|
| Impedance, transformed to feed point | 54.7 $\Omega$ - 4.4 j $\Omega$ |
| Return Loss                          | - 24.2 dB                      |

### General Antenna Parameters and Design

|                                  |          |
|----------------------------------|----------|
| Electrical Delay (one direction) | 1.133 ns |
|----------------------------------|----------|

After long term use with 100W radiated power, only a slight warming of the dipole near the feedpoint can be measured.

The dipole is made of standard semirigid coaxial cable. The center conductor of the feeding line is directly connected to the second arm of the dipole. The antenna is therefore short-circuited for DC-signals. On some of the dipoles, small end caps are added to the dipole arms in order to improve matching when loaded according to the position as explained in the "Measurement Conditions" paragraph. The SAR data are not affected by this change. The overall dipole length is still according to the Standard.

No excessive force must be applied to the dipole arms, because they might bend or the soldered connections near the feedpoint may be damaged.

### Additional EUT Data

|                 |       |
|-----------------|-------|
| Manufactured by | SPEAG |
|-----------------|-------|

## DASY5 Validation Report for Head TSL

Date: 17.01.2022

Test Laboratory: SPEAG, Zurich, Switzerland

**DUT: Dipole 3500 MHz; Type: D3500V2; Serial: D3500V2 - SN:1014**

Communication System: UID 0 - CW; Frequency: 3500 MHz

Medium parameters used:  $f = 3500$  MHz;  $\sigma = 2.91$  S/m;  $\epsilon_r = 37.2$ ;  $\rho = 1000$  kg/m<sup>3</sup>

Phantom section: Flat Section

Measurement Standard: DASY5 (IEEE/IEC/ANSI C63.19-2011)

DASY52 Configuration:

- Probe: EX3DV4 - SN3503; ConvF(7.91, 7.91, 7.91) @ 3500 MHz; Calibrated: 31.12.2021
- Sensor-Surface: 1.4mm (Mechanical Surface Detection)
- Electronics: DAE4 Sn601; Calibrated: 01.11.2021
- Phantom: Flat Phantom 5.0 (front); Type: QD 000 P50 AA; Serial: 1001
- DASY52 52.10.4(1535); SEMCAD X 14.6.14(7501)

**Dipole Calibration for Head Tissue/Pin=100 mW, d=10mm, f=3500MHz/Zoom Scan, dist=1.4mm (8x8x8)/Cube 0:** Measurement grid: dx=4mm, dy=4mm, dz=1.4mm

Reference Value = 69.66 V/m; Power Drift = 0.09 dB

Peak SAR (extrapolated) = 18.5 W/kg

**SAR(1 g) = 6.75 W/kg; SAR(10 g) = 2.52 W/kg**

Smallest distance from peaks to all points 3 dB below = 8.4 mm

Ratio of SAR at M2 to SAR at M1 = 74.5%

Maximum value of SAR (measured) = 13.0 W/kg



0 dB = 13.0 W/kg = 11.12 dBW/kg

# Impedance Measurement Plot for Head TSL

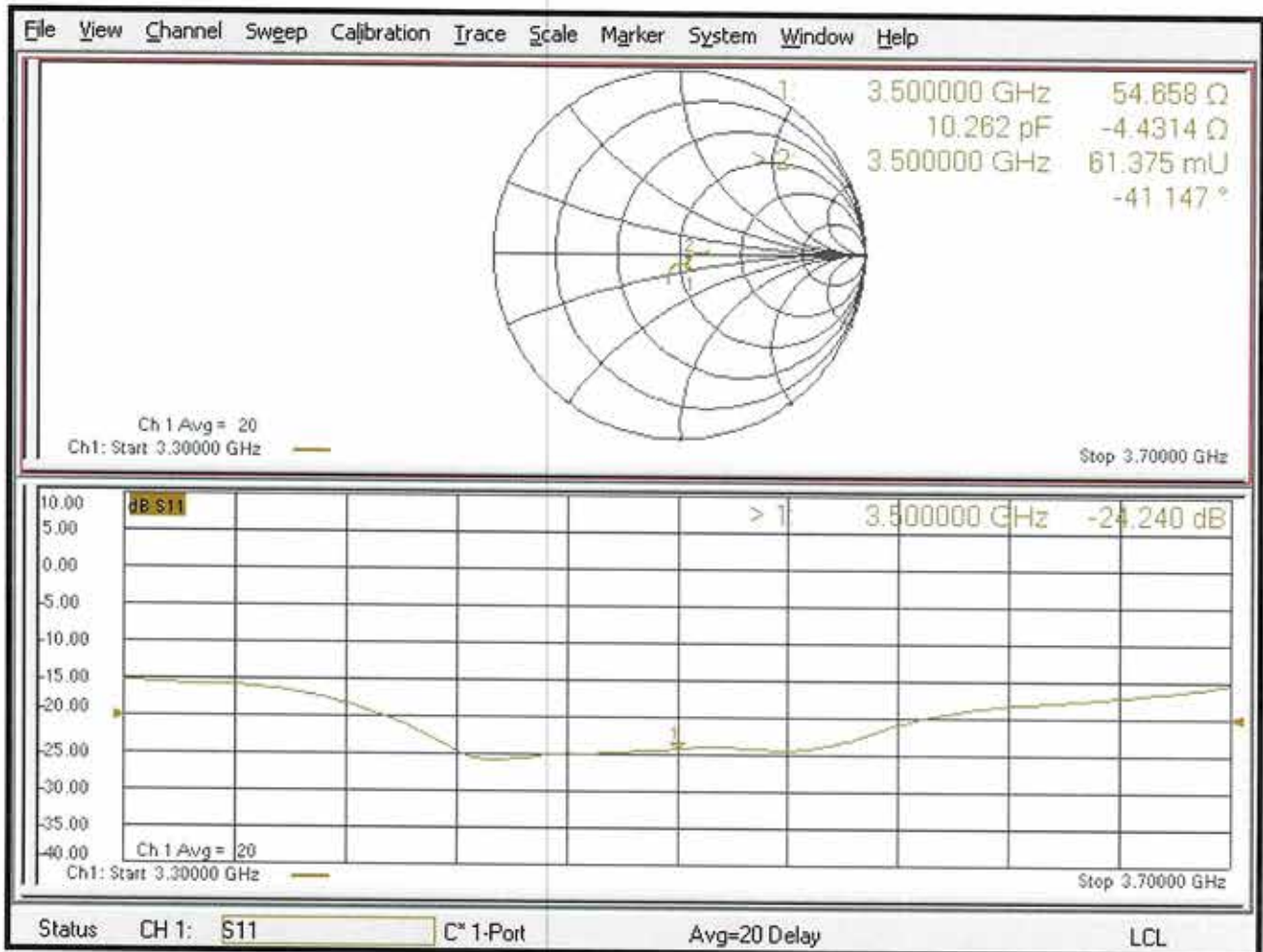



## D3500V2, serial no. 1014 Extended Dipole Calibrations

If dipoles are verified in return loss (<-20dB, within 20% of prior calibration), and in impedance (within 5 ohm of prior calibration), the annual calibration is not necessary and the calibration interval can be extended.

### <Justification of the extended calibration>

| D3500V2 – serial no. 1014   |                  |           |                      |             |                           |             |
|-----------------------------|------------------|-----------|----------------------|-------------|---------------------------|-------------|
| 3500MHZ                     |                  |           |                      |             |                           |             |
| Date of Measurement         | Return-Loss (dB) | Delta (%) | Real Impedance (ohm) | Delta (ohm) | Imaginary Impedance (ohm) | Delta (ohm) |
| 01.17.2022<br>(Cal. Report) | -24.24           |           | 54.658               |             | -4.4314                   |             |
| 01.16.2023<br>(extended)    | -25.446          | 4.739     | 53.693               | -0.965      | -1.2395                   | 3.1919      |

The return loss is <-20dB, within 20% of prior calibration; the impedance is within 5 ohm of prior calibration. Therefore the verification result should support extended calibration.

<Dipole Verification Data> - D3500 V2, serial no.1014 (Data of Measurement : 01.16.2023)

3500MHz - Head

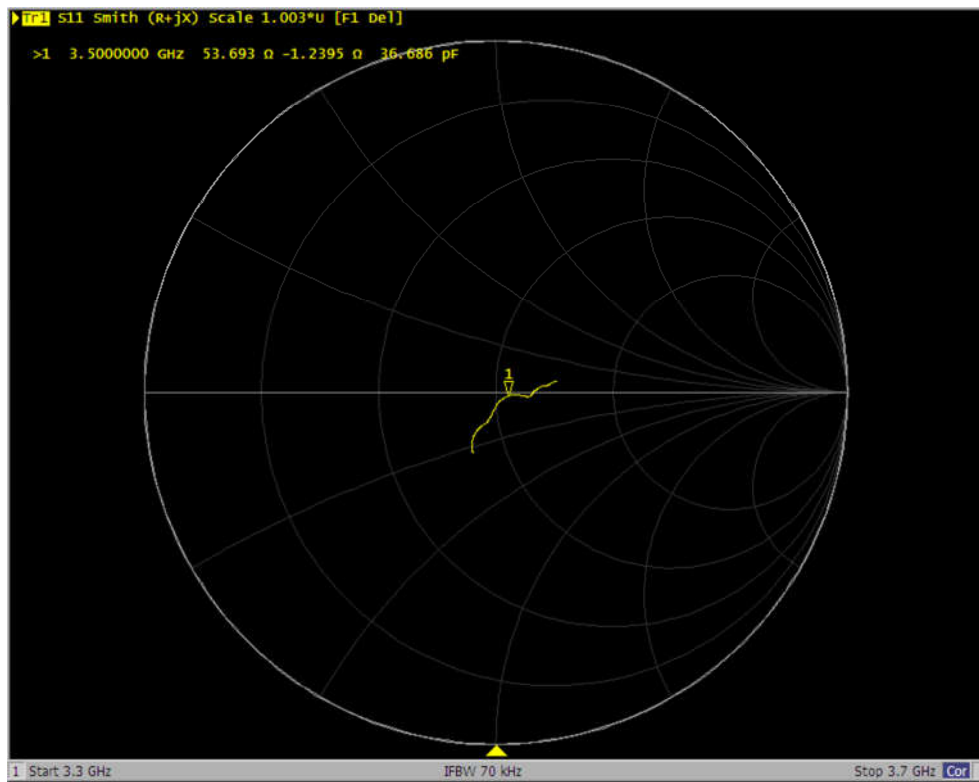
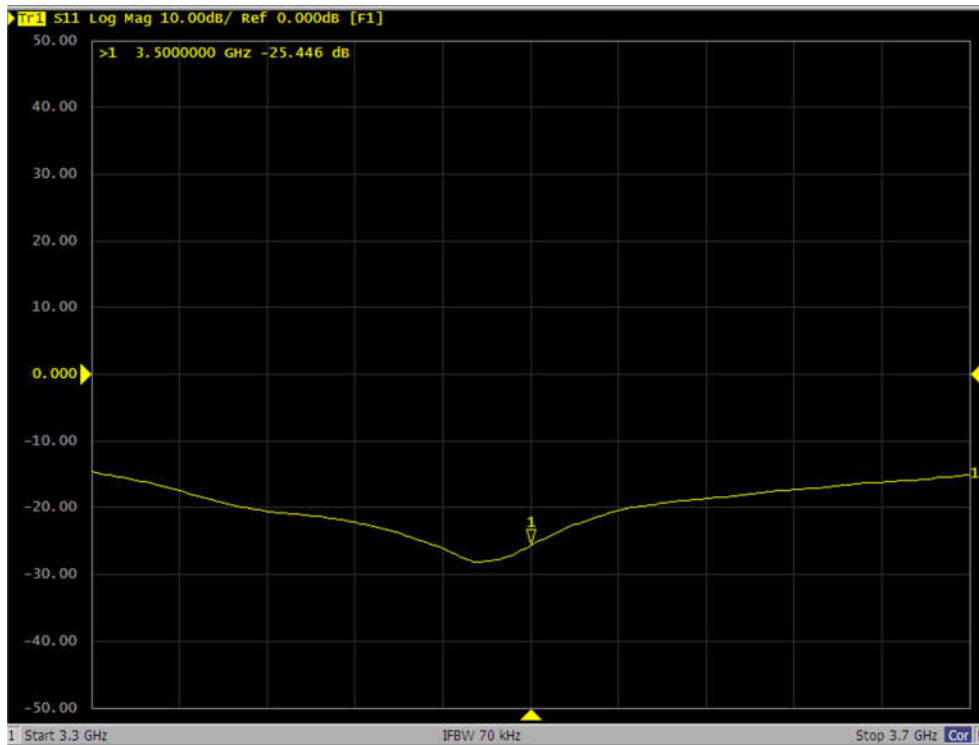



Accredited by the Swiss Accreditation Service (SAS)  
The Swiss Accreditation Service is one of the signatories to the EA  
Multilateral Agreement for the recognition of calibration certificates

Accreditation No.: **SCS 0108**

Client **Sporton**

Certificate No: **D3500V2-1036\_Mar22**

## CALIBRATION CERTIFICATE

Object **D3500V2 - SN:1036**

Calibration procedure(s) **QA CAL-22.v6  
Calibration Procedure for SAR Validation Sources between 3-10 GHz**

Calibration date: **March 23, 2022**

This calibration certificate documents the traceability to national standards, which realize the physical units of measurements (SI).  
The measurements and the uncertainties with confidence probability are given on the following pages and are part of the certificate.

All calibrations have been conducted in the closed laboratory facility: environment temperature ( $22 \pm 3$ )°C and humidity < 70%.

Calibration Equipment used (M&TE critical for calibration)

| Primary Standards               | ID #               | Cal Date (Certificate No.)        | Scheduled Calibration  |
|---------------------------------|--------------------|-----------------------------------|------------------------|
| Power meter NRP                 | SN: 104778         | 09-Apr-21 (No. 217-03291/03292)   | Apr-22                 |
| Power sensor NRP-Z91            | SN: 103244         | 09-Apr-21 (No. 217-03291)         | Apr-22                 |
| Power sensor NRP-Z91            | SN: 103245         | 09-Apr-21 (No. 217-03292)         | Apr-22                 |
| Reference 20 dB Attenuator      | SN: BH9394 (20k)   | 09-Apr-21 (No. 217-03343)         | Apr-22                 |
| Type-N mismatch combination     | SN: 310982 / 06327 | 09-Apr-21 (No. 217-03344)         | Apr-22                 |
| Reference Probe EX3DV4          | SN: 3503           | 08-Mar-22 (No. EX3-3503_Mar22)    | Mar-23                 |
| DAE4                            | SN: 601            | 01-Nov-21 (No. DAE4-601_Nov21)    | Nov-22                 |
| Secondary Standards             | ID #               | Check Date (in house)             | Scheduled Check        |
| Power meter E4419B              | SN: GB39512475     | 30-Oct-14 (in house check Oct-20) | In house check: Oct-22 |
| Power sensor HP 8481A           | SN: US37292783     | 07-Oct-15 (in house check Oct-20) | In house check: Oct-22 |
| Power sensor HP 8481A           | SN: MY41093315     | 07-Oct-15 (in house check Oct-20) | In house check: Oct-22 |
| RF generator R&S SMT-06         | SN: 100972         | 15-Jun-15 (in house check Oct-20) | In house check: Oct-22 |
| Network Analyzer Agilent E8358A | SN: US41080477     | 31-Mar-14 (in house check Oct-20) | In house check: Oct-22 |

Calibrated by: **Michael Weber**      Name: Michael Weber      Function: Laboratory Technician

Approved by: **Sven Kühn**      Name: Sven Kühn      Function: Deputy Manager

Signature

Issued: March 28, 2022

This calibration certificate shall not be reproduced except in full without written approval of the laboratory.



Accredited by the Swiss Accreditation Service (SAS)  
The Swiss Accreditation Service is one of the signatories to the EA  
Multilateral Agreement for the recognition of calibration certificates

Accreditation No.: **SCS 0108**

**Glossary:**

|       |                                 |
|-------|---------------------------------|
| TSL   | tissue simulating liquid        |
| ConvF | sensitivity in TSL / NORM x,y,z |
| N/A   | not applicable or not measured  |

**Calibration is Performed According to the Following Standards:**

- IEC/IEEE 62209-1528, "Measurement Procedure For The Assessment Of Specific Absorption Rate Of Human Exposure To Radio Frequency Fields From Hand-Held And Body-Worn Wireless Communication Devices - Part 1528: Human Models, Instrumentation And Procedures (Frequency Range of 4 MHz to 10 GHz)", October 2020.
- KDB 865664, "SAR Measurement Requirements for 100 MHz to 6 GHz"

**Additional Documentation:**

- DASY System Handbook

**Methods Applied and Interpretation of Parameters:**

- Measurement Conditions:* Further details are available from the Validation Report at the end of the certificate. All figures stated in the certificate are valid at the frequency indicated.
- Antenna Parameters with TSL:* The source is mounted in a touch configuration below the center marking of the flat phantom.
- Return Loss:* This parameter is measured with the source positioned under the liquid filled phantom (as described in the measurement condition clause). The Return Loss ensures low reflected power. No uncertainty required.
- SAR measured:* SAR measured at the stated antenna input power.
- SAR normalized:* SAR as measured, normalized to an input power of 1 W at the antenna connector.
- SAR for nominal TSL parameters:* The measured TSL parameters are used to calculate the nominal SAR result.

The reported uncertainty of measurement is stated as the standard uncertainty of measurement multiplied by the coverage factor  $k=2$ , which for a normal distribution corresponds to a coverage probability of approximately 95%.

## Measurement Conditions

DASY system configuration, as far as not given on page 1.

|                              |                            |                                  |
|------------------------------|----------------------------|----------------------------------|
| DASY Version                 | DASY52                     | V52.10.4                         |
| Extrapolation                | Advanced Extrapolation     |                                  |
| Phantom                      | Modular Flat Phantom       |                                  |
| Distance Dipole Center - TSL | 10 mm                      | with Spacer                      |
| Zoom Scan Resolution         | dx, dy = 4 mm, dz = 1.4 mm | Graded Ratio = 1.4 (Z direction) |
| Frequency                    | 3500 MHz $\pm$ 1 MHz       |                                  |

## Head TSL parameters

The following parameters and calculations were applied.

|   | Temperature         | Permittivity   | Conductivity         |
|---|---------------------|----------------|----------------------|
| Nominal Head TSL parameters             | 22.0 °C             | 37.9           | 2.91 mho/m           |
| Measured Head TSL parameters            | (22.0 $\pm$ 0.2) °C | 37.4 $\pm$ 6 % | 2.94 mho/m $\pm$ 6 % |
| Head TSL temperature change during test | < 0.5 °C            | ----           | ----                 |

## SAR result with Head TSL

| SAR averaged over 1 cm <sup>3</sup> (1 g) of Head TSL | Condition          |  |
|---|--------------------|--|
| SAR measured  | 100 mW input power | 6.78 W/kg                                      |
| SAR for nominal Head TSL parameters                   | normalized to 1W   | <b>67.4 W/kg <math>\pm</math> 19.9 % (k=2)</b> |

| SAR averaged over 10 cm <sup>3</sup> (10 g) of Head TSL | condition          |  |
|---|--------------------|--|
| SAR measured  | 100 mW input power | 2.52 W/kg                                      |
| SAR for nominal Head TSL parameters                     | normalized to 1W   | <b>25.1 W/kg <math>\pm</math> 19.5 % (k=2)</b> |



## Appendix (Additional assessments outside the scope of SCS 0108)

### Antenna Parameters with Head TSL

|                                      |                                |
|--------------------------------------|--------------------------------|
| Impedance, transformed to feed point | 52.3 $\Omega$ - 1.8 j $\Omega$ |
| Return Loss                          | - 30.9 dB                      |

### General Antenna Parameters and Design

|                                  |          |
|----------------------------------|----------|
| Electrical Delay (one direction) | 1.140 ns |
|----------------------------------|----------|

After long term use with 100W radiated power, only a slight warming of the dipole near the feedpoint can be measured.

The dipole is made of standard semirigid coaxial cable. The center conductor of the feeding line is directly connected to the second arm of the dipole. The antenna is therefore short-circuited for DC-signals. On some of the dipoles, small end caps are added to the dipole arms in order to improve matching when loaded according to the position as explained in the "Measurement Conditions" paragraph. The SAR data are not affected by this change. The overall dipole length is still according to the Standard.

No excessive force must be applied to the dipole arms, because they might bend or the soldered connections near the feedpoint may be damaged.

### Additional EUT Data

|                 |       |
|-----------------|-------|
| Manufactured by | SPEAG |
|-----------------|-------|