

Measurement Conditions

DASY system configuration, as far as not given on page 1.

| | | |
|------------------------------|----------------------------|----------------------------------|
| DASY Version | DASY52 | V52.10.4 |
| Extrapolation | Advanced Extrapolation | |
| Phantom | Modular Flat Phantom | |
| Distance Dipole Center - TSL | 10 mm | with Spacer |
| Zoom Scan Resolution | dx, dy = 4 mm, dz = 1.4 mm | Graded Ratio = 1.4 (Z direction) |
| Frequency | 3500 MHz \pm 1 MHz | |

Head TSL parameters

The following parameters and calculations were applied.

| | Temperature | Permittivity | Conductivity |
|---|---------------------|----------------|----------------------|
| Nominal Head TSL parameters | 22.0 °C | 37.9 | 2.91 mho/m |
| Measured Head TSL parameters | (22.0 \pm 0.2) °C | 37.4 \pm 6 % | 2.94 mho/m \pm 6 % |
| Head TSL temperature change during test | < 0.5 °C | ---- | ---- |

SAR result with Head TSL

| SAR averaged over 1 cm ³ (1 g) of Head TSL | Condition | |
|---|--------------------|--|
| SAR measured | 100 mW input power | 6.78 W/kg |
| SAR for nominal Head TSL parameters | normalized to 1W | 67.4 W/kg \pm 19.9 % (k=2) |

| SAR averaged over 10 cm ³ (10 g) of Head TSL | condition | |
|---|--------------------|--|
| SAR measured | 100 mW input power | 2.52 W/kg |
| SAR for nominal Head TSL parameters | normalized to 1W | 25.1 W/kg \pm 19.5 % (k=2) |

Appendix (Additional assessments outside the scope of SCS 0108)

Antenna Parameters with Head TSL

| | |
|--------------------------------------|--------------------------------|
| Impedance, transformed to feed point | 52.3 Ω - 1.8 j Ω |
| Return Loss | - 30.9 dB |

General Antenna Parameters and Design

| | |
|----------------------------------|----------|
| Electrical Delay (one direction) | 1.140 ns |
|----------------------------------|----------|

After long term use with 100W radiated power, only a slight warming of the dipole near the feedpoint can be measured.

The dipole is made of standard semirigid coaxial cable. The center conductor of the feeding line is directly connected to the second arm of the dipole. The antenna is therefore short-circuited for DC-signals. On some of the dipoles, small end caps are added to the dipole arms in order to improve matching when loaded according to the position as explained in the "Measurement Conditions" paragraph. The SAR data are not affected by this change. The overall dipole length is still according to the Standard.

No excessive force must be applied to the dipole arms, because they might bend or the soldered connections near the feedpoint may be damaged.

Additional EUT Data

| | |
|-----------------|-------|
| Manufactured by | SPEAG |
|-----------------|-------|

DASY5 Validation Report for Head TSL

Date: 23.03.2022

Test Laboratory: SPEAG, Zurich, Switzerland

DUT: Dipole 3500 MHz; Type: D3500V2; Serial: D3500V2 - SN:1036

Communication System: UID 0 - CW; Frequency: 3500 MHz

Medium parameters used: $f = 3500$ MHz; $\sigma = 2.94$ S/m; $\epsilon_r = 37.4$; $\rho = 1000$ kg/m³

Phantom section: Flat Section

Measurement Standard: DASY5 (IEEE/IEC/ANSI C63.19-2011)

DASY52 Configuration:

- Probe: EX3DV4 - SN3503; ConvF(7.91, 7.91, 7.91) @ 3500 MHz; Calibrated: 08.03.2022
- Sensor-Surface: 1.4mm (Mechanical Surface Detection)
- Electronics: DAE4 Sn601; Calibrated: 01.11.2021
- Phantom: Flat Phantom 5.0 (front); Type: QD 000 P50 AA; Serial: 1001
- DASY52 52.10.4(1535); SEMCAD X 14.6.14(7501)

Dipole Calibration for Head Tissue/Pin=100 mW, d=10mm, f=3500MHz/Zoom Scan,

dist=1.4mm (8x8x8)/Cube 0: Measurement grid: dx=4mm, dy=4mm, dz=1.4mm

Reference Value = 72.91 V/m; Power Drift = 0.06 dB

Peak SAR (extrapolated) = 18.5 W/kg

SAR(1 g) = 6.78 W/kg; SAR(10 g) = 2.52 W/kg

Smallest distance from peaks to all points 3 dB below = 8 mm

Ratio of SAR at M2 to SAR at M1 = 74.5%

Maximum value of SAR (measured) = 12.9 W/kg

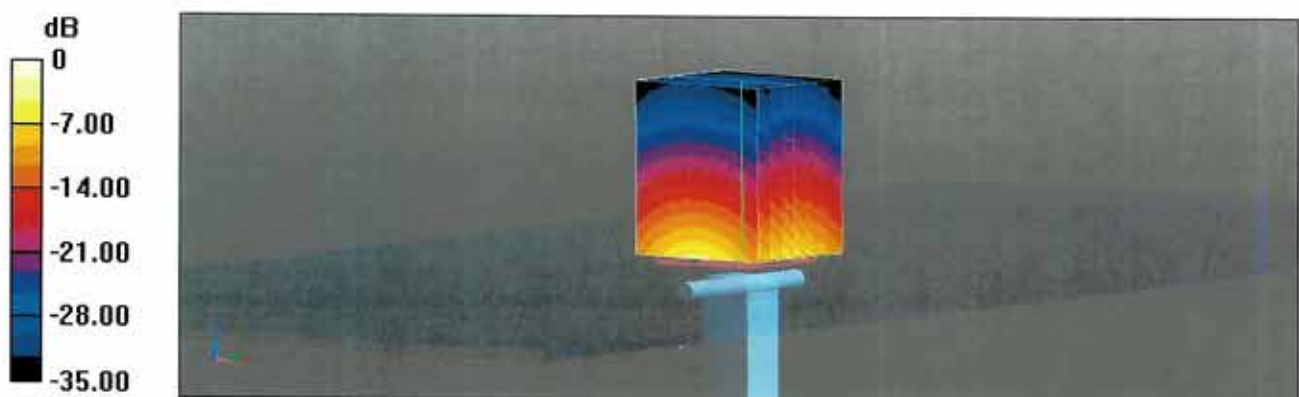

Impedance Measurement Plot for Head TSL

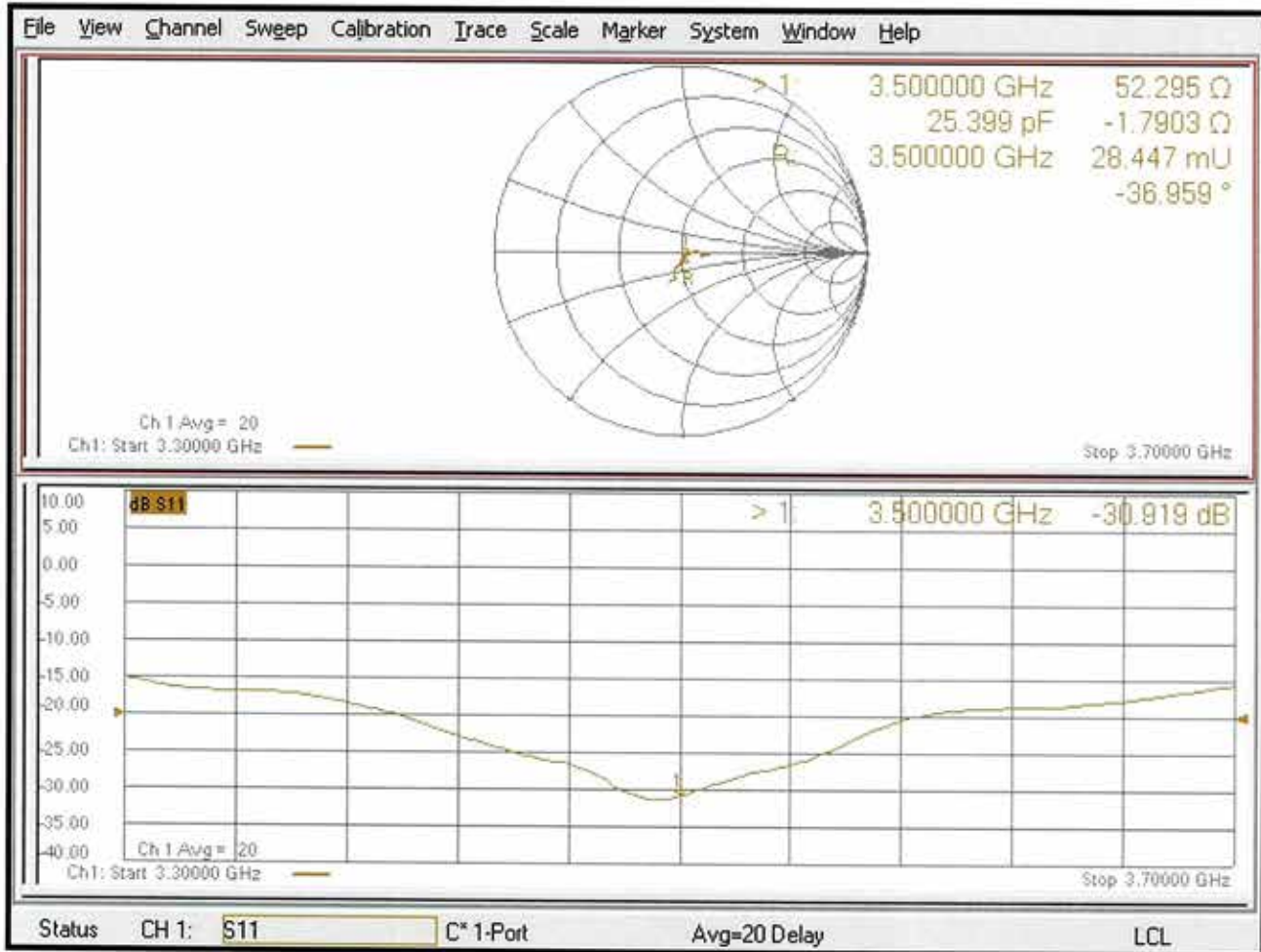



D3500V2, serial no. 1036 Extended Dipole Calibrations

If dipoles are verified in return loss (<-20dB, within 20% of prior calibration), and in impedance (within 5 ohm of prior calibration), the annual calibration is not necessary and the calibration interval can be extended.

<Justification of the extended calibration>

| D3500V2 – serial no. 1036 | | | | | | |
|-----------------------------|------------------|-----------|----------------------|-------------|---------------------------|-------------|
| 3500MHZ | | | | | | |
| Date of Measurement | Return-Loss (dB) | Delta (%) | Real Impedance (ohm) | Delta (ohm) | Imaginary Impedance (ohm) | Delta (ohm) |
| 03.23.2022 (Cal. Report) | -30.919 | | 52.295 | | -1.7903 | |
| 03.22.2023 (extended) | -30.444 | -1.53 | 52.726 | 0.431 | -2.9057 | -1.1154 |

The return loss is <-20dB, within 20% of prior calibration; the impedance is within 5 ohm of prior calibration. Therefore the verification result should support extended calibration.



<Dipole Verification Data> - D3500 V2, serial no. 1036 (Data of Measurement : 03.22.2023)

3500 MHz - Head

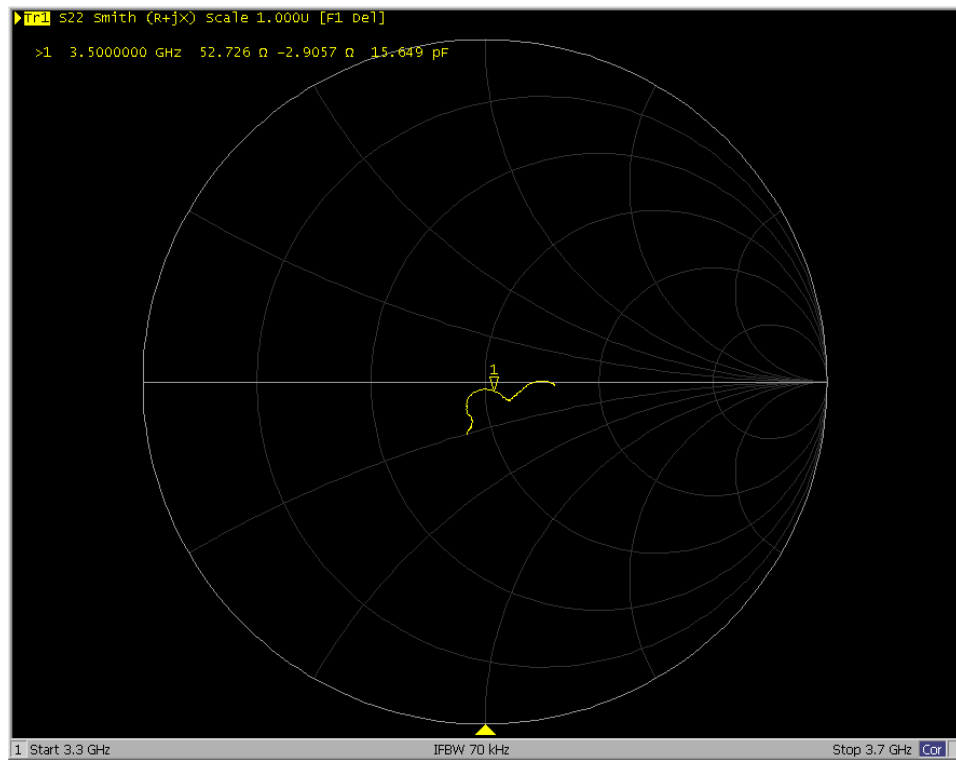
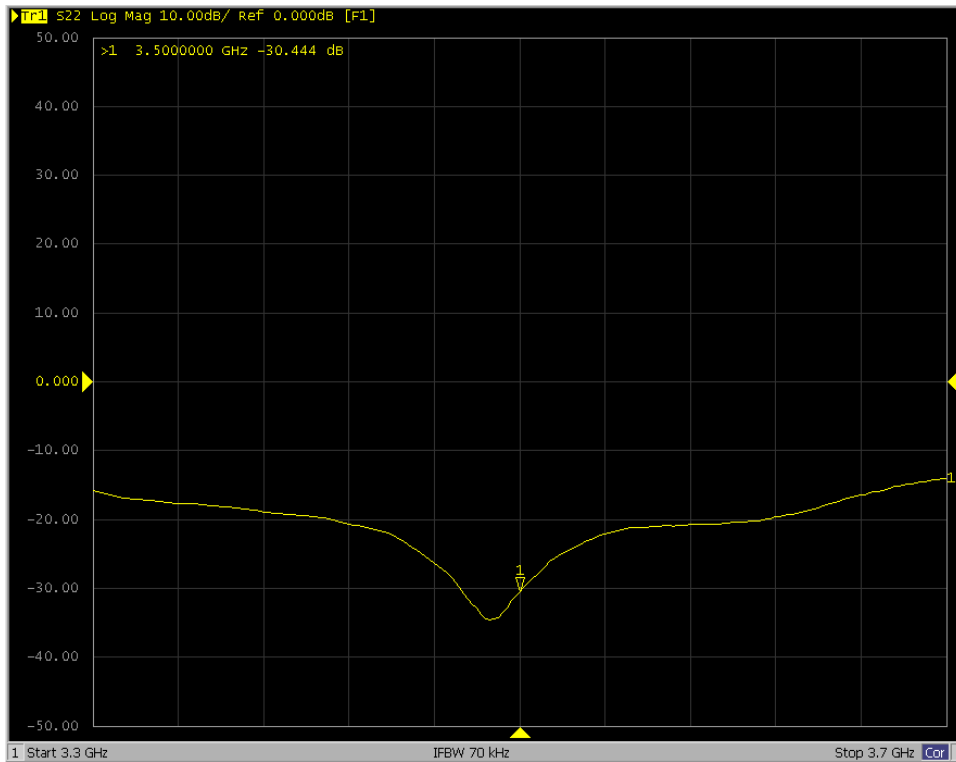



Accredited by the Swiss Accreditation Service (SAS)
The Swiss Accreditation Service is one of the signatories to the EA
Multilateral Agreement for the recognition of calibration certificates

Accreditation No.: **SCS 0108**

Client **Sporton**

Certificate No: **D3700V2-1006_Jun22**

CALIBRATION CERTIFICATE

Object **D3700V2 - SN:1006**

Calibration procedure(s) **QA CAL-22.v6
Calibration Procedure for SAR Validation Sources between 3-10 GHz**

Calibration date: **June 20, 2022**

This calibration certificate documents the traceability to national standards, which realize the physical units of measurements (SI).
The measurements and the uncertainties with confidence probability are given on the following pages and are part of the certificate.

All calibrations have been conducted in the closed laboratory facility: environment temperature (22 ± 3)°C and humidity < 70%.

Calibration Equipment used (M&TE critical for calibration)

| Primary Standards | ID # | Cal Date (Certificate No.) | Scheduled Calibration |
|-----------------------------|--------------------|---------------------------------|-----------------------|
| Power meter NRP | SN: 104778 | 04-Apr-22 (No. 217-03525/03524) | Apr-23 |
| Power sensor NRP-Z91 | SN: 103244 | 04-Apr-22 (No. 217-03524) | Apr-23 |
| Power sensor NRP-Z91 | SN: 103245 | 04-Apr-22 (No. 217-03525) | Apr-23 |
| Reference 20 dB Attenuator | SN: BH9394 (20k) | 04-Apr-22 (No. 217-03527) | Apr-23 |
| Type-N mismatch combination | SN: 310982 / 06327 | 04-Apr-22 (No. 217-03528) | Apr-23 |
| Reference Probe EX3DV4 | SN: 3503 | 08-Mar-22 (No. EX3-3503_Mar22) | Mar-23 |
| DAE4 | SN: 601 | 02-May-22 (No. DAE4-601_May22) | May-23 |

| Secondary Standards | ID # | Check Date (in house) | Scheduled Check |
|---------------------------------|----------------|-----------------------------------|------------------------|
| Power meter E4419B | SN: GB39512475 | 30-Oct-14 (in house check Oct-20) | In house check: Oct-22 |
| Power sensor HP 8481A | SN: US37292783 | 07-Oct-15 (in house check Oct-20) | In house check: Oct-22 |
| Power sensor HP 8481A | SN: MY41093315 | 07-Oct-15 (in house check Oct-20) | In house check: Oct-22 |
| RF generator R&S SMT-06 | SN: 100972 | 15-Jun-15 (in house check Oct-20) | In house check: Oct-22 |
| Network Analyzer Agilent E8358A | SN: US41080477 | 31-Mar-14 (in house check Oct-20) | In house check: Oct-22 |

| | | | |
|----------------|--------------------------------|--|---------------|
| Calibrated by: | Name Jeffrey Katzman | Function Laboratory Technician | Signature |
| Approved by: | Name Sven Kühn | Technical Manager | |

Issued: June 27, 2022

This calibration certificate shall not be reproduced except in full without written approval of the laboratory.



Accredited by the Swiss Accreditation Service (SAS)
The Swiss Accreditation Service is one of the signatories to the EA
Multilateral Agreement for the recognition of calibration certificates

Accreditation No.: **SCS 0108**

Glossary:

| | |
|-------|---------------------------------|
| TSL | tissue simulating liquid |
| ConvF | sensitivity in TSL / NORM x,y,z |
| N/A | not applicable or not measured |

Calibration is Performed According to the Following Standards:

- IEC/IEEE 62209-1528, "Measurement Procedure For The Assessment Of Specific Absorption Rate Of Human Exposure To Radio Frequency Fields From Hand-Held And Body-Worn Wireless Communication Devices - Part 1528: Human Models, Instrumentation And Procedures (Frequency Range of 4 MHz to 10 GHz)", October 2020.
- KDB 865664, "SAR Measurement Requirements for 100 MHz to 6 GHz"

Additional Documentation:

- DASY System Handbook

Methods Applied and Interpretation of Parameters:

- Measurement Conditions:** Further details are available from the Validation Report at the end of the certificate. All figures stated in the certificate are valid at the frequency indicated.
- Antenna Parameters with TSL:** The source is mounted in a touch configuration below the center marking of the flat phantom.
- Return Loss:** This parameter is measured with the source positioned under the liquid filled phantom (as described in the measurement condition clause). The Return Loss ensures low reflected power. No uncertainty required.
- SAR measured:** SAR measured at the stated antenna input power.
- SAR normalized:** SAR as measured, normalized to an input power of 1 W at the antenna connector.
- SAR for nominal TSL parameters:** The measured TSL parameters are used to calculate the nominal SAR result.

The reported uncertainty of measurement is stated as the standard uncertainty of measurement multiplied by the coverage factor $k=2$, which for a normal distribution corresponds to a coverage probability of approximately 95%.

Measurement Conditions

DASY system configuration, as far as not given on page 1.

| | | |
|------------------------------|----------------------------|----------------------------------|
| DASY Version | DASY52 | V52.10.4 |
| Extrapolation | Advanced Extrapolation | |
| Phantom | Modular Flat Phantom | |
| Distance Dipole Center - TSL | 10 mm | with Spacer |
| Zoom Scan Resolution | dx, dy = 4 mm, dz = 1.4 mm | Graded Ratio = 1.4 (Z direction) |
| Frequency | 3700 MHz \pm 1 MHz | |

Head TSL parameters

The following parameters and calculations were applied.

| | Temperature | Permittivity | Conductivity |
|---|---------------------|----------------|----------------------|
| Nominal Head TSL parameters | 22.0 °C | 37.7 | 3.12 mho/m |
| Measured Head TSL parameters | (22.0 \pm 0.2) °C | 37.0 \pm 6 % | 3.07 mho/m \pm 6 % |
| Head TSL temperature change during test | < 0.5 °C | ---- | ---- |

SAR result with Head TSL

| SAR averaged over 1 cm ³ (1 g) of Head TSL | Condition | |
|---|--------------------|--|
| SAR measured | 100 mW input power | 6.56 W/kg |
| SAR for nominal Head TSL parameters | normalized to 1W | 65.6 W/kg \pm 19.9 % (k=2) |

| SAR averaged over 10 cm ³ (10 g) of Head TSL | condition | |
|---|--------------------|--|
| SAR measured | 100 mW input power | 2.38 W/kg |
| SAR for nominal Head TSL parameters | normalized to 1W | 23.7 W/kg \pm 19.5 % (k=2) |

Appendix (Additional assessments outside the scope of SCS 0108)

Antenna Parameters with Head TSL

| | |
|--------------------------------------|---------------------------------|
| Impedance, transformed to feed point | 50.6 Ω - 10.0 j Ω |
| Return Loss | - 20.0 dB |

General Antenna Parameters and Design

| | |
|----------------------------------|----------|
| Electrical Delay (one direction) | 1.137 ns |
|----------------------------------|----------|

After long term use with 100W radiated power, only a slight warming of the dipole near the feedpoint can be measured.

The dipole is made of standard semirigid coaxial cable. The center conductor of the feeding line is directly connected to the second arm of the dipole. The antenna is therefore short-circuited for DC-signals. On some of the dipoles, small end caps are added to the dipole arms in order to improve matching when loaded according to the position as explained in the "Measurement Conditions" paragraph. The SAR data are not affected by this change. The overall dipole length is still according to the Standard.

No excessive force must be applied to the dipole arms, because they might bend or the soldered connections near the feedpoint may be damaged.

Additional EUT Data

| | |
|-----------------|-------|
| Manufactured by | SPEAG |
|-----------------|-------|

DASY5 Validation Report for Head TSL

Date: 20.06.2022

Test Laboratory: SPEAG, Zurich, Switzerland

DUT: Dipole 3700 MHz; Type: D3700V2; Serial: D3700V2 - SN:1006

Communication System: UID 0 - CW; Frequency: 3700 MHz

Medium parameters used: $f = 3700$ MHz; $\sigma = 3.07$ S/m; $\epsilon_r = 37$; $\rho = 1000$ kg/m³

Phantom section: Flat Section

Measurement Standard: DASY5 (IEEE/IEC/ANSI C63.19-2011)

DASY52 Configuration:

- Probe: EX3DV4 - SN3503; ConvF(7.73, 7.73, 7.73) @ 3700 MHz; Calibrated: 08.03.2022
- Sensor-Surface: 1.4mm (Mechanical Surface Detection)
- Electronics: DAE4 Sn601; Calibrated: 02.05.2022
- Phantom: Flat Phantom 5.0 (front); Type: QD 000 P50 AA; Serial: 1001
- DASY52 52.10.4(1535); SEMCAD X 14.6.14(7501)

Dipole Calibration for Head Tissue/Pin=100 mW, d=10mm, f=3700MHz/Zoom Scan, dist=1.4mm (8x8x8)/Cube 0: Measurement grid: dx=4mm, dy=4mm, dz=1.4mm

Reference Value = 68.96 V/m; Power Drift = -0.01 dB

Peak SAR (extrapolated) = 18.6 W/kg

SAR(1 g) = 6.56 W/kg; SAR(10 g) = 2.38 W/kg

Smallest distance from peaks to all points 3 dB below = 8 mm

Ratio of SAR at M2 to SAR at M1 = 73.4%

Maximum value of SAR (measured) = 12.8 W/kg



0 dB = 12.8 W/kg = 11.06 dBW/kg

Impedance Measurement Plot for Head TSL

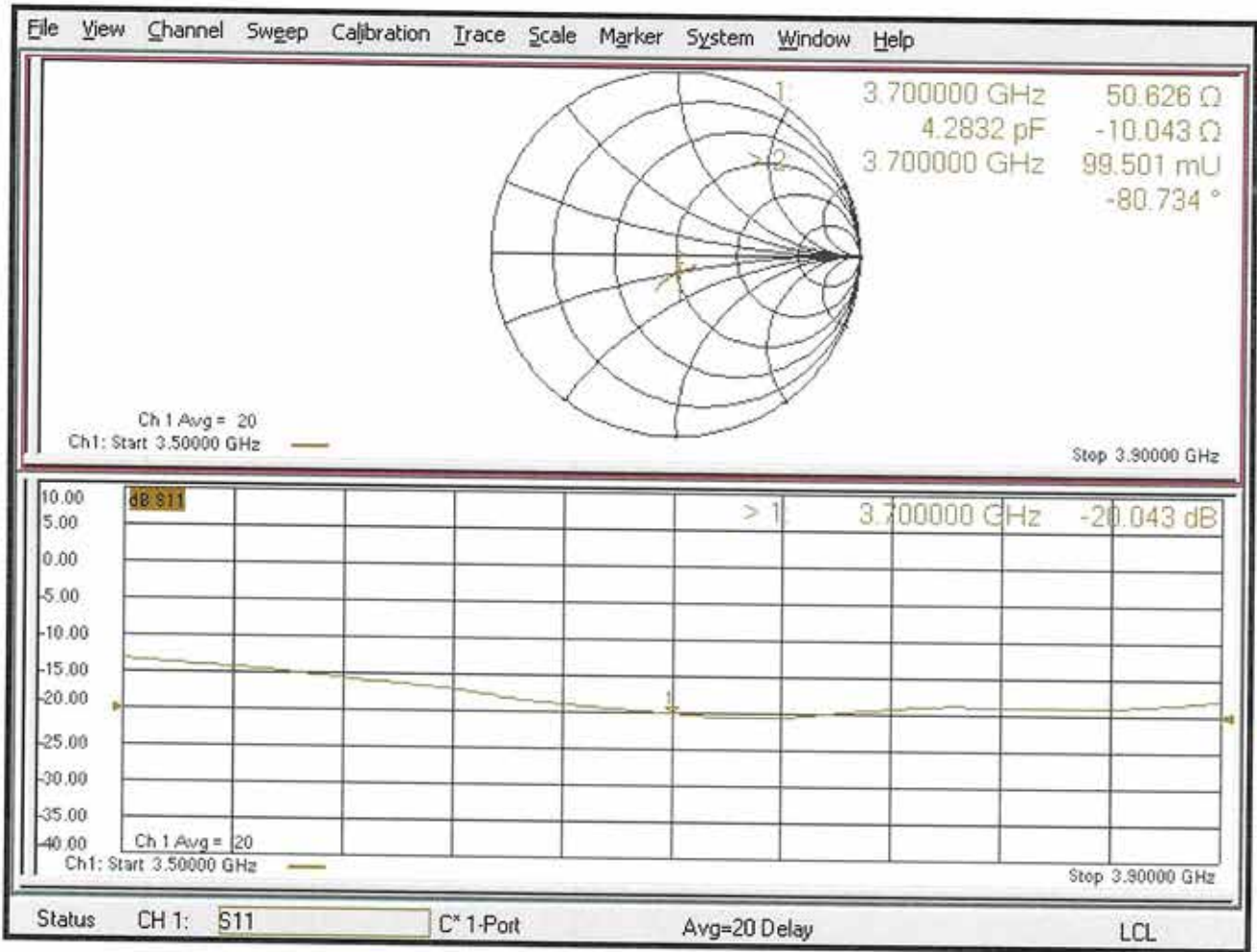



D3700V2, serial no. 1006 Extended Dipole Calibrations

If dipoles are verified in return loss (<-20dB, within 20% of prior calibration), and in impedance (within 5 ohm of prior calibration), the annual calibration is not necessary and the calibration interval can be extended.

<Justification of the extended calibration>

| D3700V2 – serial no. 1006 | | | | | | |
|-----------------------------|------------------|-----------|----------------------|-------------|---------------------------|-------------|
| 3700MHZ | | | | | | |
| Date of Measurement | Return-Loss (dB) | Delta (%) | Real Impedance (ohm) | Delta (ohm) | Imaginary Impedance (ohm) | Delta (ohm) |
| 06.20.2022 (Cal. Report) | -20.043 | | 50.626 | | -10.043 | |
| 06.19.2023 (extended) | -20.534 | -2.45 | 50.984 | 0.358 | -12.260 | -2.217 |

The return loss is <-20dB, within 20% of prior calibration; the impedance is within 5 ohm of prior calibration. Therefore the verification result should support extended calibration.



<Dipole Verification Data> - D3700 V2, serial no. 1006(Data of Measurement : 06.19.2023)
3700MHz - Head

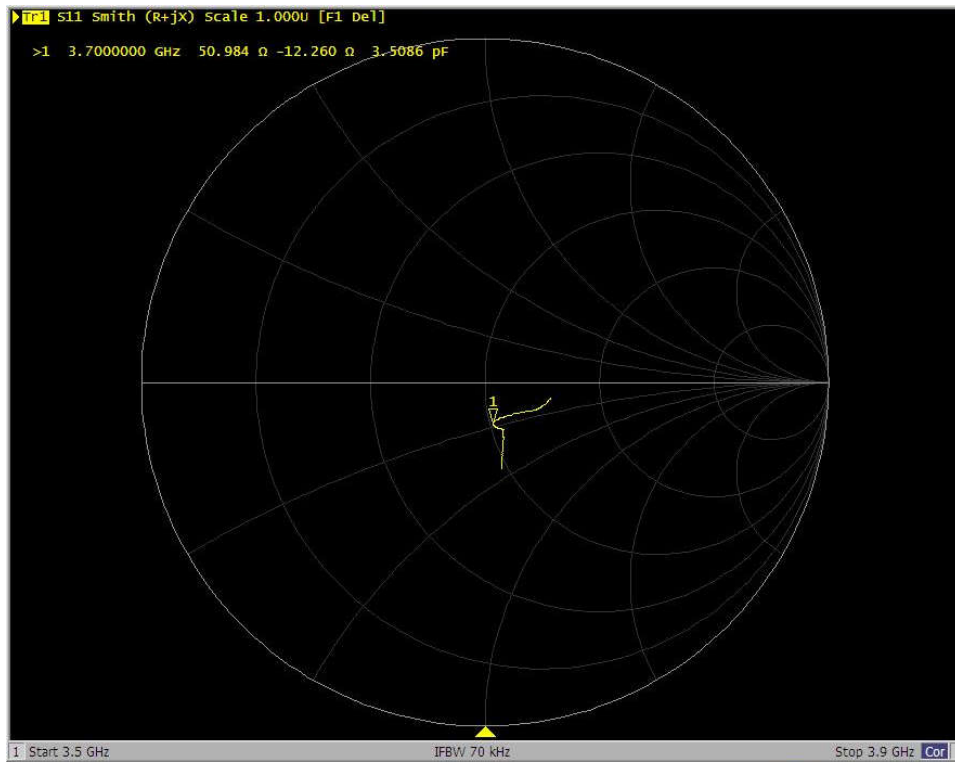
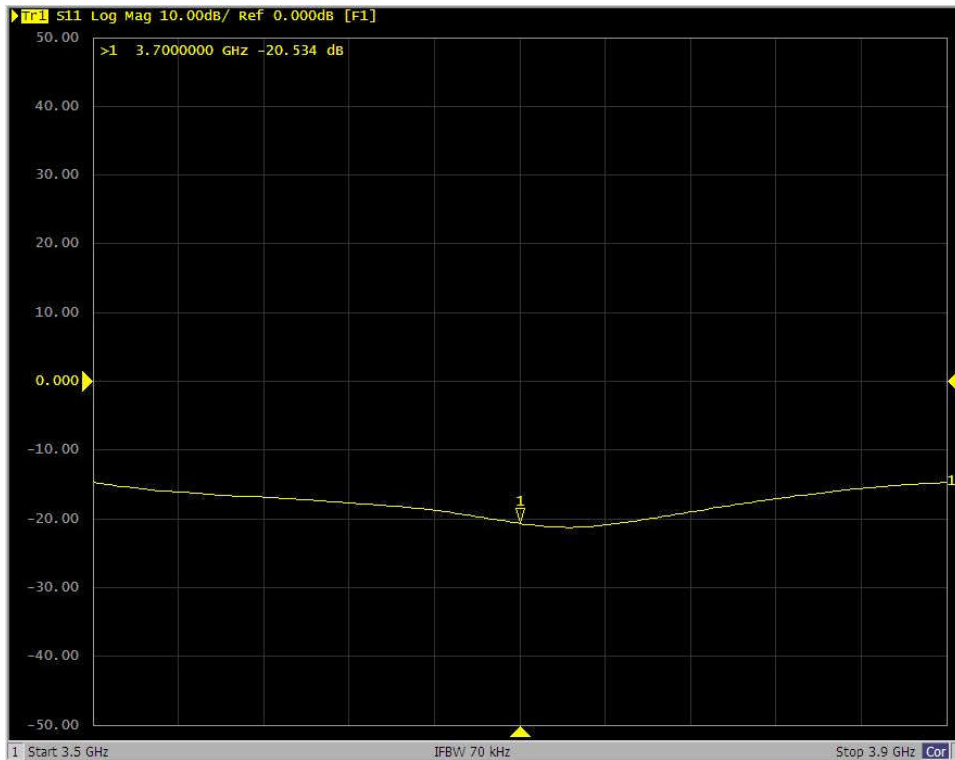



Accredited by the Swiss Accreditation Service (SAS)
The Swiss Accreditation Service is one of the signatories to the EA
Multilateral Agreement for the recognition of calibration certificates

Accreditation No.: **SCS 0108**

Client **Sporton**

Certificate No: **D3900V2-1017_Apr22**

CALIBRATION CERTIFICATE

Object **D3900V2 - SN:1017**

Calibration procedure(s) **QA CAL-22.v6
Calibration Procedure for SAR Validation Sources between 3-10 GHz**

Calibration date: **April 22, 2022**

This calibration certificate documents the traceability to national standards, which realize the physical units of measurements (SI).
The measurements and the uncertainties with confidence probability are given on the following pages and are part of the certificate.

All calibrations have been conducted in the closed laboratory facility: environment temperature $(22 \pm 3)^\circ\text{C}$ and humidity $< 70\%$.

Calibration Equipment used (M&TE critical for calibration)

| Primary Standards | ID # | Cal Date (Certificate No.) | Scheduled Calibration |
|---------------------------------|--------------------|-----------------------------------|------------------------|
| Power meter NRP | SN: 104778 | 04-Apr-22 (No. 217-03525/03524) | Apr-23 |
| Power sensor NRP-Z91 | SN: 103244 | 04-Apr-22 (No. 217-03524) | Apr-23 |
| Power sensor NRP-Z91 | SN: 103245 | 04-Apr-22 (No. 217-03525) | Apr-23 |
| Reference 20 dB Attenuator | SN: BH9394 (20k) | 04-Apr-22 (No. 217-03527) | Apr-23 |
| Type-N mismatch combination | SN: 310982 / 06327 | 04-Apr-22 (No. 217-03528) | Apr-23 |
| Reference Probe EX3DV4 | SN: 3503 | 08-Mar-22 (No. EX3-3503_Mar22) | Mar-23 |
| DAE4 | SN: 601 | 01-Nov-21 (No. DAE4-601_Nov21) | Nov-22 |
| Secondary Standards | ID # | Check Date (in house) | Scheduled Check |
| Power meter E4419B | SN: GB39512475 | 30-Oct-14 (in house check Oct-20) | In house check: Oct-22 |
| Power sensor HP 8481A | SN: US37292783 | 07-Oct-15 (in house check Oct-20) | In house check: Oct-22 |
| Power sensor HP 8481A | SN: MY41093315 | 07-Oct-15 (in house check Oct-20) | In house check: Oct-22 |
| RF generator R&S SMT-06 | SN: 100972 | 15-Jun-15 (in house check Oct-20) | In house check: Oct-22 |
| Network Analyzer Agilent E8358A | SN: US41080477 | 31-Mar-14 (in house check Oct-20) | In house check: Oct-22 |

Calibrated by: **Joanna Lleshaj** **Laboratory Technician**

Approved by: **Sven Kühn** **Deputy Manager**

Issued: April 28, 2022

This calibration certificate shall not be reproduced except in full without written approval of the laboratory.



Accredited by the Swiss Accreditation Service (SAS)
The Swiss Accreditation Service is one of the signatories to the EA
Multilateral Agreement for the recognition of calibration certificates

Accreditation No.: **SCS 0108**

Glossary:

| | |
|-------|---------------------------------|
| TSL | tissue simulating liquid |
| ConvF | sensitivity in TSL / NORM x,y,z |
| N/A | not applicable or not measured |

Calibration is Performed According to the Following Standards:

- a) IEC/IEEE 62209-1528, "Measurement Procedure For The Assessment Of Specific Absorption Rate Of Human Exposure To Radio Frequency Fields From Hand-Held And Body-Worn Wireless Communication Devices - Part 1528: Human Models, Instrumentation And Procedures (Frequency Range of 4 MHz to 10 GHz)", October 2020.
- b) KDB 865664, "SAR Measurement Requirements for 100 MHz to 6 GHz"

Additional Documentation:

- c) DASY System Handbook

Methods Applied and Interpretation of Parameters:

- *Measurement Conditions:* Further details are available from the Validation Report at the end of the certificate. All figures stated in the certificate are valid at the frequency indicated.
- *Antenna Parameters with TSL:* The source is mounted in a touch configuration below the center marking of the flat phantom.
- *Return Loss:* This parameter is measured with the source positioned under the liquid filled phantom (as described in the measurement condition clause). The Return Loss ensures low reflected power. No uncertainty required.
- *SAR measured:* SAR measured at the stated antenna input power.
- *SAR normalized:* SAR as measured, normalized to an input power of 1 W at the antenna connector.
- *SAR for nominal TSL parameters:* The measured TSL parameters are used to calculate the nominal SAR result.

The reported uncertainty of measurement is stated as the standard uncertainty of measurement multiplied by the coverage factor $k=2$, which for a normal distribution corresponds to a coverage probability of approximately 95%.

Measurement Conditions

DASY system configuration, as far as not given on page 1.

| | | |
|------------------------------|--|----------------------------------|
| DASY Version | DASY52 | V52.10.4 |
| Extrapolation | Advanced Extrapolation | |
| Phantom | Modular Flat Phantom V5.0 | |
| Distance Dipole Center - TSL | 10 mm | with Spacer |
| Zoom Scan Resolution | dx, dy = 4.0 mm, dz = 1.4 mm | Graded Ratio = 1.4 (Z direction) |
| Frequency | 3900 MHz \pm 1 MHz 4100 MHz \pm 1 MHz | |

Head TSL parameters at 3900 MHz

The following parameters and calculations were applied.

| | Temperature | Permittivity | Conductivity |
|---|---------------------|----------------|----------------------|
| Nominal Head TSL parameters | 22.0 °C | 37.5 | 3.32 mho/m |
| Measured Head TSL parameters | (22.0 \pm 0.2) °C | 36.5 \pm 6 % | 3.25 mho/m \pm 6 % |
| Head TSL temperature change during test | < 0.5 °C | ---- | ---- |

SAR result with Head TSL at 3900 MHz

| SAR averaged over 1 cm ³ (1 g) of Head TSL | Condition | |
|---|--------------------|--|
| SAR measured | 100 mW input power | 6.89 W/kg |
| SAR for nominal Head TSL parameters | normalized to 1W | 68.7 W/kg \pm 19.9 % (k=2) |

| SAR averaged over 10 cm ³ (10 g) of Head TSL | condition | |
|---|--------------------|--|
| SAR measured | 100 mW input power | 2.41 W/kg |
| SAR for nominal Head TSL parameters | normalized to 1W | 23.9 W/kg \pm 19.5 % (k=2) |

Head TSL parameters at 4100 MHz

The following parameters and calculations were applied.

| | Temperature | Permittivity | Conductivity |
|---|---------------------|----------------|----------------------|
| Nominal Head TSL parameters | 22.0 °C | 37.2 | 3.53 mho/m |
| Measured Head TSL parameters | (22.0 \pm 0.2) °C | 36.3 \pm 6 % | 3.42 mho/m \pm 6 % |
| Head TSL temperature change during test | < 0.5 °C | ---- | ---- |

SAR result with Head TSL at 4100 MHz

| SAR averaged over 1 cm ³ (1 g) of Head TSL | Condition | |
|---|--------------------|--|
| SAR measured | 100 mW input power | 6.84 W/kg |
| SAR for nominal Head TSL parameters | normalized to 1W | 68.3 W/kg \pm 19.9 % (k=2) |

| SAR averaged over 10 cm ³ (10 g) of Head TSL | condition | |
|---|--------------------|--|
| SAR measured | 100 mW input power | 2.38 W/kg |
| SAR for nominal Head TSL parameters | normalized to 1W | 23.7 W/kg \pm 19.5 % (k=2) |

Appendix (Additional assessments outside the scope of SCS 0108)

Antenna Parameters with Head TSL at 3900 MHz

| | |
|--------------------------------------|--------------------------------|
| Impedance, transformed to feed point | 49.4 Ω - 7.0 j Ω |
| Return Loss | - 23.0 dB |

Antenna Parameters with Head TSL at 4100 MHz

| | |
|--------------------------------------|--------------------------------|
| Impedance, transformed to feed point | 60.1 Ω + 0.0 j Ω |
| Return Loss | - 20.8 dB |

General Antenna Parameters and Design

| | |
|----------------------------------|----------|
| Electrical Delay (one direction) | 1.104 ns |
|----------------------------------|----------|

After long term use with 100W radiated power, only a slight warming of the dipole near the feedpoint can be measured.

The dipole is made of standard semirigid coaxial cable. The center conductor of the feeding line is directly connected to the second arm of the dipole. The antenna is therefore short-circuited for DC-signals. On some of the dipoles, small end caps are added to the dipole arms in order to improve matching when loaded according to the position as explained in the "Measurement Conditions" paragraph. The SAR data are not affected by this change. The overall dipole length is still according to the Standard.

No excessive force must be applied to the dipole arms, because they might bend or the soldered connections near the feedpoint may be damaged.

Additional EUT Data

| | |
|-----------------|-------|
| Manufactured by | SPEAG |
|-----------------|-------|

DASY5 Validation Report for Head TSL

Date: 22.04.2022

Test Laboratory: SPEAG, Zurich, Switzerland

DUT: Dipole 3900 MHz; Type: D3900V2; Serial: D3900V2 - SN:1017

Communication System: UID 0 - CW; Frequency: 3900 MHz, Frequency: 4100 MHz
Medium parameters used: $f = 3900$ MHz; $\sigma = 3.25$ S/m; $\epsilon_r = 36.5$; $\rho = 1000$ kg/m³,
Medium parameters used: $f = 4100$ MHz; $\sigma = 3.42$ S/m; $\epsilon_r = 36.3$; $\rho = 1000$ kg/m³
Phantom section: Flat Section
Measurement Standard: DASY5 (IEEE/IEC/ANSI C63.19-2011)

DASY52 Configuration:

- Probe: EX3DV4 - SN3503; ConvF(7.39, 7.39, 7.39) @ 3900 MHz, ConvF(7.26, 7.26, 7.26) @ 4100 MHz; Calibrated: 08.03.2022
- Sensor-Surface: 1.4mm (Mechanical Surface Detection)
- Electronics: DAE4 Sn601; Calibrated: 01.11.2021
- Phantom: Flat Phantom 5.0 (front); Type: QD 000 P50 AA; Serial: 1001
- DASY52 52.10.4(1535); SEMCAD X 14.6.14(7501)

Dipole Calibration for Head Tissue/Pin=100 mW, d=10mm, f=3900MHz/Zoom Scan,

dist=1.4mm (8x8x8)/Cube 0: Measurement grid: dx=4mm, dy=4mm, dz=1.4mm

Reference Value = 69.24 V/m; Power Drift = -0.04 dB

Peak SAR (extrapolated) = 19.6 W/kg

SAR(1 g) = 6.89 W/kg; SAR(10 g) = 2.41 W/kg

Smallest distance from peaks to all points 3 dB below = 8.2 mm

Ratio of SAR at M2 to SAR at M1 = 73.9%

Maximum value of SAR (measured) = 13.7 W/kg

Dipole Calibration for Head Tissue/Pin=100 mW, d=10mm, f=4100MHz/Zoom Scan,

dist=1.4mm (8x8x8)/Cube 0: Measurement grid: dx=4mm, dy=4mm, dz=1.4mm

Reference Value = 69.78 V/m; Power Drift = -0.03 dB

Peak SAR (extrapolated) = 19.4 W/kg

SAR(1 g) = 6.84 W/kg; SAR(10 g) = 2.38 W/kg

Smallest distance from peaks to all points 3 dB below = 8.4 mm

Ratio of SAR at M2 to SAR at M1 = 74.1%

Maximum value of SAR (measured) = 13.5 W/kg

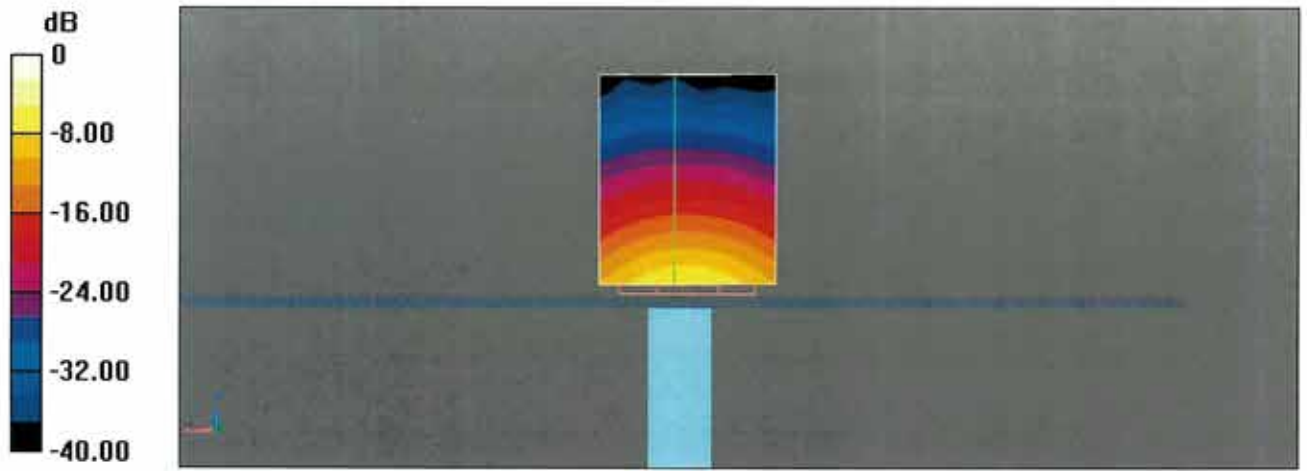

0 dB = 13.7 W/kg = 11.36 dBW/kg

Impedance Measurement Plot for Head TSL

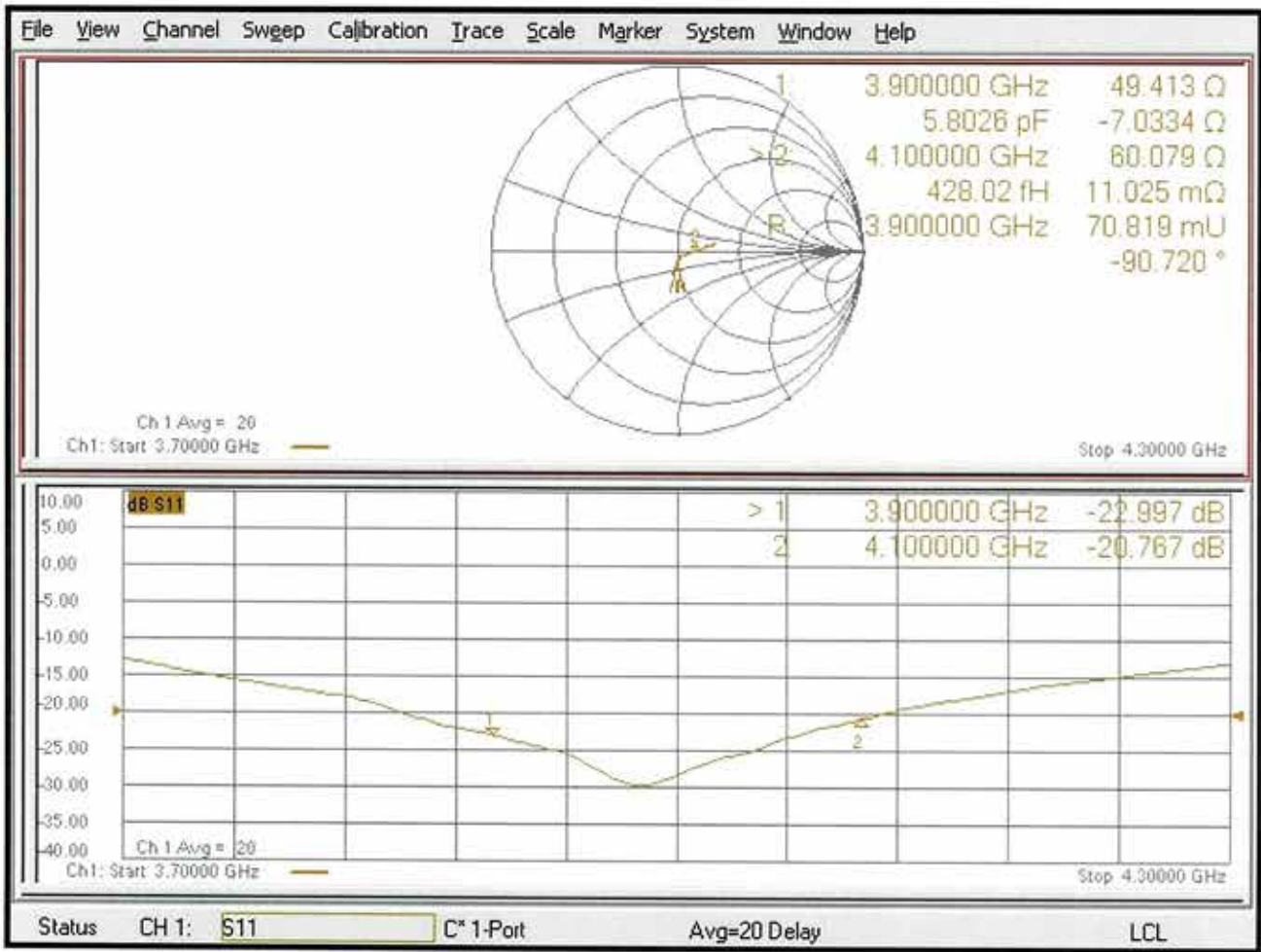



D3900V2, serial no. 1017 Extended Dipole Calibrations

If dipoles are verified in return loss (<-20dB, within 20% of prior calibration), and in impedance (within 5 ohm of prior calibration), the annual calibration is not necessary and the calibration interval can be extended.

<Justification of the extended calibration>

| D3900V2 – serial no. 1017 | | | | | | |
|-----------------------------|------------------|-----------|----------------------|-------------|---------------------------|-------------|
| 3900MHZ | | | | | | |
| Date of Measurement | Return-Loss (dB) | Delta (%) | Real Impedance (ohm) | Delta (ohm) | Imaginary Impedance (ohm) | Delta (ohm) |
| 04.22.2022 (Cal. Report) | -22.997 | | 49.413 | | -7.0334 | |
| 04.21.2023 (extended) | -22.064 | 4.06 | 51.756 | 2.343 | -4.9563 | 2.0771 |
| 4100MHZ | | | | | | |
| Date of Measurement | Return-Loss (dB) | Delta (%) | Real Impedance (ohm) | Delta (ohm) | Imaginary Impedance (ohm) | Delta (ohm) |
| 04.22.2022 (Cal. Report) | -20.767 | | 60.079 | | 0.011025 | |
| 04.21.2023 (extended) | -21.052 | -1.37 | 64.918 | 4.839 | -4.7317 | -4.74273 |

The return loss is <-20dB, within 20% of prior calibration; the impedance is within 5 ohm of prior calibration. Therefore the verification result should support extended calibration.



<Dipole Verification Data> - D3900 V2, serial no. 1017 (Data of Measurement : 04.21.2023)

3900 MHz - Head

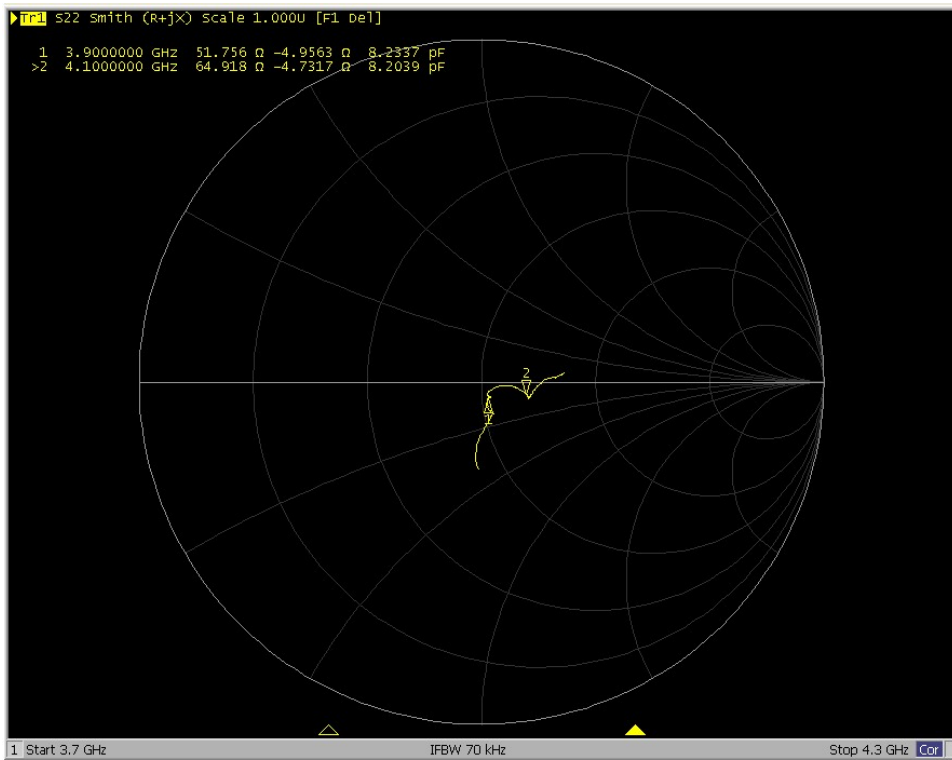
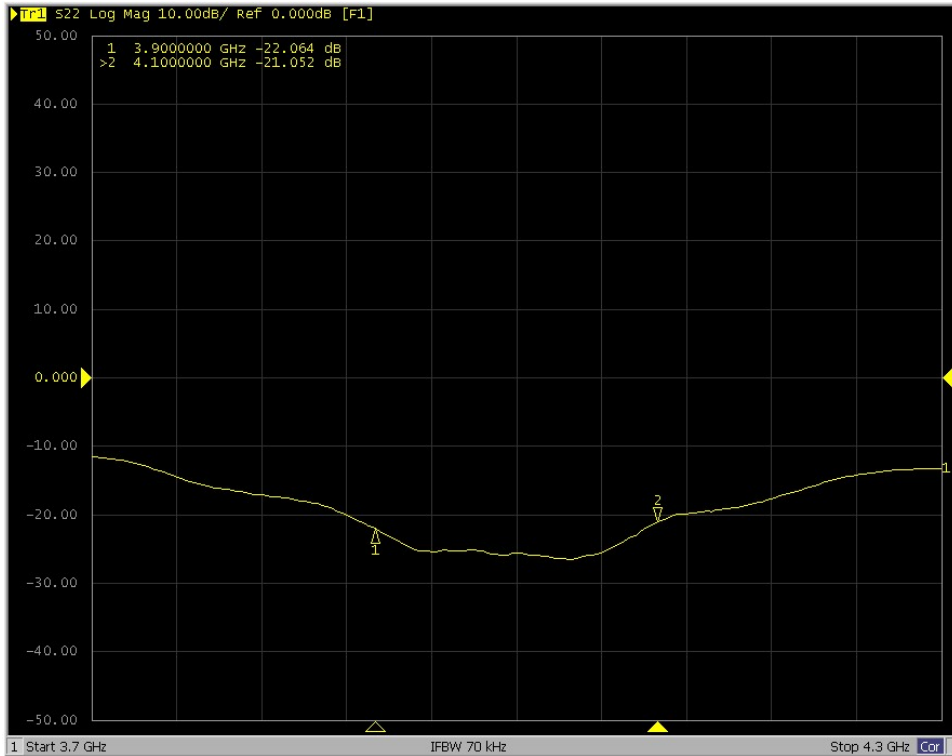



Accredited by the Swiss Accreditation Service (SAS)
The Swiss Accreditation Service is one of the signatories to the EA
Multilateral Agreement for the recognition of calibration certificates

Client **Sporton**
Taoyuan City

Certificate No. **D3900V2-1092_May23**

CALIBRATION CERTIFICATE

Object **D3900V2 - SN:1092**

Calibration procedure(s) **QA CAL-22.v7
Calibration Procedure for SAR Validation Sources between 3-10 GHz**

Calibration date: **May 15, 2023**

This calibration certificate documents the traceability to national standards, which realize the physical units of measurements (SI).
The measurements and the uncertainties with confidence probability are given on the following pages and are part of the certificate.

All calibrations have been conducted in the closed laboratory facility: environment temperature (22 ± 3)°C and humidity < 70%.

Calibration Equipment used (M&TE critical for calibration)

| Primary Standards | ID # | Cal Date (Certificate No.) | Scheduled Calibration |
|---------------------------------|--------------------|-----------------------------------|------------------------|
| Power meter NRP2 | SN: 104778 | 30-Mar-23 (No. 217-03804/03805) | Mar-24 |
| Power sensor NRP-Z91 | SN: 103244 | 30-Mar-23 (No. 217-03804) | Mar-24 |
| Power sensor NRP-Z91 | SN: 103245 | 30-Mar-23 (No. 217-03805) | Mar-24 |
| Reference 20 dB Attenuator | SN: BH9394 (20k) | 30-Mar-23 (No. 217-03809) | Mar-24 |
| Type-N mismatch combination | SN: 310982 / 06327 | 30-Mar-23 (No. 217-03810) | Mar-24 |
| Reference Probe EX3DV4 | SN: 3503 | 07-Mar-23 (No. EX3-3503_Mar23) | Mar-24 |
| DAE4 | SN: 601 | 19-Dec-22 (No. DAE4-601_Dec22) | Dec-23 |
| Secondary Standards | ID # | Check Date (in house) | Scheduled Check |
| Power meter E4419B | SN: GB39512475 | 30-Oct-14 (in house check Oct-22) | In house check: Oct-24 |
| Power sensor HP 8481A | SN: US37292783 | 07-Oct-15 (in house check Oct-22) | In house check: Oct-24 |
| Power sensor HP 8481A | SN: MY41093315 | 07-Oct-15 (in house check Oct-22) | In house check: Oct-24 |
| RF generator R&S SMT-06 | SN: 100972 | 15-Jun-15 (in house check Oct-22) | In house check: Oct-24 |
| Network Analyzer Agilent E8358A | SN: US41080477 | 31-Mar-14 (in house check Oct-22) | In house check: Oct-24 |

| | | | |
|----------------|------------------------|-----------------------------------|---------------|
| Calibrated by: | Name Jeton Kastrati | Function Laboratory Technician | Signature |
| Approved by: | Sven Kühn | Technical Manager | |

Issued: May 17, 2023

This calibration certificate shall not be reproduced except in full without written approval of the laboratory.



Accredited by the Swiss Accreditation Service (SAS)
The Swiss Accreditation Service is one of the signatories to the EA
Multilateral Agreement for the recognition of calibration certificates

Accreditation No.: **SCS 0108**

Glossary:

| | |
|-------|---------------------------------|
| TSL | tissue simulating liquid |
| ConvF | sensitivity in TSL / NORM x,y,z |
| N/A | not applicable or not measured |

Calibration is Performed According to the Following Standards:

- a) IEC/IEEE 62209-1528, "Measurement Procedure For The Assessment Of Specific Absorption Rate Of Human Exposure To Radio Frequency Fields From Hand-Held And Body-Worn Wireless Communication Devices - Part 1528: Human Models, Instrumentation And Procedures (Frequency Range of 4 MHz to 10 GHz)", October 2020.
- b) KDB 865664, "SAR Measurement Requirements for 100 MHz to 6 GHz"

Additional Documentation:

- c) DASY System Handbook

Methods Applied and Interpretation of Parameters:

- *Measurement Conditions:* Further details are available from the Validation Report at the end of the certificate. All figures stated in the certificate are valid at the frequency indicated.
- *Antenna Parameters with TSL:* The source is mounted in a touch configuration below the center marking of the flat phantom.
- *Return Loss:* This parameter is measured with the source positioned under the liquid filled phantom (as described in the measurement condition clause). The Return Loss ensures low reflected power. No uncertainty required.
- *SAR measured:* SAR measured at the stated antenna input power.
- *SAR normalized:* SAR as measured, normalized to an input power of 1 W at the antenna connector.
- *SAR for nominal TSL parameters:* The measured TSL parameters are used to calculate the nominal SAR result.

The reported uncertainty of measurement is stated as the standard uncertainty of measurement multiplied by the coverage factor $k=2$, which for a normal distribution corresponds to a coverage probability of approximately 95%.

Measurement Conditions

DASY system configuration, as far as not given on page 1.

| | | |
|-------------------------------------|--------------------------------------|----------------------------------|
| DASY Version | DASY52 | V52.10.4 |
| Extrapolation | Advanced Extrapolation | |
| Phantom | Modular Flat Phantom V5.0 | |
| Distance Dipole Center - TSL | 10 mm | with Spacer |
| Zoom Scan Resolution | dx, dy = 4.0 mm, dz = 1.4 mm | Graded Ratio = 1.4 (Z direction) |
| Frequency | 3900 MHz ± 1 MHz 4100 MHz ± 1 MHz | |

Head TSL parameters at 3900 MHz

The following parameters and calculations were applied.

| | Temperature | Permittivity | Conductivity |
|--|-----------------|--------------|------------------|
| Nominal Head TSL parameters | 22.0 °C | 37.5 | 3.32 mho/m |
| Measured Head TSL parameters | (22.0 ± 0.2) °C | 37.0 ± 6 % | 3.23 mho/m ± 6 % |
| Head TSL temperature change during test | < 0.5 °C | ---- | ---- |

SAR result with Head TSL at 3900 MHz

| SAR averaged over 1 cm³ (1 g) of Head TSL | Condition | |
|---|--------------------|---------------------------------|
| SAR measured | 100 mW input power | 6.69 W/kg |
| SAR for nominal Head TSL parameters | normalized to 1W | 67.0 W/kg ± 19.9 % (k=2) |

| SAR averaged over 10 cm³ (10 g) of Head TSL | condition | |
|---|--------------------|---------------------------------|
| SAR measured | 100 mW input power | 2.32 W/kg |
| SAR for nominal Head TSL parameters | normalized to 1W | 23.2 W/kg ± 19.5 % (k=2) |

Head TSL parameters at 4100 MHz

The following parameters and calculations were applied.

| | Temperature | Permittivity | Conductivity |
|--|-----------------|--------------|------------------|
| Nominal Head TSL parameters | 22.0 °C | 37.2 | 3.53 mho/m |
| Measured Head TSL parameters | (22.0 ± 0.2) °C | 36.7 ± 6 % | 3.40 mho/m ± 6 % |
| Head TSL temperature change during test | < 0.5 °C | ---- | ---- |

SAR result with Head TSL at 4100 MHz

| SAR averaged over 1 cm³ (1 g) of Head TSL | Condition | |
|---|--------------------|---------------------------------|
| SAR measured | 100 mW input power | 6.67 W/kg |
| SAR for nominal Head TSL parameters | normalized to 1W | 66.8 W/kg ± 19.9 % (k=2) |

| SAR averaged over 10 cm³ (10 g) of Head TSL | condition | |
|---|--------------------|---------------------------------|
| SAR measured | 100 mW input power | 2.31 W/kg |
| SAR for nominal Head TSL parameters | normalized to 1W | 23.0 W/kg ± 19.5 % (k=2) |

Appendix (Additional assessments outside the scope of SCS 0108)

Antenna Parameters with Head TSL at 3900 MHz

| | |
|--------------------------------------|--------------------------------|
| Impedance, transformed to feed point | 49.2 Ω - 4.0 j Ω |
| Return Loss | - 27.7 dB |

Antenna Parameters with Head TSL at 4100 MHz

| | |
|--------------------------------------|--------------------------------|
| Impedance, transformed to feed point | 56.0 Ω + 5.0 j Ω |
| Return Loss | - 22.6 dB |

General Antenna Parameters and Design

| | |
|----------------------------------|----------|
| Electrical Delay (one direction) | 1.112 ns |
|----------------------------------|----------|

After long term use with 100W radiated power, only a slight warming of the dipole near the feedpoint can be measured.

The dipole is made of standard semirigid coaxial cable. The center conductor of the feeding line is directly connected to the second arm of the dipole. The antenna is therefore short-circuited for DC-signals. On some of the dipoles, small end caps are added to the dipole arms in order to improve matching when loaded according to the position as explained in the "Measurement Conditions" paragraph. The SAR data are not affected by this change. The overall dipole length is still according to the Standard.

No excessive force must be applied to the dipole arms, because they might bend or the soldered connections near the feedpoint may be damaged.

Additional EUT Data

| | |
|-----------------|-------|
| Manufactured by | SPEAG |
|-----------------|-------|

DASY5 Validation Report for Head TSL

Date: 15.05.2023

Test Laboratory: SPEAG, Zurich, Switzerland

DUT: Dipole 3900 MHz; Type: D3900V2; Serial: D3900V2 - SN:1092

Communication System: UID 0 - CW; Frequency: 3900 MHz, Frequency: 4100 MHz

Medium parameters used: $f = 3900$ MHz; $\sigma = 3.23$ S/m; $\epsilon_r = 37.0$; $\rho = 1000$ kg/m³,

Medium parameters used: $f = 4100$ MHz; $\sigma = 3.40$ S/m; $\epsilon_r = 36.7$; $\rho = 1000$ kg/m³

Phantom section: Flat Section

Measurement Standard: DASY5 (IEEE/IEC/ANSI C63.19-2011)

DASY52 Configuration:

- Probe: EX3DV4 - SN3503; ConvF(7.39, 7.39, 7.39) @ 3900 MHz, ConvF(7.26, 7.26, 7.26) @ 4100 MHz; Calibrated: 07.03.2023
- Sensor-Surface: 1.4mm (Mechanical Surface Detection)
- Electronics: DAE4 Sn601; Calibrated: 19.12.2022
- Phantom: Flat Phantom 5.0 (front); Type: QD 000 P50 AA; Serial: 1001
- DASY52 52.10.4(1535); SEMCAD X 14.6.14(7501)

Dipole Calibration for Head Tissue/Pin=100 mW, d=10mm, f=3900MHz/Zoom Scan, dist=1.4mm (8x8x8)/Cube 0: Measurement grid: dx=4mm, dy=4mm, dz=1.4mm

Reference Value = 70.57 V/m; Power Drift = -0.01 dB

Peak SAR (extrapolated) = 18.8 W/kg

SAR(1 g) = 6.69 W/kg; SAR(10 g) = 2.32 W/kg

Smallest distance from peaks to all points 3 dB below = 7.9 mm

Ratio of SAR at M2 to SAR at M1 = 74.2%

Maximum value of SAR (measured) = 13.3 W/kg

Dipole Calibration for Head Tissue/Pin=100 mW, d=10mm, f=4100MHz/Zoom Scan, dist=1.4mm (8x8x8)/Cube 0: Measurement grid: dx=4mm, dy=4mm, dz=1.4mm

Reference Value = 68.75 V/m; Power Drift = -0.00 dB

Peak SAR (extrapolated) = 18.9 W/kg

SAR(1 g) = 6.67 W/kg; SAR(10 g) = 2.31 W/kg

Smallest distance from peaks to all points 3 dB below = 7.9 mm

Ratio of SAR at M2 to SAR at M1 = 74%

Maximum value of SAR (measured) = 13.4 W/kg

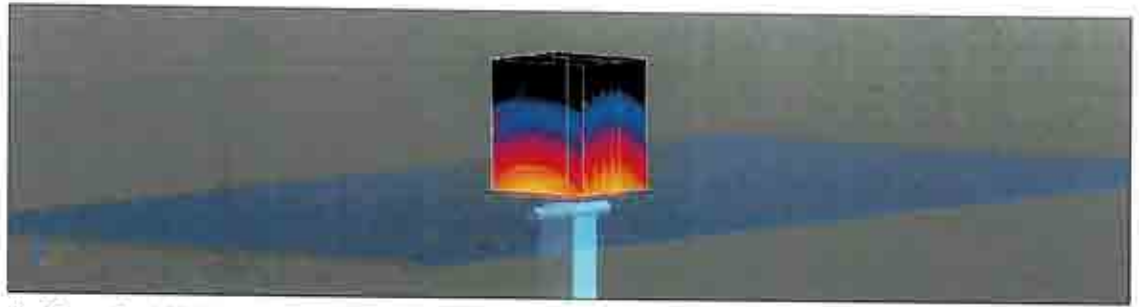
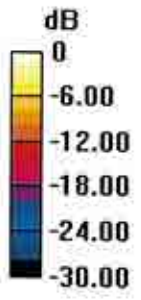

0 dB = 13.4 W/kg = 11.28 dBW/kg

Impedance Measurement Plot for Head TSL

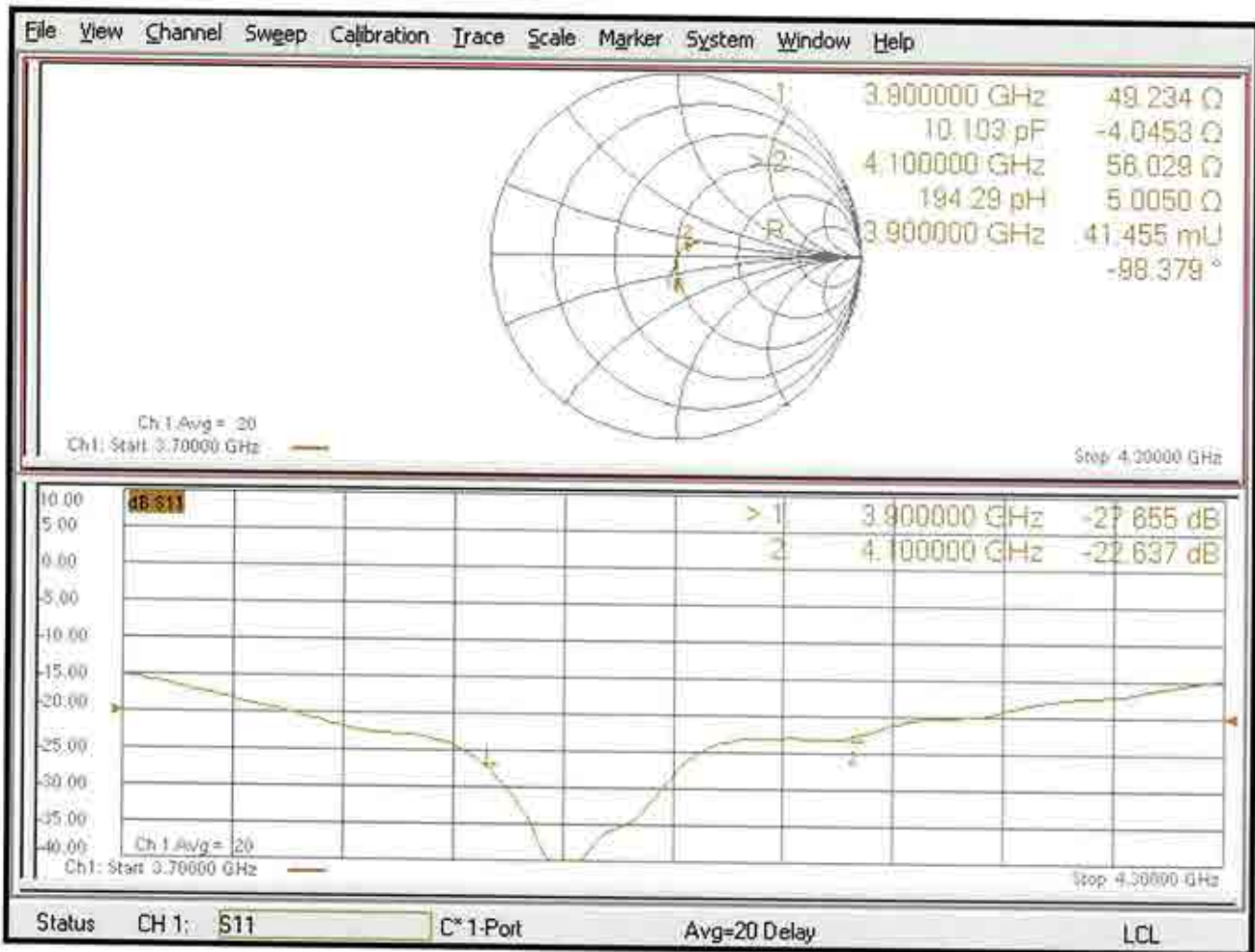



Accredited by the Swiss Accreditation Service (SAS)
The Swiss Accreditation Service is one of the signatories to the EA
Multilateral Agreement for the recognition of calibration certificates

Client **Sporton**
Taoyuan City

Certificate No. **D5GHzV2-1006_May23**

CALIBRATION CERTIFICATE

Object: **D5GHzV2 - SN:1006**

Calibration procedure(s): **QA CAL-22.v7
Calibration Procedure for SAR Validation Sources between 3-10 GHz**

Calibration date: **May 25, 2023**

This calibration certificate documents the traceability to national standards, which realize the physical units of measurements (SI).
The measurements and the uncertainties with confidence probability are given on the following pages and are part of the certificate.

All calibrations have been conducted in the closed laboratory facility: environment temperature (22 ± 3)°C and humidity < 70%.

Calibration Equipment used (M&TE critical for calibration)

| Primary Standards | ID # | Cal Date (Certificate No.) | Scheduled Calibration |
|---------------------------------|--------------------|-----------------------------------|------------------------|
| Power meter NRP2 | SN: 104778 | 30-Mar-23 (No. 217-03804/03805) | Mar-24 |
| Power sensor NRP-Z91 | SN: 103244 | 30-Mar-23 (No. 217-03804) | Mar-24 |
| Power sensor NRP-Z91 | SN: 103245 | 30-Mar-23 (No. 217-03805) | Mar-24 |
| Reference 20 dB Attenuator | SN: BH9394 (20k) | 30-Mar-23 (No. 217-03809) | Mar-24 |
| Type-N mismatch combination | SN: 310982 / 06327 | 30-Mar-23 (No. 217-03810) | Mar-24 |
| Reference Probe EX3DV4 | SN: 3503 | 07-Mar-23 (No. EX3-3503_Mar23) | Mar-24 |
| DAE4 | SN: 601 | 19-Dec-22 (No. DAE4-601_Dec22) | Dec-23 |
| Secondary Standards | ID # | Check Date (in house) | Scheduled Check |
| Power meter E4419B | SN: GB39512475 | 30-Oct-14 (in house check Oct-22) | In house check: Oct-24 |
| Power sensor HP 8481A | SN: US37292783 | 07-Oct-15 (in house check Oct-22) | In house check: Oct-24 |
| Power sensor HP 8481A | SN: MY41093315 | 07-Oct-15 (in house check Oct-22) | In house check: Oct-24 |
| RF generator R&S SMT-06 | SN: 100972 | 15-Jun-15 (in house check Oct-22) | In house check: Oct-24 |
| Network Analyzer Agilent E8358A | SN: US41080477 | 31-Mar-14 (in house check Oct-22) | In house check: Oct-24 |

| | | | |
|----------------|---------------------------------|-----------------------------------|---------------|
| Calibrated by: | Name Krešimir Franjić | Function Laboratory Technician | Signature |
| Approved by: | Name Sven Kühn | Function Technical Manager | Signature |

Issued: May 25, 2023

This calibration certificate shall not be reproduced except in full without written approval of the laboratory.



Accredited by the Swiss Accreditation Service (SAS)

The Swiss Accreditation Service is one of the signatories to the EA Multilateral Agreement for the recognition of calibration certificates

Accreditation No.: **SCS 0108**

Glossary:

| | |
|-------|---------------------------------|
| TSL | tissue simulating liquid |
| ConvF | sensitivity in TSL / NORM x,y,z |
| N/A | not applicable or not measured |

Calibration is Performed According to the Following Standards:

- a) IEC/IEEE 62209-1528, "Measurement Procedure For The Assessment Of Specific Absorption Rate Of Human Exposure To Radio Frequency Fields From Hand-Held And Body-Worn Wireless Communication Devices - Part 1528: Human Models, Instrumentation And Procedures (Frequency Range of 4 MHz to 10 GHz)", October 2020.
- b) KDB 865664, "SAR Measurement Requirements for 100 MHz to 6 GHz"

Additional Documentation:

- c) DASY System Handbook

Methods Applied and Interpretation of Parameters:

- *Measurement Conditions:* Further details are available from the Validation Report at the end of the certificate. All figures stated in the certificate are valid at the frequency indicated.
- *Antenna Parameters with TSL:* The source is mounted in a touch configuration below the center marking of the flat phantom.
- *Return Loss:* This parameter is measured with the source positioned under the liquid filled phantom (as described in the measurement condition clause). The Return Loss ensures low reflected power. No uncertainty required.
- *SAR measured:* SAR measured at the stated antenna input power.
- *SAR normalized:* SAR as measured, normalized to an input power of 1 W at the antenna connector.
- *SAR for nominal TSL parameters:* The measured TSL parameters are used to calculate the nominal SAR result.

The reported uncertainty of measurement is stated as the standard uncertainty of measurement multiplied by the coverage factor $k=2$, which for a normal distribution corresponds to a coverage probability of approximately 95%.

Measurement Conditions

DASY system configuration, as far as not given on page 1.

| | | |
|------------------------------|--|----------------------------------|
| DASY Version | DASY52 | V52.10.4 |
| Extrapolation | Advanced Extrapolation | |
| Phantom | Modular Flat Phantom V5.0 | |
| Distance Dipole Center - TSL | 10 mm | with Spacer |
| Zoom Scan Resolution | dx, dy = 4.0 mm, dz = 1.4 mm | Graded Ratio = 1.4 (Z direction) |
| Frequency | 5250 MHz ± 1 MHz 5600 MHz ± 1 MHz 5750 MHz ± 1 MHz 5850 MHz ± 1 MHz | |

Head TSL parameters at 5250 MHz

The following parameters and calculations were applied.

| | Temperature | Permittivity | Conductivity |
|---|-----------------|--------------|------------------|
| Nominal Head TSL parameters | 22.0 °C | 35.9 | 4.71 mho/m |
| Measured Head TSL parameters | (22.0 ± 0.2) °C | 34.8 ± 6 % | 4.60 mho/m ± 6 % |
| Head TSL temperature change during test | < 0.5 °C | ---- | ---- |

SAR result with Head TSL at 5250 MHz

| SAR averaged over 1 cm ³ (1 g) of Head TSL | Condition | |
|---|--------------------|---------------------------------|
| SAR measured | 100 mW input power | 8.18 W/kg |
| SAR for nominal Head TSL parameters | normalized to 1W | 81.2 W/kg ± 19.9 % (k=2) |

| SAR averaged over 10 cm ³ (10 g) of Head TSL | condition | |
|---|--------------------|---------------------------------|
| SAR measured | 100 mW input power | 2.34 W/kg |
| SAR for nominal Head TSL parameters | normalized to 1W | 23.2 W/kg ± 19.5 % (k=2) |

Head TSL parameters at 5600 MHz

The following parameters and calculations were applied.

| | Temperature | Permittivity | Conductivity |
|---|-----------------|--------------|------------------|
| Nominal Head TSL parameters | 22.0 °C | 35.5 | 5.07 mho/m |
| Measured Head TSL parameters | (22.0 ± 0.2) °C | 34.6 ± 6 % | 4.97 mho/m ± 6 % |
| Head TSL temperature change during test | < 0.5 °C | ---- | ---- |

SAR result with Head TSL at 5600 MHz

| SAR averaged over 1 cm ³ (1 g) of Head TSL | Condition | |
|---|--------------------|---------------------------------|
| SAR measured | 100 mW input power | 8.52 W/kg |
| SAR for nominal Head TSL parameters | normalized to 1W | 84.7 W/kg ± 19.9 % (k=2) |

| SAR averaged over 10 cm ³ (10 g) of Head TSL | condition | |
|---|--------------------|---------------------------------|
| SAR measured | 100 mW input power | 2.44 W/kg |
| SAR for nominal Head TSL parameters | normalized to 1W | 24.2 W/kg ± 19.5 % (k=2) |

Head TSL parameters at 5750 MHz

The following parameters and calculations were applied.

| | Temperature | Permittivity | Conductivity |
|---|-----------------|--------------|------------------|
| Nominal Head TSL parameters | 22.0 °C | 35.4 | 5.22 mho/m |
| Measured Head TSL parameters | (22.0 ± 0.2) °C | 34.4 ± 6 % | 5.08 mho/m ± 6 % |
| Head TSL temperature change during test | < 0.5 °C | ---- | ---- |

SAR result with Head TSL at 5750 MHz

| SAR averaged over 1 cm ³ (1 g) of Head TSL | Condition | |
|---|--------------------|---------------------------------|
| SAR measured | 100 mW input power | 8.15 W/kg |
| SAR for nominal Head TSL parameters | normalized to 1W | 80.9 W/kg ± 19.9 % (k=2) |

| SAR averaged over 10 cm ³ (10 g) of Head TSL | condition | |
|---|--------------------|---------------------------------|
| SAR measured | 100 mW input power | 2.31 W/kg |
| SAR for nominal Head TSL parameters | normalized to 1W | 22.9 W/kg ± 19.5 % (k=2) |

Head TSL parameters at 5850 MHz

The following parameters and calculations were applied.

| | Temperature | Permittivity | Conductivity |
|---|-----------------|--------------|------------------|
| Nominal Head TSL parameters | 22.0 °C | 35.2 | 5.32 mho/m |
| Measured Head TSL parameters | (22.0 ± 0.2) °C | 34.2 ± 6 % | 5.15 mho/m ± 6 % |
| Head TSL temperature change during test | < 0.5 °C | ---- | ---- |

SAR result with Head TSL at 5850 MHz

| SAR averaged over 1 cm ³ (1 g) of Head TSL | Condition | |
|---|--------------------|---------------------------------|
| SAR measured | 100 mW input power | 8.24 W/kg |
| SAR for nominal Head TSL parameters | normalized to 1W | 81.8 W/kg ± 19.9 % (k=2) |

| SAR averaged over 10 cm ³ (10 g) of Head TSL | condition | |
|---|--------------------|---------------------------------|
| SAR measured | 100 mW input power | 2.34 W/kg |
| SAR for nominal Head TSL parameters | normalized to 1W | 23.2 W/kg ± 19.5 % (k=2) |

Appendix (Additional assessments outside the scope of SCS 0108)

Antenna Parameters with Head TSL at 5250 MHz

| | |
|--------------------------------------|--------------------------------|
| Impedance, transformed to feed point | 54.4 Ω - 7.5 j Ω |
| Return Loss | - 21.6 dB |

Antenna Parameters with Head TSL at 5600 MHz

| | |
|--------------------------------------|--------------------------------|
| Impedance, transformed to feed point | 57.1 Ω - 7.3 j Ω |
| Return Loss | - 20.5 dB |

Antenna Parameters with Head TSL at 5750 MHz

| | |
|--------------------------------------|--------------------------------|
| Impedance, transformed to feed point | 59.1 Ω + 4.1 j Ω |
| Return Loss | - 20.8 dB |

Antenna Parameters with Head TSL at 5850 MHz

| | |
|--------------------------------------|--------------------------------|
| Impedance, transformed to feed point | 52.7 Ω + 0.8 j Ω |
| Return Loss | - 31.4 dB |

General Antenna Parameters and Design

| | |
|----------------------------------|----------|
| Electrical Delay (one direction) | 1.200 ns |
|----------------------------------|----------|

After long term use with 100W radiated power, only a slight warming of the dipole near the feedpoint can be measured.

The dipole is made of standard semirigid coaxial cable. The center conductor of the feeding line is directly connected to the second arm of the dipole. The antenna is therefore short-circuited for DC-signals. On some of the dipoles, small end caps are added to the dipole arms in order to improve matching when loaded according to the position as explained in the "Measurement Conditions" paragraph. The SAR data are not affected by this change. The overall dipole length is still according to the Standard.

No excessive force must be applied to the dipole arms, because they might bend or the soldered connections near the feedpoint may be damaged.

Additional EUT Data

| | |
|-----------------|-------|
| Manufactured by | SPEAG |
|-----------------|-------|

DASY5 Validation Report for Head TSL

Date: 25.05.2023

Test Laboratory: SPEAG, Zurich, Switzerland

DUT: Dipole D5GHzV2; Type: D5GHzV2; Serial: D5GHzV2 - SN:1006

Communication System: UID 0 - CW; Frequency: 5250 MHz, Frequency: 5600 MHz, Frequency: 5750 MHz, Frequency: 5850 MHz

Medium parameters used: $f = 5250$ MHz; $\sigma = 4.6$ S/m; $\epsilon_r = 34.8$; $\rho = 1000$ kg/m³,

Medium parameters used: $f = 5600$ MHz; $\sigma = 4.97$ S/m; $\epsilon_r = 34.6$; $\rho = 1000$ kg/m³,

Medium parameters used: $f = 5750$ MHz; $\sigma = 5.08$ S/m; $\epsilon_r = 34.4$; $\rho = 1000$ kg/m³,

Medium parameters used: $f = 5850$ MHz; $\sigma = 5.15$ S/m; $\epsilon_r = 34.2$; $\rho = 1000$ kg/m³

Phantom section: Flat Section

Measurement Standard: DASY5 (IEEE/IEC/ANSI C63.19-2011)

DASY52 Configuration:

- Probe: EX3DV4 - SN3503; ConvF(5.5, 5.5, 5.5) @ 5250 MHz, ConvF(5.1, 5.1, 5.1) @ 5600 MHz, ConvF(5.08, 5.08, 5.08) @ 5750 MHz, ConvF(4.99, 4.99, 4.99) @ 5850 MHz; Calibrated: 07.03.2023
- Sensor-Surface: 1.4mm (Mechanical Surface Detection)
- Electronics: DAE4 Sn601; Calibrated: 19.12.2022
- Phantom: Flat Phantom 5.0 (front); Type: QD000P50AA; Serial: 1001
- DASY52 52.10.4(1535); SEMCAD X 14.6.14(7501)

Dipole Calibration for Head Tissue/Pin=100mW, dist=10mm, f=5250 MHz/Zoom Scan, dist=1.4mm (8x8x7)/Cube 0:

Measurement grid: dx=4mm, dy=4mm, dz=1.4mm

Reference Value = 76.81 V/m; Power Drift = -0.05 dB

Peak SAR (extrapolated) = 27.7 W/kg

SAR(1 g) = 8.18 W/kg; SAR(10 g) = 2.34 W/kg

Smallest distance from peaks to all points 3 dB below = 7.2 mm

Ratio of SAR at M2 to SAR at M1 = 71.2%

Maximum value of SAR (measured) = 18.5 W/kg

Dipole Calibration for Head Tissue/Pin=100mW, dist=10mm, f=5600 MHz/Zoom Scan, dist=1.4mm (8x8x7)/Cube 0:

Measurement grid: dx=4mm, dy=4mm, dz=1.4mm

Reference Value = 75.46 V/m; Power Drift = 0.09 dB

Peak SAR (extrapolated) = 31.1 W/kg

SAR(1 g) = 8.52 W/kg; SAR(10 g) = 2.44 W/kg

Smallest distance from peaks to all points 3 dB below = 7.4 mm

Ratio of SAR at M2 to SAR at M1 = 68.6%

Maximum value of SAR (measured) = 19.8 W/kg

Dipole Calibration for Head Tissue/Pin=100mW, dist=10mm, f=5750 MHz/Zoom Scan,

dist=1.4mm (8x8x7)/Cube 0: Measurement grid: dx=4mm, dy=4mm, dz=1.4mm

Reference Value = 73.42 V/m; Power Drift = 0.09 dB

Peak SAR (extrapolated) = 31.5 W/kg

SAR(1 g) = 8.15 W/kg; SAR(10 g) = 2.31 W/kg

Smallest distance from peaks to all points 3 dB below = 7.4 mm

Ratio of SAR at M2 to SAR at M1 = 66.8%

Maximum value of SAR (measured) = 19.3 W/kg

Dipole Calibration for Head Tissue/Pin=100mW, dist=10mm, f=5850 MHz/Zoom Scan,

dist=1.4mm (8x8x7)/Cube 0: Measurement grid: dx=4mm, dy=4mm, dz=1.4mm

Reference Value = 73.29 V/m; Power Drift = 0.06 dB

Peak SAR (extrapolated) = 32.6 W/kg

SAR(1 g) = 8.24 W/kg; SAR(10 g) = 2.34 W/kg

Smallest distance from peaks to all points 3 dB below = 7.4 mm

Ratio of SAR at M2 to SAR at M1 = 65.8%

Maximum value of SAR (measured) = 20.0 W/kg

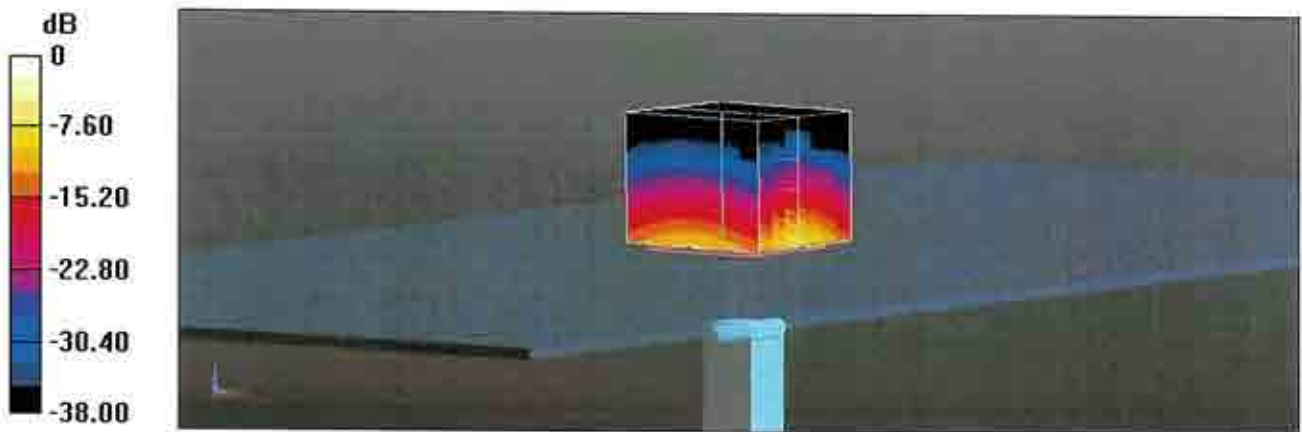

0 dB = 20.0 W/kg = 13.01 dBW/kg

Impedance Measurement Plot for Head TSL

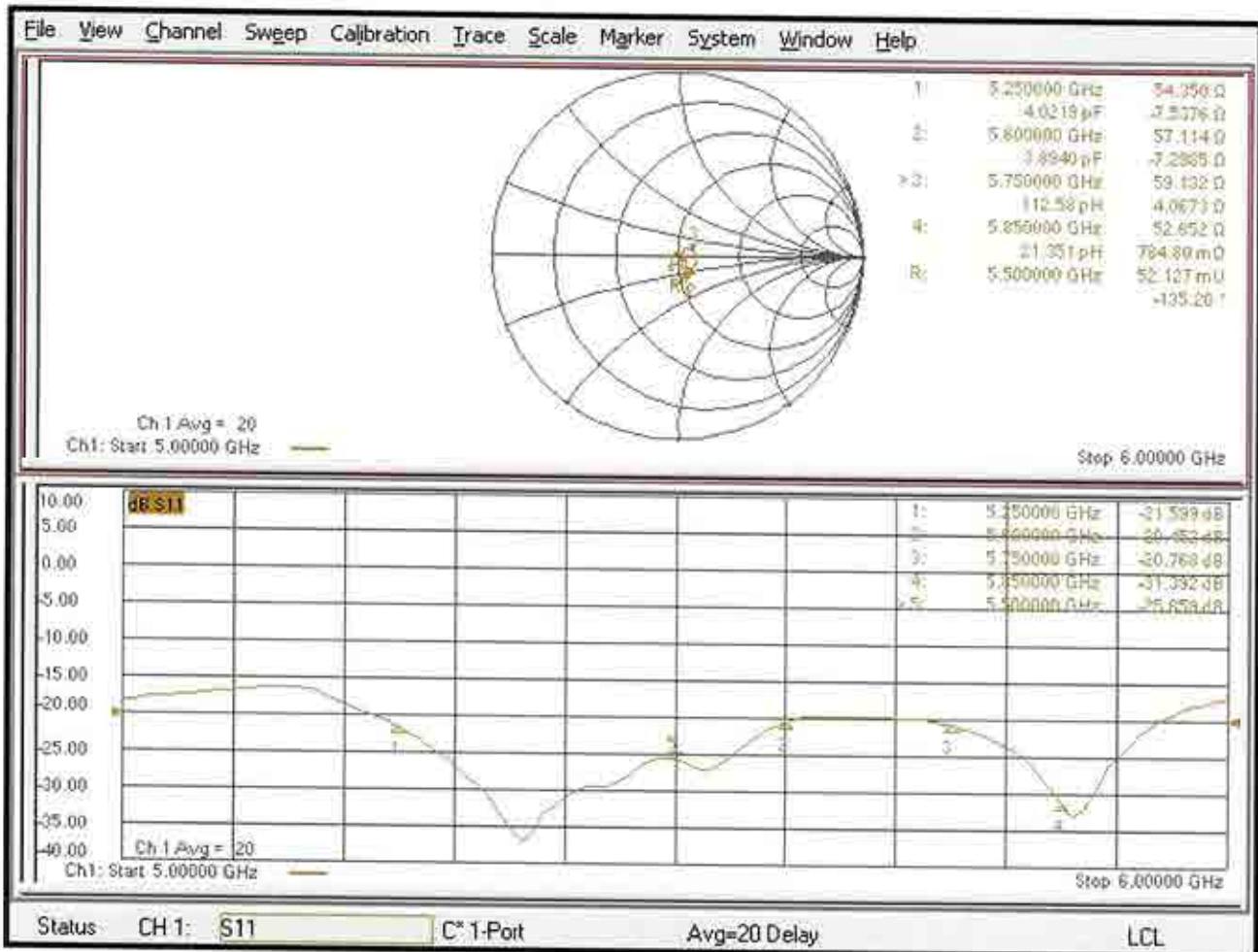



Accredited by the Swiss Accreditation Service (SAS)
The Swiss Accreditation Service is one of the signatories to the EA
Multilateral Agreement for the recognition of calibration certificates

Accreditation No.: **SCS 0108**

Client **Sporton**

Certificate No: **D5GHzV2-1171_Apr21**

CALIBRATION CERTIFICATE

Object **D5GHzV2 - SN:1171**

Calibration procedure(s) **QA CAL-22.v6
Calibration Procedure for SAR Validation Sources between 3-10 GHz**

Calibration date: **April 20, 2021**

This calibration certificate documents the traceability to national standards, which realize the physical units of measurements (SI).
The measurements and the uncertainties with confidence probability are given on the following pages and are part of the certificate.

All calibrations have been conducted in the closed laboratory facility: environment temperature (22 ± 3)°C and humidity < 70%.

Calibration Equipment used (M&TE critical for calibration)

| Primary Standards | ID # | Cal Date (Certificate No.) | Scheduled Calibration |
|-----------------------------|--------------------|---------------------------------|-----------------------|
| Power meter NRP | SN: 104778 | 09-Apr-21 (No. 217-03291/03292) | Apr-22 |
| Power sensor NRP-Z91 | SN: 103244 | 09-Apr-21 (No. 217-03291) | Apr-22 |
| Power sensor NRP-Z91 | SN: 103245 | 09-Apr-21 (No. 217-03292) | Apr-22 |
| Reference 20 dB Attenuator | SN: BH9394 (20k) | 09-Apr-21 (No. 217-03343) | Apr-22 |
| Type-N mismatch combination | SN: 310982 / 06327 | 09-Apr-21 (No. 217-03344) | Apr-22 |
| Reference Probe EX3DV4 | SN: 3503 | 30-Dec-20 (No. EX3-3503_Dec20) | Dec-21 |
| DAE4 | SN: 601 | 02-Nov-20 (No. DAE4-601_Nov20) | Nov-21 |

| Secondary Standards | ID # | Check Date (in house) | Scheduled Check |
|---------------------------------|----------------|-----------------------------------|------------------------|
| Power meter E4419B | SN: GB39512475 | 30-Oct-14 (in house check Oct-20) | In house check: Oct-22 |
| Power sensor HP 8481A | SN: US37292783 | 07-Oct-15 (in house check Oct-20) | In house check: Oct-22 |
| Power sensor HP 8481A | SN: MY41092317 | 07-Oct-15 (in house check Oct-20) | In house check: Oct-22 |
| RF generator R&S SMT-06 | SN: 100972 | 15-Jun-15 (in house check Oct-20) | In house check: Oct-22 |
| Network Analyzer Agilent E8358A | SN: US41080477 | 31-Mar-14 (in house check Oct-20) | In house check: Oct-21 |

| | | | |
|----------------|------------------------------|-----------------------------------|---------------|
| Calibrated by: | Name Michael Weber | Function Laboratory Technician | Signature |
| Approved by: | Name Katja Pokovic | Technical Manager | |

Issued: April 20, 2021

This calibration certificate shall not be reproduced except in full without written approval of the laboratory.