



FCC RF Test Report

APPLICANT : Google LLC
EQUIPMENT : Wireless Device
MODEL NAME : G4SKY
FCC ID : A4RG4SKY
STANDARD : 47 CFR Part 2, 22(H), 24(E), 27(L), 27(H), 27(F), 27(N)
CLASSIFICATION : PCS Licensed Transmitter (PCB)
TEST DATE(S) : Jul. 28, 2023 ~ Jan. 23, 2024

We, Sporton International Inc. (Kunshan), would like to declare that the tested sample has been evaluated in accordance with the procedures given in ANSI C63.26-2015 and shown compliance with the applicable technical standards.

The test results in this report apply exclusively to the tested model / sample. Without written approval of Sporton International Inc. (Kunshan), the test report shall not be reproduced except in full.

Jason Jia

Approved by: Jason Jia



Sporton International Inc. (Kunshan)

**No. 1098, Pengxi North Road, Kunshan Economic Development Zone Jiangsu Province 215300
People's Republic of China**



TABLE OF CONTENTS

REVISION HISTORY 3
SUMMARY OF TEST RESULT 4
1 GENERAL DESCRIPTION 5
1.1 Applicant 5
1.2 Product Feature of Equipment Under Test 5
1.3 Product Specification of Equipment Under Test 5
1.4 Modification of EUT 6
1.5 Maximum ERP/EIRP Power and Emission Designator 7
1.6 Testing Location 10
1.7 Test Software 10
1.8 Applicable Standards 10
2 TEST CONFIGURATION OF EQUIPMENT UNDER TEST 11
2.1 Test Mode 11
2.2 Connection Diagram of Test System 14
2.3 Support Unit used in test configuration and system 14
2.4 Measurement Results Explanation Example 14
2.5 Frequency List of Low/Middle/High Channels 15
3 CONDUCTED TEST ITEMS 20
3.1 Measuring Instruments 20
3.2 Test Setup 20
3.3 Test Result of Conducted Test 20
3.4 Conducted Output Power and ERP/EIRP 21
3.5 Peak-to-Average Ratio 22
3.6 Occupied Bandwidth 23
3.7 Conducted Band Edge 24
3.8 Conducted Spurious Emission 26
3.9 Frequency Stability 27
4 RADIATED TEST ITEMS 28
4.1 Measuring Instruments 28
4.2 Test Setup 28
4.3 Test Result of Radiated Test 29
4.4 Radiated Spurious Emission 30
5 LIST OF MEASURING EQUIPMENT 31
6 MEASUREMENT UNCERTAINTY 32
APPENDIX A. TEST RESULTS OF CONDUCTED TEST
APPENDIX B. TEST RESULTS OF RADIATED TEST



SUMMARY OF TEST RESULT

Report Section	FCC Rule	Description	Limit	Result	Remark
3.4	§2.1046	Conducted Output Power	-	Report Only	-
	§22.913(a)(5)	Effective Radiated Power (Band 5) (Band 26)	ERP < 7 Watt	PASS	-
	§27.50(b)(10) §27.50(c)(10)	Effective Radiated Power (Band 12) (Band 13) (Band 17) (Band 71)	ERP < 3 Watt		-
	§24.232(c) §27.50(h)(2)	Equivalent Isotropic Radiated Power (Band 2) (Band 25)	EIRP < 2Watt		-
	§27.50(d)(4)	Equivalent Isotropic Radiated Power (Band 4) (Band 66)	EIRP < 1Watt		-
3.5	§24.232(d)	Peak-to-Average Ratio	<13 dB	PASS	-
3.6	§2.1049	Occupied Bandwidth	-	Report Only	-
3.7	§2.1051 §22.917(a) §24.238(a) §27.53(c)(2)(4) §27.53(g) §27.53(h)	Conducted Band Edge Measurement (Band 2) (Band 4) (Band 5) (Band 12) (Band 13) (Band 17) (Band 25) (Band 26) (Band 66) (Band 71)	< 43+10log10(P[Watts])	PASS	-
3.8	§2.1051 §22.917(a) §24.238(a) §27.53(c)(2) §27.53(g) §27.53(h)	Conducted Spurious Emission (Band 2) (Band 4) (Band 5) (Band 12) (Band 13) (Band 17) (Band 25) (Band 26) (Band 66) (Band 71)	< 43+10log10(P[Watts])	PASS	-
3.9	§2.1055 §22.355	Frequency Stability Temperature & Voltage	< 2.5 ppm for Part 22	PASS	-
	§2.1055 §24.235 §27.54		Within Authorized Band		
4.4	§2.1053 §22.917(a) §24.238(a) §27.53(c)(2) §27.53(f) §27.53(g) §27.53(h)	Radiated Spurious Emission (Band 2) (Band 4) (Band 5) (Band 12) (Band 13) (Band 17) (Band 25) (Band 26) (Band 66) (Band 71)	< 43+10log10(P[Watts])	PASS	Under limit 10.46 dB at 1568.00 MHz

Conformity Assessment Condition:

- The test results (PASS/FAIL) with all measurement uncertainty excluded are presented against the regulation limits or in accordance with the requirements stipulated by the applicant/manufacture who shall bear all the risks of non-compliance that may potentially occur if measurement uncertainty is taken into account.
- The measurement uncertainty please refer to each test result in the section "Measurement Uncertainty"

Disclaimer:

The product specifications of the EUT presented in the test report that may affect the test assessments are declared by the manufacturer who shall take full responsibility for the authenticity.



1 General Description

1.1 Applicant

Google LLC

1600 Amphitheatre Parkway, Mountain View, California, 94043 USA

1.2 Product Feature of Equipment Under Test

Product Feature	
Equipment	Wireless Device
Model Name	G4SKY
FCC ID	A4RG4SKY
S/N Code	Conducted: 0GB65008640053236810069 Radiation: 3C211LTK0N0148

1.3 Product Specification of Equipment Under Test

Standards-related Product Specification	
Tx Frequency	LTE Band 2 : 1850 MHz ~ 1910 MHz LTE Band 4 : 1710 MHz ~ 1755 MHz LTE Band 5 : 824 MHz ~ 849 MHz LTE Band 12 : 699 MHz ~ 716 MHz LTE Band 13 : 777 MHz ~ 787 MHz LTE Band 17 : 704 MHz ~ 716 MHz LTE Band 25 : 1850 MHz ~ 1915 MHz LTE Band 26 : 824 MHz ~ 849 MHz LTE Band 66 : 1710 MHz ~ 1780 MHz LTE Band 71: 663 MHz ~ 698 MHz
Rx Frequency	LTE Band 2 : 1930 MHz ~ 1990 MHz LTE Band 4 : 2110 MHz ~ 2155 MHz LTE Band 5 : 869 MHz ~ 894 MHz LTE Band 12 : 729 MHz ~ 746 MHz LTE Band 13 : 746 MHz ~ 756 MHz LTE Band 17 : 734 MHz ~ 746 MHz LTE Band 25 : 1930 MHz ~ 1995 MHz LTE Band 26 : 869 MHz ~ 894 MHz LTE Band 66 : 2110 MHz ~ 2180 MHz LTE Band 71: 617 MHz ~ 652 MHz
Bandwidth	LTE Band 2 : 1.4MHz / 3MHz / 5MHz / 10MHz / 15MHz / 20MHz LTE Band 4 : 1.4MHz / 3MHz / 5MHz / 10MHz / 15MHz / 20MHz LTE Band 5 : 1.4MHz / 3MHz / 5MHz / 10MHz LTE Band 12 : 1.4MHz / 3MHz / 5MHz / 10MHz LTE Band 13 : 5MHz / 10MHz LTE Band 17 : 5MHz / 10MHz LTE Band 25 : 1.4MHz / 3MHz / 5MHz / 10MHz / 15MHz / 20MHz LTE Band 26 : 1.4MHz / 3MHz / 5MHz / 10MHz / 15MHz LTE Band 66 : 1.4MHz / 3MHz / 5MHz / 10MHz / 15MHz / 20MHz LTE Band 71 : 5MHz / 10MHz / 15MHz / 20MHz
Maximum Output Power to Antenna	<Ant. 0> LTE Band 5 : 24.31 dBm LTE Band 12 : 24.11 dBm



	LTE Band 13 : 24.47 dBm LTE Band 17 : 24.10 dBm LTE Band 26 : 24.55 dBm LTE Band 71 : 24.03 dBm <Ant. 1> LTE Band 2 : 24.23 dBm LTE Band 4 : 24.59 dBm LTE Band 25 : 24.24 dBm LTE Band 66 : 24.62 dBm
Antenna Gain	<Ant. 0> LTE Band 5 : -11.3 dBi LTE Band 12 : -13.0 dBi LTE Band 13 : -12.6 dBi LTE Band 17 : -13.2 dBi LTE Band 26 : -11.3 dBi LTE Band 71 : -13.3 dBi <Ant. 1> LTE Band 2 : -4.1 dBi LTE Band 4 : -5.2 dBi LTE Band 25 : -4.1 dBi LTE Band 66 : -4.9 dBi
Type of Modulation	QPSK / 16QAM

1.4 Modification of EUT

No modifications are made to the EUT during all test items.



1.5 Maximum ERP/EIRP Power and Emission Designator

LTE Band 2		QPSK		16QAM	
BW (MHz)	Frequency Range (MHz)	Maximum EIRP(W)	Emission Designator (99%OBW)	Maximum EIRP(W)	Emission Designator (99%OBW)
1.4	1850.7 ~ 1909.3	0.1002	1M10G7D	0.0789	1M09W7D
3	1851.5 ~ 1908.5	0.1005	2M73G7D	0.0776	2M72W7D
5	1852.5 ~ 1907.5	0.1009	4M49G7D	0.0774	4M49W7D
10	1855.0 ~ 1905.0	0.1000	8M99G7D	0.0771	9M05W7D
15	1857.5 ~ 1902.5	0.0998	13M5G7D	0.0785	13M5W7D
20	1860.0 ~ 1900.0	0.1030	17M9G7D	0.0804	18M0W7D
LTE Band 25		QPSK		16QAM	
BW (MHz)	Frequency Range (MHz)	Maximum EIRP(W)	Emission Designator (99%OBW)	Maximum EIRP(W)	Emission Designator (99%OBW)
1.4	1850.7 ~ 1914.3	0.1000	1M10G7D	0.0757	1M09W7D
3	1851.5 ~ 1913.5	0.1014	2M73G7D	0.0757	2M72W7D
5	1852.5 ~ 1912.5	0.0998	4M49G7D	0.0762	4M49W7D
10	1855.0 ~ 1910.0	0.0979	8M99G7D	0.0782	9M05W7D
15	1857.5 ~ 1907.5	0.1016	13M5G7D	0.0782	13M5W7D
20	1860.0 ~ 1905.0	0.1033	17M9G7D	0.0798	18M0W7D
LTE Band 4		QPSK		16QAM	
BW (MHz)	Frequency Range (MHz)	Maximum EIRP(W)	Emission Designator (99%OBW)	Maximum EIRP(W)	Emission Designator (99%OBW)
1.4	1710.7 ~ 1754.3	0.0839	1M09G7D	0.0632	1M10W7D
3	1711.5 ~ 1753.5	0.0847	2M72G7D	0.0604	2M72W7D
5	1712.5 ~ 1752.5	0.0838	4M50G7D	0.0628	4M49W7D
10	1715.0 ~ 1750.0	0.0847	9M13G7D	0.0605	9M03W7D
15	1717.5 ~ 1747.5	0.0836	13M5G7D	0.0608	13M5W7D
20	1720.0 ~ 1745.0	0.0869	17M9G7D	0.0635	17M9W7D
LTE Band 66		QPSK		16QAM	
BW (MHz)	Frequency Range (MHz)	Maximum EIRP(W)	Emission Designator (99%OBW)	Maximum EIRP(W)	Emission Designator (99%OBW)
1.4	1710.7 ~ 1779.3	0.0891	1M09G7D	0.0708	1M10W7D
3	1711.5 ~ 1778.5	0.0897	2M72G7D	0.0690	2M72W7D
5	1712.5 ~ 1777.5	0.0918	4M50G7D	0.0697	4M49W7D
10	1715.0 ~ 1775.0	0.0912	9M13G7D	0.0698	9M03W7D
15	1717.5 ~ 1772.5	0.0931	13M5G7D	0.0716	13M5W7D
20	1720.0 ~ 1770.0	0.0938	17M9G7D	0.0723	17M9W7D



LTE Band 5		QPSK		16QAM	
BW (MHz)	Frequency Range (MHz)	Maximum ERP(W)	Emission Designator (99%OBW)	Maximum ERP(W)	Emission Designator (99%OBW)
1.4	824.7 ~ 848.3	0.0116	1M10G7D	0.0095	1M10W7D
3	825.5 ~ 847.5	0.0120	2M71G7D	0.0092	2M73W7D
5	826.5 ~ 846.5	0.0117	4M50G7D	0.0093	4M48W7D
10	829.0 ~ 844.0	0.0122	9M07G7D	0.0097	9M01W7D
LTE Band 26		QPSK		16QAM	
BW (MHz)	Frequency Range (MHz)	Maximum ERP(W)	Emission Designator (99%OBW)	Maximum ERP(W)	Emission Designator (99%OBW)
1.4	824.7 ~ 848.3	0.0124	1M10G7D	0.0097	1M10W7D
3	825.5 ~ 847.5	0.0126	2M71G7D	0.0099	2M73W7D
5	826.5 ~ 846.5	0.0123	4M50G7D	0.0099	4M48W7D
10	829.0 ~ 844.0	0.0123	9M07G7D	0.0099	9M01W7D
15	831.5 ~ 841.5	0.0129	13M4G7D	0.0101	13M5W7D
CH26790	824.0	0.0123	13M5G7D	0.0096	13M5W7D
LTE Band 12		QPSK		16QAM	
BW (MHz)	Frequency Range (MHz)	Maximum ERP(W)	Emission Designator (99%OBW)	Maximum ERP(W)	Emission Designator (99%OBW)
1.4	699.7 ~ 715.3	0.0078	1M11G7D	0.0056	1M10W7D
3	700.5 ~ 714.5	0.0075	2M73G7D	0.0056	2M72W7D
5	701.5 ~ 713.5	0.0075	4M52G7D	0.0057	4M49W7D
10	704.0 ~ 711.0	0.0079	9M05G7D	0.0058	9M01W7D
LTE Band 13		QPSK		16QAM	
BW (MHz)	Frequency Range (MHz)	Maximum ERP(W)	Emission Designator (99%OBW)	Maximum ERP(W)	Emission Designator (99%OBW)
5	779.5 ~ 784.5	0.0091	4M51G7D	0.0073	4M48W7D
10	782.0	0.0094	9M03G7D	0.0073	9M03W7D
LTE Band 17		QPSK		16QAM	
BW (MHz)	Frequency Range (MHz)	Maximum ERP(W)	Emission Designator (99%OBW)	Maximum ERP(W)	Emission Designator (99%OBW)
5	706.5 ~ 713.5	0.0075	4M52G7D	0.0060	4M49W7D
10	709.0 ~ 711.0	0.0075	9M05G7D	0.0061	9M01W7D



LTE Band 71		QPSK		16QAM	
BW (MHz)	Frequency Range (MHz)	Maximum ERP(W)	Emission Designator (99%OBW)	Maximum ERP(W)	Emission Designator (99%OBW)
5	665.5 ~ 695.5	0.0072	4M48G7D	0.0059	4M50W7D
10	668.0 ~ 693.0	0.0069	8M99G7D	0.0059	9M01W7D
15	670.5 ~ 690.5	0.0069	13M4G7D	0.0060	13M5W7D
20	673.0 ~ 688.0	0.0072	17M8G7D	0.0061	17M8W7D

Note:

1. LTE Band 26 overlaps the entire frequency range of LTE Band 5. Therefore, the test results provided in this report covers Band 5 and the portion of Band 26 subject to Part 22.
2. LTE Band 66 overlaps the entire frequency range of LTE Band 4. Therefore, the test results provided in this report covers Band 66 as well as Band 4.
3. LTE Band 25 overlaps the entire frequency range of LTE Band 2. Therefore, the test results provided in this report covers Band 25 as well as Band 2.
4. LTE Band 12 overlaps the entire frequency range of LTE Band 17. Therefore, the test results provided in this report covers Band 12 as well as Band 17.



1.6 Testing Location

Sporton International Inc. (Kunshan) is accredited to ISO/IEC 17025:2017 by American Association for Laboratory Accreditation with Certificate Number 5145.02.

Test Firm	Sporton International Inc. (Kunshan)		
Test Site Location	No. 1098, Pengxi North Road, Kunshan Economic Development Zone Jiangsu Province 215300 People's Republic of China TEL : +86-512-57900158		
Test Site No.	Sporton Site No.	FCC Designation No.	FCC Test Firm Registration No.
	03CH04-KS TH01-KS	CN1257	314309

1.7 Test Software

Item	Site	Manufacture	Name	Version
1.	TH01-KS	SPORTON	FCC LTE_Ver2.0 Auto_china_210503	2.0
2.	03CH04-KS	AUDIX	E3	210616

1.8 Applicable Standards

According to the specifications of the manufacturer, the EUT must comply with the requirements of the following standards:

- 47 CFR Part 2, 22(H), 24(E), 27(L), 27(H), 27(F), 27(N)
- ANSI C63.26-2015
- FCC KDB 971168 D01 Power Meas License Digital Systems v03r01
- FCC KDB 971168 D02 Misc Rev Approv License Devices v02r02
- FCC KDB 412172 D01 Determining ERP and EIRP v01r01

Remark: All test items were verified and recorded according to the standards and without any deviation during the test.



2 Test Configuration of Equipment Under Test

2.1 Test Mode

Antenna port conducted and radiated test items listed below are performed according to KDB 971168 D01 Power Meas License Digital Systems v03r01 with maximum output power.

Radiated measurements are performed by rotating the EUT in three different orthogonal test planes to find the maximum emission.

Test Items	Band	Bandwidth (MHz)						Modulation			RB #			Test Channel		
		1.4	3	5	10	15	20	QPSK	16QAM	64QAM	1	Half	Full	L	M	H
Max. Output Power	2	v	v	v	v	v	v	v	v	-	v		v	v	v	v
	4	v	v	v	v	v	v	v	v	-	v		v	v	v	v
	5	v	v	v	v	-	-	v	v	-	v		v	v	v	v
	12	v	v	v	v	-	-	v	v	-	v		v	v	v	v
	13	-	-	v	v	-	-	v	v	-	v		v	v	v	v
	17	-	-	v	v	-	-	v	v	-	v		v	v	v	v
	25	v	v	v	v	v	v	v	v	-	v		v	v	v	v
	26	v	v	v	v	v	-	v	v	-	v		v	v	v	v
	66	v	v	v	v	v	v	v	v	-	v		v	v	v	v
	71	-	-	v	v	v	v	v	v	-	v		v	v	v	v
Peak-to-Average Ratio	12				v	-	-	v	v	-			v		v	
	13	-	-		v	-	-	v	v	-			v		v	
	25						v	v	v	-			v		v	
	26					v	-	v	v	-			v		v	
	66						v	v	v	-			v		v	
	71	-	-				v	v	v	-			v		v	



Test Items	Band	Bandwidth (MHz)						Modulation			RB #			Test Channel		
		1.4	3	5	10	15	20	QPSK	16QAM	64QAM	1	Half	Full	L	M	H
26dB and 99% Bandwidth	12	v	v	v	v	-	-	v	v	-			v		v	
	13	-	-	v	v	-	-	v	v	-			v		v	
	25	v	v	v	v	v	v	v	v	-			v		v	
	26	v	v	v	v	v	-	v	v	-			v		v	
	66	v	v	v	v	v	v	v	v	-			v		v	
	71	-	-	v	v	v	v	v	v	-			v		v	
Conducted Band Edge	12	v	v	v	v	-	-	v	v	-	v		v	v		v
	13	-	-	v	v	-	-	v	v	-	v		v	v		v
	25	v	v	v	v	v	v	v	v	-	v		v	v		v
	26	v	v	v	v	v	-	v	v	-	v		v	v		v
	66	v	v	v	v	v	v	v	v	-	v		v	v		v
	71	-	-	v	v	v	v	v	v	-	v		v	v		v
Conducted Spurious Emission	12	v	v	v	v	-	-	v		-	v			v	v	v
	13	-	-	v	v	-	-	v		-	v			v	v	v
	25	v	v	v	v	v	v	v		-	v			v	v	v
	26	v	v	v	v	v	-	v		-	v			v	v	v
	66	v	v	v	v	v	v	v		-	v			v	v	v
	71	-	-	v	v	v	v	v		-	v			v	v	v
Frequency Stability	12				v	-	-	v		-			v		v	
	13	-	-		v	-	-	v		-			v		v	
	25				v			v		-			v		v	
	26				v		-	v		-			v		v	
	66				v			v		-			v		v	
	71	-	-		v			v		-			v		v	



Test Items	Band	Bandwidth (MHz)						Modulation			RB #			Test Channel		
		1.4	3	5	10	15	20	QPSK	16QAM	64QAM	1	Half	Full	L	M	H
E.R.P / E.I.R.P	2	v	v	v	v	v	v	v	v	-	v			v	v	v
	4	v	v	v	v	v	v	v	v	-	v			v	v	v
	5	v	v	v	v	-	-	v	v	-	v			v	v	v
	12	v	v	v	v	-	-	v	v	-	v			v	v	v
	13	-	-	v	v	-	-	v	v	-	v			v	v	v
	17	-	-	v	v	-	-	v	v	-	v			v	v	v
	25	v	v	v	v	v	v	v	v	-	v			v	v	v
	26	v	v	v	v	v	-	v	v	-	v			v	v	v
	66	v	v	v	v	v	v	v	v	-	v			v	v	v
	71	-	-	v	v	v	v	v	v	-	v			v	v	v
Radiated Spurious Emission	12	Worst Case											v	v	v	
	13	Worst Case											v	v	v	
	25	Worst Case											v	v	v	
	26	Worst Case											v	v	v	
	66	Worst Case											v	v	v	
	71	Worst Case											v	v	v	
Note	<ol style="list-style-type: none"> The mark "v" means that this configuration is chosen for testing The mark "-" means that this bandwidth is not supported. The device is investigated from 30MHz to 10 times of fundamental signal for radiated spurious emission test under different RB size/offset and modulations in exploratory test. Subsequently, only the worst case emissions are reported. All test items are based on engineering evaluation. 															

2.2 Connection Diagram of Test System

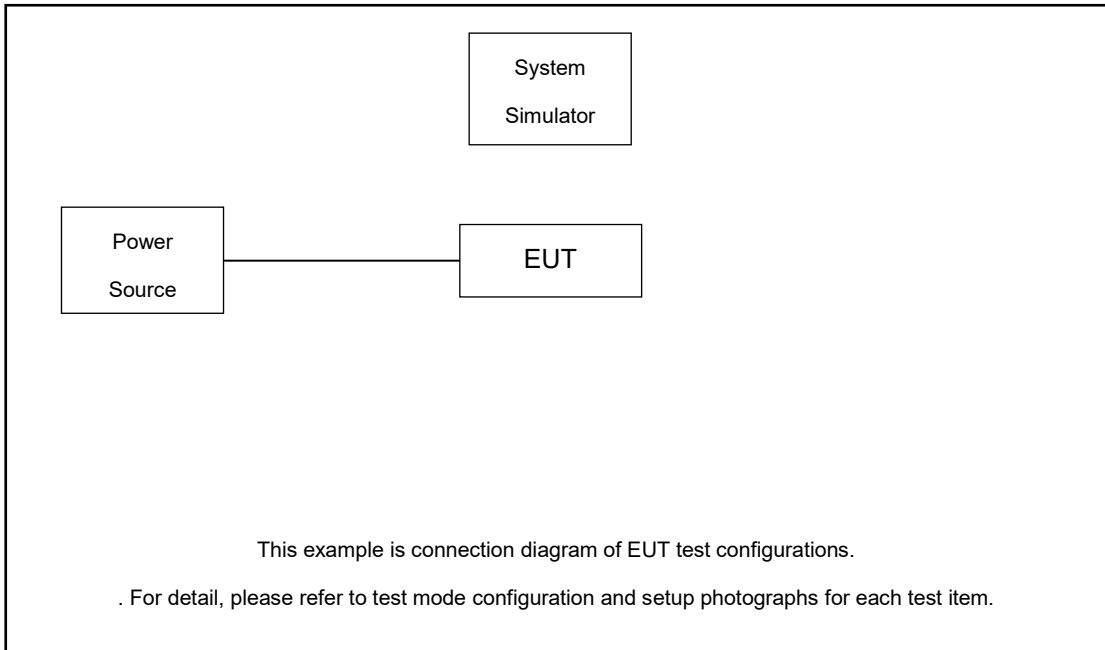

2.3 Support Unit used in test configuration and system

Item	Equipment	Trade Name	Model No.	FCC ID	Data Cable	Power Cord
1.	Power Supply	GWINSTEK	PSS-2002	N/A	N/A	Unshielded, 1.8 m
2.	LTE Base Station	Anritsu	MT8820C	N/A	N/A	Unshielded, 1.8 m
3.	AC Adapter	N/A	N/A	N/A	N/A	N/A
4.	USB Cable	N/A	N/A	N/A	N/A	shielded, 0.8 m

2.4 Measurement Results Explanation Example

For all conducted test items:

The offset level is set in the spectrum analyzer to compensate the RF cable loss and between EUT conducted output port and spectrum analyzer. With the offset compensation, the spectrum analyzer reading level is exactly the EUT RF output level.

The spectrum analyzer offset is derived from RF cable loss.

Offset = RF cable loss.

Following shows an offset computation example with cable loss 4.6 dB.

Example :

$$\begin{aligned} \text{Offset(dB)} &= \text{RF cable loss(dB)}. \\ &= 4.6 \text{ (dB)} \end{aligned}$$



2.5 Frequency List of Low/Middle/High Channels

LTE Band 2 Channel and Frequency List				
BW [MHz]	Channel/Frequency(MHz)	Lowest	Middle	Highest
20	Channel	18700	18900	19100
	Frequency	1860	1880	1900
15	Channel	18675	18900	19125
	Frequency	1857.5	1880	1902.5
10	Channel	18650	18900	19150
	Frequency	1855	1880	1905
5	Channel	18625	18900	19175
	Frequency	1852.5	1880	1907.5
3	Channel	18615	18900	19185
	Frequency	1851.5	1880	1908.5
1.4	Channel	18607	18900	19193
	Frequency	1850.7	1880	1909.3

LTE Band 4 Channel and Frequency List				
BW [MHz]	Channel/Frequency(MHz)	Lowest	Middle	Highest
20	Channel	20050	20175	20300
	Frequency	1720	1732.5	1745
15	Channel	20025	20175	20325
	Frequency	1717.5	1732.5	1747.5
10	Channel	20000	20175	20350
	Frequency	1715	1732.5	1750
5	Channel	19975	20175	20375
	Frequency	1712.5	1732.5	1752.5
3	Channel	19965	20175	20385
	Frequency	1711.5	1732.5	1753.5
1.4	Channel	19957	20175	20393
	Frequency	1710.7	1732.5	1754.3



LTE Band 5 Channel and Frequency List				
BW [MHz]	Channel/Frequency(MHz)	Lowest	Middle	Highest
10	Channel	20450	20525	20600
	Frequency	829	836.5	844
5	Channel	20425	20525	20625
	Frequency	826.5	836.5	846.5
3	Channel	20415	20525	20635
	Frequency	825.5	836.5	847.5
1.4	Channel	20407	20525	20643
	Frequency	824.7	836.5	848.3

LTE Band 12 Channel and Frequency List				
BW [MHz]	Channel/Frequency(MHz)	Lowest	Middle	Highest
10	Channel	23060	23095	23130
	Frequency	704	707.5	711
5	Channel	23035	23095	23155
	Frequency	701.5	707.5	713.5
3	Channel	23025	23095	23165
	Frequency	700.5	707.5	714.5
1.4	Channel	23017	23095	23173
	Frequency	699.7	707.5	715.3

LTE Band 13 Channel and Frequency List				
BW [MHz]	Channel/Frequency(MHz)	Lowest	Middle	Highest
10	Channel	-	23230	-
	Frequency	-	782	-
5	Channel	23205	23230	23255
	Frequency	779.5	782	784.5

LTE Band 17 Channel and Frequency List				
BW [MHz]	Channel/Frequency(MHz)	Lowest	Middle	Highest
10	Channel	23780	23790	23800
	Frequency	709	710	711
5	Channel	23755	23790	23825
	Frequency	706.5	710	713.5



LTE Band 25 Channel and Frequency List				
BW [MHz]	Channel/Frequency(MHz)	Lowest	Middle	Highest
20	Channel	26140	26340	26590
	Frequency	1860	1880	1905
15	Channel	26115	26340	26615
	Frequency	1857.5	1880	1907.5
10	Channel	26090	26340	26640
	Frequency	1855	1880	1910
5	Channel	26065	26340	26665
	Frequency	1852.5	1880	1912.5
3	Channel	26055	26340	26675
	Frequency	1851.5	1880	1913.5
1.4	Channel	26047	26340	26683
	Frequency	1850.7	1880	1914.3

LTE Band 26 Channel and Frequency List				
BW [MHz]	Channel/Frequency(MHz)	Lowest	Middle	Highest
15	Channel	26865	26915	26965
	Frequency	831.5	836.5	841.5
10	Channel	26840	26915	26990
	Frequency	829	836.5	844
5	Channel	26815	26915	27015
	Frequency	826.5	836.5	846.5
3	Channel	26805	26915	27025
	Frequency	825.5	836.5	847.5
1.4	Channel	26797	26915	27033
	Frequency	824.7	836.5	848.3



LTE Band 26-Cross Rule Channel and Frequency List				
BW [MHz]	Channel/Frequency(MHz)	Lowest	Middle	Highest
15	Channel	-	26790	-
	Frequency	-	824	-
10	Channel	-	26790	-
	Frequency	-	824	-
5	Channel	-	26790	-
	Frequency	-	824	-
3	Channel	-	26790	-
	Frequency	-	824	-
1.4	Channel	-	26790	-
	Frequency	-	824	-

LTE Band 66 Channel and Frequency List				
BW [MHz]	Channel/Frequency(MHz)	Lowest	Middle	Highest
20	Channel	132072	132322	132572
	Frequency	1720	1745	1770
15	Channel	132047	132322	132597
	Frequency	1717.5	1745	1772.5
10	Channel	132022	132322	132622
	Frequency	1715	1745	1775
5	Channel	131997	132322	132647
	Frequency	1712.5	1745	1777.5
3	Channel	131987	132322	132657
	Frequency	1711.5	1745	1778.5
1.4	Channel	131979	132322	132665
	Frequency	1710.7	1745	1779.3



LTE Band 71 Channel and Frequency List				
BW [MHz]	Channel/Frequency(MHz)	Lowest	Middle	Highest
20	Channel	133222	133322	133372
	Frequency	673.0	680.5	688.0
15	Channel	133197	133297	133397
	Frequency	670.5	680.5	690.5
10	Channel	133172	133272	133422
	Frequency	668.0	678.0	693.0
5	Channel	133147	133247	133447
	Frequency	665.5	675.5	695.5

3 Conducted Test Items

3.1 Measuring Instruments

See list of measuring instruments of this test report.

3.2 Test Setup

3.2.1 Conducted Output Power



3.2.2 Peak-to-Average Ratio, Occupied Bandwidth, Conducted Band-Edge and Conducted Spurious Emission

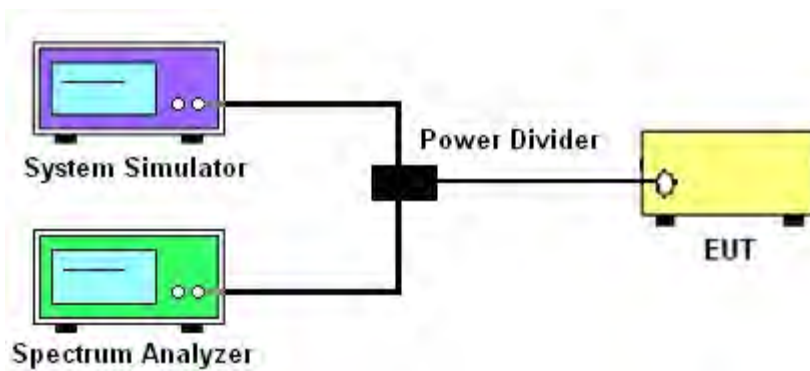

3.2.3 Frequency Stability

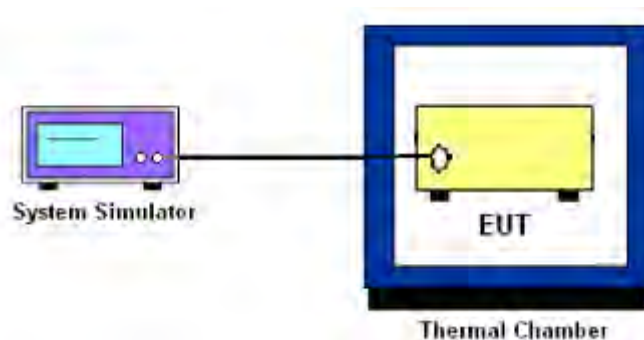

3.3 Test Result of Conducted Test

Please refer to Appendix A.



3.4 Conducted Output Power and ERP/EIRP

3.4.1 Description of the Conducted Output Power Measurement and ERP/EIRP Measurement

A system simulator was used to establish communication with the EUT. Its parameters were set to force the EUT transmitting at maximum output power. The measured power in the radio frequency on the transmitter output terminals shall be reported.

The ERP of mobile transmitters must not exceed 7 Watts for LTE Band 5 and Band 26.

The ERP of mobile transmitters must not exceed 3 Watts for LTE Band 12, Band 13 and Band 17 and Band 71.

The EIRP of mobile transmitters must not exceed 2 Watts for LTE Band 2 and Band 25.

The EIRP of mobile transmitters must not exceed 1 Watts for LTE Band 4 and Band 66.

According to KDB 412172 D01 Power Approach,

$EIRP = P_T + G_T - L_C$, $ERP = EIRP - 2.15$, where

P_T = transmitter output power in dBm

G_T = gain of the transmitting antenna in dBi

L_C = signal attenuation in the connecting cable between the transmitter and antenna in dB

3.4.2 Test Procedures

1. The testing follows ANSI C63.26 Section 5.2
2. The transmitter output port was connected to the system simulator.
3. Set EUT at maximum power through the system simulator.
4. Select lowest, middle, and highest channels for each band and different modulation.
5. Measure and record the power level from the system simulator.



3.5 Peak-to-Average Ratio

3.5.1 Description of the PAR Measurement

Power Complementary Cumulative Distribution Function (CCDF) curves provide a means for characterizing the power peaks of a digitally modulated signal on a statistical basis. A CCDF curve depicts the probability of the peak signal amplitude exceeding the average power level. Most contemporary measurement instrumentation include the capability to produce CCDF curves for an input signal provided that the instrument's resolution bandwidth can be set wide enough to accommodate the entire input signal bandwidth. In measuring transmissions in this band using an average power technique, the peak-to-average ratio (PAR) of the transmission may not exceed 13 dB.

3.5.2 Test Procedures

1. The testing follows ANSI C63.26 Section 5.2.3.4 (CCDF).
2. The EUT was connected to spectrum and system simulator via a power divider.
3. Set the CCDF (Complementary Cumulative Distribution Function) option in spectrum analyzer.
4. The highest RF powers were measured and recorded the maximum PAPR level associated with a probability of 0.1 %.
5. Record the deviation as Peak to Average Ratio.



3.6 Occupied Bandwidth

3.6.1 Description of Occupied Bandwidth Measurement

The occupied bandwidth is the width of a frequency band such that, below the lower and above the upper frequency limits, the mean powers emitted are each equal to a specified percentage 0.5% of the total mean transmitted power.

The 26 dB emission bandwidth is defined as the frequency range between two points, one above and one below the carrier frequency, at which the spectral density of the emission is attenuated 26 dB below the maximum in-band spectral density of the modulated signal. Spectral density (power per unit bandwidth) is to be measured with a detector of resolution bandwidth equal to approximately 1.0% of the emission bandwidth.

3.6.2 Test Procedures

1. The testing follows ANSI C63.26 Section 5.4
2. The EUT was connected to spectrum analyzer and system simulator via a power divider.
3. The spectrum analyzer center frequency is set to the nominal EUT channel center frequency. The span range for the spectrum analyzer shall be between two and five times the anticipated OBW.
4. The nominal resolution bandwidth (RBW) shall be in the range of 1 to 5 % of the anticipated OBW, and the VBW shall be at least 3 times the RBW.
5. Set the detection mode to peak, and the trace mode to max hold.
6. Determine the reference value: Set the EUT to transmit a modulated signal. Allow the trace to stabilize. Set the spectrum analyzer marker to the highest level of the displayed trace.
(this is the reference value)
7. Determine the “-26 dB down amplitude” as equal to (Reference Value – X).
8. Place two markers, one at the lowest and the other at the highest frequency of the envelope of the spectral display such that each marker is at or slightly below the “-X dB down amplitude” determined in step 6. If a marker is below this “-X dB down amplitude” value it shall be placed as close as possible to this value. The OBW is the positive frequency difference between the two markers.
9. Use the 99 % power bandwidth function of the spectrum analyzer and report the measured bandwidth.



3.7 Conducted Band Edge

3.7.1 Description of Conducted Band Edge Measurement

22.917(a)

For operations in the 824 – 849 MHz band, the FCC limit is $43 + 10\log_{10}(P[\text{Watts}])$ dB below the transmitter power P(Watts) in a 100kHz bandwidth. However, in the 1MHz bands immediately outside and adjacent to the licensee's frequency block, a resolution bandwidth of at least one percent of the emission bandwidth of the fundamental emission of the transmitter may be employed.

24.238 (a)

For operations in the 1850-1910 and 1930-1990 MHz band, the FCC limit is $43 + 10\log_{10}(P[\text{Watts}])$ dB below the transmitter power P(Watts) in a 1MHz bandwidth. However, in the 1 MHz bands immediately outside and adjacent to the frequency block a resolution bandwidth of at least one percent of the emission bandwidth of the fundamental emission of the transmitter may be employed.

27.53 (c)

For operations in the 776-788 MHz band, the FCC limit is $43 + 10\log_{10}(P[\text{Watts}])$ dB below the transmitter power P(Watts) in a 100 kHz bandwidth. However, in the 100 kHz bands immediately outside and adjacent to the frequency block, a resolution bandwidth of at least 30 kHz may be employed. In addition, the power of any unwanted emissions in any 6.25 kHz bandwidth for all frequencies between 763-775 MHz and 793-806 MHz shall be attenuated below the transmitter power, P (dBW), by at least $65 + 10 \log_{10} p(\text{watts})$, dB, for mobile and portable equipment.

27.53 (g)

For operations in the 600MHz band and 698 -746 MHz band, the FCC limit is $43 + 10\log_{10}(P[\text{Watts}])$ dB below the transmitter power P(Watts) in a 100 kHz bandwidth. However, in the 100 kilohertz bands immediately outside and adjacent to a licensee's frequency block, a resolution bandwidth of at least 30 kHz may be employed.

27.53 (h)

For operations in the 1710 – 1755 MHz band, the FCC limit is $43 + 10\log_{10}(P[\text{Watts}])$ dB below the transmitter power P(Watts) in a 1 MHz bandwidth. However, in the 1MHz bands immediately outside and adjacent to the licensee's frequency block, a resolution bandwidth of at least one percent of the emission bandwidth of the fundamental emission of the transmitter may be employed.



3.7.2 Test Procedures

1. The testing follows ANSI C63.26 section 5.7
2. The EUT was connected to spectrum analyzer and system simulator via a power divider.
3. The band edges of low and high channels for the highest RF powers were measured.
4. Set RBW \geq 1% EBW in the 1MHz band immediately outside and adjacent to the band edge.
5. Beyond the 1 MHz band from the band edge, RBW=1MHz was used.
6. Set spectrum analyzer with RMS detector.
7. The RF fundamental frequency should be excluded against the limit line in the operating frequency band.
8. Checked that all the results comply with the emission limit line.

Example:

The limit line is derived from $43 + 10\log(P)$ dB below the transmitter power P(Watts)
= P(W)- [43 + 10log(P)] (dB)
= [30 + 10log(P)] (dBm) - [43 + 10log(P)] (dB) = -13dBm.

9. When using the integration method, the starting frequency of the integration shall be centered at one-half of the RBW away from the band edge.



3.8 Conducted Spurious Emission

3.8.1 Description of Conducted Spurious Emission Measurement

The power of any emission outside of the authorized operating frequency ranges must be lower than the transmitter power (P) by a factor of at least $43 + 10 \log (P)$ dB.

It is measured by means of a calibrated spectrum analyzer and scanned from 30 MHz up to a frequency including its 10th harmonic.

3.8.2 Test Procedures

1. The testing follows ANSI C63.26 section 5.7
2. The EUT was connected to spectrum analyzer and system simulator via a power divider.
3. The RF output of EUT was connected to the spectrum analyzer by RF cable and attenuator. The path loss was compensated to the results for each measurement.
4. The middle channel for the highest RF power within the transmitting frequency was measured.
5. The conducted spurious emission for the whole frequency range was taken.
6. Make the measurement with the spectrum analyzer's RBW = 1MHz, VBW = 3MHz.
7. Set spectrum analyzer with RMS detector.
8. Taking the record of maximum spurious emission.
9. The RF fundamental frequency should be excluded against the limit line in the operating frequency band.
10. The limit line is derived from $43 + 10\log(P)$ dB below the transmitter power P(Watts)
= $P(W) - [43 + 10\log(P)]$ (dB)
= $[30 + 10\log(P)]$ (dBm) - $[43 + 10\log(P)]$ (dB)
= -13dBm.



3.9 Frequency Stability

3.9.1 Description of Frequency Stability Measurement

The frequency stability shall be measured by variation of ambient temperature and variation of primary supply voltage to ensure that the fundamental emission stays within the authorized frequency block. The frequency stability of the transmitter shall be maintained within $\pm 0.00025\%$ ($\pm 2.5\text{ppm}$) of the center frequency.

3.9.2 Test Procedures for Temperature Variation

1. The testing follows ANSI C63.26 section 5.6.4
2. The EUT was set up in the thermal chamber and connected with the system simulator.
3. With power OFF, the temperature was decreased to -30°C and the EUT was stabilized before testing. Power was applied and the maximum change in frequency was recorded within one minute.
4. With power OFF, the temperature was raised in 10°C step up to 50°C . The EUT was stabilized at each step for at least half an hour. Power was applied and the maximum frequency change was recorded within one minute.

3.9.3 Test Procedures for Voltage Variation

1. The testing follows ANSI C63.26 section 5.6.5
2. The EUT was placed in a temperature chamber at $20\pm 5^{\circ}\text{C}$ and connected with the system simulator.
3. The power supply voltage to the EUT was varied from 85% to 115% of the nominal value for other than hand carried battery equipment.
4. For hand carried, battery powered equipment, reduce the primary ac or dc supply voltage to the battery operating end point, which shall be specified by the manufacturer.
5. The variation in frequency was measured for the worst case.

4 Radiated Test Items

4.1 Measuring Instruments

See list of measuring instruments of this test report.

4.2 Test Setup

4.2.1 For radiated test below 30MHz

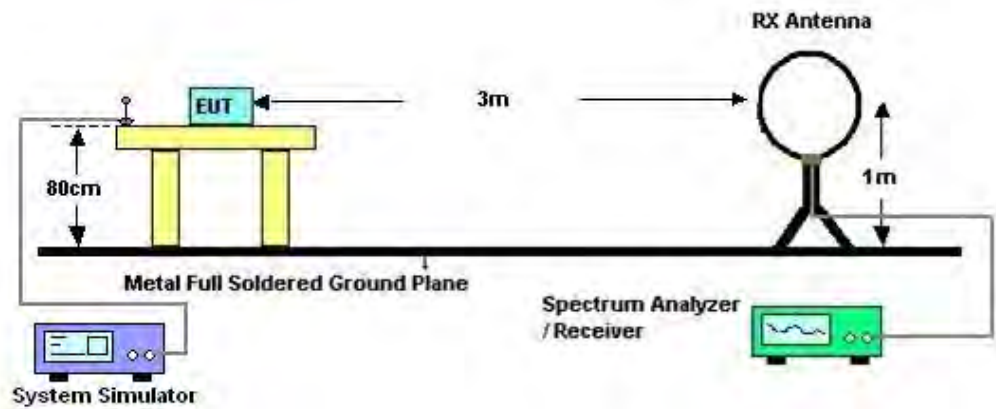

4.2.2 For radiated test from 30MHz to 1GHz

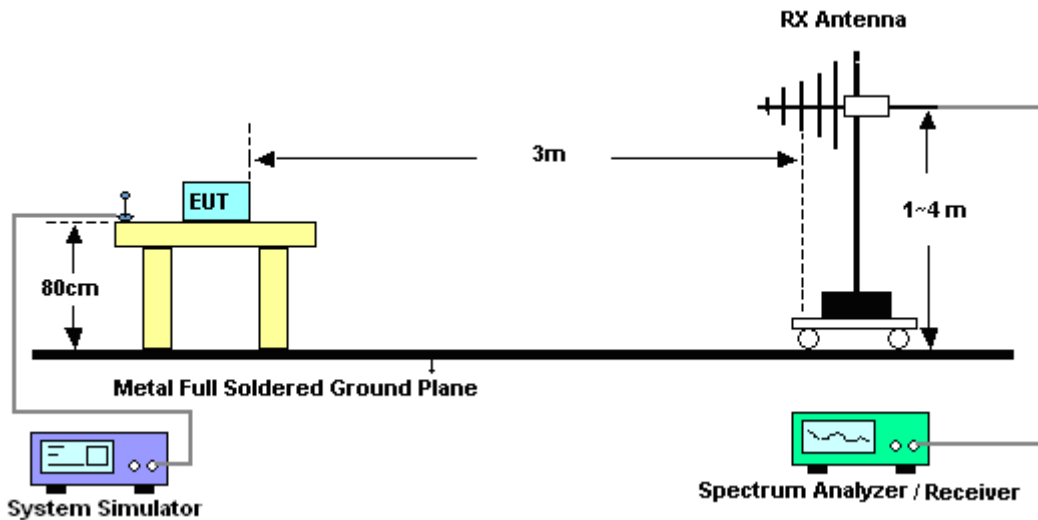

4.2.3 For radiated test above 1GHz

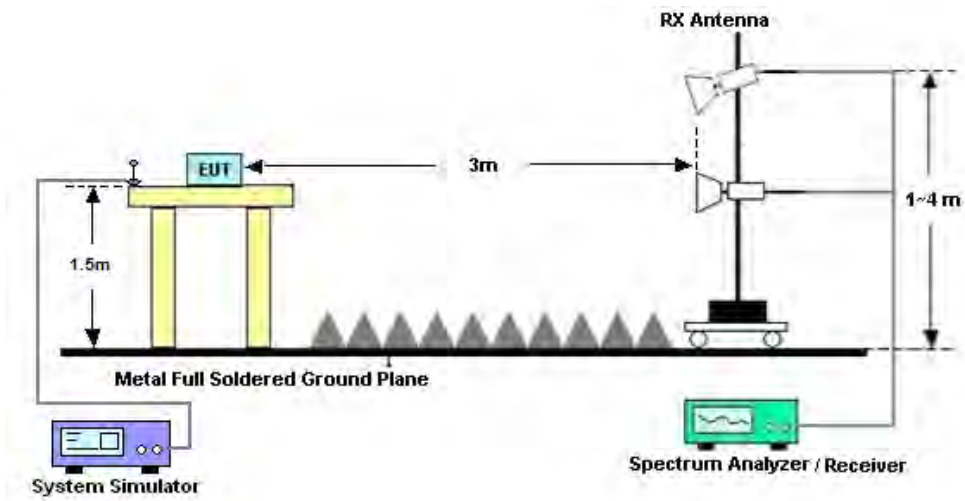

4.3 Test Result of Radiated Test

The low frequency, which started from 9 kHz to 30MHz, was pre-scanned and the result which was 20dB lower than the limit line was not reported.

Please refer to Appendix B.



4.4 Radiated Spurious Emission

4.4.1 Description of Radiated Spurious Emission

The radiated spurious emission was measured by substitution method according to ANSI C63.26. The power of any emission outside of the authorized operating frequency ranges must be attenuated below the transmitter power (P) by a factor of at least $43 + 10 \log (P)$ dB.

For LTE Band 13:

For operations in the 746-758 MHz, 775-788 MHz, and 805-806 MHz bands, emissions in the band 1559-1610 MHz shall be limited to -70 dBW/MHz equivalent isotropically radiated power (EIRP) for wideband signals, and -80 dBW EIRP for discrete emissions of less than 700 Hz bandwidth.

The spectrum is scanned from 30 MHz up to a frequency including its 10th harmonic.

4.4.2 Test Procedures

1. The testing follows ANSI C63.26 Section 5.5
2. The EUT was placed on a turntable with 0.8 meter height for frequency below 1GHz and 1.5 meter height for frequency above 1GHz respectively above ground.
3. The EUT was set 3 meters from the receiving antenna mounted on the antenna tower.
4. The table was rotated 360 degrees to determine the position of the highest spurious emission.
5. The height of the receiving antenna is varied between 1m to 4m to search the maximum spurious emission for both horizontal and vertical polarizations.
6. During the measurement, the system simulator parameters were set to force the EUT transmitting at maximum output power.
7. Make the measurement with the spectrum analyzer's RBW = 1MHz, VBW = 3MHz, taking the record of maximum spurious emission.
8. A horn antenna was substituted in place of the EUT and was driven by a signal generator.
9. Tune the output power of signal generator to the same emission level with EUT maximum spurious emission.
10. $EIRP \text{ (dBm)} = S.G. \text{ Power} - Tx \text{ Cable Loss} + Tx \text{ Antenna Gain}$
11. $ERP \text{ (dBm)} = EIRP - 2.15$
12. The RF fundamental frequency should be excluded against the limit line in the operating frequency band.

The limit line is derived from $43 + 10\log(P)$ dB below the transmitter power P(Watts)
 $= P(W) - [43 + 10\log(P)] \text{ (dB)}$
 $= [30 + 10\log(P)] \text{ (dBm)} - [43 + 10\log(P)] \text{ (dB)}$
 $= -13\text{dBm}.$



5 List of Measuring Equipment

Instrument	Manufacturer	Model No.	Serial No.	Characteristics	Calibration Date	Test Date	Due Date	Remark
Spectrum Analyzer	R&S	FSV40	101040	10Hz~40GHz	Oct. 12, 2022	Jul. 28, 2023~ Jul. 30, 2023	Oct. 11, 2023	Conducted (TH01-KS)
Power divider	STI	STI08-0055	-	0.5~40GHz	NCR	Jul. 28, 2023~ Jul. 30, 2023	NCR	Conducted (TH01-KS)
Temperature & humidity chamber	Hongzhan	LP-150U	H2014011440	-40~+150°C 20%~95%RH	Jul. 06, 2023	Jul. 28, 2023~ Jul. 30, 2023	Jul. 05, 2024	Conducted (TH01-KS)
EXA Spectrum Analyzer	Keysight	N9010B	MY57471079	10Hz-44G,MAX 30dB	Oct. 10, 2023	Jan. 23, 2024	Oct. 09, 2024	Radiation (03CH04-KS)
Loop Antenna	R&S	HFH2-Z2E	101125	9kHz~30MHz	Sep. 11 2023	Jan. 23, 2024	Sep. 10, 2024	Radiation (03CH04-KS)
Bilog Antenna	TeseQ	CBL6111D	49922	30MHz-1GHz	Apr. 09, 2023	Jan. 23, 2024	Apr. 08, 2024	Radiation (03CH04-KS)
Horn Antenna	Schwarzbeck	BBHA9120D	1284	1GHz~18GHz	Oct. 10, 2023	Jan. 23, 2024	Oct. 09, 2024	Radiation (03CH04-KS)
SHF-EHF Horn	Com-power	AH-840	101070	18GHz~40GHz	Jan. 05, 2024	Jan. 23, 2024	Jan. 04, 2025	Radiation (03CH04-KS)
Amplifier	SONOMA	310N	380827	9KHz-1GHz	Jul. 06, 2023	Jan. 23, 2024	Jul. 05, 2024	Radiation (03CH04-KS)
Amplifier	MITEQ	EM18G40G GA	060728	18~40GHz	Jan. 05, 2024	Jan. 23, 2024	Jan. 04, 2025	Radiation (03CH04-KS)
high gain Amplifier	EM	EM01G18G A	060840	1Ghz-18Ghz	Oct. 10, 2023	Jan. 23, 2024	Oct. 09, 2024	Radiation (03CH04-KS)
Amplifier	Agilent	8449B	3008A02370	1Ghz-18Ghz	Oct. 10, 2023	Jan. 23, 2024	Oct. 09, 2024	Radiation (03CH04-KS)
AC Power Source	Chroma	61601	F104090004	N/A	NCR	Jan. 23, 2024	NCR	Radiation (03CH04-KS)
Turn Table	ChamPro	EM 1000-T	060762-T	0~360 degree	NCR	Jan. 23, 2024	NCR	Radiation (03CH04-KS)
Antenna Mast	ChamPro	EM 1000-A	060762-A	1 m~4 m	NCR	Jan. 23, 2024	NCR	Radiation (03CH04-KS)

NCR: No Calibration Required



6 Measurement Uncertainty

The measurement uncertainties shown below were calculated in accordance with the requirements of ANSI 63.26-2015. All the measurement uncertainty value were shown with a coverage K=2 to indicate 95% level of confidence. The measurement data show herein meets or exceeds the CISPR measurement uncertainty values specified in CISPR 16-4-2 and can be compared directly to specified limit to determine compliance.

Uncertainty of Conducted Measurement

Test Item	Uncertainty
Conducted Spurious Emission & Bandedge	±2.26 dB
Occupied Channel Bandwidth	±0.1%
Conducted Power	±0.46 dB
Peak to Average Ratio	±0.46 dB
Frequency Stability	±0.4 Hz

Uncertainty of Radiated Emission Measurement (30 MHz ~ 1000 MHz)

Measuring Uncertainty for a Level of Confidence of 95% (U = 2Uc(y))	3.82dB
---	--------

Uncertainty of Radiated Emission Measurement (1 GHz ~ 18 GHz)

Measuring Uncertainty for a Level of Confidence of 95% (U = 2Uc(y))	3.56dB
---	--------

Uncertainty of Radiated Emission Measurement (18 GHz ~ 40 GHz)

Measuring Uncertainty for a Level of Confidence of 95% (U = 2Uc(y))	3.54dB
---	--------



Appendix A. Test Results of Conducted Test

Test Engineer :	Simle Wang	Temperature :	22~23°C
		Relative Humidity :	40~42%

Conducted Output Power(Average power) and ERP/EIRP

LTE Band 2:

BW [MHz]	Modulation	RB Size	RB Offset	Power Low Ch. / Freq.	Power Middle Ch. / Freq.	Power High Ch. / Freq.	EIRP(W)		
							L	M	H
Channel				18700	18900	19100	EIRP(W)		
Frequency (MHz)				1860	1880	1900	L	M	H
20	QPSK	1	0	24.11	24.23	24.09	0.1002	0.1030	0.0998
20	QPSK	1	99	23.76	23.88	23.74	0.0925	0.0951	0.0920
20	QPSK	100	0	22.95	23.07	22.93	0.0767	0.0789	0.0764
20	16QAM	1	0	23.03	23.15	23.01	0.0782	0.0804	0.0778
Channel				18675	18900	19125	EIRP(W)		
Frequency (MHz)				1857.5	1880	1902.5	L	M	H
15	QPSK	1	0	24.01	24.09	24.02	0.0979	0.0998	0.0982
15	16QAM	1	0	22.91	23.05	22.82	0.0760	0.0785	0.0745
Channel				18650	18900	19150	EIRP(W)		
Frequency (MHz)				1855	1880	1905	L	M	H
10	QPSK	1	0	24.01	24.10	23.89	0.0979	0.1000	0.0953
10	16QAM	1	0	22.85	22.97	22.95	0.0750	0.0771	0.0767
Channel				18625	18900	19175	EIRP(W)		
Frequency (MHz)				1852.5	1880	1907.5	L	M	H
5	QPSK	1	0	24.06	24.14	23.95	0.0991	0.1009	0.0966
5	16QAM	1	0	22.99	22.92	22.86	0.0774	0.0762	0.0752
Channel				18615	18900	19185	EIRP(W)		
Frequency (MHz)				1851.5	1880	1908.5	L	M	H
3	QPSK	1	0	24.05	24.12	23.98	0.0989	0.1005	0.0973
3	16QAM	1	0	22.86	23.00	22.86	0.0752	0.0776	0.0752
Channel				18607	18900	19193	EIRP(W)		
Frequency (MHz)				1850.7	1880	1909.3	L	M	H
1.4	QPSK	1	0	24.07	24.11	23.91	0.0993	0.1002	0.0957
1.4	16QAM	1	0	22.85	23.07	22.99	0.0750	0.0789	0.0774



LTE Band 4:

BW [MHz]	Modulation	RB Size	RB Offset	Power Low Ch. / Freq.	Power Middle Ch. / Freq.	Power High Ch. / Freq.	EIRP(W)		
Channel				20050	20175	20300	EIRP(W)		
Frequency (MHz)				1720	1732.5	1745	L	M	H
20	QPSK	1	0	24.29	24.59	24.42	0.0811	0.0869	0.0836
20	QPSK	1	99	24.26	24.29	24.12	0.0805	0.0811	0.0780
20	QPSK	100	0	22.95	23.25	23.08	0.0596	0.0638	0.0614
20	16QAM	1	0	22.93	23.23	23.06	0.0593	0.0635	0.0611
Channel				20025	20175	20325	EIRP(W)		
Frequency (MHz)				1717.5	1732.5	1747.5	L	M	H
15	QPSK	1	0	24.23	24.37	24.42	0.0800	0.0826	0.0836
15	16QAM	1	0	22.79	23.04	22.86	0.0574	0.0608	0.0583
Channel				20000	20175	20350	EIRP(W)		
Frequency (MHz)				1715	1732.5	1750	L	M	H
10	QPSK	1	0	24.22	24.48	24.37	0.0798	0.0847	0.0826
10	16QAM	1	0	22.87	23.02	22.88	0.0585	0.0605	0.0586
Channel				19975	20175	20375	EIRP(W)		
Frequency (MHz)				1712.5	1732.5	1752.5	L	M	H
5	QPSK	1	0	24.08	24.43	24.24	0.0773	0.0838	0.0802
5	16QAM	1	0	22.81	23.18	22.88	0.0577	0.0628	0.0586
Channel				19965	20175	20385	EIRP(W)		
Frequency (MHz)				1711.5	1732.5	1753.5	L	M	H
3	QPSK	1	0	24.17	24.48	24.27	0.0789	0.0847	0.0807
3	16QAM	1	0	22.90	23.01	22.99	0.0589	0.0604	0.0601
Channel				19950	20175	20393	EIRP(W)		
Frequency (MHz)				1710	1732.5	1754.3	L	M	H
1.4	QPSK	1	0	24.26	24.44	24.31	0.0805	0.0839	0.0815
1.4	16QAM	1	0	22.87	23.21	22.85	0.0585	0.0632	0.0582



LTE Band 5:

BW [MHz]	Modulation	RB Size	RB Offset	Power Low Ch. / Freq.	Power Middle Ch. / Freq.	Power High Ch. / Freq.	ERP(W)		
Channel				20450	20525	20600	ERP(W)		
Frequency (MHz)				829	836.5	844	L	M	H
10	QPSK	1	0	24.06	24.31	24.18	0.0115	0.0122	0.0118
10	QPSK	1	49	24.01	24.22	24.09	0.0114	0.0119	0.0116
10	QPSK	50	0	22.81	23.13	22.90	0.0086	0.0093	0.0088
10	16QAM	1	0	23.00	23.32	23.09	0.0090	0.0097	0.0092
Channel				20425	20525	20625	ERP(W)		
Frequency (MHz)				826.5	836.5	846.5	L	M	H
5	QPSK	1	0	24.04	24.15	23.99	0.0115	0.0117	0.0113
5	16QAM	1	0	23.01	23.13	23.08	0.0090	0.0093	0.0092
Channel				20415	20525	20635	ERP(W)		
Frequency (MHz)				825.5	836.5	847.5	L	M	H
3	QPSK	1	0	24.02	24.25	24.04	0.0114	0.0120	0.0115
3	16QAM	1	0	22.85	23.10	22.89	0.0087	0.0092	0.0088
Channel				20407	20525	20643	ERP(W)		
Frequency (MHz)				824.7	836.5	848.3	L	M	H
1.4	QPSK	1	0	23.88	24.10	24.07	0.0110	0.0116	0.0115
1.4	16QAM	1	0	22.92	23.22	23.02	0.0089	0.0095	0.0091

LTE Band 12:

BW [MHz]	Modulation	RB Size	RB Offset	Power Low Ch. / Freq.	Power Middle Ch. / Freq.	Power High Ch. / Freq.	ERP(W)		
Channel				23060	23095	23130	ERP(W)		
Frequency (MHz)				704	707.5	711	L	M	H
10	QPSK	1	0	23.98	24.11	23.88	0.0076	0.0079	0.0075
10	QPSK	1	49	23.69	23.68	23.71	0.0071	0.0071	0.0072
10	QPSK	50	0	22.44	22.57	22.34	0.0054	0.0055	0.0052
10	16QAM	1	0	22.68	22.81	22.58	0.0057	0.0058	0.0055
Channel				23035	23095	23155	ERP(W)		
Frequency (MHz)				701.5	707.5	713.5	L	M	H
5	QPSK	1	0	23.80	23.92	23.86	0.0073	0.0075	0.0074
5	16QAM	1	0	22.50	22.70	22.52	0.0054	0.0057	0.0055
Channel				23025	23095	23165	ERP(W)		
Frequency (MHz)				700.5	707.5	714.5	L	M	H
3	QPSK	1	0	23.75	23.88	23.88	0.0072	0.0075	0.0075
3	16QAM	1	0	22.66	22.61	22.49	0.0056	0.0056	0.0054
Channel				23017	23095	23173	ERP(W)		
Frequency (MHz)				699.7	707.5	715.3	L	M	H
1.4	QPSK	1	0	23.86	24.05	23.70	0.0074	0.0078	0.0072
1.4	16QAM	1	0	22.52	22.66	22.54	0.0055	0.0056	0.0055



LTE Band 13:

BW [MHz]	Modulation	RB Size	RB Offset	Power Low Ch. / Freq.	Power Middle Ch. / Freq.	Power High Ch. / Freq.	ERP(W)		
Channel				23230					
Frequency (MHz)				782				M	
10	QPSK	1	0		24.47			0.0094	
10	QPSK	1	49		24.38			0.0092	
10	QPSK	50	0		22.98			0.0067	
10	16QAM	1	0		23.41			0.0073	
Channel				23205	23230	23255	ERP(W)		
Frequency (MHz)				779.5	782	784.5	L	M	H
5	QPSK	1	0	24.07	24.30	24.33	0.0086	0.0090	0.0091
5	16QAM	1	0	23.10	23.36	22.99	0.0068	0.0073	0.0067

LTE Band 17:

BW [MHz]	Modulation	RB Size	RB Offset	Power Low Ch. / Freq.	Power Middle Ch. / Freq.	Power High Ch. / Freq.	ERP(W)		
Channel				23780	23790	23800			
Frequency (MHz)				709	710	711	L	M	H
10	QPSK	1	0	24.08	24.10	24.08	0.0075	0.0075	0.0075
10	QPSK	1	49	23.79	23.84	23.82	0.0070	0.0071	0.0070
10	QPSK	50	0	22.74	22.79	22.77	0.0055	0.0055	0.0055
10	16QAM	1	0	23.17	23.22	23.20	0.0061	0.0061	0.0061
Channel				23755	23790	23825	ERP(W)		
Frequency (MHz)				706.5	710	713.5	L	M	H
5	QPSK	1	0	24.03	23.92	24.08	0.0074	0.0072	0.0075
5	16QAM	1	0	22.95	23.00	23.14	0.0058	0.0058	0.0060



LTE Band 25:

BW [MHz]	Modulation	RB Size	RB Offset	Power Low Ch. / Freq.	Power Middle Ch. / Freq.	Power High Ch. / Freq.	EIRP(W)		
Channel				26140	26340	26590			
Frequency (MHz)				1860	1880	1905	L	M	H
20	QPSK	1	0	24.13	24.24	23.98	0.1007	0.1033	0.0973
20	QPSK	1	99	23.89	23.91	23.85	0.0953	0.0957	0.0944
20	QPSK	100	0	23.24	23.35	23.09	0.0820	0.0841	0.0793
20	16QAM	1	0	23.01	23.12	22.86	0.0778	0.0798	0.0752
Channel				26115	26340	26615	EIRP(W)		
Frequency (MHz)				1857.5	1880	1907.5	L	M	H
15	QPSK	1	0	23.98	24.17	23.83	0.0973	0.1016	0.0940
15	16QAM	1	0	22.98	23.03	22.75	0.0773	0.0782	0.0733
Channel				26090	26340	26640	EIRP(W)		
Frequency (MHz)				1855	1880	1910	L	M	H
10	QPSK	1	0	23.97	24.01	23.86	0.0971	0.0979	0.0946
10	16QAM	1	0	22.91	23.03	22.82	0.0760	0.0782	0.0745
Channel				26065	26340	26665	EIRP(W)		
Frequency (MHz)				1852.5	1880	1912.5	L	M	H
5	QPSK	1	0	24.09	24.07	23.84	0.0998	0.0993	0.0942
5	16QAM	1	0	22.89	22.92	22.70	0.0757	0.0762	0.0724
Channel				26055	26340	26675	EIRP(W)		
Frequency (MHz)				1851.5	1880	1913.5	L	M	H
3	QPSK	1	0	24.05	24.16	23.87	0.0989	0.1014	0.0948
3	16QAM	1	0	22.80	22.89	22.76	0.0741	0.0757	0.0735
Channel				26047	26340	26683	EIRP(W)		
Frequency (MHz)				1850.7	1880	1914.3	L	M	H
1.4	QPSK	1	0	24.10	24.05	23.77	0.1000	0.0989	0.0927
1.4	16QAM	1	0	22.82	22.89	22.79	0.0745	0.0757	0.0740



LTE Band 26:

BW [MHz]	Modulation	RB Size	RB Offset	Power Low Ch. / Freq.	Power Low Ch. / Freq.	Power Middle Ch. / Freq.	Power High Ch. / Freq.	ERP(W)			
Channel				26790	26865	26915	26965				
Frequency (MHz)				824	831.5	836.5	841.5	Straddle Ch	L	M	H
15	QPSK	1	0	24.33	24.45	24.55	24.36	0.0122	0.0126	0.0129	0.0123
15	QPSK	1	74	24.21	24.22	24.52	24.33	0.0119	0.0119	0.0128	0.0122
15	QPSK	75	0	22.96	23.05	23.31	23.12	0.0089	0.0091	0.0097	0.0093
15	16QAM	1	0	23.24	23.48	23.44	23.25	0.0095	0.0101	0.0100	0.0095
Channel				26790	26840	26915	26990	ERP(W)			
Frequency (MHz)				824	829	836.5	844	Straddle Ch	L	M	H
10	QPSK	1	0	24.36	24.10	24.35	24.27	0.0123	0.0116	0.0123	0.0121
10	16QAM	1	0	23.28	23.01	23.39	23.09	0.0096	0.0090	0.0099	0.0092
Channel				26790	26815	26915	27015	ERP(W)			
Frequency (MHz)				824	826.5	836.5	846.5	Straddle Ch	L	M	H
5	QPSK	1	0	24.28	24.22	24.35	24.30	0.0121	0.0119	0.0123	0.0122
5	16QAM	1	0	23.21	23.04	23.40	23.04	0.0095	0.0091	0.0099	0.0091
Channel				26790	26815	26915	27025	ERP(W)			
Frequency (MHz)				824	825.5	836.5	847.5	Straddle Ch	L	M	H
3	QPSK	1	0	24.19	24.21	24.46	24.25	0.0119	0.0119	0.0126	0.0120
3	16QAM	1	0	23.28	23.16	23.41	23.05	0.0096	0.0094	0.0099	0.0091
Channel				26790	26797	26915	27033	ERP(W)			
Frequency (MHz)				824	824.7	836.5	848.3	Straddle Ch	L	M	H
1.4	QPSK	1	0	24.13	24.12	24.39	24.36	0.0117	0.0117	0.0124	0.0123
1.4	16QAM	1	0	23.25	23.03	23.30	23.06	0.0095	0.0091	0.0097	0.0091



LTE Band 66:

BW [MHz]	Modulation	RB Size	RB Offset	Power Low Ch. / Freq.	Power Middle Ch. / Freq.	Power High Ch. / Freq.	EIRP(W)		
Channel				132072	132322	132572	EIRP(W)		
Frequency (MHz)				1720	1745	1770	L	M	H
20	QPSK	1	0	24.50	24.62	24.36	0.0912	0.0938	0.0883
20	QPSK	1	99	24.44	24.56	24.30	0.0899	0.0925	0.0871
20	QPSK	100	0	23.29	23.41	23.15	0.0690	0.0710	0.0668
20	16QAM	1	0	23.37	23.49	23.23	0.0703	0.0723	0.0681
Channel				132047	132322	132597	EIRP(W)		
Frequency (MHz)				1717.5	1745	1772.5	L	M	H
15	QPSK	1	0	24.49	24.59	24.35	0.0910	0.0931	0.0881
15	16QAM	1	0	23.19	23.45	23.20	0.0675	0.0716	0.0676
Channel				132022	132322	132622	EIRP(W)		
Frequency (MHz)				1715	1745	1775	L	M	H
10	QPSK	1	0	24.50	24.48	24.17	0.0912	0.0908	0.0845
10	16QAM	1	0	23.16	23.34	23.14	0.0670	0.0698	0.0667
Channel				131997	132322	132647	EIRP(W)		
Frequency (MHz)				1712.5	1745	1777.5	L	M	H
5	QPSK	1	0	24.40	24.53	24.14	0.0891	0.0918	0.0839
5	16QAM	1	0	23.16	23.33	23.17	0.0670	0.0697	0.0671
Channel				131987	132322	132657	EIRP(W)		
Frequency (MHz)				1711.5	1745	1778.5	L	M	H
3	QPSK	1	0	24.43	24.42	24.16	0.0897	0.0895	0.0843
3	16QAM	1	0	23.26	23.29	23.18	0.0685	0.0690	0.0673
Channel				131979	132322	132665	EIRP(W)		
Frequency (MHz)				1710.7	1745	1779.3	L	M	H
1.4	QPSK	1	0	24.29	24.40	24.32	0.0869	0.0891	0.0875
1.4	16QAM	1	0	23.31	23.40	22.99	0.0693	0.0708	0.0644



LTE Band 71:

BW [MHz]	Modulation	RB Size	RB Offset	Power Low Ch. / Freq.	Power Middle Ch. / Freq.	Power High Ch. / Freq.	ERP(W)		
							L	M	H
Channel				133222	133322	133372	ERP(W)		
Frequency (MHz)				673	683	688	L	M	H
20	QPSK	1	0	23.94	24.03	23.87	0.0071	0.0072	0.0070
20	QPSK	1	99	23.66	23.75	23.59	0.0066	0.0068	0.0065
20	QPSK	100	0	22.73	22.82	22.66	0.0053	0.0055	0.0053
20	16QAM	1	0	23.19	23.28	23.12	0.0059	0.0061	0.0058
Channel				133197	133297	133397	EIRP(W)		
Frequency (MHz)				670.5	680.5	690.5	L	M	H
15	QPSK	1	0	23.79	23.80	23.81	0.0068	0.0068	0.0069
15	16QAM	1	0	23.02	23.21	22.89	0.0057	0.0060	0.0055
Channel				133172	133272	133422	EIRP(W)		
Frequency (MHz)				668	678	693	L	M	H
10	QPSK	1	0	23.74	23.84	23.68	0.0067	0.0069	0.0067
10	16QAM	1	0	23.15	23.13	23.02	0.0059	0.0059	0.0057
Channel				133147	133247	133447	EIRP(W)		
Frequency (MHz)				665.5	675.5	695.5	L	M	H
5	QPSK	1	0	23.83	24.02	23.79	0.0069	0.0072	0.0068
5	16QAM	1	0	23.09	23.13	22.95	0.0058	0.0059	0.0056



LTE Band 12

Peak-to-Average Ratio

Mode	LTE Band 12 / 10MHz		
Mod.	QPSK	16QAM	Limit: 13dB
RB Size	Full RB	Full RB	Result
Middle CH	4.84	5.77	PASS

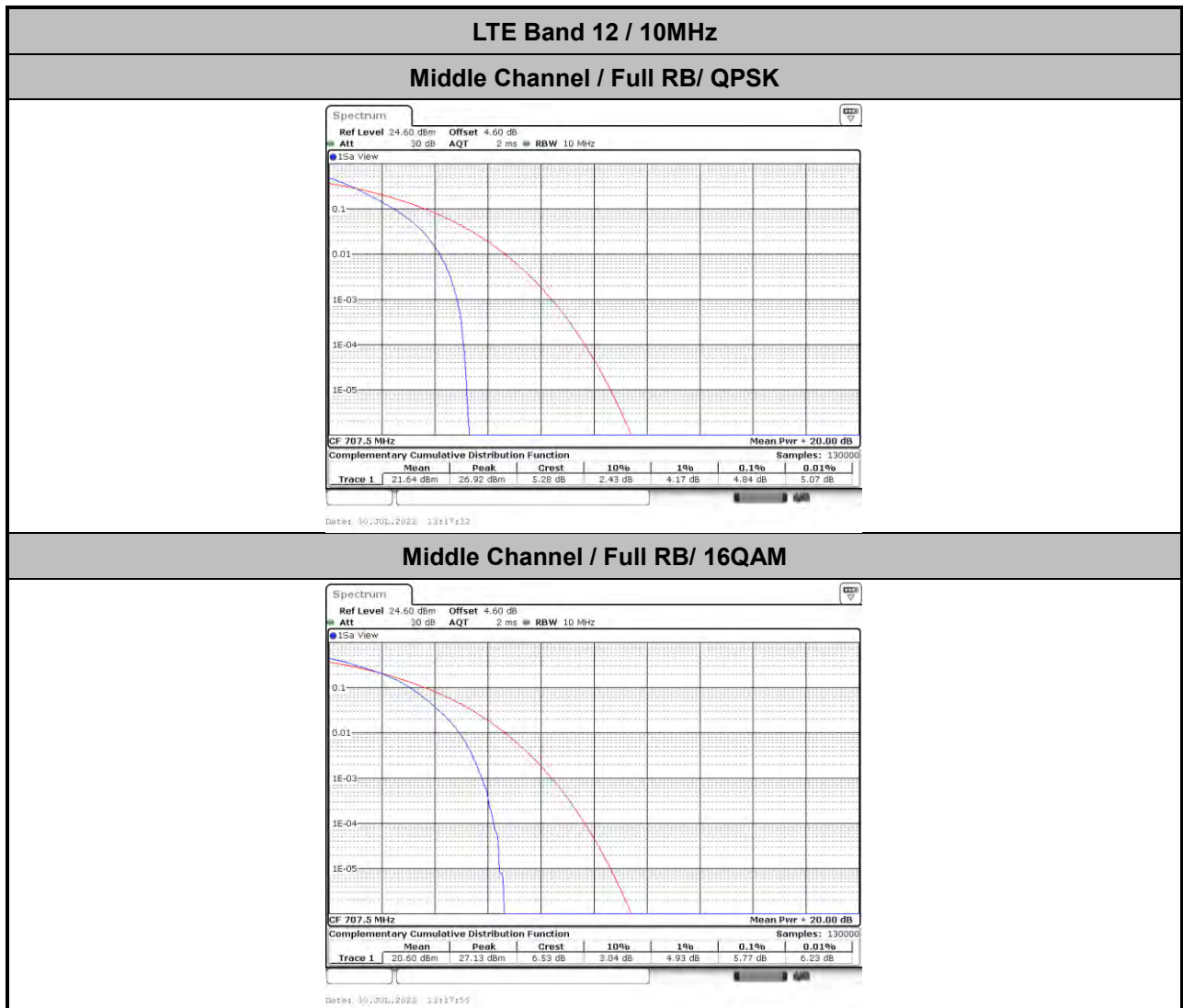



26dB Bandwidth

Mode	LTE Band 12 : 26dB BW(MHz)	
BW	1.4MHz	
Mod.	QPSK	16QAM
Middle CH	1.27	1.25
BW	3MHz	
Mod.	QPSK	16QAM
Middle CH	3.03	3.02
BW	5MHz	
Mod.	QPSK	16QAM
Middle CH	4.93	4.93
BW	10MHz	
Mod.	QPSK	16QAM
Middle CH	9.73	9.79

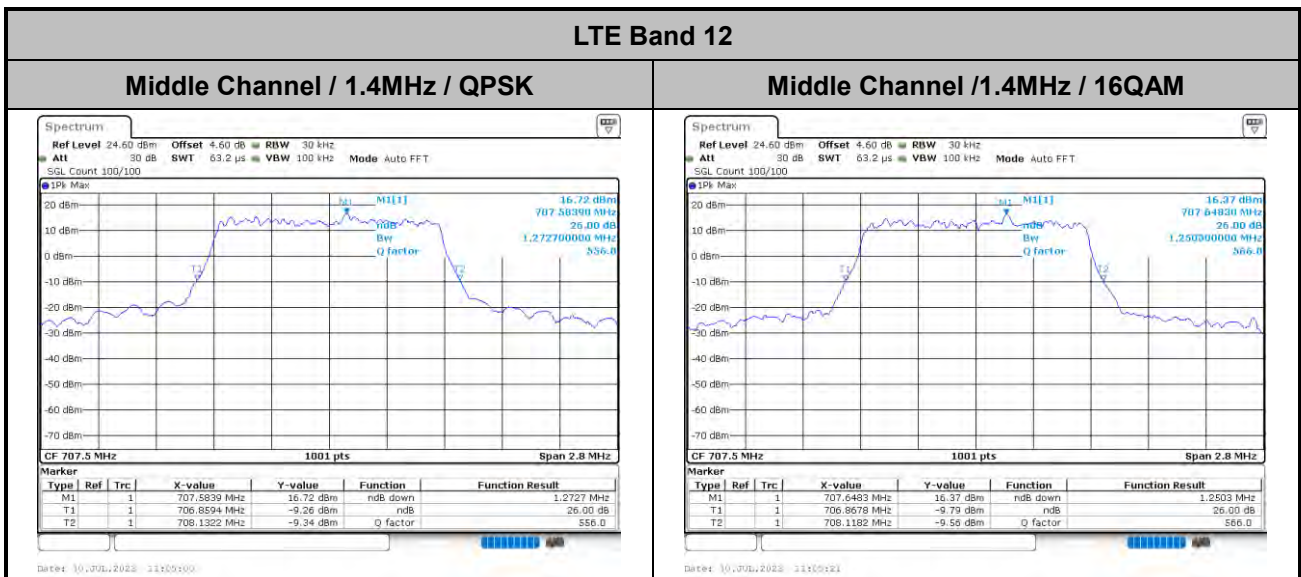



LTE Band 12

Middle Channel / 3MHz / QPSK

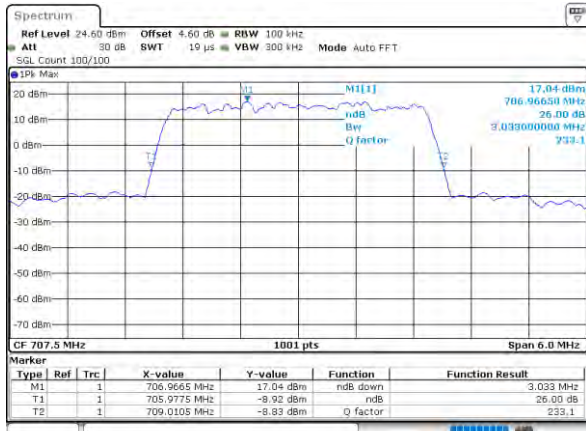

Date: 10/20/2023 11:49:04

Middle Channel / 3MHz / 16QAM

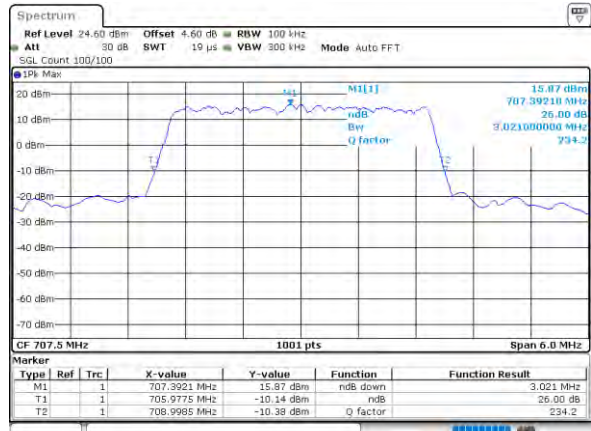

Date: 10/20/2023 11:49:25

LTE Band 12

Middle Channel / 5MHz / QPSK

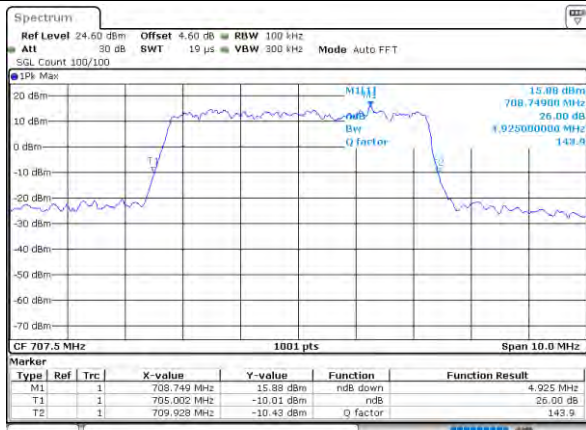

Date: 10/20/2023 12:11:20

Middle Channel / 5MHz / 16QAM

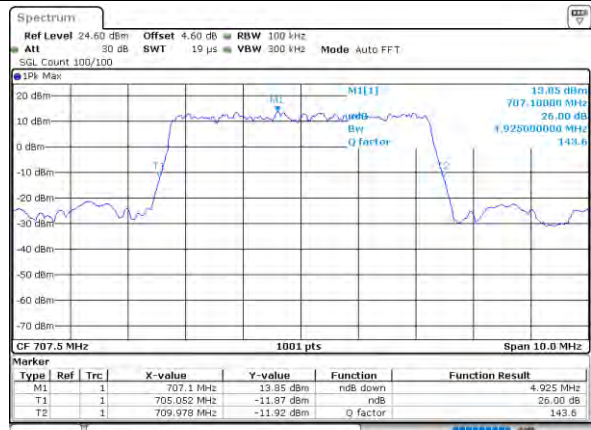

Date: 10/20/2023 12:11:51

LTE Band 12

Middle Channel / 10MHz / QPSK

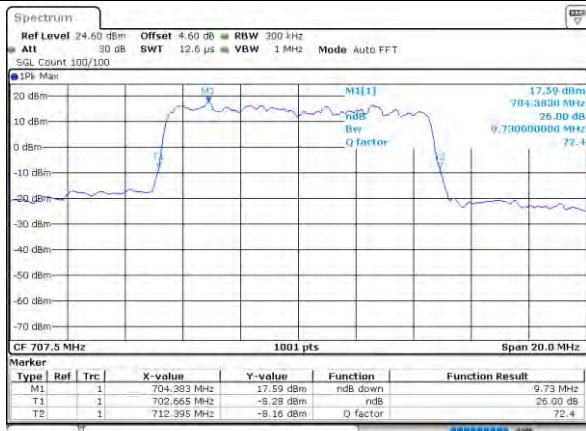

Date: 10/20/2023 13:18:59

Middle Channel / 10MHz / 16QAM

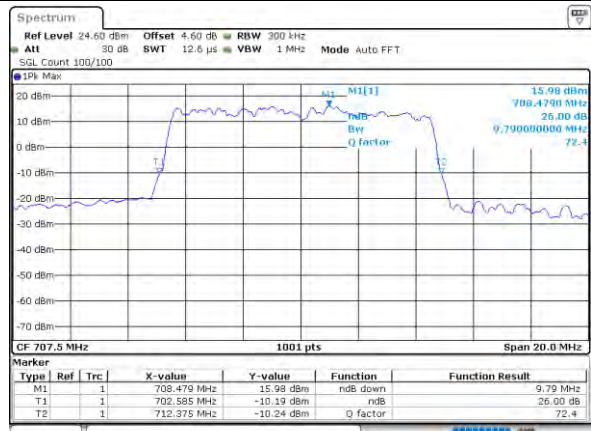

Date: 10/20/2023 13:19:22



Occupied Bandwidth

Mode	LTE Band 12 : 99%OBW(MHz)	
BW	1.4MHz	
Mod.	QPSK	16QAM
Middle CH	1.11	1.10
BW	3MHz	
Mod.	QPSK	16QAM
Middle CH	2.73	2.72
BW	5MHz	
Mod.	QPSK	16QAM
Middle CH	4.52	4.49
BW	10MHz	
Mod.	QPSK	16QAM
Middle CH	9.05	9.01

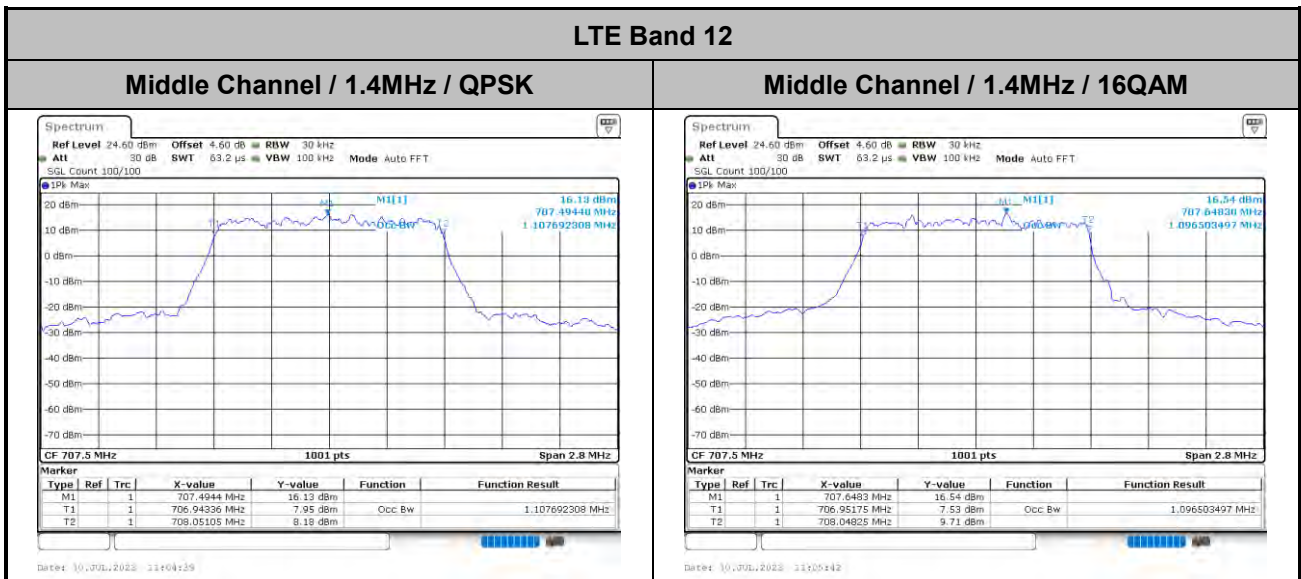



LTE Band 12

Middle Channel / 3MHz / QPSK

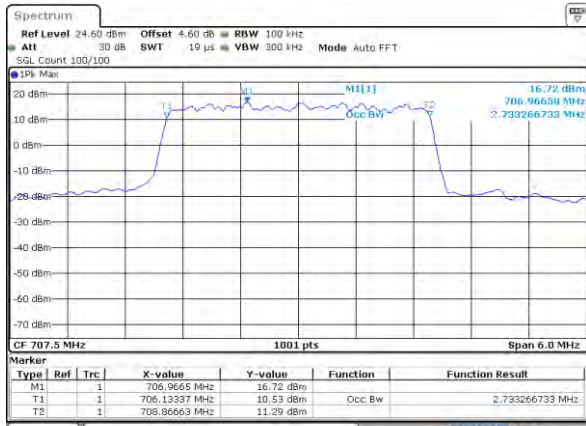

Date: 10.JUL.2023 11:39:43

Middle Channel / 3MHz / 16QAM

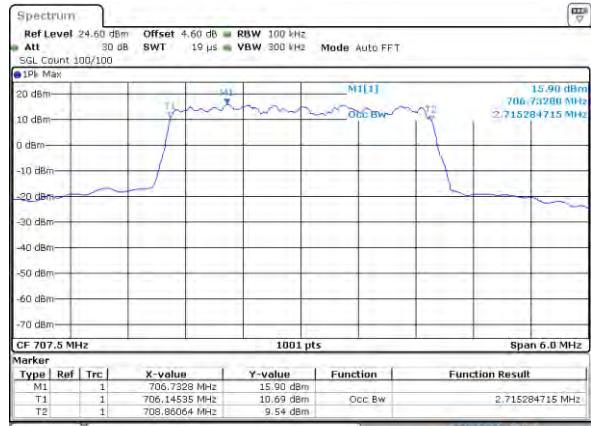

Date: 10.JUL.2023 11:40:47

LTE Band 12

Middle Channel / 5MHz / QPSK

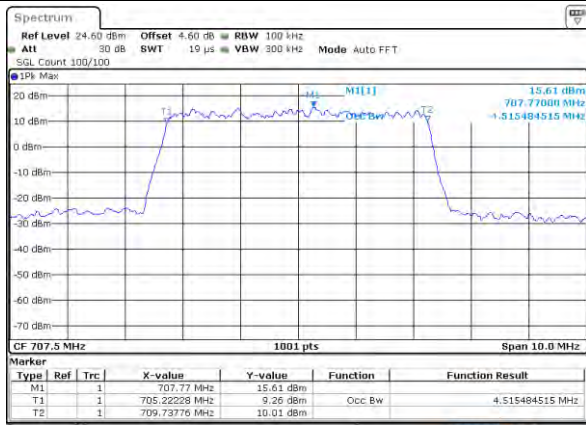

Date: 10.JUL.2023 12:16:59

Middle Channel / 5MHz / 16QAM

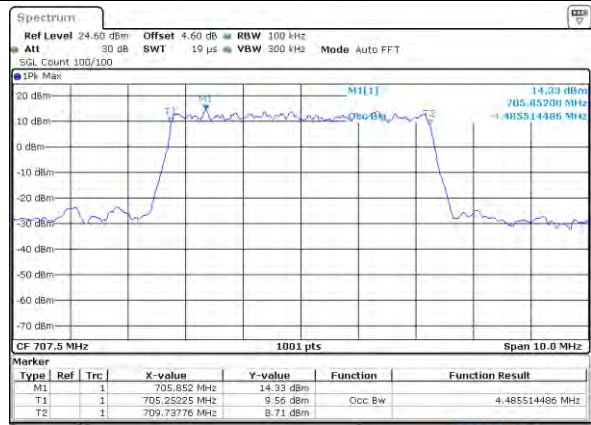

Date: 10.JUL.2023 12:18:02

LTE Band 12

Middle Channel / 10MHz / QPSK

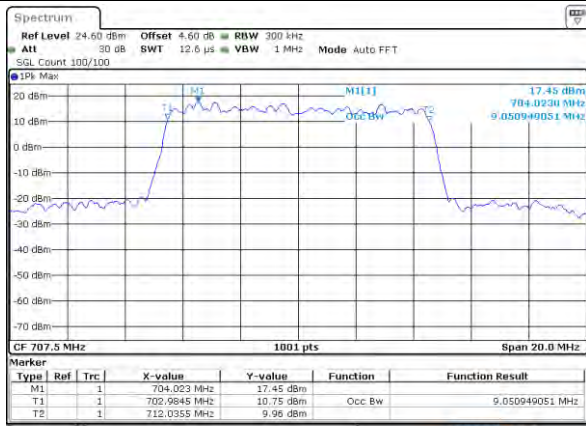

Date: 10.JUL.2023 13:18:16

Middle Channel / 10MHz / 16QAM



Date: 10.JUL.2023 13:18:51



Conducted Band Edge

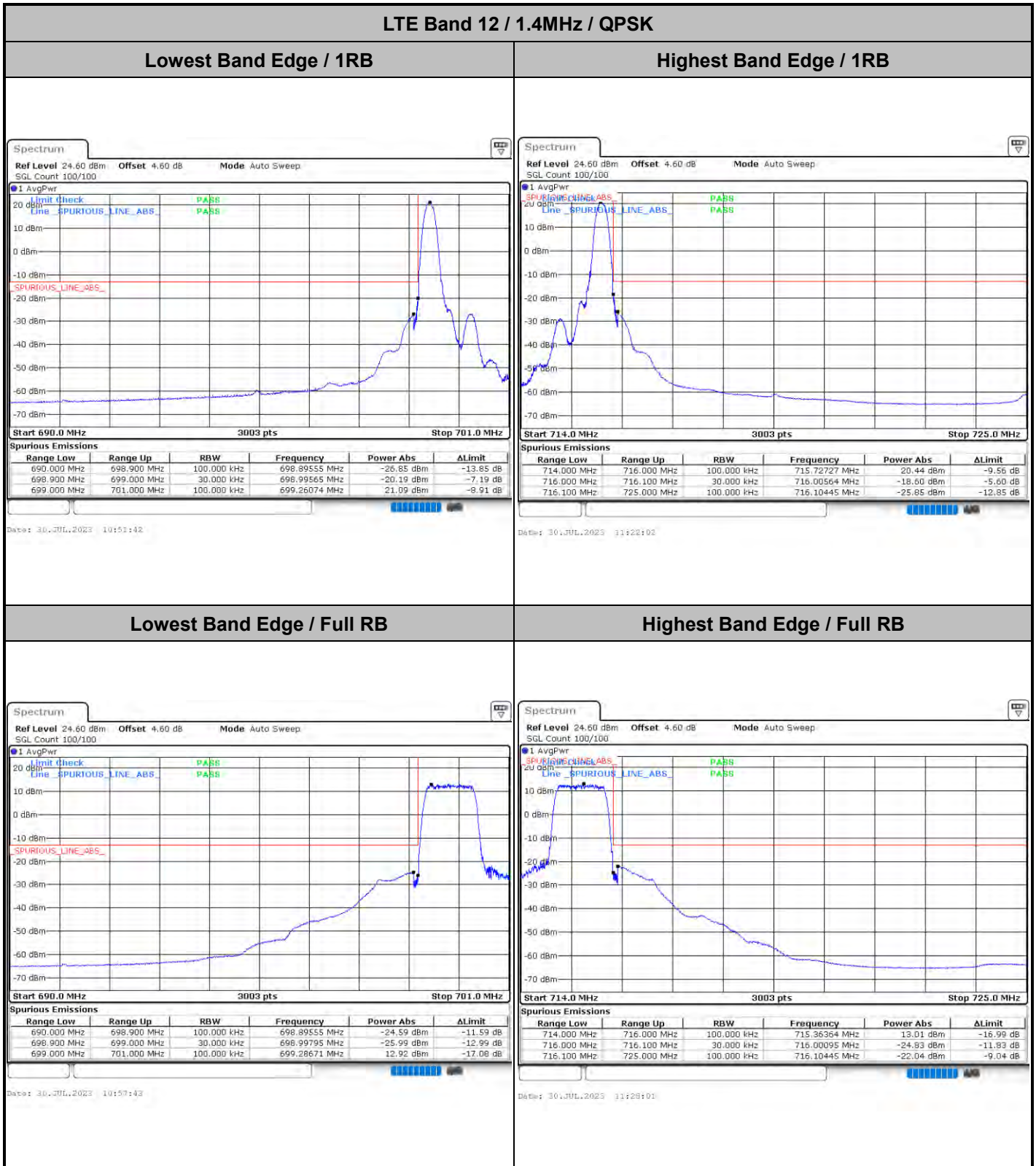



LTE Band 12 / 1.4MHz / 16QAM

Lowest Band Edge / 1 RB

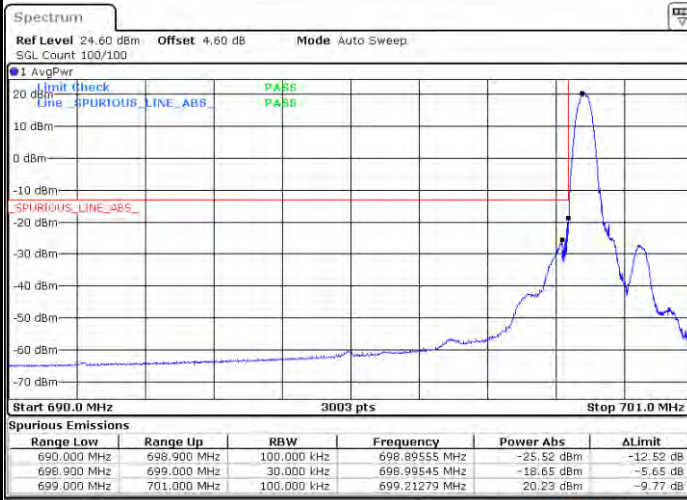

Date: 30.JUL.2023 10:53:42

Highest Band Edge / 1 RB



Date: 30.JUL.2023 11:24:02

Lowest Band Edge / Full RB

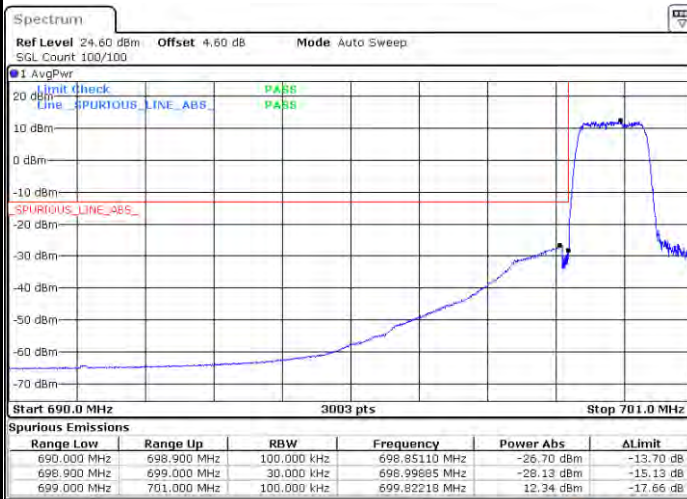

Date: 30.JUL.2023 10:59:43

Highest Band Edge / Full RB

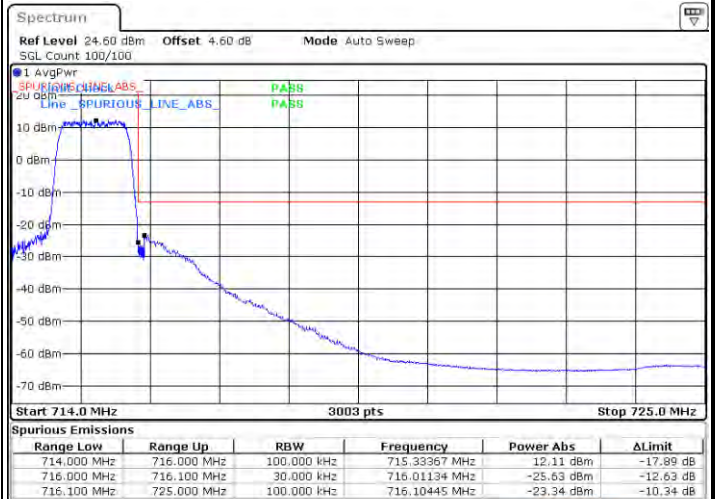

Date: 30.JUL.2023 11:26:02



LTE Band 12 / 3MHz / QPSK

Lowest Band Edge / 1RB

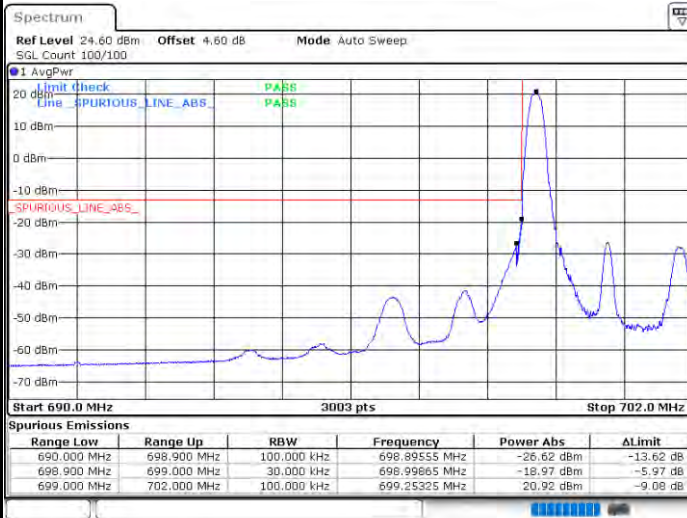

Highest Band Edge / 1 RB

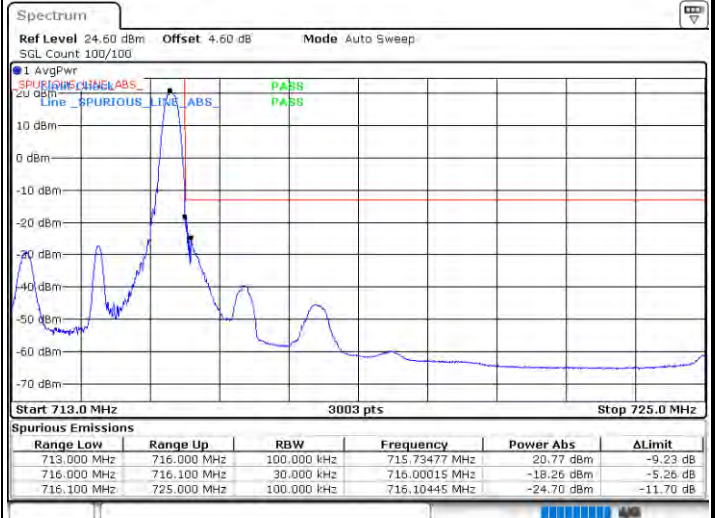

Lowest Band Edge / Full RB

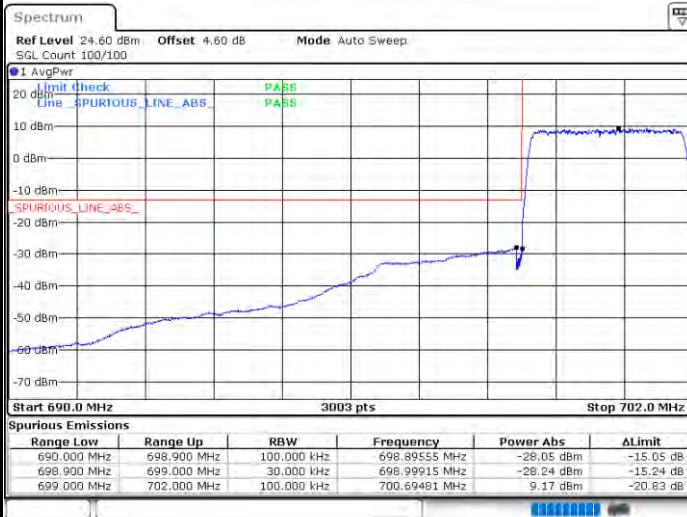

Highest Band Edge / Full RB

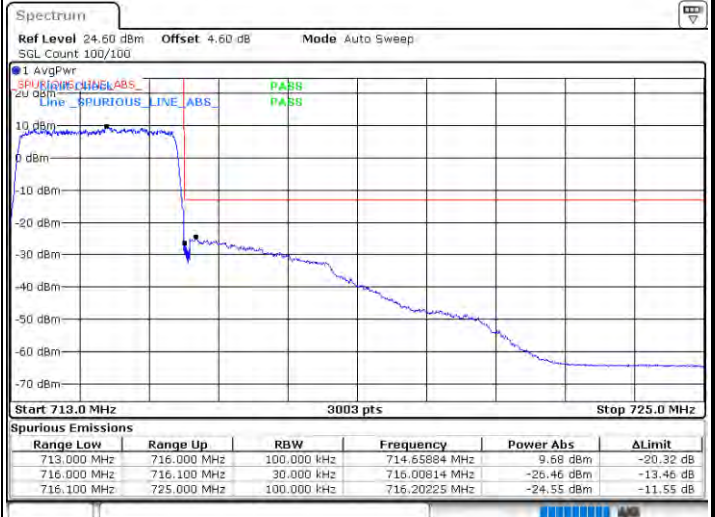



LTE Band 12 / 3MHz / 16QAM

Lowest Band Edge / 1 RB

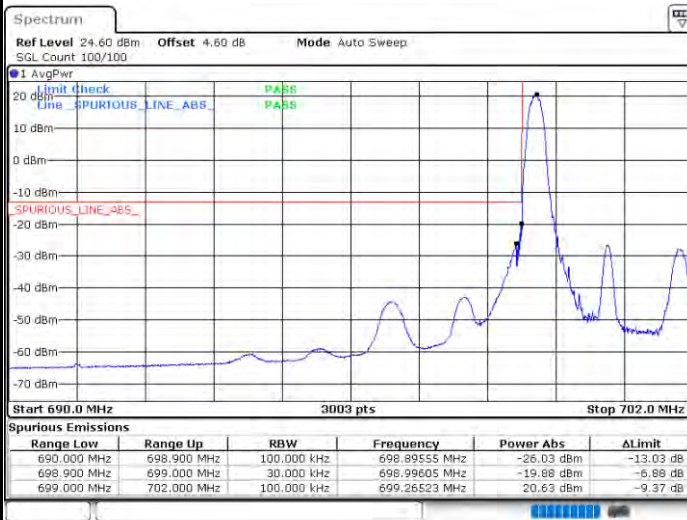

Date: 30.JUL.2023 11:03:43

Highest Band Edge / 1 RB

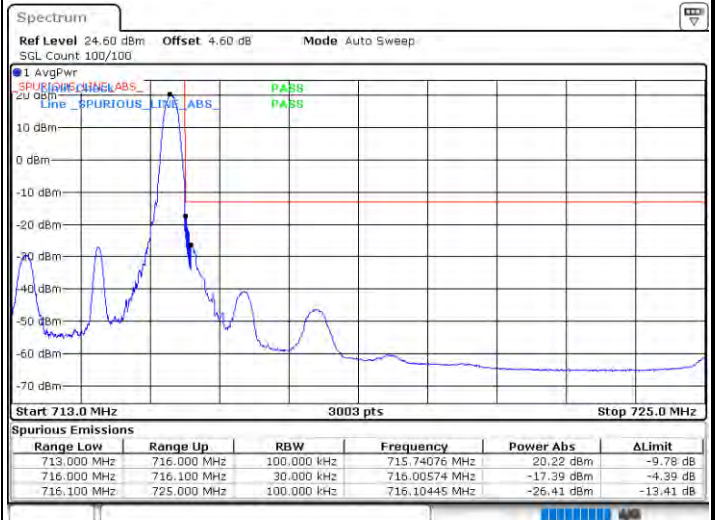

Date: 30.JUL.2023 12:01:18

Lowest Band Edge / Full RB

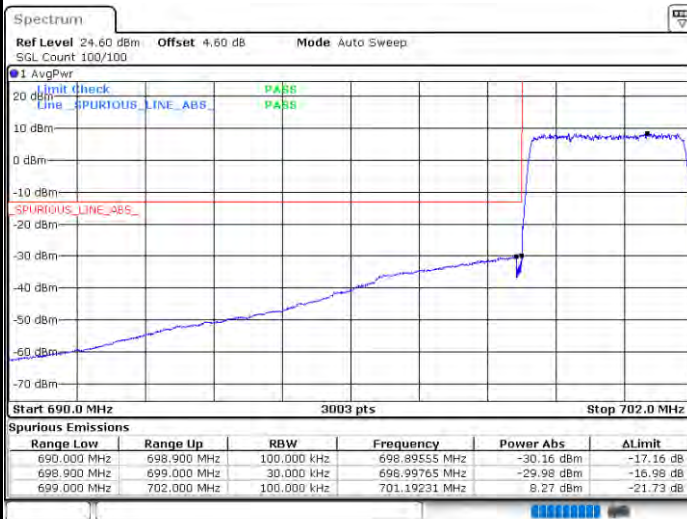

Date: 30.JUL.2023 11:59:42

Highest Band Edge / Full RB

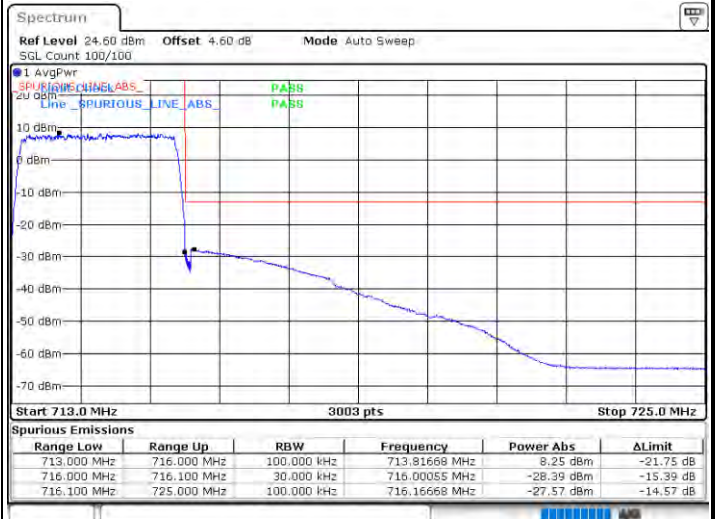

Date: 30.JUL.2023 12:05:18



LTE Band 12 / 5MHz / QPSK

Lowest Band Edge / 1 RB

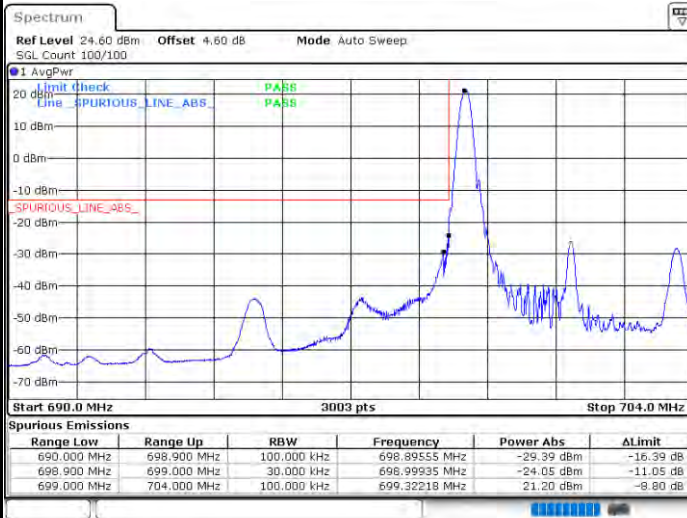

Date: 30.JUL.2023 12:08:59

Highest Band Edge / 1 RB

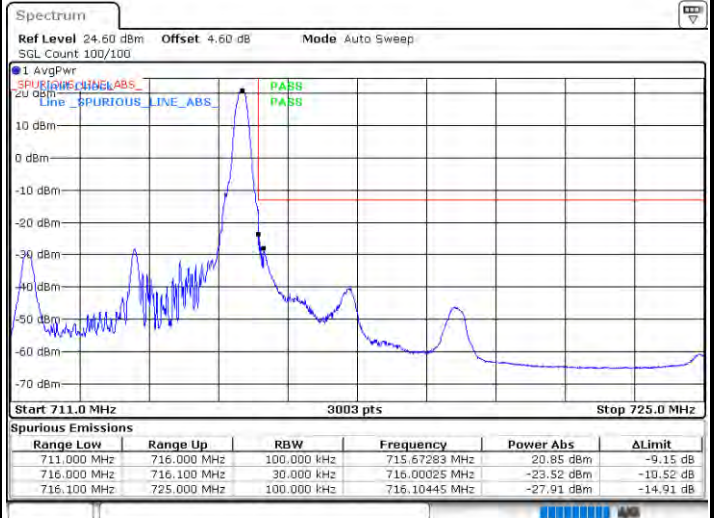

Date: 30.JUL.2023 12:10:09

Lowest Band Edge / Full RB

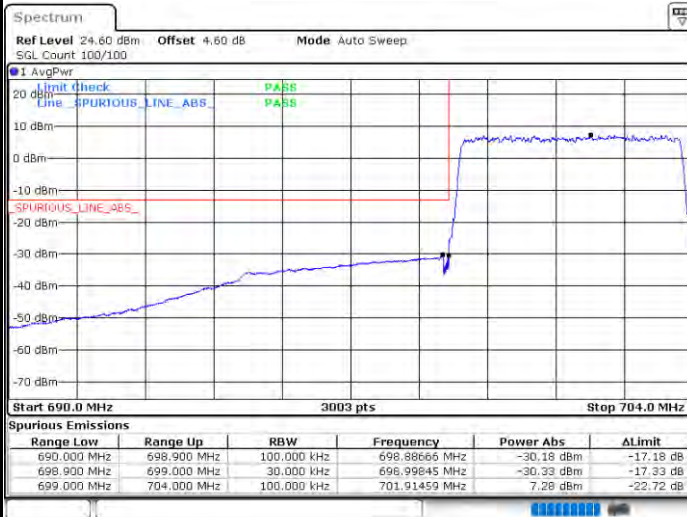

Date: 30.JUL.2023 12:10:58

Highest Band Edge / Full RB



Date: 30.JUL.2023 12:15:11



LTE Band 12 / 5MHz / 16QAM

Lowest Band Edge / 1RB

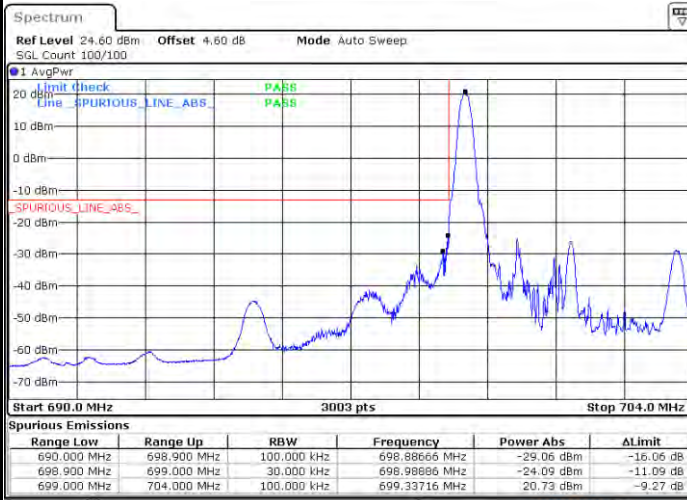

Highest Band Edge / 1 RB



Lowest Band Edge / Full RB

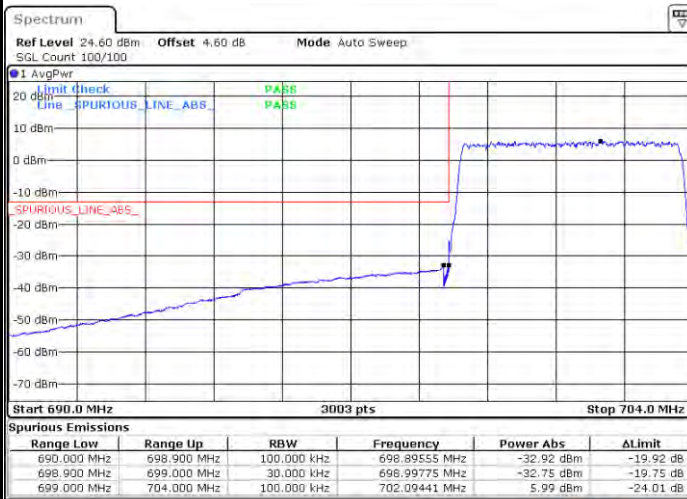

Highest Band Edge / Full RB





LTE Band 12 / 10MHz / QPSK

Lowest Band Edge / 1 RB

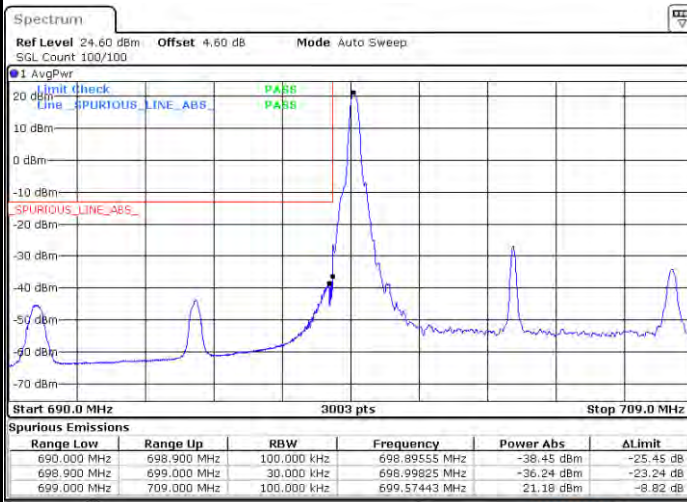

Date: 30.JUL.2023 12:59:51

Highest Band Edge / 1 RB

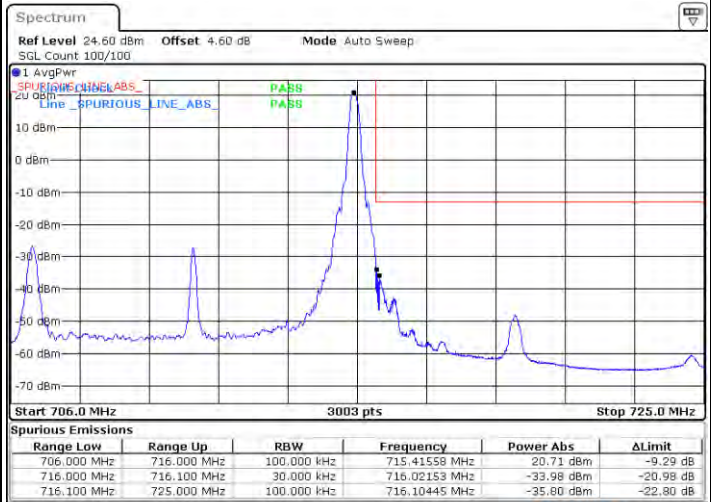

Date: 30.JUL.2023 13:11:10

Lowest Band Edge / Full RB

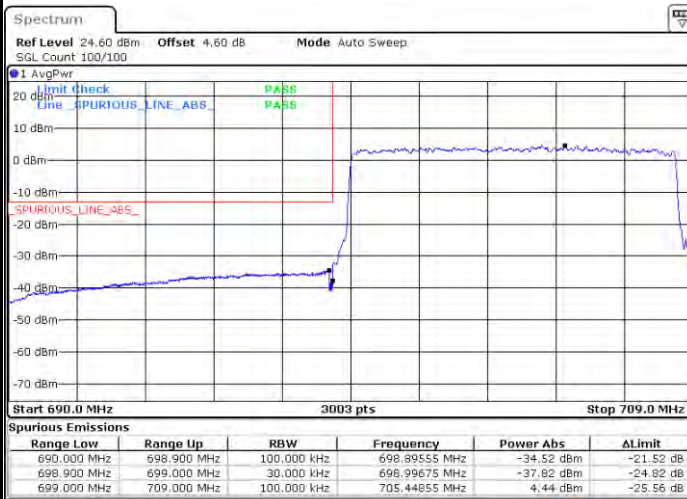

Date: 30.JUL.2023 13:09:51

Highest Band Edge / Full RB



Date: 30.JUL.2023 13:17:09



LTE Band 12 / 10MHz / 16QAM

Lowest Band Edge / 1 RB

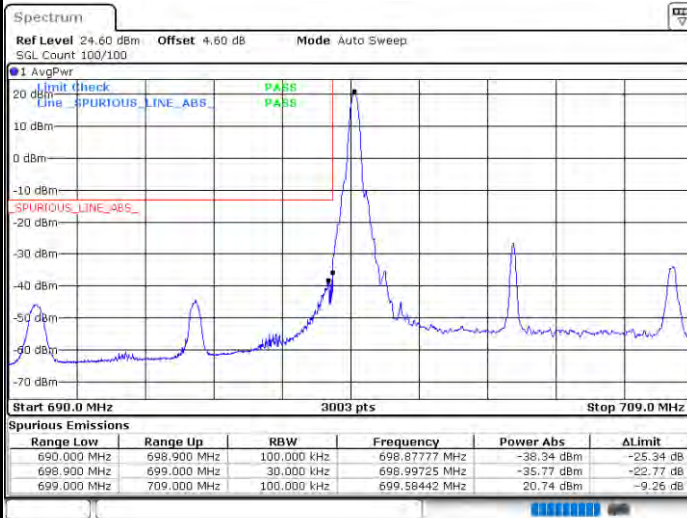

Date: 30.JUL.2023 13:01:51

Highest Band Edge / 1 RB

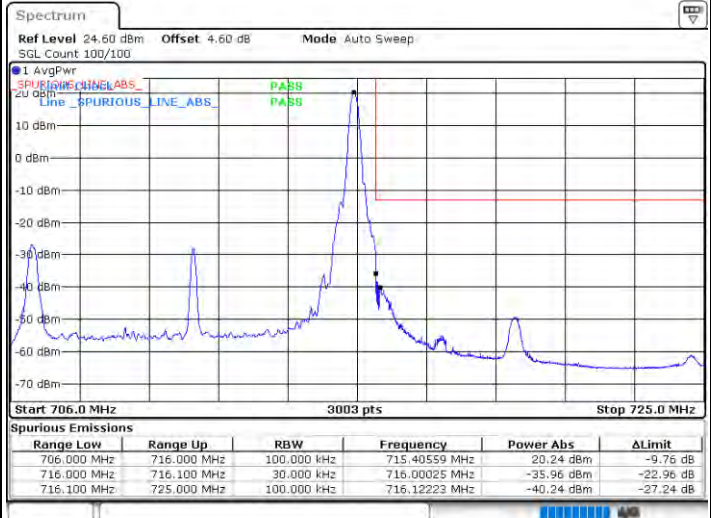

Date: 30.JUL.2023 13:10:10

Lowest Band Edge / Full RB

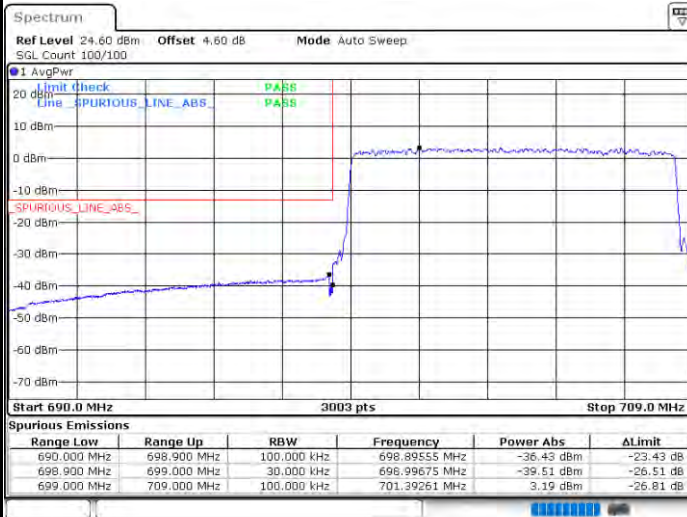

Date: 30.JUL.2023 13:03:51

Highest Band Edge / Full RB



Date: 30.JUL.2023 13:15:10



Conducted Spurious Emission

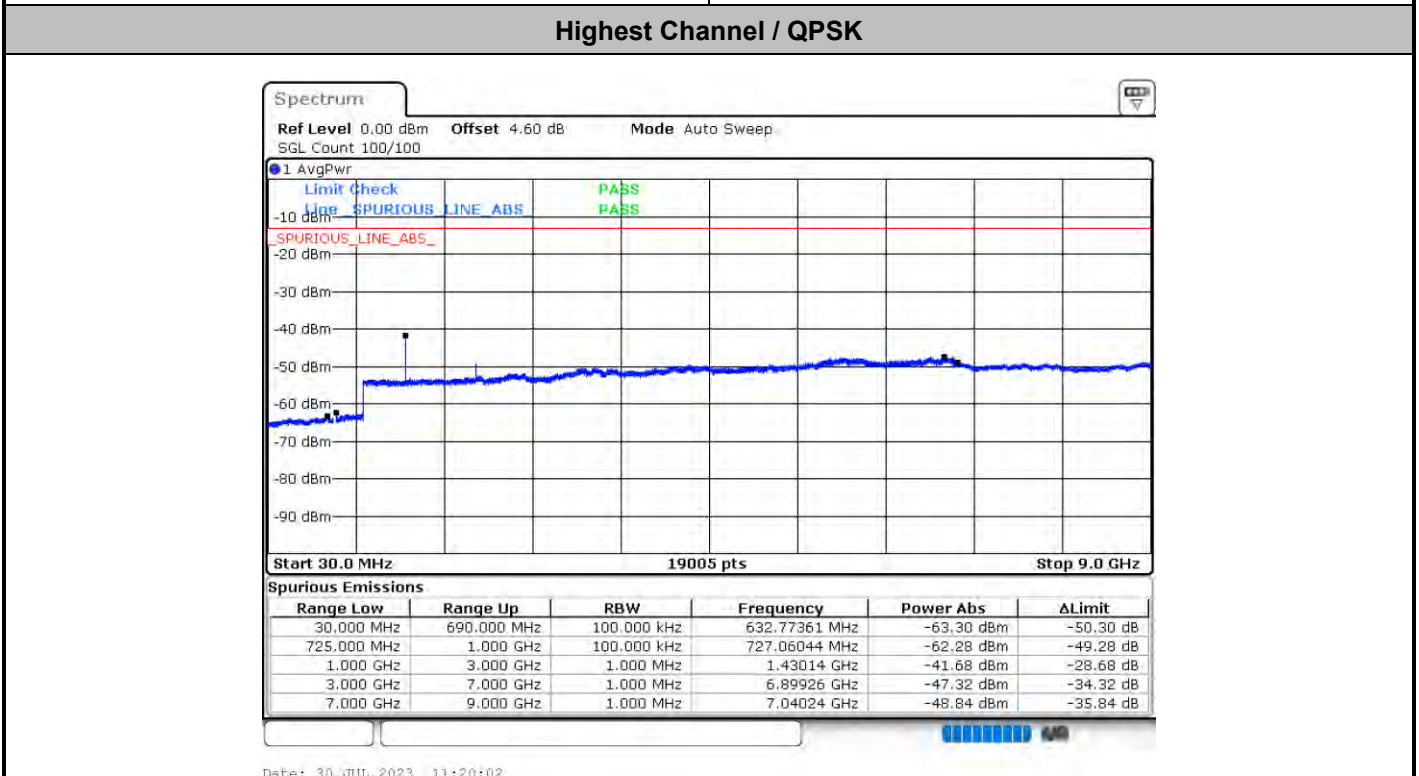
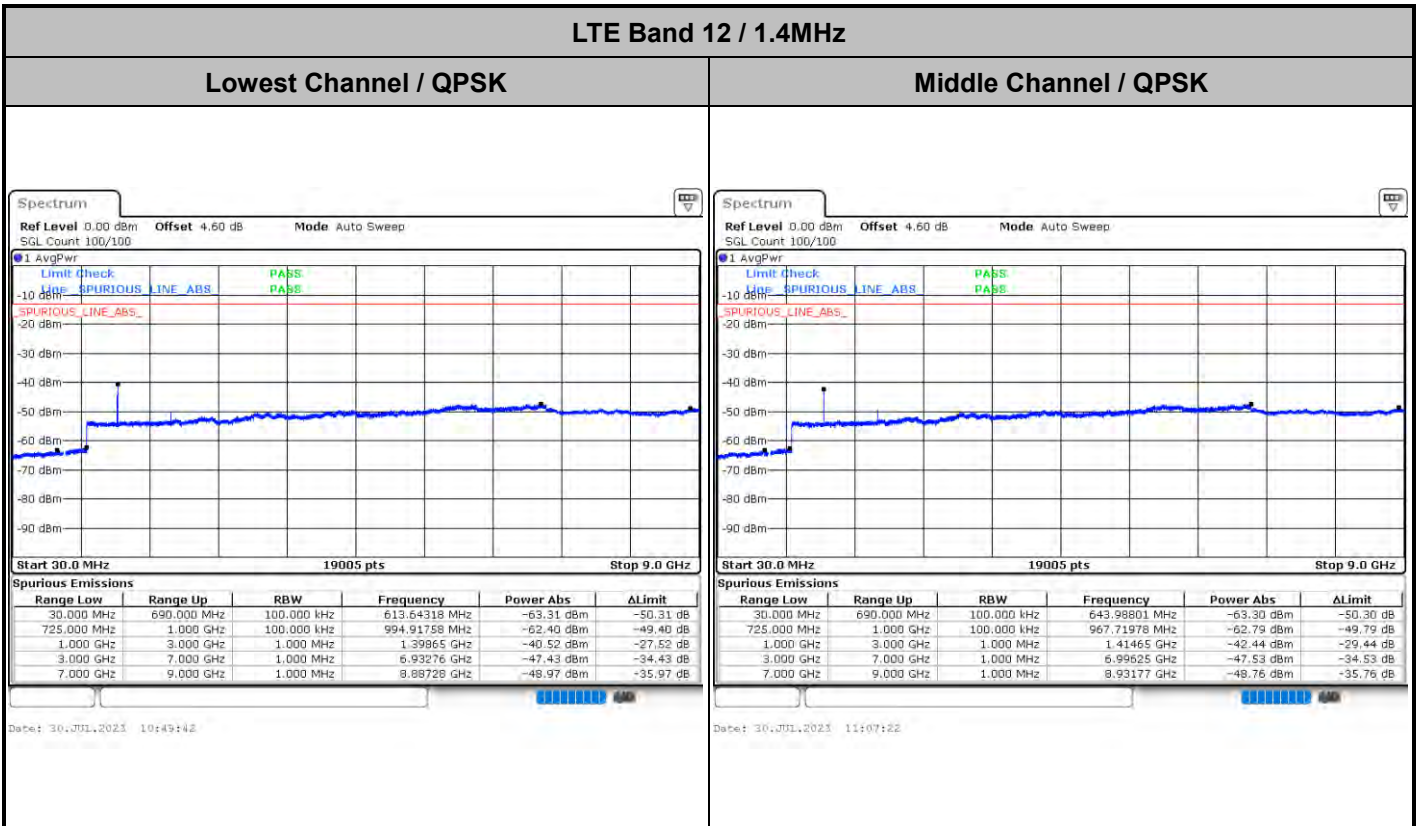



LTE Band 12 / 3MHz

Lowest Channel / QPSK

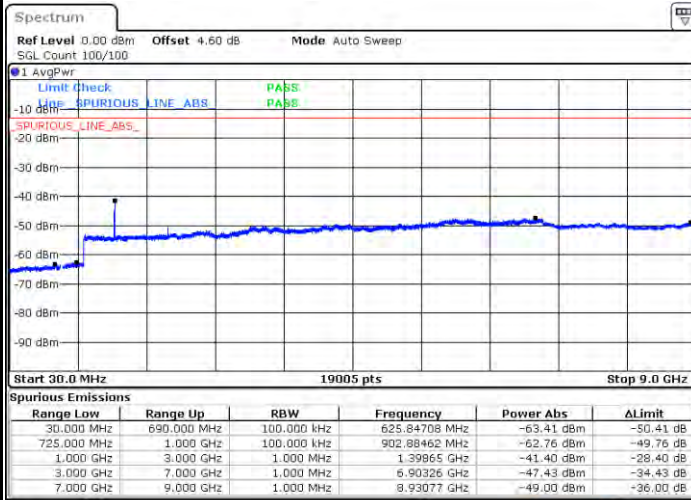

Date: 30-JUL-2023 11:29:42

Middle Channel / QPSK

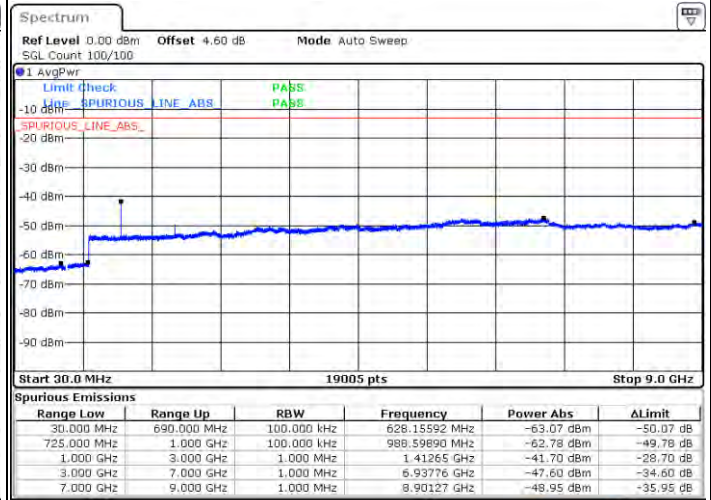

Date: 30-JUL-2023 11:35:22

Highest Channel / QPSK

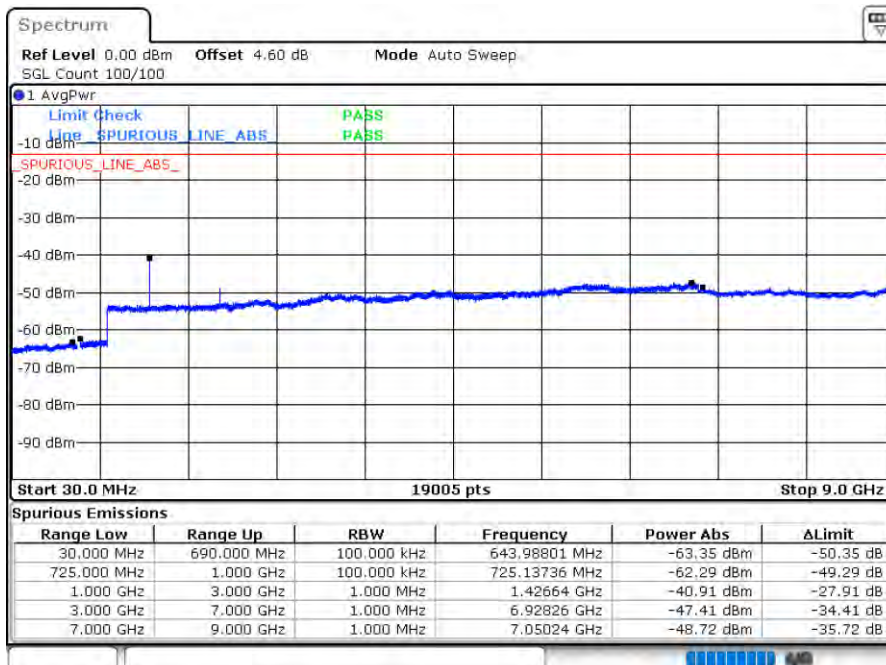

Date: 30-JUL-2023 11:57:19



LTE Band 12 / 5MHz

Lowest Channel / QPSK

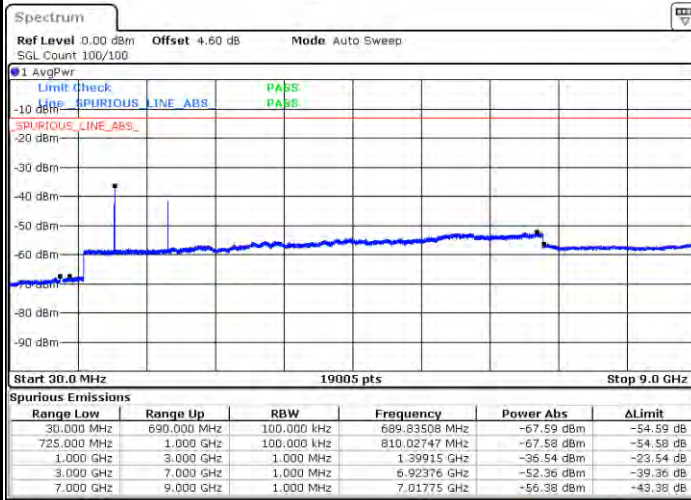

Date: 30.JUL.2023 12:06:58

Middle Channel / QPSK

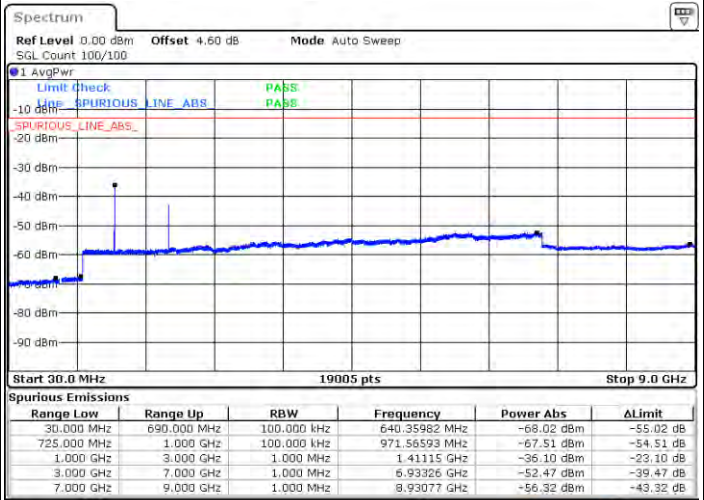

Date: 30.JUL.2023 12:16:38

Highest Channel / QPSK

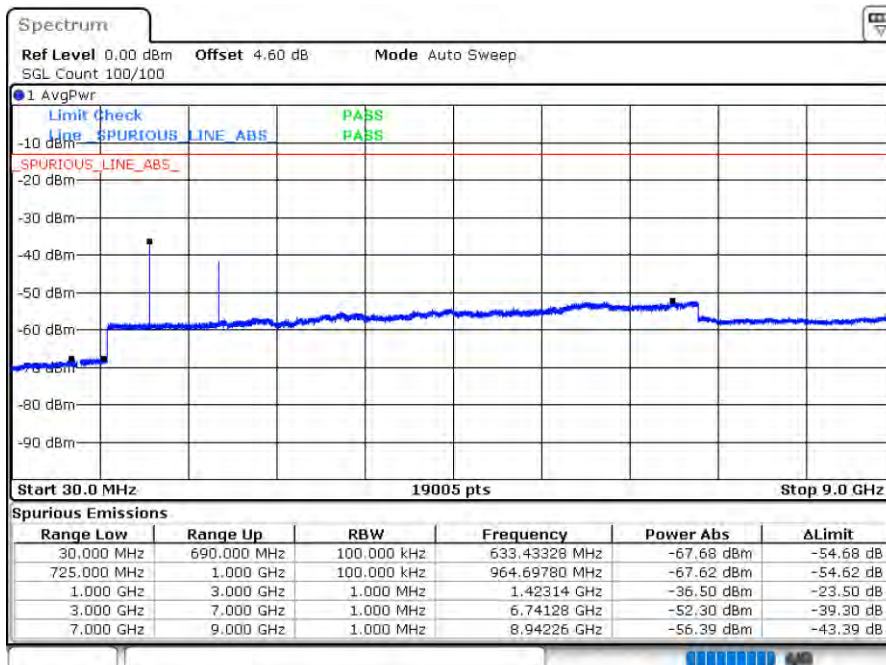

Date: 30.JUL.2023 12:48:09



LTE Band 12 / 10MHz

Lowest Channel / QPSK

Middle Channel / QPSK

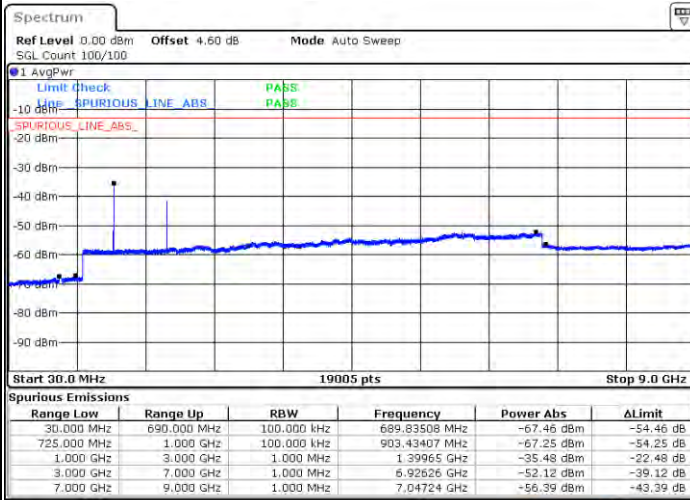

Date: 30-JUL-2023 12:57:51

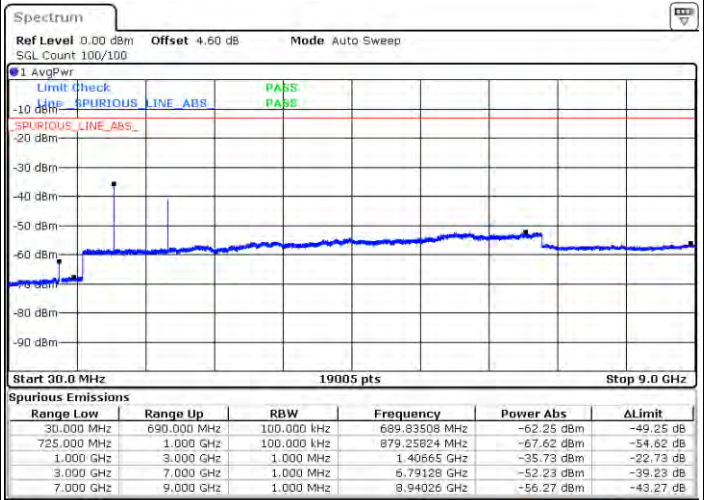

Date: 30-JUL-2023 13:07:51

Highest Channel / QPSK

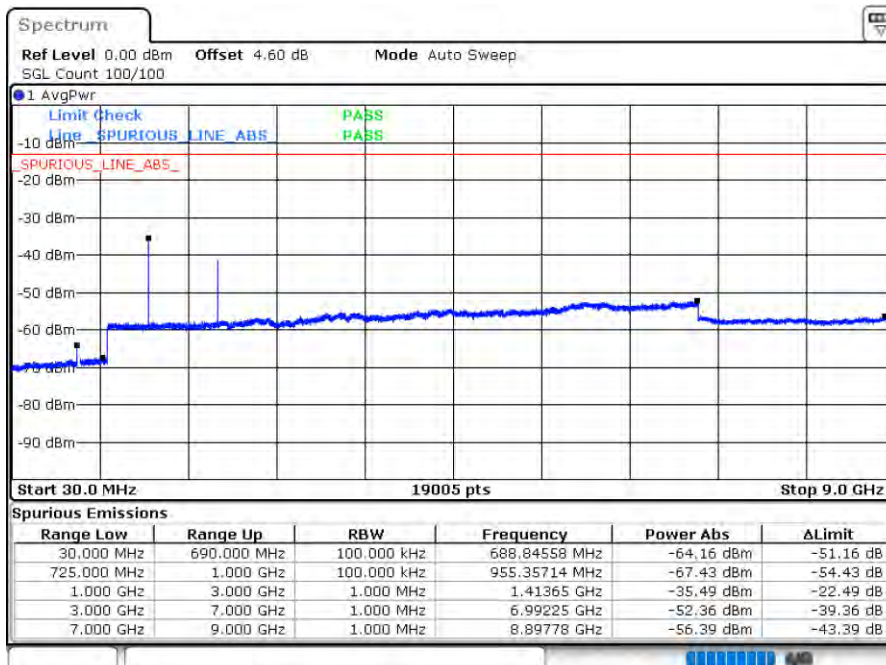

Date: 30-JUL-2023 13:09:10



Frequency Stability

Test Conditions		LTE Band 12 (QPSK) / Middle Channel	Limit
Temperature (°C)	Voltage (Volt)	BW 10MHz	Note 2.
		Deviation (ppm)	Result
50	Normal Voltage	0.0032	PASS
40	Normal Voltage	0.0006	
30	Normal Voltage	0.0048	
20(Ref.)	Normal Voltage	0.0000	
10	Normal Voltage	0.0039	
0	Normal Voltage	0.0026	
-10	Normal Voltage	0.0017	
-20	Normal Voltage	0.0051	
-30	Normal Voltage	0.0021	
20	Maximum Voltage	0.0015	
20	Normal Voltage	0.0008	
20	Battery End Point	0.0003	

Note:

1. Normal Voltage =3.87 V. ; Battery End Point (BEP) =3.5 V. ; Maximum Voltage =4.45 V.
2. Note: The frequency fundamental emissions stay within the authorized frequency block.



LTE Band 13

Peak-to-Average Ratio

Mode	LTE Band 13 / 10MHz		
Mod.	QPSK	16QAM	Limit: 13dB
RB Size	Full RB	Full RB	Result
Middle CH	4.26	5.25	PASS

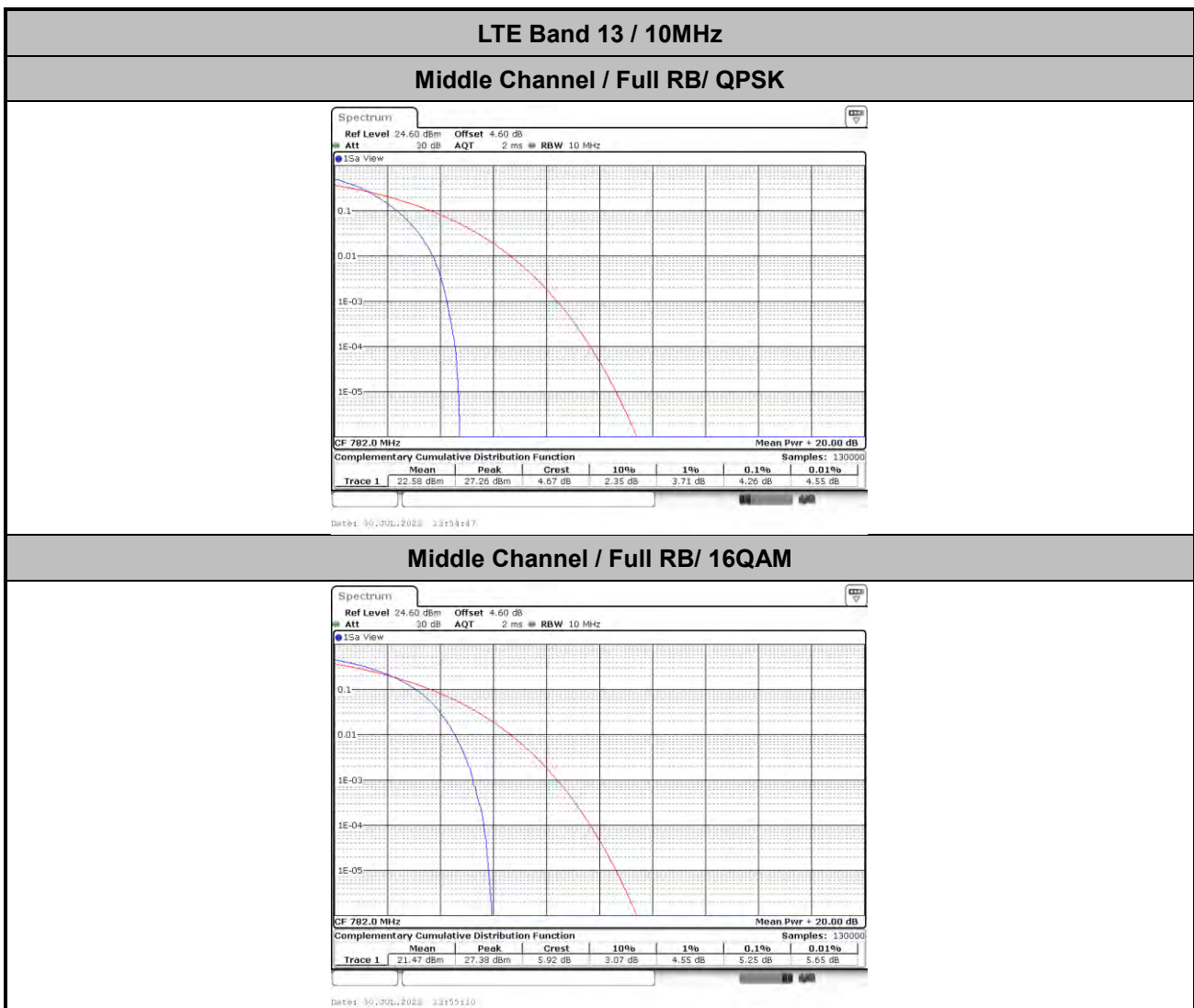



26dB Bandwidth

Mode	LTE Band 13 : 26dB BW(MHz)	
BW	5MHz	
Mod.	QPSK	16QAM
Middle CH	4.86	4.94
BW	10MHz	
Mod.	QPSK	16QAM
Middle CH	9.89	9.79

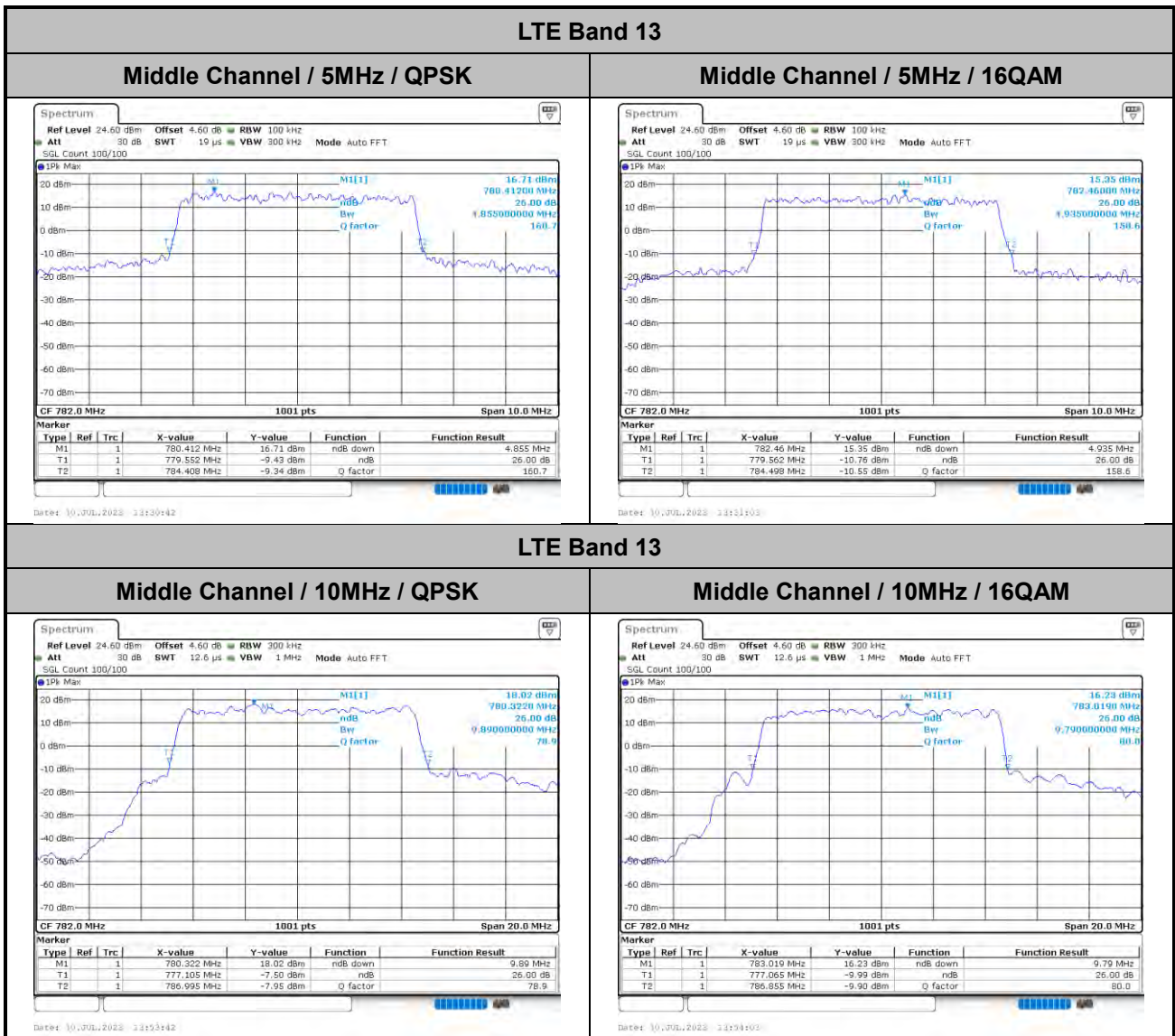



Occupied Bandwidth

Mode	LTE Band 13 : 99%OBW(MHz)	
BW	5MHz	
Mod.	QPSK	16QAM
Middle CH	4.51	4.48
BW	10MHz	
Mod.	QPSK	16QAM
Middle CH	9.03	9.03

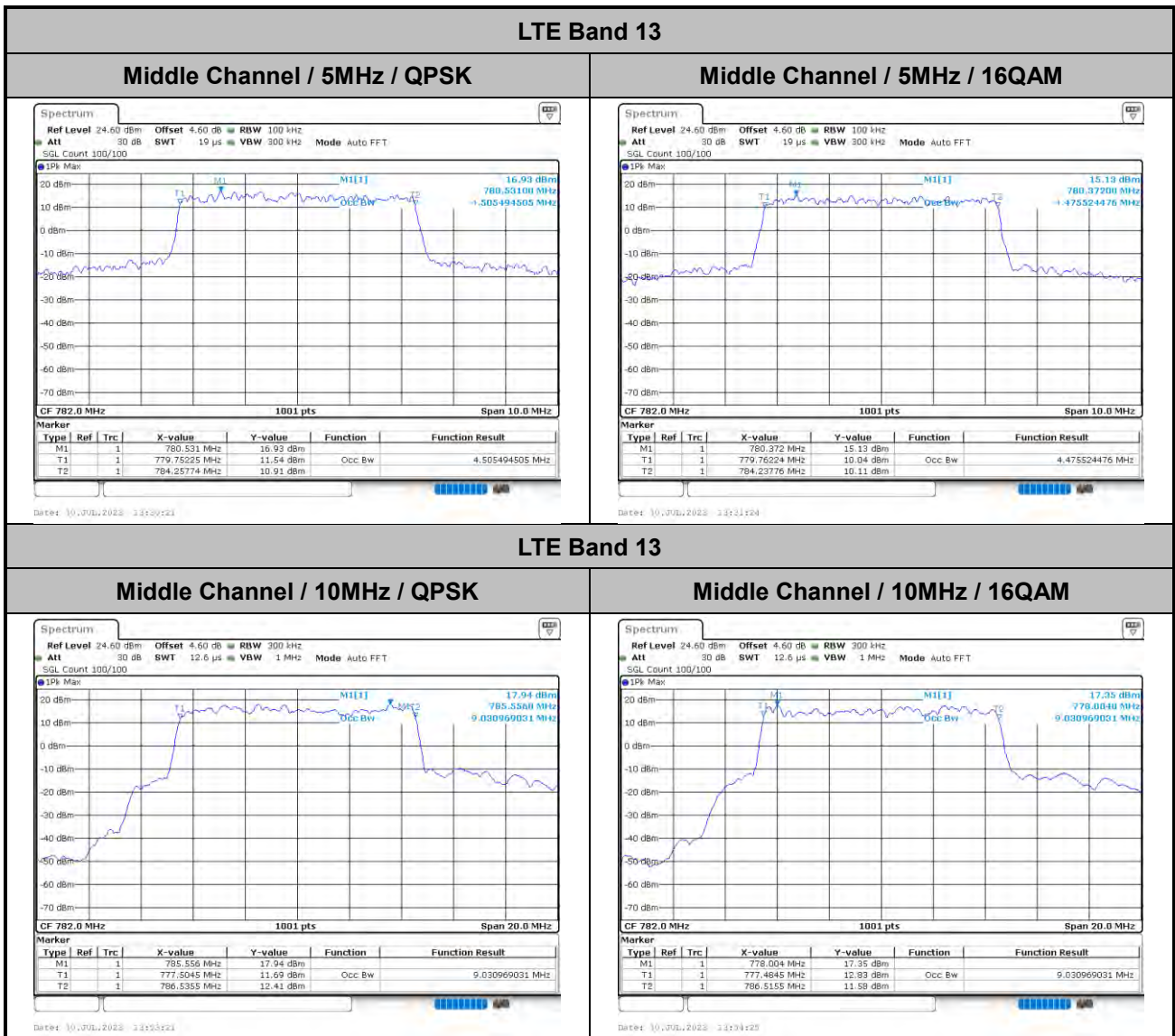



Conducted Band Edge

LTE Band 13 / 5MHz / QPSK

Lowest Band Edge / 1 RB

Highest Band Edge / 1 RB

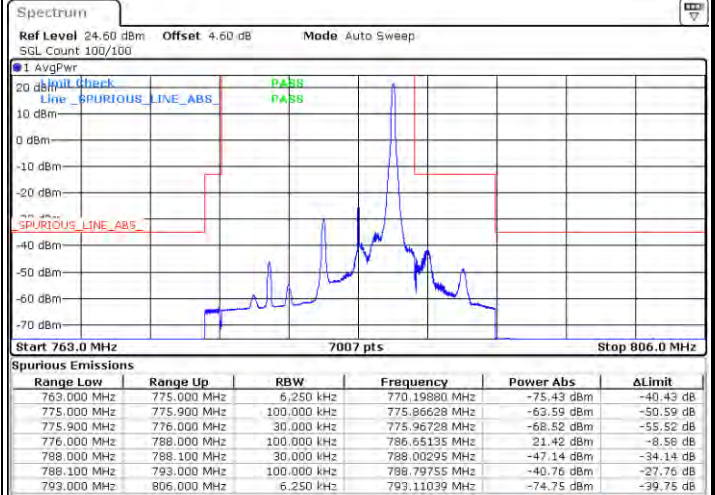
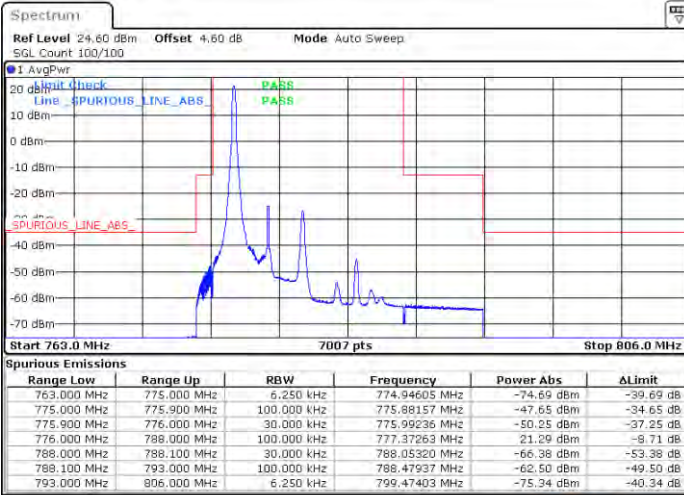

Date: 30.JUL.2023 13:23:11

Date: 30.JUL.2023 13:24:54

Lowest Band Edge / Full RB

Highest Band Edge / Full RB

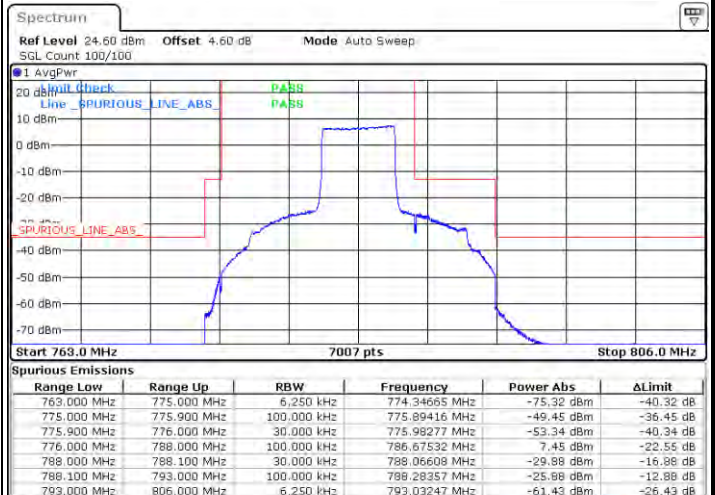
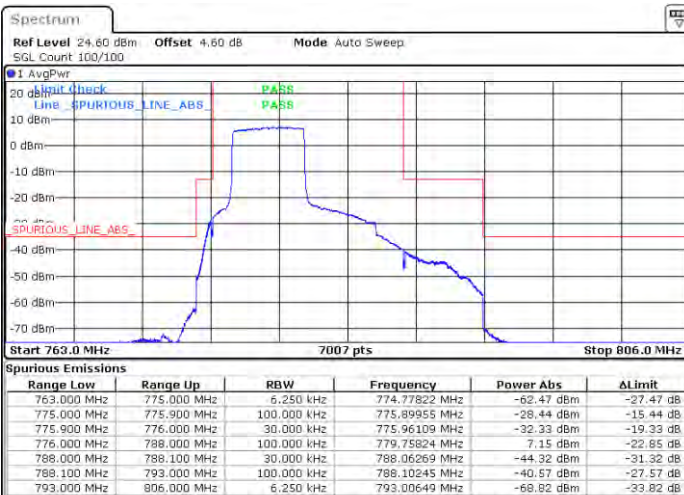

Date: 30.JUL.2023 13:26:41

Date: 30.JUL.2023 13:28:23



LTE Band 13 / 5MHz / 16QAM

Lowest Band Edge / 1RB

Highest Band Edge / 1 RB

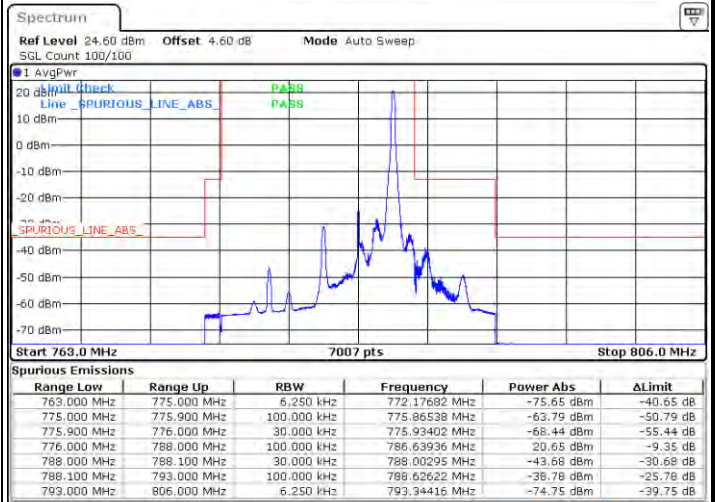
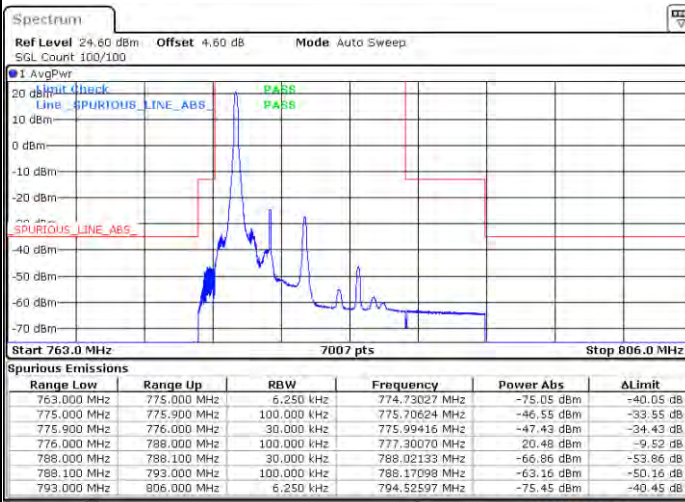

Date: 30.JUL.2023 13:23:01

Date: 30.JUL.2023 13:26:44

Lowest Band Edge / Full RB

Highest Band Edge / Full RB

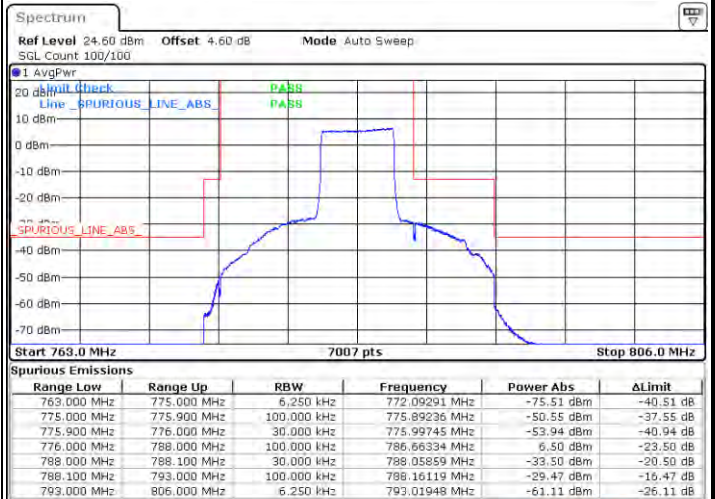
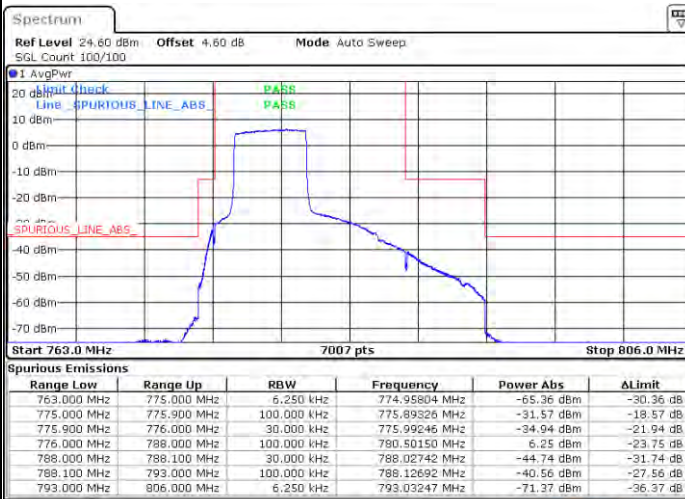

Date: 30.JUL.2023 13:24:51

Date: 30.JUL.2023 13:28:23



LTE Band 13 / 10MHz / QPSK

middle Band Edge / 1 RB

middle Band Edge / 1 RB

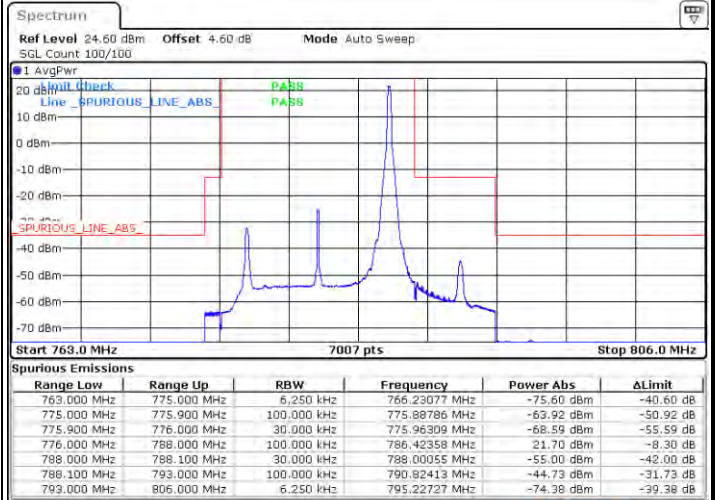
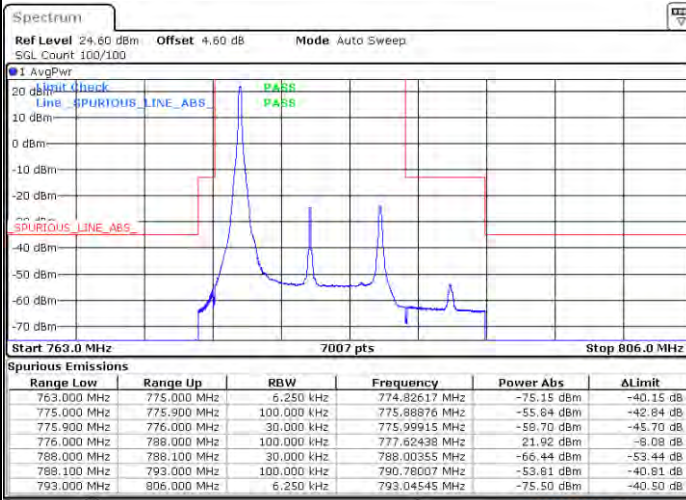

Date: 30.JUL.2023 13:47:42

Date: 30.JUL.2023 13:51:10

Middle Band Edge / Full RB

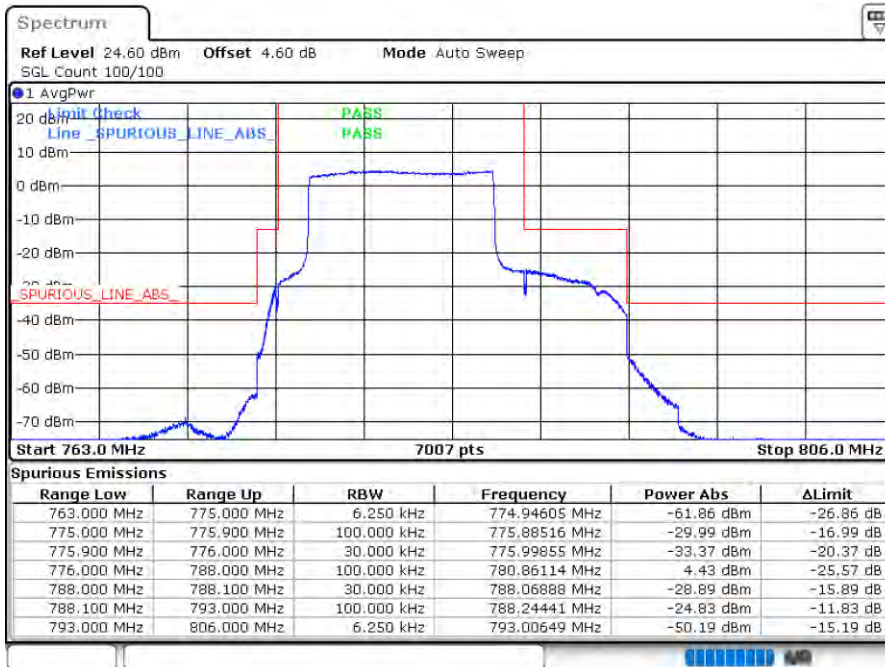

Date: 30.JUL.2023 13:42:14



LTE Band 13 / 10MHz / 16QAM

middle Band Edge / 1 RB

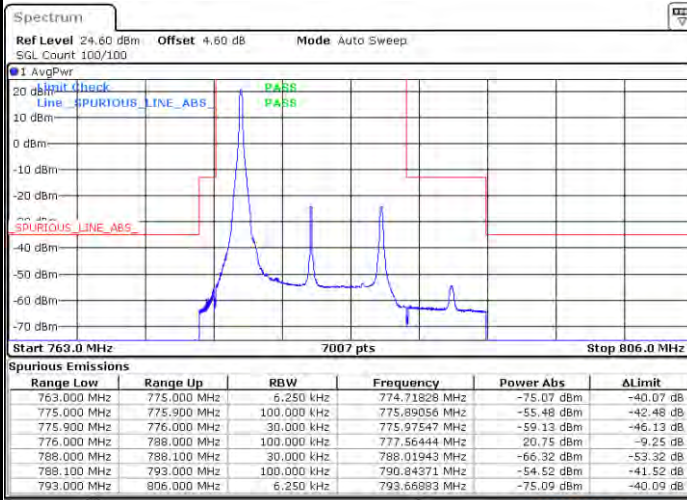

Date: 30.JUL.2023 13:45:52

middle Band Edge / 1 RB

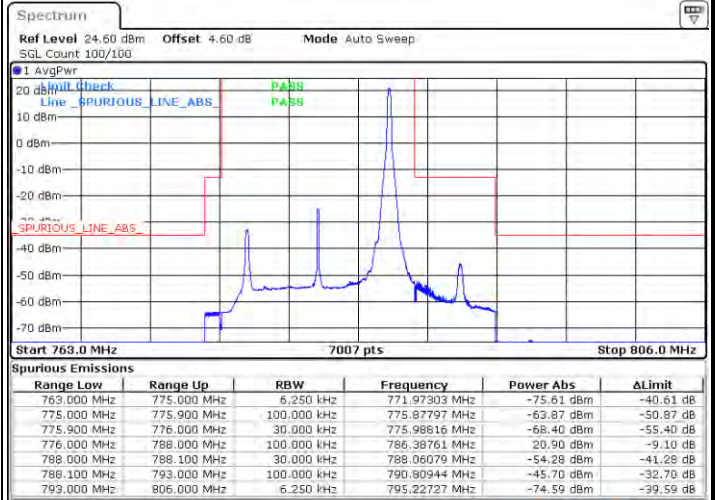

Date: 30.JUL.2023 13:53:00

middle Band Edge / Full RB

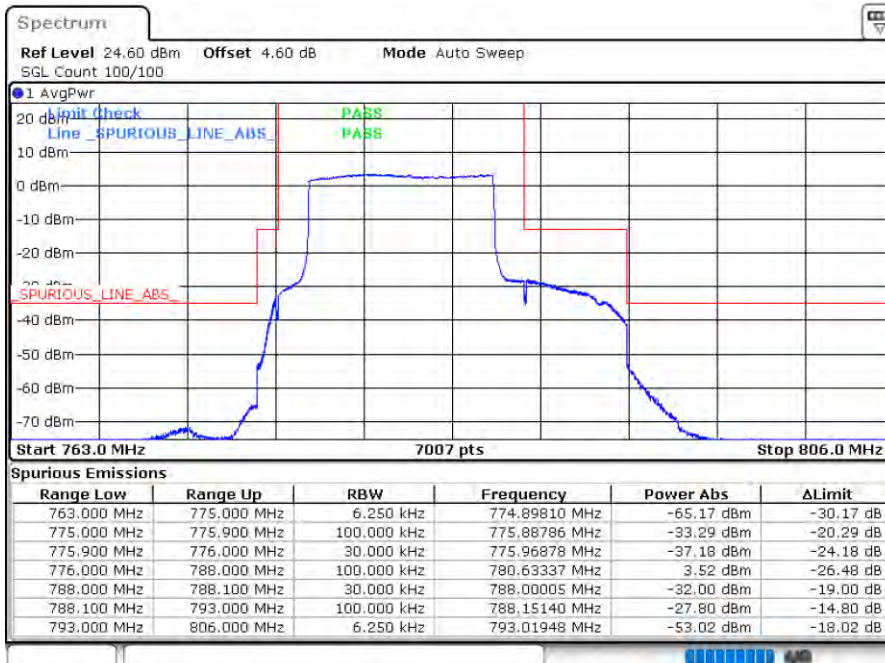

Date: 30.JUL.2023 13:44:03