

ELECTROMAGNETIC EMISSIONS COMPLIANCE REPORT

Applicant: GOOGLE LLC
1600 Amphitheatre Parkway Mountain View, CA 94043

Product Name: Wireless Streaming Device

Brand Name: Google

Model No.: G3AL9

Model Difference: N/A

Report Number: ER/2020/80015

FCC ID: A4RG3AL9

FCC Rule Part: §15.407, Cat: NII

Issue Date: Dec. 08, 2020

Date of Test: Aug. 06, 2020 ~ Sep. 25, 2020

Date of EUT Received: Aug. 06, 2020

We hereby certify that:

The above equipment was tested by SGS Taiwan Ltd. Central RF Lab The test data, data evaluation, test procedures, and equipment configurations shown in this report were made in accordance with the procedures given in ANSI C63.10: 2013 and the energy emitted by the sample EUT tested as described in this report is in compliance with conducted and radiated emission limits.

The test results of this report relate only to the tested sample identified in this report.

Approved By: _____



Blue Yang / Asst. Manager



Testing Laboratory
3702

Unless otherwise stated the results shown in this test report refer only to the sample(s) tested and such sample(s) are retained for 90 days only.

除非另有說明，此報告結果僅對測試之樣品負責，同時此樣品僅保留90天。本報告未經本公司書面許可，不可部份複製。

This document is issued by the Company subject to its General Conditions of Service printed overleaf, available on request or accessible at <http://www.sgs.com.tw/Terms-and-Conditions> and for electronic format documents, subject to Terms and Conditions for Electronic Documents at <http://www.sgs.com.tw/Terms-and-Conditions>. Attention is drawn to the limitation of liability, indemnification and jurisdiction issues defined therein. Any holder of this document is advised that information contained hereon reflects the Company's findings at the time of its intervention only and within the limits of Client's instructions, if any. The Company's sole responsibility is to its Client and this document does not exonerate parties to a transaction from exercising all their rights and obligations under the transaction documents. This document cannot be reproduced except in full, without prior written approval of the Company. Any unauthorized alteration, forgery or falsification of the content or appearance of this document is unlawful and offenders may be prosecuted to the fullest extent of the law.

Revision History

Report Number	Revision	Description	Issue Date	Remark
ER/2020/80015	Rev.00	Original.	Dec. 08, 2020	Revised By: Tiffany Kao

Note:

1、Disclaimer

Antenna information is provided by the applicant, test results of this report are applicable to the sample EUT received.

Unless otherwise stated the results shown in this test report refer only to the sample(s) tested and such sample(s) are retained for 90 days only.

除非另有說明，此報告結果僅對測試之樣品負責，同時此樣品僅保留90天。本報告未經本公司書面許可，不可部份複製。

This document is issued by the Company subject to its General Conditions of Service printed overleaf, available on request or accessible at <http://www.sgs.com.tw/Terms-and-Conditions> and for electronic format documents, subject to Terms and Conditions for Electronic Documents at <http://www.sgs.com.tw/Terms-and-Conditions>. Attention is drawn to the limitation of liability, indemnification and jurisdiction issues defined therein. Any holder of this document is advised that information contained hereon reflects the Company's findings at the time of its intervention only and within the limits of Client's instructions, if any. The Company's sole responsibility is to its Client and this document does not exonerate parties to a transaction from exercising all their rights and obligations under the transaction documents. This document cannot be reproduced except in full, without prior written approval of the Company. Any unauthorized alteration, forgery or falsification of the content or appearance of this document is unlawful and offenders may be prosecuted to the fullest extent of the law.

Contents

1	GENERAL INFORMATION	4
2	SYSTEM TEST CONFIGURATION.....	7
3	SUMMARY OF TEST RESULT	10
4	DESCRIPTION OF TEST MODES.....	11
5	MEASUREMENT UNCERTAINTY	14
6	CONDUCTED EMISSION TEST.....	15
7	DUTY CYCLE TEST SIGNAL	19
8	26dB & 6dB EMISSION BANDWIDTH MEASUREMENT.....	21
9	MAXIMUM CONDUCTED OUTPUT POWER MEASUREMENT	28
10	MAXIMUM POWER SPECTRAL DENSITY.....	31
11	UNDESIRABLE RADIATED EMISSION MEASUREMENT.....	38
12	TRANSMISSION IN THE ABSENCE OF DATA.....	124
13	FREQUENCY STABILITY.....	125
14	ANTENNA REQUIREMENT.....	128

Unless otherwise stated the results shown in this test report refer only to the sample(s) tested and such sample(s) are retained for 90 days only.

除非另有說明，此報告結果僅對測試之樣品負責，同時此樣品僅保留90天。本報告未經本公司書面許可，不可部份複製。

This document is issued by the Company subject to its General Conditions of Service printed overleaf, available on request or accessible at <http://www.sgs.com.tw/Terms-and-Conditions> and for electronic format documents, subject to Terms and Conditions for Electronic Documents at <http://www.sgs.com.tw/Terms-and-Conditions>. Attention is drawn to the limitation of liability, indemnification and jurisdiction issues defined therein. Any holder of this document is advised that information contained hereon reflects the Company's findings at the time of its intervention only and within the limits of Client's instructions, if any. The Company's sole responsibility is to its Client and this document does not exonerate parties to a transaction from exercising all their rights and obligations under the transaction documents. This document cannot be reproduced except in full, without prior written approval of the Company. Any unauthorized alteration, forgery or falsification of the content or appearance of this document is unlawful and offenders may be prosecuted to the fullest extent of the law.

1 GENERAL INFORMATION

1.1 Product Description

Product Name:	Wireless Streaming Device
Brand Name:	Google
Model No.:	G3AL9
Model Difference:	N/A
Hardware Version:	N/A
Software Version:	N/A
Power Supply:	3.65Vdc from Rechargeable Li-polymer Battery or 5V from AC/DC Adapter
Modulation type	64QAM, 16QAM, QPSK, BPSK for OFDM
Transition Rate:	802.11 a: 6/9/12/18/24/36/48/54 Mbps 802.11 n_20MHz: 6.5 – 72.2Mbps

1.2 Antenna Designation

Antenna Type	Supplier	Antenna Part No.	Freq. (MHz)	Peak Antenna Gain (dBi)	Worst Antenna Gain
PIFA	N/A	N/A	5150~5250	5.9	-
			5250~5350	5.9	-
			5470~5725	6.5	-
			5725~5850	6.6	-

Unless otherwise stated the results shown in this test report refer only to the sample(s) tested and such sample(s) are retained for 90 days only.

除非另有說明，此報告結果僅對測試之樣品負責，同時此樣品僅保留90天。本報告未經本公司書面許可，不可部份複製。

This document is issued by the Company subject to its General Conditions of Service printed overleaf, available on request or accessible at <http://www.sgs.com.tw/Terms-and-Conditions> and for electronic format documents, subject to Terms and Conditions for Electronic Documents at <http://www.sgs.com.tw/Terms-and-Conditions>. Attention is drawn to the limitation of liability, indemnification and jurisdiction issues defined therein. Any holder of this document is advised that information contained hereon reflects the Company's findings at the time of its intervention only and within the limits of Client's instructions, if any. The Company's sole responsibility is to its Client and this document does not exonerate parties to a transaction from exercising all their rights and obligations under the transaction documents. This document cannot be reproduced except in full, without prior written approval of the Company. Any unauthorized alteration, forgery or falsification of the content or appearance of this document is unlawful and offenders may be prosecuted to the fullest extent of the law.

1.3 FCC worst power

Wi-Fi 802.11	Frequency Range	Channels	Rated Power (Avg.) (dBm) (Worst case)	Modulation Technology
a	5150~5250	4	15.48	OFDM
	5250~5350	4	15.47	
	5470~5725	12	15.44	
	5725~5850	5	15.38	
n_HT 20M	5150~5250	4	HT: 15.46	OFDM
	5250~5350	4	HT: 15.49	
	5470~5725	12	HT: 15.47	
	5725~5850	5	HT: 15.49	

Unless otherwise stated the results shown in this test report refer only to the sample(s) tested and such sample(s) are retained for 90 days only.

除非另有說明，此報告結果僅對測試之樣品負責，同時此樣品僅保留90天。本報告未經本公司書面許可，不可部份複製。

This document is issued by the Company subject to its General Conditions of Service printed overleaf, available on request or accessible at <http://www.sgs.com.tw/Terms-and-Conditions> and for electronic format documents, subject to Terms and Conditions for Electronic Documents at <http://www.sgs.com.tw/Terms-and-Conditions>. Attention is drawn to the limitation of liability, indemnification and jurisdiction issues defined therein. Any holder of this document is advised that information contained hereon reflects the Company's findings at the time of its intervention only and within the limits of Client's instructions, if any. The Company's sole responsibility is to its Client and this document does not exonerate parties to a transaction from exercising all their rights and obligations under the transaction documents. This document cannot be reproduced except in full, without prior written approval of the Company. Any unauthorized alteration, forgery or falsification of the content or appearance of this document is unlawful and offenders may be prosecuted to the fullest extent of the law.

1.4 Test Methodology of Applied Standards

FCC Part 15, Subpart E §15.407
FCC KDB 789033 D02 General UNII Test Procedures New Rules v02r01
FCC KDB 662911 D01 Multiple Transmitter Output v02r01
ANSI C63.10:2013

1.5 Test Facility

SGS Taiwan Ltd. Central RF Lab (TAF code 3702)
No.134, Wu Kung Road, New Taipei Industrial Park, Wuku District, New Taipei City, Taiwan
24803

FCC Designation number: TW0027

1.6 Special Accessories

There are no special accessories used while test was conducted.

1.7 Equipment Modifications

There was no modification incorporated into the EUT.

Unless otherwise stated the results shown in this test report refer only to the sample(s) tested and such sample(s) are retained for 90 days only.

除非另有說明，此報告結果僅對測試之樣品負責，同時此樣品僅保留90天。本報告未經本公司書面許可，不可部份複製。

This document is issued by the Company subject to its General Conditions of Service printed overleaf, available on request or accessible at <http://www.sgs.com.tw/Terms-and-Conditions> and for electronic format documents, subject to Terms and Conditions for Electronic Documents at <http://www.sgs.com.tw/Terms-and-Conditions>. Attention is drawn to the limitation of liability, indemnification and jurisdiction issues defined therein. Any holder of this document is advised that information contained hereon reflects the Company's findings at the time of its intervention only and within the limits of Client's instructions, if any. The Company's sole responsibility is to its Client and this document does not exonerate parties to a transaction from exercising all their rights and obligations under the transaction documents. This document cannot be reproduced except in full, without prior written approval of the Company. Any unauthorized alteration, forgery or falsification of the content or appearance of this document is unlawful and offenders may be prosecuted to the fullest extent of the law.

2 SYSTEM TEST CONFIGURATION

2.1 EUT Configuration

The EUT configuration for testing is installed on RF field strength measurement to meet the Commissions requirement and operating in a manner which intends to maximize its emission characteristics in a continuous normal application.

2.2 EUT Exercise

An engineering test mode (software/firmware) that applicant provided was utilized to manipulate the EUT into transmit, selection of the test channel, and modulation scheme.

2.3 Test Procedure

2.3.1 Conducted Emissions

The EUT is placed on a table which is 0.8 m above ground plane. Conducted emissions from the EUT measured in the frequency range between 0.15 MHz and 30MHz. The CISPR Quasi-Peak and Average detector mode is employed. The two LISNs provide 50uH/50 ohm of coupling impedance for the measuring instrument. Both lines of the power mains connected to the EUT were checked for maximum conducted interference.

2.3.2 Conducted Test (RF)

The active antenna port of the unlicensed wireless device is connected to the spectrum analyzer with attenuator to protect the instrumentation. If a second antenna port is available, it is tested at one operating frequency, with other port(s) appropriately terminated, to verify it has similar output characteristics as the fully tested port.

2.3.3 Radiated Emissions

The EUT is placed on a turn table. For emissions testing at or below 1 GHz, the table height shall be 0.8 m above the reference ground plane. For emission measurements above 1 GHz, the table height shall be 1.5 m. The turn table shall rotate 360 degrees to determine the position of maximum emission level. EUT is set 3m away from the receiving antenna which varied from 1m to 4m to find out the highest emission. And also, each emission was to be maximized by changing the polarization of receiving antenna both horizontal and vertical. In order to find out the max. emission, the relative positions of this transmitter (EUT) was rotated through three orthogonal axes and measurement procedures for electric field radiated emissions above 1 GHz the EUT measurement is to be made "while keeping the antenna in the 'cone of radiation' from that area and pointed at the area both in azimuth and elevation, with polarization oriented for maximum response." is still within the 3dB illumination BW of the measurement antenna.

Unless otherwise stated the results shown in this test report refer only to the sample(s) tested and such sample(s) are retained for 90 days only.

除非另有說明，此報告結果僅對測試之樣品負責，同時此樣品僅保留90天。本報告未經本公司書面許可，不可部份複製。

This document is issued by the Company subject to its General Conditions of Service printed overleaf, available on request or accessible at <http://www.sgs.com.tw/Terms-and-Conditions> and for electronic format documents, subject to Terms and Conditions for Electronic Documents at <http://www.sgs.com.tw/Terms-and-Conditions>. Attention is drawn to the limitation of liability, indemnification and jurisdiction issues defined therein. Any holder of this document is advised that information contained hereon reflects the Company's findings at the time of its intervention only and within the limits of Client's instructions, if any. The Company's sole responsibility is to its Client and this document does not exonerate parties to a transaction from exercising all their rights and obligations under the transaction documents. This document cannot be reproduced except in full, without prior written approval of the Company. Any unauthorized alteration, forgery or falsification of the content or appearance of this document is unlawful and offenders may be prosecuted to the fullest extent of the law.

2.4 Measurement Results Explanation Example

2.4.1 Radiated Emission Test Sites For Measurements From 9 kHz To 30 MHz

Radiated emission below 30MHz is measured in a 9m*9m*6m semi-anechoic chamber, the measurements correspond to those obtained at an open-field test site.

There is a comparison data of both open-field test site and semi-Anechoic chamber, and the result came out very similar.

2.4.2 For all conducted test items:

The offset level is set in the spectrum analyzer to compensate the RF cable loss and attenuation factor between EUT conducted port and spectrum analyzer. With the offset compensation, the spectrum analyzer reading level is exactly EUT RF output level.

Unless otherwise stated the results shown in this test report refer only to the sample(s) tested and such sample(s) are retained for 90 days only.

除非另有說明，此報告結果僅對測試之樣品負責，同時此樣品僅保留90天。本報告未經本公司書面許可，不可部份複製。

This document is issued by the Company subject to its General Conditions of Service printed overleaf, available on request or accessible at <http://www.sgs.com.tw/Terms-and-Conditions> and for electronic format documents, subject to Terms and Conditions for Electronic Documents at <http://www.sgs.com.tw/Terms-and-Conditions>. Attention is drawn to the limitation of liability, indemnification and jurisdiction issues defined therein. Any holder of this document is advised that information contained hereon reflects the Company's findings at the time of its intervention only and within the limits of Client's instructions, if any. The Company's sole responsibility is to its Client and this document does not exonerate parties to a transaction from exercising all their rights and obligations under the transaction documents. This document cannot be reproduced except in full, without prior written approval of the Company. Any unauthorized alteration, forgery or falsification of the content or appearance of this document is unlawful and offenders may be prosecuted to the fullest extent of the law.

2.5 Configuration of Tested System

Fig. 2-1 Radiated Emission Configuration



Fig. 2-3 Conducted (AC powerline) Emission Configuration

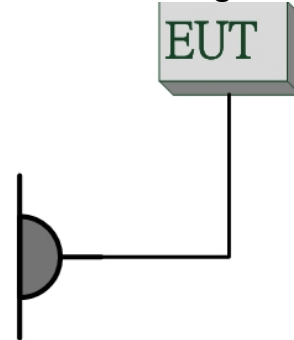

Fig. 2-2 Conducted (Antenna Port) Emission Configuration

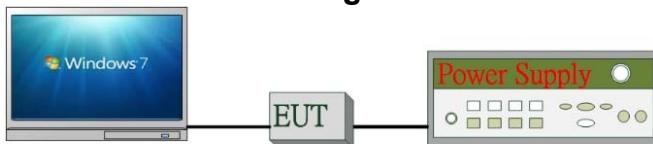

Table 2-1 Equipment Used in Tested System

Item	Equipment	Mfr/Brand	Model/Type No.	Series No.	Data Cable	Power Cord
1.	WLAN 5G Test software	N/A	N/A	N/A	N/A	N/A
2.	Notebook	Lenovo	T440P	PC-014TAK	N/A	N/A
3.	DC Power Supply	Agilent	E3640A	MY40000811	N/A	N/A

Unless otherwise stated the results shown in this test report refer only to the sample(s) tested and such sample(s) are retained for 90 days only.

除非另有說明，此報告結果僅對測試之樣品負責，同時此樣品僅保留90天。本報告未經本公司書面許可，不可部份複製。

This document is issued by the Company subject to its General Conditions of Service printed overleaf, available on request or accessible at <http://www.sgs.com.tw/Terms-and-Conditions> and for electronic format documents, subject to Terms and Conditions for Electronic Documents at <http://www.sgs.com.tw/Terms-and-Conditions>. Attention is drawn to the limitation of liability, indemnification and jurisdiction issues defined therein. Any holder of this document is advised that information contained hereon reflects the Company's findings at the time of its intervention only and within the limits of Client's instructions, if any. The Company's sole responsibility is to its Client and this document does not exonerate parties to a transaction from exercising all their rights and obligations under the transaction documents. This document cannot be reproduced except in full, without prior written approval of the Company. Any unauthorized alteration, forgery or falsification of the content or appearance of this document is unlawful and offenders may be prosecuted to the fullest extent of the law.

3 SUMMARY OF TEST RESULT

FCC Rules	Description Of Test	Result
§15.207	AC Power Line Conducted Emission	Compliant
§15.403(i) §15.407(e)	26 dB & 6dB Emission Bandwidth	Compliant
§15.407(a)	Maximum Conducted Output Power	Compliant
§15.407(a)	Power Spectral Density	Compliant
§15.205 §15.209 §15.407(b)	Undesirable Radiated Emissions	Compliant
§15.407(c)	Transmission in case of Absence of Information	Compliant
§15.407(g)	Frequency Stability	Compliant
§15.203 §15.407(a)	Antenna Requirement	Compliant

Unless otherwise stated the results shown in this test report refer only to the sample(s) tested and such sample(s) are retained for 90 days only.

除非另有說明，此報告結果僅對測試之樣品負責，同時此樣品僅保留90天。本報告未經本公司書面許可，不可部份複製。

This document is issued by the Company subject to its General Conditions of Service printed overleaf, available on request or accessible at <http://www.sgs.com.tw/Terms-and-Conditions> and for electronic format documents, subject to Terms and Conditions for Electronic Documents at <http://www.sgs.com.tw/Terms-and-Conditions>. Attention is drawn to the limitation of liability, indemnification and jurisdiction issues defined therein. Any holder of this document is advised that information contained hereon reflects the Company's findings at the time of its intervention only and within the limits of Client's instructions, if any. The Company's sole responsibility is to its Client and this document does not exonerate parties to a transaction from exercising all their rights and obligations under the transaction documents. This document cannot be reproduced except in full, without prior written approval of the Company. Any unauthorized alteration, forgery or falsification of the content or appearance of this document is unlawful and offenders may be prosecuted to the fullest extent of the law.

4 DESCRIPTION OF TEST MODES

4.1 802.11a/n operated in U-NII Bands

Operated band in 5150 MHz ~5250 MHz:

20 M	
CH	Freq (MHz)
36	5180
40	5200
44	5220
48	5240

Operated band in 5250 MHz ~5350 MHz:

20 M	
CH	Freq (MHz)
52	5260
56	5280
60	5300
64	5320

Operated band in 5470 MHz ~5725 MHz:

20 M	
CH	Freq (MHz)
100	5500
104	5520
108	5540
112	5560
116	5580
120	5600
124	5620
128	5640
132	5660
136	5680
140	5700

Operated band in 5745 MHz ~5850 MHz:

20 M	
CH	Freq (MHz)
149	5745
153	5765
157	5785
161	5805
165	5825

Unless otherwise stated the results shown in this test report refer only to the sample(s) tested and such sample(s) are retained for 90 days only.

除非另有說明，此報告結果僅對測試之樣品負責，同時此樣品僅保留90天。本報告未經本公司書面許可，不可部份複製。

This document is issued by the Company subject to its General Conditions of Service printed overleaf, available on request or accessible at <http://www.sgs.com.tw/Terms-and-Conditions> and for electronic format documents, subject to Terms and Conditions for Electronic Documents at <http://www.sgs.com.tw/Terms-and-Conditions>. Attention is drawn to the limitation of liability, indemnification and jurisdiction issues defined therein. Any holder of this document is advised that information contained hereon reflects the Company's findings at the time of its intervention only and within the limits of Client's instructions, if any. The Company's sole responsibility is to its Client and this document does not exonerate parties to a transaction from exercising all their rights and obligations under the transaction documents. This document cannot be reproduced except in full, without prior written approval of the Company. Any unauthorized alteration, forgery or falsification of the content or appearance of this document is unlawful and offenders may be prosecuted to the fullest extent of the law.

4.2 The Worst Test Modes and Channel Details

1. The EUT has been tested under operating condition.
2. Test program used to control the EUT for staying in continuous transmitting mode is programmed.
3. Investigation has been done on all the possible configurations for searching the worst case. The given UE is pre-scanned among below modes.

Modulation	Transmission Chain				Multiple Transmission Spatial
<input checked="" type="checkbox"/> 802.11 a	<input checked="" type="checkbox"/> Ch0	<input checked="" type="checkbox"/> Ch1	<input type="checkbox"/> Ch2	<input type="checkbox"/> Ch3	<input type="checkbox"/> 2TX
<input checked="" type="checkbox"/> 802.11 n	<input checked="" type="checkbox"/> Ch0	<input checked="" type="checkbox"/> Ch1	<input type="checkbox"/> Ch2	<input type="checkbox"/> Ch3	<input type="checkbox"/> MIMO

4. Therefore, below summary is the modes of test configuration that yield the highest reading and generate the highest emission chosen to carry out the relevantly mandatory test items.

Unless otherwise stated the results shown in this test report refer only to the sample(s) tested and such sample(s) are retained for 90 days only.

除非另有說明，此報告結果僅對測試之樣品負責，同時此樣品僅保留90天。本報告未經本公司書面許可，不可部份複製。

This document is issued by the Company subject to its General Conditions of Service printed overleaf, available on request or accessible at <http://www.sgs.com.tw/Terms-and-Conditions> and for electronic format documents, subject to Terms and Conditions for Electronic Documents at <http://www.sgs.com.tw/Terms-and-Conditions>. Attention is drawn to the limitation of liability, indemnification and jurisdiction issues defined therein. Any holder of this document is advised that information contained hereon reflects the Company's findings at the time of its intervention only and within the limits of Client's instructions, if any. The Company's sole responsibility is to its Client and this document does not exonerate parties to a transaction from exercising all their rights and obligations under the transaction documents. This document cannot be reproduced except in full, without prior written approval of the Company. Any unauthorized alteration, forgery or falsification of the content or appearance of this document is unlawful and offenders may be prosecuted to the fullest extent of the law.

4.2.1 RADIATED EMISSION TEST:

RADIATED EMISSION TEST (BELOW 1 GHz)						
MODE	FREQUENCY BAND (MHz)	AVAILABLE CHANNEL	TESTED CHANNEL	MODULATION	DATA RATE (Mbps)	AN-TENNA PORT
802.11a	5180~5240	36 to 48	44	OFDM	6	Ch0
	5260~5320	52 to 64	60			
	5500~5700	100 to 140	116			
	5745~5825	149 to 165	157			

RADIATED EMISSION TEST (ABOVE 1 GHz)						
MODE	FREQUENCY BAND (MHz)	AVAILABLE CHANNEL	TESTED CHANNEL	MODULATION	DATA RATE (Mbps)	AN-TENNA PORT
802.11a	5180~5240	36 to 48	36,44,48	OFDM	6	Ch0
	5260~5320	52 to 64	52,60,64			
	5500~5700	100 to 140	100,116,140			
	5745~5825	149 to 165	149,157,165			
802.11n_HT20	5180~5240	36 to 48	36,44,48	OFDM	MCS0	Ch0
	5260~5320	52 to 64	52,60,64			
	5500~5700	100 to 140	100,116,140			
	5745~5825	149 to 165	149,157,165			

Note:

The field strength of radiation emission was measured as EUT stand-up position (H mode) and lie down position (E1, E2 mode) for 802.11a/n/ac WLAN Transmitter for channel Low, Mid and High, the worst case H position was reported.

4.2.2 ANTENNA PORT CONDUCTED MEASUREMENT:

CONDUCTED TEST						
MODE	FREQUENCY BAND (MHz)	AVAILABLE CHANNEL	TESTED CHANNEL	MODULATION	DATA RATE (Mbps)	AN-TENNA PORT
802.11a	5180~5240	36 to 48	36,44,48	OFDM	6	Ch0
	5260~5320	52 to 64	52,60,64			
	5500~5700	100 to 140	100,116,140			
	5745~5825	149 to 165	149,157,165			
802.11n_HT20	5180~5240	36 to 48	36,44,48	OFDM	MCS0	Ch0
	5260~5320	52 to 64	52,60,64			
	5500~5700	100 to 140	100,116,140			
	5745~5825	149 to 165	149,157,165			

Unless otherwise stated the results shown in this test report refer only to the sample(s) tested and such sample(s) are retained for 90 days only.

除非另有說明，此報告結果僅對測試之樣品負責，同時此樣品僅保留90天。本報告未經本公司書面許可，不可部份複製。

This document is issued by the Company subject to its General Conditions of Service printed overleaf, available on request or accessible at <http://www.sgs.com.tw/Terms-and-Conditions> and for electronic format documents, subject to Terms and Conditions for Electronic Documents at <http://www.sgs.com.tw/Terms-and-Conditions>. Attention is drawn to the limitation of liability, indemnification and jurisdiction issues defined therein. Any holder of this document is advised that information contained hereon reflects the Company's findings at the time of its intervention only and within the limits of Client's instructions, if any. The Company's sole responsibility is to its Client and this document does not exonerate parties to a transaction from exercising all their rights and obligations under the transaction documents. This document cannot be reproduced except in full, without prior written approval of the Company. Any unauthorized alteration, forgery or falsification of the content or appearance of this document is unlawful and offenders may be prosecuted to the fullest extent of the law.

5 MEASUREMENT UNCERTAINTY

Test Items	Uncertainty
AC Power Line Conducted Emission	+/- 2.586 dB
26dB & 6dB Emission Bandwidth	+/- 123.36 Hz
The Maximum Output Power Measurement	+/- 0.96 dB
Peak Power Spectral Density Measurement	+/- 1.67 dB
Frequency Stability	+/- 123.36 Hz
Temperature	+/- 0.65 °C
Humidity	+/- 4.6 %
DC / AC Power Source	DC= +/- 0.13%, AC=+/- 0.2%

Radiated Spurious Emission Measurement Uncertainty	
Polarization: Vertical	9kHz~30MHz: +2.3dB
	30MHz - 180MHz: +/- 3.37dB
	180MHz -417MHz: +/- 3.19dB
	0.417GHz-1GHz: +/- 3.19dB
	1GHz - 18GHz: +/- 4.04dB
	18GHz - 40GHz: +/- 4.04dB
Polarization: Horizontal	9kHz~30MHz: +2.3dB
	30MHz - 167MHz: +/- 4.22dB
	167MHz -500MHz: +/- 3.44dB
	0.5GHz-1GHz: +/- 3.39dB
	1GHz - 18GHz: +/- 4.08dB
	18GHz - 40GHz: +/- 4.08dB

Note:

1. This uncertainty represents an expanded uncertainty expressed at approximately the 95% confidence level using a coverage factor of k=2.
2. The conformity assessment statement in this report is based solely on the test results, measurement uncertainty is excluded.

Unless otherwise stated the results shown in this test report refer only to the sample(s) tested and such sample(s) are retained for 90 days only.

除非另有說明，此報告結果僅對測試之樣品負責，同時此樣品僅保留90天。本報告未經本公司書面許可，不可部份複製。

This document is issued by the Company subject to its General Conditions of Service printed overleaf, available on request or accessible at <http://www.sgs.com.tw/Terms-and-Conditions> and for electronic format documents, subject to Terms and Conditions for Electronic Documents at <http://www.sgs.com.tw/Terms-and-Conditions>. Attention is drawn to the limitation of liability, indemnification and jurisdiction issues defined therein. Any holder of this document is advised that information contained hereon reflects the Company's findings at the time of its intervention only and within the limits of Client's instructions, if any. The Company's sole responsibility is to its Client and this document does not exonerate parties to a transaction from exercising all their rights and obligations under the transaction documents. This document cannot be reproduced except in full, without prior written approval of the Company. Any unauthorized alteration, forgery or falsification of the content or appearance of this document is unlawful and offenders may be prosecuted to the fullest extent of the law.

6 CONDUCTED EMISSION TEST

6.1 Standard Applicable

Frequency range within 150 kHz to 30 MHz shall not exceed the Limit table as below.

Frequency range MHz	Limits dB(uV)	
	Quasi-peak	Average
0.15 to 0.50	66 to 56	56 to 46
0.50 to 5	56	46
5 to 30	60	50

Note

- 1.The lower limit shall apply at the transition frequencies
- 2.The limit decreases linearly with the logarithm of the frequency in the range 0.15 MHz to 0.50 MHz.

6.2 Measurement Equipment Used

Conducted Emission Test Site					
EQUIPMENT TYPE	MFR	MODEL NUMBER	SERIAL NUMBER	LAST CAL.	CAL DUE.
EMI Test Receiver	R&S	ESCI 7	100759	07/13/2020	07/12/2021
LISN	SCHWARZBECK	NSLK 8127	8127-465	04/09/2020	04/08/2021
Coaxial Cables	N/A	Coaxial Cable	161207	12/07/2019	12/06/2020
Test Software	audix	e3	Ver. 6.11-20180413	N.C.R	N.C.R

6.3 EUT Setup

1. The conducted emission tests were performed in the test site, using the setup in accordance with the ANSI C63.10:2013.
2. The AC/DC Power adaptor of EUT was plug-in LISN. The rear of the EUT and peripherals were placed flushed with the rear of the tabletop.
3. The LISN was connected with 120Vac/60Hz power source.

Unless otherwise stated the results shown in this test report refer only to the sample(s) tested and such sample(s) are retained for 90 days only.

除非另有說明，此報告結果僅對測試之樣品負責，同時此樣品僅保留90天。本報告未經本公司書面許可，不可部份複製。

This document is issued by the Company subject to its General Conditions of Service printed overleaf, available on request or accessible at <http://www.sgs.com.tw/Terms-and-Conditions> and for electronic format documents, subject to Terms and Conditions for Electronic Documents at <http://www.sgs.com.tw/Terms-and-Conditions>. Attention is drawn to the limitation of liability, indemnification and jurisdiction issues defined therein. Any holder of this document is advised that information contained hereon reflects the Company's findings at the time of its intervention only and within the limits of Client's instructions, if any. The Company's sole responsibility is to its Client and this document does not exonerate parties to a transaction from exercising all their rights and obligations under the transaction documents. This document cannot be reproduced except in full, without prior written approval of the Company. Any unauthorized alteration, forgery or falsification of the content or appearance of this document is unlawful and offenders may be prosecuted to the fullest extent of the law.

6.4 Test SET-UP

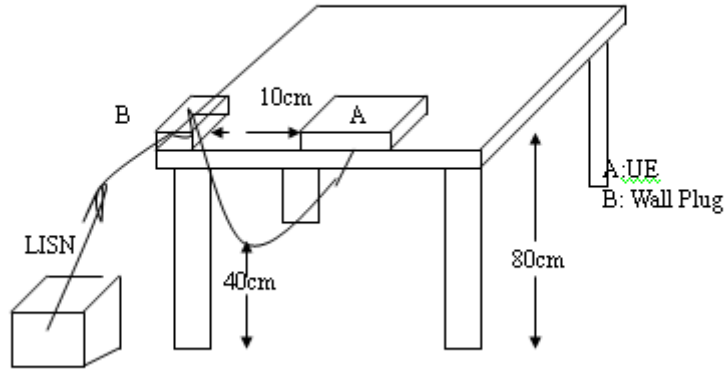

6.5 Measurement Procedure

1. The EUT was placed on a table which is 0.8m above ground plane.
2. Maximum procedure was performed on the six highest emissions to ensure EUT compliance.
3. Repeat above procedures until all phases of power being supplied by given UE are completed.

6.6 Measurement Result

Note: Refer to next page for measurement data and plots.

Note2: The * reveals the worst-case results that closet to the limit.

Unless otherwise stated the results shown in this test report refer only to the sample(s) tested and such sample(s) are retained for 90 days only.

除非另有說明，此報告結果僅對測試之樣品負責，同時此樣品僅保留90天。本報告未經本公司書面許可，不可部份複製。

This document is issued by the Company subject to its General Conditions of Service printed overleaf, available on request or accessible at <http://www.sgs.com.tw/Terms-and-Conditions> and for electronic format documents, subject to Terms and Conditions for Electronic Documents at <http://www.sgs.com.tw/Terms-and-Conditions>. Attention is drawn to the limitation of liability, indemnification and jurisdiction issues defined therein. Any holder of this document is advised that information contained hereon reflects the Company's findings at the time of its intervention only and within the limits of Client's instructions, if any. The Company's sole responsibility is to its Client and this document does not exonerate parties to a transaction from exercising all their rights and obligations under the transaction documents. This document cannot be reproduced except in full, without prior written approval of the Company. Any unauthorized alteration, forgery or falsification of the content or appearance of this document is unlawful and offenders may be prosecuted to the fullest extent of the law.

AC POWER LINE CONDUCTED EMISSION TEST DATA

Report Number	:ER-2020-80015	Test Site	:Conduction 6F
Test Mode	:WLAN 5G	Test Date	:2020-08-10
Power	:AC 120V/60Hz	Temp./Humi.	:26.2/53
Probe	:L	Engineer	:Nick
Note:	:		

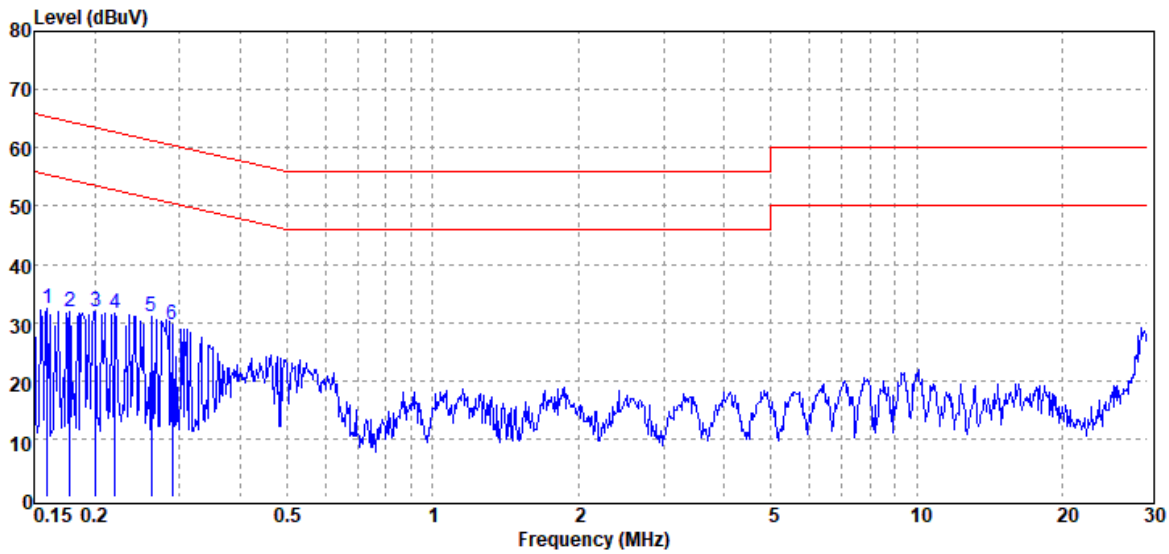

Freq. MHz	Detector Mode PK/QP/AV	Spectrum Reading Level dBµV	Factor dB	Actual FS dBµV	Limit dBµV	Margin dB
0.16	Peak	30.24	2.14	32.38	65.47	-33.09
0.18	Peak	29.59	2.14	31.73	64.59	-32.86
0.20	Peak	29.61	2.14	31.75	63.58	-31.83
0.22	Peak	29.30	2.14	31.44	62.79	-31.35
0.26	Peak	28.79	2.14	30.93	61.38	-30.45
0.29	Peak	27.57	2.15	29.72	60.54	-30.82

Unless otherwise stated the results shown in this test report refer only to the sample(s) tested and such sample(s) are retained for 90 days only.

除非另有說明，此報告結果僅對測試之樣品負責，同時此樣品僅保留90天。本報告未經本公司書面許可，不可部份複製。

This document is issued by the Company subject to its General Conditions of Service printed overleaf, available on request or accessible at <http://www.sgs.com.tw/Terms-and-Conditions> and for electronic format documents, subject to Terms and Conditions for Electronic Documents at <http://www.sgs.com.tw/Terms-and-Conditions>. Attention is drawn to the limitation of liability, indemnification and jurisdiction issues defined therein. Any holder of this document is advised that information contained hereon reflects the Company's findings at the time of its intervention only and within the limits of Client's instructions, if any. The Company's sole responsibility is to its Client and this document does not exonerate parties to a transaction from exercising all their rights and obligations under the transaction documents. This document cannot be reproduced except in full, without prior written approval of the Company. Any unauthorized alteration, forgery or falsification of the content or appearance of this document is unlawful and offenders may be prosecuted to the fullest extent of the law.

Report Number :ER-2020-80015
 Test Mode :WLAN 5G
 Power :AC 120V/60Hz
 Probe :N
 Note: :

Test Site :Conduction 6F
 Test Date :2020-08-10
 Temp./Humi. :26.2/53
 Engineer :Nick

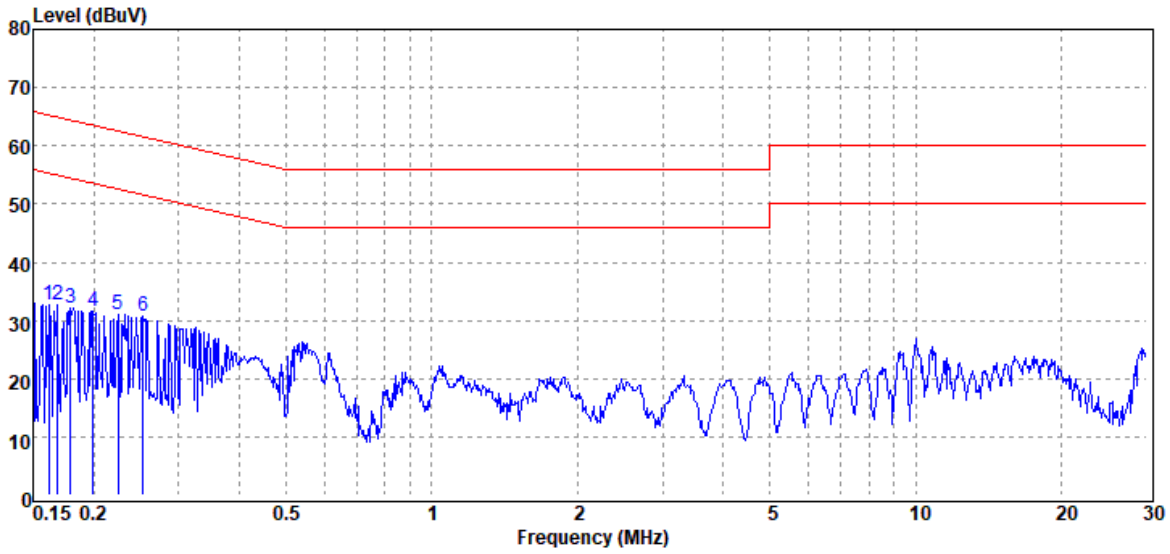

Freq. MHz	Detector Mode PK/QP/AV	Spectrum Reading Level dBμV	Factor dB	Actual FS dBμV	Limit dBμV	Margin dB
0.16	Peak	30.47	2.14	32.61	65.38	-32.77
0.17	Peak	30.66	2.14	32.80	65.03	-32.23
0.18	Peak	29.98	2.14	32.12	64.50	-32.38
0.20	Peak	29.47	2.14	31.61	63.62	-32.01
0.22	Peak	28.99	2.14	31.13	62.66	-31.53
0.25	Peak	28.58	2.14	30.72	61.64	-30.92

Unless otherwise stated the results shown in this test report refer only to the sample(s) tested and such sample(s) are retained for 90 days only.

除非另有說明，此報告結果僅對測試之樣品負責，同時此樣品僅保留90天。本報告未經本公司書面許可，不可部份複製。

This document is issued by the Company subject to its General Conditions of Service printed overleaf, available on request or accessible at <http://www.sgs.com.tw/Terms-and-Conditions> and for electronic format documents, subject to Terms and Conditions for Electronic Documents at <http://www.sgs.com.tw/Terms-and-Conditions>. Attention is drawn to the limitation of liability, indemnification and jurisdiction issues defined therein. Any holder of this document is advised that information contained hereon reflects the Company's findings at the time of its intervention only and within the limits of Client's instructions, if any. The Company's sole responsibility is to its Client and this document does not exonerate parties to a transaction from exercising all their rights and obligations under the transaction documents. This document cannot be reproduced except in full, without prior written approval of the Company. Any unauthorized alteration, forgery or falsification of the content or appearance of this document is unlawful and offenders may be prosecuted to the fullest extent of the law.

7 DUTY CYCLE TEST SIGNAL

Pre-analysis Check: While conducting average power measurement, duty cycle of each mode shall be checked to ensure its duty cycle in order to compensate for the loss due to insufficient ratio of duty cycle. All duty cycle is pre-scanned, and result as obtained below shows only the most representative ones where duty cycle is conducted as the given transmission with given virtual operation that expresses the percentage.

7.1 Measurement Procedure:

1. Set span = Zero
2. RBW = 8MHz
3. VBW = 8MHz,
4. Detector = Peak

Duty Cycle:

Mode	Duty Cycle (%) =Ton / (Ton+Toff)	Duty Factor (dB) =10*log (1/Duty Cycle)	1/T (kHz)	VBW setting (kHz)
802.11a	93.09	0.31	0.70	1.00
802.11n_20	92.78	0.33	0.75	1.00

Duty Cycle Factor: $10 * \log(1/0.9309) = 0.31$

Duty Cycle Factor: $10 * \log(1/0.9278) = 0.33$

Unless otherwise stated the results shown in this test report refer only to the sample(s) tested and such sample(s) are retained for 90 days only.

除非另有說明，此報告結果僅對測試之樣品負責，同時此樣品僅保留90天。本報告未經本公司書面許可，不可部份複製。

This document is issued by the Company subject to its General Conditions of Service printed overleaf, available on request or accessible at <http://www.sgs.com.tw/Terms-and-Conditions> and for electronic format documents, subject to Terms and Conditions for Electronic Documents at <http://www.sgs.com.tw/Terms-and-Conditions>. Attention is drawn to the limitation of liability, indemnification and jurisdiction issues defined therein. Any holder of this document is advised that information contained hereon reflects the Company's findings at the time of its intervention only and within the limits of Client's instructions, if any. The Company's sole responsibility is to its Client and this document does not exonerate parties to a transaction from exercising all their rights and obligations under the transaction documents. This document cannot be reproduced except in full, without prior written approval of the Company. Any unauthorized alteration, forgery or falsification of the content or appearance of this document is unlawful and offenders may be prosecuted to the fullest extent of the law.

7.2 DUTY CYCLE TEST SIGNAL MEASUREMENT RESULT

802.11a_20MHz\5180 MHz-5180



802.11n_20MHz\5180 MHz-5180



Unless otherwise stated the results shown in this test report refer only to the sample(s) tested and such sample(s) are retained for 90 days only.

除非另有說明，此報告結果僅對測試之樣品負責，同時此樣品僅保留90天。本報告未經本公司書面許可，不可部份複製。

This document is issued by the Company subject to its General Conditions of Service printed overleaf, available on request or accessible at <http://www.sgs.com.tw/Terms-and-Conditions> and for electronic format documents, subject to Terms and Conditions for Electronic Documents at <http://www.sgs.com.tw/Terms-and-Conditions>. Attention is drawn to the limitation of liability, indemnification and jurisdiction issues defined therein. Any holder of this document is advised that information contained hereon reflects the Company's findings at the time of its intervention only and within the limits of Client's instructions, if any. The Company's sole responsibility is to its Client and this document does not exonerate parties to a transaction from exercising all their rights and obligations under the transaction documents. This document cannot be reproduced except in full, without prior written approval of the Company. Any unauthorized alteration, forgery or falsification of the content or appearance of this document is unlawful and offenders may be prosecuted to the fullest extent of the law.

8 26DB & 6DB EMISSION BANDWIDTH MEASUREMENT

8.1 Standard Applicable

There is no limit bandwidth for U-NII-1, U-NII-2-A and U-NII-2-C.
The minimum of 6dB Bandwidth measurement is 0.5 MHz for U-NII-3

8.2 Measurement Procedure

1. Place the EUT on the table and set it in transmitting mode.
2. The testing follows FCC KDB 789033 D02 General UNII Test Procedures New Rules.
3. Remove the antenna from the EUT and then connect a low loss RF cable from the Antenna port to the spectrum analyzer.
 - 3.a. 26dB Band width Measurement: Set the spectrum analyzer as 1% of emission BW
Sweep=auto,
Detector = Peak,
Trace Mode = Max Hold,
Manually readjust RBW until the RBW/EBW ratio is 1% based on EBW as observed on the result of pre-sequence measurement.
 - 3.b. Mark the peak frequency and -26dB (upper and lower) frequency.
4. Repeat the procedures as list above until all test default channels (low, middle, and high) are completed.
5. Minimum Emission Bandwidth for the band 5.725-5.850GHz.
 - a. Set the spectrum analyzer as
RBW = 100 kHz,
VBW = 3*RBW,
Span = 30M/50MHz,
Detector=Peak,
Sweep=auto
 - b. Mark the peak frequency and -6dB (upper and lower) frequency.
6. Repeat above procedures until all frequency of interest measured was complete.

Unless otherwise stated the results shown in this test report refer only to the sample(s) tested and such sample(s) are retained for 90 days only.

除非另有說明，此報告結果僅對測試之樣品負責，同時此樣品僅保留90天。本報告未經本公司書面許可，不可部份複製。

This document is issued by the Company subject to its General Conditions of Service printed overleaf, available on request or accessible at <http://www.sgs.com.tw/Terms-and-Conditions> and for electronic format documents, subject to Terms and Conditions for Electronic Documents at <http://www.sgs.com.tw/Terms-and-Conditions>. Attention is drawn to the limitation of liability, indemnification and jurisdiction issues defined therein. Any holder of this document is advised that information contained hereon reflects the Company's findings at the time of its intervention only and within the limits of Client's instructions, if any. The Company's sole responsibility is to its Client and this document does not exonerate parties to a transaction from exercising all their rights and obligations under the transaction documents. This document cannot be reproduced except in full, without prior written approval of the Company. Any unauthorized alteration, forgery or falsification of the content or appearance of this document is unlawful and offenders may be prosecuted to the fullest extent of the law.

8.3 Measurement Equipment Used

SGS Conducted Room					
Name of Equipment	Manufacturer	Model	Serial Number	Calibration Date	Calibration Due
PXA Spectrum Analyzer	Agilent	N9030A	MY53120760	04/21/2020	04/20/2021
DC Power Supply	Agilent	E3640A	MY40000811	12/23/2019	12/22/2020
Temperature Chamber	TERCHY	MHG-120LF	911009	05/20/2020	05/19/2021
Attenuator	Mini-Circuit	BW-S10W2+	2	01/02/2020	01/01/2021
DC Block	Mini-Circuits	BLK-18-S+	1	01/02/2020	01/01/2021

8.4 Test Set-up

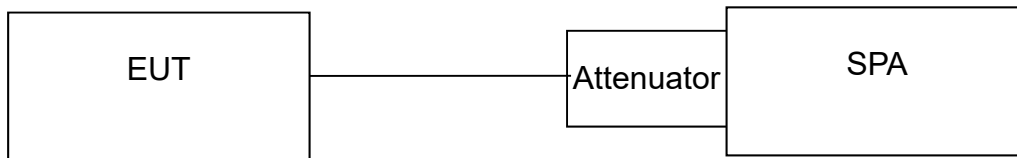

Unless otherwise stated the results shown in this test report refer only to the sample(s) tested and such sample(s) are retained for 90 days only.

除非另有說明，此報告結果僅對測試之樣品負責，同時此樣品僅保留90天。本報告未經本公司書面許可，不可部份複製。

This document is issued by the Company subject to its General Conditions of Service printed overleaf, available on request or accessible at <http://www.sgs.com.tw/Terms-and-Conditions> and for electronic format documents, subject to Terms and Conditions for Electronic Documents at <http://www.sgs.com.tw/Terms-and-Conditions>. Attention is drawn to the limitation of liability, indemnification and jurisdiction issues defined therein. Any holder of this document is advised that information contained hereon reflects the Company's findings at the time of its intervention only and within the limits of Client's instructions, if any. The Company's sole responsibility is to its Client and this document does not exonerate parties to a transaction from exercising all their rights and obligations under the transaction documents. This document cannot be reproduced except in full, without prior written approval of the Company. Any unauthorized alteration, forgery or falsification of the content or appearance of this document is unlawful and offenders may be prosecuted to the fullest extent of the law.

8.5 Measurement Result

8.5.1 FCC 26dB Bandwidth

802.11a_Ch0			802.11n_HT20_Ch0		
Freq. (MHz)	26dB BW (MHz)	10 Log (B) (dB)	Freq. (MHz)	26dB BW (MHz)	10 Log (B) (dB)
5180	20.6	13.139	5180	20.66	13.151
5220	20.51	13.120	5220	21.1	13.243
5240	20.19	13.051	5240	20.63	13.145
5260	20.32	13.079	5260	20.7	13.160
5300	20.39	13.094	5300	20.36	13.088
5320	20.29	13.073	5320	20.54	13.126
5500	20.36	13.088	5500	20.86	13.193
5580	20.27	13.069	5580	20.64	13.147
5700	20.49	13.115	5700	20.49	13.115

8.5.2 6dB Bandwidth (5725 MHz~ 5850 MHz) measure with Peak detector for FCC

802.11a_Ch0			802.11n_HT20_Ch0		
Freq. (MHz)	6dB BW (MHz)	10 Log (B) (dB)	Freq. (MHz)	6dB BW (MHz)	10 Log (B) (dB)
5745	14.45	11.599	5745	16.69	12.225
5785	14.24	11.535	5785	15.67	11.951
5825	14.96	11.749	5825	11.3	10.531

8.5.3 26dB BW Verification for DFS Function

802.11a_Ch0			802.11n_HT20_Ch0		
Freq. (MHz)	Measured Freq. (MHz)	Limit (MHz)	Freq. (MHz)	Measured Freq. (MHz)	Limit (MHz)
5240	5248.21	< 5250	5240	5248.80	< 5250
5745	5736.75	> 5725	5745	5736.15	> 5725

Please see next page for test plots.

Unless otherwise stated the results shown in this test report refer only to the sample(s) tested and such sample(s) are retained for 90 days only.

除非另有說明，此報告結果僅對測試之樣品負責，同時此樣品僅保留90天。本報告未經本公司書面許可，不可部份複製。

This document is issued by the Company subject to its General Conditions of Service printed overleaf, available on request or accessible at <http://www.sgs.com.tw/Terms-and-Conditions> and for electronic format documents, subject to Terms and Conditions for Electronic Documents at <http://www.sgs.com.tw/Terms-and-Conditions>. Attention is drawn to the limitation of liability, indemnification and jurisdiction issues defined therein. Any holder of this document is advised that information contained hereon reflects the Company's findings at the time of its intervention only and within the limits of Client's instructions, if any. The Company's sole responsibility is to its Client and this document does not exonerate parties to a transaction from exercising all their rights and obligations under the transaction documents. This document cannot be reproduced except in full, without prior written approval of the Company. Any unauthorized alteration, forgery or falsification of the content or appearance of this document is unlawful and offenders may be prosecuted to the fullest extent of the law.

FCC_802.11a_20MHz_5180MHz_Main

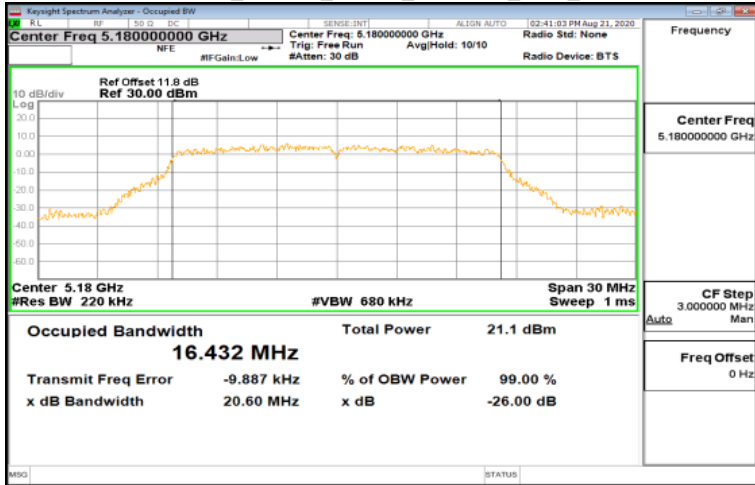

FCC_802.11a_20MHz_5260MHz_Main

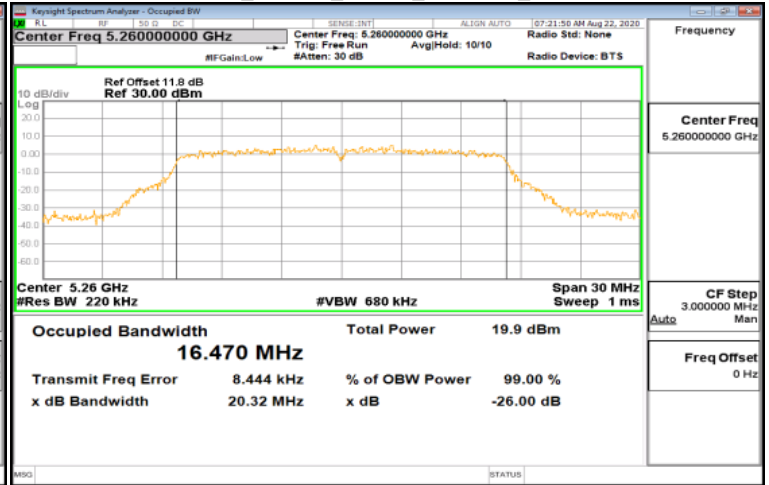

FCC_802.11a_20MHz_5220MHz_Main

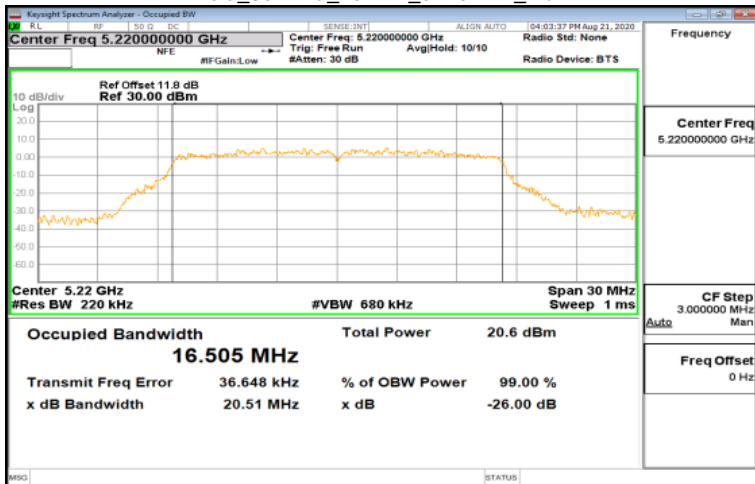

FCC_802.11a_20MHz_5300MHz_Main

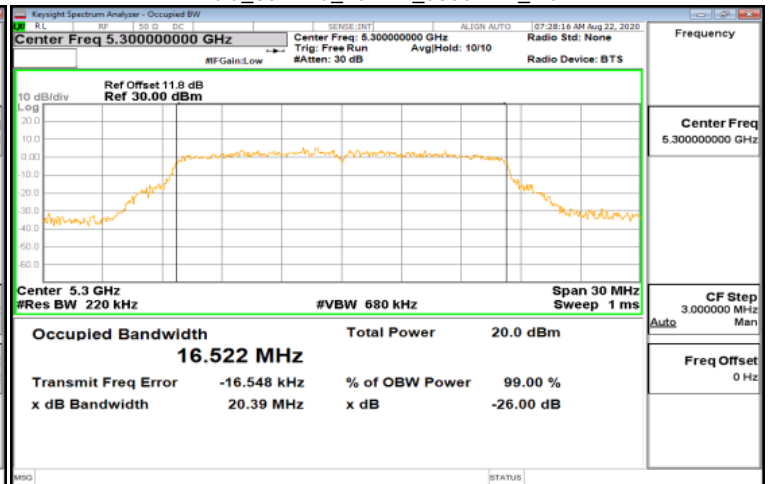

FCC_802.11a_20MHz_5240MHz_Main

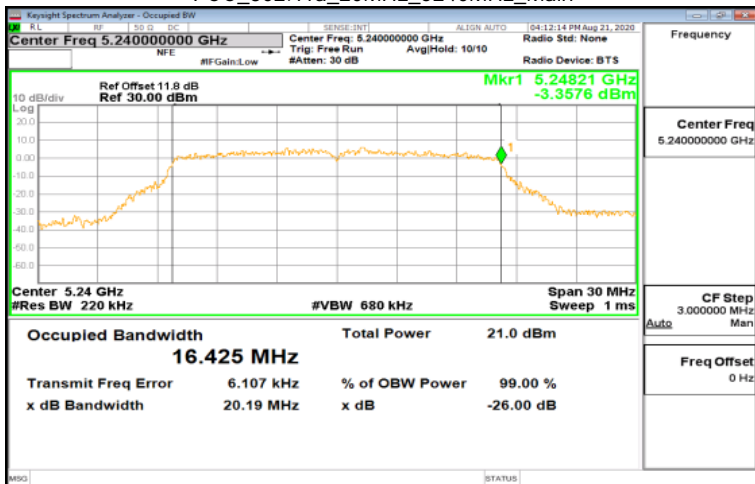

FCC_802.11a_20MHz_5320MHz_Main

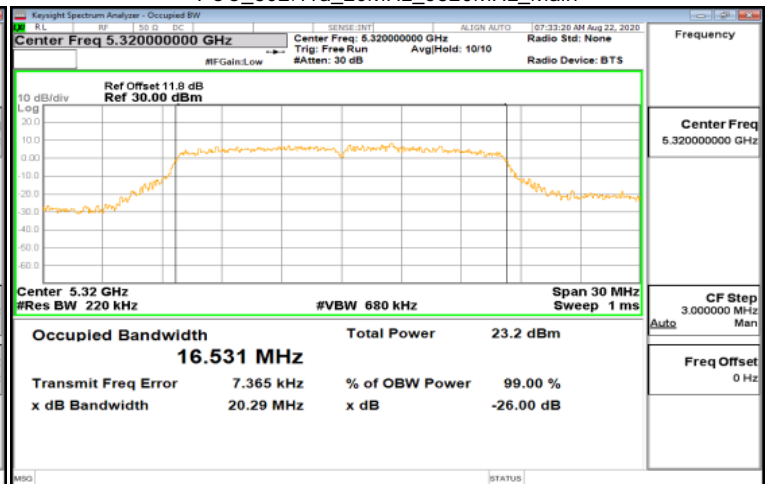

Unless otherwise stated the results shown in this test report refer only to the sample(s) tested and such sample(s) are retained for 90 days only.

除非另有說明，此報告結果僅對測試之樣品負責，同時此樣品僅保留90天。本報告未經本公司書面許可，不可部份複製。

This document is issued by the Company subject to its General Conditions of Service printed overleaf, available on request or accessible at <http://www.sgs.com.tw/Terms-and-Conditions> and for electronic format documents, subject to Terms and Conditions for Electronic Documents at <http://www.sgs.com.tw/Terms-and-Conditions>. Attention is drawn to the limitation of liability, indemnification and jurisdiction issues defined therein. Any holder of this document is advised that information contained hereon reflects the Company's findings at the time of its intervention only and within the limits of Client's instructions, if any. The Company's sole responsibility is to its Client and this document does not exonerate parties to a transaction from exercising all their rights and obligations under the transaction documents. This document cannot be reproduced except in full, without prior written approval of the Company. Any unauthorized alteration, forgery or falsification of the content or appearance of this document is unlawful and offenders may be prosecuted to the fullest extent of the law.

FCC_802.11a_20MHz_5500MHz_Main

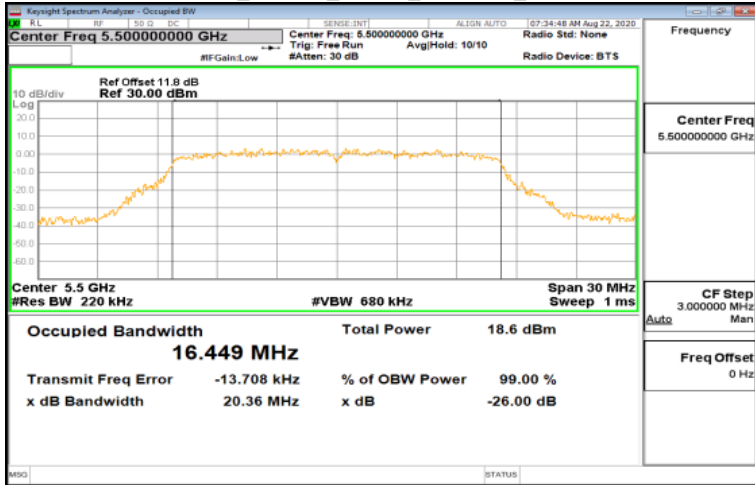

FCC_802.11a_20MHz_5745MHz_Main

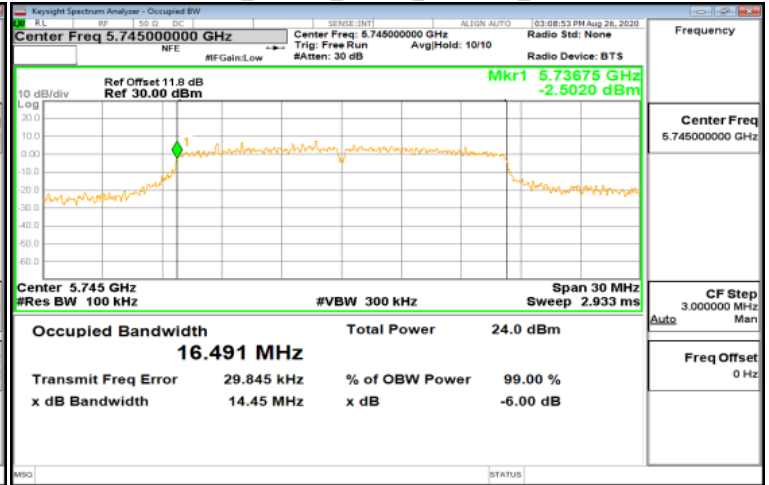

FCC_802.11a_20MHz_5580MHz_Main

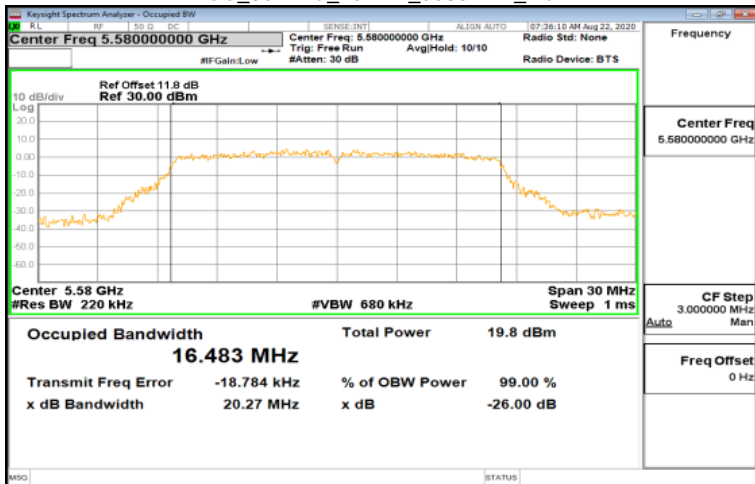

FCC_802.11a_20MHz_5785MHz_Main

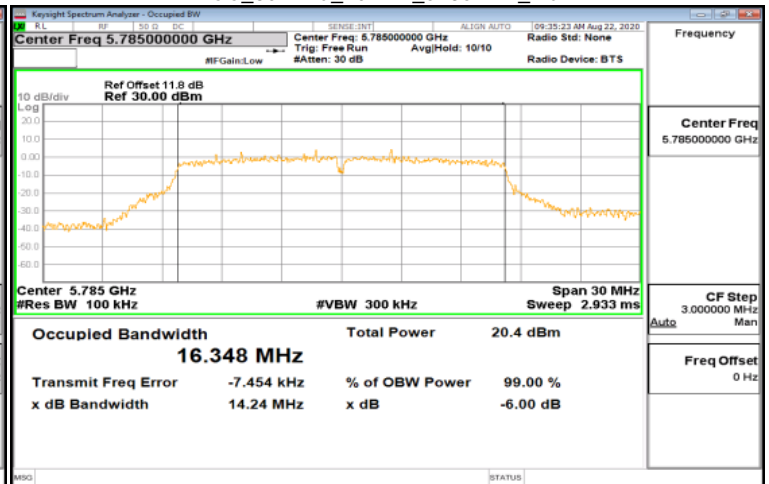

FCC_802.11a_20MHz_5700MHz_Main

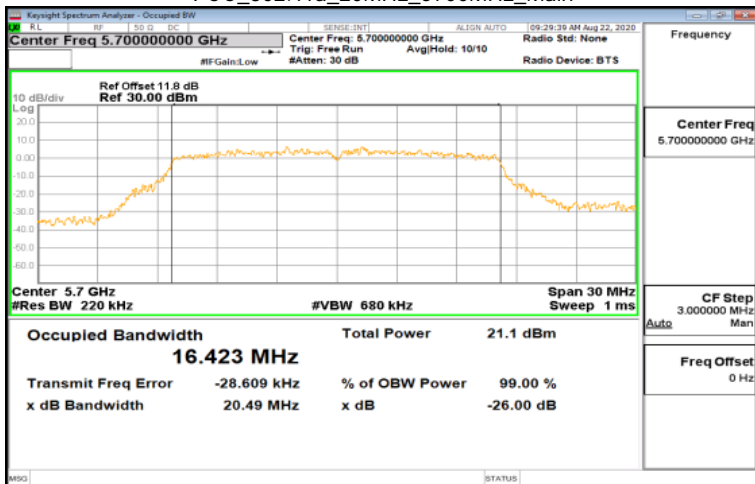

FCC_802.11a_20MHz_5825MHz_Main

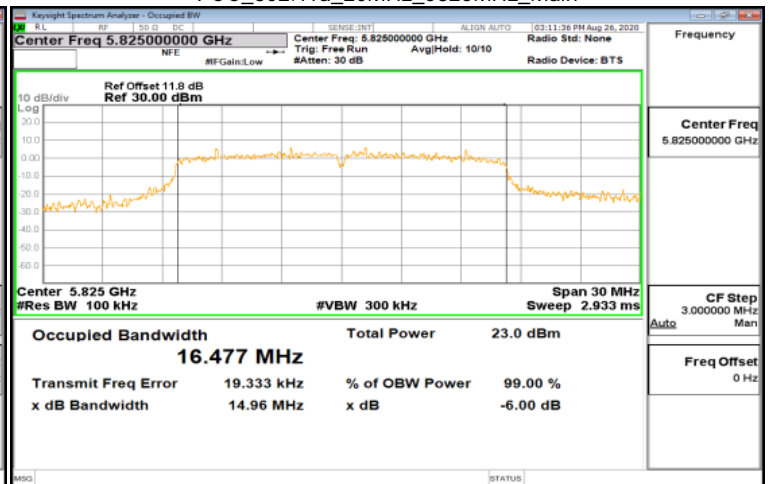

Unless otherwise stated the results shown in this test report refer only to the sample(s) tested and such sample(s) are retained for 90 days only.

除非另有說明，此報告結果僅對測試之樣品負責，同時此樣品僅保留90天。本報告未經本公司書面許可，不可部份複製。

This document is issued by the Company subject to its General Conditions of Service printed overleaf, available on request or accessible at <http://www.sgs.com.tw/Terms-and-Conditions> and for electronic format documents, subject to Terms and Conditions for Electronic Documents at <http://www.sgs.com.tw/Terms-and-Conditions>. Attention is drawn to the limitation of liability, indemnification and jurisdiction issues defined therein. Any holder of this document is advised that information contained hereon reflects the Company's findings at the time of its intervention only and within the limits of Client's instructions, if any. The Company's sole responsibility is to its Client and this document does not exonerate parties to a transaction from exercising all their rights and obligations under the transaction documents. This document cannot be reproduced except in full, without prior written approval of the Company. Any unauthorized alteration, forgery or falsification of the content or appearance of this document is unlawful and offenders may be prosecuted to the fullest extent of the law.

FCC_802.11n_20MHz_5180MHz_Main

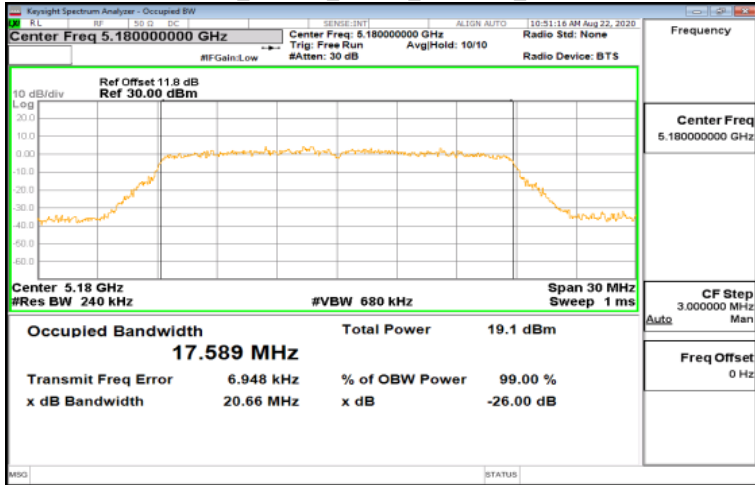

FCC_802.11n_20MHz_5260MHz_Main

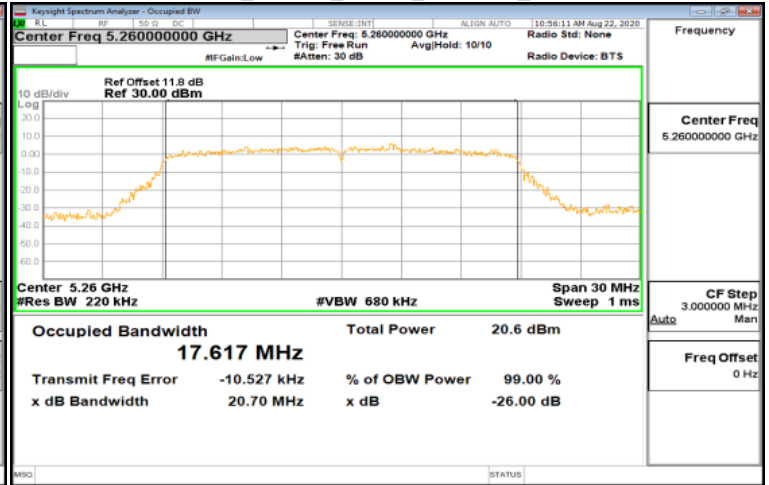

FCC_802.11n_20MHz_5220MHz_Main

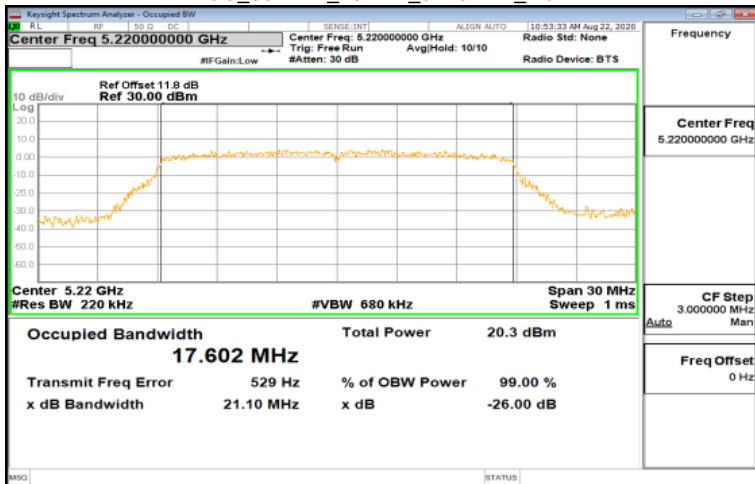

FCC_802.11n_20MHz_5300MHz_Main

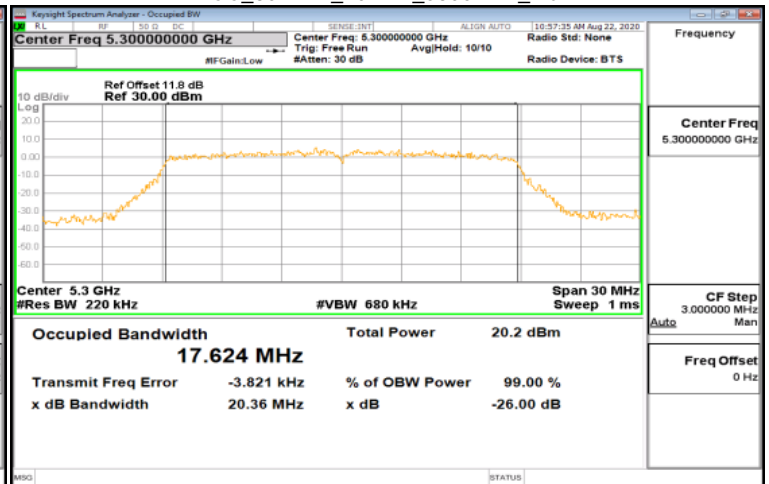

FCC_802.11n_20MHz_5240MHz_Main

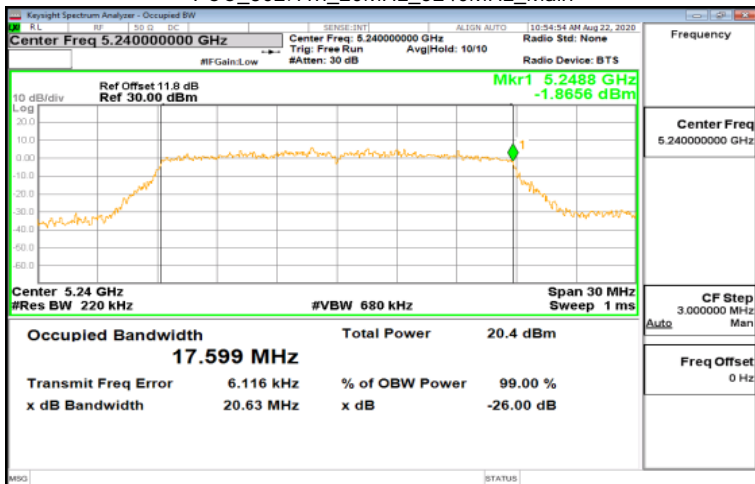

FCC_802.11n_20MHz_5320MHz_Main

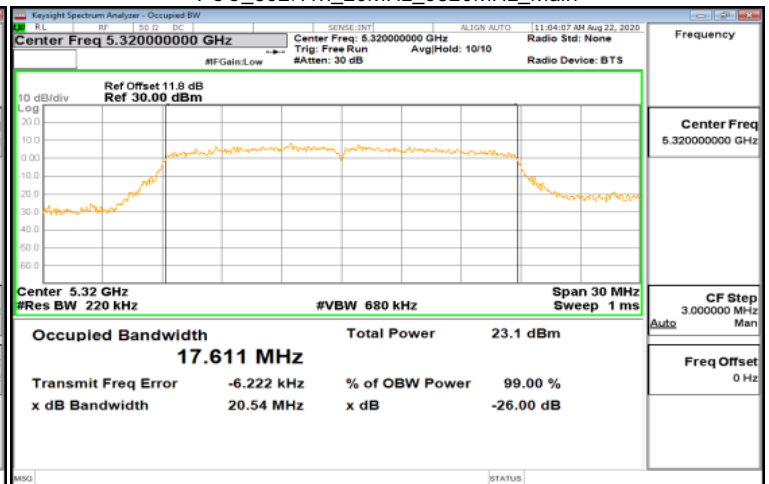

Unless otherwise stated the results shown in this test report refer only to the sample(s) tested and such sample(s) are retained for 90 days only.

除非另有說明，此報告結果僅對測試之樣品負責，同時此樣品僅保留90天。本報告未經本公司書面許可，不可部份複製。

This document is issued by the Company subject to its General Conditions of Service printed overleaf, available on request or accessible at <http://www.sgs.com.tw/Terms-and-Conditions> and for electronic format documents, subject to Terms and Conditions for Electronic Documents at <http://www.sgs.com.tw/Terms-and-Conditions>. Attention is drawn to the limitation of liability, indemnification and jurisdiction issues defined therein. Any holder of this document is advised that information contained hereon reflects the Company's findings at the time of its intervention only and within the limits of Client's instructions, if any. The Company's sole responsibility is to its Client and this document does not exonerate parties to a transaction from exercising all their rights and obligations under the transaction documents. This document cannot be reproduced except in full, without prior written approval of the Company. Any unauthorized alteration, forgery or falsification of the content or appearance of this document is unlawful and offenders may be prosecuted to the fullest extent of the law.

FCC_802.11n_20MHz_5500MHz_Main

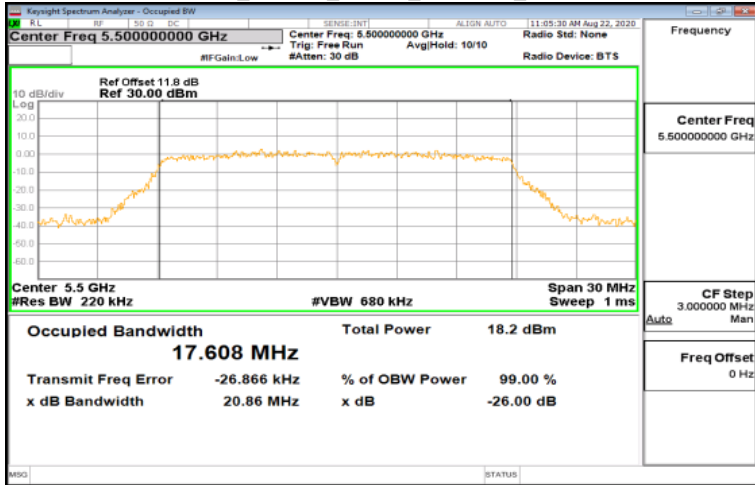

FCC_802.11n_20MHz_5745MHz_Main

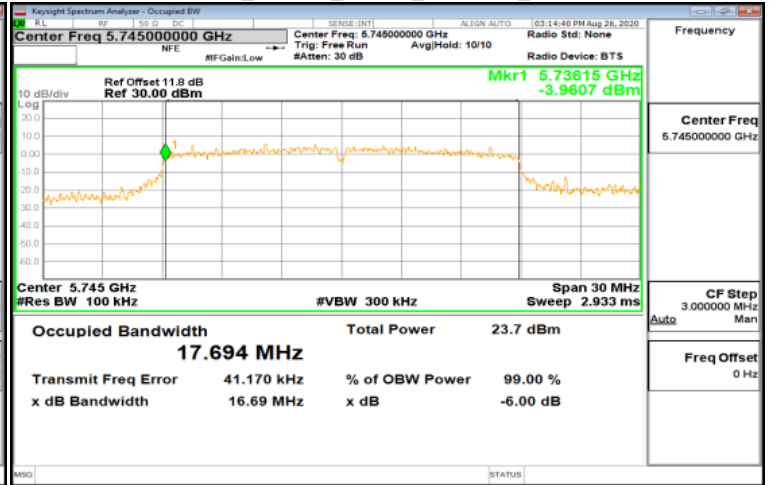

FCC_802.11n_20MHz_5580MHz_Main

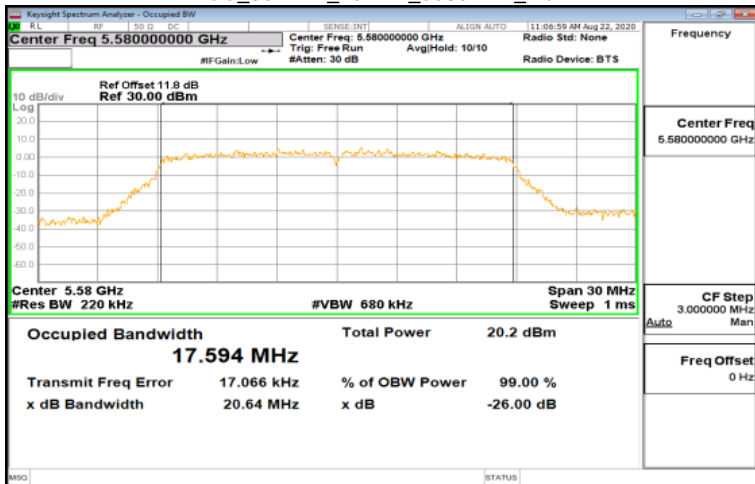

FCC_802.11n_20MHz_5785MHz_Main

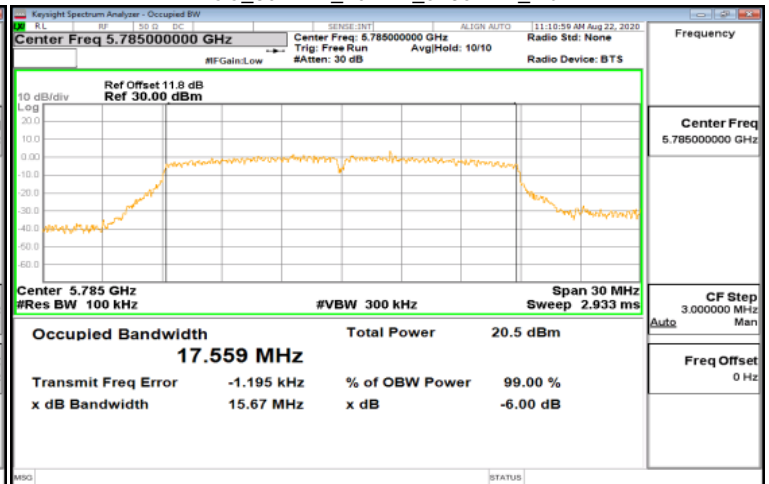

FCC_802.11n_20MHz_5700MHz_Main

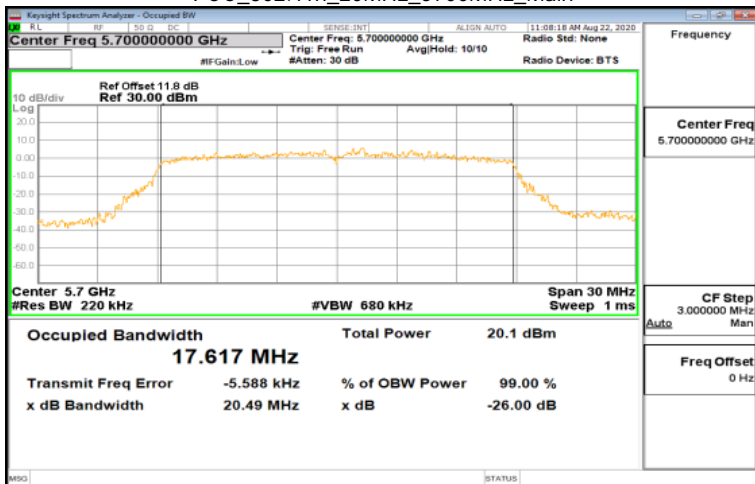

FCC_802.11n_20MHz_5825MHz_Main

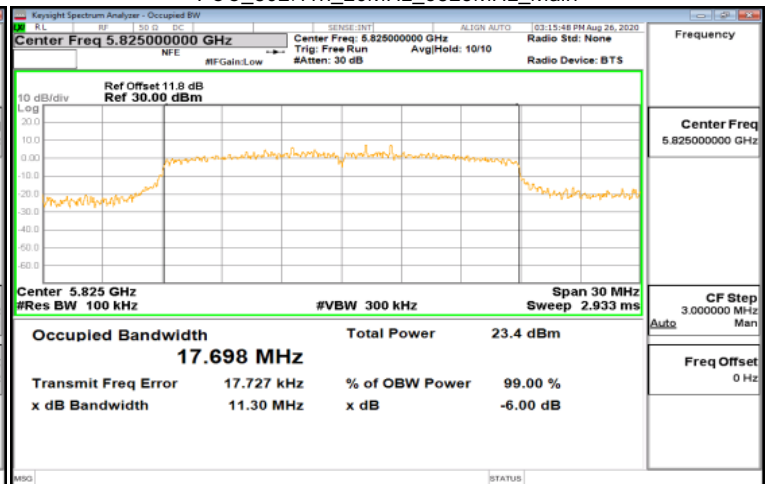

Unless otherwise stated the results shown in this test report refer only to the sample(s) tested and such sample(s) are retained for 90 days only.

除非另有說明，此報告結果僅對測試之樣品負責，同時此樣品僅保留90天。本報告未經本公司書面許可，不可部份複製。

This document is issued by the Company subject to its General Conditions of Service printed overleaf, available on request or accessible at <http://www.sgs.com.tw/Terms-and-Conditions> and for electronic format documents, subject to Terms and Conditions for Electronic Documents at <http://www.sgs.com.tw/Terms-and-Conditions>. Attention is drawn to the limitation of liability, indemnification and jurisdiction issues defined therein. Any holder of this document is advised that information contained hereon reflects the Company's findings at the time of its intervention only and within the limits of Client's instructions, if any. The Company's sole responsibility is to its Client and this document does not exonerate parties to a transaction from exercising all their rights and obligations under the transaction documents. This document cannot be reproduced except in full, without prior written approval of the Company. Any unauthorized alteration, forgery or falsification of the content or appearance of this document is unlawful and offenders may be prosecuted to the fullest extent of the law.

9 MAXIMUM CONDUCTED OUTPUT POWER MEASUREMENT

9.1 Standard Applicable

FCC

OPERZTION Band	EUT CATEGORY	LIMIT
U-NII-1	Access Point (Master device)	1 Watt(30dBm)
	Fixed point-to-point Access Ponit	1 Watt(30dBm)
	√ Mobile and portable client device	250mW(23.98dBm)
U-NII-2A	√	250mW(23.98dBm) or 11dBm+10 log B
U-NII-2C	√	250mW(23.98dBm) or 11dBm+10 log B
U-NII-3	√	1 Watt(30dBm)

If transmitting antennas of directional gain greater than 6 dBi are used, the Maximum transmit power shall be reduced by the amount in dB that the direction-al gain of the antenna exceeds 6 dBi.

The antenna gain is grater than 6 dBi, therefore the limit needs to be reduced as below:
FCC Power Limit Reduction

	Effective Legacy Gain (dBi)	Conducted Power Limit (dBm)
UNII-1	5.90	23.98
UNII-2A	5.90	23.98
U-NII-2C	6.50	23.48
U-NII-3	6.60	29.40

9.2 Measurement Procedure

1. Place the EUT on the table and set it in transmitting mode.
2. The testing follows FCC KDB 789033 D02 General UNII Test Procedures New Rules .
3. Remove the antenna from the EUT and then connect a low loss RF cable from the antenna port to the power meter
4. Power Meter is used as the auxiliary test equipment to conduct the output power measurement.
5. Record the max. reading and add 10 log(1/duty cycle).
6. Repeat above procedures until all frequency (low, middle, and high channel) measured were complete.

Unless otherwise stated the results shown in this test report refer only to the sample(s) tested and such sample(s) are retained for 90 days only.

除非另有說明，此報告結果僅對測試之樣品負責，同時此樣品僅保留90天。本報告未經本公司書面許可，不可部份複製。

This document is issued by the Company subject to its General Conditions of Service printed overleaf, available on request or accessible at <http://www.sgs.com.tw/Terms-and-Conditions> and for electronic format documents, subject to Terms and Conditions for Electronic Documents at <http://www.sgs.com.tw/Terms-and-Conditions>. Attention is drawn to the limitation of liability, indemnification and jurisdiction issues defined therein. Any holder of this document is advised that information contained hereon reflects the Company's findings at the time of its intervention only and within the limits of Client's instructions, if any. The Company's sole responsibility is to its Client and this document does not exonerate parties to a transaction from exercising all their rights and obligations under the transaction documents. This document cannot be reproduced except in full, without prior written approval of the Company. Any unauthorized alteration, forgery or falsification of the content or appearance of this document is unlawful and offenders may be prosecuted to the fullest extent of the law.

9.3 Measurement Equipment Used

SGS Conducted Room					
Name of Equipment	Manufacturer	Model	Serial Number	Calibration Date	Calibration Due
PXA Spectrum Analyzer	Agilent	N9030A	MY53120760	04/21/2020	04/20/2021
DC Power Supply	Agilent	E3640A	MY40000811	12/23/2019	12/22/2020
Power Meter	Anritsu	ML2496A	1242004	11/05/2019	11/04/2020
Power Sensor	Anritsu	MA2411B	1207365	11/05/2019	11/04/2020
Power Sensor	Anritsu	MA2411B	1207368	11/05/2019	11/04/2020
Attenuator	Mini-Circuit	BW-S10W2+	2	01/02/2020	01/01/2021
DC Block	Mini-Circuits	BLK-18-S+	1	01/02/2020	01/01/2021
PXA Spectrum Analyzer	Agilent	N9030A	MY53120760	04/21/2020	04/20/2021

9.4 Test Set-up

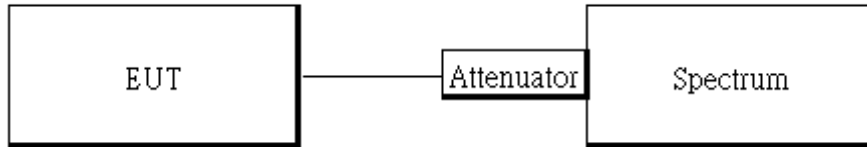

Unless otherwise stated the results shown in this test report refer only to the sample(s) tested and such sample(s) are retained for 90 days only.

除非另有說明，此報告結果僅對測試之樣品負責，同時此樣品僅保留90天。本報告未經本公司書面許可，不可部份複製。

This document is issued by the Company subject to its General Conditions of Service printed overleaf, available on request or accessible at <http://www.sgs.com.tw/Terms-and-Conditions> and for electronic format documents, subject to Terms and Conditions for Electronic Documents at <http://www.sgs.com.tw/Terms-and-Conditions>. Attention is drawn to the limitation of liability, indemnification and jurisdiction issues defined therein. Any holder of this document is advised that information contained hereon reflects the Company's findings at the time of its intervention only and within the limits of Client's instructions, if any. The Company's sole responsibility is to its Client and this document does not exonerate parties to a transaction from exercising all their rights and obligations under the transaction documents. This document cannot be reproduced except in full, without prior written approval of the Company. Any unauthorized alteration, forgery or falsification of the content or appearance of this document is unlawful and offenders may be prosecuted to the fullest extent of the law.

9.5 Measurement Result

9.5.1 Conducted output power (FCC)

802.11a_Ch0

CH	Frequency (MHz)	Data Rate	TOTAL POWER (dBm)	TOTAL POWER (mW)	REQUIRED LIMIT (dBm)	RESULT
36	5180	6	12.89	19.445	23.98	PASS
44	5220	6	15.46	35.141	23.98	PASS
48	5240	6	15.48	35.303	23.98	PASS
52	5260	6	15.30	33.870	23.98 or $11+10\log(B) = 24.08$	PASS
60	5300	6	15.42	34.819	23.98 or $11+10\log(B) = 24.09$	PASS
64	5320	6	15.47	35.222	23.98 or $11+10\log(B) = 24.07$	PASS
100	5500	6	13.21	20.932	23.48 or $11+10\log(B) = 24.09$	PASS
116	5580	6	15.32	34.026	23.48 or $11+10\log(B) = 24.07$	PASS
140	5700	6	15.44	34.980	23.48 or $11+10\log(B) = 24.12$	PASS
149	5745	6	15.38	34.500	29.4	PASS
157	5785	6	15.28	33.715	29.4	PASS
165	5825	6	15.29	33.792	29.4	PASS

802.11n_HT20_Ch0

CH	Frequency (MHz)	Data Rate	TOTAL POWER (dBm)	TOTAL POWER (mW)	REQUIRED LIMIT (dBm)	RESULT
36	5180	MCS0	12.97	19.822	23.98	PASS
44	5220	MCS0	15.32	34.053	23.98	PASS
48	5240	MCS0	15.46	35.169	23.98	PASS
52	5260	MCS0	15.49	35.412	23.98 or $11+10\log(B) = 24.16$	PASS
60	5300	MCS0	15.29	33.819	23.98 or $11+10\log(B) = 24.09$	PASS
64	5320	MCS0	15.46	35.169	23.98 or $11+10\log(B) = 24.13$	PASS
100	5500	MCS0	13.38	21.785	23.48 or $11+10\log(B) = 24.19$	PASS
116	5580	MCS0	15.47	35.250	23.48 or $11+10\log(B) = 24.15$	PASS
140	5700	MCS0	14.36	27.299	23.48 or $11+10\log(B) = 24.12$	PASS
149	5745	MCS0	15.45	35.088	29.4	PASS
157	5785	MCS0	15.49	35.412	29.4	PASS
165	5825	MCS0	15.41	34.766	29.4	PASS

Unless otherwise stated the results shown in this test report refer only to the sample(s) tested and such sample(s) are retained for 90 days only.

除非另有說明，此報告結果僅對測試之樣品負責，同時此樣品僅保留90天。本報告未經本公司書面許可，不可部份複製。

This document is issued by the Company subject to its General Conditions of Service printed overleaf, available on request or accessible at <http://www.sgs.com.tw/Terms-and-Conditions> and for electronic format documents, subject to Terms and Conditions for Electronic Documents at <http://www.sgs.com.tw/Terms-and-Conditions>. Attention is drawn to the limitation of liability, indemnification and jurisdiction issues defined therein. Any holder of this document is advised that information contained hereon reflects the Company's findings at the time of its intervention only and within the limits of Client's instructions, if any. The Company's sole responsibility is to its Client and this document does not exonerate parties to a transaction from exercising all their rights and obligations under the transaction documents. This document cannot be reproduced except in full, without prior written approval of the Company. Any unauthorized alteration, forgery or falsification of the content or appearance of this document is unlawful and offenders may be prosecuted to the fullest extent of the law.

10 MAXIMUM POWER SPECTRAL DENSITY

10.1 Standard Applicable

FCC

OPERZTION Band	EUT CATEGORY	LIMIT
U-NII-1	Access Point (Master device)	17dBm/ MHz
	Fixed point-to-point Access Ponit	
	√ Mobile and portable client device	11dBm/ MHz
U-NII-2A	√	11dBm/ MHz
U-NII-2C	√	11dBm/ MHz
U-NII-3	√	30dBm/ 500kHz

If transmitting antennas of directional gain greater than 6 dBi are used, the Maximum power spectral density shall be reduced by the amount in dB that the directional gain of the antenna exceeds 6 dBi.

The antenna gain is grater than 6 dBi, therefore the limit needs to be reduced as below:

FCC PSD Limit Attenuation

	Effective Legacy Gain (dBi)	PSD Limit	
UNII-1	5.90	11.00	dBm/MHz
UNII-2A	5.90	11.00	dBm/MHz
U-NII-2C	6.50	10.50	dBm/MHz
U-NII-3	6.60	29.40	dBm/500 kHz

10.2 Measurement Procedure

- Place the EUT on the table and set it in transmitting mode.
- The testing follows FCC KDB 789033 D02 General UNII Test Procedures New Rules .
- Remove the antenna from the EUT and then connect a low loss RF cable from the antenna port to Spectrum.
- For U-NII1, U-NII-2A, U-NII-2C Band:**
Set RBW=1MHz, VBW=3MHz, where span is enough to capture the entire bandwidth, Sweep time = Auto (601 pts), detector = sample, traces 100 sweeps of video averaging. (SA-2 with the omission of procedure x, the integration with 26dB EBW bandwidth)
For U-NII-3 Band:
Set RBW=500 kHz, VBW≥ 3RBW, where span is enough to capture the entire bandwidth, Sweep time = Auto (601 pts), detector = sample, traces 100 sweeps of video averaging. (SA-2 with the omission of procedure x, the integration with 26dB EBW bandwidth)
- User the cursor on spectrum to peak search the highest level of trace
- Record the max. reading and add 10 log(1/duty cycle).
- Repeat above procedures until all default test channel (low, middle, and high) was complete.

Unless otherwise stated the results shown in this test report refer only to the sample(s) tested and such sample(s) are retained for 90 days only.

除非另有說明，此報告結果僅對測試之樣品負責，同時此樣品僅保留90天。本報告未經本公司書面許可，不可部份複製。

This document is issued by the Company subject to its General Conditions of Service printed overleaf, available on request or accessible at <http://www.sgs.com.tw/Terms-and-Conditions> and for electronic format documents, subject to Terms and Conditions for Electronic Documents at <http://www.sgs.com.tw/Terms-and-Conditions>. Attention is drawn to the limitation of liability, indemnification and jurisdiction issues defined therein. Any holder of this document is advised that information contained hereon reflects the Company's findings at the time of its intervention only and within the limits of Client's instructions, if any. The Company's sole responsibility is to its Client and this document does not exonerate parties to a transaction from exercising all their rights and obligations under the transaction documents. This document cannot be reproduced except in full, without prior written approval of the Company. Any unauthorized alteration, forgery or falsification of the content or appearance of this document is unlawful and offenders may be prosecuted to the fullest extent of the law.

10.3 Measurement Equipment Used

SGS Conducted Room					
Name of Equipment	Manufacturer	Model	Serial Number	Calibration Date	Calibration Due
PXA Spectrum Analyzer	Agilent	N9030A	MY53120760	04/21/2020	04/20/2021
DC Power Supply	Agilent	E3640A	MY40000811	12/23/2019	12/22/2020
Temperature Chamber	TERCHY	MHG-120LF	911009	05/20/2020	05/19/2021
Attenuator	Mini-Circuit	BW-S10W2+	2	01/02/2020	01/01/2021
DC Block	Mini-Circuits	BLK-18-S+	1	01/02/2020	01/01/2021

10.4 Test Set-up

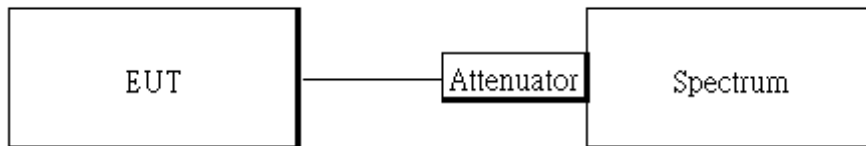

10.5 Measurement Result

10.5.1 Power spectral density

POWER DENSITY 802.11a MODE_Ch0					
Frequency (MHz)	PSD W/O Duty Factor (dBm)	Duty Factor	PSD With Duty Factor (dBm/MHz)-UNII 1~2C (dBm/500kHz)-UNII 3	Limit (dBm/MHz)-UNII 1~2C (dBm/500kHz)-UNII 3	Margin (dB)
5180.00	1.83	0.31	2.14	11.00	-8.86
5220.00	5.53	0.31	5.84	11.00	-5.16
5240.00	5.20	0.31	5.51	11.00	-5.49
5260.00	4.80	0.31	5.11	11.00	-5.89
5300.00	5.12	0.31	5.43	11.00	-5.57
5320.00	4.76	0.31	5.07	11.00	-5.93
5500.00	2.45	0.31	2.76	10.50	-7.74
5580.00	4.54	0.31	4.85	10.50	-5.65
5700.00	5.49	0.31	5.80	10.50	-4.70
5745.00	2.41	0.31	2.72	29.40	-26.68
5785.00	1.74	0.31	2.05	29.40	-27.35
5825.00	1.67	0.31	1.98	29.40	-27.42

Unless otherwise stated the results shown in this test report refer only to the sample(s) tested and such sample(s) are retained for 90 days only.

除非另有說明，此報告結果僅對測試之樣品負責，同時此樣品僅保留90天。本報告未經本公司書面許可，不可部份複製。

This document is issued by the Company subject to its General Conditions of Service printed overleaf, available on request or accessible at <http://www.sgs.com.tw/Terms-and-Conditions> and for electronic format documents, subject to Terms and Conditions for Electronic Documents at <http://www.sgs.com.tw/Terms-and-Conditions>. Attention is drawn to the limitation of liability, indemnification and jurisdiction issues defined therein. Any holder of this document is advised that information contained hereon reflects the Company's findings at the time of its intervention only and within the limits of Client's instructions, if any. The Company's sole responsibility is to its Client and this document does not exonerate parties to a transaction from exercising all their rights and obligations under the transaction documents. This document cannot be reproduced except in full, without prior written approval of the Company. Any unauthorized alteration, forgery or falsification of the content or appearance of this document is unlawful and offenders may be prosecuted to the fullest extent of the law.

POWER DENSITY 802.11n HT20 MODE_Ch0					
Frequency (MHz)	PSD W/O Duty Factor (dBm)	Duty Factor	PSD With Duty Factor (dBm/MHz)-UNII 1~2C (dBm/500kHz)-UNII 3	Limit (dBm/MHz)-UNII 1~2C (dBm/500kHz)-UNII 3	Margin (dB)
5180	2.48	0.33	2.81	11	-8.19
5220	5.06	0.33	5.39	11	-5.61
5240	4.87	0.33	5.20	11	-5.80
5260	4.94	0.33	5.27	11	-5.73
5300	4.69	0.33	5.02	11	-5.98
5320	4.26	0.33	4.59	11	-6.41
5500	2.48	0.33	2.81	10.5	-7.69
5580	3.67	0.33	4.00	10.5	-6.50
5700	4.09	0.33	4.42	10.5	-6.08
5745	2.04	0.33	2.37	29.4	-27.03
5785	2.10	0.33	2.43	29.4	-26.97
5825	1.42	0.33	1.75	29.4	-27.65

Note:

Cable Loss=

11.75 dB

Unless otherwise stated the results shown in this test report refer only to the sample(s) tested and such sample(s) are retained for 90 days only.

除非另有說明，此報告結果僅對測試之樣品負責，同時此樣品僅保留90天。本報告未經本公司書面許可，不可部份複製。

This document is issued by the Company subject to its General Conditions of Service printed overleaf, available on request or accessible at <http://www.sgs.com.tw/Terms-and-Conditions> and for electronic format documents, subject to Terms and Conditions for Electronic Documents at <http://www.sgs.com.tw/Terms-and-Conditions>. Attention is drawn to the limitation of liability, indemnification and jurisdiction issues defined therein. Any holder of this document is advised that information contained hereon reflects the Company's findings at the time of its intervention only and within the limits of Client's instructions, if any. The Company's sole responsibility is to its Client and this document does not exonerate parties to a transaction from exercising all their rights and obligations under the transaction documents. This document cannot be reproduced except in full, without prior written approval of the Company. Any unauthorized alteration, forgery or falsification of the content or appearance of this document is unlawful and offenders may be prosecuted to the fullest extent of the law.

802.11a_20MHz_5180MHz-5180



802.11a_20MHz_5260MHz-5260



802.11a_20MHz_5220MHz-5220



802.11a_20MHz_5300MHz-5300



802.11a_20MHz_5240MHz-5240



802.11a_20MHz_5320MHz-5320



Unless otherwise stated the results shown in this test report refer only to the sample(s) tested and such sample(s) are retained for 90 days only.

除非另有說明，此報告結果僅對測試之樣品負責，同時此樣品僅保留90天。本報告未經本公司書面許可，不可部份複製。

This document is issued by the Company subject to its General Conditions of Service printed overleaf, available on request or accessible at <http://www.sgs.com.tw/Terms-and-Conditions> and for electronic format documents, subject to Terms and Conditions for Electronic Documents at <http://www.sgs.com.tw/Terms-and-Conditions>. Attention is drawn to the limitation of liability, indemnification and jurisdiction issues defined therein. Any holder of this document is advised that information contained hereon reflects the Company's findings at the time of its intervention only and within the limits of Client's instructions, if any. The Company's sole responsibility is to its Client and this document does not exonerate parties to a transaction from exercising all their rights and obligations under the transaction documents. This document cannot be reproduced except in full, without prior written approval of the Company. Any unauthorized alteration, forgery or falsification of the content or appearance of this document is unlawful and offenders may be prosecuted to the fullest extent of the law.

802.11a_20MHz_5500MHz-5500



802.11a_20MHz_5745MHz-5745



802.11a_20MHz_5580MHz-5580

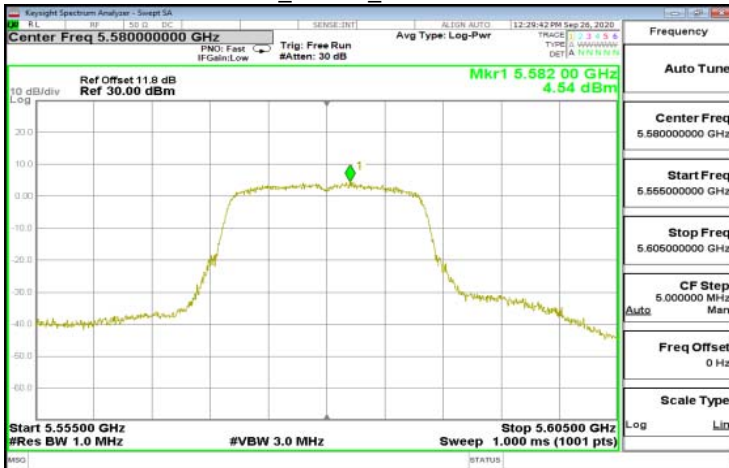

802.11a_20MHz_5785MHz-5785



802.11a_20MHz_5700MHz-5700



802.11a_20MHz_5825MHz-5825



Unless otherwise stated the results shown in this test report refer only to the sample(s) tested and such sample(s) are retained for 90 days only.

除非另有說明，此報告結果僅對測試之樣品負責，同時此樣品僅保留90天。本報告未經本公司書面許可，不可部份複製。

This document is issued by the Company subject to its General Conditions of Service printed overleaf, available on request or accessible at <http://www.sgs.com.tw/Terms-and-Conditions> and for electronic format documents, subject to Terms and Conditions for Electronic Documents at <http://www.sgs.com.tw/Terms-and-Conditions>. Attention is drawn to the limitation of liability, indemnification and jurisdiction issues defined therein. Any holder of this document is advised that information contained hereon reflects the Company's findings at the time of its intervention only and within the limits of Client's instructions, if any. The Company's sole responsibility is to its Client and this document does not exonerate parties to a transaction from exercising all their rights and obligations under the transaction documents. This document cannot be reproduced except in full, without prior written approval of the Company. Any unauthorized alteration, forgery or falsification of the content or appearance of this document is unlawful and offenders may be prosecuted to the fullest extent of the law.

802.11n_20MHz_5180MHz-5180



802.11n_20MHz_5260MHz-5260



802.11n_20MHz_5220MHz-5220



802.11n_20MHz_5300MHz-5300



802.11n_20MHz_5240MHz-5240

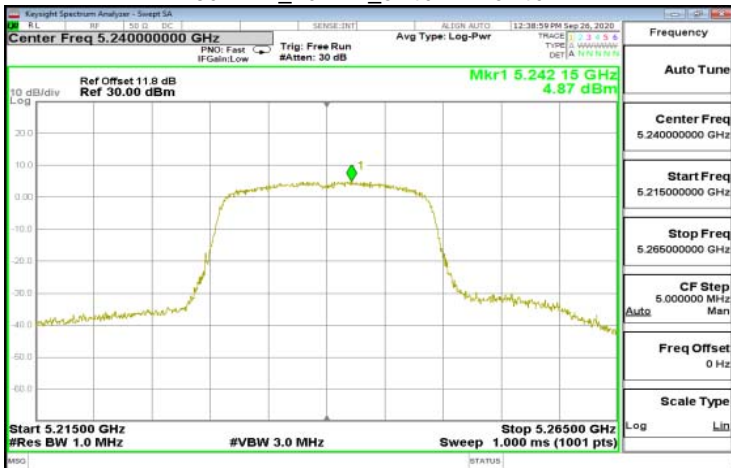

802.11n_20MHz_5320MHz-5320

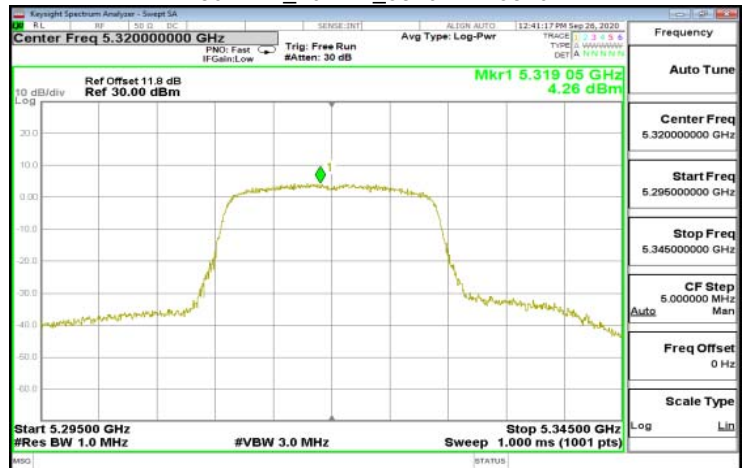

Unless otherwise stated the results shown in this test report refer only to the sample(s) tested and such sample(s) are retained for 90 days only.

除非另有說明，此報告結果僅對測試之樣品負責，同時此樣品僅保留90天。本報告未經本公司書面許可，不可部份複製。

This document is issued by the Company subject to its General Conditions of Service printed overleaf, available on request or accessible at <http://www.sgs.com.tw/Terms-and-Conditions> and for electronic format documents, subject to Terms and Conditions for Electronic Documents at <http://www.sgs.com.tw/Terms-and-Conditions>. Attention is drawn to the limitation of liability, indemnification and jurisdiction issues defined therein. Any holder of this document is advised that information contained hereon reflects the Company's findings at the time of its intervention only and within the limits of Client's instructions, if any. The Company's sole responsibility is to its Client and this document does not exonerate parties to a transaction from exercising all their rights and obligations under the transaction documents. This document cannot be reproduced except in full, without prior written approval of the Company. Any unauthorized alteration, forgery or falsification of the content or appearance of this document is unlawful and offenders may be prosecuted to the fullest extent of the law.

802.11n_20MHz_5500MHz-5500



802.11n_20MHz_5745MHz-5745

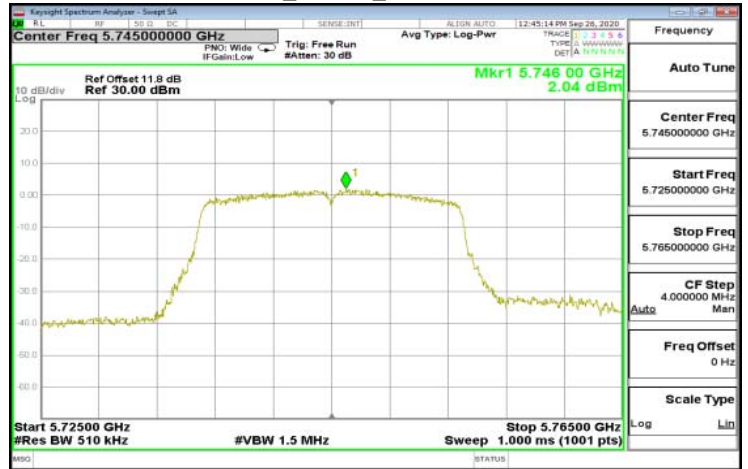

802.11n_20MHz_5580MHz-5580

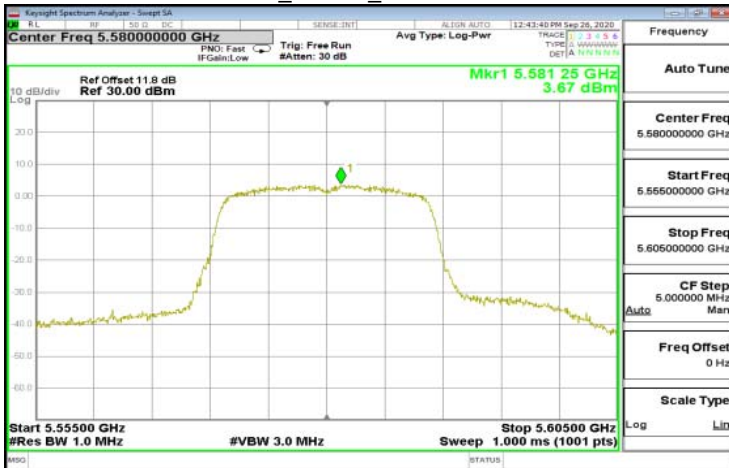

802.11n_20MHz_5785MHz-5785



802.11n_20MHz_5700MHz-5700

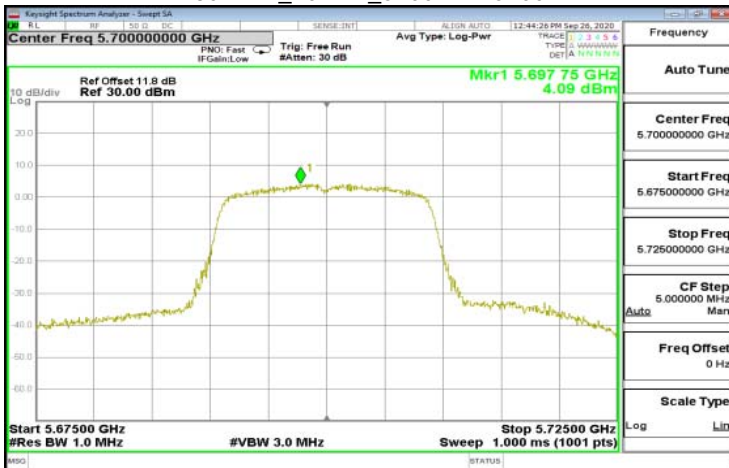

802.11n_20MHz_5825MHz-5825

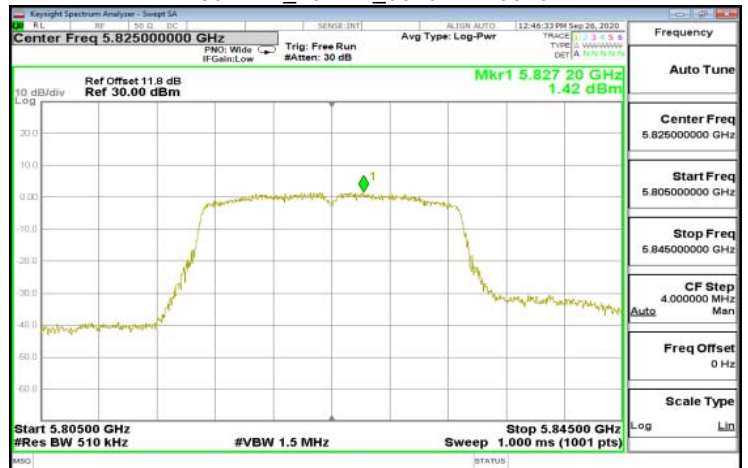

Unless otherwise stated the results shown in this test report refer only to the sample(s) tested and such sample(s) are retained for 90 days only.

除非另有說明，此報告結果僅對測試之樣品負責，同時此樣品僅保留90天。本報告未經本公司書面許可，不可部份複製。

This document is issued by the Company subject to its General Conditions of Service printed overleaf, available on request or accessible at <http://www.sgs.com.tw/Terms-and-Conditions> and for electronic format documents, subject to Terms and Conditions for Electronic Documents at <http://www.sgs.com.tw/Terms-and-Conditions>. Attention is drawn to the limitation of liability, indemnification and jurisdiction issues defined therein. Any holder of this document is advised that information contained hereon reflects the Company's findings at the time of its intervention only and within the limits of Client's instructions, if any. The Company's sole responsibility is to its Client and this document does not exonerate parties to a transaction from exercising all their rights and obligations under the transaction documents. This document cannot be reproduced except in full, without prior written approval of the Company. Any unauthorized alteration, forgery or falsification of the content or appearance of this document is unlawful and offenders may be prosecuted to the fullest extent of the law.

11 UNDESIRABLE RADIATED EMISSION MEASUREMENT

11.1 Standard Applicable

11.1.1 Band Edge

The maximum emissions outside of the frequency bands of operation shall be attenuated in accordance with the following limits:

1. For transmitters operating in the 5.15-5.25 GHz band: All emissions outside of the 5.15-5.35 GHz band shall not exceed an e.i.r.p. of -27 dBm/MHz.
2. For transmitters operating in the 5.725-5.85 GHz band: All emissions shall be limited to a level of -27 dBm/MHz at 75 MHz or more above or below the band edge increasing linearly to 10 dBm/MHz at 25 MHz above or below the band edge, and from 25 MHz above or below the band edge increasing linearly to a level of 15.6 dBm/MHz at 5 MHz above or below the band edge, and from 5 MHz above or below the band edge increasing linearly to a level of 27 dBm/MHz at the band edge.

APPLICABLE TO	EIRP LIMIT	FIELD STRENGTH AT 3m
15.407(b)(1) RSS-247 §6.2.1.2	PK: -27 (dBm/MHz)	PK: 68.3 (dBµV/m)
15.407(b)(2) RSS-247 §6.2.2.2		
15.407(b)(3) RSS-247 §6.2.3.2		
15.407(b)(4)(i) RSS-247 §6.2.4.2	PK:-27 (dBm/MHz) *1 PK:10 (dBm/MHz) *2 PK:15.6 (dBm/MHz) *3 PK:27 (dBm/MHz) *4	PK: 68.2(dBµV/m) *1 PK:105.2 (dBµV/m) *2 PK: 110.8(dBµV/m) *3 PK:122.2 (dBµV/m) *4
<p>*1 beyond 75 MHz or more above of the bandedge. *2 below the band edge increasing linearly to 10 dBm/MHz at 25 MHz above. *3 below the band edge increasing linearly to a level of 15.6 dBm/MHz at 5 MHz above. *4 from 5 MHz above or below the band edge increasing linearly to a level of 27 dBm/MHz at the band edge.</p>		

$EIRP = (E \cdot d)^2 / 30$, where E is the field in V/m, d is the measurement distance (3m), $EIRP$ is the equivalent isotropically radiated power in Watts.

Unless otherwise stated the results shown in this test report refer only to the sample(s) tested and such sample(s) are retained for 90 days only.

除非另有說明，此報告結果僅對測試之樣品負責，同時此樣品僅保留90天。本報告未經本公司書面許可，不可部份複製。

This document is issued by the Company subject to its General Conditions of Service printed overleaf, available on request or accessible at <http://www.sgs.com.tw/Terms-and-Conditions> and for electronic format documents, subject to Terms and Conditions for Electronic Documents at <http://www.sgs.com.tw/Terms-and-Conditions>. Attention is drawn to the limitation of liability, indemnification and jurisdiction issues defined therein. Any holder of this document is advised that information contained hereon reflects the Company's findings at the time of its intervention only and within the limits of Client's instructions, if any. The Company's sole responsibility is to its Client and this document does not exonerate parties to a transaction from exercising all their rights and obligations under the transaction documents. This document cannot be reproduced except in full, without prior written approval of the Company. Any unauthorized alteration, forgery or falsification of the content or appearance of this document is unlawful and offenders may be prosecuted to the fullest extent of the law.

11.1.2 Spurious Emission

Unwanted spurious emissions which fall in the restricted bands must comply with the radiated emission limits specified as below table:

Frequency (MHz)	Field strength (microvolts/meter)	Distance (meters)
0.009-0.490	2400/F(KHz)	300
0.490-1.705	24000/F(KHz)	30
1.705-30	30	30
30-88	100	3
88-216	150	3
216-960	200	3
Above 960	500	3

Note:

1. The lower limit shall apply at the transition frequencies.
2. Emission level (dBμV/m) = 20 log Emission level (μV/m)

Unless otherwise stated the results shown in this test report refer only to the sample(s) tested and such sample(s) are retained for 90 days only.

除非另有說明，此報告結果僅對測試之樣品負責，同時此樣品僅保留90天。本報告未經本公司書面許可，不可部份複製。

This document is issued by the Company subject to its General Conditions of Service printed overleaf, available on request or accessible at <http://www.sgs.com.tw/Terms-and-Conditions> and for electronic format documents, subject to Terms and Conditions for Electronic Documents at <http://www.sgs.com.tw/Terms-and-Conditions>. Attention is drawn to the limitation of liability, indemnification and jurisdiction issues defined therein. Any holder of this document is advised that information contained hereon reflects the Company's findings at the time of its intervention only and within the limits of Client's instructions, if any. The Company's sole responsibility is to its Client and this document does not exonerate parties to a transaction from exercising all their rights and obligations under the transaction documents. This document cannot be reproduced except in full, without prior written approval of the Company. Any unauthorized alteration, forgery or falsification of the content or appearance of this document is unlawful and offenders may be prosecuted to the fullest extent of the law.

11.2 Measurement Equipment Used

SGS SAC-III					
Name of Equipment	Manufacturer	Model	Serial Number	Calibration Date	Calibration Due
Horn Antenna	Schwarzbeck	BBHA9170	185	08/07/2019	08/06/2020
Horn Antenna	Schwarzbeck	BBHA9120D	1187	01/10/2020	01/09/2021
EMI Test Receiver	R&S	ESU 40	100363	04/29/2020	04/28/2021
Pre-Amplifier	EMC Instruments	EMC0011830	980199	11/20/2019	11/19/2020
Pre-Amplifier	EMC Instruments	EMC184045B	980135	11/20/2019	11/19/2020
Attenuator	Woken	WATT-218FS-10	RF25	11/20/2019	11/19/2020
Band Rejection Filter	Micro-Tronics	G015	RF100	11/20/2019	11/19/2020
Band Rejection Filter	Micro-Tronics	G016	RF101	11/20/2019	11/19/2020
Band Rejection Filter	Micro-Tronics	G021	RF102	11/20/2019	11/19/2020
Coaxial Cable	Huber Suhner	SUCOFLEX 104	MY17388/4	11/20/2019	11/19/2020
Coaxial Cable	Huber Suhner	RG 214/U	W22.03	11/20/2019	11/19/2020

Unless otherwise stated the results shown in this test report refer only to the sample(s) tested and such sample(s) are retained for 90 days only.

除非另有說明，此報告結果僅對測試之樣品負責，同時此樣品僅保留90天。本報告未經本公司書面許可，不可部份複製。

This document is issued by the Company subject to its General Conditions of Service printed overleaf, available on request or accessible at <http://www.sgs.com.tw/Terms-and-Conditions> and for electronic format documents, subject to Terms and Conditions for Electronic Documents at <http://www.sgs.com.tw/Terms-and-Conditions>. Attention is drawn to the limitation of liability, indemnification and jurisdiction issues defined therein. Any holder of this document is advised that information contained hereon reflects the Company's findings at the time of its intervention only and within the limits of Client's instructions, if any. The Company's sole responsibility is to its Client and this document does not exonerate parties to a transaction from exercising all their rights and obligations under the transaction documents. This document cannot be reproduced except in full, without prior written approval of the Company. Any unauthorized alteration, forgery or falsification of the content or appearance of this document is unlawful and offenders may be prosecuted to the fullest extent of the law.

11.3 Test SET-UP

(A) Radiated Emission Test Set-UP Frequency Below 30MHz.

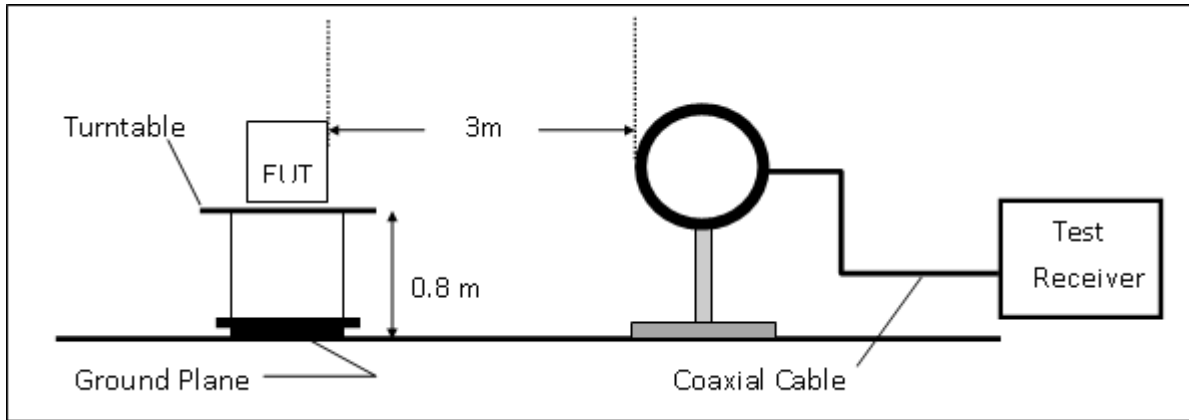

(B) Radiated Emission Test Set-Up, Frequency form 30MHz to 1000MHz

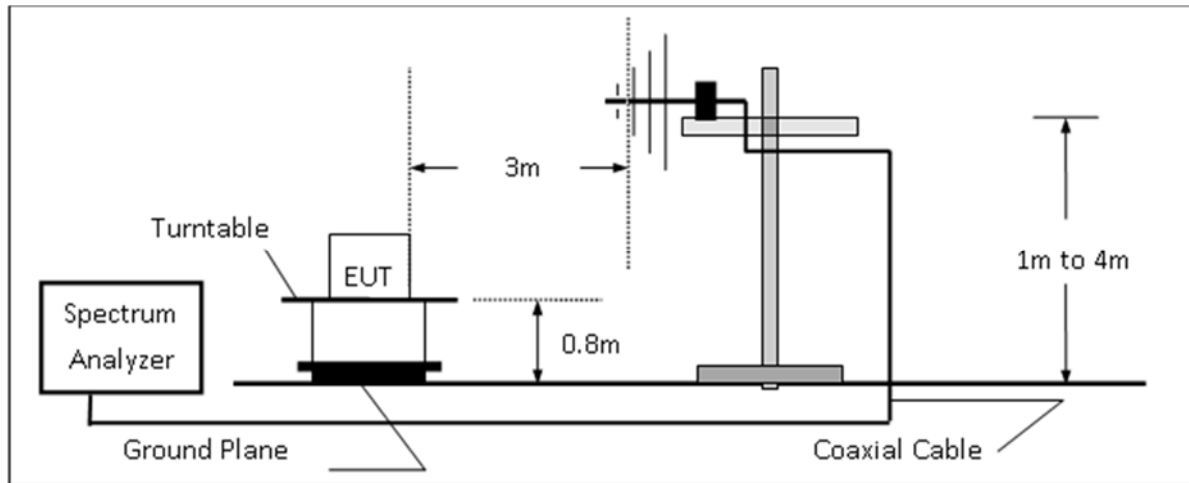

(C) Radiated Emission Test Set-UP Frequency Over 1 GHz

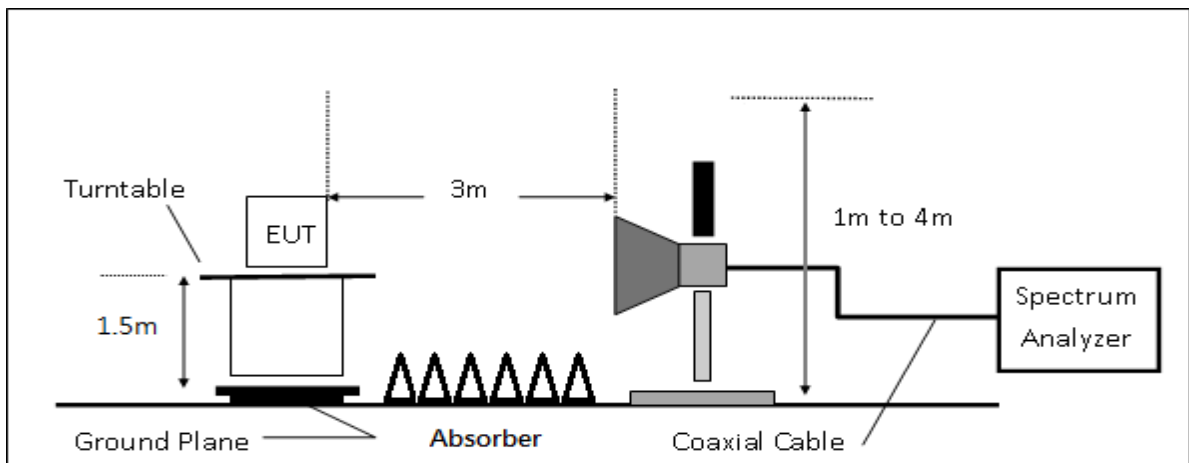

Unless otherwise stated the results shown in this test report refer only to the sample(s) tested and such sample(s) are retained for 90 days only.

除非另有說明，此報告結果僅對測試之樣品負責，同時此樣品僅保留90天。本報告未經本公司書面許可，不可部份複製。

This document is issued by the Company subject to its General Conditions of Service printed overleaf, available on request or accessible at <http://www.sgs.com.tw/Terms-and-Conditions> and for electronic format documents, subject to Terms and Conditions for Electronic Documents at <http://www.sgs.com.tw/Terms-and-Conditions>. Attention is drawn to the limitation of liability, indemnification and jurisdiction issues defined therein. Any holder of this document is advised that information contained hereon reflects the Company's findings at the time of its intervention only and within the limits of Client's instructions, if any. The Company's sole responsibility is to its Client and this document does not exonerate parties to a transaction from exercising all their rights and obligations under the transaction documents. This document cannot be reproduced except in full, without prior written approval of the Company. Any unauthorized alteration, forgery or falsification of the content or appearance of this document is unlawful and offenders may be prosecuted to the fullest extent of the law.

11.4 Measurement Procedure

1. The EUT was placed on a turn table which is 0.8m above ground plane.
2. The testing follows FCC KDB 789033 D02 General UNII Test Procedures New Rules .
3. The EUT was placed on a turn table with 0.8m for frequency < 1GHz and 1.5m for frequency > 1GHz above ground plane.
4. The turn table shall rotate 360 degrees to determine the position of maximum emission level.
5. EUT is set 3m away from the receiving antenna which varied from 1m to 4m to find out the highest emissions.
6. Set the spectrum analyzer as RBW=120 kHz and VBW=300 kHz for Peak Detector (PK) and Quasi-peak (QP) at frequency below 1 GHz.
7. At frequency above 1 GHz, Set the spectrum analyzer:
 - A. RBW=1 MHz, VBW=3 MHz for **Peak** Detector.
 - B. Set the spectrum analyzer as RBW=1 MHz, VBW=10 Hz (Duty cycle > 98%) or VBW ≥ 1/T (Duty cycle < 98%) for **Average** Detector.
8. Maximum procedure was performed on the six highest emissions to ensure EUT compliance.
9. And also, each emission was to be maximized by changing the polarization of receiving antenna both horizontal and vertical.
10. Repeat above procedures until all frequency measured were complete.

Unless otherwise stated the results shown in this test report refer only to the sample(s) tested and such sample(s) are retained for 90 days only.

除非另有說明，此報告結果僅對測試之樣品負責，同時此樣品僅保留90天。本報告未經本公司書面許可，不可部份複製。

This document is issued by the Company subject to its General Conditions of Service printed overleaf, available on request or accessible at <http://www.sgs.com.tw/Terms-and-Conditions> and for electronic format documents, subject to Terms and Conditions for Electronic Documents at <http://www.sgs.com.tw/Terms-and-Conditions>. Attention is drawn to the limitation of liability, indemnification and jurisdiction issues defined therein. Any holder of this document is advised that information contained hereon reflects the Company's findings at the time of its intervention only and within the limits of Client's instructions, if any. The Company's sole responsibility is to its Client and this document does not exonerate parties to a transaction from exercising all their rights and obligations under the transaction documents. This document cannot be reproduced except in full, without prior written approval of the Company. Any unauthorized alteration, forgery or falsification of the content or appearance of this document is unlawful and offenders may be prosecuted to the fullest extent of the law.

11.5 Field Strength Calculation

The field strength is calculated by adding the Antenna Factor and Cable Factor and subtracting the Amplifier Gain and Duty Cycle Correction Factor (if any) from the measured reading. The basic equation with a sample calculation is as follows:

$$FS = RA + AF + CL - AG$$

Where *FS = Field Strength*

CL = Cable Attenuation Factor (Cable Loss)

RA = Reading Amplitude

AG = Amplifier Gain

AF = Antenna Factor

The limit of the emission level is expressed in dBuV/m, which converts $20 \cdot \log(uV/m)$

Actual FS(dBμV/m) = SPA. Reading level(dBμV) + Factor(dB)

Factor(dB) = Antenna Factor(dBμV/m) + Cable Loss(dB) – Pre_Amplifier Gain(dB)

11.6 Test Results of Radiated Spurious Emissions form 9 KHz to 30 MHz

The low frequency, which started from 9 kHz to 30MHz, was pre-scanned and the result which was 20dB lower than the limit per 15.31(o) was not reported.

Unless otherwise stated the results shown in this test report refer only to the sample(s) tested and such sample(s) are retained for 90 days only.

除非另有說明，此報告結果僅對測試之樣品負責，同時此樣品僅保留90天。本報告未經本公司書面許可，不可部份複製。

This document is issued by the Company subject to its General Conditions of Service printed overleaf, available on request or accessible at <http://www.sgs.com.tw/Terms-and-Conditions> and for electronic format documents, subject to Terms and Conditions for Electronic Documents at <http://www.sgs.com.tw/Terms-and-Conditions>. Attention is drawn to the limitation of liability, indemnification and jurisdiction issues defined therein. Any holder of this document is advised that information contained hereon reflects the Company's findings at the time of its intervention only and within the limits of Client's instructions, if any. The Company's sole responsibility is to its Client and this document does not exonerate parties to a transaction from exercising all their rights and obligations under the transaction documents. This document cannot be reproduced except in full, without prior written approval of the Company. Any unauthorized alteration, forgery or falsification of the content or appearance of this document is unlawful and offenders may be prosecuted to the fullest extent of the law.

11.7 Radiated Spurious Emission Measurement Result

11.7.1 Below 1GHz Worst-Case Data:

Report Number	:ER-2020-80015	Test Site	:SAC III Chamber
Operation Mode	:802.11a	Test Date	:2020-08-10
Test Frequency	:5220 MHz	Temp./Humi.	:25.8/60
Test Mode	:Tx CH Mid	Antenna Pol.	:VERTICAL
EUT Pol	:H Plane	Engineer	:Ricky

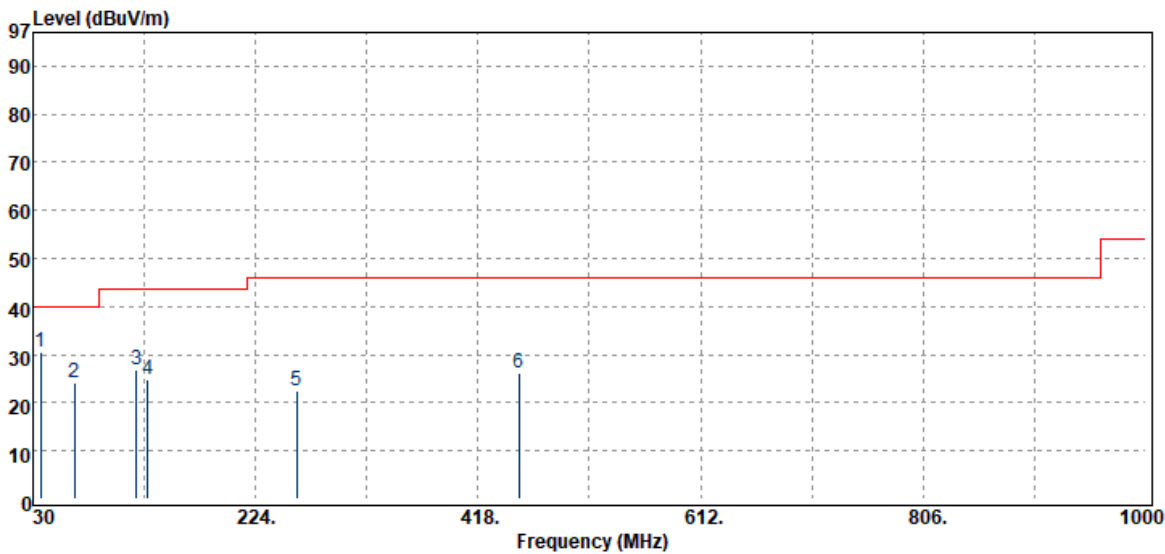

Freq. MHz	Detector Mode PK/QP/AV	Spectrum Reading Level dBuV	Factor dB	Actual FS dBuV/m	Limit @3m dBuV/m	Margin dB
36.79	QP	39.58	-8.93	30.65	40.00	-9.35
65.89	Peak	33.78	-9.78	24.00	40.00	-16.00
120.21	Peak	36.49	-9.74	26.75	43.50	-16.75
129.91	Peak	33.52	-8.55	24.97	43.50	-18.53
259.89	Peak	29.94	-7.53	22.41	46.00	-23.59
453.89	Peak	28.51	-2.42	26.09	46.00	-19.91

Unless otherwise stated the results shown in this test report refer only to the sample(s) tested and such sample(s) are retained for 90 days only.

除非另有說明，此報告結果僅對測試之樣品負責，同時此樣品僅保留90天。本報告未經本公司書面許可，不可部份複製。

This document is issued by the Company subject to its General Conditions of Service printed overleaf, available on request or accessible at <http://www.sgs.com.tw/Terms-and-Conditions> and for electronic format documents, subject to Terms and Conditions for Electronic Documents at <http://www.sgs.com.tw/Terms-and-Conditions>. Attention is drawn to the limitation of liability, indemnification and jurisdiction issues defined therein. Any holder of this document is advised that information contained hereon reflects the Company's findings at the time of its intervention only and within the limits of Client's instructions, if any. The Company's sole responsibility is to its Client and this document does not exonerate parties to a transaction from exercising all their rights and obligations under the transaction documents. This document cannot be reproduced except in full, without prior written approval of the Company. Any unauthorized alteration, forgery or falsification of the content or appearance of this document is unlawful and offenders may be prosecuted to the fullest extent of the law.

Report Number :ER-2020-80015
Operation Mode :802.11a
Test Frequency :5220 MHz
Test Mode :Tx CH Mid
EUT Pol :H Plane

Test Site :SAC III Chamber
Test Date :2020-08-10
Temp./Humi. :25.8/60
Antenna Pol. :HORIZONTAL
Engineer :Ricky

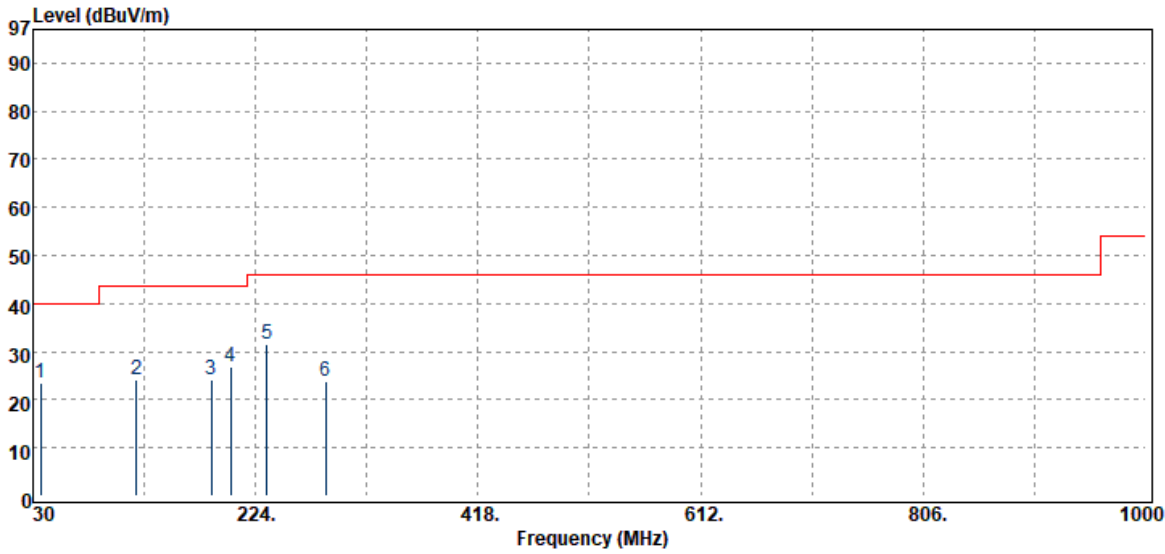

Freq. MHz	Detector Mode PK/QP/AV	Spectrum Reading Level dB μ V	Factor dB	Actual FS dB μ V/m	Limit @3m dB μ V/m	Margin dB
36.79	Peak	32.42	-8.93	23.49	40.00	-16.51
120.21	Peak	33.91	-9.74	24.17	43.50	-19.33
185.20	Peak	33.52	-9.24	24.28	43.50	-19.22
202.66	Peak	36.44	-9.70	26.74	43.50	-16.76
233.70	Peak	40.04	-8.62	31.42	46.00	-14.58
285.11	Peak	30.23	-6.41	23.82	46.00	-22.18

Unless otherwise stated the results shown in this test report refer only to the sample(s) tested and such sample(s) are retained for 90 days only.

除非另有說明，此報告結果僅對測試之樣品負責，同時此樣品僅保留90天。本報告未經本公司書面許可，不可部份複製。

This document is issued by the Company subject to its General Conditions of Service printed overleaf, available on request or accessible at <http://www.sgs.com.tw/Terms-and-Conditions> and for electronic format documents, subject to Terms and Conditions for Electronic Documents at <http://www.sgs.com.tw/Terms-and-Conditions>. Attention is drawn to the limitation of liability, indemnification and jurisdiction issues defined therein. Any holder of this document is advised that information contained hereon reflects the Company's findings at the time of its intervention only and within the limits of Client's instructions, if any. The Company's sole responsibility is to its Client and this document does not exonerate parties to a transaction from exercising all their rights and obligations under the transaction documents. This document cannot be reproduced except in full, without prior written approval of the Company. Any unauthorized alteration, forgery or falsification of the content or appearance of this document is unlawful and offenders may be prosecuted to the fullest extent of the law.

Report Number :ER-2020-80015
 Operation Mode :802.11a
 Test Frequency :5300 MHz
 Test Mode :Tx CH Mid
 EUT Pol :H Plane

Test Site :SAC III Chamber
 Test Date :2020-08-10
 Temp./Humi. :25.8/60
 Antenna Pol. :VERTICAL
 Engineer :Ricky

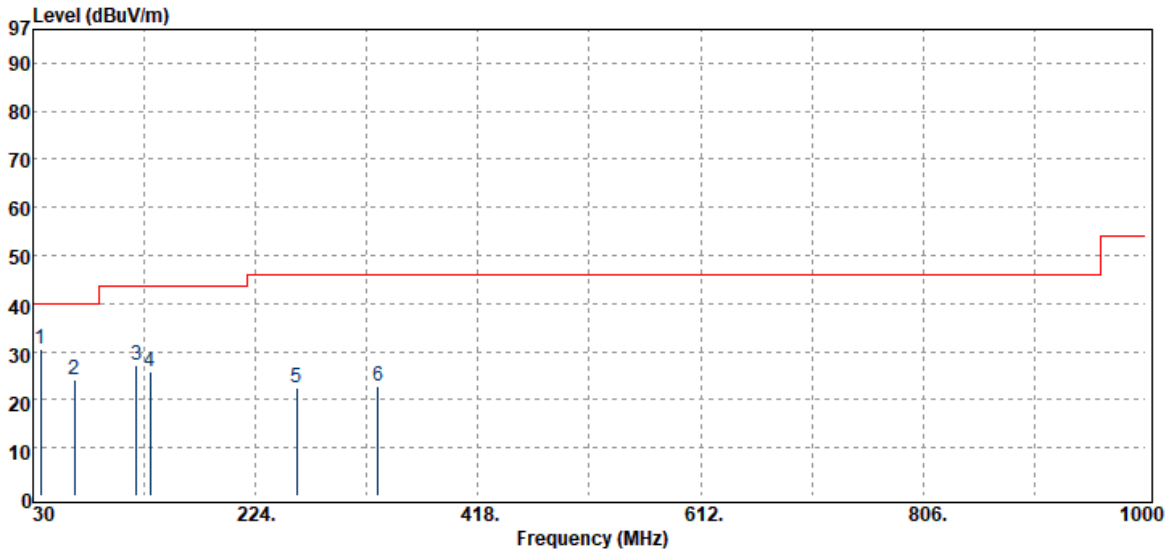

Freq. MHz	Detector Mode PK/QP/AV	Spectrum Reading Level dB μ V	Factor dB	Actual FS dB μ V/m	Limit @3m dB μ V/m	Margin dB
36.79	QP	39.47	-8.93	30.54	40.00	-9.46
65.89	Peak	33.90	-9.78	24.12	40.00	-15.88
120.21	Peak	36.82	-9.74	27.08	43.50	-16.42
131.85	Peak	34.28	-8.42	25.86	43.50	-17.64
259.89	Peak	30.10	-7.53	22.57	46.00	-23.43
330.70	Peak	27.86	-5.14	22.72	46.00	-23.28

Unless otherwise stated the results shown in this test report refer only to the sample(s) tested and such sample(s) are retained for 90 days only.

除非另有說明，此報告結果僅對測試之樣品負責，同時此樣品僅保留90天。本報告未經本公司書面許可，不可部份複製。

This document is issued by the Company subject to its General Conditions of Service printed overleaf, available on request or accessible at <http://www.sgs.com.tw/Terms-and-Conditions> and for electronic format documents, subject to Terms and Conditions for Electronic Documents at <http://www.sgs.com.tw/Terms-and-Conditions>. Attention is drawn to the limitation of liability, indemnification and jurisdiction issues defined therein. Any holder of this document is advised that information contained hereon reflects the Company's findings at the time of its intervention only and within the limits of Client's instructions, if any. The Company's sole responsibility is to its Client and this document does not exonerate parties to a transaction from exercising all their rights and obligations under the transaction documents. This document cannot be reproduced except in full, without prior written approval of the Company. Any unauthorized alteration, forgery or falsification of the content or appearance of this document is unlawful and offenders may be prosecuted to the fullest extent of the law.

Report Number :ER-2020-80015
 Operation Mode :802.11a
 Test Frequency :5300 MHz
 Test Mode :Tx CH Mid
 EUT Pol :H Plane

Test Site :SAC III Chamber
 Test Date :2020-08-10
 Temp./Humi. :25.8/60
 Antenna Pol. :HORIZONTAL
 Engineer :Ricky

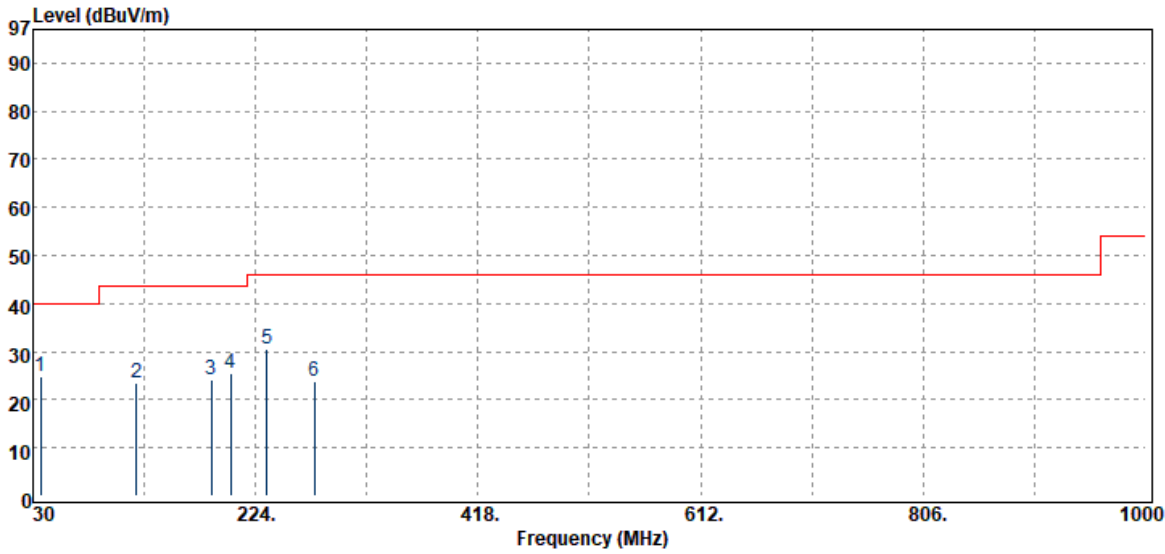

Freq. MHz	Detector Mode PK/QP/AV	Spectrum Reading Level dB μ V	Factor dB	Actual FS dB μ V/m	Limit @3m dB μ V/m	Margin dB
36.79	Peak	33.89	-8.93	24.96	40.00	-15.04
120.21	Peak	33.31	-9.74	23.57	43.50	-19.93
185.20	Peak	33.24	-9.24	24.00	43.50	-19.50
202.66	Peak	35.30	-9.70	25.60	43.50	-17.90
233.70	Peak	39.01	-8.62	30.39	46.00	-15.61
275.41	Peak	30.53	-6.83	23.70	46.00	-22.30

Unless otherwise stated the results shown in this test report refer only to the sample(s) tested and such sample(s) are retained for 90 days only.

除非另有說明，此報告結果僅對測試之樣品負責，同時此樣品僅保留90天。本報告未經本公司書面許可，不可部份複製。

This document is issued by the Company subject to its General Conditions of Service printed overleaf, available on request or accessible at <http://www.sgs.com.tw/Terms-and-Conditions> and for electronic format documents, subject to Terms and Conditions for Electronic Documents at <http://www.sgs.com.tw/Terms-and-Conditions>. Attention is drawn to the limitation of liability, indemnification and jurisdiction issues defined therein. Any holder of this document is advised that information contained hereon reflects the Company's findings at the time of its intervention only and within the limits of Client's instructions, if any. The Company's sole responsibility is to its Client and this document does not exonerate parties to a transaction from exercising all their rights and obligations under the transaction documents. This document cannot be reproduced except in full, without prior written approval of the Company. Any unauthorized alteration, forgery or falsification of the content or appearance of this document is unlawful and offenders may be prosecuted to the fullest extent of the law.

Report Number :ER-2020-80015
 Operation Mode :802.11a
 Test Frequency :5580 MHz
 Test Mode :Tx CH Mid
 EUT Pol :H Plane

Test Site :SAC III Chamber
 Test Date :2020-08-10
 Temp./Humi. :25.8/60
 Antenna Pol. :VERTICAL
 Engineer :Ricky

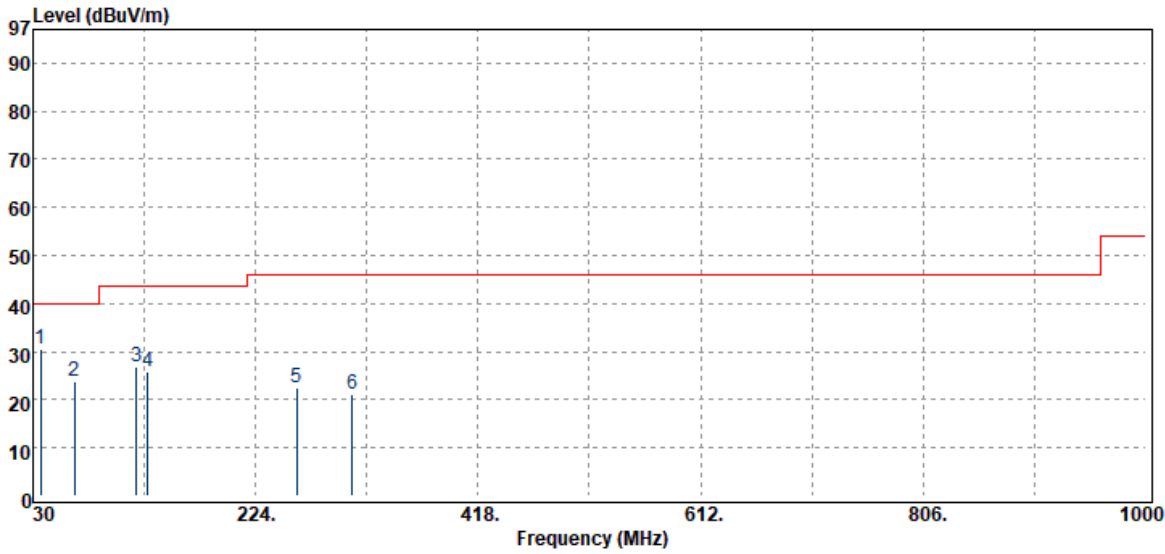

Freq. MHz	Detector Mode PK/QP/AV	Spectrum Reading Level dB μ V	Factor dB	Actual FS dB μ V/m	Limit @3m dB μ V/m	Margin dB
36.79	QP	39.39	-8.93	30.46	40.00	-9.54
65.89	Peak	33.52	-9.78	23.74	40.00	-16.26
120.21	Peak	36.68	-9.74	26.94	43.50	-16.56
129.91	Peak	34.42	-8.55	25.87	43.50	-17.63
259.89	Peak	29.90	-7.53	22.37	46.00	-23.63
308.39	Peak	27.26	-5.96	21.30	46.00	-24.70

Unless otherwise stated the results shown in this test report refer only to the sample(s) tested and such sample(s) are retained for 90 days only.

除非另有說明，此報告結果僅對測試之樣品負責，同時此樣品僅保留90天。本報告未經本公司書面許可，不可部份複製。

This document is issued by the Company subject to its General Conditions of Service printed overleaf, available on request or accessible at <http://www.sgs.com.tw/Terms-and-Conditions> and for electronic format documents, subject to Terms and Conditions for Electronic Documents at <http://www.sgs.com.tw/Terms-and-Conditions>. Attention is drawn to the limitation of liability, indemnification and jurisdiction issues defined therein. Any holder of this document is advised that information contained hereon reflects the Company's findings at the time of its intervention only and within the limits of Client's instructions, if any. The Company's sole responsibility is to its Client and this document does not exonerate parties to a transaction from exercising all their rights and obligations under the transaction documents. This document cannot be reproduced except in full, without prior written approval of the Company. Any unauthorized alteration, forgery or falsification of the content or appearance of this document is unlawful and offenders may be prosecuted to the fullest extent of the law.

Report Number :ER-2020-80015
 Operation Mode :802.11a
 Test Frequency :5580 MHz
 Test Mode :Tx CH Mid
 EUT Pol :H Plane

Test Site :SAC III Chamber
 Test Date :2020-08-10
 Temp./Humi. :25.8/60
 Antenna Pol. :HORIZONTAL
 Engineer :Ricky

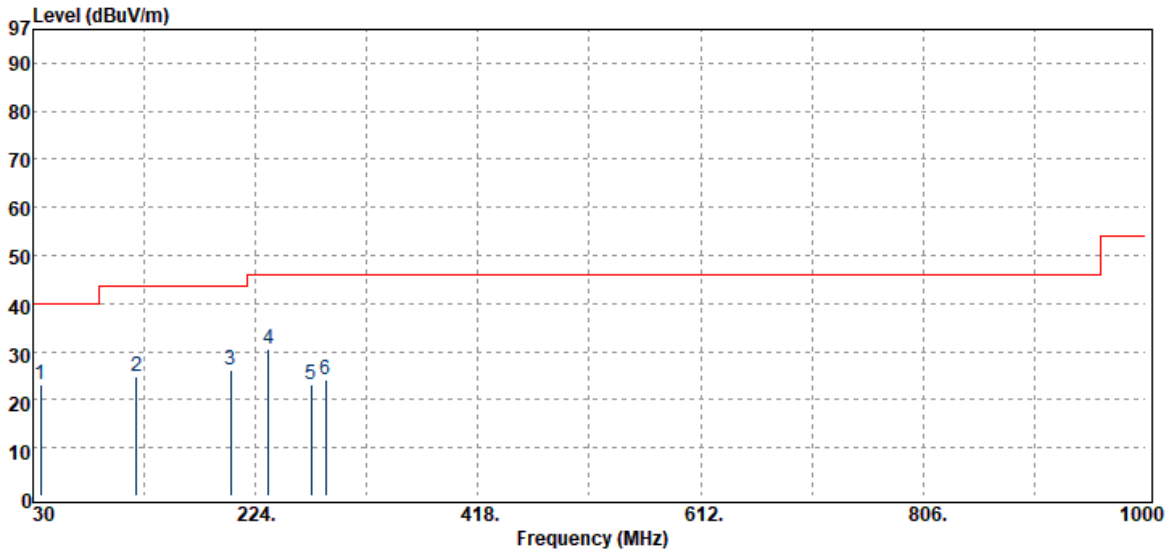

Freq. MHz	Detector Mode PK/QP/AV	Spectrum Reading Level dB μ V	Factor dB	Actual FS dB μ V/m	Limit @3m dB μ V/m	Margin dB
36.79	Peak	32.11	-8.93	23.18	40.00	-16.82
120.21	Peak	34.48	-9.74	24.74	43.50	-18.76
202.66	Peak	36.04	-9.70	26.34	43.50	-17.16
235.64	Peak	39.04	-8.44	30.60	46.00	-15.40
272.50	Peak	30.07	-6.91	23.16	46.00	-22.84
285.11	Peak	30.49	-6.41	24.08	46.00	-21.92

Unless otherwise stated the results shown in this test report refer only to the sample(s) tested and such sample(s) are retained for 90 days only.

除非另有說明，此報告結果僅對測試之樣品負責，同時此樣品僅保留90天。本報告未經本公司書面許可，不可部份複製。

This document is issued by the Company subject to its General Conditions of Service printed overleaf, available on request or accessible at <http://www.sgs.com.tw/Terms-and-Conditions> and for electronic format documents, subject to Terms and Conditions for Electronic Documents at <http://www.sgs.com.tw/Terms-and-Conditions>. Attention is drawn to the limitation of liability, indemnification and jurisdiction issues defined therein. Any holder of this document is advised that information contained hereon reflects the Company's findings at the time of its intervention only and within the limits of Client's instructions, if any. The Company's sole responsibility is to its Client and this document does not exonerate parties to a transaction from exercising all their rights and obligations under the transaction documents. This document cannot be reproduced except in full, without prior written approval of the Company. Any unauthorized alteration, forgery or falsification of the content or appearance of this document is unlawful and offenders may be prosecuted to the fullest extent of the law.

Report Number :ER-2020-80015
 Operation Mode :802.11a
 Test Frequency :5785 MHz
 Test Mode :Tx CH Mid
 EUT Pol :H Plane

Test Site :SAC III Chamber
 Test Date :2020-08-10
 Temp./Humi. :25.8/60
 Antenna Pol. :VERTICAL
 Engineer :Ricky

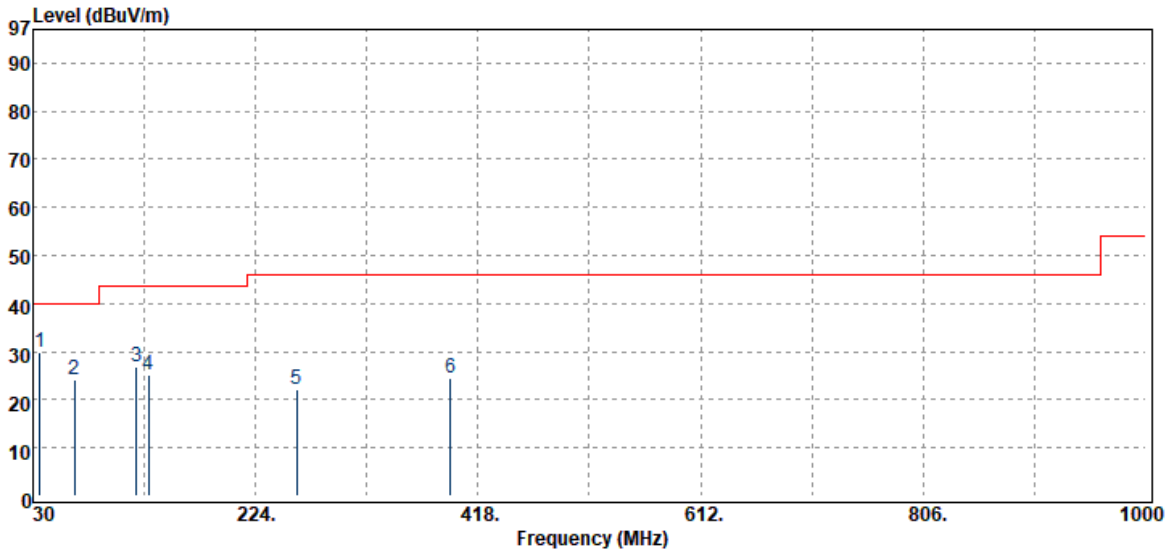

Freq. MHz	Detector Mode PK/QP/AV	Spectrum Reading Level dB μ V	Factor dB	Actual FS dB μ V/m	Limit @3m dB μ V/m	Margin dB
35.82	QP	38.76	-8.88	29.88	40.00	-10.12
65.89	Peak	33.97	-9.78	24.19	40.00	-15.81
120.21	Peak	36.43	-9.74	26.69	43.50	-16.81
130.88	Peak	33.45	-8.43	25.02	43.50	-18.48
259.89	Peak	29.75	-7.53	22.22	46.00	-23.78
393.75	Peak	28.88	-4.35	24.53	46.00	-21.47

Unless otherwise stated the results shown in this test report refer only to the sample(s) tested and such sample(s) are retained for 90 days only.

除非另有說明，此報告結果僅對測試之樣品負責，同時此樣品僅保留90天。本報告未經本公司書面許可，不可部份複製。

This document is issued by the Company subject to its General Conditions of Service printed overleaf, available on request or accessible at <http://www.sgs.com.tw/Terms-and-Conditions> and for electronic format documents, subject to Terms and Conditions for Electronic Documents at <http://www.sgs.com.tw/Terms-and-Conditions>. Attention is drawn to the limitation of liability, indemnification and jurisdiction issues defined therein. Any holder of this document is advised that information contained hereon reflects the Company's findings at the time of its intervention only and within the limits of Client's instructions, if any. The Company's sole responsibility is to its Client and this document does not exonerate parties to a transaction from exercising all their rights and obligations under the transaction documents. This document cannot be reproduced except in full, without prior written approval of the Company. Any unauthorized alteration, forgery or falsification of the content or appearance of this document is unlawful and offenders may be prosecuted to the fullest extent of the law.

Report Number :ER-2020-80015
 Operation Mode :802.11a
 Test Frequency :5785 MHz
 Test Mode :Tx CH Mid
 EUT Pol :H Plane

Test Site :SAC III Chamber
 Test Date :2020-08-10
 Temp./Humi. :25.8/60
 Antenna Pol. :HORIZONTAL
 Engineer :Ricky

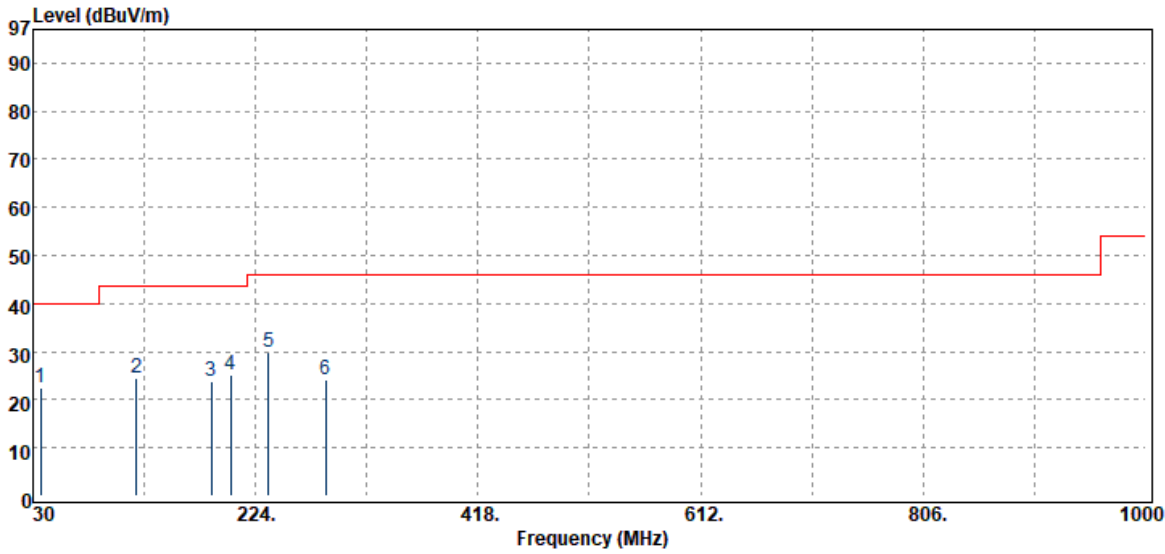

Freq. MHz	Detector Mode PK/QP/AV	Spectrum Reading Level dB μ V	Factor dB	Actual FS dB μ V/m	Limit @3m dB μ V/m	Margin dB
36.79	Peak	31.40	-8.93	22.47	40.00	-17.53
120.21	Peak	34.18	-9.74	24.44	43.50	-19.06
185.20	Peak	32.97	-9.24	23.73	43.50	-19.77
202.66	Peak	34.73	-9.70	25.03	43.50	-18.47
235.64	Peak	38.42	-8.44	29.98	46.00	-16.02
285.11	Peak	30.53	-6.41	24.12	46.00	-21.88

Unless otherwise stated the results shown in this test report refer only to the sample(s) tested and such sample(s) are retained for 90 days only.

除非另有說明，此報告結果僅對測試之樣品負責，同時此樣品僅保留90天。本報告未經本公司書面許可，不可部份複製。

This document is issued by the Company subject to its General Conditions of Service printed overleaf, available on request or accessible at <http://www.sgs.com.tw/Terms-and-Conditions> and for electronic format documents, subject to Terms and Conditions for Electronic Documents at <http://www.sgs.com.tw/Terms-and-Conditions>. Attention is drawn to the limitation of liability, indemnification and jurisdiction issues defined therein. Any holder of this document is advised that information contained hereon reflects the Company's findings at the time of its intervention only and within the limits of Client's instructions, if any. The Company's sole responsibility is to its Client and this document does not exonerate parties to a transaction from exercising all their rights and obligations under the transaction documents. This document cannot be reproduced except in full, without prior written approval of the Company. Any unauthorized alteration, forgery or falsification of the content or appearance of this document is unlawful and offenders may be prosecuted to the fullest extent of the law.

11.7.2 Above 1GHz Worst-Case Data:

Report Number	:ER-2020-80015	Test Site	:SAC III Chamber
Operation Mode	:802.11a	Test Date	:2020-08-10
Test Frequency	:5180 MHz	Temp./Humi.	:25.8/60
Test Mode	:Tx CH Low	Antenna Pol.	:VERTICAL
EUT Pol	:H Plane	Engineer	:Ricky

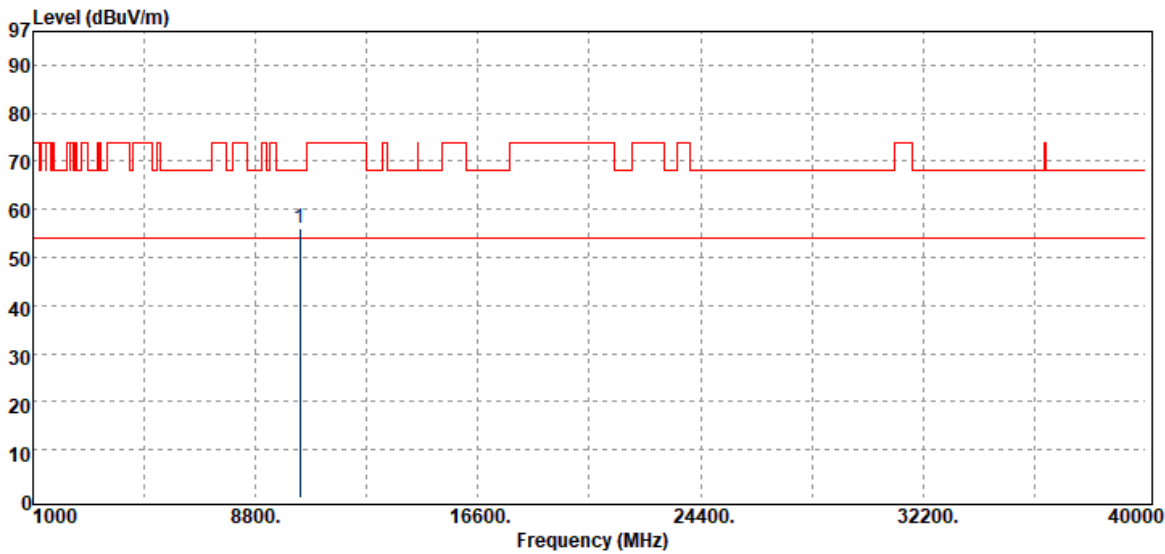

Freq. MHz	Detector Mode PK/QP/AV	Spectrum Reading Level dB μ V	Factor dB	Actual FS dB μ V/m	Limit @3m dB μ V/m	Margin dB
10360.00	Peak	35.58	20.59	56.17	68.20	-12.03

Unless otherwise stated the results shown in this test report refer only to the sample(s) tested and such sample(s) are retained for 90 days only.

除非另有說明，此報告結果僅對測試之樣品負責，同時此樣品僅保留90天。本報告未經本公司書面許可，不可部份複製。

This document is issued by the Company subject to its General Conditions of Service printed overleaf, available on request or accessible at <http://www.sgs.com.tw/Terms-and-Conditions> and for electronic format documents, subject to Terms and Conditions for Electronic Documents at <http://www.sgs.com.tw/Terms-and-Conditions>. Attention is drawn to the limitation of liability, indemnification and jurisdiction issues defined therein. Any holder of this document is advised that information contained hereon reflects the Company's findings at the time of its intervention only and within the limits of Client's instructions, if any. The Company's sole responsibility is to its Client and this document does not exonerate parties to a transaction from exercising all their rights and obligations under the transaction documents. This document cannot be reproduced except in full, without prior written approval of the Company. Any unauthorized alteration, forgery or falsification of the content or appearance of this document is unlawful and offenders may be prosecuted to the fullest extent of the law.

Report Number :ER-2020-80015
 Operation Mode :802.11a
 Test Frequency :5180 MHz
 Test Mode :Tx CH Low
 EUT Pol :H Plane

Test Site :SAC III Chamber
 Test Date :2020-08-10
 Temp./Humi. :25.8/60
 Antenna Pol. :HORIZONTAL
 Engineer :Ricky

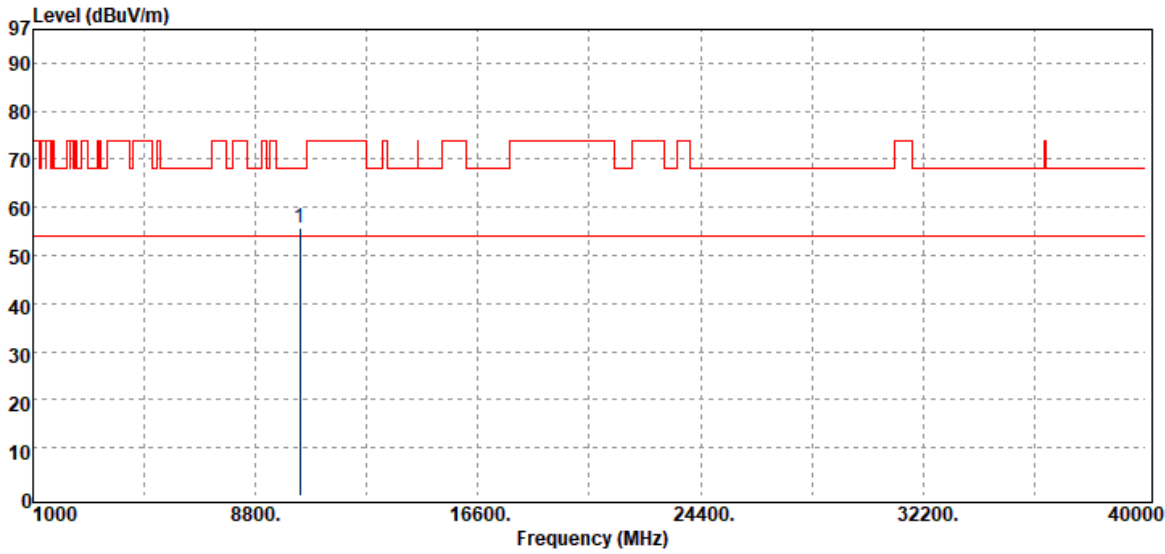

Freq. MHz	Detector Mode PK/QP/AV	Spectrum Reading Level dB μ V	Factor dB	Actual FS dB μ V/m	Limit @3m dB μ V/m	Margin dB
10360.00	Peak	35.22	20.59	55.81	68.20	-12.39

Unless otherwise stated the results shown in this test report refer only to the sample(s) tested and such sample(s) are retained for 90 days only.

除非另有說明，此報告結果僅對測試之樣品負責，同時此樣品僅保留90天。本報告未經本公司書面許可，不可部份複製。

This document is issued by the Company subject to its General Conditions of Service printed overleaf, available on request or accessible at <http://www.sgs.com.tw/Terms-and-Conditions> and for electronic format documents, subject to Terms and Conditions for Electronic Documents at <http://www.sgs.com.tw/Terms-and-Conditions>. Attention is drawn to the limitation of liability, indemnification and jurisdiction issues defined therein. Any holder of this document is advised that information contained hereon reflects the Company's findings at the time of its intervention only and within the limits of Client's instructions, if any. The Company's sole responsibility is to its Client and this document does not exonerate parties to a transaction from exercising all their rights and obligations under the transaction documents. This document cannot be reproduced except in full, without prior written approval of the Company. Any unauthorized alteration, forgery or falsification of the content or appearance of this document is unlawful and offenders may be prosecuted to the fullest extent of the law.

Report Number :ER-2020-80015
Operation Mode :802.11a
Test Frequency :5220 MHz
Test Mode :Tx CH Mid
EUT Pol :H Plane

Test Site :SAC III Chamber
Test Date :2020-08-10
Temp./Humi. :25.8/60
Antenna Pol. :VERTICAL
Engineer :Ricky

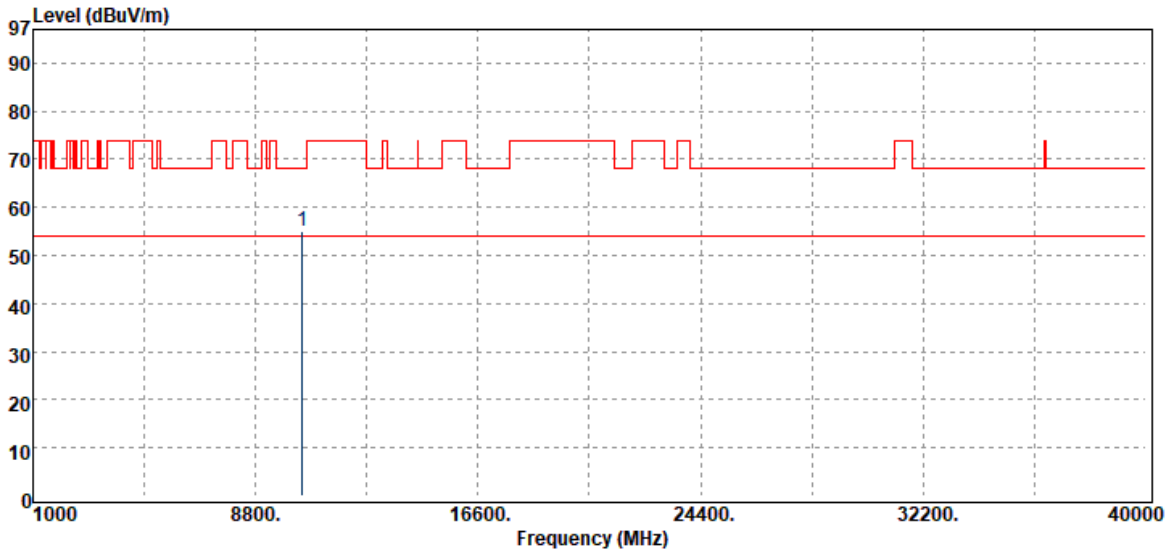

Freq. MHz	Detector Mode PK/QP/AV	Spectrum Reading Level dB μ V	Factor dB	Actual FS dB μ V/m	Limit @3m dB μ V/m	Margin dB
10440.00	Peak	34.00	21.08	55.08	68.20	-13.12

Unless otherwise stated the results shown in this test report refer only to the sample(s) tested and such sample(s) are retained for 90 days only.

除非另有說明，此報告結果僅對測試之樣品負責，同時此樣品僅保留90天。本報告未經本公司書面許可，不可部份複製。

This document is issued by the Company subject to its General Conditions of Service printed overleaf, available on request or accessible at <http://www.sgs.com.tw/Terms-and-Conditions> and for electronic format documents, subject to Terms and Conditions for Electronic Documents at <http://www.sgs.com.tw/Terms-and-Conditions>. Attention is drawn to the limitation of liability, indemnification and jurisdiction issues defined therein. Any holder of this document is advised that information contained hereon reflects the Company's findings at the time of its intervention only and within the limits of Client's instructions, if any. The Company's sole responsibility is to its Client and this document does not exonerate parties to a transaction from exercising all their rights and obligations under the transaction documents. This document cannot be reproduced except in full, without prior written approval of the Company. Any unauthorized alteration, forgery or falsification of the content or appearance of this document is unlawful and offenders may be prosecuted to the fullest extent of the law.

Report Number :ER-2020-80015
 Operation Mode :802.11a
 Test Frequency :5220 MHz
 Test Mode :Tx CH Mid
 EUT Pol :H Plane

Test Site :SAC III Chamber
 Test Date :2020-08-10
 Temp./Humi. :25.8/60
 Antenna Pol. :HORIZONTAL
 Engineer :Ricky

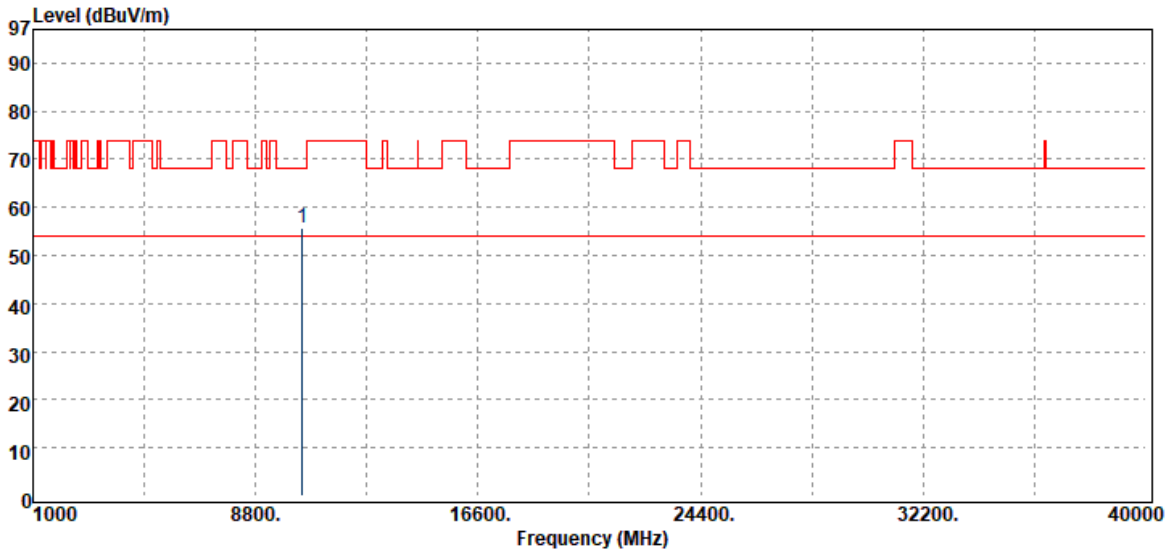

Freq. MHz	Detector Mode PK/QP/AV	Spectrum Reading Level dB μ V	Factor dB	Actual FS dB μ V/m	Limit @3m dB μ V/m	Margin dB
10440.00	Peak	34.49	21.08	55.57	68.20	-12.63

Unless otherwise stated the results shown in this test report refer only to the sample(s) tested and such sample(s) are retained for 90 days only.

除非另有說明，此報告結果僅對測試之樣品負責，同時此樣品僅保留90天。本報告未經本公司書面許可，不可部份複製。

This document is issued by the Company subject to its General Conditions of Service printed overleaf, available on request or accessible at <http://www.sgs.com.tw/Terms-and-Conditions> and for electronic format documents, subject to Terms and Conditions for Electronic Documents at <http://www.sgs.com.tw/Terms-and-Conditions>. Attention is drawn to the limitation of liability, indemnification and jurisdiction issues defined therein. Any holder of this document is advised that information contained hereon reflects the Company's findings at the time of its intervention only and within the limits of Client's instructions, if any. The Company's sole responsibility is to its Client and this document does not exonerate parties to a transaction from exercising all their rights and obligations under the transaction documents. This document cannot be reproduced except in full, without prior written approval of the Company. Any unauthorized alteration, forgery or falsification of the content or appearance of this document is unlawful and offenders may be prosecuted to the fullest extent of the law.

Report Number :ER-2020-80015
 Operation Mode :802.11a
 Test Frequency :5240 MHz
 Test Mode :Tx CH High
 EUT Pol :H Plane

Test Site :SAC III Chamber
 Test Date :2020-08-10
 Temp./Humi. :25.8/60
 Antenna Pol. :VERTICAL
 Engineer :Ricky

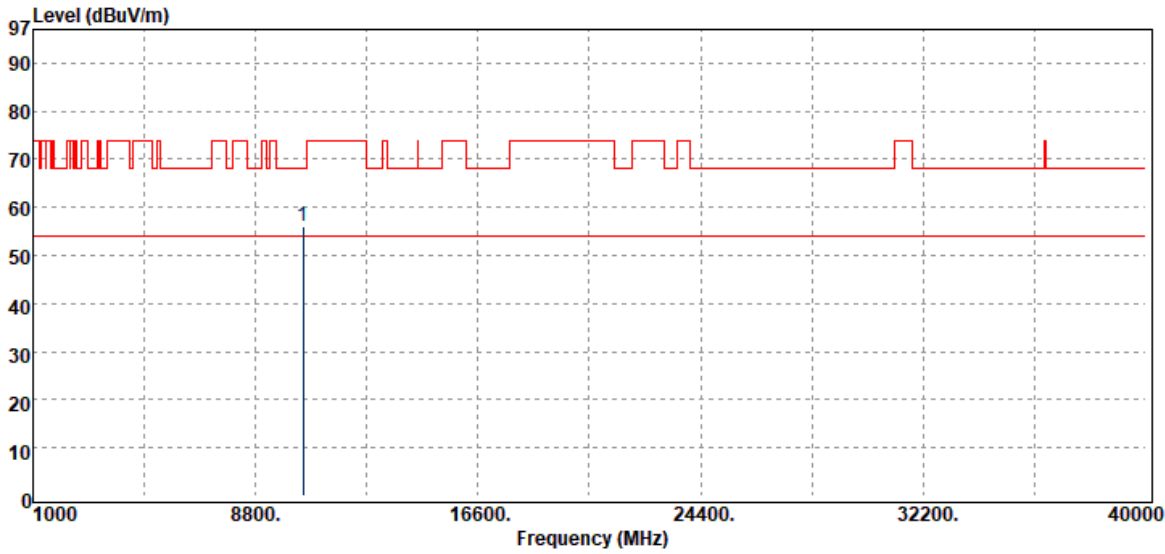

Freq. MHz	Detector Mode PK/QP/AV	Spectrum Reading Level dB μ V	Factor dB	Actual FS dB μ V/m	Limit @3m dB μ V/m	Margin dB
10480.00	Peak	34.86	21.21	56.07	68.20	-12.13

Unless otherwise stated the results shown in this test report refer only to the sample(s) tested and such sample(s) are retained for 90 days only.

除非另有說明，此報告結果僅對測試之樣品負責，同時此樣品僅保留90天。本報告未經本公司書面許可，不可部份複製。

This document is issued by the Company subject to its General Conditions of Service printed overleaf, available on request or accessible at <http://www.sgs.com.tw/Terms-and-Conditions> and for electronic format documents, subject to Terms and Conditions for Electronic Documents at <http://www.sgs.com.tw/Terms-and-Conditions>. Attention is drawn to the limitation of liability, indemnification and jurisdiction issues defined therein. Any holder of this document is advised that information contained hereon reflects the Company's findings at the time of its intervention only and within the limits of Client's instructions, if any. The Company's sole responsibility is to its Client and this document does not exonerate parties to a transaction from exercising all their rights and obligations under the transaction documents. This document cannot be reproduced except in full, without prior written approval of the Company. Any unauthorized alteration, forgery or falsification of the content or appearance of this document is unlawful and offenders may be prosecuted to the fullest extent of the law.

Report Number :ER-2020-80015
Operation Mode :802.11a
Test Frequency :5240 MHz
Test Mode :Tx CH High
EUT Pol :H Plane

Test Site :SAC III Chamber
Test Date :2020-08-10
Temp./Humi. :25.8/60
Antenna Pol. :HORIZONTAL
Engineer :Ricky

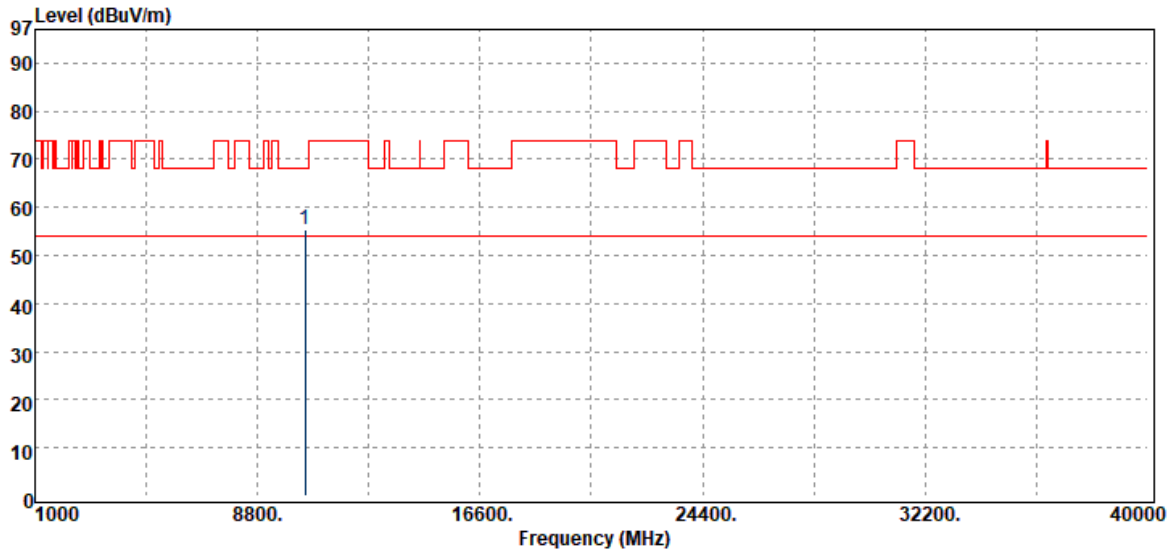

Freq. MHz	Detector Mode PK/QP/AV	Spectrum Reading Level dB μ V	Factor dB	Actual FS dB μ V/m	Limit @3m dB μ V/m	Margin dB
10480.00	Peak	34.09	21.21	55.30	68.20	-12.90

Unless otherwise stated the results shown in this test report refer only to the sample(s) tested and such sample(s) are retained for 90 days only.

除非另有說明，此報告結果僅對測試之樣品負責，同時此樣品僅保留90天。本報告未經本公司書面許可，不可部份複製。

This document is issued by the Company subject to its General Conditions of Service printed overleaf, available on request or accessible at <http://www.sgs.com.tw/Terms-and-Conditions> and for electronic format documents, subject to Terms and Conditions for Electronic Documents at <http://www.sgs.com.tw/Terms-and-Conditions>. Attention is drawn to the limitation of liability, indemnification and jurisdiction issues defined therein. Any holder of this document is advised that information contained hereon reflects the Company's findings at the time of its intervention only and within the limits of Client's instructions, if any. The Company's sole responsibility is to its Client and this document does not exonerate parties to a transaction from exercising all their rights and obligations under the transaction documents. This document cannot be reproduced except in full, without prior written approval of the Company. Any unauthorized alteration, forgery or falsification of the content or appearance of this document is unlawful and offenders may be prosecuted to the fullest extent of the law.

Report Number :ER-2020-80015
Operation Mode :802.11a
Test Frequency :5260 MHz
Test Mode :Tx CH Low
EUT Pol :H Plane

Test Site :SAC III Chamber
Test Date :2020-08-10
Temp./Humi. :25.8/60
Antenna Pol. :VERTICAL
Engineer :Ricky

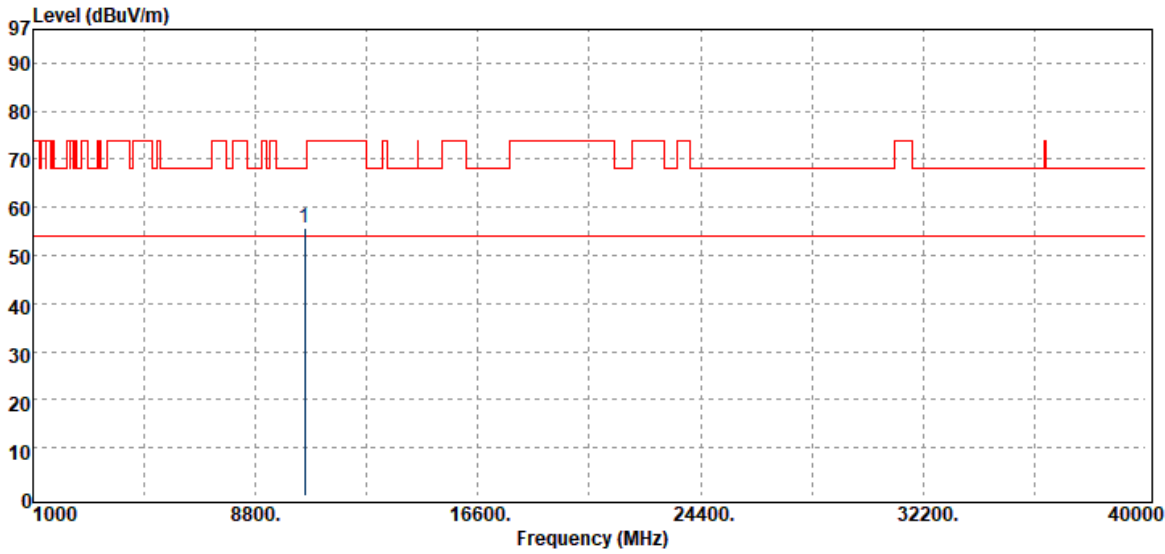

Freq. MHz	Detector Mode PK/QP/AV	Spectrum Reading Level dB μ V	Factor dB	Actual FS dB μ V/m	Limit @3m dB μ V/m	Margin dB
10520.00	Peak	34.54	21.27	55.81	68.20	-12.39

Unless otherwise stated the results shown in this test report refer only to the sample(s) tested and such sample(s) are retained for 90 days only.

除非另有說明，此報告結果僅對測試之樣品負責，同時此樣品僅保留90天。本報告未經本公司書面許可，不可部份複製。

This document is issued by the Company subject to its General Conditions of Service printed overleaf, available on request or accessible at <http://www.sgs.com.tw/Terms-and-Conditions> and for electronic format documents, subject to Terms and Conditions for Electronic Documents at <http://www.sgs.com.tw/Terms-and-Conditions>. Attention is drawn to the limitation of liability, indemnification and jurisdiction issues defined therein. Any holder of this document is advised that information contained hereon reflects the Company's findings at the time of its intervention only and within the limits of Client's instructions, if any. The Company's sole responsibility is to its Client and this document does not exonerate parties to a transaction from exercising all their rights and obligations under the transaction documents. This document cannot be reproduced except in full, without prior written approval of the Company. Any unauthorized alteration, forgery or falsification of the content or appearance of this document is unlawful and offenders may be prosecuted to the fullest extent of the law.

Report Number :ER-2020-80015
 Operation Mode :802.11a
 Test Frequency :5260 MHz
 Test Mode :Tx CH Low
 EUT Pol :H Plane

Test Site :SAC III Chamber
 Test Date :2020-08-10
 Temp./Humi. :25.8/60
 Antenna Pol. :HORIZONTAL
 Engineer :Ricky

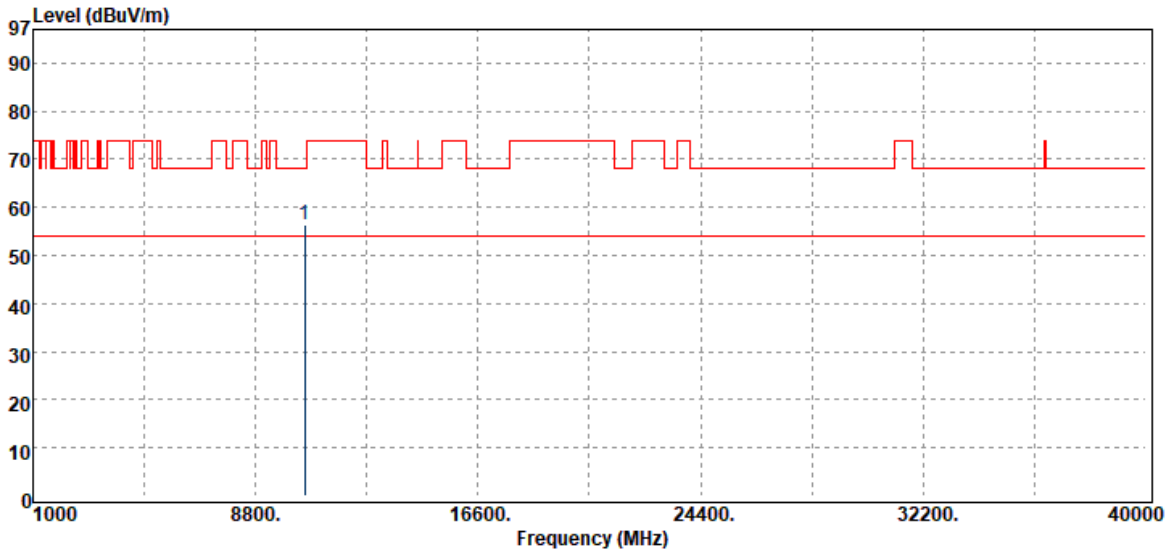

Freq. MHz	Detector Mode PK/QP/AV	Spectrum Reading Level dB μ V	Factor dB	Actual FS dB μ V/m	Limit @3m dB μ V/m	Margin dB
10520.00	Peak	35.20	21.27	56.47	68.20	-11.73

Unless otherwise stated the results shown in this test report refer only to the sample(s) tested and such sample(s) are retained for 90 days only.

除非另有說明，此報告結果僅對測試之樣品負責，同時此樣品僅保留90天。本報告未經本公司書面許可，不可部份複製。

This document is issued by the Company subject to its General Conditions of Service printed overleaf, available on request or accessible at <http://www.sgs.com.tw/Terms-and-Conditions> and for electronic format documents, subject to Terms and Conditions for Electronic Documents at <http://www.sgs.com.tw/Terms-and-Conditions>. Attention is drawn to the limitation of liability, indemnification and jurisdiction issues defined therein. Any holder of this document is advised that information contained hereon reflects the Company's findings at the time of its intervention only and within the limits of Client's instructions, if any. The Company's sole responsibility is to its Client and this document does not exonerate parties to a transaction from exercising all their rights and obligations under the transaction documents. This document cannot be reproduced except in full, without prior written approval of the Company. Any unauthorized alteration, forgery or falsification of the content or appearance of this document is unlawful and offenders may be prosecuted to the fullest extent of the law.

Report Number :ER-2020-80015
 Operation Mode :802.11a
 Test Frequency :5300 MHz
 Test Mode :Tx CH Mid
 EUT Pol :H Plane

Test Site :SAC III Chamber
 Test Date :2020-08-10
 Temp./Humi. :25.8/60
 Antenna Pol. :VERTICAL
 Engineer :Ricky

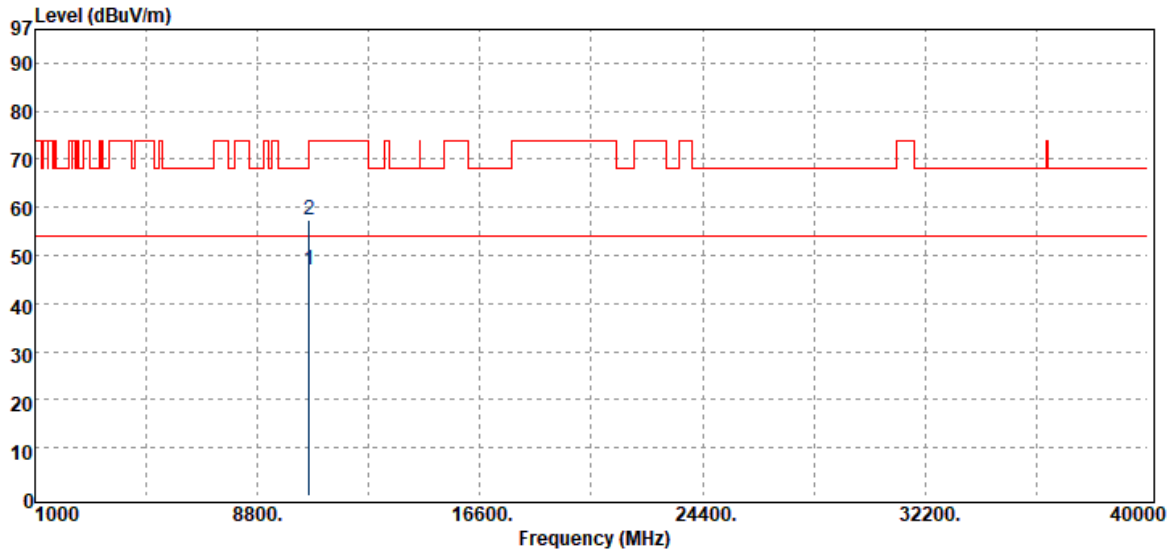

Freq. MHz	Detector Mode PK/QP/AV	Spectrum Reading Level dB μ V	Factor dB	Actual FS dB μ V/m	Limit @3m dB μ V/m	Margin dB
10600.00	Average	25.63	21.27	46.90	54.00	-7.10
10600.00	Peak	36.00	21.27	57.27	74.00	-16.73

Unless otherwise stated the results shown in this test report refer only to the sample(s) tested and such sample(s) are retained for 90 days only.

除非另有說明，此報告結果僅對測試之樣品負責，同時此樣品僅保留90天。本報告未經本公司書面許可，不可部份複製。

This document is issued by the Company subject to its General Conditions of Service printed overleaf, available on request or accessible at <http://www.sgs.com.tw/Terms-and-Conditions> and for electronic format documents, subject to Terms and Conditions for Electronic Documents at <http://www.sgs.com.tw/Terms-and-Conditions>. Attention is drawn to the limitation of liability, indemnification and jurisdiction issues defined therein. Any holder of this document is advised that information contained hereon reflects the Company's findings at the time of its intervention only and within the limits of Client's instructions, if any. The Company's sole responsibility is to its Client and this document does not exonerate parties to a transaction from exercising all their rights and obligations under the transaction documents. This document cannot be reproduced except in full, without prior written approval of the Company. Any unauthorized alteration, forgery or falsification of the content or appearance of this document is unlawful and offenders may be prosecuted to the fullest extent of the law.

Report Number :ER-2020-80015
 Operation Mode :802.11a
 Test Frequency :5300 MHz
 Test Mode :Tx CH Mid
 EUT Pol :H Plane

Test Site :SAC III Chamber
 Test Date :2020-08-10
 Temp./Humi. :25.8/60
 Antenna Pol. :HORIZONTAL
 Engineer :Ricky

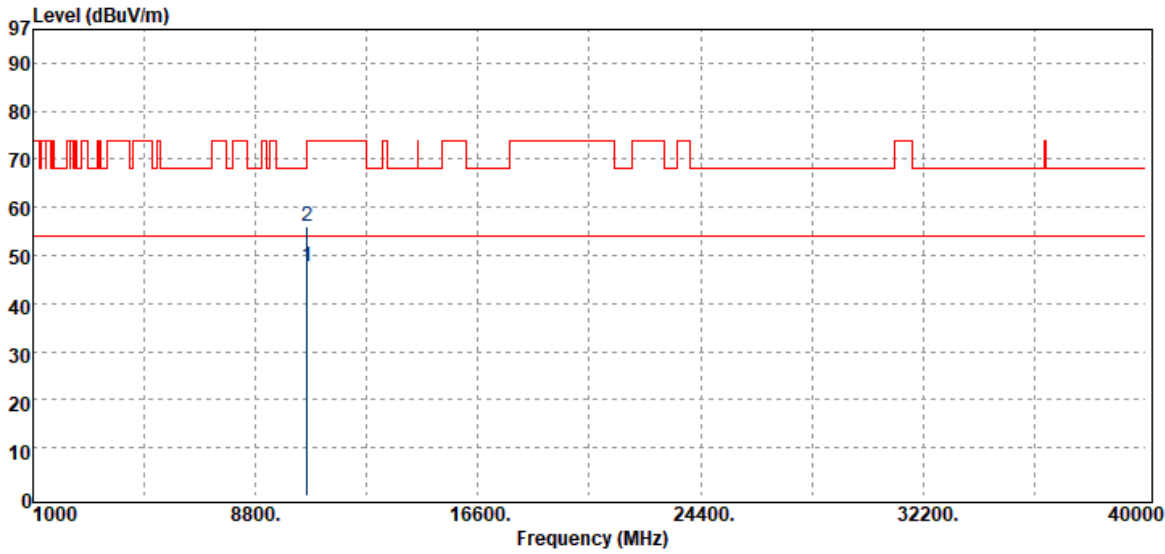

Freq. MHz	Detector Mode PK/QP/AV	Spectrum Reading Level dB μ V	Factor dB	Actual FS dB μ V/m	Limit @3m dB μ V/m	Margin dB
10600.00	Average	26.44	21.27	47.71	54.00	-6.29
10600.00	Peak	34.82	21.27	56.09	74.00	-17.91

Unless otherwise stated the results shown in this test report refer only to the sample(s) tested and such sample(s) are retained for 90 days only.

除非另有說明，此報告結果僅對測試之樣品負責，同時此樣品僅保留90天。本報告未經本公司書面許可，不可部份複製。

This document is issued by the Company subject to its General Conditions of Service printed overleaf, available on request or accessible at <http://www.sgs.com.tw/Terms-and-Conditions> and for electronic format documents, subject to Terms and Conditions for Electronic Documents at <http://www.sgs.com.tw/Terms-and-Conditions>. Attention is drawn to the limitation of liability, indemnification and jurisdiction issues defined therein. Any holder of this document is advised that information contained hereon reflects the Company's findings at the time of its intervention only and within the limits of Client's instructions, if any. The Company's sole responsibility is to its Client and this document does not exonerate parties to a transaction from exercising all their rights and obligations under the transaction documents. This document cannot be reproduced except in full, without prior written approval of the Company. Any unauthorized alteration, forgery or falsification of the content or appearance of this document is unlawful and offenders may be prosecuted to the fullest extent of the law.

Report Number :ER-2020-80015
 Operation Mode :802.11a
 Test Frequency :5320 MHz
 Test Mode :Tx CH High
 EUT Pol :H Plane

Test Site :SAC III Chamber
 Test Date :2020-08-10
 Temp./Humi. :25.8/60
 Antenna Pol. :VERTICAL
 Engineer :Ricky

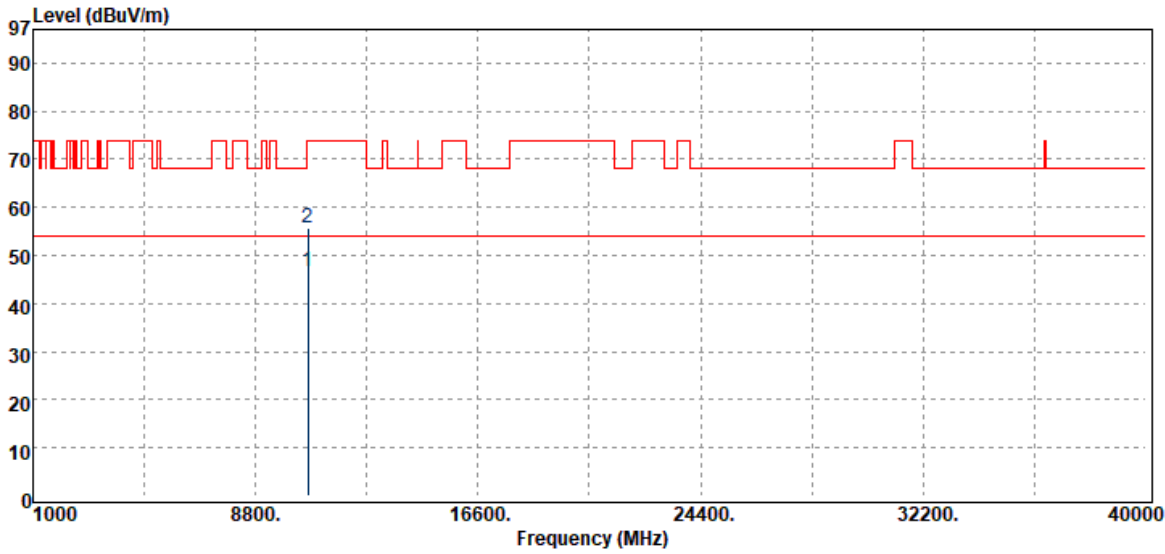

Freq. MHz	Detector Mode PK/QP/AV	Spectrum Reading Level dB μ V	Factor dB	Actual FS dB μ V/m	Limit @3m dB μ V/m	Margin dB
10640.00	Average	25.51	21.21	46.72	54.00	-7.28
10640.00	Peak	34.58	21.21	55.79	74.00	-18.21

Unless otherwise stated the results shown in this test report refer only to the sample(s) tested and such sample(s) are retained for 90 days only.

除非另有說明，此報告結果僅對測試之樣品負責，同時此樣品僅保留90天。本報告未經本公司書面許可，不可部份複製。

This document is issued by the Company subject to its General Conditions of Service printed overleaf, available on request or accessible at <http://www.sgs.com.tw/Terms-and-Conditions> and for electronic format documents, subject to Terms and Conditions for Electronic Documents at <http://www.sgs.com.tw/Terms-and-Conditions>. Attention is drawn to the limitation of liability, indemnification and jurisdiction issues defined therein. Any holder of this document is advised that information contained hereon reflects the Company's findings at the time of its intervention only and within the limits of Client's instructions, if any. The Company's sole responsibility is to its Client and this document does not exonerate parties to a transaction from exercising all their rights and obligations under the transaction documents. This document cannot be reproduced except in full, without prior written approval of the Company. Any unauthorized alteration, forgery or falsification of the content or appearance of this document is unlawful and offenders may be prosecuted to the fullest extent of the law.

Report Number :ER-2020-80015
 Operation Mode :802.11a
 Test Frequency :5320 MHz
 Test Mode :Tx CH High
 EUT Pol :H Plane

Test Site :SAC III Chamber
 Test Date :2020-08-10
 Temp./Humi. :25.8/60
 Antenna Pol. :HORIZONTAL
 Engineer :Ricky

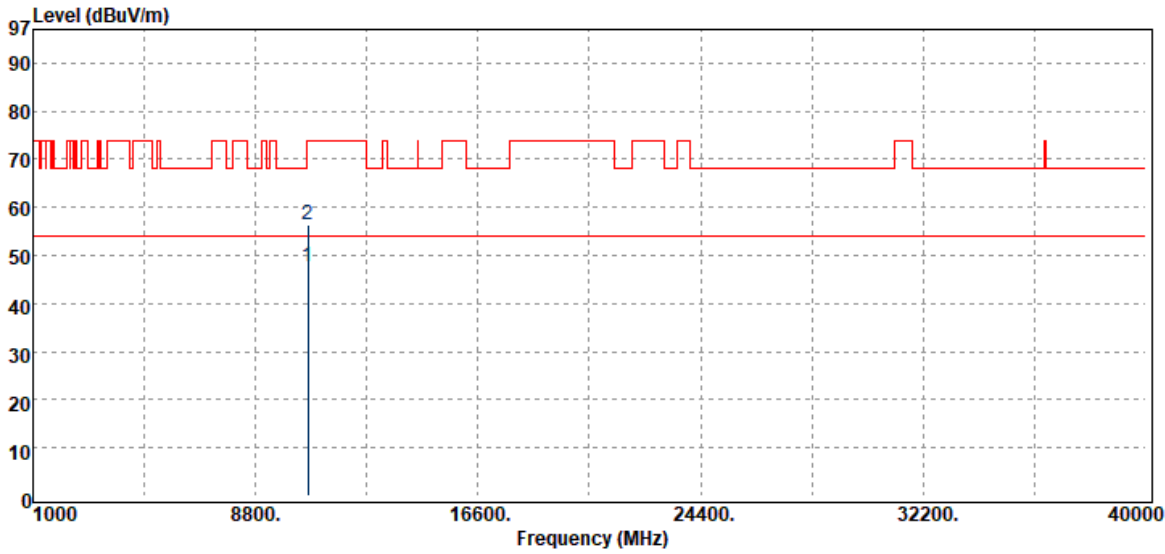

Freq. MHz	Detector Mode PK/QP/AV	Spectrum Reading Level dB μ V	Factor dB	Actual FS dB μ V/m	Limit @3m dB μ V/m	Margin dB
10640.00	Average	26.32	21.21	47.53	54.00	-6.47
10640.00	Peak	35.27	21.21	56.48	74.00	-17.52

Unless otherwise stated the results shown in this test report refer only to the sample(s) tested and such sample(s) are retained for 90 days only.

除非另有說明，此報告結果僅對測試之樣品負責，同時此樣品僅保留90天。本報告未經本公司書面許可，不可部份複製。

This document is issued by the Company subject to its General Conditions of Service printed overleaf, available on request or accessible at <http://www.sgs.com.tw/Terms-and-Conditions> and for electronic format documents, subject to Terms and Conditions for Electronic Documents at <http://www.sgs.com.tw/Terms-and-Conditions>. Attention is drawn to the limitation of liability, indemnification and jurisdiction issues defined therein. Any holder of this document is advised that information contained hereon reflects the Company's findings at the time of its intervention only and within the limits of Client's instructions, if any. The Company's sole responsibility is to its Client and this document does not exonerate parties to a transaction from exercising all their rights and obligations under the transaction documents. This document cannot be reproduced except in full, without prior written approval of the Company. Any unauthorized alteration, forgery or falsification of the content or appearance of this document is unlawful and offenders may be prosecuted to the fullest extent of the law.

Report Number :ER-2020-80015
 Operation Mode :802.11a
 Test Frequency :5500 MHz
 Test Mode :Tx CH Low
 EUT Pol :H Plane

Test Site :SAC III Chamber
 Test Date :2020-08-10
 Temp./Humi. :25.8/60
 Antenna Pol. :VERTICAL
 Engineer :Ricky

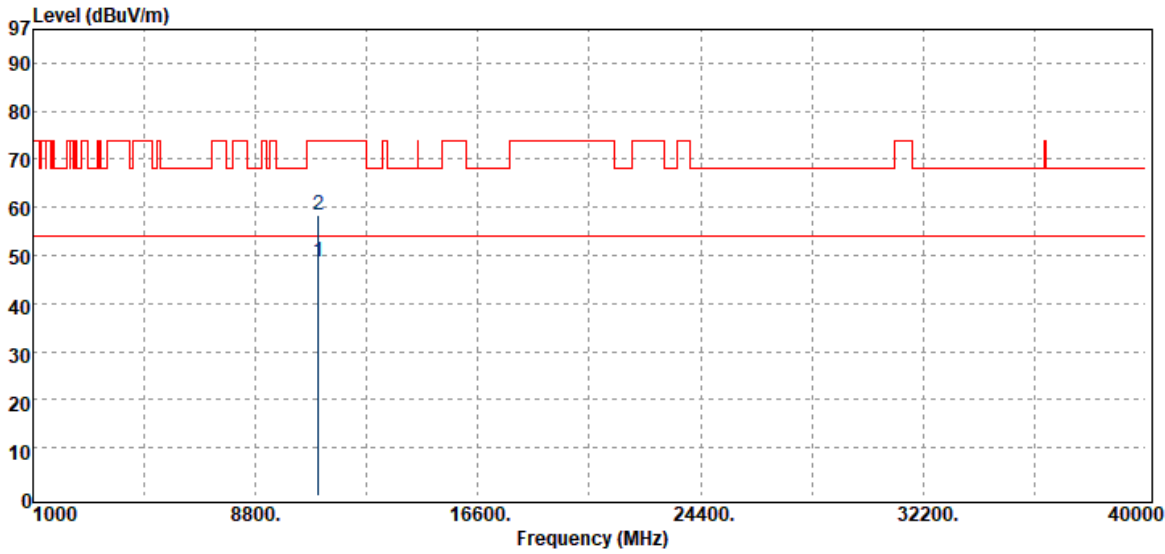

Freq. MHz	Detector Mode PK/QP/AV	Spectrum Reading Level dB μ V	Factor dB	Actual FS dB μ V/m	Limit @3m dB μ V/m	Margin dB
11000.00	Average	25.32	23.37	48.69	54.00	-5.31
11000.00	Peak	35.17	23.37	58.54	74.00	-15.46

Unless otherwise stated the results shown in this test report refer only to the sample(s) tested and such sample(s) are retained for 90 days only.

除非另有說明，此報告結果僅對測試之樣品負責，同時此樣品僅保留90天。本報告未經本公司書面許可，不可部份複製。

This document is issued by the Company subject to its General Conditions of Service printed overleaf, available on request or accessible at <http://www.sgs.com.tw/Terms-and-Conditions> and for electronic format documents, subject to Terms and Conditions for Electronic Documents at <http://www.sgs.com.tw/Terms-and-Conditions>. Attention is drawn to the limitation of liability, indemnification and jurisdiction issues defined therein. Any holder of this document is advised that information contained hereon reflects the Company's findings at the time of its intervention only and within the limits of Client's instructions, if any. The Company's sole responsibility is to its Client and this document does not exonerate parties to a transaction from exercising all their rights and obligations under the transaction documents. This document cannot be reproduced except in full, without prior written approval of the Company. Any unauthorized alteration, forgery or falsification of the content or appearance of this document is unlawful and offenders may be prosecuted to the fullest extent of the law.

Report Number :ER-2020-80015
 Operation Mode :802.11a
 Test Frequency :5500 MHz
 Test Mode :Tx CH Low
 EUT Pol :H Plane

Test Site :SAC III Chamber
 Test Date :2020-08-10
 Temp./Humi. :25.8/60
 Antenna Pol. :HORIZONTAL
 Engineer :Ricky

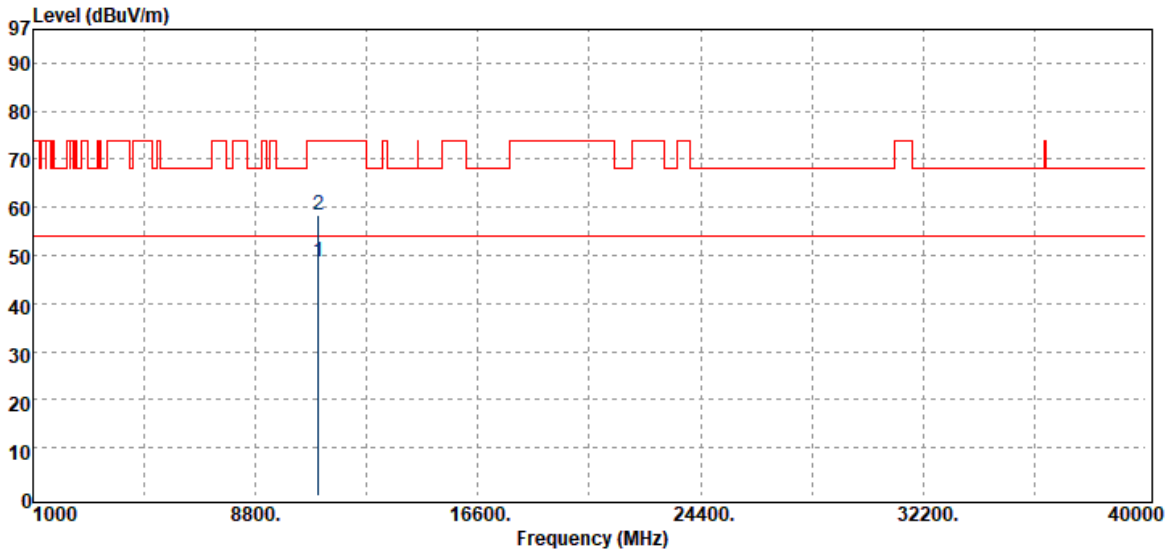

Freq. MHz	Detector Mode PK/QP/AV	Spectrum Reading Level dB μ V	Factor dB	Actual FS dB μ V/m	Limit @3m dB μ V/m	Margin dB
11000.00	Average	25.31	23.37	48.68	54.00	-5.32
11000.00	Peak	35.06	23.37	58.43	74.00	-15.57

Unless otherwise stated the results shown in this test report refer only to the sample(s) tested and such sample(s) are retained for 90 days only.

除非另有說明，此報告結果僅對測試之樣品負責，同時此樣品僅保留90天。本報告未經本公司書面許可，不可部份複製。

This document is issued by the Company subject to its General Conditions of Service printed overleaf, available on request or accessible at <http://www.sgs.com.tw/Terms-and-Conditions> and for electronic format documents, subject to Terms and Conditions for Electronic Documents at <http://www.sgs.com.tw/Terms-and-Conditions>. Attention is drawn to the limitation of liability, indemnification and jurisdiction issues defined therein. Any holder of this document is advised that information contained hereon reflects the Company's findings at the time of its intervention only and within the limits of Client's instructions, if any. The Company's sole responsibility is to its Client and this document does not exonerate parties to a transaction from exercising all their rights and obligations under the transaction documents. This document cannot be reproduced except in full, without prior written approval of the Company. Any unauthorized alteration, forgery or falsification of the content or appearance of this document is unlawful and offenders may be prosecuted to the fullest extent of the law.

Report Number :ER-2020-80015
 Operation Mode :802.11a
 Test Frequency :5580 MHz
 Test Mode :Tx CH Mid
 EUT Pol :H Plane

Test Site :SAC III Chamber
 Test Date :2020-08-10
 Temp./Humi. :25.8/60
 Antenna Pol. :VERTICAL
 Engineer :Ricky

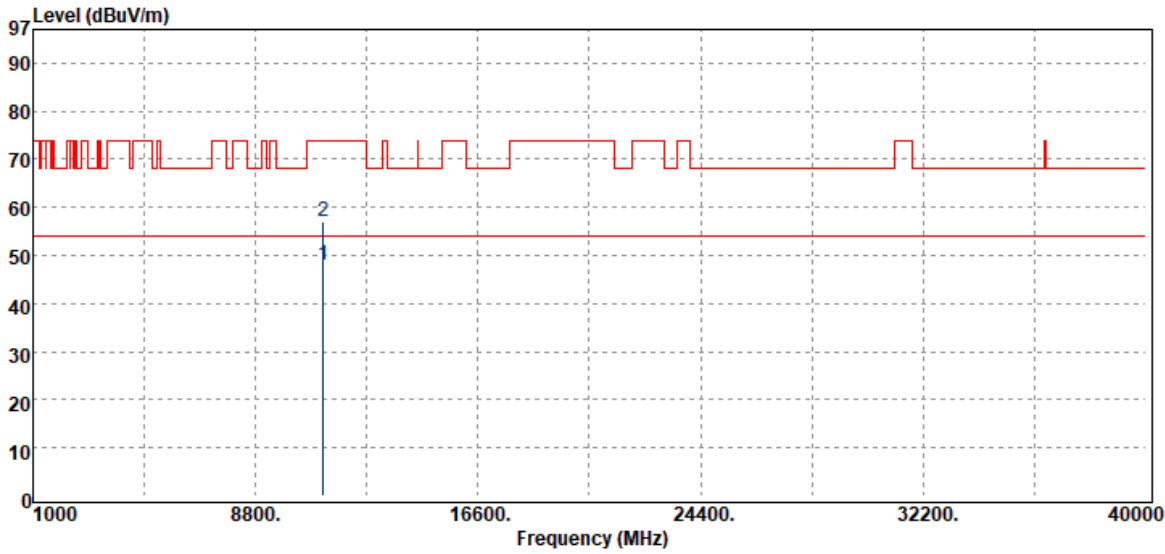

Freq. MHz	Detector Mode PK/QP/AV	Spectrum Reading Level dB μ V	Factor dB	Actual FS dB μ V/m	Limit @3m dB μ V/m	Margin dB
11160.00	Average	25.80	22.20	48.00	54.00	-6.00
11160.00	Peak	34.74	22.20	56.94	74.00	-17.06

Unless otherwise stated the results shown in this test report refer only to the sample(s) tested and such sample(s) are retained for 90 days only.

除非另有說明，此報告結果僅對測試之樣品負責，同時此樣品僅保留90天。本報告未經本公司書面許可，不可部份複製。

This document is issued by the Company subject to its General Conditions of Service printed overleaf, available on request or accessible at <http://www.sgs.com.tw/Terms-and-Conditions> and for electronic format documents, subject to Terms and Conditions for Electronic Documents at <http://www.sgs.com.tw/Terms-and-Conditions>. Attention is drawn to the limitation of liability, indemnification and jurisdiction issues defined therein. Any holder of this document is advised that information contained hereon reflects the Company's findings at the time of its intervention only and within the limits of Client's instructions, if any. The Company's sole responsibility is to its Client and this document does not exonerate parties to a transaction from exercising all their rights and obligations under the transaction documents. This document cannot be reproduced except in full, without prior written approval of the Company. Any unauthorized alteration, forgery or falsification of the content or appearance of this document is unlawful and offenders may be prosecuted to the fullest extent of the law.

Report Number :ER-2020-80015
Operation Mode :802.11a
Test Frequency :5580 MHz
Test Mode :Tx CH Mid
EUT Pol :H Plane

Test Site :SAC III Chamber
Test Date :2020-08-10
Temp./Humi. :25.8/60
Antenna Pol. :HORIZONTAL
Engineer :Ricky

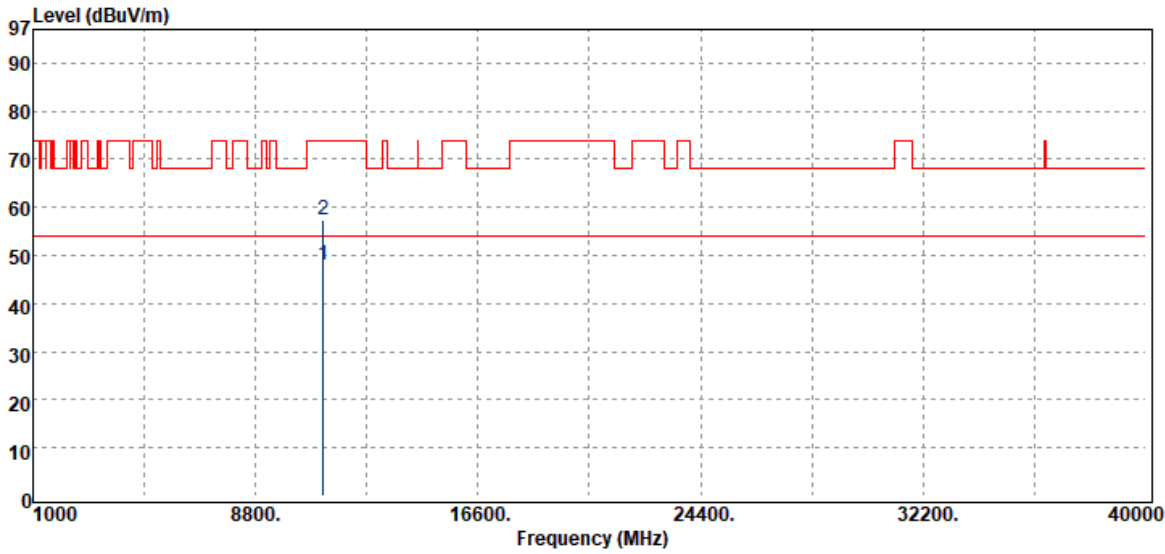

Freq. MHz	Detector Mode PK/QP/AV	Spectrum Reading Level dB μ V	Factor dB	Actual FS dB μ V/m	Limit @3m dB μ V/m	Margin dB
11160.00	Average	25.76	22.20	47.96	54.00	-6.04
11160.00	Peak	35.21	22.20	57.41	74.00	-16.59

Unless otherwise stated the results shown in this test report refer only to the sample(s) tested and such sample(s) are retained for 90 days only.

除非另有說明，此報告結果僅對測試之樣品負責，同時此樣品僅保留90天。本報告未經本公司書面許可，不可部份複製。

This document is issued by the Company subject to its General Conditions of Service printed overleaf, available on request or accessible at <http://www.sgs.com.tw/Terms-and-Conditions> and for electronic format documents, subject to Terms and Conditions for Electronic Documents at <http://www.sgs.com.tw/Terms-and-Conditions>. Attention is drawn to the limitation of liability, indemnification and jurisdiction issues defined therein. Any holder of this document is advised that information contained hereon reflects the Company's findings at the time of its intervention only and within the limits of Client's instructions, if any. The Company's sole responsibility is to its Client and this document does not exonerate parties to a transaction from exercising all their rights and obligations under the transaction documents. This document cannot be reproduced except in full, without prior written approval of the Company. Any unauthorized alteration, forgery or falsification of the content or appearance of this document is unlawful and offenders may be prosecuted to the fullest extent of the law.

Report Number :ER-2020-80015
 Operation Mode :802.11a
 Test Frequency :5700 MHz
 Test Mode :Tx CH High
 EUT Pol :H Plane

Test Site :SAC III Chamber
 Test Date :2020-08-10
 Temp./Humi. :25.8/60
 Antenna Pol. :VERTICAL
 Engineer :Ricky

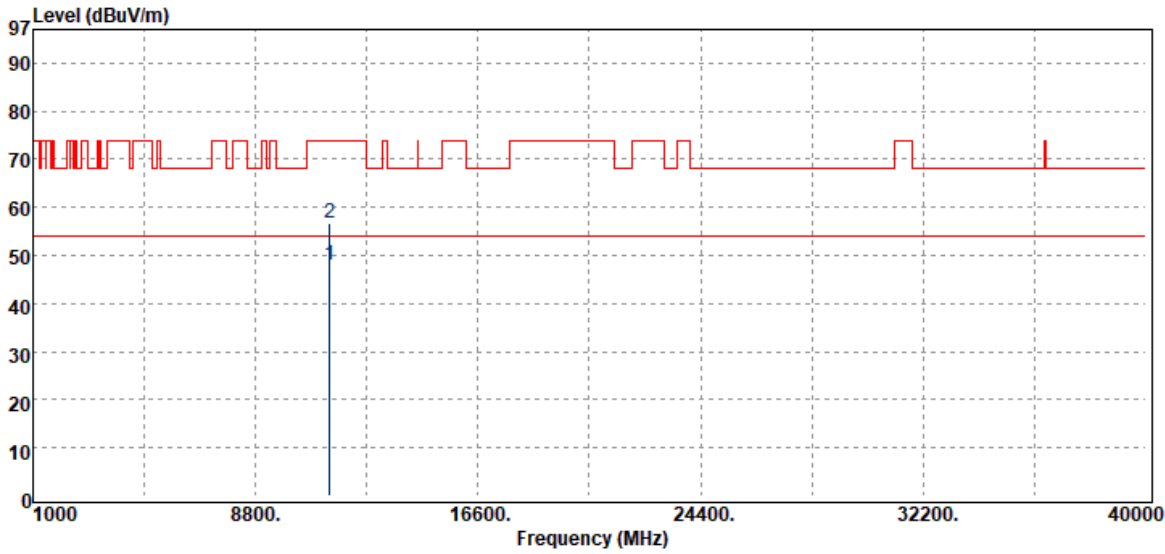

Freq. MHz	Detector Mode PK/QP/AV	Spectrum Reading Level dB μ V	Factor dB	Actual FS dB μ V/m	Limit @3m dB μ V/m	Margin dB
11400.00	Average	25.63	22.22	47.85	54.00	-6.15
11400.00	Peak	34.56	22.22	56.78	74.00	-17.22

Unless otherwise stated the results shown in this test report refer only to the sample(s) tested and such sample(s) are retained for 90 days only.

除非另有說明，此報告結果僅對測試之樣品負責，同時此樣品僅保留90天。本報告未經本公司書面許可，不可部份複製。

This document is issued by the Company subject to its General Conditions of Service printed overleaf, available on request or accessible at <http://www.sgs.com.tw/Terms-and-Conditions> and for electronic format documents, subject to Terms and Conditions for Electronic Documents at <http://www.sgs.com.tw/Terms-and-Conditions>. Attention is drawn to the limitation of liability, indemnification and jurisdiction issues defined therein. Any holder of this document is advised that information contained hereon reflects the Company's findings at the time of its intervention only and within the limits of Client's instructions, if any. The Company's sole responsibility is to its Client and this document does not exonerate parties to a transaction from exercising all their rights and obligations under the transaction documents. This document cannot be reproduced except in full, without prior written approval of the Company. Any unauthorized alteration, forgery or falsification of the content or appearance of this document is unlawful and offenders may be prosecuted to the fullest extent of the law.

Report Number :ER-2020-80015
 Operation Mode :802.11a
 Test Frequency :5700 MHz
 Test Mode :Tx CH High
 EUT Pol :H Plane

Test Site :SAC III Chamber
 Test Date :2020-08-10
 Temp./Humi. :25.8/60
 Antenna Pol. :HORIZONTAL
 Engineer :Ricky

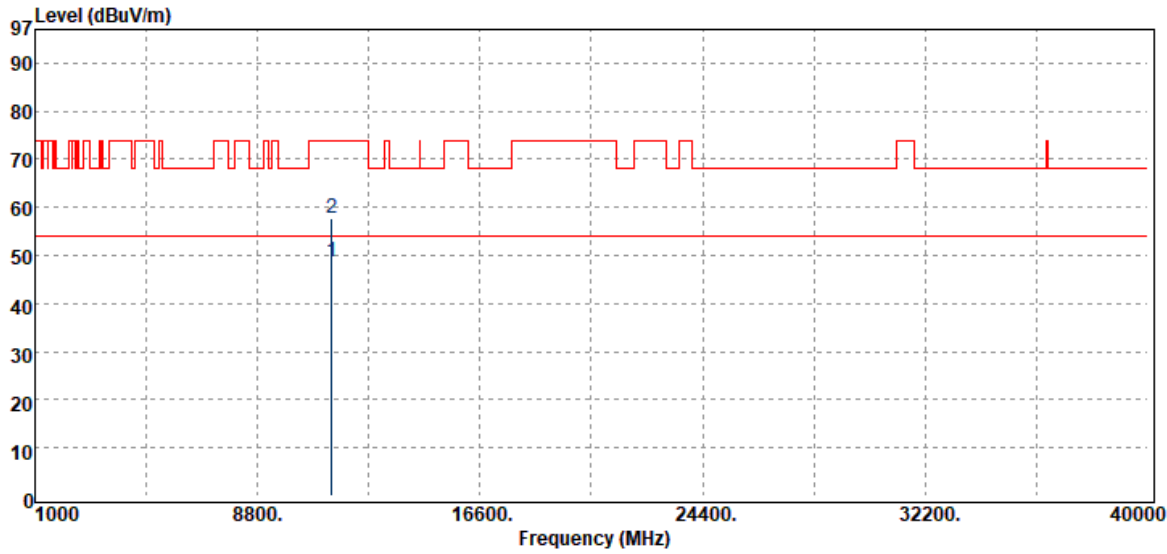

Freq. MHz	Detector Mode PK/QP/AV	Spectrum Reading Level dB μ V	Factor dB	Actual FS dB μ V/m	Limit @3m dB μ V/m	Margin dB
11400.00	Average	26.41	22.22	48.63	54.00	-5.37
11400.00	Peak	35.36	22.22	57.58	74.00	-16.42

Unless otherwise stated the results shown in this test report refer only to the sample(s) tested and such sample(s) are retained for 90 days only.

除非另有說明，此報告結果僅對測試之樣品負責，同時此樣品僅保留90天。本報告未經本公司書面許可，不可部份複製。

This document is issued by the Company subject to its General Conditions of Service printed overleaf, available on request or accessible at <http://www.sgs.com.tw/Terms-and-Conditions> and for electronic format documents, subject to Terms and Conditions for Electronic Documents at <http://www.sgs.com.tw/Terms-and-Conditions>. Attention is drawn to the limitation of liability, indemnification and jurisdiction issues defined therein. Any holder of this document is advised that information contained hereon reflects the Company's findings at the time of its intervention only and within the limits of Client's instructions, if any. The Company's sole responsibility is to its Client and this document does not exonerate parties to a transaction from exercising all their rights and obligations under the transaction documents. This document cannot be reproduced except in full, without prior written approval of the Company. Any unauthorized alteration, forgery or falsification of the content or appearance of this document is unlawful and offenders may be prosecuted to the fullest extent of the law.

Report Number :ER-2020-80015
 Operation Mode :802.11a
 Test Frequency :5745 MHz
 Test Mode :Tx CH Low
 EUT Pol :H Plane

Test Site :SAC III Chamber
 Test Date :2020-08-10
 Temp./Humi. :25.8/60
 Antenna Pol. :VERTICAL
 Engineer :Ricky

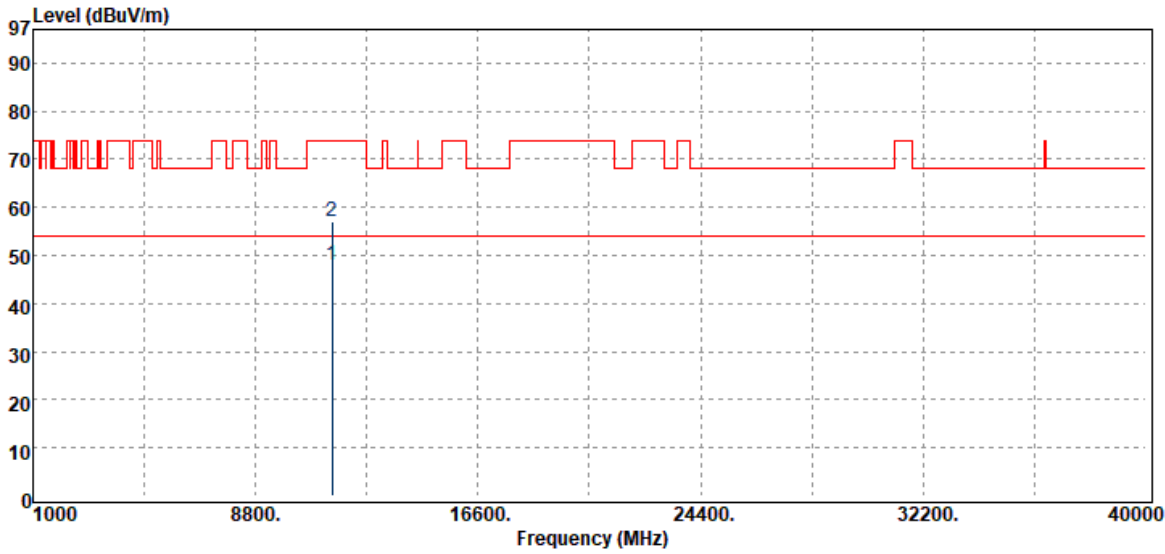

Freq. MHz	Detector Mode PK/QP/AV	Spectrum Reading Level dB μ V	Factor dB	Actual FS dB μ V/m	Limit @3m dB μ V/m	Margin dB
11490.00	Average	24.92	23.24	48.16	54.00	-5.84
11490.00	Peak	33.79	23.24	57.03	74.00	-16.97

Unless otherwise stated the results shown in this test report refer only to the sample(s) tested and such sample(s) are retained for 90 days only.

除非另有說明，此報告結果僅對測試之樣品負責，同時此樣品僅保留90天。本報告未經本公司書面許可，不可部份複製。

This document is issued by the Company subject to its General Conditions of Service printed overleaf, available on request or accessible at <http://www.sgs.com.tw/Terms-and-Conditions> and for electronic format documents, subject to Terms and Conditions for Electronic Documents at <http://www.sgs.com.tw/Terms-and-Conditions>. Attention is drawn to the limitation of liability, indemnification and jurisdiction issues defined therein. Any holder of this document is advised that information contained hereon reflects the Company's findings at the time of its intervention only and within the limits of Client's instructions, if any. The Company's sole responsibility is to its Client and this document does not exonerate parties to a transaction from exercising all their rights and obligations under the transaction documents. This document cannot be reproduced except in full, without prior written approval of the Company. Any unauthorized alteration, forgery or falsification of the content or appearance of this document is unlawful and offenders may be prosecuted to the fullest extent of the law.

Report Number :ER-2020-80015
 Operation Mode :802.11a
 Test Frequency :5745 MHz
 Test Mode :Tx CH Low
 EUT Pol :H Plane

Test Site :SAC III Chamber
 Test Date :2020-08-10
 Temp./Humi. :25.8/60
 Antenna Pol. :HORIZONTAL
 Engineer :Ricky

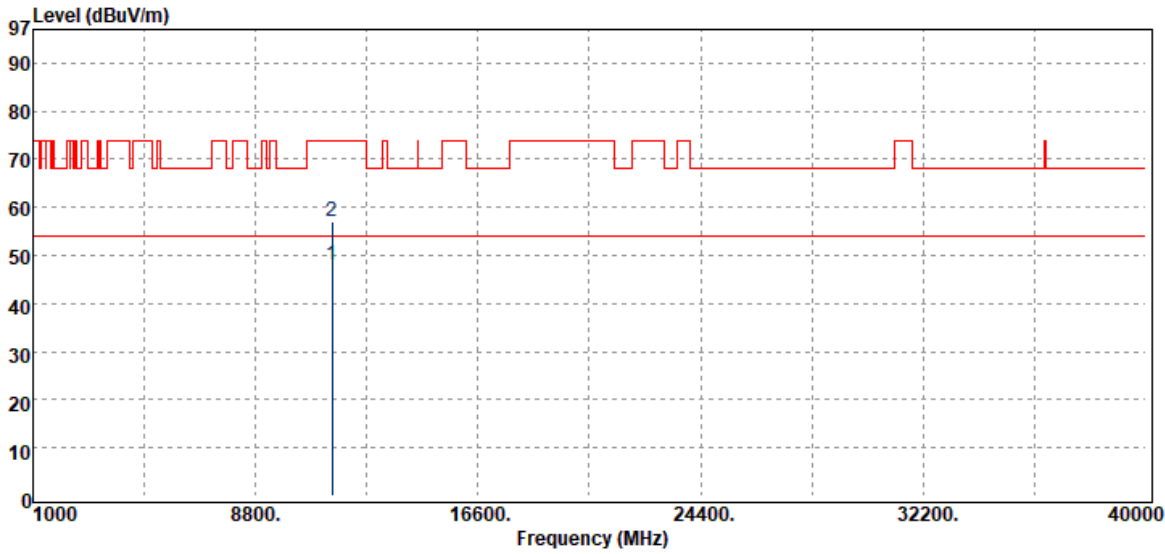

Freq. MHz	Detector Mode PK/QP/AV	Spectrum Reading Level dB μ V	Factor dB	Actual FS dB μ V/m	Limit @3m dB μ V/m	Margin dB
11490.00	Average	24.83	23.24	48.07	54.00	-5.93
11490.00	Peak	33.67	23.24	56.91	74.00	-17.09

Unless otherwise stated the results shown in this test report refer only to the sample(s) tested and such sample(s) are retained for 90 days only.

除非另有說明，此報告結果僅對測試之樣品負責，同時此樣品僅保留90天。本報告未經本公司書面許可，不可部份複製。

This document is issued by the Company subject to its General Conditions of Service printed overleaf, available on request or accessible at <http://www.sgs.com.tw/Terms-and-Conditions> and for electronic format documents, subject to Terms and Conditions for Electronic Documents at <http://www.sgs.com.tw/Terms-and-Conditions>. Attention is drawn to the limitation of liability, indemnification and jurisdiction issues defined therein. Any holder of this document is advised that information contained hereon reflects the Company's findings at the time of its intervention only and within the limits of Client's instructions, if any. The Company's sole responsibility is to its Client and this document does not exonerate parties to a transaction from exercising all their rights and obligations under the transaction documents. This document cannot be reproduced except in full, without prior written approval of the Company. Any unauthorized alteration, forgery or falsification of the content or appearance of this document is unlawful and offenders may be prosecuted to the fullest extent of the law.

Report Number :ER-2020-80015
 Operation Mode :802.11a
 Test Frequency :5785 MHz
 Test Mode :Tx CH Mid
 EUT Pol :H Plane

Test Site :SAC III Chamber
 Test Date :2020-08-10
 Temp./Humi. :25.8/60
 Antenna Pol. :VERTICAL
 Engineer :Ricky

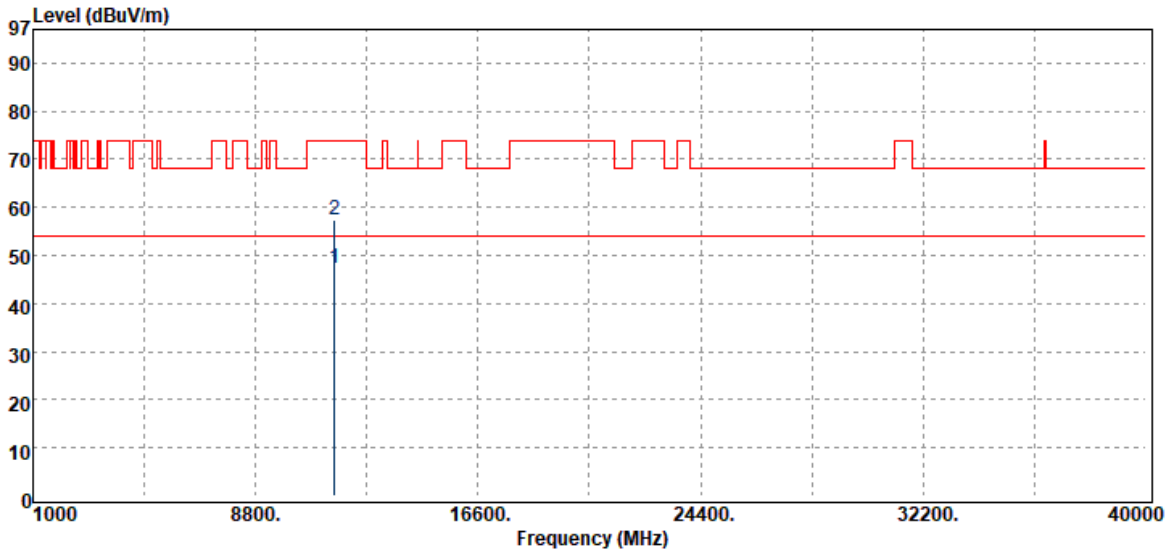

Freq. MHz	Detector Mode PK/QP/AV	Spectrum Reading Level dB μ V	Factor dB	Actual FS dB μ V/m	Limit @3m dB μ V/m	Margin dB
11570.00	Average	25.45	22.01	47.46	54.00	-6.54
11570.00	Peak	35.35	22.01	57.36	74.00	-16.64

Unless otherwise stated the results shown in this test report refer only to the sample(s) tested and such sample(s) are retained for 90 days only.

除非另有說明，此報告結果僅對測試之樣品負責，同時此樣品僅保留90天。本報告未經本公司書面許可，不可部份複製。

This document is issued by the Company subject to its General Conditions of Service printed overleaf, available on request or accessible at <http://www.sgs.com.tw/Terms-and-Conditions> and for electronic format documents, subject to Terms and Conditions for Electronic Documents at <http://www.sgs.com.tw/Terms-and-Conditions>. Attention is drawn to the limitation of liability, indemnification and jurisdiction issues defined therein. Any holder of this document is advised that information contained hereon reflects the Company's findings at the time of its intervention only and within the limits of Client's instructions, if any. The Company's sole responsibility is to its Client and this document does not exonerate parties to a transaction from exercising all their rights and obligations under the transaction documents. This document cannot be reproduced except in full, without prior written approval of the Company. Any unauthorized alteration, forgery or falsification of the content or appearance of this document is unlawful and offenders may be prosecuted to the fullest extent of the law.

Report Number :ER-2020-80015
 Operation Mode :802.11a
 Test Frequency :5785 MHz
 Test Mode :Tx CH Mid
 EUT Pol :H Plane

Test Site :SAC III Chamber
 Test Date :2020-08-10
 Temp./Humi. :25.8/60
 Antenna Pol. :HORIZONTAL
 Engineer :Ricky

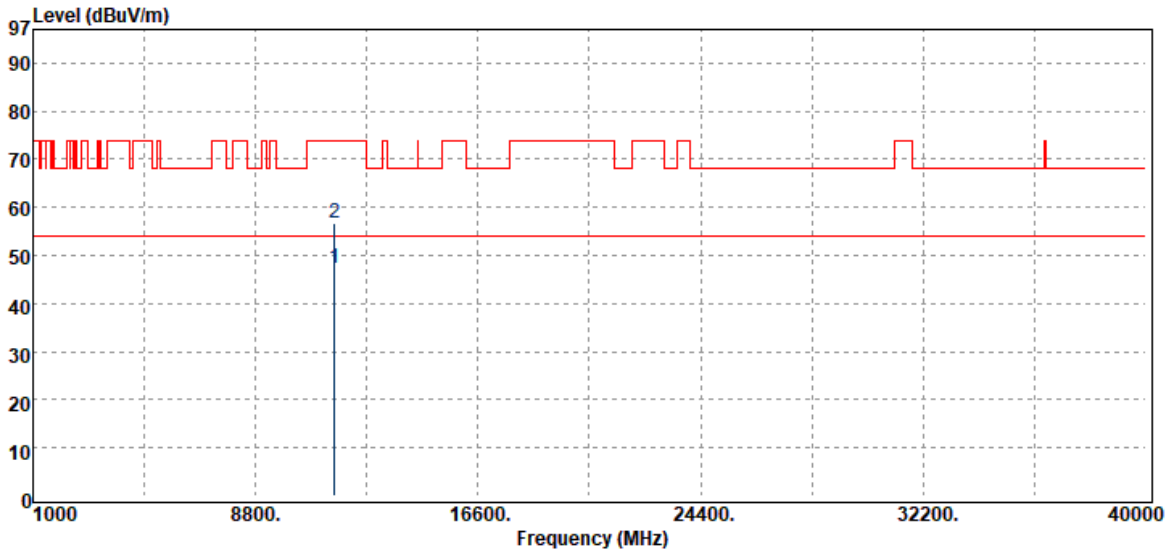

Freq. MHz	Detector Mode PK/QP/AV	Spectrum Reading Level dB μ V	Factor dB	Actual FS dB μ V/m	Limit @3m dB μ V/m	Margin dB
11570.00	Average	25.38	22.01	47.39	54.00	-6.61
11570.00	Peak	34.66	22.01	56.67	74.00	-17.33

Unless otherwise stated the results shown in this test report refer only to the sample(s) tested and such sample(s) are retained for 90 days only.

除非另有說明，此報告結果僅對測試之樣品負責，同時此樣品僅保留90天。本報告未經本公司書面許可，不可部份複製。

This document is issued by the Company subject to its General Conditions of Service printed overleaf, available on request or accessible at <http://www.sgs.com.tw/Terms-and-Conditions> and for electronic format documents, subject to Terms and Conditions for Electronic Documents at <http://www.sgs.com.tw/Terms-and-Conditions>. Attention is drawn to the limitation of liability, indemnification and jurisdiction issues defined therein. Any holder of this document is advised that information contained hereon reflects the Company's findings at the time of its intervention only and within the limits of Client's instructions, if any. The Company's sole responsibility is to its Client and this document does not exonerate parties to a transaction from exercising all their rights and obligations under the transaction documents. This document cannot be reproduced except in full, without prior written approval of the Company. Any unauthorized alteration, forgery or falsification of the content or appearance of this document is unlawful and offenders may be prosecuted to the fullest extent of the law.

Report Number :ER-2020-80015
 Operation Mode :802.11a
 Test Frequency :5825 MHz
 Test Mode :Tx CH High
 EUT Pol :H Plane

Test Site :SAC III Chamber
 Test Date :2020-08-10
 Temp./Humi. :25.8/60
 Antenna Pol. :VERTICAL
 Engineer :Ricky

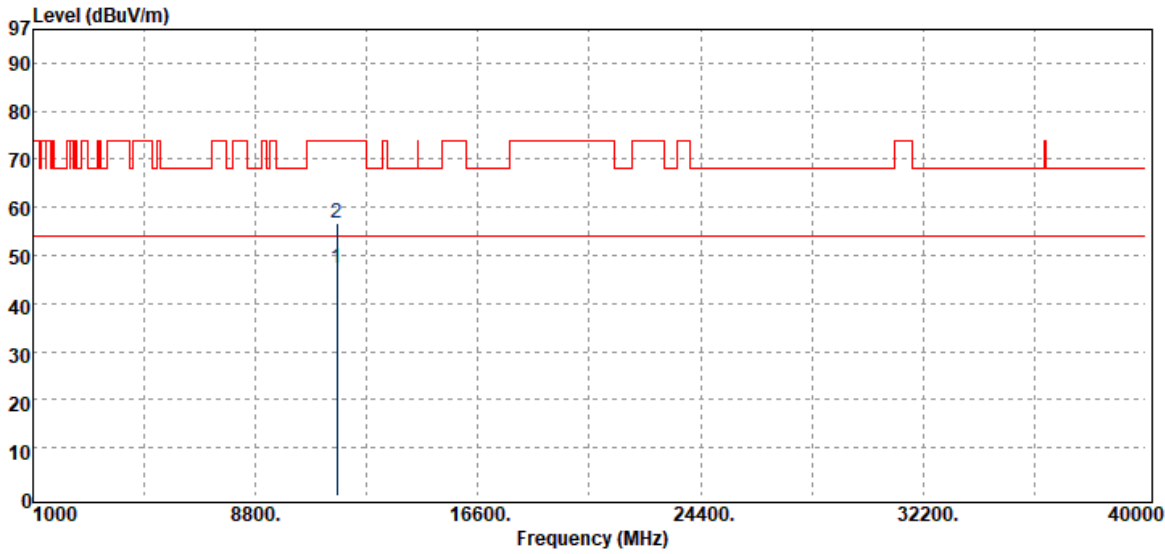

Freq. MHz	Detector Mode PK/QP/AV	Spectrum Reading Level d μ V	Factor dB	Actual FS d μ V/m	Limit @3m d μ V/m	Margin dB
11650.00	Average	24.98	22.45	47.43	54.00	-6.57
11650.00	Peak	34.11	22.45	56.56	74.00	-17.44

Unless otherwise stated the results shown in this test report refer only to the sample(s) tested and such sample(s) are retained for 90 days only.

除非另有說明，此報告結果僅對測試之樣品負責，同時此樣品僅保留90天。本報告未經本公司書面許可，不可部份複製。

This document is issued by the Company subject to its General Conditions of Service printed overleaf, available on request or accessible at <http://www.sgs.com.tw/Terms-and-Conditions> and for electronic format documents, subject to Terms and Conditions for Electronic Documents at <http://www.sgs.com.tw/Terms-and-Conditions>. Attention is drawn to the limitation of liability, indemnification and jurisdiction issues defined therein. Any holder of this document is advised that information contained hereon reflects the Company's findings at the time of its intervention only and within the limits of Client's instructions, if any. The Company's sole responsibility is to its Client and this document does not exonerate parties to a transaction from exercising all their rights and obligations under the transaction documents. This document cannot be reproduced except in full, without prior written approval of the Company. Any unauthorized alteration, forgery or falsification of the content or appearance of this document is unlawful and offenders may be prosecuted to the fullest extent of the law.

Report Number :ER-2020-80015
Operation Mode :802.11a
Test Frequency :5825 MHz
Test Mode :Tx CH High
EUT Pol :H Plane

Test Site :SAC III Chamber
Test Date :2020-08-10
Temp./Humi. :25.8/60
Antenna Pol. :HORIZONTAL
Engineer :Ricky

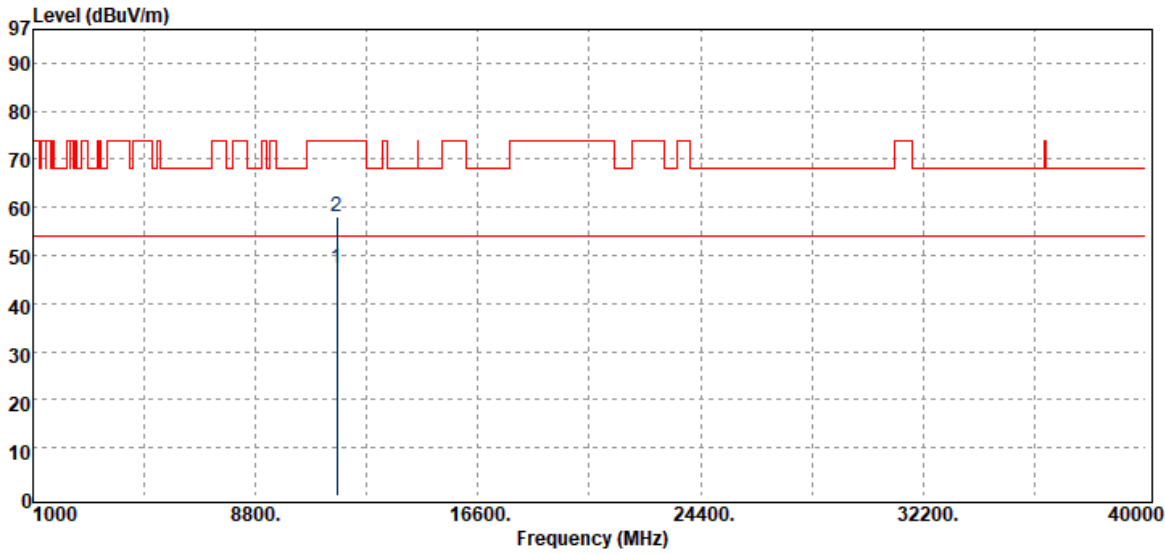

Freq. MHz	Detector Mode PK/QP/AV	Spectrum Reading Level dB μ V	Factor dB	Actual FS dB μ V/m	Limit @3m dB μ V/m	Margin dB
11650.00	Average	24.85	22.45	47.30	54.00	-6.70
11650.00	Peak	35.66	22.45	58.11	74.00	-15.89

Unless otherwise stated the results shown in this test report refer only to the sample(s) tested and such sample(s) are retained for 90 days only.

除非另有說明，此報告結果僅對測試之樣品負責，同時此樣品僅保留90天。本報告未經本公司書面許可，不可部份複製。

This document is issued by the Company subject to its General Conditions of Service printed overleaf, available on request or accessible at <http://www.sgs.com.tw/Terms-and-Conditions> and for electronic format documents, subject to Terms and Conditions for Electronic Documents at <http://www.sgs.com.tw/Terms-and-Conditions>. Attention is drawn to the limitation of liability, indemnification and jurisdiction issues defined therein. Any holder of this document is advised that information contained hereon reflects the Company's findings at the time of its intervention only and within the limits of Client's instructions, if any. The Company's sole responsibility is to its Client and this document does not exonerate parties to a transaction from exercising all their rights and obligations under the transaction documents. This document cannot be reproduced except in full, without prior written approval of the Company. Any unauthorized alteration, forgery or falsification of the content or appearance of this document is unlawful and offenders may be prosecuted to the fullest extent of the law.

Report Number :ER-2020-80015
 Operation Mode :802.11n20
 Test Frequency :5180 MHz
 Test Mode :Tx CH Low
 EUT Pol :H Plane

Test Site :SAC III Chamber
 Test Date :2020-08-10
 Temp./Humi. :25.8/60
 Antenna Pol. :VERTICAL
 Engineer :Ricky

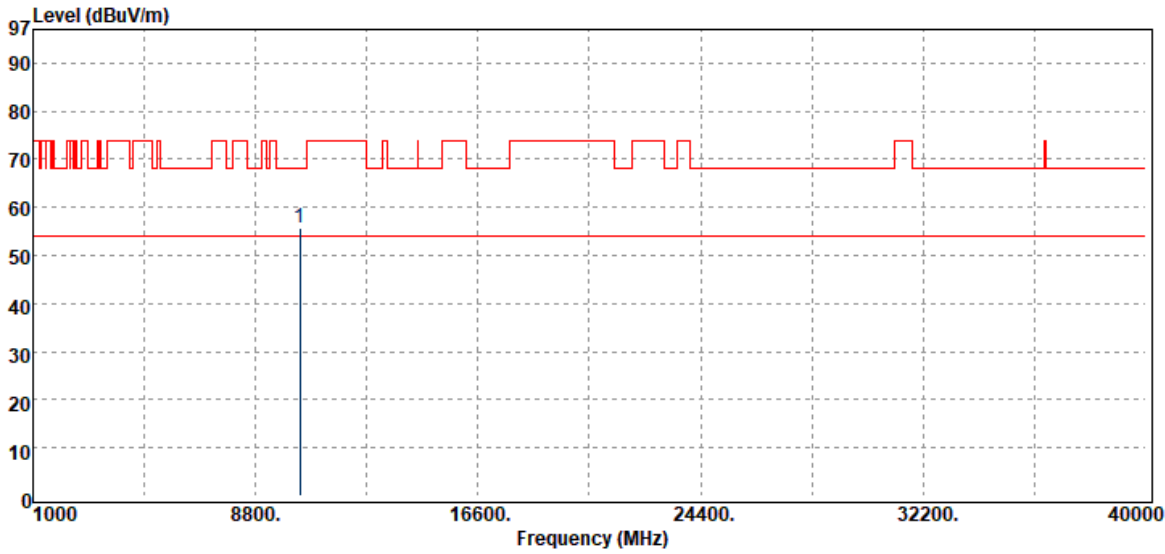

Freq. MHz	Detector Mode PK/QP/AV	Spectrum Reading Level dB μ V	Factor dB	Actual FS dB μ V/m	Limit @3m dB μ V/m	Margin dB
10360.00	Peak	35.05	20.59	55.64	68.20	-12.56

Unless otherwise stated the results shown in this test report refer only to the sample(s) tested and such sample(s) are retained for 90 days only.

除非另有說明，此報告結果僅對測試之樣品負責，同時此樣品僅保留90天。本報告未經本公司書面許可，不可部份複製。

This document is issued by the Company subject to its General Conditions of Service printed overleaf, available on request or accessible at <http://www.sgs.com.tw/Terms-and-Conditions> and for electronic format documents, subject to Terms and Conditions for Electronic Documents at <http://www.sgs.com.tw/Terms-and-Conditions>. Attention is drawn to the limitation of liability, indemnification and jurisdiction issues defined therein. Any holder of this document is advised that information contained hereon reflects the Company's findings at the time of its intervention only and within the limits of Client's instructions, if any. The Company's sole responsibility is to its Client and this document does not exonerate parties to a transaction from exercising all their rights and obligations under the transaction documents. This document cannot be reproduced except in full, without prior written approval of the Company. Any unauthorized alteration, forgery or falsification of the content or appearance of this document is unlawful and offenders may be prosecuted to the fullest extent of the law.

Report Number :ER-2020-80015
Operation Mode :802.11n20
Test Frequency :5180 MHz
Test Mode :Tx CH Low
EUT Pol :H Plane

Test Site :SAC III Chamber
Test Date :2020-08-10
Temp./Humi. :25.8/60
Antenna Pol. :HORIZONTAL
Engineer :Ricky

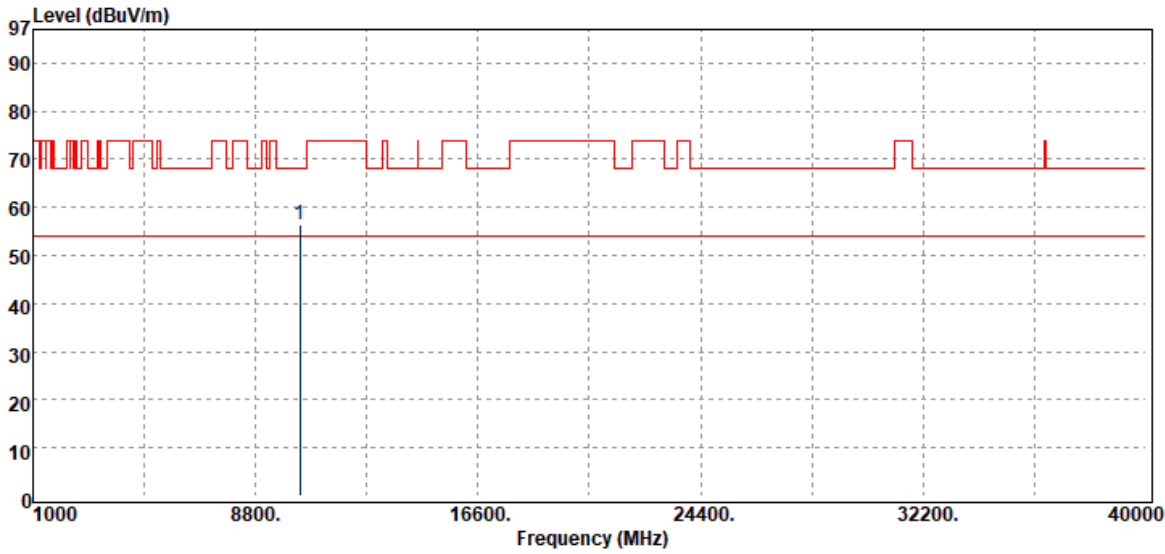

Freq. MHz	Detector Mode PK/QP/AV	Spectrum Reading Level dB μ V	Factor dB	Actual FS dB μ V/m	Limit @3m dB μ V/m	Margin dB
10360.00	Peak	35.74	20.59	56.33	68.20	-11.87

Unless otherwise stated the results shown in this test report refer only to the sample(s) tested and such sample(s) are retained for 90 days only.

除非另有說明，此報告結果僅對測試之樣品負責，同時此樣品僅保留90天。本報告未經本公司書面許可，不可部份複製。

This document is issued by the Company subject to its General Conditions of Service printed overleaf, available on request or accessible at <http://www.sgs.com.tw/Terms-and-Conditions> and for electronic format documents, subject to Terms and Conditions for Electronic Documents at <http://www.sgs.com.tw/Terms-and-Conditions>. Attention is drawn to the limitation of liability, indemnification and jurisdiction issues defined therein. Any holder of this document is advised that information contained hereon reflects the Company's findings at the time of its intervention only and within the limits of Client's instructions, if any. The Company's sole responsibility is to its Client and this document does not exonerate parties to a transaction from exercising all their rights and obligations under the transaction documents. This document cannot be reproduced except in full, without prior written approval of the Company. Any unauthorized alteration, forgery or falsification of the content or appearance of this document is unlawful and offenders may be prosecuted to the fullest extent of the law.

Report Number :ER-2020-80015
Operation Mode :802.11n20
Test Frequency :5220 MHz
Test Mode :Tx CH Mid
EUT Pol :H Plane

Test Site :SAC III Chamber
Test Date :2020-08-10
Temp./Humi. :25.8/60
Antenna Pol. :VERTICAL
Engineer :Ricky

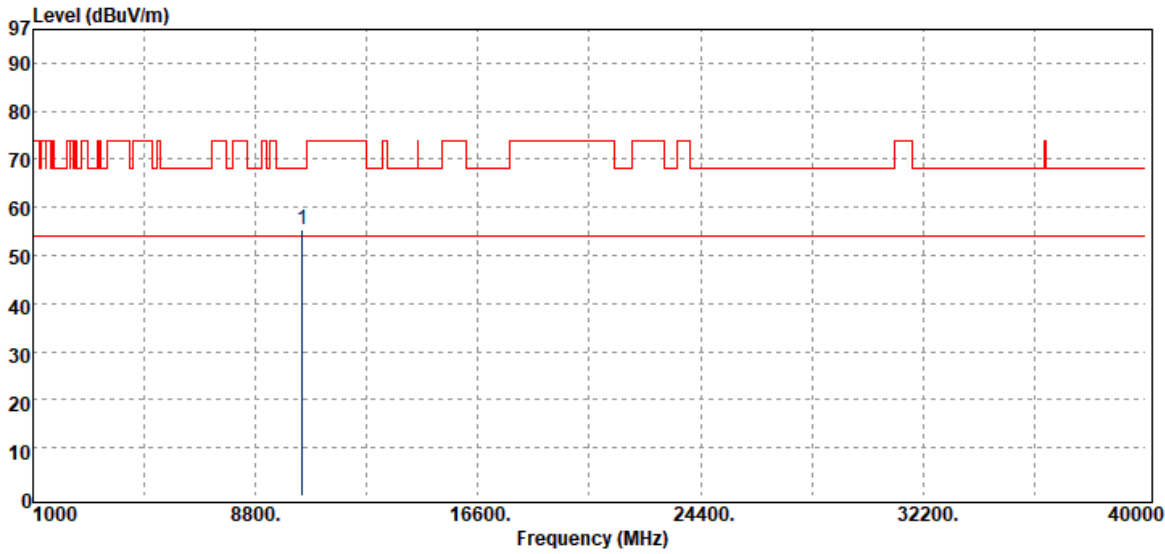

Freq. MHz	Detector Mode PK/QP/AV	Spectrum Reading Level dB μ V	Factor dB	Actual FS dB μ V/m	Limit @3m dB μ V/m	Margin dB
10440.00	Peak	34.45	21.08	55.53	68.20	-12.67

Unless otherwise stated the results shown in this test report refer only to the sample(s) tested and such sample(s) are retained for 90 days only.

除非另有說明，此報告結果僅對測試之樣品負責，同時此樣品僅保留90天。本報告未經本公司書面許可，不可部份複製。

This document is issued by the Company subject to its General Conditions of Service printed overleaf, available on request or accessible at <http://www.sgs.com.tw/Terms-and-Conditions> and for electronic format documents, subject to Terms and Conditions for Electronic Documents at <http://www.sgs.com.tw/Terms-and-Conditions>. Attention is drawn to the limitation of liability, indemnification and jurisdiction issues defined therein. Any holder of this document is advised that information contained hereon reflects the Company's findings at the time of its intervention only and within the limits of Client's instructions, if any. The Company's sole responsibility is to its Client and this document does not exonerate parties to a transaction from exercising all their rights and obligations under the transaction documents. This document cannot be reproduced except in full, without prior written approval of the Company. Any unauthorized alteration, forgery or falsification of the content or appearance of this document is unlawful and offenders may be prosecuted to the fullest extent of the law.

Report Number :ER-2020-80015
Operation Mode :802.11n20
Test Frequency :5220 MHz
Test Mode :Tx CH Mid
EUT Pol :H Plane

Test Site :SAC III Chamber
Test Date :2020-08-10
Temp./Humi. :25.8/60
Antenna Pol. :HORIZONTAL
Engineer :Ricky

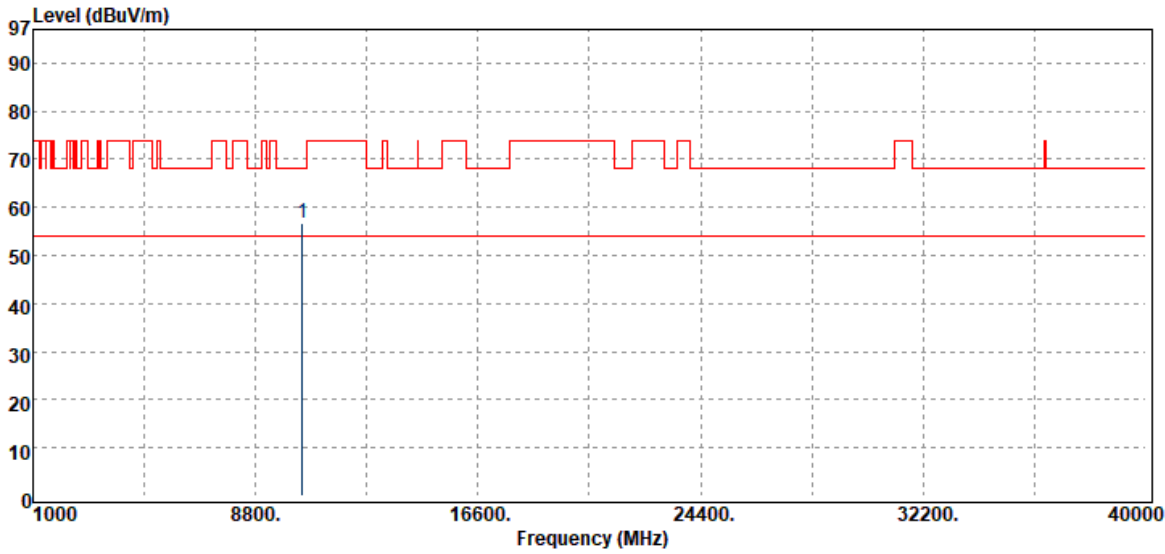

Freq. MHz	Detector Mode PK/QP/AV	Spectrum Reading Level dB μ V	Factor dB	Actual FS dB μ V/m	Limit @3m dB μ V/m	Margin dB
10440.00	Peak	35.53	21.08	56.61	68.20	-11.59

Unless otherwise stated the results shown in this test report refer only to the sample(s) tested and such sample(s) are retained for 90 days only.

除非另有說明，此報告結果僅對測試之樣品負責，同時此樣品僅保留90天。本報告未經本公司書面許可，不可部份複製。

This document is issued by the Company subject to its General Conditions of Service printed overleaf, available on request or accessible at <http://www.sgs.com.tw/Terms-and-Conditions> and for electronic format documents, subject to Terms and Conditions for Electronic Documents at <http://www.sgs.com.tw/Terms-and-Conditions>. Attention is drawn to the limitation of liability, indemnification and jurisdiction issues defined therein. Any holder of this document is advised that information contained hereon reflects the Company's findings at the time of its intervention only and within the limits of Client's instructions, if any. The Company's sole responsibility is to its Client and this document does not exonerate parties to a transaction from exercising all their rights and obligations under the transaction documents. This document cannot be reproduced except in full, without prior written approval of the Company. Any unauthorized alteration, forgery or falsification of the content or appearance of this document is unlawful and offenders may be prosecuted to the fullest extent of the law.

Report Number :ER-2020-80015
 Operation Mode :802.11n20
 Test Frequency :5240 MHz
 Test Mode :Tx CH High
 EUT Pol :H Plane

Test Site :SAC III Chamber
 Test Date :2020-08-10
 Temp./Humi. :25.8/60
 Antenna Pol. :VERTICAL
 Engineer :Ricky

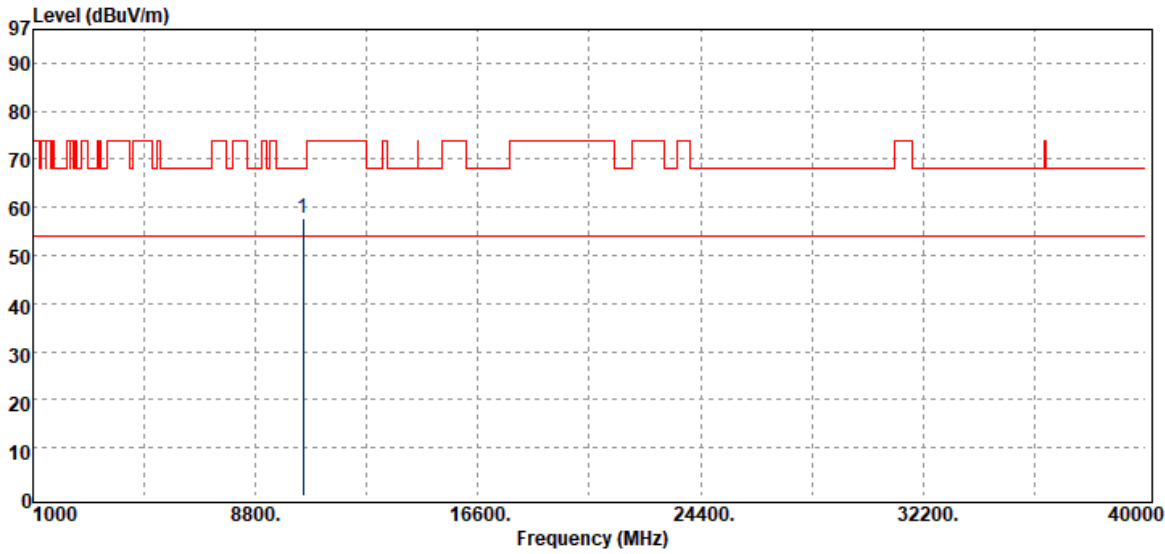

Freq. MHz	Detector Mode PK/QP/AV	Spectrum Reading Level dB μ V	Factor dB	Actual FS dB μ V/m	Limit @3m dB μ V/m	Margin dB
10480.00	Peak	36.58	21.21	57.79	68.20	-10.41

Unless otherwise stated the results shown in this test report refer only to the sample(s) tested and such sample(s) are retained for 90 days only.

除非另有說明，此報告結果僅對測試之樣品負責，同時此樣品僅保留90天。本報告未經本公司書面許可，不可部份複製。

This document is issued by the Company subject to its General Conditions of Service printed overleaf, available on request or accessible at <http://www.sgs.com.tw/Terms-and-Conditions> and for electronic format documents, subject to Terms and Conditions for Electronic Documents at <http://www.sgs.com.tw/Terms-and-Conditions>. Attention is drawn to the limitation of liability, indemnification and jurisdiction issues defined therein. Any holder of this document is advised that information contained hereon reflects the Company's findings at the time of its intervention only and within the limits of Client's instructions, if any. The Company's sole responsibility is to its Client and this document does not exonerate parties to a transaction from exercising all their rights and obligations under the transaction documents. This document cannot be reproduced except in full, without prior written approval of the Company. Any unauthorized alteration, forgery or falsification of the content or appearance of this document is unlawful and offenders may be prosecuted to the fullest extent of the law.

Report Number :ER-2020-80015
Operation Mode :802.11n20
Test Frequency :5240 MHz
Test Mode :Tx CH High
EUT Pol :H Plane

Test Site :SAC III Chamber
Test Date :2020-08-10
Temp./Humi. :25.8/60
Antenna Pol. :HORIZONTAL
Engineer :Ricky

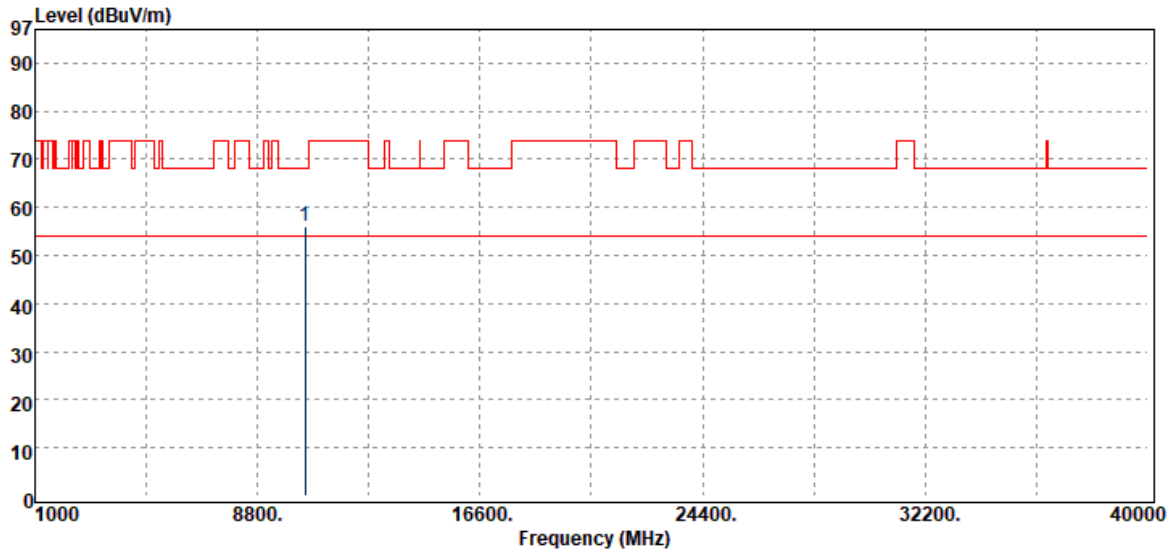

Freq. MHz	Detector Mode PK/QP/AV	Spectrum Reading Level dB μ V	Factor dB	Actual FS dB μ V/m	Limit @3m dB μ V/m	Margin dB
10480.00	Peak	34.92	21.21	56.13	68.20	-12.07

Unless otherwise stated the results shown in this test report refer only to the sample(s) tested and such sample(s) are retained for 90 days only.

除非另有說明，此報告結果僅對測試之樣品負責，同時此樣品僅保留90天。本報告未經本公司書面許可，不可部份複製。

This document is issued by the Company subject to its General Conditions of Service printed overleaf, available on request or accessible at <http://www.sgs.com.tw/Terms-and-Conditions> and for electronic format documents, subject to Terms and Conditions for Electronic Documents at <http://www.sgs.com.tw/Terms-and-Conditions>. Attention is drawn to the limitation of liability, indemnification and jurisdiction issues defined therein. Any holder of this document is advised that information contained hereon reflects the Company's findings at the time of its intervention only and within the limits of Client's instructions, if any. The Company's sole responsibility is to its Client and this document does not exonerate parties to a transaction from exercising all their rights and obligations under the transaction documents. This document cannot be reproduced except in full, without prior written approval of the Company. Any unauthorized alteration, forgery or falsification of the content or appearance of this document is unlawful and offenders may be prosecuted to the fullest extent of the law.

Report Number :ER-2020-80015
 Operation Mode :802.11n20
 Test Frequency :5260 MHz
 Test Mode :Tx CH Low
 EUT Pol :H Plane

Test Site :SAC III Chamber
 Test Date :2020-08-10
 Temp./Humi. :25.8/60
 Antenna Pol. :VERTICAL
 Engineer :Ricky

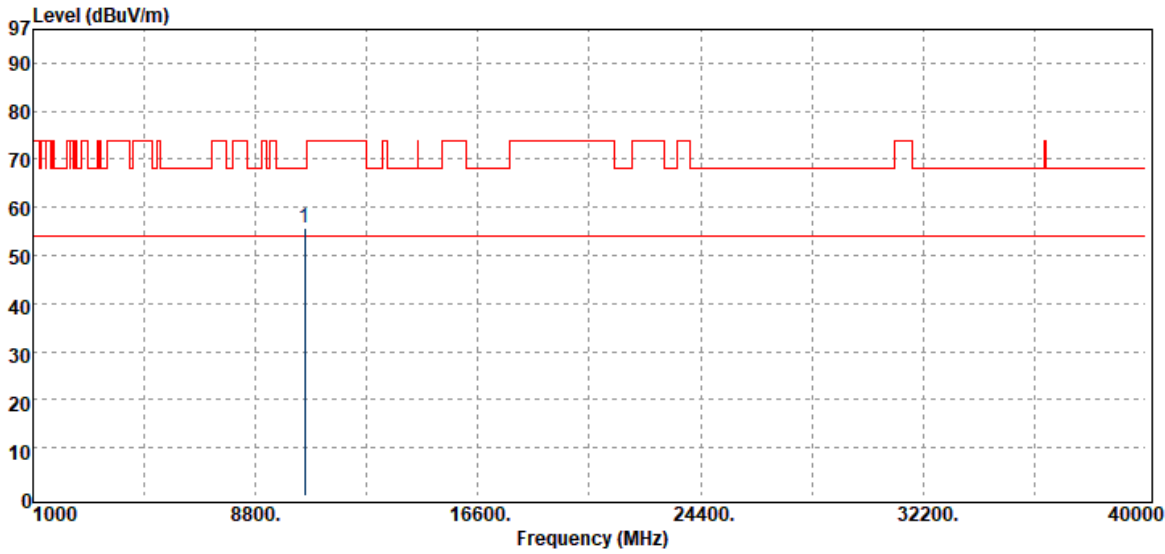

Freq. MHz	Detector Mode PK/QP/AV	Spectrum Reading Level dB μ V	Factor dB	Actual FS dB μ V/m	Limit @3m dB μ V/m	Margin dB
10520.00	Peak	34.58	21.27	55.85	68.20	-12.35

Unless otherwise stated the results shown in this test report refer only to the sample(s) tested and such sample(s) are retained for 90 days only.

除非另有說明，此報告結果僅對測試之樣品負責，同時此樣品僅保留90天。本報告未經本公司書面許可，不可部份複製。

This document is issued by the Company subject to its General Conditions of Service printed overleaf, available on request or accessible at <http://www.sgs.com.tw/Terms-and-Conditions> and for electronic format documents, subject to Terms and Conditions for Electronic Documents at <http://www.sgs.com.tw/Terms-and-Conditions>. Attention is drawn to the limitation of liability, indemnification and jurisdiction issues defined therein. Any holder of this document is advised that information contained hereon reflects the Company's findings at the time of its intervention only and within the limits of Client's instructions, if any. The Company's sole responsibility is to its Client and this document does not exonerate parties to a transaction from exercising all their rights and obligations under the transaction documents. This document cannot be reproduced except in full, without prior written approval of the Company. Any unauthorized alteration, forgery or falsification of the content or appearance of this document is unlawful and offenders may be prosecuted to the fullest extent of the law.

Report Number :ER-2020-80015
 Operation Mode :802.11n20
 Test Frequency :5260 MHz
 Test Mode :Tx CH Low
 EUT Pol :H Plane

Test Site :SAC III Chamber
 Test Date :2020-08-10
 Temp./Humi. :25.8/60
 Antenna Pol. :HORIZONTAL
 Engineer :Ricky

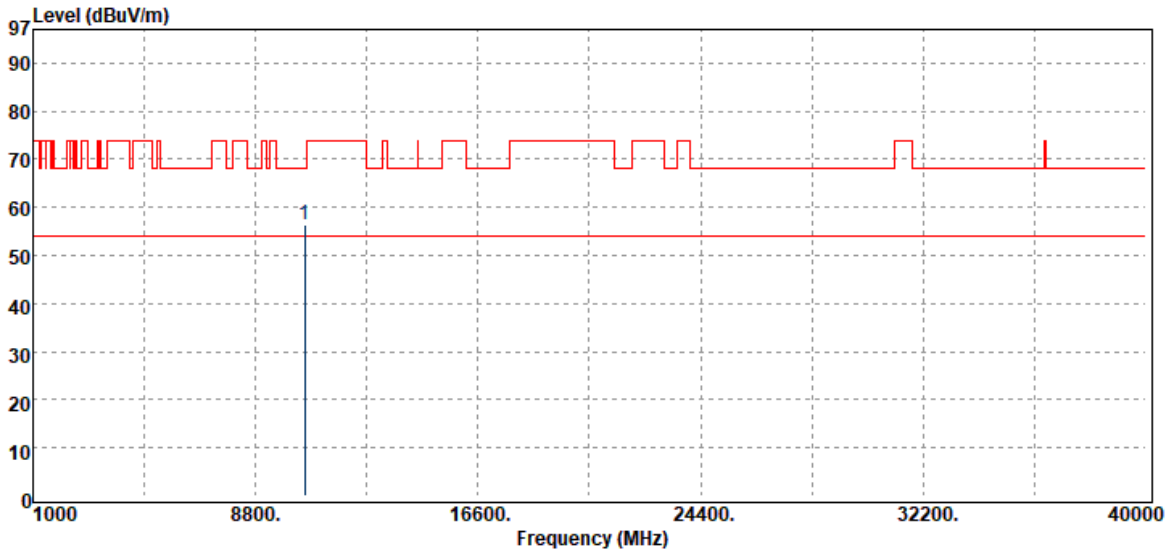

Freq. MHz	Detector Mode PK/QP/AV	Spectrum Reading Level dB μ V	Factor dB	Actual FS dB μ V/m	Limit @3m dB μ V/m	Margin dB
10520.00	Peak	35.24	21.27	56.51	68.20	-11.69

Unless otherwise stated the results shown in this test report refer only to the sample(s) tested and such sample(s) are retained for 90 days only.

除非另有說明，此報告結果僅對測試之樣品負責，同時此樣品僅保留90天。本報告未經本公司書面許可，不可部份複製。

This document is issued by the Company subject to its General Conditions of Service printed overleaf, available on request or accessible at <http://www.sgs.com.tw/Terms-and-Conditions> and for electronic format documents, subject to Terms and Conditions for Electronic Documents at <http://www.sgs.com.tw/Terms-and-Conditions>. Attention is drawn to the limitation of liability, indemnification and jurisdiction issues defined therein. Any holder of this document is advised that information contained hereon reflects the Company's findings at the time of its intervention only and within the limits of Client's instructions, if any. The Company's sole responsibility is to its Client and this document does not exonerate parties to a transaction from exercising all their rights and obligations under the transaction documents. This document cannot be reproduced except in full, without prior written approval of the Company. Any unauthorized alteration, forgery or falsification of the content or appearance of this document is unlawful and offenders may be prosecuted to the fullest extent of the law.

Report Number :ER-2020-80015
 Operation Mode :802.11n20
 Test Frequency :5300 MHz
 Test Mode :Tx CH Mid
 EUT Pol :H Plane

Test Site :SAC III Chamber
 Test Date :2020-08-10
 Temp./Humi. :25.8/60
 Antenna Pol. :VERTICAL
 Engineer :Ricky

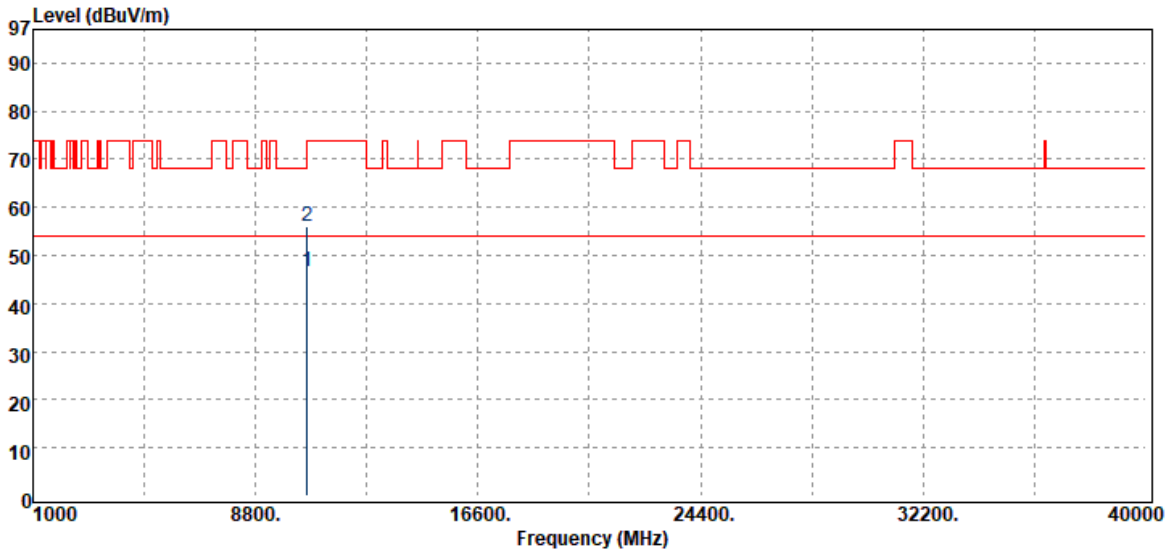

Freq. MHz	Detector Mode PK/QP/AV	Spectrum Reading Level dB μ V	Factor dB	Actual FS dB μ V/m	Limit @3m dB μ V/m	Margin dB
10600.00	Average	25.55	21.27	46.82	54.00	-7.18
10600.00	Peak	34.62	21.27	55.89	74.00	-18.11

Unless otherwise stated the results shown in this test report refer only to the sample(s) tested and such sample(s) are retained for 90 days only.

除非另有說明，此報告結果僅對測試之樣品負責，同時此樣品僅保留90天。本報告未經本公司書面許可，不可部份複製。

This document is issued by the Company subject to its General Conditions of Service printed overleaf, available on request or accessible at <http://www.sgs.com.tw/Terms-and-Conditions> and for electronic format documents, subject to Terms and Conditions for Electronic Documents at <http://www.sgs.com.tw/Terms-and-Conditions>. Attention is drawn to the limitation of liability, indemnification and jurisdiction issues defined therein. Any holder of this document is advised that information contained hereon reflects the Company's findings at the time of its intervention only and within the limits of Client's instructions, if any. The Company's sole responsibility is to its Client and this document does not exonerate parties to a transaction from exercising all their rights and obligations under the transaction documents. This document cannot be reproduced except in full, without prior written approval of the Company. Any unauthorized alteration, forgery or falsification of the content or appearance of this document is unlawful and offenders may be prosecuted to the fullest extent of the law.

Report Number :ER-2020-80015
 Operation Mode :802.11n20
 Test Frequency :5300 MHz
 Test Mode :Tx CH Mid
 EUT Pol :H Plane

Test Site :SAC III Chamber
 Test Date :2020-08-10
 Temp./Humi. :25.8/60
 Antenna Pol. :HORIZONTAL
 Engineer :Ricky

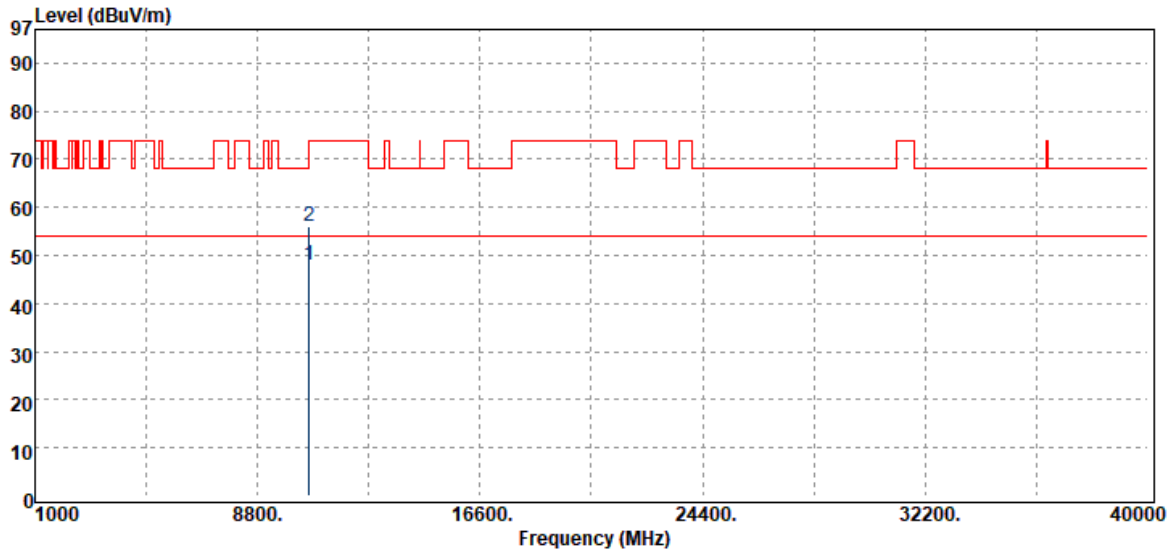

Freq. MHz	Detector Mode PK/QP/AV	Spectrum Reading Level dB μ V	Factor dB	Actual FS dB μ V/m	Limit @3m dB μ V/m	Margin dB
10600.00	Average	26.63	21.27	47.90	54.00	-6.10
10600.00	Peak	34.74	21.27	56.01	74.00	-17.99

Unless otherwise stated the results shown in this test report refer only to the sample(s) tested and such sample(s) are retained for 90 days only.

除非另有說明，此報告結果僅對測試之樣品負責，同時此樣品僅保留90天。本報告未經本公司書面許可，不可部份複製。

This document is issued by the Company subject to its General Conditions of Service printed overleaf, available on request or accessible at <http://www.sgs.com.tw/Terms-and-Conditions> and for electronic format documents, subject to Terms and Conditions for Electronic Documents at <http://www.sgs.com.tw/Terms-and-Conditions>. Attention is drawn to the limitation of liability, indemnification and jurisdiction issues defined therein. Any holder of this document is advised that information contained hereon reflects the Company's findings at the time of its intervention only and within the limits of Client's instructions, if any. The Company's sole responsibility is to its Client and this document does not exonerate parties to a transaction from exercising all their rights and obligations under the transaction documents. This document cannot be reproduced except in full, without prior written approval of the Company. Any unauthorized alteration, forgery or falsification of the content or appearance of this document is unlawful and offenders may be prosecuted to the fullest extent of the law.

Report Number :ER-2020-80015
Operation Mode :802.11n20
Test Frequency :5320 MHz
Test Mode :Tx CH High
EUT Pol :H Plane

Test Site :SAC III Chamber
Test Date :2020-08-10
Temp./Humi. :25.8/60
Antenna Pol. :VERTICAL
Engineer :Ricky

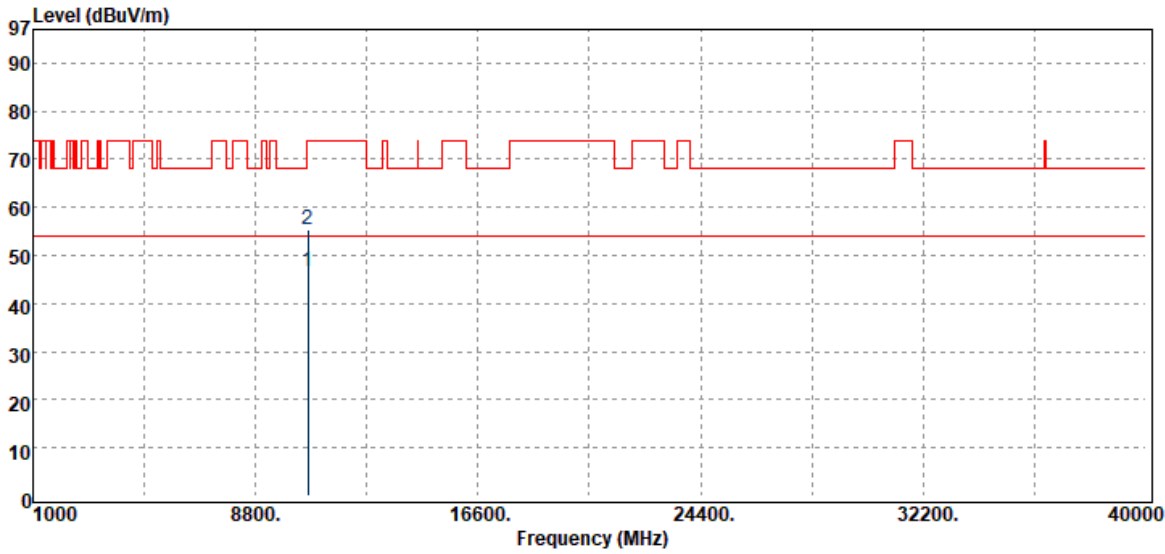

Freq. MHz	Detector Mode PK/QP/AV	Spectrum Reading Level dB μ V	Factor dB	Actual FS dB μ V/m	Limit @3m dB μ V/m	Margin dB
10640.00	Average	25.51	21.21	46.72	54.00	-7.28
10640.00	Peak	34.18	21.21	55.39	74.00	-18.61

Unless otherwise stated the results shown in this test report refer only to the sample(s) tested and such sample(s) are retained for 90 days only.

除非另有說明，此報告結果僅對測試之樣品負責，同時此樣品僅保留90天。本報告未經本公司書面許可，不可部份複製。

This document is issued by the Company subject to its General Conditions of Service printed overleaf, available on request or accessible at <http://www.sgs.com.tw/Terms-and-Conditions> and for electronic format documents, subject to Terms and Conditions for Electronic Documents at <http://www.sgs.com.tw/Terms-and-Conditions>. Attention is drawn to the limitation of liability, indemnification and jurisdiction issues defined therein. Any holder of this document is advised that information contained hereon reflects the Company's findings at the time of its intervention only and within the limits of Client's instructions, if any. The Company's sole responsibility is to its Client and this document does not exonerate parties to a transaction from exercising all their rights and obligations under the transaction documents. This document cannot be reproduced except in full, without prior written approval of the Company. Any unauthorized alteration, forgery or falsification of the content or appearance of this document is unlawful and offenders may be prosecuted to the fullest extent of the law.

Report Number :ER-2020-80015
Operation Mode :802.11n20
Test Frequency :5320 MHz
Test Mode :Tx CH High
EUT Pol :H Plane

Test Site :SAC III Chamber
Test Date :2020-08-10
Temp./Humi. :25.8/60
Antenna Pol. :HORIZONTAL
Engineer :Ricky

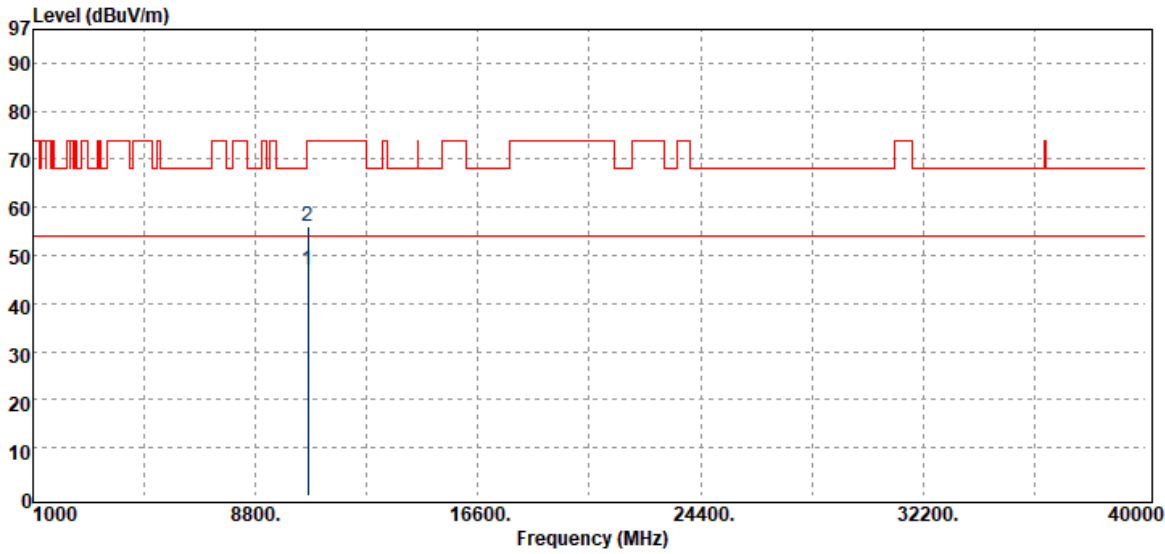

Freq. MHz	Detector Mode PK/QP/AV	Spectrum Reading Level dB μ V	Factor dB	Actual FS dB μ V/m	Limit @3m dB μ V/m	Margin dB
10640.00	Average	25.66	21.21	46.87	54.00	-7.13
10640.00	Peak	34.80	21.21	56.01	74.00	-17.99

Unless otherwise stated the results shown in this test report refer only to the sample(s) tested and such sample(s) are retained for 90 days only.

除非另有說明，此報告結果僅對測試之樣品負責，同時此樣品僅保留90天。本報告未經本公司書面許可，不可部份複製。

This document is issued by the Company subject to its General Conditions of Service printed overleaf, available on request or accessible at <http://www.sgs.com.tw/Terms-and-Conditions> and for electronic format documents, subject to Terms and Conditions for Electronic Documents at <http://www.sgs.com.tw/Terms-and-Conditions>. Attention is drawn to the limitation of liability, indemnification and jurisdiction issues defined therein. Any holder of this document is advised that information contained hereon reflects the Company's findings at the time of its intervention only and within the limits of Client's instructions, if any. The Company's sole responsibility is to its Client and this document does not exonerate parties to a transaction from exercising all their rights and obligations under the transaction documents. This document cannot be reproduced except in full, without prior written approval of the Company. Any unauthorized alteration, forgery or falsification of the content or appearance of this document is unlawful and offenders may be prosecuted to the fullest extent of the law.

Report Number :ER-2020-80015
 Operation Mode :802.11n20
 Test Frequency :5500 MHz
 Test Mode :Tx CH Low
 EUT Pol :H Plane

Test Site :SAC III Chamber
 Test Date :2020-08-10
 Temp./Humi. :25.8/60
 Antenna Pol. :VERTICAL
 Engineer :Ricky

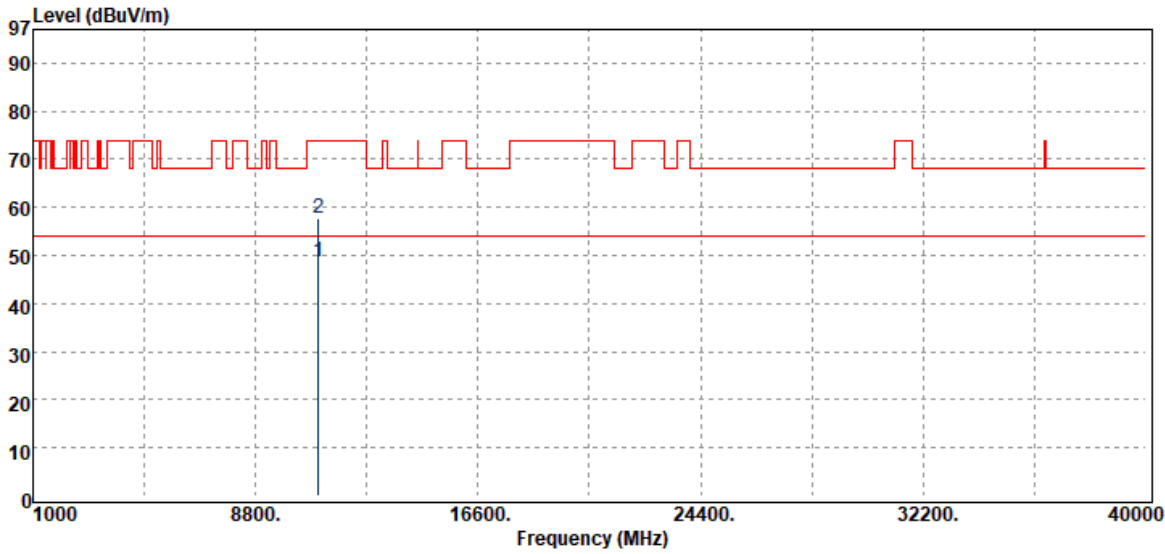

Freq. MHz	Detector Mode PK/QP/AV	Spectrum Reading Level dB μ V	Factor dB	Actual FS dB μ V/m	Limit @3m dB μ V/m	Margin dB
11000.00	Average	25.43	23.37	48.80	54.00	-5.20
11000.00	Peak	34.50	23.37	57.87	74.00	-16.13

Unless otherwise stated the results shown in this test report refer only to the sample(s) tested and such sample(s) are retained for 90 days only.

除非另有說明，此報告結果僅對測試之樣品負責，同時此樣品僅保留90天。本報告未經本公司書面許可，不可部份複製。

This document is issued by the Company subject to its General Conditions of Service printed overleaf, available on request or accessible at <http://www.sgs.com.tw/Terms-and-Conditions> and for electronic format documents, subject to Terms and Conditions for Electronic Documents at <http://www.sgs.com.tw/Terms-and-Conditions>. Attention is drawn to the limitation of liability, indemnification and jurisdiction issues defined therein. Any holder of this document is advised that information contained hereon reflects the Company's findings at the time of its intervention only and within the limits of Client's instructions, if any. The Company's sole responsibility is to its Client and this document does not exonerate parties to a transaction from exercising all their rights and obligations under the transaction documents. This document cannot be reproduced except in full, without prior written approval of the Company. Any unauthorized alteration, forgery or falsification of the content or appearance of this document is unlawful and offenders may be prosecuted to the fullest extent of the law.

Report Number :ER-2020-80015
Operation Mode :802.11n20
Test Frequency :5500 MHz
Test Mode :Tx CH Low
EUT Pol :H Plane

Test Site :SAC III Chamber
Test Date :2020-08-10
Temp./Humi. :25.8/60
Antenna Pol. :HORIZONTAL
Engineer :Ricky

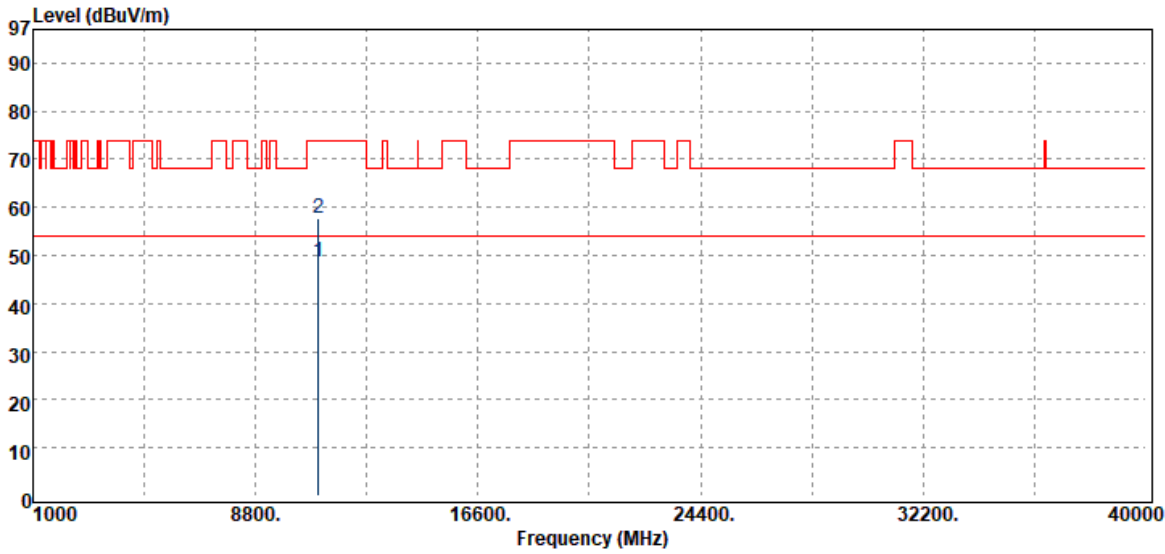

Freq. MHz	Detector Mode PK/QP/AV	Spectrum Reading Level dB μ V	Factor dB	Actual FS dB μ V/m	Limit @3m dB μ V/m	Margin dB
11000.00	Average	25.36	23.37	48.73	54.00	-5.27
11000.00	Peak	34.23	23.37	57.60	74.00	-16.40

Unless otherwise stated the results shown in this test report refer only to the sample(s) tested and such sample(s) are retained for 90 days only.

除非另有說明，此報告結果僅對測試之樣品負責，同時此樣品僅保留90天。本報告未經本公司書面許可，不可部份複製。

This document is issued by the Company subject to its General Conditions of Service printed overleaf, available on request or accessible at <http://www.sgs.com.tw/Terms-and-Conditions> and for electronic format documents, subject to Terms and Conditions for Electronic Documents at <http://www.sgs.com.tw/Terms-and-Conditions>. Attention is drawn to the limitation of liability, indemnification and jurisdiction issues defined therein. Any holder of this document is advised that information contained hereon reflects the Company's findings at the time of its intervention only and within the limits of Client's instructions, if any. The Company's sole responsibility is to its Client and this document does not exonerate parties to a transaction from exercising all their rights and obligations under the transaction documents. This document cannot be reproduced except in full, without prior written approval of the Company. Any unauthorized alteration, forgery or falsification of the content or appearance of this document is unlawful and offenders may be prosecuted to the fullest extent of the law.

Report Number :ER-2020-80015
 Operation Mode :802.11n20
 Test Frequency :5580 MHz
 Test Mode :Tx CH Mid
 EUT Pol :H Plane

Test Site :SAC III Chamber
 Test Date :2020-08-10
 Temp./Humi. :25.8/60
 Antenna Pol. :VERTICAL
 Engineer :Ricky

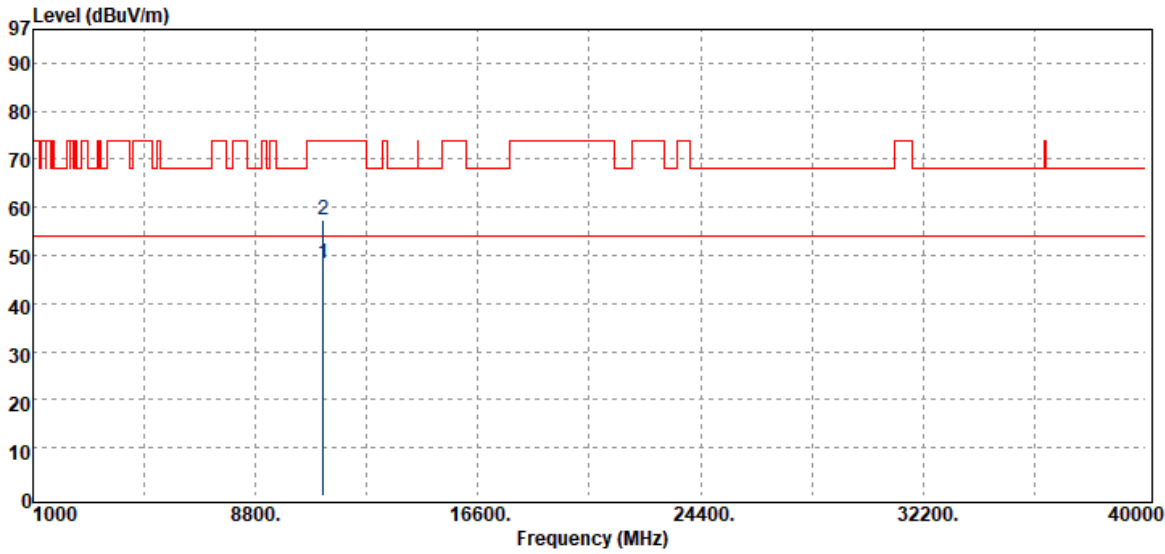

Freq. MHz	Detector Mode PK/QP/AV	Spectrum Reading Level dB μ V	Factor dB	Actual FS dB μ V/m	Limit @3m dB μ V/m	Margin dB
11160.00	Average	25.97	22.20	48.17	54.00	-5.83
11160.00	Peak	35.36	22.20	57.56	74.00	-16.44

Unless otherwise stated the results shown in this test report refer only to the sample(s) tested and such sample(s) are retained for 90 days only.

除非另有說明，此報告結果僅對測試之樣品負責，同時此樣品僅保留90天。本報告未經本公司書面許可，不可部份複製。

This document is issued by the Company subject to its General Conditions of Service printed overleaf, available on request or accessible at <http://www.sgs.com.tw/Terms-and-Conditions> and for electronic format documents, subject to Terms and Conditions for Electronic Documents at <http://www.sgs.com.tw/Terms-and-Conditions>. Attention is drawn to the limitation of liability, indemnification and jurisdiction issues defined therein. Any holder of this document is advised that information contained hereon reflects the Company's findings at the time of its intervention only and within the limits of Client's instructions, if any. The Company's sole responsibility is to its Client and this document does not exonerate parties to a transaction from exercising all their rights and obligations under the transaction documents. This document cannot be reproduced except in full, without prior written approval of the Company. Any unauthorized alteration, forgery or falsification of the content or appearance of this document is unlawful and offenders may be prosecuted to the fullest extent of the law.

Report Number :ER-2020-80015
 Operation Mode :802.11n20
 Test Frequency :5580 MHz
 Test Mode :Tx CH Mid
 EUT Pol :H Plane

Test Site :SAC III Chamber
 Test Date :2020-08-10
 Temp./Humi. :25.8/60
 Antenna Pol. :HORIZONTAL
 Engineer :Ricky

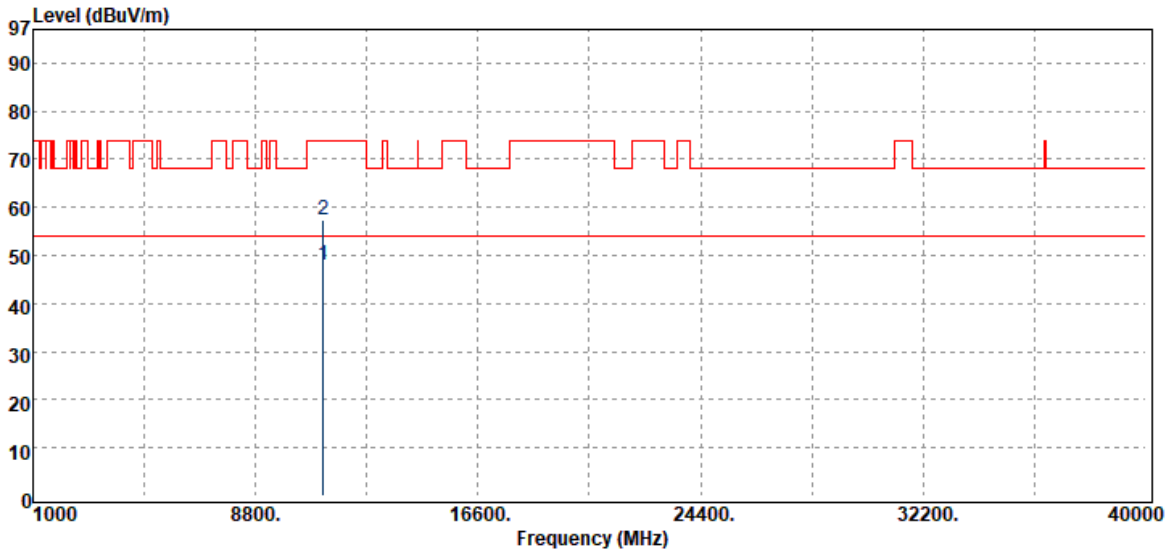

Freq. MHz	Detector Mode PK/QP/AV	Spectrum Reading Level dB μ V	Factor dB	Actual FS dB μ V/m	Limit @3m dB μ V/m	Margin dB
11160.00	Average	25.70	22.20	47.90	54.00	-6.10
11160.00	Peak	35.19	22.20	57.39	74.00	-16.61

Unless otherwise stated the results shown in this test report refer only to the sample(s) tested and such sample(s) are retained for 90 days only.

除非另有說明，此報告結果僅對測試之樣品負責，同時此樣品僅保留90天。本報告未經本公司書面許可，不可部份複製。

This document is issued by the Company subject to its General Conditions of Service printed overleaf, available on request or accessible at <http://www.sgs.com.tw/Terms-and-Conditions> and for electronic format documents, subject to Terms and Conditions for Electronic Documents at <http://www.sgs.com.tw/Terms-and-Conditions>. Attention is drawn to the limitation of liability, indemnification and jurisdiction issues defined therein. Any holder of this document is advised that information contained hereon reflects the Company's findings at the time of its intervention only and within the limits of Client's instructions, if any. The Company's sole responsibility is to its Client and this document does not exonerate parties to a transaction from exercising all their rights and obligations under the transaction documents. This document cannot be reproduced except in full, without prior written approval of the Company. Any unauthorized alteration, forgery or falsification of the content or appearance of this document is unlawful and offenders may be prosecuted to the fullest extent of the law.

Report Number :ER-2020-80015
 Operation Mode :802.11n20
 Test Frequency :5700 MHz
 Test Mode :Tx CH High
 EUT Pol :H Plane

Test Site :SAC III Chamber
 Test Date :2020-08-10
 Temp./Humi. :25.8/60
 Antenna Pol. :VERTICAL
 Engineer :Ricky

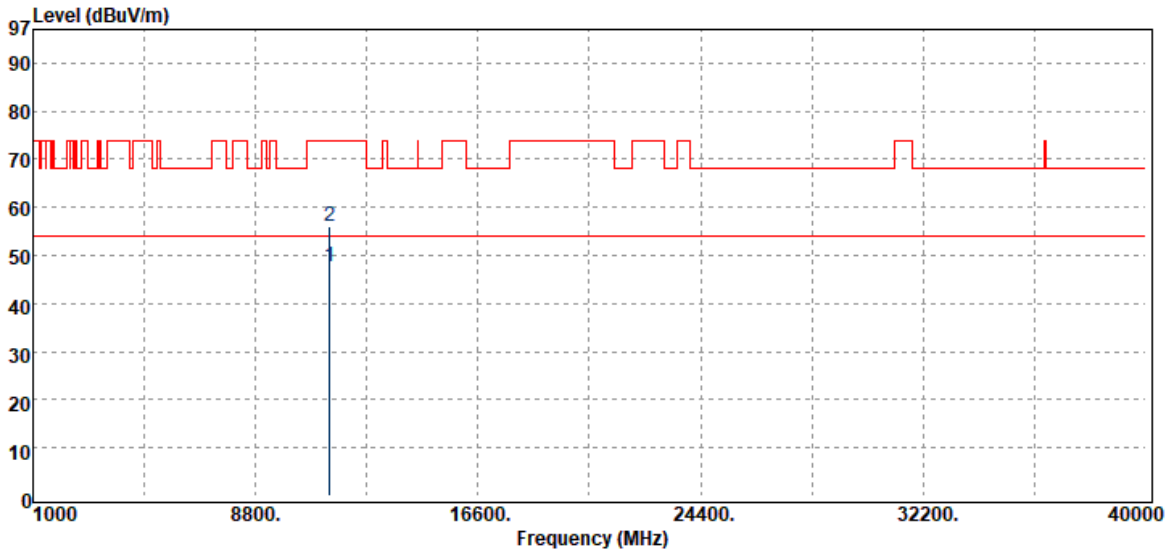

Freq. MHz	Detector Mode PK/QP/AV	Spectrum Reading Level dB μ V	Factor dB	Actual FS dB μ V/m	Limit @3m dB μ V/m	Margin dB
11400.00	Average	25.54	22.22	47.76	54.00	-6.24
11400.00	Peak	33.81	22.22	56.03	74.00	-17.97

Unless otherwise stated the results shown in this test report refer only to the sample(s) tested and such sample(s) are retained for 90 days only.

除非另有說明，此報告結果僅對測試之樣品負責，同時此樣品僅保留90天。本報告未經本公司書面許可，不可部份複製。

This document is issued by the Company subject to its General Conditions of Service printed overleaf, available on request or accessible at <http://www.sgs.com.tw/Terms-and-Conditions> and for electronic format documents, subject to Terms and Conditions for Electronic Documents at <http://www.sgs.com.tw/Terms-and-Conditions>. Attention is drawn to the limitation of liability, indemnification and jurisdiction issues defined therein. Any holder of this document is advised that information contained hereon reflects the Company's findings at the time of its intervention only and within the limits of Client's instructions, if any. The Company's sole responsibility is to its Client and this document does not exonerate parties to a transaction from exercising all their rights and obligations under the transaction documents. This document cannot be reproduced except in full, without prior written approval of the Company. Any unauthorized alteration, forgery or falsification of the content or appearance of this document is unlawful and offenders may be prosecuted to the fullest extent of the law.

Report Number :ER-2020-80015
 Operation Mode :802.11n20
 Test Frequency :5700 MHz
 Test Mode :Tx CH High
 EUT Pol :H Plane

Test Site :SAC III Chamber
 Test Date :2020-08-10
 Temp./Humi. :25.8/60
 Antenna Pol. :HORIZONTAL
 Engineer :Ricky

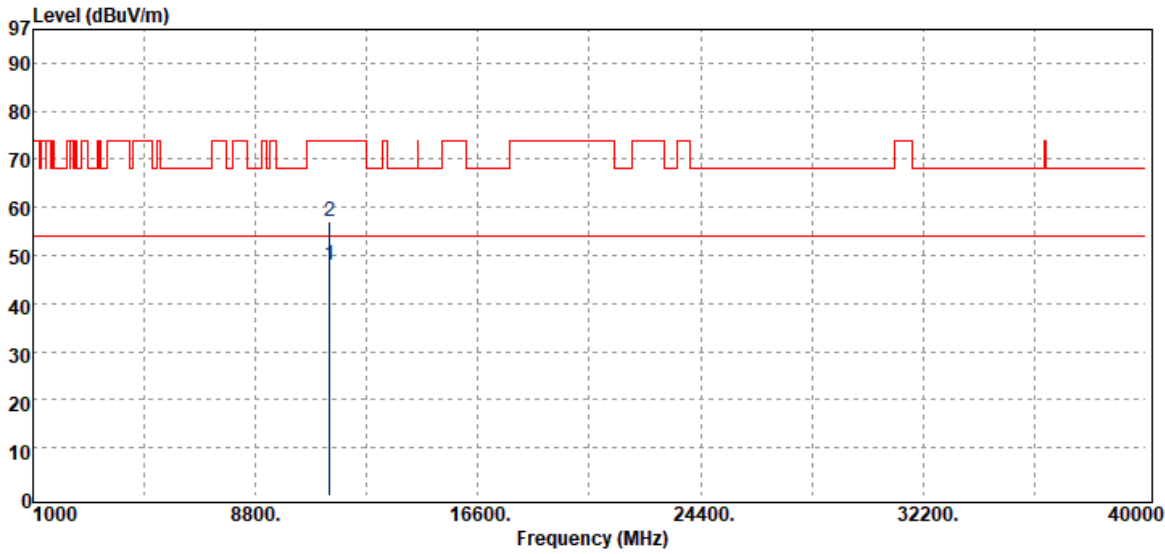

Freq. MHz	Detector Mode PK/QP/AV	Spectrum Reading Level dB μ V	Factor dB	Actual FS dB μ V/m	Limit @3m dB μ V/m	Margin dB
11400.00	Average	25.76	22.22	47.98	54.00	-6.02
11400.00	Peak	34.82	22.22	57.04	74.00	-16.96

Unless otherwise stated the results shown in this test report refer only to the sample(s) tested and such sample(s) are retained for 90 days only.

除非另有說明，此報告結果僅對測試之樣品負責，同時此樣品僅保留90天。本報告未經本公司書面許可，不可部份複製。

This document is issued by the Company subject to its General Conditions of Service printed overleaf, available on request or accessible at <http://www.sgs.com.tw/Terms-and-Conditions> and for electronic format documents, subject to Terms and Conditions for Electronic Documents at <http://www.sgs.com.tw/Terms-and-Conditions>. Attention is drawn to the limitation of liability, indemnification and jurisdiction issues defined therein. Any holder of this document is advised that information contained hereon reflects the Company's findings at the time of its intervention only and within the limits of Client's instructions, if any. The Company's sole responsibility is to its Client and this document does not exonerate parties to a transaction from exercising all their rights and obligations under the transaction documents. This document cannot be reproduced except in full, without prior written approval of the Company. Any unauthorized alteration, forgery or falsification of the content or appearance of this document is unlawful and offenders may be prosecuted to the fullest extent of the law.

Report Number :ER-2020-80015
 Operation Mode :802.11n20
 Test Frequency :5745 MHz
 Test Mode :Tx CH Low
 EUT Pol :H Plane

Test Site :SAC III Chamber
 Test Date :2020-08-10
 Temp./Humi. :25.8/60
 Antenna Pol. :VERTICAL
 Engineer :Ricky

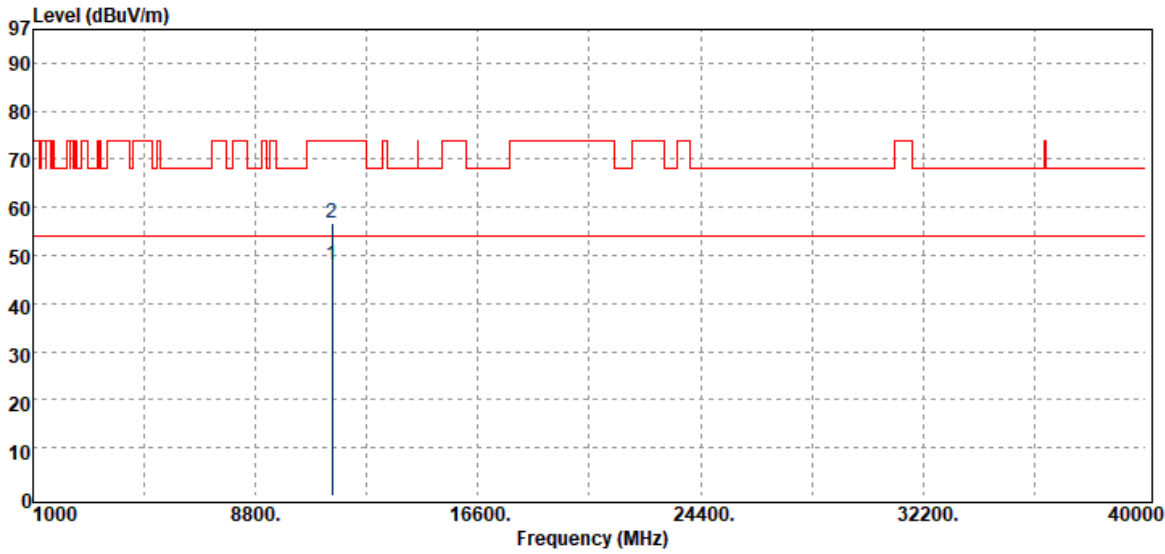

Freq. MHz	Detector Mode PK/QP/AV	Spectrum Reading Level dB μ V	Factor dB	Actual FS dB μ V/m	Limit @3m dB μ V/m	Margin dB
11490.00	Average	24.77	23.24	48.01	54.00	-5.99
11490.00	Peak	33.64	23.24	56.88	74.00	-17.12

Unless otherwise stated the results shown in this test report refer only to the sample(s) tested and such sample(s) are retained for 90 days only.

除非另有說明，此報告結果僅對測試之樣品負責，同時此樣品僅保留90天。本報告未經本公司書面許可，不可部份複製。

This document is issued by the Company subject to its General Conditions of Service printed overleaf, available on request or accessible at <http://www.sgs.com.tw/Terms-and-Conditions> and for electronic format documents, subject to Terms and Conditions for Electronic Documents at <http://www.sgs.com.tw/Terms-and-Conditions>. Attention is drawn to the limitation of liability, indemnification and jurisdiction issues defined therein. Any holder of this document is advised that information contained hereon reflects the Company's findings at the time of its intervention only and within the limits of Client's instructions, if any. The Company's sole responsibility is to its Client and this document does not exonerate parties to a transaction from exercising all their rights and obligations under the transaction documents. This document cannot be reproduced except in full, without prior written approval of the Company. Any unauthorized alteration, forgery or falsification of the content or appearance of this document is unlawful and offenders may be prosecuted to the fullest extent of the law.

Report Number :ER-2020-80015
Operation Mode :802.11n20
Test Frequency :5745 MHz
Test Mode :Tx CH Low
EUT Pol :H Plane

Test Site :SAC III Chamber
Test Date :2020-08-10
Temp./Humi. :25.8/60
Antenna Pol. :HORIZONTAL
Engineer :Ricky

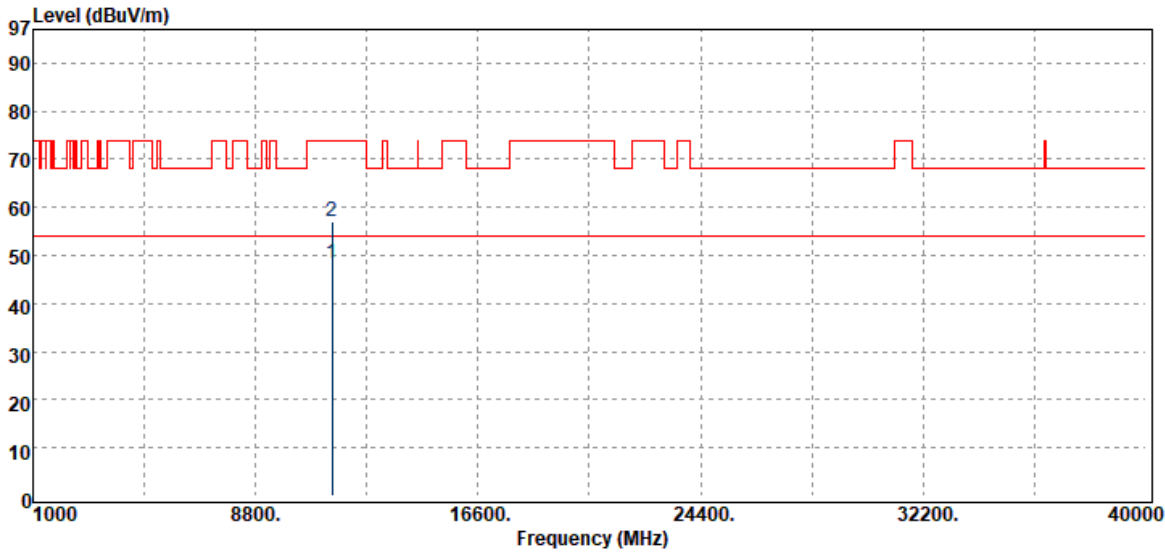

Freq. MHz	Detector Mode PK/QP/AV	Spectrum Reading Level d μ V	Factor dB	Actual FS d μ V/m	Limit @3m d μ V/m	Margin dB
11490.00	Average	24.99	23.24	48.23	54.00	-5.77
11490.00	Peak	33.85	23.24	57.09	74.00	-16.91

Unless otherwise stated the results shown in this test report refer only to the sample(s) tested and such sample(s) are retained for 90 days only.

除非另有說明，此報告結果僅對測試之樣品負責，同時此樣品僅保留90天。本報告未經本公司書面許可，不可部份複製。

This document is issued by the Company subject to its General Conditions of Service printed overleaf, available on request or accessible at <http://www.sgs.com.tw/Terms-and-Conditions> and for electronic format documents, subject to Terms and Conditions for Electronic Documents at <http://www.sgs.com.tw/Terms-and-Conditions>. Attention is drawn to the limitation of liability, indemnification and jurisdiction issues defined therein. Any holder of this document is advised that information contained hereon reflects the Company's findings at the time of its intervention only and within the limits of Client's instructions, if any. The Company's sole responsibility is to its Client and this document does not exonerate parties to a transaction from exercising all their rights and obligations under the transaction documents. This document cannot be reproduced except in full, without prior written approval of the Company. Any unauthorized alteration, forgery or falsification of the content or appearance of this document is unlawful and offenders may be prosecuted to the fullest extent of the law.

Report Number :ER-2020-80015
 Operation Mode :802.11n20
 Test Frequency :5785 MHz
 Test Mode :Tx CH Mid
 EUT Pol :H Plane

Test Site :SAC III Chamber
 Test Date :2020-08-10
 Temp./Humi. :25.8/60
 Antenna Pol. :VERTICAL
 Engineer :Ricky

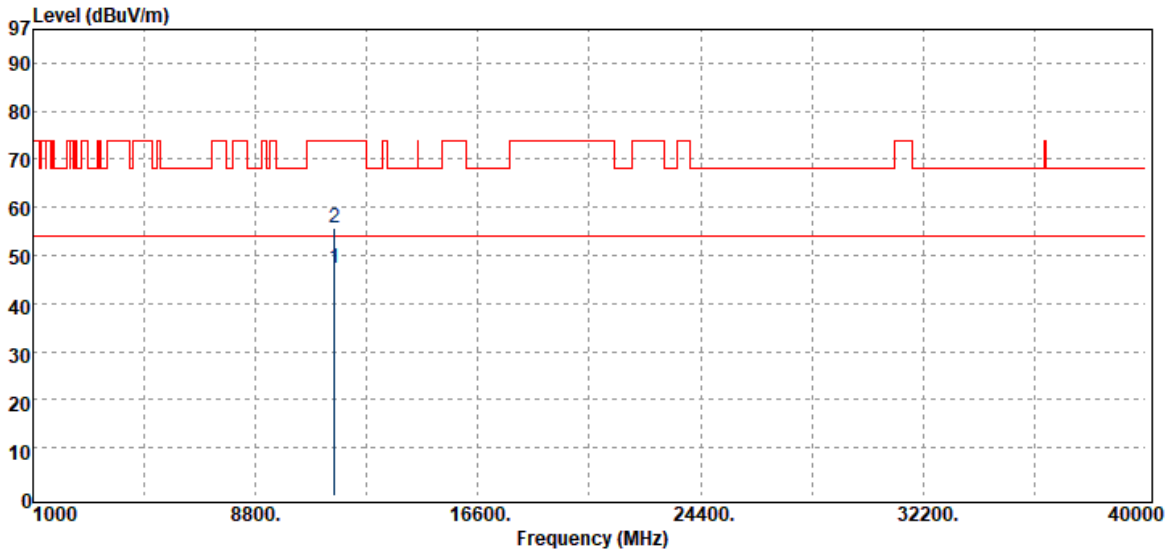

Freq. MHz	Detector Mode PK/QP/AV	Spectrum Reading Level dB μ V	Factor dB	Actual FS dB μ V/m	Limit @3m dB μ V/m	Margin dB
11570.00	Average	25.44	22.01	47.45	54.00	-6.55
11570.00	Peak	33.83	22.01	55.84	74.00	-18.16

Unless otherwise stated the results shown in this test report refer only to the sample(s) tested and such sample(s) are retained for 90 days only.

除非另有說明，此報告結果僅對測試之樣品負責，同時此樣品僅保留90天。本報告未經本公司書面許可，不可部份複製。

This document is issued by the Company subject to its General Conditions of Service printed overleaf, available on request or accessible at <http://www.sgs.com.tw/Terms-and-Conditions> and for electronic format documents, subject to Terms and Conditions for Electronic Documents at <http://www.sgs.com.tw/Terms-and-Conditions>. Attention is drawn to the limitation of liability, indemnification and jurisdiction issues defined therein. Any holder of this document is advised that information contained hereon reflects the Company's findings at the time of its intervention only and within the limits of Client's instructions, if any. The Company's sole responsibility is to its Client and this document does not exonerate parties to a transaction from exercising all their rights and obligations under the transaction documents. This document cannot be reproduced except in full, without prior written approval of the Company. Any unauthorized alteration, forgery or falsification of the content or appearance of this document is unlawful and offenders may be prosecuted to the fullest extent of the law.

Report Number :ER-2020-80015
Operation Mode :802.11n20
Test Frequency :5785 MHz
Test Mode :Tx CH Mid
EUT Pol :H Plane

Test Site :SAC III Chamber
Test Date :2020-08-10
Temp./Humi. :25.8/60
Antenna Pol. :HORIZONTAL
Engineer :Ricky

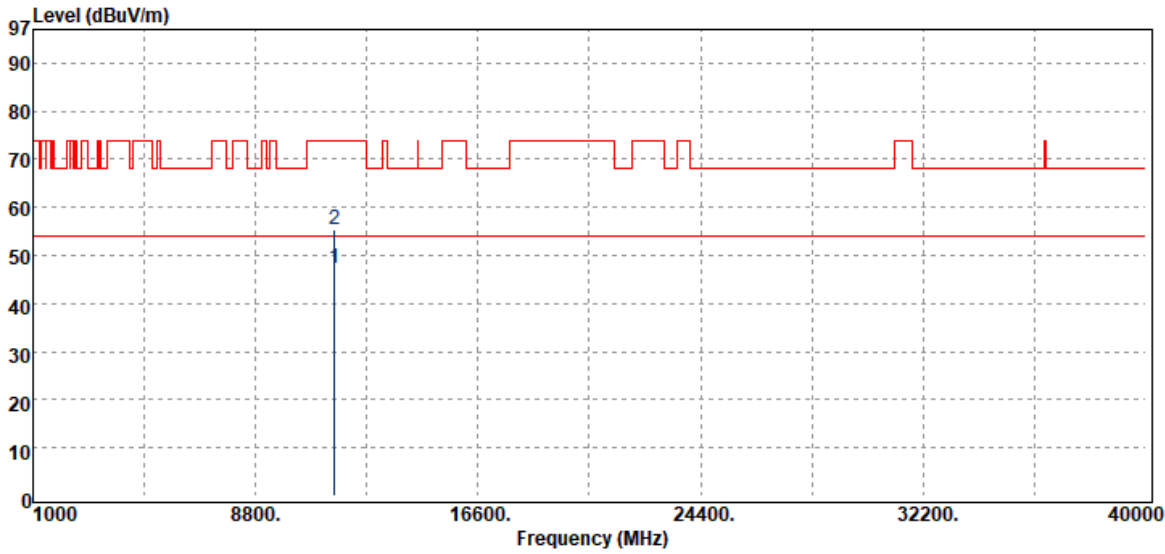

Freq. MHz	Detector Mode PK/QP/AV	Spectrum Reading Level dB μ V	Factor dB	Actual FS dB μ V/m	Limit @3m dB μ V/m	Margin dB
11570.00	Average	25.41	22.01	47.42	54.00	-6.58
11570.00	Peak	33.48	22.01	55.49	74.00	-18.51

Unless otherwise stated the results shown in this test report refer only to the sample(s) tested and such sample(s) are retained for 90 days only.

除非另有說明，此報告結果僅對測試之樣品負責，同時此樣品僅保留90天。本報告未經本公司書面許可，不可部份複製。

This document is issued by the Company subject to its General Conditions of Service printed overleaf, available on request or accessible at <http://www.sgs.com.tw/Terms-and-Conditions> and for electronic format documents, subject to Terms and Conditions for Electronic Documents at <http://www.sgs.com.tw/Terms-and-Conditions>. Attention is drawn to the limitation of liability, indemnification and jurisdiction issues defined therein. Any holder of this document is advised that information contained hereon reflects the Company's findings at the time of its intervention only and within the limits of Client's instructions, if any. The Company's sole responsibility is to its Client and this document does not exonerate parties to a transaction from exercising all their rights and obligations under the transaction documents. This document cannot be reproduced except in full, without prior written approval of the Company. Any unauthorized alteration, forgery or falsification of the content or appearance of this document is unlawful and offenders may be prosecuted to the fullest extent of the law.

Report Number :ER-2020-80015
 Operation Mode :802.11n20
 Test Frequency :5825 MHz
 Test Mode :Tx CH High
 EUT Pol :H Plane

Test Site :SAC III Chamber
 Test Date :2020-08-10
 Temp./Humi. :25.8/60
 Antenna Pol. :VERTICAL
 Engineer :Ricky

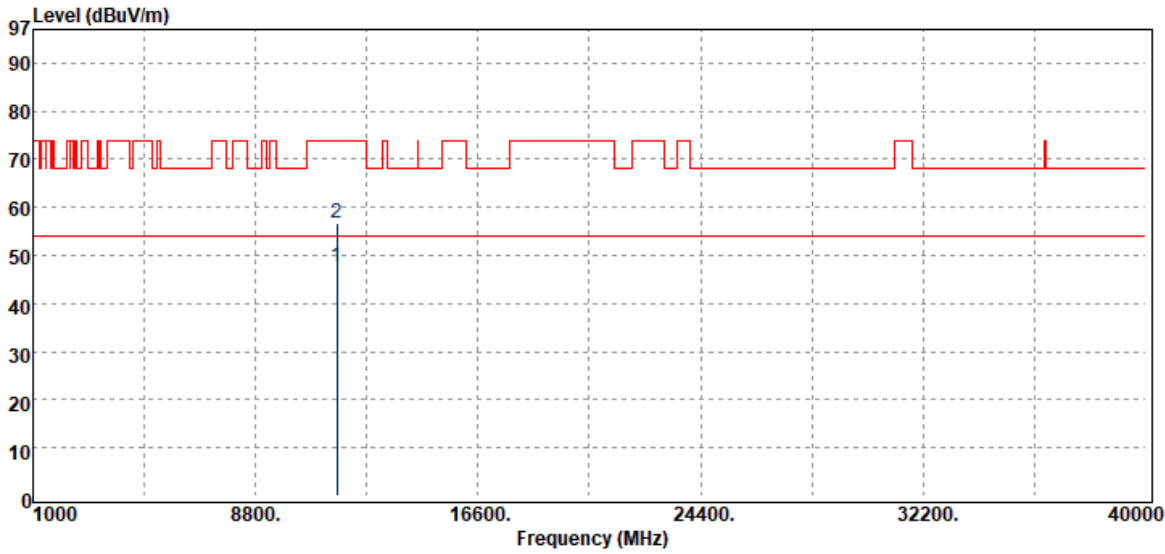

Freq. MHz	Detector Mode PK/QP/AV	Spectrum Reading Level dB μ V	Factor dB	Actual FS dB μ V/m	Limit @3m dB μ V/m	Margin dB
11650.00	Average	25.08	22.45	47.53	54.00	-6.47
11650.00	Peak	34.32	22.45	56.77	74.00	-17.23

Unless otherwise stated the results shown in this test report refer only to the sample(s) tested and such sample(s) are retained for 90 days only.

除非另有說明，此報告結果僅對測試之樣品負責，同時此樣品僅保留90天。本報告未經本公司書面許可，不可部份複製。

This document is issued by the Company subject to its General Conditions of Service printed overleaf, available on request or accessible at <http://www.sgs.com.tw/Terms-and-Conditions> and for electronic format documents, subject to Terms and Conditions for Electronic Documents at <http://www.sgs.com.tw/Terms-and-Conditions>. Attention is drawn to the limitation of liability, indemnification and jurisdiction issues defined therein. Any holder of this document is advised that information contained hereon reflects the Company's findings at the time of its intervention only and within the limits of Client's instructions, if any. The Company's sole responsibility is to its Client and this document does not exonerate parties to a transaction from exercising all their rights and obligations under the transaction documents. This document cannot be reproduced except in full, without prior written approval of the Company. Any unauthorized alteration, forgery or falsification of the content or appearance of this document is unlawful and offenders may be prosecuted to the fullest extent of the law.

Report Number :ER-2020-80015
 Operation Mode :802.11n20
 Test Frequency :5825 MHz
 Test Mode :Tx CH High
 EUT Pol :H Plane

Test Site :SAC III Chamber
 Test Date :2020-08-10
 Temp./Humi. :25.8/60
 Antenna Pol. :HORIZONTAL
 Engineer :Ricky

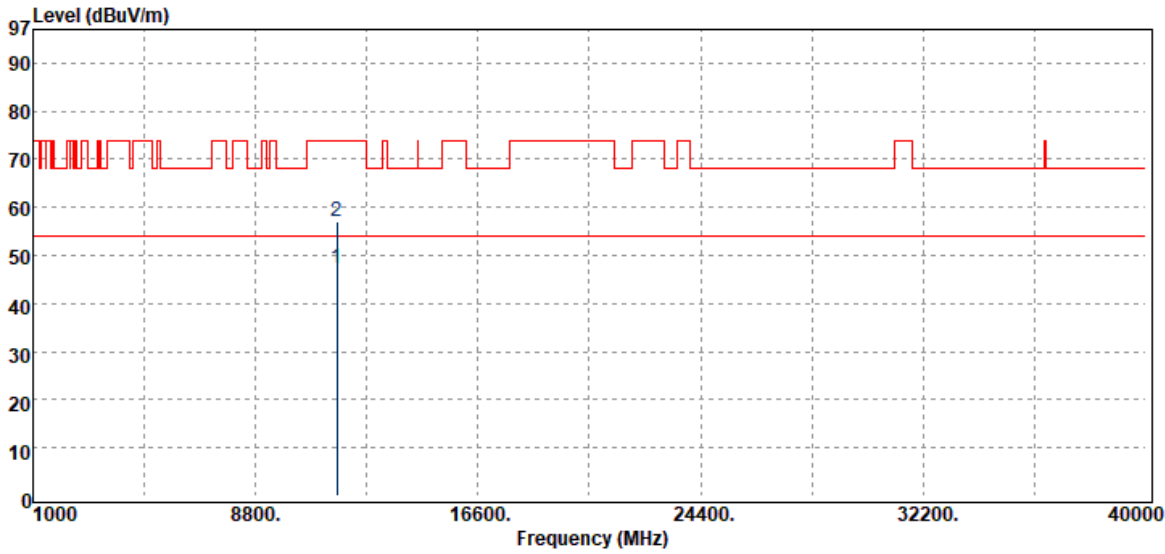

Freq. MHz	Detector Mode PK/QP/AV	Spectrum Reading Level dB μ V	Factor dB	Actual FS dB μ V/m	Limit @3m dB μ V/m	Margin dB
11650.00	Average	24.81	22.45	47.26	54.00	-6.74
11650.00	Peak	34.54	22.45	56.99	74.00	-17.01

Unless otherwise stated the results shown in this test report refer only to the sample(s) tested and such sample(s) are retained for 90 days only.

除非另有說明，此報告結果僅對測試之樣品負責，同時此樣品僅保留90天。本報告未經本公司書面許可，不可部份複製。

This document is issued by the Company subject to its General Conditions of Service printed overleaf, available on request or accessible at <http://www.sgs.com.tw/Terms-and-Conditions> and for electronic format documents, subject to Terms and Conditions for Electronic Documents at <http://www.sgs.com.tw/Terms-and-Conditions>. Attention is drawn to the limitation of liability, indemnification and jurisdiction issues defined therein. Any holder of this document is advised that information contained hereon reflects the Company's findings at the time of its intervention only and within the limits of Client's instructions, if any. The Company's sole responsibility is to its Client and this document does not exonerate parties to a transaction from exercising all their rights and obligations under the transaction documents. This document cannot be reproduced except in full, without prior written approval of the Company. Any unauthorized alteration, forgery or falsification of the content or appearance of this document is unlawful and offenders may be prosecuted to the fullest extent of the law.

11.7.3 Band edge falling to restricted band

Report Number	:ER-2020-80015	Test Site	:SAC III Chamber
Operation Mode	:802.11a	Test Date	:2020-08-07
Test Frequency	:5180 MHz	Temp./Humi.	:25.8/63
Test Mode	:Bandedge CH Low	Antenna Pol.	:VERTICAL
EUT Pol	:H Plane	Engineer	:Ricky

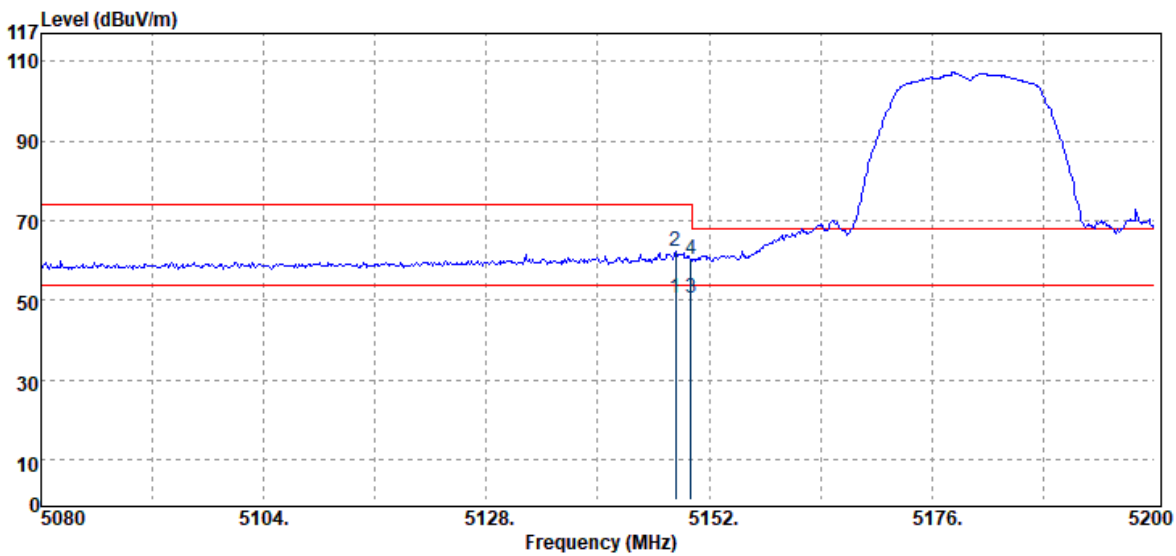

Freq. MHz	Detector Mode PK/QP/AV	Spectrum Reading Level dB μ V	Factor dB	Actual FS dB μ V/m	Limit @3m dB μ V/m	Margin dB
5148.40	Average	41.95	8.68	50.63	54.00	-3.37
5148.40	Peak	53.60	8.68	62.28	74.00	-11.72
5150.00	Average	41.94	8.68	50.62	54.00	-3.38
5150.00	Peak	51.62	8.68	60.30	74.00	-13.70

Unless otherwise stated the results shown in this test report refer only to the sample(s) tested and such sample(s) are retained for 90 days only.

除非另有說明，此報告結果僅對測試之樣品負責，同時此樣品僅保留90天。本報告未經本公司書面許可，不可部份複製。

This document is issued by the Company subject to its General Conditions of Service printed overleaf, available on request or accessible at <http://www.sgs.com.tw/Terms-and-Conditions> and for electronic format documents, subject to Terms and Conditions for Electronic Documents at <http://www.sgs.com.tw/Terms-and-Conditions>. Attention is drawn to the limitation of liability, indemnification and jurisdiction issues defined therein. Any holder of this document is advised that information contained hereon reflects the Company's findings at the time of its intervention only and within the limits of Client's instructions, if any. The Company's sole responsibility is to its Client and this document does not exonerate parties to a transaction from exercising all their rights and obligations under the transaction documents. This document cannot be reproduced except in full, without prior written approval of the Company. Any unauthorized alteration, forgery or falsification of the content or appearance of this document is unlawful and offenders may be prosecuted to the fullest extent of the law.

Report Number :ER-2020-80015
Operation Mode :802.11a
Test Frequency :5180 MHz
Test Mode :Bandedge CH Low
EUT Pol :H Plane

Test Site :SAC III Chamber
Test Date :2020-08-07
Temp./Humi. :25.8/63
Antenna Pol. :HORIZONTAL
Engineer :Ricky

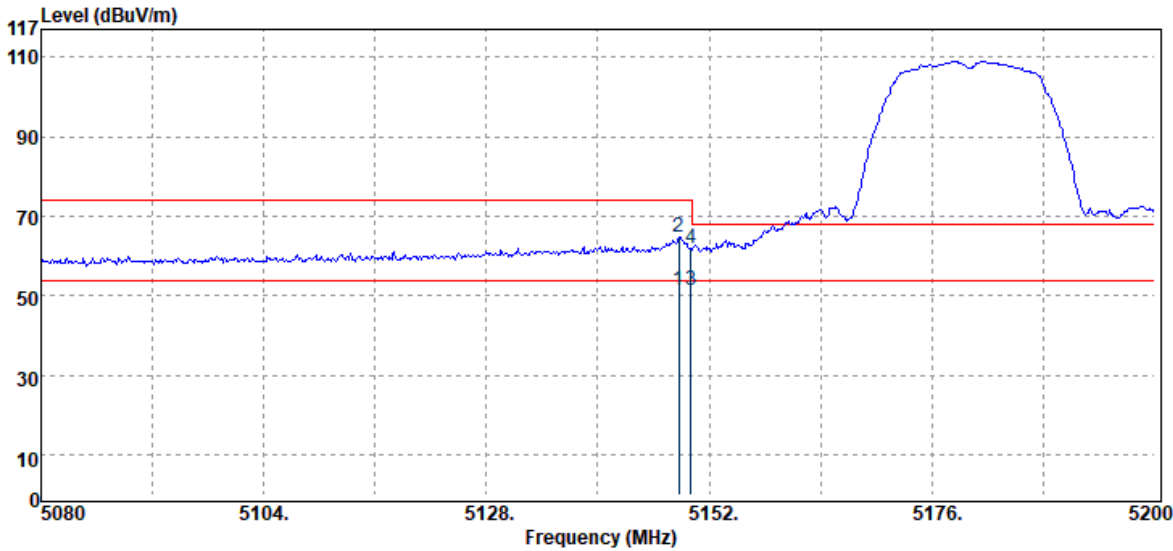

Freq. MHz	Detector Mode PK/QP/AV	Spectrum Reading Level dB μ V	Factor dB	Actual FS dB μ V/m	Limit @3m dB μ V/m	Margin dB
5148.76	Average	42.78	8.68	51.46	54.00	-2.54
5148.76	Peak	56.14	8.68	64.82	74.00	-9.18
5150.00	Average	42.84	8.68	51.52	54.00	-2.48
5150.00	Peak	53.41	8.68	62.09	74.00	-11.91

Unless otherwise stated the results shown in this test report refer only to the sample(s) tested and such sample(s) are retained for 90 days only.

除非另有說明，此報告結果僅對測試之樣品負責，同時此樣品僅保留90天。本報告未經本公司書面許可，不可部份複製。

This document is issued by the Company subject to its General Conditions of Service printed overleaf, available on request or accessible at <http://www.sgs.com.tw/Terms-and-Conditions> and for electronic format documents, subject to Terms and Conditions for Electronic Documents at <http://www.sgs.com.tw/Terms-and-Conditions>. Attention is drawn to the limitation of liability, indemnification and jurisdiction issues defined therein. Any holder of this document is advised that information contained hereon reflects the Company's findings at the time of its intervention only and within the limits of Client's instructions, if any. The Company's sole responsibility is to its Client and this document does not exonerate parties to a transaction from exercising all their rights and obligations under the transaction documents. This document cannot be reproduced except in full, without prior written approval of the Company. Any unauthorized alteration, forgery or falsification of the content or appearance of this document is unlawful and offenders may be prosecuted to the fullest extent of the law.

Report Number :ER-2020-80015
 Operation Mode :802.11a
 Test Frequency :5320 MHz
 Test Mode :Bandedge CH High
 EUT Pol :H Plane

Test Site :SAC III Chamber
 Test Date :2020-08-07
 Temp./Humi. :25.8/63
 Antenna Pol. :VERTICAL
 Engineer :Ricky

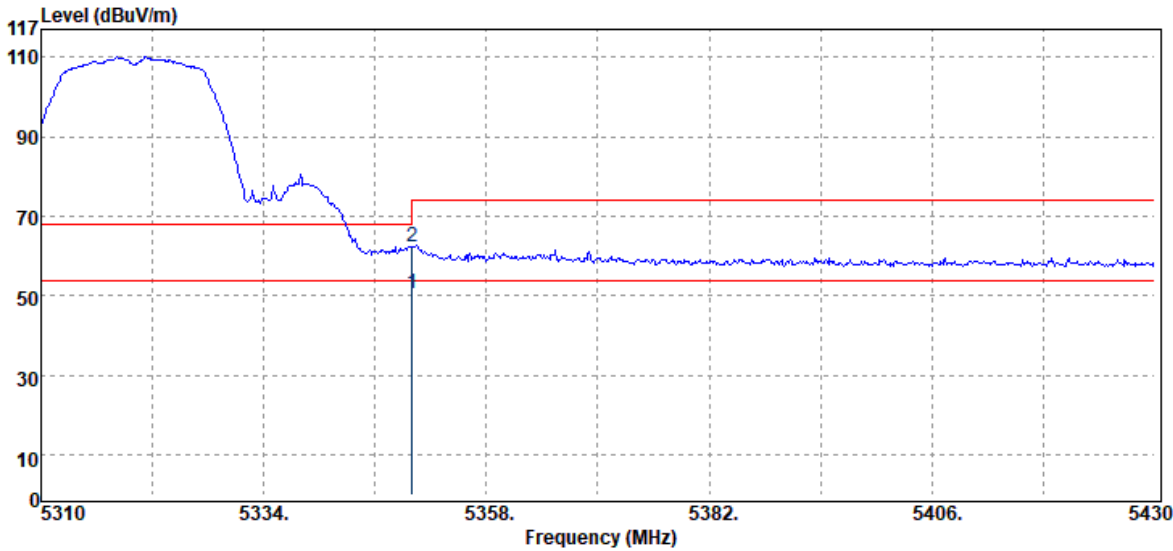

Freq. MHz	Detector Mode PK/QP/AV	Spectrum Reading Level dB μ V	Factor dB	Actual FS dB μ V/m	Limit @3m dB μ V/m	Margin dB
5350.00	Average	42.31	8.12	50.43	54.00	-3.57
5350.00	Peak	54.36	8.12	62.48	74.00	-11.52

Unless otherwise stated the results shown in this test report refer only to the sample(s) tested and such sample(s) are retained for 90 days only.

除非另有說明，此報告結果僅對測試之樣品負責，同時此樣品僅保留90天。本報告未經本公司書面許可，不可部份複製。

This document is issued by the Company subject to its General Conditions of Service printed overleaf, available on request or accessible at <http://www.sgs.com.tw/Terms-and-Conditions> and for electronic format documents, subject to Terms and Conditions for Electronic Documents at <http://www.sgs.com.tw/Terms-and-Conditions>. Attention is drawn to the limitation of liability, indemnification and jurisdiction issues defined therein. Any holder of this document is advised that information contained hereon reflects the Company's findings at the time of its intervention only and within the limits of Client's instructions, if any. The Company's sole responsibility is to its Client and this document does not exonerate parties to a transaction from exercising all their rights and obligations under the transaction documents. This document cannot be reproduced except in full, without prior written approval of the Company. Any unauthorized alteration, forgery or falsification of the content or appearance of this document is unlawful and offenders may be prosecuted to the fullest extent of the law.

Report Number	:ER-2020-80015	Test Site	:SAC III Chamber
Operation Mode	:802.11a	Test Date	:2020-08-07
Test Frequency	:5320 MHz	Temp./Humi.	:25.8/63
Test Mode	:Bandedge CH High	Antenna Pol.	:HORIZONTAL
EUT Pol	:H Plane	Engineer	:Ricky

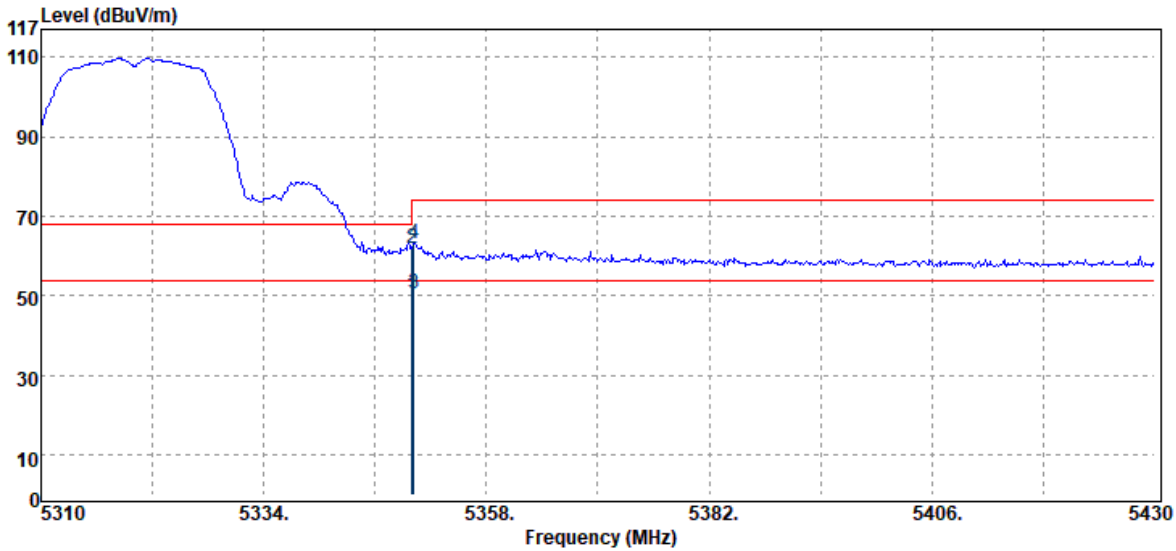

Freq. MHz	Detector Mode PK/QP/AV	Spectrum Reading Level dB μ V	Factor dB	Actual FS dB μ V/m	Limit @3m dB μ V/m	Margin dB
5350.00	Average	42.26	8.12	50.38	54.00	-3.62
5350.00	Peak	53.95	8.12	62.07	74.00	-11.93
5350.20	Average	42.33	8.12	50.45	54.00	-3.55
5350.20	Peak	55.20	8.12	63.32	74.00	-10.68

Unless otherwise stated the results shown in this test report refer only to the sample(s) tested and such sample(s) are retained for 90 days only.

除非另有說明，此報告結果僅對測試之樣品負責，同時此樣品僅保留90天。本報告未經本公司書面許可，不可部份複製。

This document is issued by the Company subject to its General Conditions of Service printed overleaf, available on request or accessible at <http://www.sgs.com.tw/Terms-and-Conditions> and for electronic format documents, subject to Terms and Conditions for Electronic Documents at <http://www.sgs.com.tw/Terms-and-Conditions>. Attention is drawn to the limitation of liability, indemnification and jurisdiction issues defined therein. Any holder of this document is advised that information contained hereon reflects the Company's findings at the time of its intervention only and within the limits of Client's instructions, if any. The Company's sole responsibility is to its Client and this document does not exonerate parties to a transaction from exercising all their rights and obligations under the transaction documents. This document cannot be reproduced except in full, without prior written approval of the Company. Any unauthorized alteration, forgery or falsification of the content or appearance of this document is unlawful and offenders may be prosecuted to the fullest extent of the law.

Report Number :ER-2020-80015
Operation Mode :802.11a
Test Frequency :5500 MHz
Test Mode :Bandedge CH Low
EUT Pol :H Plane

Test Site :SAC III Chamber
Test Date :2020-08-07
Temp./Humi. :25.8/63
Antenna Pol. :VERTICAL
Engineer :Ricky

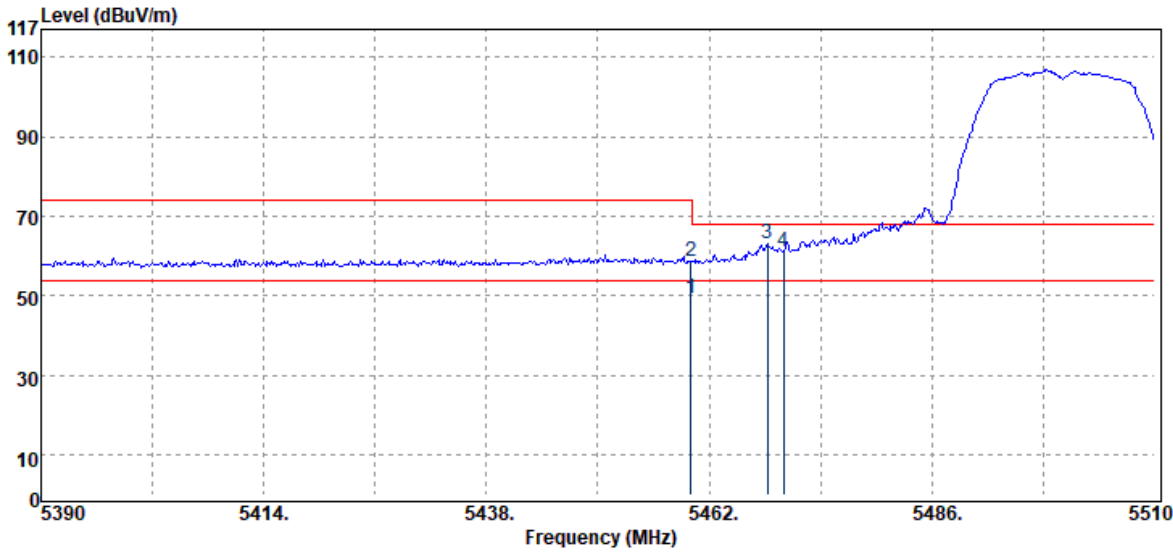

Freq. MHz	Detector Mode PK/QP/AV	Spectrum Reading Level dB μ V	Factor dB	Actual FS dB μ V/m	Limit @3m dB μ V/m	Margin dB
5460.00	Average	41.23	8.06	49.29	54.00	-4.71
5460.00	Peak	50.84	8.06	58.90	74.00	-15.10
5468.24	Peak	55.04	8.08	63.12	68.20	-5.08
5470.00	Peak	53.13	8.07	61.20	68.20	-7.00

Unless otherwise stated the results shown in this test report refer only to the sample(s) tested and such sample(s) are retained for 90 days only.

除非另有說明，此報告結果僅對測試之樣品負責，同時此樣品僅保留90天。本報告未經本公司書面許可，不可部份複製。

This document is issued by the Company subject to its General Conditions of Service printed overleaf, available on request or accessible at <http://www.sgs.com.tw/Terms-and-Conditions> and for electronic format documents, subject to Terms and Conditions for Electronic Documents at <http://www.sgs.com.tw/Terms-and-Conditions>. Attention is drawn to the limitation of liability, indemnification and jurisdiction issues defined therein. Any holder of this document is advised that information contained hereon reflects the Company's findings at the time of its intervention only and within the limits of Client's instructions, if any. The Company's sole responsibility is to its Client and this document does not exonerate parties to a transaction from exercising all their rights and obligations under the transaction documents. This document cannot be reproduced except in full, without prior written approval of the Company. Any unauthorized alteration, forgery or falsification of the content or appearance of this document is unlawful and offenders may be prosecuted to the fullest extent of the law.

Report Number :ER-2020-80015
Operation Mode :802.11a
Test Frequency :5500 MHz
Test Mode :Bandedge CH Low
EUT Pol :H Plane

Test Site :SAC III Chamber
Test Date :2020-08-07
Temp./Humi. :25.8/63
Antenna Pol. :HORIZONTAL
Engineer :Ricky

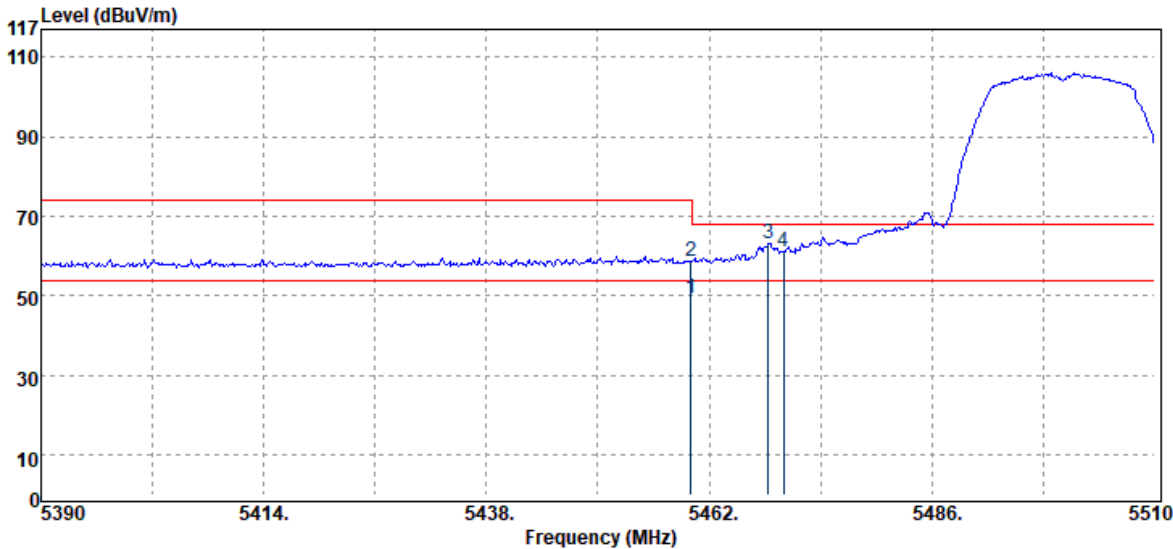

Freq. MHz	Detector Mode PK/QP/AV	Spectrum Reading Level dB μ V	Factor dB	Actual FS dB μ V/m	Limit @3m dB μ V/m	Margin dB
5460.00	Average	41.39	8.06	49.45	54.00	-4.55
5460.00	Peak	50.51	8.06	58.57	74.00	-15.43
5468.36	Peak	55.21	8.08	63.29	68.20	-4.91
5470.00	Peak	53.17	8.07	61.24	68.20	-6.96

Unless otherwise stated the results shown in this test report refer only to the sample(s) tested and such sample(s) are retained for 90 days only.

除非另有說明，此報告結果僅對測試之樣品負責，同時此樣品僅保留90天。本報告未經本公司書面許可，不可部份複製。

This document is issued by the Company subject to its General Conditions of Service printed overleaf, available on request or accessible at <http://www.sgs.com.tw/Terms-and-Conditions> and for electronic format documents, subject to Terms and Conditions for Electronic Documents at <http://www.sgs.com.tw/Terms-and-Conditions>. Attention is drawn to the limitation of liability, indemnification and jurisdiction issues defined therein. Any holder of this document is advised that information contained hereon reflects the Company's findings at the time of its intervention only and within the limits of Client's instructions, if any. The Company's sole responsibility is to its Client and this document does not exonerate parties to a transaction from exercising all their rights and obligations under the transaction documents. This document cannot be reproduced except in full, without prior written approval of the Company. Any unauthorized alteration, forgery or falsification of the content or appearance of this document is unlawful and offenders may be prosecuted to the fullest extent of the law.

Report Number :ER-2020-80015
Operation Mode :802.11a
Test Frequency :5700 MHz
Test Mode :Bandedge CH High
EUT Pol :H Plane

Test Site :SAC III Chamber
Test Date :2020-08-07
Temp./Humi. :25.8/63
Antenna Pol. :VERTICAL
Engineer :Ricky

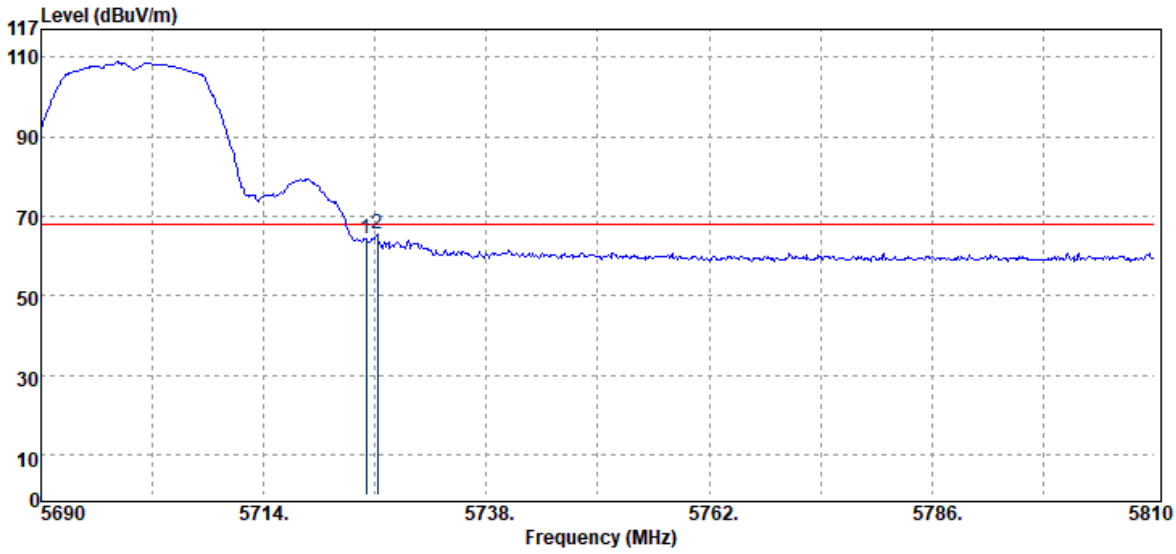

Freq. MHz	Detector Mode PK/QP/AV	Spectrum Reading Level d μ V	Factor dB	Actual FS d μ V/m	Limit @3m d μ V/m	Margin dB
5725.00	Peak	55.58	8.81	64.39	68.20	-3.81
5726.24	Peak	56.92	8.81	65.73	68.20	-2.47

Unless otherwise stated the results shown in this test report refer only to the sample(s) tested and such sample(s) are retained for 90 days only.

除非另有說明，此報告結果僅對測試之樣品負責，同時此樣品僅保留90天。本報告未經本公司書面許可，不可部份複製。

This document is issued by the Company subject to its General Conditions of Service printed overleaf, available on request or accessible at <http://www.sgs.com.tw/Terms-and-Conditions> and for electronic format documents, subject to Terms and Conditions for Electronic Documents at <http://www.sgs.com.tw/Terms-and-Conditions>. Attention is drawn to the limitation of liability, indemnification and jurisdiction issues defined therein. Any holder of this document is advised that information contained hereon reflects the Company's findings at the time of its intervention only and within the limits of Client's instructions, if any. The Company's sole responsibility is to its Client and this document does not exonerate parties to a transaction from exercising all their rights and obligations under the transaction documents. This document cannot be reproduced except in full, without prior written approval of the Company. Any unauthorized alteration, forgery or falsification of the content or appearance of this document is unlawful and offenders may be prosecuted to the fullest extent of the law.

Report Number	:ER-2020-80015	Test Site	:SAC III Chamber
Operation Mode	:802.11a	Test Date	:2020-08-07
Test Frequency	:5700 MHz	Temp./Humi.	:25.8/63
Test Mode	:Bandedge CH High	Antenna Pol.	:HORIZONTAL
EUT Pol	:H Plane	Engineer	:Ricky

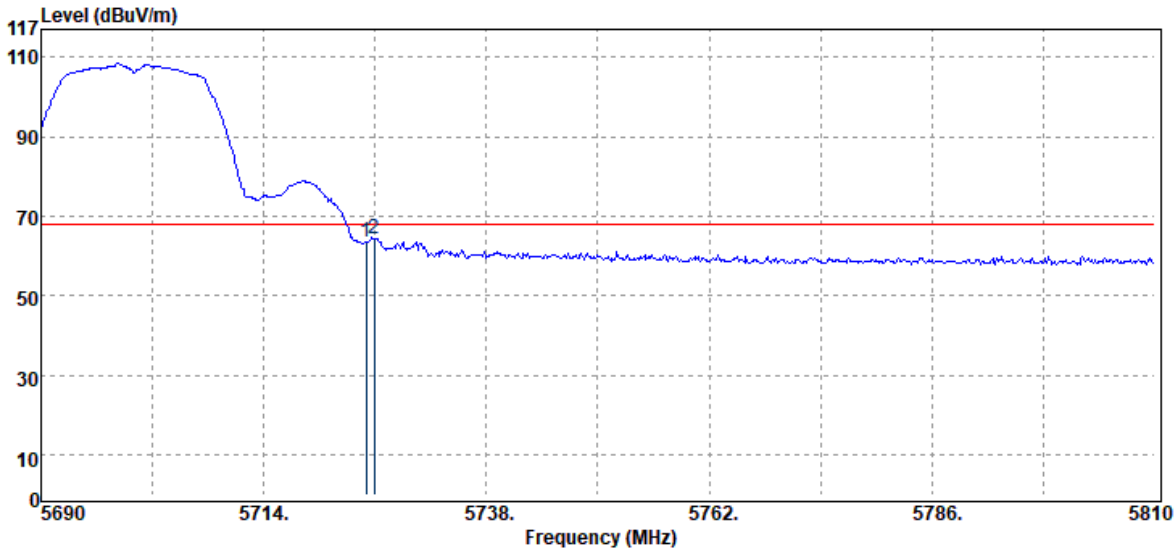

Freq. MHz	Detector Mode PK/QP/AV	Spectrum Reading Level d μ V	Factor dB	Actual FS d μ V/m	Limit @3m d μ V/m	Margin dB
5725.00	Peak	54.95	8.81	63.76	68.20	-4.44
5725.88	Peak	55.74	8.81	64.55	68.20	-3.65

Unless otherwise stated the results shown in this test report refer only to the sample(s) tested and such sample(s) are retained for 90 days only.

除非另有說明，此報告結果僅對測試之樣品負責，同時此樣品僅保留90天。本報告未經本公司書面許可，不可部份複製。

This document is issued by the Company subject to its General Conditions of Service printed overleaf, available on request or accessible at <http://www.sgs.com.tw/Terms-and-Conditions> and for electronic format documents, subject to Terms and Conditions for Electronic Documents at <http://www.sgs.com.tw/Terms-and-Conditions>. Attention is drawn to the limitation of liability, indemnification and jurisdiction issues defined therein. Any holder of this document is advised that information contained hereon reflects the Company's findings at the time of its intervention only and within the limits of Client's instructions, if any. The Company's sole responsibility is to its Client and this document does not exonerate parties to a transaction from exercising all their rights and obligations under the transaction documents. This document cannot be reproduced except in full, without prior written approval of the Company. Any unauthorized alteration, forgery or falsification of the content or appearance of this document is unlawful and offenders may be prosecuted to the fullest extent of the law.

Report Number :ER-2020-80015
Operation Mode :802.11a
Test Frequency :5745 MHz
Test Mode :Bandedge CH Low
EUT Pol :H Plane

Test Site :SAC III Chamber
Test Date :2020-08-07
Temp./Humi. :25.8/63
Antenna Pol. :VERTICAL
Engineer :Ricky

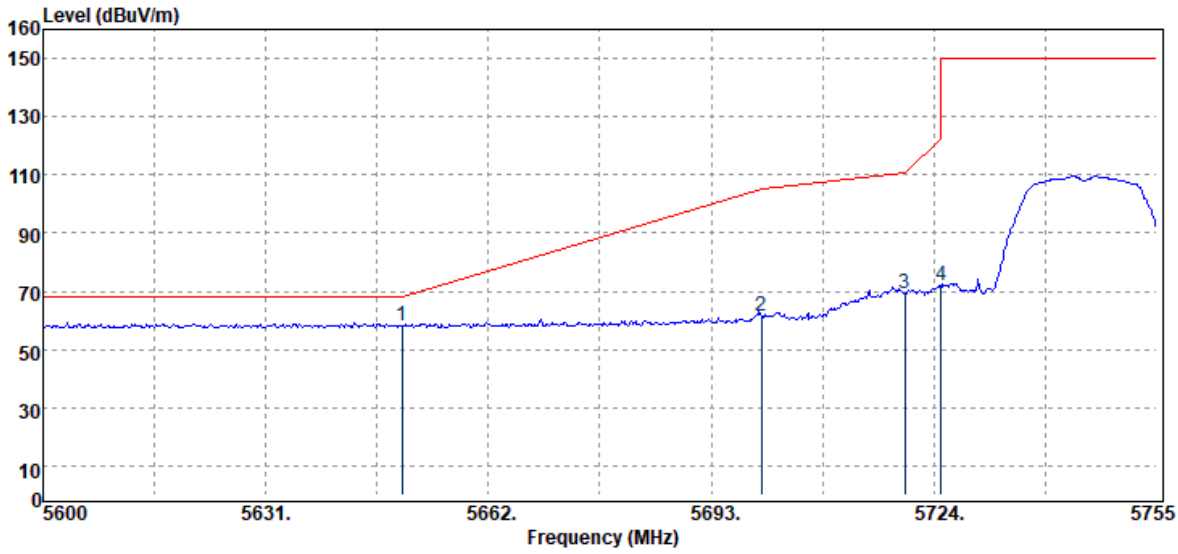

Freq. MHz	Detector Mode PK/QP/AV	Spectrum Reading Level dB μ V	Factor dB	Actual FS dB μ V/m	Limit @3m dB μ V/m	Margin dB
5650.00	Peak	49.77	8.32	58.09	68.20	-10.11
5700.00	Peak	52.66	8.69	61.35	105.20	-43.85
5720.00	Peak	60.50	8.78	69.28	110.80	-41.52
5725.00	Peak	63.36	8.81	72.17	122.20	-50.03

Unless otherwise stated the results shown in this test report refer only to the sample(s) tested and such sample(s) are retained for 90 days only.

除非另有說明，此報告結果僅對測試之樣品負責，同時此樣品僅保留90天。本報告未經本公司書面許可，不可部份複製。

This document is issued by the Company subject to its General Conditions of Service printed overleaf, available on request or accessible at <http://www.sgs.com.tw/Terms-and-Conditions> and for electronic format documents, subject to Terms and Conditions for Electronic Documents at <http://www.sgs.com.tw/Terms-and-Conditions>. Attention is drawn to the limitation of liability, indemnification and jurisdiction issues defined therein. Any holder of this document is advised that information contained hereon reflects the Company's findings at the time of its intervention only and within the limits of Client's instructions, if any. The Company's sole responsibility is to its Client and this document does not exonerate parties to a transaction from exercising all their rights and obligations under the transaction documents. This document cannot be reproduced except in full, without prior written approval of the Company. Any unauthorized alteration, forgery or falsification of the content or appearance of this document is unlawful and offenders may be prosecuted to the fullest extent of the law.

Report Number :ER-2020-80015
Operation Mode :802.11a
Test Frequency :5745 MHz
Test Mode :Bandedge CH Low
EUT Pol :H Plane

Test Site :SAC III Chamber
Test Date :2020-08-07
Temp./Humi. :25.8/63
Antenna Pol. :HORIZONTAL
Engineer :Ricky

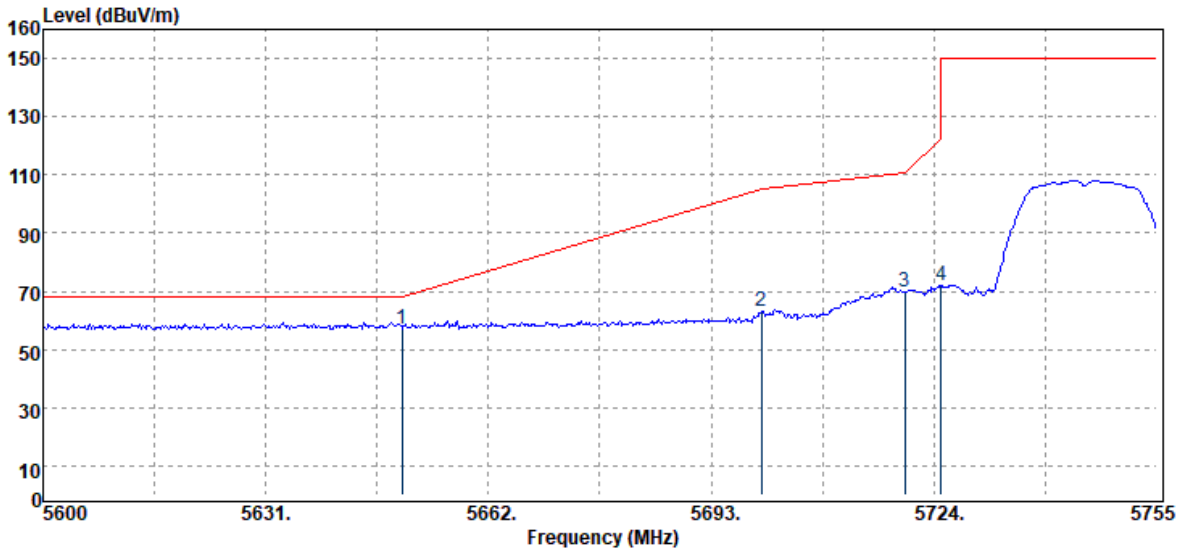

Freq. MHz	Detector Mode PK/QP/AV	Spectrum Reading Level dB μ V	Factor dB	Actual FS dB μ V/m	Limit @3m dB μ V/m	Margin dB
5650.00	Peak	48.95	8.32	57.27	68.20	-10.93
5700.00	Peak	54.35	8.69	63.04	105.20	-42.16
5720.00	Peak	60.97	8.78	69.75	110.80	-41.05
5725.00	Peak	63.05	8.81	71.86	122.20	-50.34

Unless otherwise stated the results shown in this test report refer only to the sample(s) tested and such sample(s) are retained for 90 days only.

除非另有說明，此報告結果僅對測試之樣品負責，同時此樣品僅保留90天。本報告未經本公司書面許可，不可部份複製。

This document is issued by the Company subject to its General Conditions of Service printed overleaf, available on request or accessible at <http://www.sgs.com.tw/Terms-and-Conditions> and for electronic format documents, subject to Terms and Conditions for Electronic Documents at <http://www.sgs.com.tw/Terms-and-Conditions>. Attention is drawn to the limitation of liability, indemnification and jurisdiction issues defined therein. Any holder of this document is advised that information contained hereon reflects the Company's findings at the time of its intervention only and within the limits of Client's instructions, if any. The Company's sole responsibility is to its Client and this document does not exonerate parties to a transaction from exercising all their rights and obligations under the transaction documents. This document cannot be reproduced except in full, without prior written approval of the Company. Any unauthorized alteration, forgery or falsification of the content or appearance of this document is unlawful and offenders may be prosecuted to the fullest extent of the law.

Report Number :ER-2020-80015
Operation Mode :802.11a
Test Frequency :5825 MHz
Test Mode :Bandedge CH High
EUT Pol :H Plane

Test Site :SAC III Chamber
Test Date :2020-08-07
Temp./Humi. :25.8/63
Antenna Pol. :VERTICAL
Engineer :Ricky

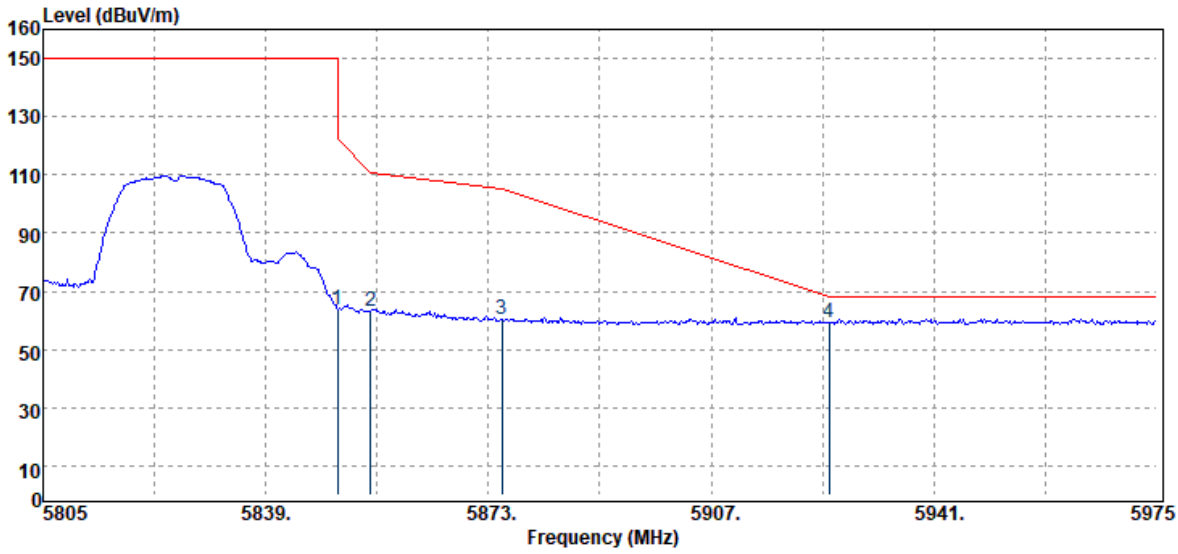

Freq. MHz	Detector Mode PK/QP/AV	Spectrum Reading Level dB μ V	Factor dB	Actual FS dB μ V/m	Limit @3m dB μ V/m	Margin dB
5850.00	Peak	54.51	9.42	63.93	122.20	-58.27
5855.00	Peak	53.95	9.44	63.39	110.80	-47.41
5875.00	Peak	50.92	9.50	60.42	105.20	-44.78
5925.00	Peak	49.57	9.65	59.22	68.20	-8.98

Unless otherwise stated the results shown in this test report refer only to the sample(s) tested and such sample(s) are retained for 90 days only.

除非另有說明，此報告結果僅對測試之樣品負責，同時此樣品僅保留90天。本報告未經本公司書面許可，不可部份複製。

This document is issued by the Company subject to its General Conditions of Service printed overleaf, available on request or accessible at <http://www.sgs.com.tw/Terms-and-Conditions> and for electronic format documents, subject to Terms and Conditions for Electronic Documents at <http://www.sgs.com.tw/Terms-and-Conditions>. Attention is drawn to the limitation of liability, indemnification and jurisdiction issues defined therein. Any holder of this document is advised that information contained hereon reflects the Company's findings at the time of its intervention only and within the limits of Client's instructions, if any. The Company's sole responsibility is to its Client and this document does not exonerate parties to a transaction from exercising all their rights and obligations under the transaction documents. This document cannot be reproduced except in full, without prior written approval of the Company. Any unauthorized alteration, forgery or falsification of the content or appearance of this document is unlawful and offenders may be prosecuted to the fullest extent of the law.

Report Number :ER-2020-80015
Operation Mode :802.11a
Test Frequency :5825 MHz
Test Mode :Bandedge CH High
EUT Pol :H Plane

Test Site :SAC III Chamber
Test Date :2020-08-07
Temp./Humi. :25.8/63
Antenna Pol. :HORIZONTAL
Engineer :Ricky

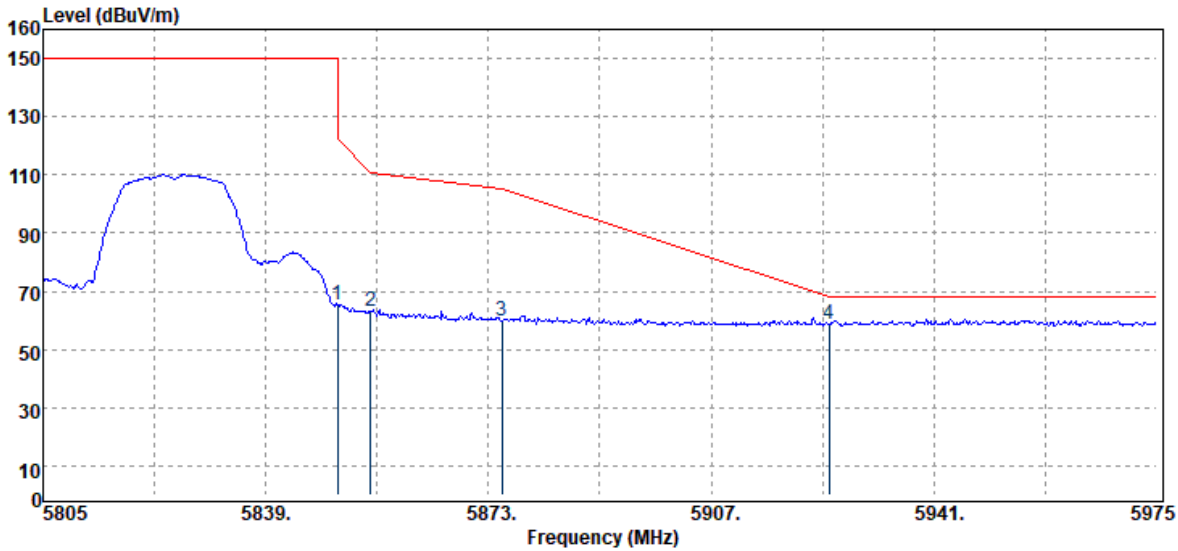

Freq. MHz	Detector Mode PK/QP/AV	Spectrum Reading Level dB μ V	Factor dB	Actual FS dB μ V/m	Limit @3m dB μ V/m	Margin dB
5850.00	Peak	56.05	9.42	65.47	122.20	-56.73
5855.00	Peak	53.66	9.44	63.10	110.80	-47.70
5875.00	Peak	50.13	9.50	59.63	105.20	-45.57
5925.00	Peak	48.87	9.65	58.52	68.20	-9.68

Unless otherwise stated the results shown in this test report refer only to the sample(s) tested and such sample(s) are retained for 90 days only.

除非另有說明，此報告結果僅對測試之樣品負責，同時此樣品僅保留90天。本報告未經本公司書面許可，不可部份複製。

This document is issued by the Company subject to its General Conditions of Service printed overleaf, available on request or accessible at <http://www.sgs.com.tw/Terms-and-Conditions> and for electronic format documents, subject to Terms and Conditions for Electronic Documents at <http://www.sgs.com.tw/Terms-and-Conditions>. Attention is drawn to the limitation of liability, indemnification and jurisdiction issues defined therein. Any holder of this document is advised that information contained hereon reflects the Company's findings at the time of its intervention only and within the limits of Client's instructions, if any. The Company's sole responsibility is to its Client and this document does not exonerate parties to a transaction from exercising all their rights and obligations under the transaction documents. This document cannot be reproduced except in full, without prior written approval of the Company. Any unauthorized alteration, forgery or falsification of the content or appearance of this document is unlawful and offenders may be prosecuted to the fullest extent of the law.

Report Number :ER-2020-80015
Operation Mode :802.11n20
Test Frequency :5180 MHz
Test Mode :Bandedge CH Low
EUT Pol :H Plane

Test Site :SAC III Chamber
Test Date :2020-08-07
Temp./Humi. :25.8/63
Antenna Pol. :VERTICAL
Engineer :Ricky

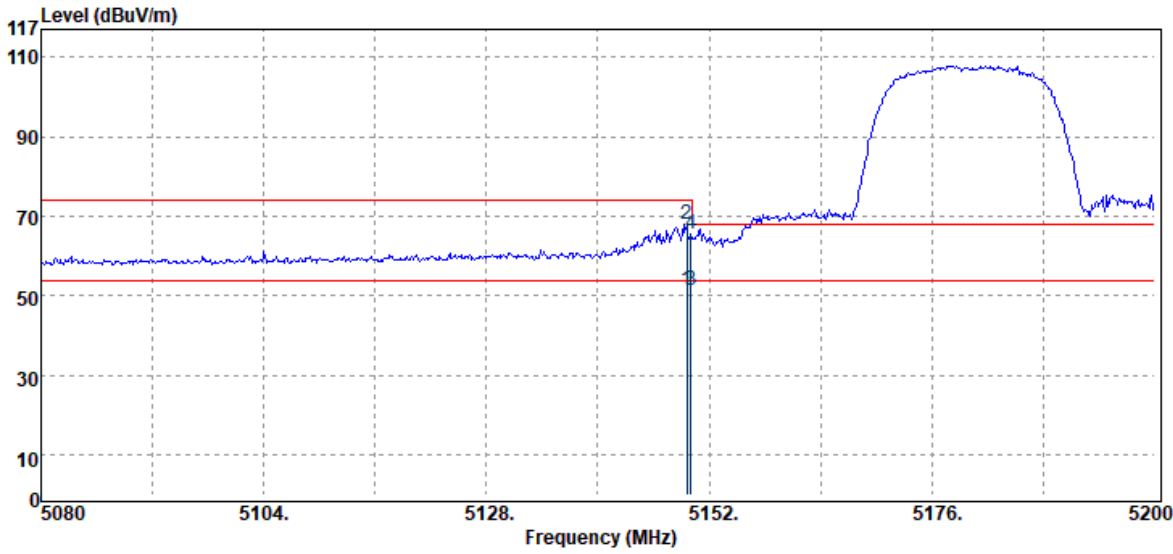

Freq. MHz	Detector Mode PK/QP/AV	Spectrum Reading Level dB μ V	Factor dB	Actual FS dB μ V/m	Limit @3m dB μ V/m	Margin dB
5149.60	Average	42.85	8.68	51.53	54.00	-2.47
5149.60	Peak	59.20	8.68	67.88	74.00	-6.12
5150.00	Average	42.71	8.68	51.39	54.00	-2.61
5150.00	Peak	56.78	8.68	65.46	74.00	-8.54

Unless otherwise stated the results shown in this test report refer only to the sample(s) tested and such sample(s) are retained for 90 days only.

除非另有說明，此報告結果僅對測試之樣品負責，同時此樣品僅保留90天。本報告未經本公司書面許可，不可部份複製。

This document is issued by the Company subject to its General Conditions of Service printed overleaf, available on request or accessible at <http://www.sgs.com.tw/Terms-and-Conditions> and for electronic format documents, subject to Terms and Conditions for Electronic Documents at <http://www.sgs.com.tw/Terms-and-Conditions>. Attention is drawn to the limitation of liability, indemnification and jurisdiction issues defined therein. Any holder of this document is advised that information contained hereon reflects the Company's findings at the time of its intervention only and within the limits of Client's instructions, if any. The Company's sole responsibility is to its Client and this document does not exonerate parties to a transaction from exercising all their rights and obligations under the transaction documents. This document cannot be reproduced except in full, without prior written approval of the Company. Any unauthorized alteration, forgery or falsification of the content or appearance of this document is unlawful and offenders may be prosecuted to the fullest extent of the law.

Report Number :ER-2020-80015
Operation Mode :802.11n20
Test Frequency :5180 MHz
Test Mode :Bandedge CH Low
EUT Pol :H Plane

Test Site :SAC III Chamber
Test Date :2020-08-07
Temp./Humi. :25.8/63
Antenna Pol. :HORIZONTAL
Engineer :Ricky

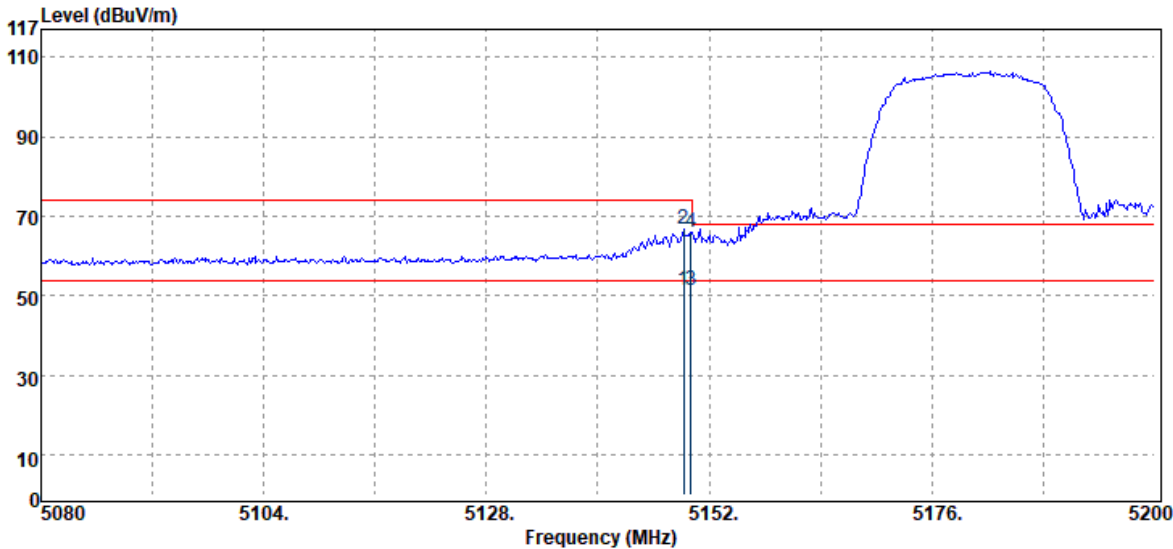

Freq. MHz	Detector Mode PK/QP/AV	Spectrum Reading Level dB μ V	Factor dB	Actual FS dB μ V/m	Limit @3m dB μ V/m	Margin dB
5149.24	Average	42.69	8.68	51.37	54.00	-2.63
5149.24	Peak	58.20	8.68	66.88	74.00	-7.12
5150.00	Average	42.93	8.68	51.61	54.00	-2.39
5150.00	Peak	57.19	8.68	65.87	74.00	-8.13

Unless otherwise stated the results shown in this test report refer only to the sample(s) tested and such sample(s) are retained for 90 days only.

除非另有說明，此報告結果僅對測試之樣品負責，同時此樣品僅保留90天。本報告未經本公司書面許可，不可部份複製。

This document is issued by the Company subject to its General Conditions of Service printed overleaf, available on request or accessible at <http://www.sgs.com.tw/Terms-and-Conditions> and for electronic format documents, subject to Terms and Conditions for Electronic Documents at <http://www.sgs.com.tw/Terms-and-Conditions>. Attention is drawn to the limitation of liability, indemnification and jurisdiction issues defined therein. Any holder of this document is advised that information contained hereon reflects the Company's findings at the time of its intervention only and within the limits of Client's instructions, if any. The Company's sole responsibility is to its Client and this document does not exonerate parties to a transaction from exercising all their rights and obligations under the transaction documents. This document cannot be reproduced except in full, without prior written approval of the Company. Any unauthorized alteration, forgery or falsification of the content or appearance of this document is unlawful and offenders may be prosecuted to the fullest extent of the law.

Report Number :ER-2020-80015
Operation Mode :802.11n20
Test Frequency :5320 MHz
Test Mode :Bandedge CH High
EUT Pol :H Plane

Test Site :SAC III Chamber
Test Date :2020-08-07
Temp./Humi. :25.8/63
Antenna Pol. :VERTICAL
Engineer :Ricky

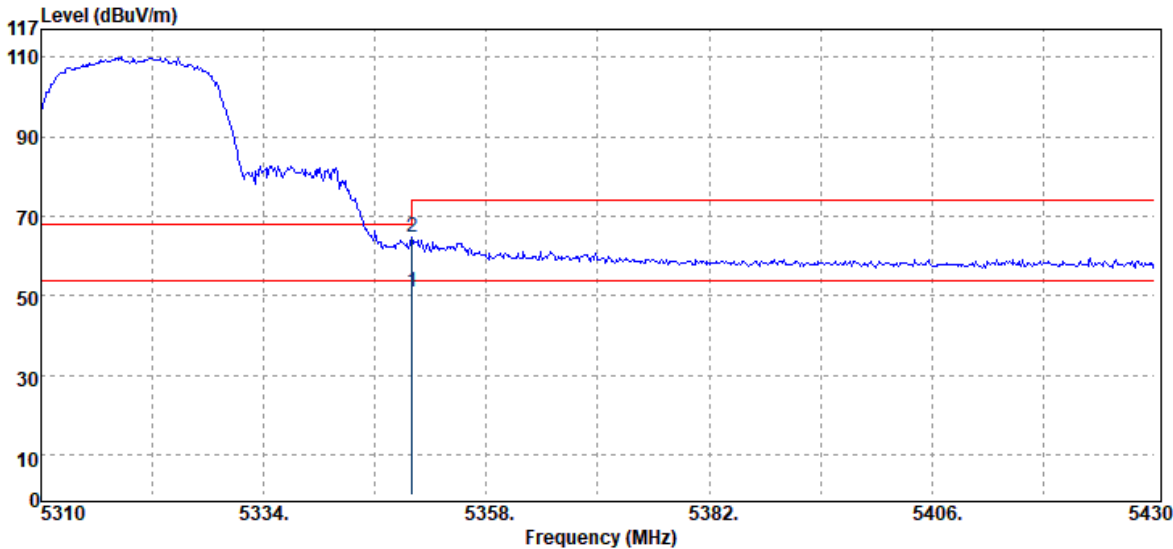

Freq. MHz	Detector Mode PK/QP/AV	Spectrum Reading Level dB μ V	Factor dB	Actual FS dB μ V/m	Limit @3m dB μ V/m	Margin dB
5350.00	Average	42.84	8.12	50.96	54.00	-3.04
5350.00	Peak	56.79	8.12	64.91	74.00	-9.09

Unless otherwise stated the results shown in this test report refer only to the sample(s) tested and such sample(s) are retained for 90 days only.

除非另有說明，此報告結果僅對測試之樣品負責，同時此樣品僅保留90天。本報告未經本公司書面許可，不可部份複製。

This document is issued by the Company subject to its General Conditions of Service printed overleaf, available on request or accessible at <http://www.sgs.com.tw/Terms-and-Conditions> and for electronic format documents, subject to Terms and Conditions for Electronic Documents at <http://www.sgs.com.tw/Terms-and-Conditions>. Attention is drawn to the limitation of liability, indemnification and jurisdiction issues defined therein. Any holder of this document is advised that information contained hereon reflects the Company's findings at the time of its intervention only and within the limits of Client's instructions, if any. The Company's sole responsibility is to its Client and this document does not exonerate parties to a transaction from exercising all their rights and obligations under the transaction documents. This document cannot be reproduced except in full, without prior written approval of the Company. Any unauthorized alteration, forgery or falsification of the content or appearance of this document is unlawful and offenders may be prosecuted to the fullest extent of the law.

Report Number :ER-2020-80015
 Operation Mode :802.11n20
 Test Frequency :5320 MHz
 Test Mode :Bandedge CH High
 EUT Pol :H Plane

Test Site :SAC III Chamber
 Test Date :2020-08-07
 Temp./Humi. :25.8/63
 Antenna Pol. :HORIZONTAL
 Engineer :Ricky

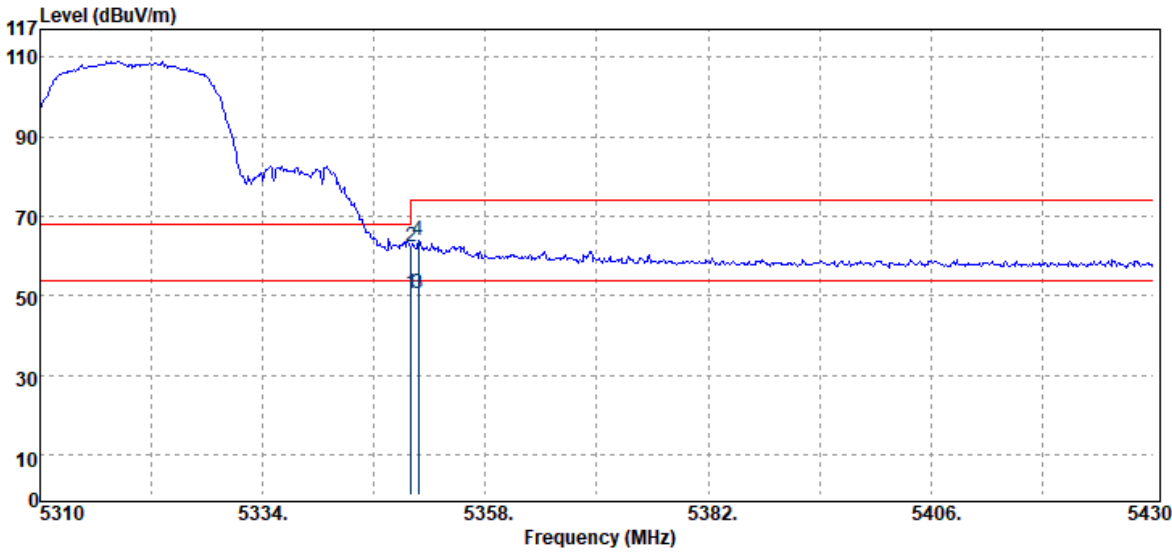

Freq. MHz	Detector Mode PK/QP/AV	Spectrum Reading Level dB μ V	Factor dB	Actual FS dB μ V/m	Limit @3m dB μ V/m	Margin dB
5350.00	Average	42.59	8.12	50.71	54.00	-3.29
5350.00	Peak	54.03	8.12	62.15	74.00	-11.85
5350.80	Average	42.58	8.12	50.70	54.00	-3.30
5350.80	Peak	55.93	8.12	64.05	74.00	-9.95

Unless otherwise stated the results shown in this test report refer only to the sample(s) tested and such sample(s) are retained for 90 days only.

除非另有說明，此報告結果僅對測試之樣品負責，同時此樣品僅保留90天。本報告未經本公司書面許可，不可部份複製。

This document is issued by the Company subject to its General Conditions of Service printed overleaf, available on request or accessible at <http://www.sgs.com.tw/Terms-and-Conditions> and for electronic format documents, subject to Terms and Conditions for Electronic Documents at <http://www.sgs.com.tw/Terms-and-Conditions>. Attention is drawn to the limitation of liability, indemnification and jurisdiction issues defined therein. Any holder of this document is advised that information contained hereon reflects the Company's findings at the time of its intervention only and within the limits of Client's instructions, if any. The Company's sole responsibility is to its Client and this document does not exonerate parties to a transaction from exercising all their rights and obligations under the transaction documents. This document cannot be reproduced except in full, without prior written approval of the Company. Any unauthorized alteration, forgery or falsification of the content or appearance of this document is unlawful and offenders may be prosecuted to the fullest extent of the law.

Report Number :ER-2020-80015
Operation Mode :802.11n20
Test Frequency :5500 MHz
Test Mode :Bandedge CH Low
EUT Pol :H Plane

Test Site :SAC III Chamber
Test Date :2020-08-07
Temp./Humi. :25.8/63
Antenna Pol. :VERTICAL
Engineer :Ricky

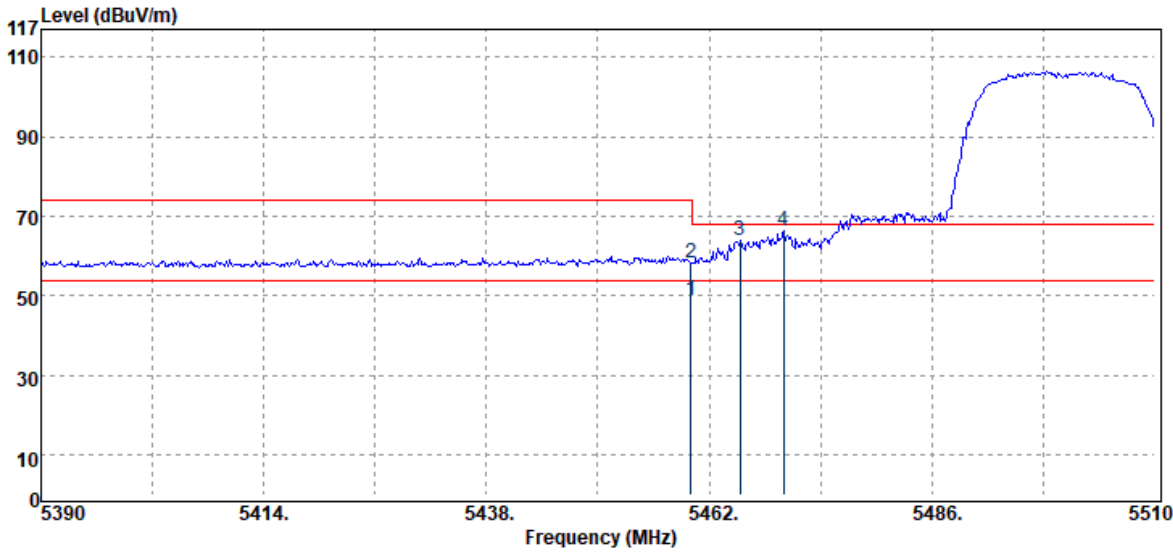

Freq. MHz	Detector Mode PK/QP/AV	Spectrum Reading Level dB μ V	Factor dB	Actual FS dB μ V/m	Limit @3m dB μ V/m	Margin dB
5460.00	Average	41.03	8.06	49.09	54.00	-4.91
5460.00	Peak	50.26	8.06	58.32	74.00	-15.68
5465.36	Peak	56.01	8.07	64.08	68.20	-4.12
5470.00	Peak	58.37	8.07	66.44	68.20	-1.76

Unless otherwise stated the results shown in this test report refer only to the sample(s) tested and such sample(s) are retained for 90 days only.

除非另有說明，此報告結果僅對測試之樣品負責，同時此樣品僅保留90天。本報告未經本公司書面許可，不可部份複製。

This document is issued by the Company subject to its General Conditions of Service printed overleaf, available on request or accessible at <http://www.sgs.com.tw/Terms-and-Conditions> and for electronic format documents, subject to Terms and Conditions for Electronic Documents at <http://www.sgs.com.tw/Terms-and-Conditions>. Attention is drawn to the limitation of liability, indemnification and jurisdiction issues defined therein. Any holder of this document is advised that information contained hereon reflects the Company's findings at the time of its intervention only and within the limits of Client's instructions, if any. The Company's sole responsibility is to its Client and this document does not exonerate parties to a transaction from exercising all their rights and obligations under the transaction documents. This document cannot be reproduced except in full, without prior written approval of the Company. Any unauthorized alteration, forgery or falsification of the content or appearance of this document is unlawful and offenders may be prosecuted to the fullest extent of the law.

Report Number :ER-2020-80015
Operation Mode :802.11n20
Test Frequency :5500 MHz
Test Mode :Bandedge CH Low
EUT Pol :H Plane

Test Site :SAC III Chamber
Test Date :2020-08-07
Temp./Humi. :25.8/63
Antenna Pol. :HORIZONTAL
Engineer :Ricky

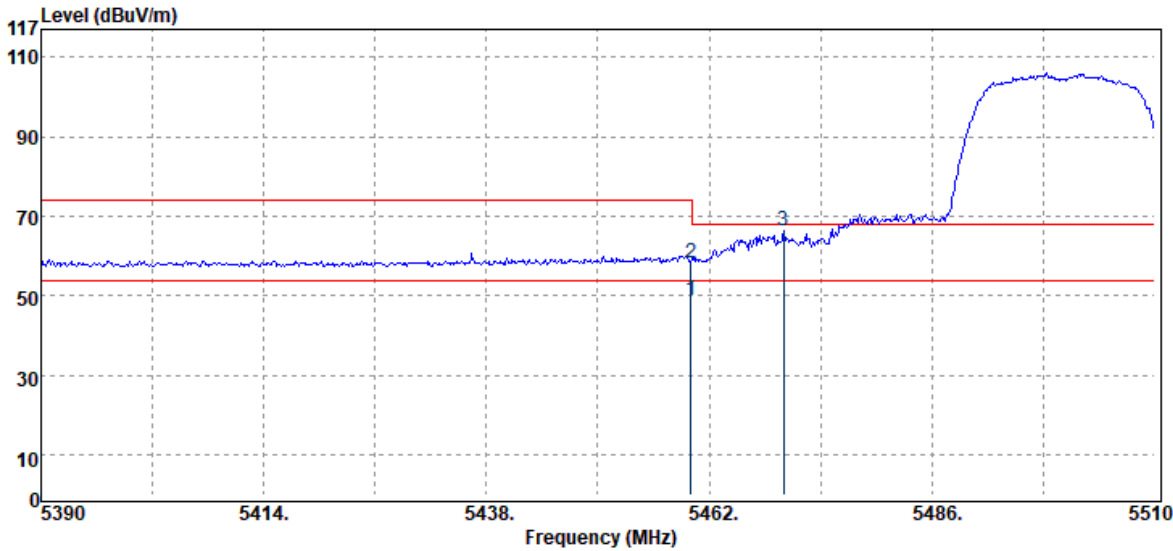

Freq. MHz	Detector Mode PK/QP/AV	Spectrum Reading Level dB μ V	Factor dB	Actual FS dB μ V/m	Limit @3m dB μ V/m	Margin dB
5460.00	Average	40.95	8.06	49.01	54.00	-4.99
5460.00	Peak	50.37	8.06	58.43	74.00	-15.57
5470.00	Peak	58.28	8.07	66.35	68.20	-1.85

Unless otherwise stated the results shown in this test report refer only to the sample(s) tested and such sample(s) are retained for 90 days only.

除非另有說明，此報告結果僅對測試之樣品負責，同時此樣品僅保留90天。本報告未經本公司書面許可，不可部份複製。

This document is issued by the Company subject to its General Conditions of Service printed overleaf, available on request or accessible at <http://www.sgs.com.tw/Terms-and-Conditions> and for electronic format documents, subject to Terms and Conditions for Electronic Documents at <http://www.sgs.com.tw/Terms-and-Conditions>. Attention is drawn to the limitation of liability, indemnification and jurisdiction issues defined therein. Any holder of this document is advised that information contained hereon reflects the Company's findings at the time of its intervention only and within the limits of Client's instructions, if any. The Company's sole responsibility is to its Client and this document does not exonerate parties to a transaction from exercising all their rights and obligations under the transaction documents. This document cannot be reproduced except in full, without prior written approval of the Company. Any unauthorized alteration, forgery or falsification of the content or appearance of this document is unlawful and offenders may be prosecuted to the fullest extent of the law.

Report Number	:ER-2020-80015	Test Site	:SAC III Chamber
Operation Mode	:802.11n20	Test Date	:2020-08-07
Test Frequency	:5700 MHz	Temp./Humi.	:25.8/63
Test Mode	:Bandedge CH High	Antenna Pol.	:VERTICAL
EUT Pol	:H Plane	Engineer	:Ricky

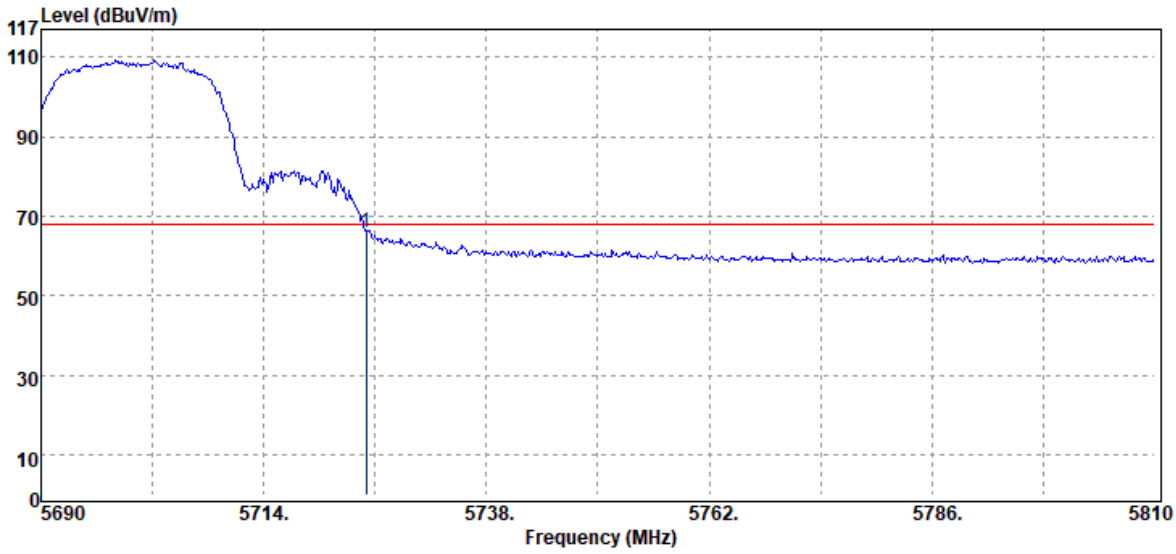

Freq. MHz	Detector Mode PK/QP/AV	Spectrum Reading Level dB μ V	Factor dB	Actual FS dB μ V/m	Limit @3m dB μ V/m	Margin dB
5725.00	Peak	57.38	8.81	66.19	68.20	-2.01

Unless otherwise stated the results shown in this test report refer only to the sample(s) tested and such sample(s) are retained for 90 days only.

除非另有說明，此報告結果僅對測試之樣品負責，同時此樣品僅保留90天。本報告未經本公司書面許可，不可部份複製。

This document is issued by the Company subject to its General Conditions of Service printed overleaf, available on request or accessible at <http://www.sgs.com.tw/Terms-and-Conditions> and for electronic format documents, subject to Terms and Conditions for Electronic Documents at <http://www.sgs.com.tw/Terms-and-Conditions>. Attention is drawn to the limitation of liability, indemnification and jurisdiction issues defined therein. Any holder of this document is advised that information contained hereon reflects the Company's findings at the time of its intervention only and within the limits of Client's instructions, if any. The Company's sole responsibility is to its Client and this document does not exonerate parties to a transaction from exercising all their rights and obligations under the transaction documents. This document cannot be reproduced except in full, without prior written approval of the Company. Any unauthorized alteration, forgery or falsification of the content or appearance of this document is unlawful and offenders may be prosecuted to the fullest extent of the law.

Report Number	:ER-2020-80015	Test Site	:SAC III Chamber
Operation Mode	:802.11n20	Test Date	:2020-08-07
Test Frequency	:5700 MHz	Temp./Humi.	:25.8/63
Test Mode	:Bandedge CH High	Antenna Pol.	:HORIZONTAL
EUT Pol	:H Plane	Engineer	:Ricky

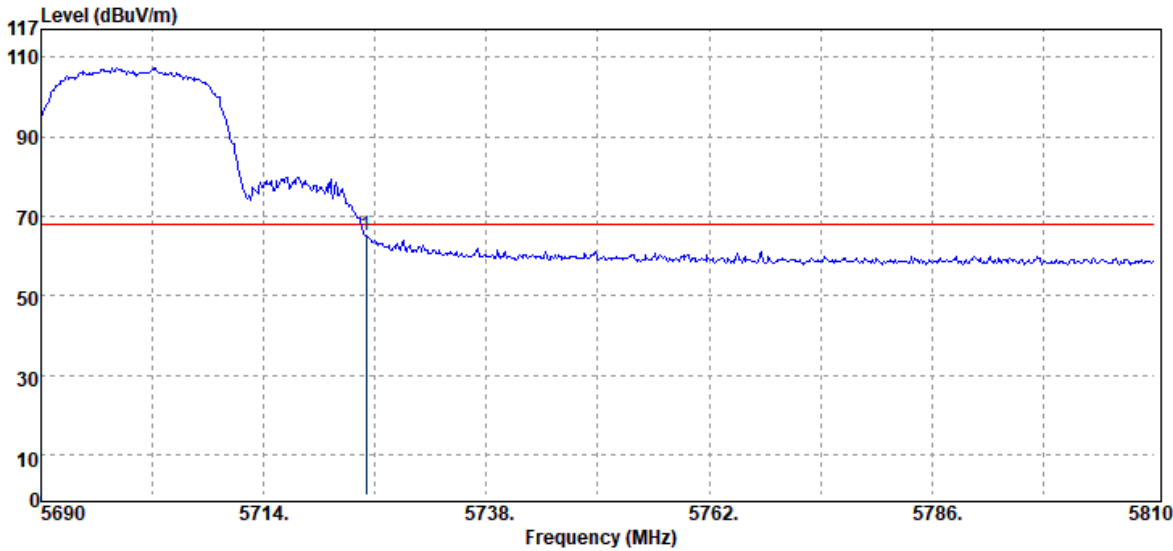

Freq. MHz	Detector Mode PK/QP/AV	Spectrum Reading Level d μ V	Factor dB	Actual FS d μ V/m	Limit @3m d μ V/m	Margin dB
5725.00	Peak	56.35	8.81	65.16	68.20	-3.04

Unless otherwise stated the results shown in this test report refer only to the sample(s) tested and such sample(s) are retained for 90 days only.

除非另有說明，此報告結果僅對測試之樣品負責，同時此樣品僅保留90天。本報告未經本公司書面許可，不可部份複製。

This document is issued by the Company subject to its General Conditions of Service printed overleaf, available on request or accessible at <http://www.sgs.com.tw/Terms-and-Conditions> and for electronic format documents, subject to Terms and Conditions for Electronic Documents at <http://www.sgs.com.tw/Terms-and-Conditions>. Attention is drawn to the limitation of liability, indemnification and jurisdiction issues defined therein. Any holder of this document is advised that information contained hereon reflects the Company's findings at the time of its intervention only and within the limits of Client's instructions, if any. The Company's sole responsibility is to its Client and this document does not exonerate parties to a transaction from exercising all their rights and obligations under the transaction documents. This document cannot be reproduced except in full, without prior written approval of the Company. Any unauthorized alteration, forgery or falsification of the content or appearance of this document is unlawful and offenders may be prosecuted to the fullest extent of the law.

Report Number :ER-2020-80015
 Operation Mode :802.11n20
 Test Frequency :5745 MHz
 Test Mode :Bandedge CH Low
 EUT Pol :H Plane

Test Site :SAC III Chamber
 Test Date :2020-08-07
 Temp./Humi. :25.8/63
 Antenna Pol. :VERTICAL
 Engineer :Ricky

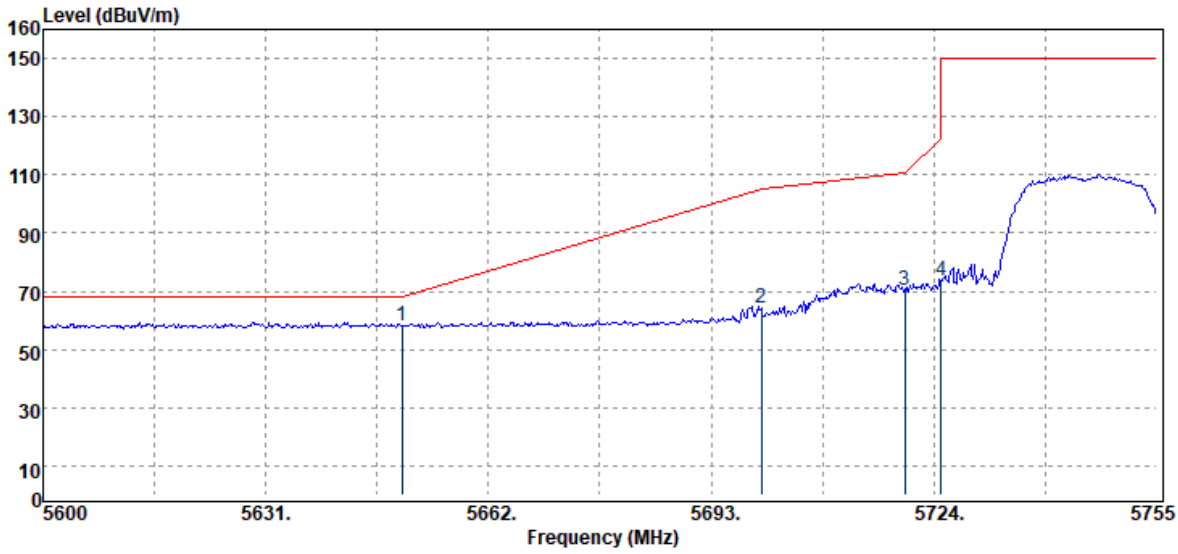

Freq. MHz	Detector Mode PK/QP/AV	Spectrum Reading Level dB μ V	Factor dB	Actual FS dB μ V/m	Limit @3m dB μ V/m	Margin dB
5650.00	Peak	49.58	8.32	57.90	68.20	-10.30
5700.00	Peak	55.40	8.69	64.09	105.20	-41.11
5720.00	Peak	61.70	8.78	70.48	110.80	-40.32
5725.00	Peak	64.94	8.81	73.75	122.20	-48.45

Unless otherwise stated the results shown in this test report refer only to the sample(s) tested and such sample(s) are retained for 90 days only.

除非另有說明，此報告結果僅對測試之樣品負責，同時此樣品僅保留90天。本報告未經本公司書面許可，不可部份複製。

This document is issued by the Company subject to its General Conditions of Service printed overleaf, available on request or accessible at <http://www.sgs.com.tw/Terms-and-Conditions> and for electronic format documents, subject to Terms and Conditions for Electronic Documents at <http://www.sgs.com.tw/Terms-and-Conditions>. Attention is drawn to the limitation of liability, indemnification and jurisdiction issues defined therein. Any holder of this document is advised that information contained hereon reflects the Company's findings at the time of its intervention only and within the limits of Client's instructions, if any. The Company's sole responsibility is to its Client and this document does not exonerate parties to a transaction from exercising all their rights and obligations under the transaction documents. This document cannot be reproduced except in full, without prior written approval of the Company. Any unauthorized alteration, forgery or falsification of the content or appearance of this document is unlawful and offenders may be prosecuted to the fullest extent of the law.

Report Number :ER-2020-80015
Operation Mode :802.11n20
Test Frequency :5745 MHz
Test Mode :Bandedge CH Low
EUT Pol :H Plane

Test Site :SAC III Chamber
Test Date :2020-08-07
Temp./Humi. :25.8/63
Antenna Pol. :HORIZONTAL
Engineer :Ricky

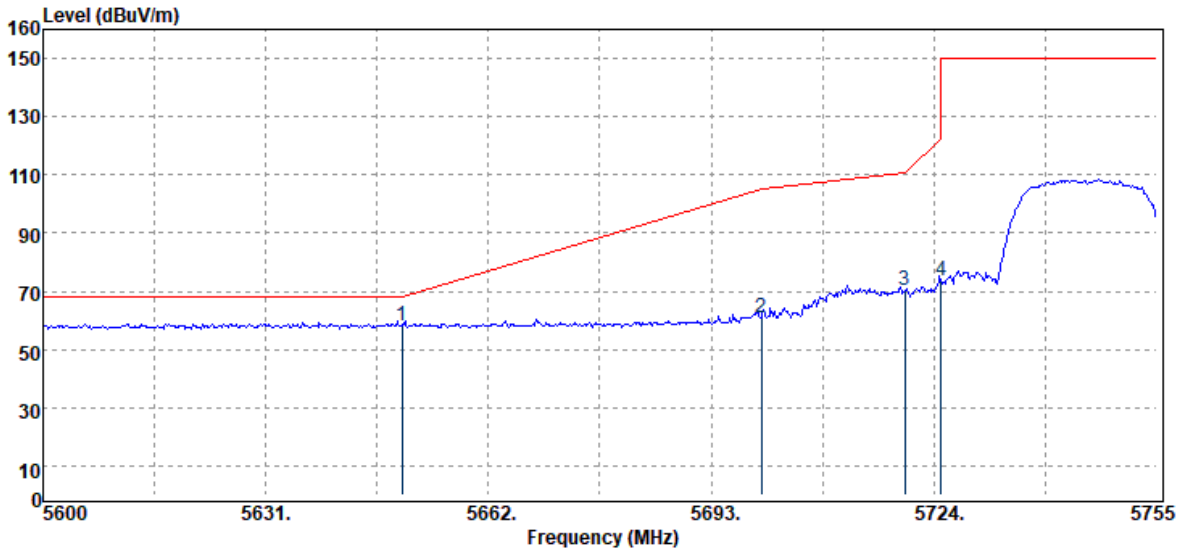

Freq. MHz	Detector Mode PK/QP/AV	Spectrum Reading Level dB μ V	Factor dB	Actual FS dB μ V/m	Limit @3m dB μ V/m	Margin dB
5650.00	Peak	49.60	8.32	57.92	68.20	-10.28
5700.00	Peak	52.06	8.69	60.75	105.20	-44.45
5720.00	Peak	61.57	8.78	70.35	110.80	-40.45
5725.00	Peak	65.07	8.81	73.88	122.20	-48.32

Unless otherwise stated the results shown in this test report refer only to the sample(s) tested and such sample(s) are retained for 90 days only.

除非另有說明，此報告結果僅對測試之樣品負責，同時此樣品僅保留90天。本報告未經本公司書面許可，不可部份複製。

This document is issued by the Company subject to its General Conditions of Service printed overleaf, available on request or accessible at <http://www.sgs.com.tw/Terms-and-Conditions> and for electronic format documents, subject to Terms and Conditions for Electronic Documents at <http://www.sgs.com.tw/Terms-and-Conditions>. Attention is drawn to the limitation of liability, indemnification and jurisdiction issues defined therein. Any holder of this document is advised that information contained hereon reflects the Company's findings at the time of its intervention only and within the limits of Client's instructions, if any. The Company's sole responsibility is to its Client and this document does not exonerate parties to a transaction from exercising all their rights and obligations under the transaction documents. This document cannot be reproduced except in full, without prior written approval of the Company. Any unauthorized alteration, forgery or falsification of the content or appearance of this document is unlawful and offenders may be prosecuted to the fullest extent of the law.

Report Number :ER-2020-80015
 Operation Mode :802.11n20
 Test Frequency :5825 MHz
 Test Mode :Bandedge CH High
 EUT Pol :H Plane

Test Site :SAC III Chamber
 Test Date :2020-08-07
 Temp./Humi. :25.8/63
 Antenna Pol. :VERTICAL
 Engineer :Ricky

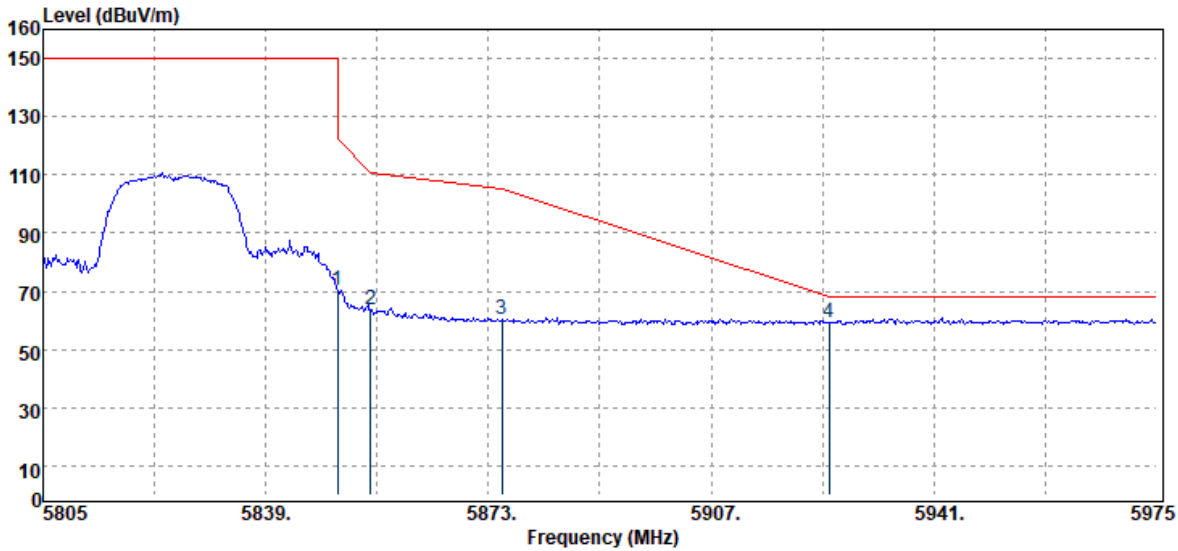

Freq. MHz	Detector Mode PK/QP/AV	Spectrum Reading Level dB μ V	Factor dB	Actual FS dB μ V/m	Limit @3m dB μ V/m	Margin dB
5850.00	Peak	60.89	9.42	70.31	122.20	-51.89
5855.00	Peak	54.25	9.44	63.69	110.80	-47.11
5875.00	Peak	50.91	9.50	60.41	105.20	-44.79
5925.00	Peak	49.75	9.65	59.40	68.20	-8.80

Unless otherwise stated the results shown in this test report refer only to the sample(s) tested and such sample(s) are retained for 90 days only.

除非另有說明，此報告結果僅對測試之樣品負責，同時此樣品僅保留90天。本報告未經本公司書面許可，不可部份複製。

This document is issued by the Company subject to its General Conditions of Service printed overleaf, available on request or accessible at <http://www.sgs.com.tw/Terms-and-Conditions> and for electronic format documents, subject to Terms and Conditions for Electronic Documents at <http://www.sgs.com.tw/Terms-and-Conditions>. Attention is drawn to the limitation of liability, indemnification and jurisdiction issues defined therein. Any holder of this document is advised that information contained hereon reflects the Company's findings at the time of its intervention only and within the limits of Client's instructions, if any. The Company's sole responsibility is to its Client and this document does not exonerate parties to a transaction from exercising all their rights and obligations under the transaction documents. This document cannot be reproduced except in full, without prior written approval of the Company. Any unauthorized alteration, forgery or falsification of the content or appearance of this document is unlawful and offenders may be prosecuted to the fullest extent of the law.

Report Number :ER-2020-80015
Operation Mode :802.11n20
Test Frequency :5825 MHz
Test Mode :Bandedge CH High
EUT Pol :H Plane

Test Site :SAC III Chamber
Test Date :2020-08-07
Temp./Humi. :25.8/63
Antenna Pol. :HORIZONTAL
Engineer :Ricky

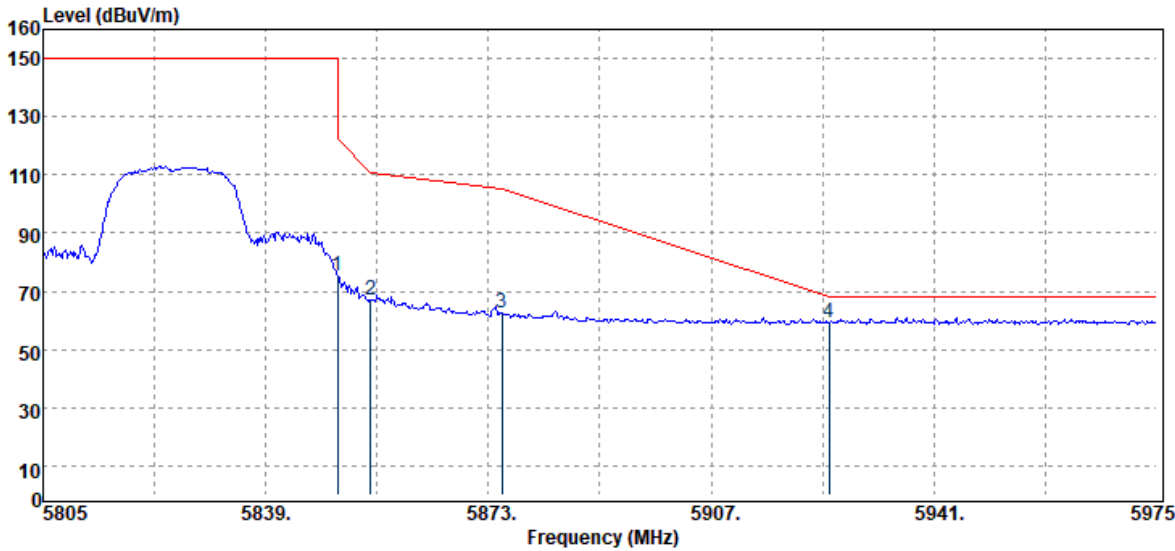

Freq. MHz	Detector Mode PK/QP/AV	Spectrum Reading Level d μ V	Factor dB	Actual FS d μ V/m	Limit @3m d μ V/m	Margin dB
5850.00	Peak	65.77	9.42	75.19	122.20	-47.01
5855.00	Peak	57.52	9.44	66.96	110.80	-43.84
5875.00	Peak	53.13	9.50	62.63	105.20	-42.57
5925.00	Peak	49.78	9.65	59.43	68.20	-8.77

Unless otherwise stated the results shown in this test report refer only to the sample(s) tested and such sample(s) are retained for 90 days only.

除非另有說明，此報告結果僅對測試之樣品負責，同時此樣品僅保留90天。本報告未經本公司書面許可，不可部份複製。

This document is issued by the Company subject to its General Conditions of Service printed overleaf, available on request or accessible at <http://www.sgs.com.tw/Terms-and-Conditions> and for electronic format documents, subject to Terms and Conditions for Electronic Documents at <http://www.sgs.com.tw/Terms-and-Conditions>. Attention is drawn to the limitation of liability, indemnification and jurisdiction issues defined therein. Any holder of this document is advised that information contained hereon reflects the Company's findings at the time of its intervention only and within the limits of Client's instructions, if any. The Company's sole responsibility is to its Client and this document does not exonerate parties to a transaction from exercising all their rights and obligations under the transaction documents. This document cannot be reproduced except in full, without prior written approval of the Company. Any unauthorized alteration, forgery or falsification of the content or appearance of this document is unlawful and offenders may be prosecuted to the fullest extent of the law.

12 TRANSMISSION IN THE ABSENCE OF DATA

12.1 Standard Applicable

According to §15.407(c)

The device shall automatically discontinue transmission in case of either absence of information to transmit or operational failure. These provisions are not intended to preclude the transmission of control or signaling information or the use of repetitive codes used by certain digital technologies to complete frame or burst intervals. Applicants shall include in their application for equipment authorization a description of how this requirement is met.

12.2 Result

While the EUT is not transmitting any information, the EUT can automatically discontinue transmission and become standby mode for power saving. The EUT can detect the controlling signal of ASK message transmitting from remote device and verify whether it shall resend or discontinue transmission.

Unless otherwise stated the results shown in this test report refer only to the sample(s) tested and such sample(s) are retained for 90 days only.

除非另有說明，此報告結果僅對測試之樣品負責，同時此樣品僅保留90天。本報告未經本公司書面許可，不可部份複製。

This document is issued by the Company subject to its General Conditions of Service printed overleaf, available on request or accessible at <http://www.sgs.com.tw/Terms-and-Conditions> and for electronic format documents, subject to Terms and Conditions for Electronic Documents at <http://www.sgs.com.tw/Terms-and-Conditions>. Attention is drawn to the limitation of liability, indemnification and jurisdiction issues defined therein. Any holder of this document is advised that information contained hereon reflects the Company's findings at the time of its intervention only and within the limits of Client's instructions, if any. The Company's sole responsibility is to its Client and this document does not exonerate parties to a transaction from exercising all their rights and obligations under the transaction documents. This document cannot be reproduced except in full, without prior written approval of the Company. Any unauthorized alteration, forgery or falsification of the content or appearance of this document is unlawful and offenders may be prosecuted to the fullest extent of the law.

13 FREQUENCY STABILITY

13.1 Standard Applicable

Manufacturers of U-NII devices are responsible for ensuring frequency stability such that an emission is maintained within the band of operation under all conditions of normal operation as specified in the user's manual.

13.2 Measurement Procedure

1. The EUT was placed inside temperature chamber and powered and powered by nominal DC voltage.
2. Set EUT as normal operation.
3. Turn the EUT on and couple its output to spectrum.
4. Turn the EUT off and set the chamber to the highest temperature specified.
5. Allow sufficient time (approximately 30 min) for the temperature of the chamber to stabilize, turn the EUT and measure the operating frequency.
6. Repeat step with the temperature chamber set to the lowest temperature.

13.3 Test SET-UP

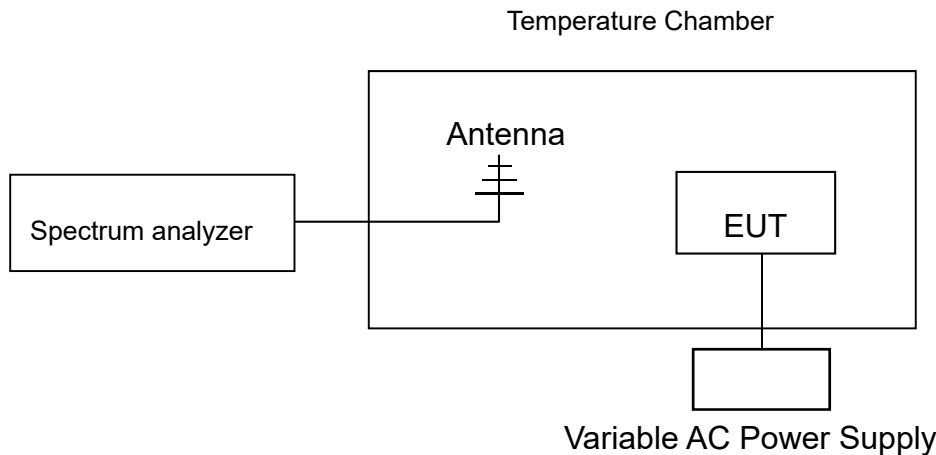

13.4 Measurement Equipment Used:

SGS Conducted Room					
Name of Equipment	Manufacturer	Model	Serial Number	Calibration Date	Calibration Due
PXA Spectrum Analyzer	Agilent	N9030A	MY53120760	04/21/2020	04/20/2021
DC Power Supply	Agilent	E3640A	MY40000811	12/23/2019	12/22/2020
Temperature Chamber	TERCHY	MHG-120LF	911009	05/20/2020	05/19/2021
Attenuator	Mini-Circuit	BW-S10W2+	2	01/02/2020	01/01/2021
DC Block	Mini-Circuits	BLK-18-S+	1	01/02/2020	01/01/2021

Unless otherwise stated the results shown in this test report refer only to the sample(s) tested and such sample(s) are retained for 90 days only.

除非另有說明，此報告結果僅對測試之樣品負責，同時此樣品僅保留90天。本報告未經本公司書面許可，不可部份複製。

This document is issued by the Company subject to its General Conditions of Service printed overleaf, available on request or accessible at <http://www.sgs.com.tw/Terms-and-Conditions> and for electronic format documents, subject to Terms and Conditions for Electronic Documents at <http://www.sgs.com.tw/Terms-and-Conditions>. Attention is drawn to the limitation of liability, indemnification and jurisdiction issues defined therein. Any holder of this document is advised that information contained hereon reflects the Company's findings at the time of its intervention only and within the limits of Client's instructions, if any. The Company's sole responsibility is to its Client and this document does not exonerate parties to a transaction from exercising all their rights and obligations under the transaction documents. This document cannot be reproduced except in full, without prior written approval of the Company. Any unauthorized alteration, forgery or falsification of the content or appearance of this document is unlawful and offenders may be prosecuted to the fullest extent of the law.

13.5 Measurement Result

Start up

Operation Mode	802.11 a	Test Date	2020/9/25
Temperature	:25.2 °C	Test By	Thomas Wei
Humidity	: 52%		

Test Temp.(°C)	Test Voltage(V)	Channel	Measured Frequency (MHz)	Spectrum Frequency (MHz)	ΔFrequency (MHz)
-20	5.5	36	5180	5,179.99104	0.00000173
	4.5	36	5180	5,180.00304	-0.00000059
25	5	36	5180	5,180.00835	-0.00000161
40	5.5	36	5180	5,180.00126	-0.00000024
	4.5	36	5180	5,179.99284	0.00000138

2 minutes

Operation Mode	802.11 a	Test Date	2020/9/25
Temperature	:25.2 °C	Test By	Thomas Wei
Humidity	: 52%		

Test Temp.(°C)	Test Voltage(V)	Channel	Measured Frequency (MHz)	Spectrum Frequency (MHz)	ΔFrequency (MHz)
-20	5.5	36	5180	5,180.00054	-0.00000010
	4.5	36	5180	5,179.97503	0.00000482
25	5	36	5180	5,179.99068	0.00000180
40	5.5	36	5180	5,180.01334	-0.00000257
	4.5	36	5180	5,180.00250	-0.00000048

Unless otherwise stated the results shown in this test report refer only to the sample(s) tested and such sample(s) are retained for 90 days only.

除非另有說明，此報告結果僅對測試之樣品負責，同時此樣品僅保留90天。本報告未經本公司書面許可，不可部份複製。

This document is issued by the Company subject to its General Conditions of Service printed overleaf, available on request or accessible at <http://www.sgs.com.tw/Terms-and-Conditions> and for electronic format documents, subject to Terms and Conditions for Electronic Documents at <http://www.sgs.com.tw/Terms-and-Conditions>. Attention is drawn to the limitation of liability, indemnification and jurisdiction issues defined therein. Any holder of this document is advised that information contained hereon reflects the Company's findings at the time of its intervention only and within the limits of Client's instructions, if any. The Company's sole responsibility is to its Client and this document does not exonerate parties to a transaction from exercising all their rights and obligations under the transaction documents. This document cannot be reproduced except in full, without prior written approval of the Company. Any unauthorized alteration, forgery or falsification of the content or appearance of this document is unlawful and offenders may be prosecuted to the fullest extent of the law.

5 minutes

Operation Mode	802.11 a	Test Date	2020/9/25
Temperature	:25.2 °C	Test By	Thomas Wei
Humidity	: 52%		

Test Temp.(°C)	Test Voltage(V)	Channel	Measured Frequency (MHz)	Spectrum Frequency (MHz)	ΔFrequency (MHz)
-20	5.5	36	5180	5,179.99144	0.00000165
	4.5	36	5180	5,179.98034	0.00000380
25	5	36	5180	5,179.99045	0.00000184
40	5.5	36	5180	5,180.00503	-0.00000097
	4.5	36	5180	5,180.00159	-0.00000031

10 minutes

Operation Mode	802.11 a	Test Date	2020/9/25
Temperature	:25.2 °C	Test By	Thomas Wei
Humidity	: 52%		

Test Temp.(°C)	Test Voltage(V)	Channel	Measured Frequency (MHz)	Spectrum Frequency (MHz)	ΔFrequency (MHz)
-20	5.5	36	5180	5,180.00016	-0.00000003
	4.5	36	5180	5,179.99156	0.00000163
25	5	36	5180	5,179.99003	0.00000193
40	5.5	36	5180	5,180.01089	-0.00000210
	4.5	36	5180	5,180.00131	-0.00000025

Unless otherwise stated the results shown in this test report refer only to the sample(s) tested and such sample(s) are retained for 90 days only.

除非另有說明，此報告結果僅對測試之樣品負責，同時此樣品僅保留90天。本報告未經本公司書面許可，不可部份複製。

This document is issued by the Company subject to its General Conditions of Service printed overleaf, available on request or accessible at <http://www.sgs.com.tw/Terms-and-Conditions> and for electronic format documents, subject to Terms and Conditions for Electronic Documents at <http://www.sgs.com.tw/Terms-and-Conditions>. Attention is drawn to the limitation of liability, indemnification and jurisdiction issues defined therein. Any holder of this document is advised that information contained hereon reflects the Company's findings at the time of its intervention only and within the limits of Client's instructions, if any. The Company's sole responsibility is to its Client and this document does not exonerate parties to a transaction from exercising all their rights and obligations under the transaction documents. This document cannot be reproduced except in full, without prior written approval of the Company. Any unauthorized alteration, forgery or falsification of the content or appearance of this document is unlawful and offenders may be prosecuted to the fullest extent of the law.

14 ANTENNA REQUIREMENT

14.1 Standard Applicable

According to §15.203, an intentional radiator shall be designed to ensure that no antenna other than furnished by the responsible party shall be used with the device.

According to §15.407, If transmitting antennas of directional gain greater than 6 dBi are used, both the maximum conducted output power and the maximum power spectral density shall be reduced by the amount in dB that the directional gain of the antenna exceeds 6 dBi.

14.2 Antenna Connected Construction

The antenna is designed as permanently attached and no consideration of replacement. Please see EUT photo for details.

~ End of Report ~

Unless otherwise stated the results shown in this test report refer only to the sample(s) tested and such sample(s) are retained for 90 days only.

除非另有說明，此報告結果僅對測試之樣品負責，同時此樣品僅保留90天。本報告未經本公司書面許可，不可部份複製。

This document is issued by the Company subject to its General Conditions of Service printed overleaf, available on request or accessible at <http://www.sgs.com.tw/Terms-and-Conditions> and for electronic format documents, subject to Terms and Conditions for Electronic Documents at <http://www.sgs.com.tw/Terms-and-Conditions>. Attention is drawn to the limitation of liability, indemnification and jurisdiction issues defined therein. Any holder of this document is advised that information contained hereon reflects the Company's findings at the time of its intervention only and within the limits of Client's instructions, if any. The Company's sole responsibility is to its Client and this document does not exonerate parties to a transaction from exercising all their rights and obligations under the transaction documents. This document cannot be reproduced except in full, without prior written approval of the Company. Any unauthorized alteration, forgery or falsification of the content or appearance of this document is unlawful and offenders may be prosecuted to the fullest extent of the law.