

# TEST REPORT

**Report Number. :** 15107843-E2V2

**Applicant :** Google LLC  
1600 Amphitheatre Parkway  
Mountain View, CA 94043 U.S.A.

**Model :** G2YBB

**FCC ID :** A4RG2YBB

**EUT Description :** PHONE

**Test Standard(s) :** FCC 47 CFR PART2, 22H, 24E, 27, 90S, 90R, AND 96

**Date Of Issue:**  
2024-05-13

**Prepared by:**  
UL Verification Services Inc.  
47173 Benicia Street  
Fremont, CA 94538, U.S.A.  
TEL: (510) 319-4000  
FAX: (510) 661-0888



Revision History

<u>Rev.</u>	<u>Issue Date</u>	<u>Revisions</u>	<u>Revised By</u>
V1	2024-05-09	Initial Review	--
V2	2024-05-13	Updated Section 6.3	Dan Corona

## TABLE OF CONTENTS

<b>1. ATTESTATION OF TEST RESULTS</b>	<b>9</b>
<b>2. SUMMARY OF TEST RESULTS</b>	<b>10</b>
<b>3. TEST METHODOLOGY</b>	<b>12</b>
<b>4. FACILITIES AND ACCREDITATION</b>	<b>12</b>
<b>5. DECISION RULES AND MEASUREMENT UNCERTAINTY</b>	<b>13</b>
5.1. METROLOGICAL TRACEABILITY	13
5.2. DECISION RULES	13
5.3. MEASUREMENT UNCERTAINTY	13
5.4. SAMPLE CALCULATION	13
<b>6. EQUIPMENT UNDER TEST</b>	<b>14</b>
6.1. DESCRIPTION OF EUT	14
6.2. MAXIMUM ANTENNA GAIN	14
6.3. MAXIMUM OUTPUT POWER	15
6.4. WORST-CASE CONFIGURATION AND MODE	28
6.5. DESCRIPTION OF TEST SETUP	30
<b>7. TEST AND MEASUREMENT EQUIPMENT</b>	<b>32</b>
<b>8. RF OUTPUT POWER MEASUREMENTS</b>	<b>33</b>
8.1. LTE BAND 5 AND 5G NR n5	34
8.2. LTE BAND 7 AND 5G NR n7	38
8.3. LTE BAND 12 AND 5G NR n12	45
8.4. LTE BAND 13	49
8.5. LTE BAND 14 AND 5G NR n14	50
8.6. LTE BAND 17	52
8.7. LTE BAND 25 AND 5G NR n25	53
8.8. LTE BAND 26 AND 5G NR 26 (Part 90S)	60
8.9. LTE BAND 26 AND 5G NR n26 (Part 22)	63
8.10. LTE BAND 30 AND 5G NR n30	68
8.11. LTE BAND 41 AND 5G NR n41	70
8.12. LTE BAND 41 AND 5G NR n41 HPUE	78
8.13. LTE BAND 48 AND 5G NR n48	86
8.14. LTE BAND 66 AND 5G NR n66	88
8.15. 5G NR n70	98

8.16. LTE BAND 71 AND 5G NR n71 ..... 100

8.17. 5G NR n77 (Part 27 3450-3550MHz)..... 104

8.18. 5G NR n77 ( Part 27 3450-3550MHz) HPUE ..... 110

8.19. 5G NR n77 (Part 27 3700-3980MHz)..... 116

8.20. 5G NR n77 (Part 27 3700-3980MHz) HPUE ..... 122

**9. CONDUCTED TEST RESULTS ..... 128**

9.1. OCCUPIED BANDWIDTH..... 128

9.1.1. LTE BAND 5 AND 5G NR n5..... 142

9.1.2. LTE BAND 7 AND 5G NR n7..... 144

9.1.3. LTE BAND 12 AND 5G NR n12..... 147

9.1.4. LTE BAND 13..... 149

9.1.5. LTE BAND 14 AND 5G NR n14..... 150

9.1.6. LTE BAND 17..... 152

9.1.7. LTE BAND 25 AND 5G NR n25..... 153

9.1.8. LTE BAND 26 AND 5G NR n26 (PART 90S)..... 156

9.1.9. LTE BAND 26 AND 5G NR n26 (PART 22) ..... 158

9.1.10. LTE BAND 30 AND 5G NR n30 ..... 160

9.1.11. LTE BAND 41 AND 5G NR n41 HPUE ..... 162

9.1.12. LTE BAND 48 AND 5G NR n48 ..... 166

9.1.13. LTE BAND 66 AND 5G NR n66 ..... 168

9.1.14. 5G NR n70..... 171

9.1.15. LTE BAND 71 AND 5G NR n71 ..... 172

9.1.16. 5G NR n77 (Part 27 3450-3550MHz) HPUE ..... 174

9.1.17. 5G NR n77 (Part 27 3700-3980MHz) HPUE ..... 177

9.2. EMISSION MASK AND ADJACENT CHANNEL POWER..... 180

9.2.1. LTE BAND 5 AND 5G NR n5..... 182

9.2.2. LTE BAND 7 AND 5G NR n7..... 189

9.2.3. LTE BAND 12 AND 5G NR n12..... 208

9.2.4. LTE BAND 13..... 220

9.2.5. LTE BAND 14 AND 5G NR n14..... 223

9.2.6. LTE BAND 17..... 227

9.2.7. LTE BAND 25 AND 5G NR n25..... 230

9.2.8. LTE BAND 26 AND 5G NR n26 (PART 90S)..... 241

9.2.9. LTE BAND 26 AND 5G NR n26 (PART 22) ..... 246

9.2.10. LTE BAND 30 AND 5G NR n30 ..... 253

9.2.11.	LTE BAND 41 AND 5G NR n41HPUE .....	260
9.2.12.	LTE BAND 48 AND 5G NR n48 .....	285
9.2.13.	LTE BAND 66 AND 5G NR n66 .....	314
9.2.14.	5G NR n70.....	324
9.2.15.	LTE BAND 71 AND 5G NR n71 .....	327
9.2.16.	5G NR n77 (Part 27 3450-3550MHz).....	340
9.2.17.	5G NR n77 (Part 27 3700-3980MHz) HPUE .....	358
9.3.	OUT OF BAND EMISSIONS .....	377
9.3.1.	LTE BAND 5 AND 5G NR n5.....	378
9.3.2.	LTE BAND 7 AND 5G NR n7.....	383
9.3.3.	LTE BAND 12 AND 5G NR n12.....	390
9.3.4.	LTE BAND 13.....	394
9.3.5.	LTE BAND 14 AND 5G NR n14.....	396
9.3.6.	LTE BAND 17.....	399
9.3.7.	LTE BAND 25 AND 5G NR n25.....	401
9.3.8.	LTE BAND 26 AND 5G NR n26 (PART 90S).....	409
9.3.9.	LTE BAND 26 AND 5G NR n26 (PART 22) .....	412
9.3.10.	LTE BAND 30 AND 5G NR n30 .....	417
9.3.11.	LTE BAND 41 AND 5G NR n41 HPUE .....	420
9.3.12.	LTE BAND 48 AND 5G NR n48 .....	429
9.3.13.	LTE BAND 66 AND 5G NR n66 .....	439
9.3.14.	5G NR n70.....	447
9.3.15.	LTE BAND 71 AND 5G NR n71 .....	449
9.3.16.	5G NR n77 (Part 27 3450-3550MHz) HPUE .....	454
9.3.17.	5G NR n77 (Part 27 3700-3980MHz) HPUE .....	460
9.4.	FREQUENCY STABILITY .....	467
9.4.1.	LTE BAND 5 AND 5G NR n5.....	468
9.4.2.	LTE BAND 7 AND 5G NR n7.....	470
9.4.3.	LTE BAND 12 AND 5G NR n12.....	472
9.4.4.	LTE BAND 13.....	474
9.4.5.	LTE BAND 14 AND 5G NR n14.....	475
9.4.6.	LTE BAND 17.....	477
9.4.7.	LTE BAND 25 AND 5G NR n25.....	478
9.4.8.	LTE BAND 26(PART 90S).....	480
9.4.9.	LTE BAND 26(PART 22) .....	482

9.4.10.	LTE BAND 30 AND 5G NR n30 .....	484
9.4.11.	LTE BAND 41 AND 5G NR n41 HPUE .....	486
9.4.12.	LTE BAND 48 AND 5G NR n48 .....	488
9.4.13.	LTE BAND 66 AND 5G NR n66 .....	490
9.4.14.	5G NR n70.....	492
9.4.15.	LTE BAND 71 AND 5G NR n71 .....	493
9.4.16.	5G NR n77 (Part 27 3450-3550MHz) HPUE .....	495
9.4.17.	5G NR n77 (Part 27 3700-3980MHz) HPUE .....	496
9.5.	PEAK-TO-AVERAGE POWER RATIO .....	497
9.5.1.	LTE BAND 5 AND 5G NR n5.....	498
9.5.2.	LTE BAND 7 AND 5G NR n7.....	501
9.5.3.	LTE BAND 12 AND 5G NR n12.....	506
9.5.4.	LTE BAND 13.....	509
9.5.5.	LTE BAND 14 AND 5G NR n14.....	510
9.5.6.	LTE BAND 17.....	512
9.5.7.	LTE BAND 25 AND 5G NR n25.....	513
9.5.8.	LTE BAND 26 AND 5G NR n26 (PART 90S).....	518
9.5.9.	LTE BAND 26 AND 5G NR n26 (PART 22).....	520
9.5.10.	LTE BAND 30 AND 5G NR n30 .....	523
9.5.11.	LTE BAND 41 AND 5G NR n41 HPUE .....	525
9.5.12.	LTE BAND 48 AND 5G NR n48 .....	526
9.5.13.	LTE BAND 66 AND 5G NR n66 .....	527
9.5.14.	5G NR n70.....	532
9.5.15.	LTE BAND 71 AND 5G NR n71 .....	533
9.5.16.	5G NR n77 (Part 27 3450-3550MHz) HPUE .....	536
9.5.17.	5G NR n77 (Part 27 3700-3980MHz) HPUE .....	537
<b>10.</b>	<b>RADIATED TEST RESULTS.....</b>	<b>538</b>
10.1.	FIELD STRENGTH OF SPURIOUS RADIATION, ANT 0 .....	541
10.1.1.	LTE BAND 5 AND 5G NR n5 .....	542
10.1.2.	LTE BAND 7 AND 5G NR n7 .....	545
10.1.3.	LTE BAND 12 AND 5G NR n12 .....	548
10.1.4.	LTE BAND 13 .....	551
10.1.5.	LTE BAND 14 AND 5G NR n14 .....	553
10.1.6.	LTE BAND 17 .....	555
10.1.7.	LTE BAND 25 AND 5G NR n25 .....	557

10.1.8.	LTE BAND 26 AND 5G NR n26 (PART 90S) .....	560
10.1.9.	LTE BAND 26 AND 5G NR n26 (PART 22).....	562
10.1.10.	LTE BAND 30 AND 5G NR n30 .....	564
10.1.11.	LTE BAND 41 AND 5G NR n41 HPUE .....	566
10.1.12.	LTE BAND 66 AND 5G NR n66 .....	568
10.1.13.	5G NR n70.....	571
10.1.14.	LTE BAND 71 AND 5G NR n71 .....	572
10.2.	FIELD STRENGTH OF SPURIOUS RADIATION, ANT 1 .....	575
10.2.1.	LTE BAND 5 AND 5G NR n5 .....	576
10.2.2.	LTE BAND 12 AND 5G NR n12 .....	579
10.2.3.	LTE BAND 13 .....	582
10.2.4.	LTE BAND 14 AND 5G NR n14 .....	584
10.2.5.	LTE BAND 17 .....	586
10.2.6.	LTE BAND 25 AND 5G NR n25 .....	588
10.2.7.	LTE BAND 26 AND 5G NR n26 (PART 90S) .....	591
10.2.8.	LTE BAND 26 AND 5G NR n26 (PART 22).....	592
10.2.9.	5G NR n41 HPUE .....	594
10.2.10.	5G NR n48.....	595
10.2.11.	LTE BAND 66 AND 5G NR n66 .....	597
10.2.12.	LTE BAND 71 AND 5G NR n71 .....	600
10.2.13.	5G NR n77 (Part 27 3450-3550MHz) HPUE .....	603
10.2.14.	5G NR n77 (Part 27 3700-3980MHz) HPUE .....	604
10.3.	FIELD STRENGTH OF SPURIOUS RADIATION, ANT 2 .....	605
10.3.1.	LTE BAND 7 AND 5G NR n7 .....	605
10.3.2.	LTE BAND 25 AND 5G NR n25 .....	608
10.3.3.	LTE BAND 30 AND 5G NR n30 .....	611
10.3.4.	LTE BAND 41 AND 5G NR n41 HPUE .....	613
10.3.5.	LTE BAND 66 AND 5G NR n66 .....	616
10.3.6.	5G NR n70.....	619
10.4.	FIELD STRENGTH OF SPURIOUS RADIATION, ANT 5 .....	620
10.4.1.	LTE BAND 25 AND 5G NR n25 .....	621
10.4.2.	5G NR n41 HPUE .....	624
10.4.3.	5G NR n48.....	626
10.4.4.	LTE BAND 66 AND 5G NR n66 .....	628
10.4.5.	5G NR n77 (Part 27 3450-3550MHz) HPUE .....	631

---

10.4.6.	5G NR n77 (Part 27 3700-3980MHz) HPUE .....	632
10.5.	FIELD STRENGTH OF SPURIOUS RADIATION, ANT 6 .....	634
10.5.1.	LTE BAND 48 AND 5G NR n48 .....	635
10.5.2.	5G NR n77 (Part 27 3450-3550MHz) HPUE .....	638
10.5.3.	5G NR n77 (Part 27 3700-3980MHz) HPUE .....	640
10.6.	FIELD STRENGTH OF SPURIOUS RADIATION, ANT 7 .....	642
10.6.1.	LTE BAND 48 AND 5G NR n48 (FCC).....	643
10.6.2.	5G NR n77 (Part 27 3450-3550MHz) HPUE .....	646
10.6.3.	5G NR n77 (Part 27 3700-3980MHz) HPUE .....	648
<b>11.</b>	<b>SETUP PHOTOS.....</b>	<b>650</b>





# 1. ATTESTATION OF TEST RESULTS

Applicant Name and Address	Google LLC 1600 Amphitheatre Parkway Mountain View, CA 94043 U.S.A.
Model	G2YBB
FCC ID	A4RG2YBB
EUT Description	Phone
Serial Number	Conducted: 41151FDAQ00063, 352207820041643, 41151FDAQ0006X and 41151FDAQ0000J Radiated: 41061FDAQ0009D, 3B091FDAQ000LC and 3B091FDAQ000BC
Sample Receipt Date	2023-12-11
Date Tested	2023-12-11 to 2024-05-06
Applicable Standards	FCC 47 CFR PART 2, 22H, 24E, 27, 90S, 90R, AND 96
Test Results	COMPLIES

UL Verification Services Inc. tested the above equipment in accordance with the requirements set forth in the above standards. The test results show that the equipment tested is capable of demonstrating compliance with the requirements as documented in this report.

The results documented in this report apply only to the tested sample, under the conditions and modes of operation as described herein. It is the manufacturer's responsibility to assure that additional production units of this model are manufactured with identical electrical and mechanical components. All samples tested were in good operating condition throughout the entire test program. Measurement Uncertainties are published for informational purposes only and were not taken into account unless noted otherwise.

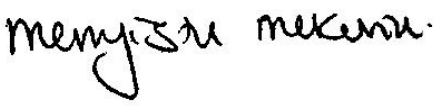
This document may not be altered or revised in any way unless done so by UL Verification Services Inc. and all revisions are duly noted in the revisions section. Any alteration of this document not carried out by UL Verification Services Inc. will constitute fraud and shall nullify the document.

		
Mengistu Mekuria Lab Staff Engineer UL Verification Services Inc.	Kiya Kedida Lead Project Engineer UL Verification Services Inc.	Glenn Escano Senior Test Engineer UL Verification Services Inc.

## 2. SUMMARY OF TEST RESULTS

This report contains data provided by the customer which can impact the validity of results. UL Verification Services Inc. is only responsible for the validity of results after the integration of the data provided by the customer.”

Below is a list of the data provided by the customer:

1. Antenna gain and type (see section 6.2)

Requirement Description	Band	Requirement Clause Number (FCC)	Result*	Remarks
RF Conducted Output Power	26 (90S)	2.1046 , 90.635 (b)	Compiles	
Effective Radiated Power	5,26	22.913 (a)(5)	Compiles	
	12	27.50 (c) (10)	Compiles	
	13	27.50 (b) (10)	Compiles	
	14	90.541 (d)	Compiles	
	17	27.50 (c) (10)	Compiles	
	71	27.50 (c) (10)	Compiles	
Equivalent Isotropic Radiated Power	2, 25	24.232 (c )	Compiles	
	4, 66	27.50 (d) (4)	Compiles	
	70	27.50 (d) (4)	Compiles	
	30	27.50 (a) (3)	Compiles	
	7, 41, 38	27.50 (h) (2)	Compiles	
	48	96.41 (b)	Compiles	
	77	96.41 (b), 27.50 (j) (3), (k) (3)	Compiles	

Requirement Description	Requirement Clause Number (FCC)	Result*	Remarks
Occupied Bandwidth	2.1049	Compiles	
Band Edge and Emission Mask	2.1051, 22.917 (a), 24.238 (a), 27.53 (h), 27.53 (m)(4) & (m) (6), 96.41(e) , 27.53 (g), 27.53 (c) (f), 27.53(a), 27.53(l), 90.543 (e)(f), 90.691 (a), 96.41(e)	Compiles	
Out of Band Emissions	2.1051, 22.917 (a), 24.238 (a), 27.53 (h), 27.53 (m)(4) & (m) (6), 96.41(e) , 27.53 (g), 27.53 (c) (f), 27.53(a), 27.53(l), 90.543 (e)(f), 90.691 (a), 96.41(e)	Compiles	
Frequency Stability	2.1055, 22.355, 24.235, 27.54, 90.539, 90.213	Compiles	
Peak-to-Average Ratio	22.913 (d), 24.232 (d), 27.50 (d) (5), 27.50 (j) (4), 96.41 (g)	Compiles	
Field Strength of Spurious Radiation	2.1053, 22.917 (a), 24.238 (a), 27.53 (h), 27.53 (m)(4) & (m) (6), 96.41(e) , 27.53 (g), 27.53 (c) (f), 27.53(a), 27.53(l), 90.543 (e)(f), 90.691 (a), 96.41(e)	Compiles	

### 3. TEST METHODOLOGY

The tests documented in this report were performed in accordance with the following:

- ANSI C63.26:2015
- FCC 47 CFR Part 2, Part 22, Part 24, Part 27, Part 90, and Part 96
- [FCC KDB 971168 D01 v03r01](#): Power Meas License Digital Systems
- [FCC KDB 971168 D02 v02r02](#): Misc Rev Approv License Devices
- [FCC KDB 412172 D01 v01r01](#): Determining ERP and EIRP

### 4. FACILITIES AND ACCREDITATION

UL Verification Services Inc. is accredited by A2LA, certification #0751.05, for all testing performed within the scope of this report. Testing was performed at the locations noted below.

	Address	ISED CABID	ISED Company Number	FCC Registration
<input type="checkbox"/>	Building 1: 47173 Benicia Street, Fremont, CA 94538, USA	US0104	2324A	550739
<input checked="" type="checkbox"/>	Building 2: 47266 Benicia Street, Fremont, CA 94538, USA			
<input type="checkbox"/>	Building 3: 843 Auburn Court, Fremont, CA 94538, USA			
<input checked="" type="checkbox"/>	Building 4: 47658 Kato Rd, Fremont, CA 94538, USA			
<input checked="" type="checkbox"/>	Building 5: 47670 Kato Rd, Fremont, CA 94538, USA			

## 5. DECISION RULES AND MEASUREMENT UNCERTAINTY

### 5.1. METROLOGICAL TRACEABILITY

All test and measuring equipment utilized to perform the tests documented in this report are calibrated on a regular basis, with a maximum time between calibrations of one year or the manufacturers' recommendation, whichever is less, and where applicable is traceable to recognized national standards.

### 5.2. DECISION RULES

The Decision Rule is based on Simple Acceptance in accordance with ISO Guide 98-4:2012 Clause 8.2. (Measurement uncertainty is not taken into account when stating conformity with a specified requirement.)

### 5.3. MEASUREMENT UNCERTAINTY

Where relevant, the following measurement uncertainty levels have been estimated for tests performed on the apparatus:

PARAMETER	U <sub>Lab</sub>
Conducted Antenna Port Emission Measurement	1.940 db
Power Spectral Density	2.466 db
Time Domain Measurements Using SA	3.39 %
RF Power Measurement Direct Method Using Power Meter	0.450 db Peak 1.300 db Ave.
Radio Frequency (Spectrum Analyzer)	141.16 Hz
Occupied Bandwidth	1.22%
Worst Case Conducted Disturbance, 9KHz to 0.15 MHz	3.78 db
Worst Case Conducted Disturbance, 0.15 to 30 MHz	3.40 db
Worst Case Radiated Disturbance, 9KHz to 30 MHz	2.87 db
Worst Case Radiated Disturbance, 30 to 1000 MHz	6.01 db
Worst Case Radiated Disturbance, 1000 to 18000 MHz	4.73 db
Worst Case Radiated Disturbance, 18000 to 26000 MHz	4.51 db
Worst Case Radiated Disturbance, 26000 to 40000 MHz	5.29 db

Uncertainty figures are valid to a confidence level of 95%.

### 5.4. SAMPLE CALCULATION

#### RADIATED EMISSIONS

Where relevant, the following sample calculation is provided:

$$\text{Field Strength (dBuV/m)} = \text{Measured Voltage (dBuV)} + \text{Antenna Factor (dB/m)} + \text{Cable Loss (dB)} - \text{Preamp Gain (dB)}$$

$$36.5 \text{ dBuV} + 18.7 \text{ dB/m} + 0.6 \text{ dB} - 26.9 \text{ dB} = 28.9 \text{ dBuV/m}$$

## 6. EQUIPMENT UNDER TEST

### 6.1. DESCRIPTION OF EUT

The EUT is a Phone.

### 6.2. MAXIMUM ANTENNA GAIN

The antenna(s) gain, as provided by the manufacturer' are as follows:

LTE and 5G NR Bands	Frequency Range (MHz)	ANT 0 Antenna Gain (dBi)	ANT 1 Antenna Gain (dBi)	ANT 2 Antenna Gain (dBi)	ANT 5 Antenna Gain (dBi)	ANT 6 Antenna Gain (dBi)	ANT 7 Antenna Gain (dBi)
LTE Band 2, 5G NR n2	1850 – 1910	1.9	-4.3	1.5	-2.2		
LTE Band 4	1710 – 1755	2.4	-5.2	1.6	-3.2		
LTE Band 5, 5G NR n5	824 – 849	-2.7	-2.2				
LTE Band 7, 5G NR n7	2500 – 2570	-0.1		1.4			
LTE Band 12, 5G NR n12	699 – 716	-1.9	-3.3				
LTE Band 13	777 – 787	-2.0	-3.3				
LTE Band 14, 5G NR n14	788 – 798	-2.2	-3.7				
LTE Band 17	704 – 716	-1.9	-3.3				
LTE Band 25, 5G NR n25	1850 – 1915	1.9	-4.3	1.5	-2.2		
LTE Band 26, 5G NR n26	814 – 849	-2.5	-2.3				
LTE Band 30, 5G NR n30	2305 – 2315	0.7		0.1			
LTE Band 38, 5G NR n38	2570 - 2620	-0.2	-3.0	1.0	-3.8		
LTE Band 41, 5G NR n41	2496 – 2690	-0.2	-3.0	1.0	-3.8		
LTE Band 48, 5G NR n48	3550 – 3700		-4.1		-3.8	0.6	-3.3
LTE Band 66, 5G NR n66	1710 – 1780	2.4	-5.2	1.6	-3.2		
5G NR n70	1695 – 1710	2.4		1.6			
LTE Band 71, 5G NR n71	663 – 698	-3.9	-4.1				
5G NR n77	3300 – 4200		-3.9		-5.5	3.0	-1.7
5G NR n78	3300 – 3800		-5.5		-4.4	3.0	-3.3

## 6.3. MAXIMUM OUTPUT POWER

### EIRP/ERP TEST PROCEDURE

ANSI C63.26:2015  
KDB 971168 D01 Section 5.6

$$\text{ERP/EIRP} = \text{PMeas} + \text{GT} - \text{LC}$$

where: ERP/EIRP = effective or equivalent radiated power, respectively (expressed in the same units as PMeas, typically dBW or dBm);

PMeas = measured transmitter output power or PSD, in dBm or dBW;

GT = gain of the transmitting antenna, in dBd (ERP) or dBi (EIRP);

LC = signal attenuation in the connecting cable between the transmitter and antenna, in dB.

For devices utilizing multiple antennas, KDB 662911 provides guidance for determining the effective array transmit antenna gain term to be used in the above equation.

EUT includes different power levels for head use configuration and body use configuration and the below tables contain the highest of all configurations average conducted and ERP/EIRP output powers as follows:

**LTE BAND 5**

Part 22H								
ERP Limit (W)		7.00						
Antenna Gain (dBi)		-2.70						
Bandwidth (MHz)	Modulation	Low Frequency (MHz)	Upper Frequency (MHz)	Conducted Average (dBm)	ERP Average (dBm)	ERP Average (W)	99% BW (kHz)	Emission Designator
1.4	QPSK	824.7	848.3	23.70	18.85	0.077	1093.7	1M09G7W
	16QAM			23.50	18.65	0.073	1088.2	1M09D7W
3.0	QPSK	825.5	847.5	23.70	18.85	0.077	2699.6	2M70G7W
	16QAM			23.60	18.75	0.075	2705.3	2M71D7W
5.0	QPSK	826.5	846.5	23.80	18.95	0.079	4502.6	4M50G7W
	16QAM			23.70	18.85	0.077	4493.4	4M49D7W
10.0	QPSK	829.0	844.0	24.30	19.45	0.088	8986.2	8M99G7W
	16QAM			23.90	19.05	0.080	9004.6	9M00D7W

**5G NR n5**

Part 22H								
ERP Limit (W)		7.00						
Antenna Gain (dBi)		-2.70						
Bandwidth (MHz)	Modulation	Low Frequency (MHz)	Upper Frequency (MHz)	Conducted Average (dBm)	ERP Average (dBm)	ERP Average (W)	99% BW (kHz)	Emission Designator
5.0	BPSK	826.5	846.5	24.40	19.55	0.090	4487.4	4M49G7W
	QPSK			24.40	19.55	0.090	4494.7	4M49G7W
	16QAM			23.30	18.45	0.070	4504.5	4M50D7W
10.0	BPSK	829.0	844.0	24.40	19.55	0.090	8975.6	8M98G7W
	QPSK			24.40	19.55	0.090	8950.9	8M95G7W
	16QAM			23.60	18.75	0.075	8968.7	8M97D7W
15.0	BPSK	831.5	841.5	24.40	19.55	0.090	13409	13M4G7W
	QPSK			24.40	19.55	0.090	13427	13M4G7W
	16QAM			23.40	18.55	0.072	13429	13M4D7W
20.0	BPSK	834.0	839.0	24.40	19.55	0.090	17846	17M8G7W
	QPSK			24.40	19.55	0.090	17865	17M9G7W
	16QAM			23.40	18.55	0.072	17832	17M8D7W

**LTE BAND 7**

Part 27								
EIRP Limit (W)		2.00						
Antenna Gain (dBi)		1.40						
Bandwidth (MHz)	Modulation	Low Frequency (MHz)	Upper Frequency (MHz)	Conducted Average (dBm)	EIRP Average (dBm)	EIRP Average (W)	99% BW (kHz)	Emission Designator
5.0	QPSK	2502.5	2567.5	24.20	25.60	0.363	4518.3	4M52G7W
	16QAM			23.70	25.10	0.324	4511.6	4M51D7W
10.0	QPSK	2505.0	2565.0	24.10	25.50	0.355	9015	9M02G7W
	16QAM			23.90	25.30	0.339	8993.3	8M99D7W
15.0	QPSK	2507.5	2562.5	24.10	25.50	0.355	13469	13M5G7W
	16QAM			23.80	25.20	0.331	13454	13M5D7W
20.0	QPSK	2510.0	2560.0	24.20	25.60	0.363	17980	18M0G7W
	16QAM			23.80	25.20	0.331	17905	17M9D7W



**5G NR n7**

Part 27								
EIRP Limit (W)		2.00						
Antenna Gain (dBi)		1.40						
Bandwidth (MHz)	Modulation	Low Frequency (MHz)	Upper Frequency (MHz)	Conducted Average (dBm)	EIRP Average (dBm)	EIRP Average (W)	99% BW (kHz)	Emission Designator
5.0	BPSK	2502.5	2567.5	24.50	25.90	0.389	4577.8	4M58G7W
	QPSK			24.50	25.90	0.389	4506.3	4M51G7W
	16QAM			23.60	25.00	0.316	4613.4	4M61D7W
10.0	BPSK	2505.0	2565.0	24.50	25.90	0.389	8986.7	8M99G7W
	QPSK			24.50	25.90	0.389	8984.9	8M98G7W
	16QAM			23.60	25.00	0.316	8979.9	8M98D7W
15.0	BPSK	2507.5	2562.5	24.60	26.00	0.398	13455	13M5G7W
	QPSK			24.50	25.90	0.389	13475	13M5G7W
	16QAM			23.60	25.00	0.316	13426	13M4D7W
20.0	BPSK	2510.0	2560.0	24.60	26.00	0.398	17962	18M0G7W
	QPSK			24.50	25.90	0.389	17919	17M9G7W
	16QAM			23.60	25.00	0.316	17972	18M0D7W
25.0	BPSK	2512.5	2557.5	24.60	26.00	0.398	22968	23M0G7W
	QPSK			24.50	25.90	0.389	22935	22M9G7W
	16QAM			23.80	25.20	0.331	22975	23M0D7W
30.0	BPSK	2515.0	2555.0	24.50	25.90	0.389	28740	28M7G7W
	QPSK			24.50	25.90	0.389	28660	28M7G7W
	16QAM			23.80	25.20	0.331	28801	28M8D7W
40.0	BPSK	2520.0	2550.0	24.50	25.90	0.389	38755	38M8G7W
	QPSK			24.50	25.90	0.389	38722	38M7G7W
	16QAM			23.80	25.20	0.331	38649	38M6D7W
50.0	BPSK	2525.0	2545.0	24.60	26.00	0.398	48300	48M3G7W
	QPSK			24.50	25.90	0.389	48225	48M2G7W
	16QAM			23.70	25.10	0.324	48205	48M2D7W

**LTE BAND 12**

Part 27								
ERP Limit (W)		3.00						
Antenna Gain (dBi)		-1.90						
Bandwidth (MHz)	Modulation	Low Frequency (MHz)	Upper Frequency (MHz)	Conducted Average (dBm)	ERP Average (dBm)	ERP Average (W)	99% BW (kHz)	Emission Designator
1.4	QPSK	699.7	715.3	24.20	20.15	0.104	1086.5	1M09G7W
	16QAM			23.70	19.65	0.092	1089.8	1M09D7W
3.0	QPSK	700.5	714.5	24.20	20.15	0.104	2703.1	2M70G7W
	16QAM			23.70	19.65	0.092	2701.8	2M70D7W
5.0	QPSK	701.5	713.5	24.10	20.05	0.101	4515.3	4M52G7W
	16QAM			23.70	19.65	0.092	4499.8	4M50D7W
10.0	QPSK	704.0	711.0	24.20	20.15	0.104	9011.9	9M01G7W
	16QAM			23.80	19.75	0.094	8983	8M98D7W

**5G NR n12**

Part 27								
ERP Limit (W)		3.00						
Antenna Gain (dBi)		-1.90						
Bandwidth (MHz)	Modulation	Low Frequency (MHz)	Upper Frequency (MHz)	Conducted Average (dBm)	ERP Average (dBm)	ERP Average (W)	99% BW (kHz)	Emission Designator
5.0	BPSK	701.5	713.5	24.40	20.35	0.108	4492.1	4M49G7W
	QPSK			24.40	20.35	0.108	4484.6	4M48G7W
	16QAM			23.50	19.45	0.088	4503.8	4M50D7W
10.0	BPSK	704.0	711.0	24.30	20.25	0.106	8966.5	8M97G7W
	QPSK			24.30	20.25	0.106	8974.7	8M97G7W
	16QAM			23.50	19.45	0.088	8951.3	8M95D7W
15.0	BPSK	706.5	708.5	24.40	20.35	0.108	13437	13M4G7W
	QPSK			24.30	20.25	0.106	13426	13M4G7W
	16QAM			23.70	19.65	0.092	13413	13M4D7W

**LTE BAND 13**

Part 27								
ERP Limit (W)		3.00						
Antenna Gain (dBi)		-2.00						
Bandwidth (MHz)	Modulation	Low Frequency (MHz)	Upper Frequency (MHz)	Conducted Average (dBm)	ERP Average (dBm)	ERP Average (W)	99% BW (kHz)	Emission Designator
5.0	QPSK	779.5	784.5	24.40	20.25	0.106	4503.7	4M50G7W
	16QAM			23.50	19.35	0.086	4504.9	4M50D7W
10.0	QPSK	782.0	782.0	24.50	20.35	0.108	8973.6	8M97G7W
	16QAM			23.40	19.25	0.084	8967	8M97D7W

**LTE BAND 14**

Part 90R								
ERP Limit (W)		3.00						
Antenna Gain (dBi)		-2.20						
Bandwidth (MHz)	Modulation	Low Frequency (MHz)	Upper Frequency (MHz)	Conducted Average (dBm)	ERP Average (dBm)	ERP Average (W)	99% BW (kHz)	Emission Designator
5.0	QPSK	790.5	795.5	24.50	20.15	0.104	4512.4	4M51G7W
	16QAM			24.00	19.65	0.092	4502.6	4M50D7W
10.0	QPSK	793.0	793.0	24.40	20.05	0.101	9004.2	9M00G7W
	16QAM			23.80	19.45	0.088	8982.2	8M98D7W

**5G NR n14**

Part 90R								
ERP Limit (W)		3.00						
Antenna Gain (dBi)		-2.20						
Bandwidth (MHz)	Modulation	Low Frequency (MHz)	Upper Frequency (MHz)	Conducted Average (dBm)	ERP Average (dBm)	ERP Average (W)	99% BW (kHz)	Emission Designator
5.0	BPSK	790.5	795.5	24.30	19.95	0.099	4497.2	4M50G7W
	QPSK			24.30	19.95	0.099	4496.8	4M50G7W
	16QAM			23.60	19.25	0.084	4507.4	4M51D7W
10.0	BPSK	793.0	793.0	24.30	19.95	0.099	8962.9	8M96G7W
	QPSK			24.20	19.85	0.097	8980.2	8M98G7W
	16QAM			23.30	18.95	0.079	8962.5	8M96D7W

**LTE BAND 17**

Part 27								
ERP Limit (W)		3.00						
Antenna Gain (dBi)		-1.90						
Bandwidth (MHz)	Modulation	Low Frequency (MHz)	Upper Frequency (MHz)	Conducted Average (dBm)	ERP Average (dBm)	ERP Average (W)	99% BW (kHz)	Emission Designator
5.0	QPSK	706.5	713.5	24.30	20.25	0.106	4528.1	4M53G7W
	16QAM			23.70	19.65	0.092	4523	4M52D7W
10.0	QPSK	709.0	711.0	24.30	20.25	0.106	9010.4	9M01G7W
	16QAM			23.70	19.65	0.092	9007	9M01D7W

**LTE BAND 25**

Part 24								
EIRP Limit (W)		2.00						
Antenna Gain (dBi)		1.90						
Bandwidth (MHz)	Modulation	Low Frequency (MHz)	Upper Frequency (MHz)	Conducted Average (dBm)	EIRP Average (dBm)	EIRP Average (W)	99% BW (kHz)	Emission Designator
1.4	QPSK	1850.7	1914.3	24.20	26.10	0.407	1089.5	1M09G7W
	16QAM			23.40	25.30	0.339	1093	1M09D7W
3.0	QPSK	1851.5	1913.5	24.30	26.20	0.417	2701.6	2M70G7W
	16QAM			23.50	25.40	0.347	2702.5	2M70D7W
5.0	QPSK	1852.5	1912.5	24.20	26.10	0.407	4519.1	4M52G7W
	16QAM			23.70	25.60	0.363	4516	4M52D7W
10.0	QPSK	1855.0	1910.0	24.40	26.30	0.427	9014.7	9M01G7W
	16QAM			23.60	25.50	0.355	9009.4	9M01D7W
15.0	QPSK	1857.5	1907.5	24.30	26.20	0.417	13488	13M5G7W
	16QAM			23.60	25.50	0.355	13467	13M5D7W
20.0	QPSK	1860.0	1905.0	24.50	26.40	0.437	17963	18M0G7W
	16QAM			23.80	25.70	0.372	17967	18M0D7W

**5G NR n25**

Part 24									
EIRP Limit (W)		2.00							
Antenna Gain (dBi)		1.90							
Bandwidth (MHz)	Modulation	Low Frequency (MHz)	Upper Frequency (MHz)	Conducted Average (dBm)	EIRP Average (dBm)	EIRP Average (W)	99% BW (kHz)	Emission Designator	
5.0	BPSK	1852.5	1912.5	24.30	26.20	0.417	4590.3	4M59G7W	
	QPSK			24.30	26.20	0.417	4503	4M50G7W	
	16QAM			23.30	25.20	0.331	4586.5	4M59D7W	
10.0	BPSK	1855.0	1910.0	24.30	26.20	0.417	8972.4	8M97G7W	
	QPSK			24.30	26.20	0.417	8974.7	8M97G7W	
	16QAM			23.40	25.30	0.339	8970	8M97D7W	
15.0	BPSK	1857.5	1907.5	24.30	26.20	0.417	13460	13M5G7W	
	QPSK			24.20	26.10	0.407	13448	13M4G7W	
	16QAM			23.40	25.30	0.339	13445	13M4D7W	
20.0	BPSK	1860.0	1905.0	24.30	26.20	0.417	17915	17M9G7W	
	QPSK			24.30	26.20	0.417	17907	17M9G7W	
	16QAM			23.30	25.20	0.331	17914	17M9D7W	
25.0	BPSK	1862.5	1902.5	24.50	26.40	0.437	22950	23M0G7W	
	QPSK			24.50	26.40	0.437	22933	22M9G7W	
	16QAM			23.70	25.60	0.363	22895	22M9D7W	
30.0	BPSK	1865.0	1900.0	24.60	26.50	0.447	28693	28M7G7W	
	QPSK			24.50	26.40	0.437	28663	28M7G7W	
	16QAM			23.60	25.50	0.355	28614	28M6D7W	
35.0	BPSK	1867.5	1897.5	24.50	26.40	0.437	32262	32M3G7W	
	QPSK			24.50	26.40	0.437	32249	32M2G7W	
	16QAM			23.60	25.50	0.355	32323	32M3D7W	
40.0	BPSK	1870.0	1895.0	24.60	26.50	0.447	38731	38M7G7W	
	QPSK			24.60	26.50	0.447	38624	38M6G7W	
	16QAM			23.90	25.80	0.380	38740	38M7D7W	

**LTE BAND 26 (Part 90S)**

Part 90S									
Conducted Limit (W)		100.00							
Antenna Gain (dBi)		-2.50							
Bandwidth (MHz)	Modulation	Low Frequency (MHz)	Upper Frequency (MHz)	Conducted Average (dBm)	Conducted Average (W)	ERP Average (dBm)	ERP Average (W)	99% BW (kHz)	Emission Designator
1.4	QPSK	814.7	823.3	25.00	0.32	20.35	0.108	1092.1	1M09G7W
	16QAM			24.10	0.26	19.45	0.088	1093.9	1M09D7W
3.0	QPSK	815.5	822.5	25.00	0.32	20.35	0.108	2703.8	2M70G7W
	16QAM			24.10	0.26	19.45	0.088	2701.3	2M70D7W
5.0	QPSK	816.5	821.5	24.70	0.30	20.05	0.101	4504.9	4M50G7W
	16QAM			23.90	0.25	19.25	0.084	4512.3	4M51D7W
10.0	QPSK	819.0	819.0	24.70	0.30	20.05	0.101	8991.5	8M99G7W
	16QAM			23.90	0.25	19.25	0.084	9001.8	9M00D7W

**5G NR n26 (Part 90S)**

Part 90S									
Conducted Limit (W)		100.00							
Antenna Gain (dBi)		-2.50							
Bandwidth (MHz)	Modulation	Low Frequency (MHz)	Upper Frequency (MHz)	Conducted Average (dBm)	Conducted Average (W)	ERP Average (dBm)	ERP Average (W)	99% BW (kHz)	Emission Designator
5.0	BPSK	816.5	821.5	24.40	0.28	19.75	0.094	4497.5	4M50G7W
	QPSK			24.30	0.27	19.65	0.092	4502.6	4M50G7W
	16QAM			23.50	0.22	18.85	0.077	4495.5	4M50D7W
10.0	BPSK	819.0	819.0	24.30	0.27	19.65	0.092	8969.4	8M97G7W
	QPSK			24.30	0.27	19.65	0.092	8980.5	8M98G7W
	16QAM			23.20	0.21	18.55	0.072	8957.6	8M96D7W

**LTE BAND 26 (Part 22)**

Part 22								
ERP Limit (W)		7.00						
Antenna Gain (dBi)		-2.50						
Bandwidth (MHz)	Modulation	Low Frequency (MHz)	Upper Frequency (MHz)	Conducted Average (dBm)	ERP Average (dBm)	ERP Average (W)	99% BW (kHz)	Emission Designator
1.4	QPSK	824.7	848.3	24.50	19.85	0.097	1087.5	1M09G7W
	16QAM			23.80	19.15	0.082	1087.7	1M09D7W
3.0	QPSK	825.5	847.5	24.50	19.85	0.097	2710.5	2M71G7W
	16QAM			23.70	19.05	0.080	2702.4	2M70D7W
5.0	QPSK	826.5	846.5	24.50	19.85	0.097	4498	4M50G7W
	16QAM			23.90	19.25	0.084	4500.7	4M50D7W
10.0	QPSK	829.0	844.0	24.50	19.85	0.097	8989.5	8M99G7W
	16QAM			23.90	19.25	0.084	8982.8	8M98D7W
15.0	QPSK	831.5	841.5	24.40	19.75	0.094	13422	13M4G7W
	16QAM			23.50	18.85	0.077	13433	13M4D7W

**5G NR n26 (Part 22)**

Part 22								
ERP Limit (W)		7.00						
Antenna Gain (dBi)		-2.50						
Bandwidth (MHz)	Modulation	Low Frequency (MHz)	Upper Frequency (MHz)	Conducted Average (dBm)	ERP Average (dBm)	ERP Average (W)	99% BW (kHz)	Emission Designator
5.0	BPSK	826.5	846.5	24.40	19.75	0.094	4499.6	4M50G7W
	QPSK			24.40	19.75	0.094	4490.6	4M49G7W
	16QAM			23.50	18.85	0.077	4500.9	4M50D7W
10.0	BPSK	829.0	844.0	24.40	19.75	0.094	8962.3	8M96G7W
	QPSK			24.40	19.75	0.094	8962.4	8M96G7W
	16QAM			23.60	18.95	0.079	8985.8	8M99D7W
15.0	BPSK	831.5	841.5	24.40	19.75	0.094	13433	13M4G7W
	QPSK			24.40	19.75	0.094	13405	13M4G7W
	16QAM			23.40	18.75	0.075	13416	13M4D7W
20.0	BPSK	834.0	839.0	24.30	19.65	0.092	17920	17M9G7W
	QPSK			24.30	19.65	0.092	17897	17M9G7W
	16QAM			23.40	18.75	0.075	17890	17M9D7W

**LTE BAND 30**

Part 27								
EIRP Limit (W)		0.25						
Antenna Gain (dBi)		0.10						
Bandwidth (MHz)	Modulation	Low Frequency (MHz)	Upper Frequency (MHz)	Conducted Average (dBm)	EIRP Average (dBm)	EIRP Average (W)	99% BW (kHz)	Emission Designator
5.0	QPSK	2307.5	2312.5	23.80	23.90	0.245	4511.8	4M51G7W
	16QAM			23.30	23.40	0.219	4510.8	4M51D7W
10.0	QPSK	2310.0	2310.0	23.70	23.80	0.240	9011.5	9M01G7W
	16QAM			23.30	23.40	0.219	8993.5	8M99D7W

**5G NR n30**

Part 27								
EIRP Limit (W)		0.25						
Antenna Gain (dBi)		0.10						
Bandwidth (MHz)	Modulation	Low Frequency (MHz)	Upper Frequency (MHz)	Conducted Average (dBm)	EIRP Average (dBm)	EIRP Average (W)	99% BW (kHz)	Emission Designator
5.0	BPSK	2307.5	2312.5	23.70	23.80	0.240	4498.7	4M50G7W
	QPSK			23.70	23.80	0.240	4493.8	4M49G7W
	16QAM			23.40	23.50	0.224	4503.8	4M50D7W
10.0	BPSK	2310.0	2310.0	23.70	23.80	0.240	8967.9	8M97G7W
	QPSK			23.70	23.80	0.240	8976.9	8M98G7W
	16QAM			23.10	23.20	0.209	8991.6	8M99D7W

**LTE BAND 41 HPUE**

Part 27								
EIRP Limit (W)		2.00						
Antenna Gain (dBi)		1.00						
Bandwidth (MHz)	Modulation	Low Frequency (MHz)	Upper Frequency (MHz)	Conducted Average (dBm)	EIRP Average (dBm)	EIRP Average (W)	99% BW (kHz)	Emission Designator
5.0	QPSK	2498.5	2687.5	25.90	26.90	0.490	45065	45M1G7W
	16QAM			25.30	26.30	0.427	4502	4M50D7W
10.0	QPSK	2501.0	2685.0	25.90	26.90	0.490	8988.9	8M99G7W
	16QAM			25.00	26.00	0.398	8992.1	8M99D7W
15.0	QPSK	2503.5	2682.5	25.90	26.90	0.490	13450	13M5G7W
	16QAM			25.10	26.10	0.407	13450	13M5D7W
20.0	QPSK	2506.0	2680.0	25.90	26.90	0.490	17908	17M9G7W
	16QAM			24.90	25.90	0.389	17962	18M0D7W

**5G NR n41 HPUE**

Part 27								
EIRP Limit (W)		2.00						
Antenna Gain (dBi)		1.00						
Bandwidth (MHz)	Modulation	Low Frequency (MHz)	Upper Frequency (MHz)	Conducted Average (dBm)	EIRP Average (dBm)	EIRP Average (W)	99% BW (kHz)	Emission Designator
10.0	BPSK	2501.0	2685.0	25.90	26.90	0.490	8664.8	8M66G7W
	QPSK			25.90	26.90	0.490	8668.1	8M67G7W
	16QAM			25.30	26.30	0.427	8680.3	8M68D7W
15.0	BPSK	2503.5	2682.5	25.90	26.90	0.490	12922	12M9G7W
	QPSK			25.90	26.90	0.490	12933	12M9G7W
	16QAM			25.20	26.20	0.417	12907	12M9D7W
20.0	BPSK	2506.0	2680.0	25.90	26.90	0.490	17926	17M9G7W
	QPSK			25.90	26.90	0.490	17889	17M9G7W
	16QAM			24.90	25.90	0.389	17873	17M9D7W
25.0	BPSK	2508.5	2682.5	26.30	27.30	0.537	22981	23M0G7W
	QPSK			26.40	27.40	0.550	22974	23M0G7W
	16QAM			24.00	25.00	0.316	22924	22M9D7W
30.0	BPSK	2511.0	2675.0	25.90	26.90	0.490	26960	27M0G7W
	QPSK			25.90	26.90	0.490	26937	26M9G7W
	16QAM			25.50	26.50	0.447	26892	26M9D7W
40.0	BPSK	2516.0	2670.0	25.90	26.90	0.490	35856	35M9G7W
	QPSK			25.90	26.90	0.490	35799	35M8G7W
	16QAM			25.10	26.10	0.407	35765	35M8D7W
50.0	BPSK	2521.0	2665.0	25.90	26.90	0.490	45782	45M8G7W
	QPSK			25.90	26.90	0.490	45771	45M8G7W
	16QAM			25.30	26.30	0.427	45678	45M7D7W
60.0	BPSK	2526.0	2660.0	25.90	26.90	0.490	58026	58M0G7W
	QPSK			25.80	26.80	0.479	57957	58M0G7W
	16QAM			25.00	26.00	0.398	57955	58M0D7W
70.0	BPSK	2531.0	2655.0	25.90	26.90	0.490	64486	64M5G7W
	QPSK			25.90	26.90	0.490	64580	64M6G7W
	16QAM			24.90	25.90	0.389	64501	64M5D7W
80.0	BPSK	2536.0	2650.0	25.90	26.90	0.490	77398	77M4G7W
	QPSK			25.90	26.90	0.490	77476	77M5G7W
	16QAM			25.20	26.20	0.417	77454	77M5D7W
90.0	BPSK	2541.0	2645.0	25.90	26.90	0.490	87125	87M1G7W
	QPSK			25.90	26.90	0.490	87144	87M1G7W
	16QAM			25.30	26.30	0.427	87074	87M1D7W
100.0	BPSK	2546.0	2640.0	25.90	26.90	0.490	96785	96M8G7W
	QPSK			25.90	26.90	0.490	96612	96M6G7W
	16QAM			25.20	26.20	0.417	96523	96M5D7W

**LTE BAND 48**

Part 96								
EIRP Limit (W)/ 10MHz		0.20						
Antenna Gain (dBi)		0.60						
Bandwidth (MHz)	Modulation	Low Frequency (MHz)	Upper Frequency (MHz)	Conducted Average (dBm)	EIRP Average (dBm)	EIRP Average (W)	99% BW (kHz)	Emission Designator
5.0	QPSK	3552.5	3697.5	21.60	22.20	0.166	4489.7	4M49G7W
	16QAM			21.60	22.20	0.166	4488.4	4M49D7W
10.0	QPSK	3555.0	3695.0	21.70	22.30	0.170	8975.8	8M98G7W
	16QAM			21.70	22.30	0.170	9022	9M02D7W
15.0	QPSK	3557.5	3692.5	21.80	22.40	0.174	13427	13M4G7W
	16QAM			21.80	22.40	0.174	13406	13M4D7W
20.0	QPSK	3560.0	3690.0	22.10	22.70	0.186	17902	17M9G7W
	16QAM			22.00	22.60	0.182	17931	17M9D7W

**5G NR n48**

Part 96								
EIRP Limit (W)		0.20						
Antenna Gain (dBi)		0.60						
Bandwidth (MHz)	Modulation	Low Frequency (MHz)	Upper Frequency (MHz)	Conducted Average (dBm)	EIRP Average (dBm)	EIRP Average (W)	99% BW (kHz)	Emission Designator
10.0	BPSK	3555.0	3695.0	22.00	22.60	0.182	8604.4	8M60G7W
	QPSK			22.00	22.60	0.182	8631.8	8M63G7W
	16QAM			21.80	22.40	0.174	8593.4	8M59D7W
15.0	BPSK	3557.5	3692.5	22.00	22.60	0.182	12869	12M9G7W
	QPSK			21.90	22.50	0.178	12828	12M8G7W
	16QAM			21.90	22.50	0.178	12954	13M0D7W
20.0	BPSK	3560.0	3690.0	21.90	22.50	0.178	17795	17M8G7W
	QPSK			21.90	22.50	0.178	17898	17M9G7W
	16QAM			21.60	22.20	0.166	17910	17M9D7W
30.0	BPSK	3565.0	3685.0	21.90	22.50	0.178	26795	26M8G7W
	QPSK			21.90	22.50	0.178	26827	26M8G7W
	16QAM			21.80	22.40	0.174	26895	26M9D7W
40.0	BPSK	3570.0	3680.0	22.00	22.60	0.182	35681	35M7G7W
	QPSK			21.90	22.50	0.178	35695	35M7G7W
	16QAM			21.80	22.40	0.174	35737	35M7D7W

**LTE BAND 66**

Part 27								
EIRP Limit (W)		1.00						
Antenna Gain (dBi)		2.40						
Bandwidth (MHz)	Modulation	Low Frequency (MHz)	Upper Frequency (MHz)	Conducted Average (dBm)	EIRP Average (dBm)	EIRP Average (W)	99% BW (kHz)	Emission Designator
1.4	QPSK	1710.7	1779.3	23.80	26.20	0.417	1088.4	1M09G7W
	16QAM			23.00	25.40	0.347	1090.6	1M09D7W
3.0	QPSK	1711.5	1778.5	23.80	26.20	0.417	2687.8	2M69G7W
	16QAM			23.00	25.40	0.347	2698.7	2M70D7W
5.0	QPSK	1712.5	1777.5	23.60	26.00	0.398	4501.7	4M50G7W
	16QAM			23.00	25.40	0.347	4499.5	4M50D7W
10.0	QPSK	1715.0	1775.0	23.70	26.10	0.407	8994.3	8M99G7W
	16QAM			23.00	25.40	0.347	8978.3	8M98D7W
15.0	QPSK	1717.5	1772.5	23.70	26.10	0.407	13453	13M5G7W
	16QAM			23.00	25.40	0.347	13480	13M5D7W
20.0	QPSK	1720.0	1770.0	23.70	26.10	0.407	17928	17M9G7W
	16QAM			23.00	25.40	0.347	17913	17M9D7W



**5G NR n66**

Part 27								
EIRP Limit (W)		1.00						
Antenna Gain (dBi)		2.40						
Bandwidth (MHz)	Modulation	Low Frequency (MHz)	Upper Frequency (MHz)	Conducted Average (dBm)	EIRP Average (dBm)	EIRP Average (W)	99% BW (kHz)	Emission Designator
5.0	BPSK	1712.5	1777.5	23.80	26.20	0.417	4501.5	4M50G7W
	QPSK			23.80	26.20	0.417	4503.1	4M50G7W
	16QAM			23.00	25.40	0.347	4513.5	4M51D7W
10.0	BPSK	1715.0	1775.0	23.80	26.20	0.417	8981.6	8M98G7W
	QPSK			23.80	26.20	0.417	8993.4	8M99G7W
	16QAM			23.00	25.40	0.347	8961.7	8M96D7W
15.0	BPSK	1717.5	1772.5	23.80	26.20	0.417	13470	13M5G7W
	QPSK			23.80	26.20	0.417	13452	13M5G7W
	16QAM			22.90	25.30	0.339	13441	13M4D7W
20.0	BPSK	1720.0	1770.0	23.80	26.20	0.417	17896	17M9G7W
	QPSK			23.80	26.20	0.417	17904	17M9G7W
	16QAM			23.10	25.50	0.355	17857	17M9D7W
25.0	BPSK	1722.5	1767.5	23.80	26.20	0.417	22951	23M0G7W
	QPSK			23.80	26.20	0.417	22952	23M0G7W
	16QAM			23.30	25.70	0.372	23029	23M0D7W
30.0	BPSK	1725.0	1765.0	23.80	26.20	0.417	28688	28M7G7W
	QPSK			23.70	26.10	0.407	28714	28M7G7W
	16QAM			23.00	25.40	0.347	28718	28M7D7W
40.0	BPSK	1730.0	1760.0	23.80	26.20	0.417	38698	38M7G7W
	QPSK			23.80	26.20	0.417	38735	38M7G7W
	16QAM			23.50	25.90	0.389	38647	38M6D7W

**5G NR n70**

Part 27								
EIRP Limit (W)		1.00						
Antenna Gain (dBi)		2.40						
Bandwidth (MHz)	Modulation	Low Frequency (MHz)	Upper Frequency (MHz)	Conducted Average (dBm)	EIRP Average (dBm)	EIRP Average (W)	99% BW (kHz)	Emission Designator
5.0	BPSK	1697.5	1707.5	23.90	26.30	0.427	4491.1	4M49G7W
	QPSK			23.80	26.20	0.417	4504.9	4M50G7W
	16QAM			23.00	25.40	0.347	4496.5	4M50D7W
10.0	BPSK	1700.0	1705.0	23.90	26.30	0.427	8983.4	8M98G7W
	QPSK			23.80	26.20	0.417	8987.3	8M99G7W
	16QAM			22.90	25.30	0.339	8989.3	8M99D7W
15.0	BPSK	1702.5	1702.5	23.80	26.20	0.417	13442	13M4G7W
	QPSK			23.80	26.20	0.417	13422	13M4G7W
	16QAM			22.80	25.20	0.331	13405	13M4D7W

**LTE BAND 71**

Part 27								
ERP Limit (W)		3.00						
Antenna Gain (dBi)		-3.90						
Bandwidth (MHz)	Modulation	Low Frequency (MHz)	Upper Frequency (MHz)	Conducted Average (dBm)	ERP Average (dBm)	ERP Average (W)	99% BW (kHz)	Emission Designator
5.0	QPSK	665.5	695.5	24.40	18.35	0.068	4511.4	4M51G7W
	16QAM			23.80	17.75	0.060	4511.5	4M51D7W
10.0	QPSK	668.0	693.0	24.90	18.85	0.077	8983.2	8M98G7W
	16QAM			23.90	17.85	0.061	8997.3	9M00D7W
15.0	QPSK	670.5	690.5	24.90	18.85	0.077	13479	13M5G7W
	16QAM			24.00	17.95	0.062	13447	13M4D7W
20.0	QPSK	673.0	688.0	24.80	18.75	0.075	17905	17M9G7W
	16QAM			24.10	18.05	0.064	17905	17M9D7W

**5G NR n71**

Part 27								
ERP Limit (W)		3.00						
Antenna Gain (dBi)_Ant(1)		-3.90						
Bandwidth (MHz)	Modulation	Low Frequency (MHz)	Upper Frequency (MHz)	Conducted Average (dBm)	ERP Average (dBm)	ERP Average (W)	99% BW (kHz)	Emission Designator
5.0	BPSK	665.5	695.5	24.70	18.65	0.073	4482.7	4M48G7W
	QPSK			24.70	18.65	0.073	4507.6	4M51G7W
	16QAM			23.70	17.65	0.058	4479.1	4M48D7W
10.0	BPSK	668.0	693.0	24.70	18.65	0.073	8956.1	8M96G7W
	QPSK			24.70	18.65	0.073	8997.4	9M00G7W
	16QAM			23.80	17.75	0.060	8949.7	8M95D7W
15.0	BPSK	670.5	690.5	24.70	18.65	0.073	13467	13M5D7W
	QPSK			24.70	18.65	0.073	13438	13M4D7W
	16QAM			23.70	17.65	0.058	13450	13M5D7W
20.0	BPSK	673.0	688.0	24.70	18.65	0.073	17907	17M9G7W
	QPSK			24.70	18.65	0.073	17863	17M9G7W
	16QAM			23.70	17.65	0.058	17861	17M9D7W

**5G NR n77 (Part 27 3450-3550MHz) HPUE**

Part 27								
EIRP Limit (W)		1.00						
Antenna Gain (dBi)		3.00						
Bandwidth (MHz)	Modulation	Low Frequency (MHz)	Upper Frequency (MHz)	Conducted Average (dBm)	EIRP Average (dBm)	EIRP Average (W)	99% BW (kHz)	Emission Designator
10.0	BPSK	3455.0	3545.0	26.10	29.10	0.813	8679	8M68G7W
	QPSK			26.10	29.10	0.813	8637.1	8M64G7W
	16QAM			25.00	28.00	0.631	8639	8M64D7W
15.0	BPSK	3457.5	3542.5	26.20	29.20	0.832	12925	12M9G7W
	QPSK			26.20	29.20	0.832	12903	12M9G7W
	16QAM			25.20	28.20	0.661	12924	12M9D7W
20.0	BPSK	3460.0	3540.0	26.30	29.30	0.851	17957	18M0G7W
	QPSK			26.20	29.20	0.832	17879	17M9G7W
	16QAM			25.00	28.00	0.631	17937	17M9D7W
25.0	BPSK	3462.5	3537.5	26.20	29.20	0.832	22982	23M0G7W
	QPSK			26.10	29.10	0.813	23014	23M0G7W
	16QAM			25.00	28.00	0.631	23092	23M1D7W
30.0	BPSK	3465.0	3535.0	26.30	29.30	0.851	26883	26M9G7W
	QPSK			26.30	29.30	0.851	26860	26M9G7W
	16QAM			25.20	28.20	0.661	26905	26M9D7W
40.0	BPSK	3470.0	3530.0	26.30	29.30	0.851	35769	35M8G7W
	QPSK			26.30	29.30	0.851	35816	35M8G7W
	16QAM			25.20	28.20	0.661	35819	35M8D7W
50.0	BPSK	3475.0	3525.0	26.30	29.30	0.851	45874	45M9G7W
	QPSK			26.30	29.30	0.851	45850	45M9G7W
	16QAM			25.30	28.30	0.676	45756	45M8D7W
60.0	BPSK	3480.0	3520.0	26.30	29.30	0.851	58008	58M0G7W
	QPSK			26.30	29.30	0.851	57990	58M0G7W
	16QAM			25.30	28.30	0.676	58014	58M0D7W
70.0	BPSK	3485.0	3515.0	26.40	29.40	0.871	64487	64M5G7W
	QPSK			26.20	29.20	0.832	64474	64M5G7W
	16QAM			25.20	28.20	0.661	64411	64M4D7W
80.0	BPSK	3490.0	3510.0	26.40	29.40	0.871	77476	77M5G7W
	QPSK			26.40	29.40	0.871	77354	77M4G7W
	16QAM			25.20	28.20	0.661	77163	77M2D7W
90.0	BPSK	3495.0	3505.0	26.40	29.40	0.871	85868	85M9G7W
	QPSK			26.40	29.40	0.871	85825	85M8G7W
	16QAM			25.20	28.20	0.661	85634	85M6D7W
100.0	BPSK	3500.0	3500.0	26.30	29.30	0.851	96681	96M7G7W
	QPSK			26.30	29.30	0.851	96767	96M8G7W
	16QAM			25.30	28.30	0.676	96709	96M7D7W

**5G NR n77 (Part 27 3700-3980MHz) HPUE**

Part 27										
EIRP Limit (W)		1.00								
Antenna Gain (dBi)		3.00								
Bandwidth (MHz)	Modulation	Low Frequency (MHz)	Upper Frequency (MHz)	Conducted Average (dBm)	EIRP Average (dBm)	EIRP Average (W)	99% BW (kHz)	Emission Designator		
10.0	BPSK	3705.0	3975.0	26.20	29.20	0.832	8556.9	8M56G7W		
	QPSK			26.20	29.20	0.832	8637.1	8M64G7W		
	16QAM			25.20	28.20	0.661	8633.4	8M63D7W		
15.0	BPSK	3707.5	3972.5	26.30	29.30	0.851	12808	12M8G7W		
	QPSK			26.30	29.30	0.851	12895	12M9G7W		
	16QAM			25.20	28.20	0.661	12822	12M8D7W		
20.0	BPSK	3710.0	3970.0	26.20	29.20	0.832	17894	17M9G7W		
	QPSK			26.20	29.20	0.832	17842	17M8G7W		
	16QAM			25.10	28.10	0.646	17793	17M8D7W		
25.0	BPSK	3712.5	3967.5	26.10	29.10	0.813	22946	22M9G7W		
	QPSK			26.10	29.10	0.813	22951	22M0G7W		
	16QAM			25.00	28.00	0.631	22862	22M9D7W		
30.0	BPSK	3715.0	3965.0	26.30	29.30	0.851	26703	26M7G7W		
	QPSK			26.20	29.20	0.832	26745	26M7G7W		
	16QAM			25.20	28.20	0.661	26805	26M8D7W		
40.0	BPSK	3720.0	3960.0	26.30	29.30	0.851	35817	35M8G7W		
	QPSK			26.30	29.30	0.851	35881	35M9G7W		
	16QAM			25.20	28.20	0.661	35459	35M5D7W		
50.0	BPSK	3725.0	3955.0	26.10	29.10	0.813	45839	45M8G7W		
	QPSK			26.10	29.10	0.813	45692	45M7G7W		
	16QAM			24.90	27.90	0.617	45810	45M8D7W		
60.0	BPSK	3730.0	3950.0	26.20	29.20	0.832	57435	57M4G7W		
	QPSK			26.20	29.20	0.832	57684	57M7G7W		
	16QAM			25.00	28.00	0.631	57913	57M9D7W		
70.0	BPSK	3735.0	3945.0	26.30	29.30	0.851	64083	64M1G7W		
	QPSK			26.20	29.20	0.832	64437	64M4G7W		
	16QAM			25.10	28.10	0.646	64443	64M4D7W		
80.0	BPSK	3740.0	3940.0	26.30	29.30	0.851	77131	77M1G7W		
	QPSK			26.20	29.20	0.832	77092	77M1G7W		
	16QAM			25.10	28.10	0.646	76849	76M8D7W		
90.0	BPSK	3745.0	3935.0	26.20	29.20	0.832	87056	87M1G7W		
	QPSK			26.20	29.20	0.832	86563	86M6G7W		
	16QAM			25.00	28.00	0.631	86583	86M6D7W		
100.0	BPSK	3750.0	3930.0	26.30	29.30	0.851	96646	96M6G7W		
	QPSK			26.30	29.30	0.851	96018	96M0G7W		
	16QAM			25.20	28.20	0.661	96214	96M2D7W		

## 6.4. WORST-CASE CONFIGURATION AND MODE

The EUT supports the following LTE and 5G NRs:

Band 2, Band 4, Band 5, Band 7, Band 12, Band 13, Band 14, Band 17, Band 25, Band 26, Band 30, Band 38, Band 41, Band 48, Band 66, Band 71, 5G NR n2, 5G NR n5, 5G NR n7, 5G NR n12, 5G NR n14, 5G NR n25, 5G NR n26, 5G NR n30, 5G NR n38, 5G NR n41, 5G NR n48, 5G NR n66, 5G NR n70, 5G NR n71, 5G NR n77 and 5G NR n78.

LTE Band 2 and 5G NR n2 (1850-1910MHz) are covered by LTE Band 25 and 5G NR n25 respectively. Because they are the subset of LTE band 25 and 5G NR n25 with the same output power and supported bandwidths.

LTE Band 4 (1710-1755MHz, 5/10/15/20MHz bandwidth) is covered by LTE Band 66 because it is a subset of LTE band 66 and they have same output power.

LTE Band 38 (2570-2620MHz) is covered by LTE Band 41 because it is a subset of LTE band 41. Also, they have the same or less output power and supported bandwidths.

5G NR n78 (3450-3650MHz) are covered by 5G NR n77 respectively. Because they are the subset of LTE band 5G NR n77 with the same output power and supported bandwidths.

For 5G NRs, conducted spurious emission tests were conducted on wider bandwidth with inner 1RB since this is the worst bandwidth and the highest output power.

BPSK modulation applied only for 5G NR frequencies and has the same tune up power as QPSK modulations.

The DFT-s-OFDM and CP-OFDM waveforms were investigated, and DFT-s-OFDM was found to be the worst case.

The worst-case scenario for all measurements is based on an engineering evaluation made on different modulations. Then, QPSK and BPSK were observed as the worst mode to LTE bands and 5G NR bands respectively and set for all conducted and radiated. Output power measurements were measured on BPSK, QPSK, 16QAM, 64QAM, and 256QAM modulations. For testing purposes emissions on sections 8 and 9 were measured while QPSK/BPSK was set at or above target power for all bands. Conducted tests were performed on the worst case antenna port because it has the highest conducted power. The worst case antenna port is shown in the table below.

LTE and 5G NR Bands	Worst case Antenna Port for Conducted Power	
LTE BAND 5 and 5G NR n5	Ant 0	
LTE BAND 12 and 5G NR n12		
LTE BAND 13		
LTE BAND 14 and 5G NR n14		
LTE Band 17		
LTE BAND 26 and 5G NR n26		
LTE BAND 30 and 5G NR n30		
LTE BAND 71 and 5G NR n71		
LTE BAND 7 and 5G NR n7		Ant 2
LTE BAND 25 and 5G NR n25		
LTE BAND 41 and 5G NR 41		
LTE BAND 66 and 5G NR n66		
5G NR n70		
5G NR n77	Ant 6	
5G NR n78		
LTE BAND 48		

The EUT was investigated in three orthogonal orientations X/Y/Z on all ANT 0, ANT1, ANT2, ANT5, ANT6 and ANT 7 antennas to determine the worst case orientation. The following table exhibit the worst case orientation for different frequency bands. The full tests of the EUT have made upon the orientations that shown in the table below.

Frequency Bands	ANT0	ANT1	ANT2	ANT5	ANT6	ANT7
663 – 849 MHz	Z	Z	N/A	N/A	N/A	N/A
1710 – 1915 MHz	Z	X	X	X	N/A	N/A
2300 – 2700 MHz	X	X	X	X	N/A	N/A
3300 – 3980 MHz	N/A	X	N/A	X	X	X

Radiated spurious emissions were investigated from 9kHz to 30MHz, 30MHz-1GHz and above 18GHz. There were no emissions found with less than 20dB of margin from 9kHz to 30MHz, 30MHz-1GHz and above 18GHz.

For simultaneous transmission of multiple channels in the 2.4GHz/5GH WLAN, UWB, and Cellular bands, tests were conducted for various configurations having the highest power, least separation in frequencies and widest operation bandwidths. No noticeable new emission was found.

## 6.5. DESCRIPTION OF TEST SETUP

SUPPORT TEST EQUIPMENT						
Description	Manufacturer	Model	Serial Number	FCC ID/ DoC		
Laptop	Dell	Latitude 7300	876819127	DoC		
AC/DC adapter	Dell	DA130PE1-00	CN-0M55GJ-DES00-066-5THK-A02	DoC		
Power Adapter	Google	GW8L7	1HV003B901000B9DE	DoC		
I/O CABLES (RF CONDUCTED TEST)						
Cable No.	Port	# of Identical Ports	Connector Type	Cable Type	Cable Length (m)	Remarks
1	AC	3	US 115V	Un-shielded	2.0	N/A
2	USB	1	USB-C	Un-shielded	1.0	N/A
3	RF In/Out	1	EUT	Un-shielded	0.6	N/A
4	RF In/Out	1	Communication Test Set	Un-shielded	1.2	N/A
5	RF In/Out	1	Barrel	N/A	N/A	N/A
I/O CABLES (RF RADIATED TEST)						
Cable No.	Port	# of Identical Ports	Connector Type	Cable Type	Cable Length (m)	Remarks
1	AC	1	US 115V	Un-shielded	2.0	N/A
1	USB	1	USB-C	Un-shielded	1	N/A
2	RF In/Out	1	Antenna	Un-shielded	5.0	N/A

**CONDUCTED SETUP**

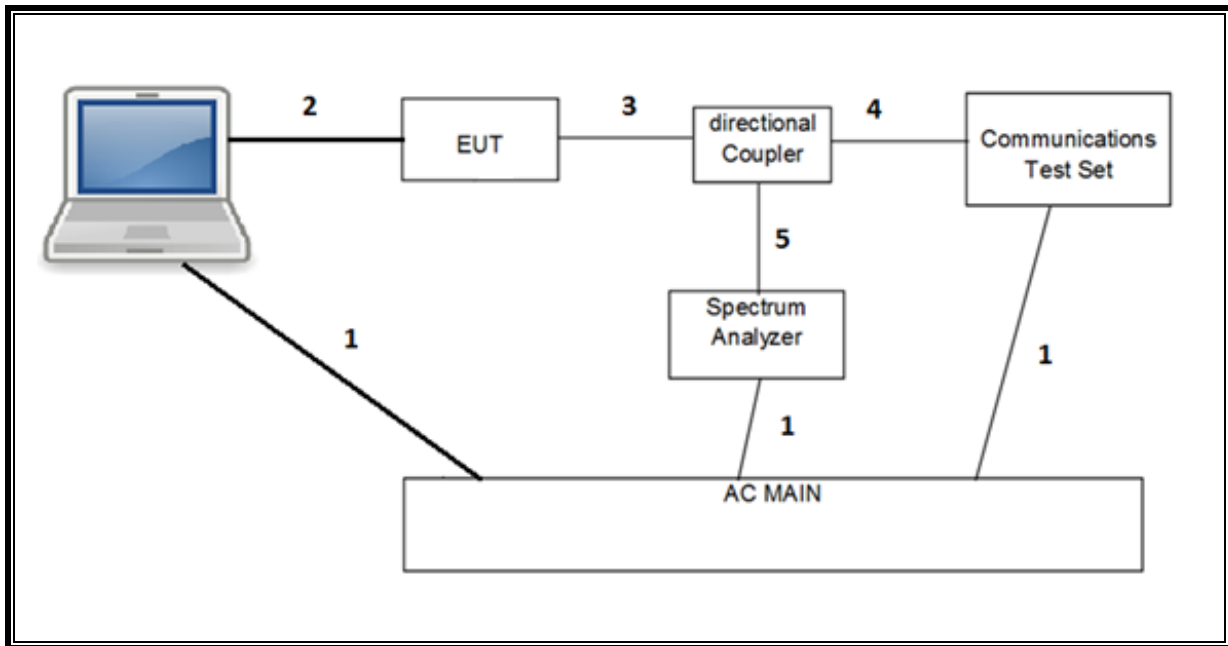

**RADIATED SETUP**

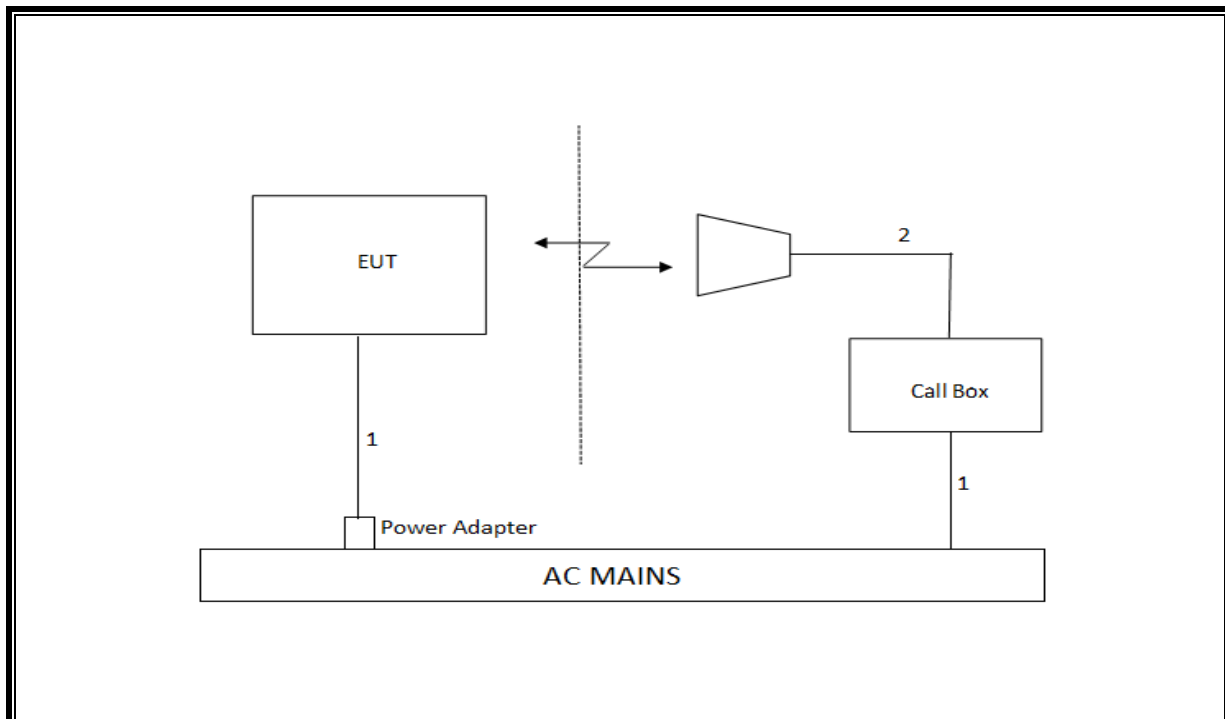

## 7. TEST AND MEASUREMENT EQUIPMENT

The following test and measurement equipment was utilized for the tests documented in this report:

TEST EQUIPMENT LIST					
Description	Manufacturer	Model	Asset	Cal Due	
Antenna, Horn 1-18GHz	ETS-Lindgren	3117	80430	2024-08-31	
Antenna, Horn 1-18GHz	ETS Lindgren	3117	79834	2024-06-30	
Antenna, Horn 1-18GHz	ETS Lindgren	3117	84796	2024-09-30	
Antenna, Broadband Hybrid, 30MHz to 3000MHz	SUNAR	JB3	222009	2024-10-31	
RF Filter Box, 1-18GHz	UL-FR1	NA	217255	2024-10-31	
RF Filter Box, 1-18GHz	UL-FR1	RATS 2	226781	2024-09-30	
RF Filter Box, 1-18GHz	UL-FR1	NA	217521	2024-03-31	
Amplifier, 10KHz to 1GHz, 32dB	Sonoma	310N	430250	2024-09-30	
EMI TEST RECEIVER	Rohde & Schwarz	ESW44	169936	2025-02-28	
EMI TEST RECEIVER	Rohde & Schwarz	ESW44	169935	2025-02-28	
EMI TEST RECEIVER	Rohde & Schwarz	ESW44	223461	2025-02-28	
Wideband Communication Test Set, Call Box	R&S GmbH & Co. KG	CMW500	85943	2025-02-28	
Directional Coupler	KRYTAR	152610	198816	2024-10-31	
Directional Coupler	KRYTAR	152610	231664	2025-01-22	
Power Meter, P-series single channel	Keysight	N1912A	90719	2025-01-31	
Power Sensor, P - series, 50MHz to 18GHz, Wideband	Keysight	N1921A	81319	2025-01-31	
Filter, HPF 1.2GHz	Wainwright Instruments GmbH	WHKX6-948-1.2/15G-40ST	99	2024-10-31	
Filter, BRF 2495 – 2690 MHz	Micro-Tronics	BRM50174-02	155055	2025-01-31	
Filter, BRF 3.4 – 3.8GHz	Micro-Tronics	BRM50711-02	208398	2024-10-31	
Spectrum Analyzer, PXA, 2Hz to 44GHz	Keysight	N9030B	231739	2025-01-31	
Spectrum Analyzer, PXA, 2Hz to 44GHz	Keysight	N9030B	245120	2025-02-28	
Spectrum Analyzer, PXA, 3Hz to 44GHz	Keysight	N9030A	85212	2025-02-28	
Wideband Communication Test Set, Call Box	R&S GmbH & Co. KG	CMW500	222793	2025-02-28	
Wideband Communication Test Set, Call Box	R&S GmbH & Co. KG	CMW500	222797	2025-02-28	
UXM 5G Wireless Test Platform	Keysight	E7515B	245172	2025-02-28	
UXM 5G Wireless Test Platform	Keysight	E7515B	231739	2025-01-31	
UXM 5G Wireless Test Platform	Keysight	E7515B	207269	2024-10-31	
UXM 5G Wireless Test Platform	Keysight	E7515B	1292206	2025-01-18	
Chamber, Environmental	Thermotron Corp.	SM-16C Mini-Max	179936	2024-06-30	
Transmitting Antenna, Horn Antenna	TEKBOX Digital Solutions	TBMA4	226709	C.N.R.	
Antenna, Horn 18 to 26.5GHz	A.R.A.	MWH-1826/B	199659	2024-12-31	
Amplifier 18-26.5GHz, +5Vdc, -54dBm P1dB	AMPLICAL	AMP18G26.5-60	234683	2024-06-29	
DC Power Supply	GWINSTEK	GPS18500	N/A	C.N.R.	
UL AUTOMATION SOFTWARE					
CLT Software	UL	UL RF		V2023.11.21.0	
Power Measurement Software	UL	UL RF		V2023.08.14.0	
Radiated test software	UL	UL RF		Ver 9.5 2023-05-01	

**NOTES:**

- \* Testing is completed before equipment expiration date.



## 8. RF OUTPUT POWER MEASUREMENTS

### CONDUCTED OUTPUT POWER MEASUREMENT PROCEDURE

All LTE bands conducted average power is obtained from the CMW500 telecommunication test set.

The following tests were conducted according to the test requirements outlined in section 6.2 of the 3GPP TS136.101 specification.

UE Power Class: 3 (23 +/- 2dBm). Band 41 UE Power Class: 2 (26 +/-2 dBm).The allowed Maximum Power Reduction (MPR) for the maximum output power due to higher order modulation and transmit bandwidth configuration (resource blocks) is specified in Table 6.2.3-1 of the 3GPP TS136.101.

**Table 6.2.3-1: Maximum Power Reduction (MPR) for Power Class 1, 2 and 3**

Modulation	Channel bandwidth / Transmission bandwidth ( $N_{RB}$ )						MPR (dB)
	1.4 MHz	3.0 MHz	5 MHz	10 MHz	15 MHz	20 MHz	
QPSK	> 5	> 4	> 8	> 12	> 16	> 18	≤ 1
16 QAM	≤ 5	≤ 4	≤ 8	≤ 12	≤ 16	≤ 18	≤ 1
16 QAM	> 5	> 4	> 8	> 12	> 16	> 18	≤ 2
64 QAM	≤ 5	≤ 4	≤ 8	≤ 12	≤ 16	≤ 18	≤ 2
64 QAM	> 5	> 4	> 8	> 12	> 16	> 18	≤ 3
256 QAM	≥ 1						≤ 5

The allowed A-MPR values specified below in Table 6.2.4.-1 of 3GPP TS136.101 are in addition to the allowed MPR requirements. All the measurements below were performed with A-MPR disabled, by using Network Signaling Value of "NS\_01".

**Table 6.2.4-1: Additional Maximum Power Reduction (A-MPR)**

Network Signalling value	Requirements (subclause)	E-UTRA Band	Channel bandwidth (MHz)	Resources Blocks ( $N_{RB}$ )	A-MPR (dB)
NS_01	6.6.2.1.1	Table 5.5-1	1.4, 3, 5, 10, 15, 20	Table 5.6-1	N/A
NS_03	6.6.2.2.1	2, 4, 10, 23, 25, 35, 36, 66, 70	3	>5	≤ 1
			5	>6	≤ 1
			10	>6	≤ 1
			15	>8	≤ 1
NS_04	6.6.2.2.2, 6.6.3.3.19	41	20	>10	≤ 1
			5, 10, 15, 20	Table 6.2.4-4, Table 6.2.4-4a	

### RESULTS

EUT includes different power levels for head use configuration and body use configuration and the below tables contain the highest of all configurations average conducted output powers as follows:

## 8.1. LTE BAND 5 AND 5G NR n5

### LTE BAND 5

<b>Test Engineer ID:</b>	24522NV and 39005RA	<b>Test Date:</b>	2024-01-18 to 2024-03-29
--------------------------	---------------------	-------------------	--------------------------

### OUTPUT POWER FOR LTE BAND 5 (1.4 MHz)

Bandwidth (MHz)	Modulation	RB Allocation	RB Offset	Conducted Average (dBm)					
				ANT 0			ANT 1		
				20407	20525	20643	20407	20525	20643
1.4	QPSK	1	0	23.5	23.5	23.5	22.9	23.5	23.4
		1	3	23.1	23.2	23.1	22.7	23.4	23.2
		1	5	23.6	23.3	23.2	22.9	23.4	23.4
		3	0	23.2	23.5	23.2	22.9	23.4	23.3
		3	1	23.2	23.2	23.2	22.9	23.3	23.3
		3	3	23.2	23.2	23.1	22.9	23.3	23.2
		6	0	23.6	23.6	<b>23.7</b>	22.9	<b>23.5</b>	23.4
	16QAM	1	0	23.4	23.3	23.4	23.1	23.4	23.4
		1	3	<b>23.5</b>	23.3	23.5	23.2	23.4	23.4
		1	5	23.5	23.4	23.4	23.2	<b>23.4</b>	23.4
		3	0	23.4	23.3	23.2	23.0	23.4	23.3
		3	1	23.4	23.3	23.3	23.0	23.4	23.3
		3	3	23.4	23.3	23.2	23.0	23.4	23.3
		6	0	22.7	22.7	22.5	22.3	22.7	22.6
	64QAM	1	0	<b>23.0</b>	22.7	22.6	22.7	<b>22.7</b>	22.6
		1	3	22.9	22.7	22.6	22.6	<b>22.7</b>	22.6
		1	5	22.9	22.7	22.6	22.6	<b>22.7</b>	22.6
		3	0	22.6	22.5	22.4	22.2	<b>22.7</b>	22.5
		3	1	22.6	22.5	22.4	22.2	<b>22.7</b>	22.6
		3	3	22.6	22.5	22.4	22.2	22.7	22.5
		6	0	21.7	21.5	21.5	21.4	21.7	21.6
	256QAM	1	0	<b>19.8</b>	19.4	19.6	19.3	<b>19.7</b>	19.5
		1	3	19.7	19.4	19.5	19.2	19.7	19.4
		1	5	19.8	19.4	19.6	19.3	<b>19.7</b>	19.4
		3	0	19.6	19.5	19.4	19.3	19.6	19.6
		3	1	19.6	19.4	19.4	19.2	19.5	19.5
		3	3	19.5	19.4	19.3	19.2	19.6	19.5
		6	0	19.6	19.5	19.5	19.2	19.7	19.6

### OUTPUT POWER FOR LTE BAND 5 (3.0 MHz)

Bandwidth (MHz)	Modulation	RB Allocation	RB Offset	Conducted Average (dBm)					
				ANT 0			ANT 1		
				20415	20525	20635	20415	20525	20635
3.0	QPSK	1	0	23.6	23.2	23.3	23.6	23.5	23.5
		1	8	23.1	23.1	23.2	23.4	23.3	23.4
		1	14	<b>23.7</b>	23.1	23.3	<b>23.6</b>	23.4	23.5
		8	0	23.3	23.6	23.2	23.5	23.5	23.4
		8	4	<b>23.7</b>	23.2	23.2	23.5	23.5	23.4
		8	7	23.6	23.3	23.2	23.5	23.5	23.4
		15	0	<b>23.7</b>	23.2	23.2	23.5	23.4	23.3
	16QAM	1	0	23.5	23.6	23.5	<b>23.5</b>	23.3	22.7
		1	8	23.4	23.5	23.4	23.5	<b>23.5</b>	<b>23.5</b>
		1	14	23.4	<b>23.6</b>	23.4	23.5	23.3	23.4
		8	0	22.7	22.6	22.6	22.8	22.7	22.7
		8	4	22.7	22.6	22.5	22.8	22.7	22.7
		8	7	22.7	22.6	22.5	22.8	22.7	22.7
		15	0	22.6	22.5	22.5	22.8	22.7	22.6
	64QAM	1	0	22.9	22.8	22.7	22.4	22.7	22.7
		1	8	22.7	22.7	22.6	22.3	22.6	22.6
		1	14	<b>22.9</b>	22.7	22.7	22.5	22.6	<b>22.8</b>
		8	0	21.7	21.5	21.6	21.3	21.7	21.7
		8	4	21.6	21.5	21.5	21.3	21.6	21.6
		8	7	21.6	21.5	21.5	21.3	21.6	21.6
		15	0	21.5	21.5	21.5	21.3	21.6	21.5
	256QAM	1	0	<b>19.8</b>	19.7	19.6	19.4	19.7	<b>19.7</b>
		1	8	19.7	19.5	19.5	19.2	19.5	19.6
		1	14	19.8	19.7	19.5	19.3	19.7	<b>19.7</b>
		8	0	19.7	19.6	19.6	19.4	<b>19.7</b>	19.7
		8	4	19.6	19.6	19.5	19.3	<b>19.7</b>	19.6
		8	7	19.6	19.5	19.6	19.4	19.7	19.6
		15	0	19.6	19.5	19.5	19.3	<b>19.7</b>	19.6

**OUTPUT POWER FOR LTE BAND 5 (5.0 MHz)**

Bandwidth (MHz)	Modulation	RB Allocation	RB Offset	Conducted Average (dBm)					
				ANT 0			ANT 1		
				20425	20525	20625	20425	20525	20625
5.0	QPSK	1	0	23.7	<b>23.8</b>	23.6	22.9	<b>23.4</b>	23.4
		1	12	23.6	<b>23.6</b>	23.5	22.8	23.3	23.3
		1	24	23.7	<b>23.8</b>	23.6	22.9	23.4	23.4
		12	0	23.3	23.2	23.2	23.0	23.4	23.4
		12	6	23.3	23.2	23.2	22.9	23.4	23.4
		12	11	23.7	23.6	<b>23.8</b>	23.0	23.4	23.3
	16QAM	25	0	<b>23.8</b>	23.7	23.6	22.9	23.4	23.4
		1	0	23.6	23.6	<b>23.7</b>	23.2	23.2	<b>23.6</b>
		1	12	23.5	23.4	23.4	23.1	23.5	<b>23.6</b>
		1	24	23.6	23.5	23.6	23.2	23.5	23.5
		12	0	22.7	22.6	22.5	22.4	22.2	22.7
		12	6	22.7	22.6	22.5	22.3	22.2	22.7
	64QAM	12	11	22.7	22.6	22.5	22.4	22.2	22.7
		25	0	22.6	22.5	22.5	22.3	22.7	22.7
		1	0	22.8	<b>22.9</b>	22.7	22.4	<b>22.6</b>	22.3
		1	12	22.8	22.8	22.6	22.4	22.6	22.2
		1	24	22.8	22.8	22.6	22.4	22.6	22.4
		12	0	21.6	21.5	21.5	21.3	21.7	21.7
	256QAM	12	6	21.6	21.5	21.5	21.3	21.7	21.7
		12	11	21.6	21.5	21.4	21.3	21.7	21.6
		25	0	21.6	21.5	21.5	21.3	21.7	21.7
		1	0	19.6	<b>19.7</b>	19.6	19.3	19.7	<b>19.7</b>
		1	12	19.5	19.6	19.5	19.2	19.5	19.6
		1	24	19.6	19.7	19.5	19.3	19.7	19.6
	256QAM	12	0	19.6	19.5	19.5	19.3	19.7	<b>19.7</b>
		12	6	19.5	19.5	19.4	19.3	19.6	<b>19.7</b>
		12	11	19.5	19.5	19.4	19.3	19.6	19.7
		25	0	19.6	19.4	19.5	19.3	19.7	19.6

**OUTPUT POWER FOR LTE BAND 5 (10.0 MHz)**

Bandwidth (MHz)	Modulation	RB Allocation	RB Offset	Conducted Average (dBm)						
				ANT 0			ANT 1			
				20450	20525	20600	20450	20525	20600	
10.0	QPSK	1	0	829.0	<b>24.3</b>	24.0	<b>24.3</b>	<b>23.8</b>	23.3	23.6
		1	24	24.2	23.9	24.3	23.7	23.3	23.6	
		1	49	24.3	23.9	24.2	23.6	23.4	23.5	
		25	0	23.4	22.9	23.3	22.8	22.4	22.6	
		25	12	23.3	22.8	23.3	22.7	22.4	22.6	
		25	24	23.3	22.8	23.2	22.7	22.4	22.6	
	16QAM	50	0	23.3	22.8	23.3	22.7	22.4	22.6	
		1	0	23.9	23.5	<b>23.9</b>	<b>23.3</b>	23.2	23.2	
		1	24	23.9	23.5	23.9	23.3	23.1	23.1	
		1	49	23.7	23.4	23.7	23.2	23.0	23.1	
		25	0	22.8	22.6	22.7	22.2	21.8	22.0	
		25	12	22.7	22.6	22.6	22.1	21.8	22.0	
	64QAM	25	24	22.7	22.6	22.6	22.1	21.8	21.9	
		50	0	22.7	22.5	22.7	22.1	21.8	22.0	
		1	0	22.9	<b>22.9</b>	22.7	<b>22.4</b>	22.1	22.3	
		1	24	22.8	22.8	22.6	22.3	22.0	22.2	
		1	49	22.7	22.8	22.5	22.2	22.1	22.1	
		25	0	21.7	21.6	21.7	21.2	20.9	21.0	
	256QAM	25	12	21.7	21.5	21.6	21.1	20.8	20.9	
		25	24	21.6	21.5	21.6	21.1	20.8	20.9	
		50	0	21.7	21.5	21.6	21.1	20.8	20.9	
		1	0	19.7	19.7	19.7	19.2	19.4	19.1	
		1	24	19.7	19.6	19.7	19.1	<b>19.7</b>	19.1	
		1	49	19.6	19.5	19.5	19.0	<b>19.7</b>	19.0	
	256QAM	25	0	<b>19.7</b>	19.6	19.7	19.2	<b>19.7</b>	19.0	
		25	12	19.7	19.6	19.6	19.1	<b>19.7</b>	18.9	
		25	24	19.7	19.5	19.6	19.0	19.7	18.9	
		50	0	19.7	19.5	19.6	19.1	19.7	18.9	

**5G NR n5**

Test Engineer ID:	19210AL	Test Date:	2024-02-02
-------------------	---------	------------	------------

**OUTPUT POWER FOR 5G NR n5 (5.0 MHz)**

Bandwidth (MHz)	Modulation	RB Allocation	RB Offset	Conducted Average (dBm)					
				ANT 0			ANT 1		
				165300	167300	169300	165300	167300	169300
5.0	BPSK	1	0	23.8	23.8	23.8	23.3	23.7	23.7
		1	1	24.3	24.2	24.3	23.4	24.2	24.1
		1	23	24.3	<b>24.4</b>	24.2	23.5	<b>24.3</b>	24.2
		1	24	23.8	23.8	23.7	23.1	23.8	23.7
		12	6	24.3	24.2	24.3	23.4	24.2	24.1
		25	0	23.9	23.8	23.7	23.2	23.6	23.6
	QPSK	1	0	23.3	23.3	23.3	22.7	23.2	23.2
		1	1	24.3	24.3	24.2	23.5	24.1	24.2
		1	23	24.3	<b>24.4</b>	24.2	23.5	<b>24.2</b>	24.2
		1	24	23.3	23.3	23.3	22.8	23.2	23.1
		12	6	24.3	24.3	24.3	23.4	24.1	24.1
		25	0	23.3	23.3	23.2	22.7	23.2	23.1
	16QAM	1	0	22.5	22.1	22.5	21.9	21.8	22.3
		1	1	23.1	23.2	23.2	23.0	23.0	22.9
		1	23	23.0	23.2	23.2	22.5	23.4	<b>23.5</b>
		1	24	22.4	22.2	22.5	21.8	22.3	22.0
		12	6	23.3	23.3	<b>23.3</b>	22.6	23.1	23.3
		25	0	22.4	22.3	22.2	21.7	22.1	22.2
	64QAM	1	0	21.7	21.9	22.1	21.2	21.7	21.2
		1	1	21.8	<b>22.2</b>	22.0	21.2	21.6	22.0
		1	23	21.8	21.8	21.7	21.3	21.9	<b>22.1</b>
		1	24	21.9	21.6	21.7	21.2	21.9	21.4
		12	6	21.8	21.7	21.6	21.2	21.7	21.7
		25	0	21.7	21.7	21.9	21.3	21.6	21.7
	256QAM	1	0	20.2	20.1	19.7	19.3	19.2	19.8
		1	1	19.8	19.6	19.7	19.2	19.7	19.7
		1	23	19.8	19.4	19.7	19.5	19.2	<b>20.0</b>
		1	24	<b>20.2</b>	19.8	19.6	19.2	19.8	19.8
12		6	19.8	19.7	19.7	19.2	19.6	19.6	
25		0	19.8	19.8	19.7	19.2	19.6	19.7	

**OUTPUT POWER FOR 5G NR n5 (10.0 MHz)**

Bandwidth (MHz)	Modulation	RB Allocation	RB Offset	Conducted Average (dBm)					
				ANT 0			ANT 1		
				165800	167300	168800	165800	167300	168800
10.0	BPSK	1	0	23.9	23.9	23.9	23.8	23.7	23.8
		1	1	<b>24.4</b>	24.3	24.3	<b>24.3</b>	24.2	24.2
		1	50	24.3	24.2	24.3	24.1	24.2	24.2
		1	51	23.8	23.7	23.7	23.7	23.5	23.6
		25	12	24.3	24.3	24.3	24.1	24.1	24.2
		50	0	23.8	23.9	23.8	23.7	23.7	23.6
	QPSK	1	0	23.3	23.3	23.3	23.2	23.2	23.2
		1	1	24.3	24.3	24.3	24.1	<b>24.2</b>	24.2
		1	50	24.2	24.2	24.2	24.1	24.2	24.1
		1	51	23.3	23.3	23.2	23.1	23.2	23.1
		25	12	<b>24.4</b>	24.2	24.3	24.2	24.2	24.1
		50	0	23.3	23.3	23.3	23.1	23.1	23.1
	16QAM	1	0	22.5	22.6	22.4	22.2	22.2	21.8
		1	1	23.4	23.3	23.2	22.9	23.2	23.0
		1	50	23.0	23.2	<b>23.6</b>	23.0	23.2	23.1
		1	51	22.5	22.5	22.3	22.2	22.2	22.0
		25	12	23.2	23.4	23.4	<b>23.2</b>	23.1	23.2
		50	0	22.3	22.4	22.3	22.2	22.1	22.1
	64QAM	1	0	22.0	21.9	21.5	21.3	21.5	21.7
		1	1	21.7	21.9	21.9	21.6	21.7	<b>22.0</b>
		1	50	21.9	<b>22.1</b>	22.0	21.7	21.6	21.8
		1	51	21.6	21.8	22.0	21.5	21.8	21.5
		25	12	21.7	21.8	21.8	21.7	21.6	21.5
		50	0	21.7	21.9	21.7	21.8	21.6	21.6
	256QAM	1	0	20.2	19.9	<b>20.2</b>	19.9	20.0	19.8
		1	1	20.1	20.1	19.8	19.5	19.6	<b>20.0</b>
		1	50	19.4	19.9	19.5	19.8	19.8	19.8
		1	51	<b>20.2</b>	19.8	19.7	19.6	19.7	19.6
		25	12	19.8	19.8	19.9	19.6	19.6	19.7
		50	0	19.8	19.8	19.8	19.7	19.7	19.7

**OUTPUT POWER FOR 5G NR n5 (15.0 MHz)**

Bandwidth (MHz)	Modulation	RB Allocation	RB Offset	Conducted Average (dBm)					
				ANT 0			ANT 1		
				166300	167300	168300	166300	167300	168300
15.0	BPSK	1	0	23.8	23.8	23.7	23.6	23.7	23.6
		1	1	24.3	24.4	24.2	24.2	24.1	24.0
		1	77	24.4	24.3	24.2	24.1	24.2	24.0
		1	78	23.8	23.9	23.6	23.6	23.7	23.6
		36	18	24.4	24.2	24.3	24.2	24.1	24.2
		75	0	23.9	23.8	23.8	23.7	23.6	23.6
	QPSK	1	0	23.3	23.4	23.3	23.1	23.2	23.0
		1	1	24.4	24.3	24.3	24.2	24.1	24.1
		1	77	24.4	24.2	24.2	24.2	24.1	24.0
		1	78	23.4	23.2	23.1	23.1	23.2	23.1
		36	18	24.4	24.3	24.3	24.2	24.1	24.1
		75	0	23.3	23.3	23.2	23.3	23.1	23.1
	16QAM	1	0	22.1	22.4	22.3	22.3	21.8	22.2
		1	1	23.2	23.4	23.2	23.0	23.3	22.8
		1	77	23.1	23.3	23.0	23.4	23.2	23.3
		1	78	22.3	22.3	22.5	22.2	22.2	22.2
		36	18	23.3	23.2	23.3	23.2	23.1	23.1
		75	0	22.3	22.3	22.2	22.2	22.2	22.2
	64QAM	1	0	22.0	22.0	21.9	21.6	21.9	21.1
		1	1	21.6	21.9	22.2	21.2	22.2	21.2
		1	77	21.9	22.0	22.0	21.6	21.5	21.8
		1	78	21.4	21.6	22.1	21.8	21.3	21.2
		36	18	21.9	21.7	21.8	21.7	21.6	21.7
		75	0	21.9	21.8	21.7	21.6	21.5	21.6
	256QAM	1	0	20.0	19.5	19.8	20.1	19.5	19.8
		1	1	20.1	20.3	20.1	19.9	19.4	19.8
		1	77	20.0	20.2	19.8	19.7	19.5	19.6
		1	78	19.7	19.5	19.6	19.9	19.2	19.9
		36	18	19.8	19.8	19.7	19.6	19.6	19.7
		75	0	19.9	19.8	19.8	19.7	19.7	19.7

**OUTPUT POWER FOR 5G NR n5 (20.0 MHz)**

Bandwidth (MHz)	Modulation	RB Allocation	RB Offset	Conducted Average (dBm)					
				ANT 0			ANT 1		
				166800	167300	167800	166800	167300	167800
20.0	BPSK	1	0	23.9	23.9	23.9	23.8	23.7	23.7
		1	1	24.4	24.4	24.4	24.2	24.1	24.3
		1	104	24.4	24.4	24.3	24.1	24.2	24.1
		1	105	23.8	23.8	23.8	23.7	23.7	23.6
		50	25	24.3	24.3	24.4	24.1	24.2	24.2
		100	0	23.7	23.7	23.8	23.7	23.7	23.7
	QPSK	1	0	23.3	23.3	23.4	23.2	23.2	23.2
		1	1	24.3	24.3	24.4	24.1	24.3	24.2
		1	104	24.3	24.3	24.2	24.1	24.2	24.2
		1	105	23.3	23.3	23.2	23.1	23.2	23.0
		50	25	24.3	24.3	24.3	24.1	24.1	24.3
		100	0	23.3	23.3	23.4	23.1	23.1	23.3
	16QAM	1	0	22.3	22.3	22.0	22.2	22.2	22.0
		1	1	23.2	23.2	23.4	23.2	23.1	22.8
		1	104	23.1	23.1	23.0	23.0	23.3	23.0
		1	105	21.9	21.9	22.1	22.3	21.9	22.4
		50	25	23.3	23.3	23.4	23.2	23.2	23.2
		100	0	22.2	22.2	22.3	22.2	22.1	22.2
	64QAM	1	0	22.0	22.0	22.1	21.5	21.6	22.0
		1	1	21.6	21.6	22.1	21.7	21.6	21.5
		1	104	22.0	22.0	21.7	21.7	21.5	21.4
		1	105	21.6	21.6	21.8	21.8	21.5	21.3
		50	25	21.8	21.8	21.9	21.7	21.6	21.7
		100	0	21.9	21.9	21.9	21.6	21.6	21.7
	256QAM	1	0	19.8	19.8	20.2	20.0	19.5	19.6
		1	1	19.8	19.8	19.5	19.8	19.9	20.1
		1	104	20.1	20.1	19.9	19.6	19.6	19.4
		1	105	19.9	19.9	19.5	19.6	19.7	19.7
		50	25	19.7	19.7	19.8	19.7	19.6	19.7
		100	0	19.8	19.8	19.8	19.6	19.7	19.6

## 8.2. LTE BAND 7 AND 5G NR n7

### LTE BAND 7

Test Engineer ID:	19420PD	Test Date:	2024-01-19 to 2024-01-22
-------------------	---------	------------	--------------------------

#### OUTPUT POWER FOR LTE BAND 7 (5.0 MHz)

Bandwidth (MHz)	Modulation	RB Allocation	RB Offset	Conducted Average (dBm)					
				ANT 2			ANT 0		
				20775	21100	21425	20775	21100	21425
5.0	QPSK	1	0	24.0	24.1	24.1	23.7	23.7	23.7
		1	12	24.1	24.1	24.0	23.7	23.7	<b>23.8</b>
		1	24	24.1	24.1	24.2	23.7	23.7	23.7
		12	0	24.1	24.1	24.2	23.7	23.7	23.7
		12	6	24.1	24.1	24.2	23.7	23.7	23.7
		12	11	24.1	24.1	24.1	23.7	23.7	23.8
	16QAM	25	0	24.1	24.1	<b>24.2</b>	23.7	23.7	23.8
		1	0	23.6	23.7	<b>23.7</b>	23.2	23.4	23.3
		1	12	23.4	23.5	23.5	23.2	23.3	<b>23.5</b>
		1	24	23.6	23.6	23.7	23.2	23.4	23.4
		12	0	22.4	22.5	22.6	22.0	22.1	22.0
		12	6	22.4	22.5	22.6	22.0	22.1	22.0
	64QAM	12	11	22.4	22.5	22.5	22.1	22.1	22.0
		25	0	22.4	22.4	22.5	22.0	21.9	22.1
		1	0	22.6	<b>22.7</b>	22.6	22.1	22.4	22.1
		1	12	22.6	22.6	22.5	22.0	<b>22.4</b>	22.1
		1	24	22.7	22.7	22.6	22.2	22.3	22.1
		12	0	21.4	21.4	21.5	21.0	21.1	21.1
	256QAM	12	6	21.4	21.4	21.5	21.0	21.1	21.1
		12	11	21.4	21.4	21.4	21.0	21.1	21.0
		25	0	21.4	21.4	21.5	21.0	21.0	21.1
		1	0	19.4	<b>19.7</b>	19.5	19.1	19.3	19.2
		1	12	19.2	19.5	19.4	19.2	<b>19.4</b>	19.1
		1	24	19.3	19.6	19.5	19.1	19.3	19.1
	256QAM	12	0	19.4	19.4	19.4	19.0	19.0	19.1
		12	6	19.4	19.4	19.4	19.0	19.0	19.0
		12	11	19.4	19.4	19.4	19.0	19.0	19.0
		25	0	19.4	19.4	19.5	19.0	19.0	19.1
		1	0	19.4	19.4	19.5	19.0	19.0	19.1
		1	12	19.4	19.4	19.5	19.0	19.0	19.1

#### OUTPUT POWER FOR LTE BAND 7 (10.0 MHz)

Bandwidth (MHz)	Modulation	RB Allocation	RB Offset	Conducted Average (dBm)					
				ANT 2			ANT 0		
				20800	21100	21400	20800	21100	21400
10.0	QPSK	1	0	24.0	24.0	24.0	23.6	23.6	23.6
		1	24	24.0	<b>24.1</b>	23.8	23.6	<b>23.7</b>	23.6
		1	49	24.0	24.0	24.0	23.5	23.5	23.6
		25	0	24.0	24.0	24.0	23.6	23.5	23.6
		25	12	24.0	24.0	24.0	23.6	23.5	23.6
		25	24	23.9	23.9	24.0	23.5	23.5	23.5
	16QAM	50	0	23.9	23.9	24.0	23.5	23.5	23.6
		1	0	23.5	23.7	<b>23.9</b>	23.2	23.0	<b>23.4</b>
		1	24	23.5	23.8	23.8	23.2	23.0	23.2
		1	49	23.4	23.7	23.8	23.1	23.0	23.3
		25	0	22.5	22.5	22.5	22.1	22.1	22.1
		25	12	22.5	22.4	22.5	22.1	22.1	22.1
	64QAM	25	24	22.5	22.4	22.4	22.1	22.0	22.1
		50	0	22.5	22.4	22.5	22.0	22.0	22.1
		1	0	22.6	22.7	22.7	22.1	<b>22.4</b>	22.2
		1	24	22.7	<b>22.7</b>	22.6	22.1	<b>22.4</b>	22.2
		1	49	22.7	22.7	22.6	22.2	22.3	22.1
		25	0	21.5	21.4	21.5	21.1	21.0	21.1
	256QAM	25	12	21.5	21.4	21.5	21.0	21.0	21.1
		25	24	21.5	21.4	21.5	21.1	21.0	21.1
		50	0	21.5	21.4	21.5	21.1	21.0	21.1
		1	0	19.5	<b>19.7</b>	19.6	19.0	19.4	19.3
		1	24	19.5	19.6	19.5	19.1	<b>19.4</b>	19.2
		1	49	19.5	19.7	19.5	19.0	19.3	19.2
	256QAM	25	0	19.4	19.5	19.6	19.1	19.1	19.2
		25	12	19.4	19.5	19.5	19.0	19.1	19.1
		25	24	19.4	19.4	19.5	19.0	19.0	19.1
		1	0	19.4	19.4	19.5	19.0	19.0	19.1
		1	12	19.4	19.4	19.5	19.0	19.0	19.1
		1	24	19.4	19.4	19.5	19.0	19.0	19.1

**OUTPUT POWER FOR LTE BAND 7 (15.0 MHz)**

Bandwidth (MHz)	Modulation	RB Allocation	RB Offset	Conducted Average (dBm)					
				ANT 2			ANT 0		
				20825 2507.5	21100 2535.0	21375 2562.5	20825 2507.5	21100 2535.0	21375 2562.5
15.0	QPSK	1	0	24.1	24.1	24.1	23.7	23.6	23.7
		1	37	23.9	23.9	24.0	23.7	23.8	23.8
		1	74	24.0	24.1	24.1	23.6	23.6	23.7
		36	0	24.1	24.1	24.1	23.7	23.7	23.7
		36	16	24.1	24.1	24.1	23.6	23.7	23.7
		36	35	24.1	24.1	24.1	23.6	23.7	23.7
		75	0	24.1	24.1	24.1	23.6	23.7	23.7
	16QAM	1	0	23.7	23.7	23.8	23.1	23.2	23.5
		1	37	23.6	23.6	23.7	23.3	23.2	23.6
		1	74	23.7	23.7	23.8	23.0	23.1	23.4
		36	0	22.5	22.5	22.5	22.1	22.1	22.1
		36	16	22.4	22.5	22.5	22.1	22.1	22.1
		36	35	22.4	22.5	22.5	22.0	22.1	22.1
		75	0	22.5	22.5	22.5	22.1	22.1	22.1
	64QAM	1	0	22.6	22.7	22.8	22.3	22.3	22.4
		1	37	22.4	22.5	22.7	22.4	22.3	21.9
		1	74	22.5	22.6	22.8	22.3	22.2	22.3
		36	0	21.5	21.5	21.5	21.1	21.1	21.0
		36	16	21.5	21.5	21.4	21.1	21.1	21.0
		36	35	21.5	21.5	21.4	21.1	21.0	21.0
		75	0	21.4	21.4	21.4	21.0	21.0	21.1
	256QAM	1	0	19.5	19.8	19.7	19.0	19.3	19.2
		1	37	19.4	19.6	19.5	19.0	19.2	19.3
		1	74	19.5	19.7	19.7	19.0	19.2	19.2
		36	0	19.4	19.5	19.4	19.0	19.1	19.0
		36	16	19.4	19.5	19.4	19.0	19.1	19.0
		36	35	19.4	19.4	19.4	19.0	19.0	19.0
		75	0	19.4	19.4	19.4	19.0	19.0	19.0

**OUTPUT POWER FOR LTE BAND 7 (20.0 MHz)**

Bandwidth (MHz)	Modulation	RB Allocation	RB Offset	Conducted Average (dBm)					
				ANT 2			ANT 0		
				20850 2510.0	21100 2535.0	21350 2560.0	20850 2510.0	21100 2535.0	21350 2560.0
20.0	QPSK	1	0	24.2	24.1	24.1	23.7	23.7	23.7
		1	49	24.1	23.9	24.1	23.8	23.5	23.6
		1	99	24.1	24.0	24.0	23.6	23.6	23.6
		50	0	24.1	24.1	24.1	23.7	23.7	23.6
		50	24	24.1	24.1	24.1	23.7	23.7	23.6
		50	49	24.1	24.1	24.0	23.6	23.6	23.6
		100	0	24.1	24.1	24.1	23.7	23.6	23.6
	16QAM	1	0	23.7	23.8	23.8	23.4	23.4	23.3
		1	49	23.8	23.7	23.7	23.2	23.3	22.9
		1	99	23.7	23.7	23.7	23.3	23.4	23.1
		50	0	22.5	22.6	22.5	22.0	22.1	22.1
		50	24	22.5	22.5	22.5	22.0	22.0	22.1
		50	49	22.5	22.5	22.4	22.0	22.0	22.0
		100	0	22.5	22.5	22.5	22.1	22.1	22.0
	64QAM	1	0	22.8	22.8	22.6	22.4	22.3	22.2
		1	49	22.6	22.7	22.5	22.6	22.4	22.1
		1	99	22.7	22.8	22.5	22.4	22.2	22.0
		50	0	21.5	21.5	21.5	21.1	21.1	21.1
		50	24	21.5	21.5	21.5	21.1	21.0	21.1
		50	49	21.5	21.4	21.4	21.1	21.0	21.0
		100	0	21.4	21.5	21.5	21.0	21.0	21.1
	256QAM	1	0	19.5	19.8	19.6	19.5	19.4	19.1
		1	49	19.4	19.7	19.4	19.7	19.1	19.2
		1	99	19.5	19.7	19.5	19.5	19.2	19.0
		50	0	19.5	19.4	19.5	19.1	19.0	19.1
		50	24	19.5	19.4	19.4	19.1	19.0	19.0
		50	49	19.5	19.4	19.4	19.1	19.0	19.0
		100	0	19.5	19.4	19.4	19.1	19.0	19.1

**5G NR n7**

<b>Test Engineer ID:</b>	19210AL	<b>Test Date:</b>	2024-02-06
--------------------------	---------	-------------------	------------

**OUTPUT POWER FOR 5G NR n7 (5.0 MHz)**

Bandwidth (MHz)	Modulation	RB Allocation	RB Offset	Conducted Average (dBm)					
				ANT 2			ANT 0		
				500500 2502.5	507000 2535.0	513500 2567.5	500500 2502.5	507000 2535.0	513500 2567.5
5.0	BPSK	1	0	24.0	23.9	24.0	23.7	23.6	23.6
		1	1	<b>24.5</b>	24.5	24.4	23.8	23.7	24.2
		1	23	24.4	24.5	24.5	23.7	23.8	24.1
		1	24	23.9	23.9	24.0	23.6	23.6	23.7
		12	6	24.3	24.4	24.5	23.8	23.6	<b>24.2</b>
	QPSK	25	0	23.8	23.9	24.0	23.6	23.5	23.8
		1	0	23.4	23.4	23.4	23.2	23.1	23.2
		1	1	<b>24.5</b>	24.5	24.5	23.8	23.8	<b>24.2</b>
		1	23	24.5	24.5	24.4	23.8	23.7	24.1
		1	24	23.5	23.4	23.4	23.2	23.1	23.2
	16QAM	12	6	24.4	24.4	24.4	23.6	23.6	24.2
		25	0	23.4	23.4	23.5	23.1	23.0	23.1
		1	0	22.2	21.9	22.5	22.3	22.0	22.3
		1	1	23.1	<b>23.6</b>	23.4	<b>23.3</b>	23.1	23.2
		1	23	23.3	23.5	23.5	23.3	23.0	23.2
	64QAM	1	24	22.2	22.4	22.5	22.3	22.3	22.1
		12	6	23.4	23.4	23.6	22.9	23.1	23.2
		25	0	22.4	22.4	22.5	22.1	22.1	22.1
		1	0	22.0	22.1	22.2	21.6	21.5	21.4
		1	1	22.1	22.1	<b>22.3</b>	21.6	21.4	21.7
	256QAM	1	23	21.5	21.8	21.9	21.9	21.4	21.8
		1	24	21.5	22.0	22.2	<b>21.9</b>	21.5	21.9
		12	6	21.8	21.9	21.8	21.7	21.5	21.7
		25	0	21.9	21.9	21.8	21.6	21.6	21.8
		1	0	20.2	19.6	19.9	19.7	19.4	19.8
	1	1	1	20.0	19.7	<b>20.2</b>	19.8	19.4	19.6
		1	23	20.0	19.7	19.8	19.6	19.3	19.8
	1	1	24	19.8	19.8	19.8	19.7	<b>20.2</b>	19.7
		12	6	19.9	19.8	19.9	19.6	19.6	19.6
	25	0	19.9	19.9	19.9	19.5	19.6	19.6	

**OUTPUT POWER FOR 5G NR n7 (10.0 MHz)**

Bandwidth (MHz)	Modulation	RB Allocation	RB Offset	Conducted Average (dBm)					
				ANT 2			ANT 0		
				501000 2505.0	507000 2535.0	513000 2565.0	501000 2505.0	507000 2535.0	513000 2565.0
10.0	BPSK	1	0	24.0	24.0	24.1	23.7	23.5	23.6
		1	1	24.5	24.4	24.5	24.1	24.0	24.1
		1	50	24.4	24.5	<b>24.5</b>	24.1	24.1	<b>24.2</b>
		1	51	23.9	24.0	24.0	23.6	23.5	23.7
		25	12	24.4	24.4	24.5	24.2	24.0	24.1
		50	0	23.9	24.0	24.0	23.6	23.5	23.6
	QPSK	1	0	23.4	23.4	23.5	23.2	23.0	23.1
		1	1	24.4	24.5	24.5	<b>24.2</b>	24.1	24.1
		1	50	24.5	<b>24.5</b>	24.5	24.1	24.1	24.2
		1	51	23.4	23.4	23.4	23.1	23.1	23.1
		25	12	24.4	24.5	24.4	24.1	23.9	24.1
		50	0	23.4	23.5	23.4	23.1	23.0	23.1
	16QAM	1	0	22.3	22.3	22.6	22.3	21.9	22.3
		1	1	23.4	<b>23.6</b>	23.5	23.4	23.0	23.0
		1	50	23.3	23.3	23.2	23.1	23.3	<b>23.4</b>
		1	51	22.3	22.5	22.5	22.3	22.1	21.9
		25	12	23.5	23.5	23.5	23.1	22.9	23.1
		50	0	22.3	22.4	22.4	22.1	22.0	22.1
	64QAM	1	0	21.9	21.6	22.2	21.4	21.7	21.7
		1	1	21.7	22.1	<b>22.3</b>	21.7	21.6	<b>22.0</b>
		1	50	21.6	22.2	22.2	21.6	21.6	21.6
		1	51	22.0	21.6	22.0	21.9	21.6	21.7
		25	12	21.8	22.0	22.1	21.5	21.5	21.5
		50	0	21.9	21.9	22.1	21.5	21.5	21.6
	256QAM	1	0	<b>20.3</b>	20.1	19.9	19.6	19.4	19.6
		1	1	19.6	20.0	19.8	19.5	19.4	19.6
		1	50	19.6	19.9	19.6	19.3	<b>19.9</b>	19.5
		1	51	19.9	19.9	19.6	19.7	19.7	19.7
		25	12	19.8	19.9	19.9	19.5	19.4	19.6
		50	0	19.8	19.9	20.0	19.6	19.5	19.6



**OUTPUT POWER FOR 5G NR n7 (15.0 MHz)**

Bandwidth (MHz)	Modulation	RB Allocation	RB Offset	Conducted Average (dBm)					
				ANT 2			ANT 0		
				501500	507000	512500	501500	507000	512500
15.0	BPSK	1	0	24.0	23.9	24.0	23.6	23.5	23.6
		1	1	24.4	24.5	24.5	24.1	24.1	24.0
		1	77	24.4	<b>24.6</b>	24.5	24.0	24.0	24.1
		1	78	23.9	24.1	24.0	23.5	23.6	23.6
		36	18	24.5	24.5	24.5	24.1	24.0	<b>24.2</b>
		75	0	23.9	23.9	24.0	23.6	23.5	23.5
		1	0	23.5	23.5	23.5	23.1	23.1	23.1
	QPSK	1	1	24.5	24.5	24.4	24.1	24.1	24.1
		1	77	24.4	24.4	24.4	24.0	24.0	<b>24.2</b>
		1	78	23.4	23.5	23.5	23.0	23.1	23.1
		36	18	24.5	<b>24.5</b>	<b>24.5</b>	24.0	24.1	24.1
		75	0	23.5	23.4	23.5	23.1	23.0	23.1
		1	0	22.7	22.7	22.4	21.9	21.9	22.2
		1	1	23.5	23.3	23.5	23.3	22.8	<b>23.3</b>
	16QAM	1	77	<b>23.6</b>	23.3	23.4	23.1	23.0	23.0
		1	78	22.2	22.4	22.6	21.8	22.0	22.1
		36	18	23.5	23.4	23.6	23.1	23.0	23.1
		75	0	22.4	22.4	22.5	22.1	22.0	22.1
		1	0	21.9	21.9	21.7	21.4	21.5	21.7
		1	1	22.2	22.0	<b>22.3</b>	21.4	21.4	<b>21.8</b>
		1	77	22.2	21.9	22.0	21.7	21.7	21.7
	64QAM	1	78	22.1	22.3	21.7	21.8	21.5	21.4
		36	18	22.0	22.0	22.0	21.5	21.6	21.6
		75	0	21.9	21.9	21.9	21.6	21.5	21.6
		1	0	<b>20.4</b>	19.6	19.7	19.5	19.5	19.4
		1	1	19.9	20.1	20.2	19.6	19.3	19.4
		1	77	20.0	19.9	19.5	19.5	<b>19.8</b>	19.5
		1	78	20.0	19.6	20.0	19.5	19.4	19.4
	256QAM	36	18	20.0	19.9	19.9	19.6	19.6	19.5
		75	0	19.9	19.9	19.9	19.5	19.5	19.5

**OUTPUT POWER FOR 5G NR n7 (20.0 MHz)**

Bandwidth (MHz)	Modulation	RB Allocation	RB Offset	Conducted Average (dBm)					
				ANT 2			ANT 0		
				502000	507000	512000	502000	507000	512000
20.0	BPSK	1	0	24.0	24.0	24.1	23.6	23.5	23.6
		1	1	24.6	24.6	24.6	24.2	24.0	24.2
		1	104	<b>24.6</b>	<b>24.6</b>	24.5	24.0	24.1	<b>24.3</b>
		1	105	24.0	24.0	24.1	23.7	23.5	23.7
		50	25	24.5	24.5	24.6	24.1	24.1	24.1
		100	0	23.9	23.9	24.0	23.6	23.5	23.6
		1	0	23.4	23.4	23.4	23.2	23.0	23.1
	QPSK	1	1	24.5	24.5	24.5	24.1	24.1	24.0
		1	104	24.5	24.5	24.5	24.0	24.1	<b>24.2</b>
		1	105	23.5	23.5	23.5	23.1	23.1	23.2
		50	25	24.5	24.5	<b>24.5</b>	24.1	24.0	<b>24.2</b>
		100	0	23.4	23.4	23.5	23.0	23.1	23.1
		1	0	22.2	22.2	22.5	21.8	21.9	22.2
		1	1	23.5	23.5	23.5	<b>23.4</b>	22.9	22.7
	16QAM	1	104	<b>23.6</b>	<b>23.6</b>	23.3	23.2	23.2	23.1
		1	105	22.3	22.3	22.7	22.4	22.1	22.3
		50	25	23.5	23.5	23.5	23.0	23.0	23.1
		100	0	22.5	22.5	22.5	22.1	22.0	22.2
		1	0	21.9	21.9	22.1	<b>21.8</b>	21.8	21.8
		1	1	21.8	21.8	21.7	21.6	21.5	21.6
		1	104	21.9	21.9	22.1	21.7	21.5	21.6
	64QAM	1	105	<b>22.1</b>	<b>22.1</b>	21.8	21.4	21.8	21.5
		50	25	22.0	22.0	22.0	21.5	21.5	21.6
		100	0	22.0	22.0	22.1	21.6	21.4	21.6
		1	0	20.0	20.0	19.9	19.3	19.5	19.4
		1	1	19.8	19.8	20.0	19.5	19.5	19.5
		1	104	20.0	20.0	19.9	19.4	19.7	19.8
		1	105	19.7	19.7	19.9	19.5	19.5	<b>19.9</b>
	256QAM	50	25	19.9	19.9	<b>20.0</b>	19.5	19.4	19.6
		100	0	19.8	19.8	19.9	19.6	19.5	19.5

**OUTPUT POWER FOR 5G NR n7 (25.0 MHz)**

Bandwidth (MHz)	Modulation	RB Allocation	RB Offset	Conducted Average (dBm)					
				ANT 2			ANT 0		
				502500	507000	511500	502500	507000	511500
25.0	BPSK	1	0	24.0	23.9	23.9	23.7	23.7	23.6
		1	1	24.4	24.4	24.4	24.2	24.0	24.1
		1	131	24.5	<b>24.6</b>	24.6	24.1	<b>24.3</b>	24.2
		1	132	23.9	24.0	24.0	23.6	23.6	23.7
		64	32	24.4	24.5	24.5	24.1	24.1	24.1
		128	0	23.9	23.9	23.9	23.6	23.5	23.6
	QPSK	1	0	23.4	23.5	23.5	23.2	23.0	23.2
		1	1	24.5	24.4	24.5	24.1	24.0	<b>24.2</b>
		1	131	24.5	24.5	<b>24.5</b>	24.1	24.2	24.1
		1	132	23.5	23.5	23.5	23.2	23.2	23.2
		64	32	24.4	24.4	24.4	24.0	24.0	24.1
		128	0	23.4	23.5	23.4	23.0	23.0	23.1
	16QAM	1	0	22.5	22.6	22.5	22.2	22.5	22.1
		1	1	23.3	23.4	<b>23.8</b>	23.1	<b>23.3</b>	23.2
		1	131	23.3	23.5	23.6	23.2	23.0	22.9
		1	132	22.6	22.5	22.2	21.7	22.1	22.6
		64	32	23.4	23.4	23.4	23.1	23.0	23.0
		128	0	22.4	22.4	22.4	22.0	22.0	22.1
	64QAM	1	0	21.7	21.6	22.0	21.5	21.7	21.4
		1	1	21.7	21.9	21.7	21.7	21.6	21.9
		1	131	<b>22.3</b>	21.8	22.1	21.5	21.7	21.9
		1	132	21.7	21.7	22.2	21.8	22.0	<b>22.0</b>
		64	32	21.8	21.9	21.9	21.5	21.6	21.6
		128	0	21.9	21.8	21.9	21.5	21.5	21.6
	256QAM	1	0	20.2	19.7	<b>20.3</b>	19.4	19.7	19.4
		1	1	20.1	20.3	19.9	19.8	19.0	19.5
		1	131	20.1	19.9	19.9	19.5	19.6	<b>19.8</b>
		1	132	20.2	19.8	20.1	19.3	19.7	19.8
		64	32	19.9	19.8	19.9	19.6	19.4	19.5
		128	0	19.9	19.8	19.9	19.5	19.5	19.5

**OUTPUT POWER FOR 5G NR n7 (30.0 MHz)**

Bandwidth (MHz)	Modulation	RB Allocation	RB Offset	Conducted Average (dBm)					
				ANT 2			ANT 0		
				503000	507000	511000	503000	507000	511000
30.0	BPSK	1	0	24.0	23.9	23.8	23.6	23.4	23.6
		1	1	24.4	24.3	24.4	24.1	24.0	24.1
		1	158	24.4	<b>24.5</b>	<b>24.5</b>	24.1	24.1	<b>24.1</b>
		1	159	24.0	24.0	23.9	23.5	23.7	23.7
		80	40	24.4	24.5	24.4	24.0	24.1	24.1
		160	0	23.8	23.9	23.8	23.6	23.6	23.5
	QPSK	1	0	23.3	23.3	23.4	23.1	23.0	23.0
		1	1	24.4	24.4	24.3	24.1	24.1	24.0
		1	158	24.4	<b>24.5</b>	24.4	24.1	<b>24.2</b>	24.1
		1	159	23.4	23.6	23.4	23.0	23.1	23.0
		80	40	24.4	24.4	24.4	24.0	23.9	24.0
		160	0	23.3	23.3	23.4	23.0	23.0	23.1
	16QAM	1	0	22.4	22.1	22.2	22.1	22.1	21.7
		1	1	23.3	23.4	23.5	<b>23.6</b>	22.9	22.9
		1	158	23.4	<b>23.8</b>	23.3	23.0	23.4	23.2
		1	159	22.5	22.8	22.6	22.1	22.1	22.1
		80	40	23.3	23.4	23.4	23.0	23.0	23.1
		160	0	22.4	22.4	22.5	22.0	22.1	22.2
	64QAM	1	0	21.8	21.7	22.0	21.5	<b>21.8</b>	21.0
		1	1	21.6	21.4	21.8	21.7	20.9	21.6
		1	158	21.7	21.7	22.0	21.5	21.6	21.6
		1	159	21.8	21.8	<b>22.2</b>	21.4	21.4	21.6
		80	40	21.9	21.9	21.9	21.5	21.5	21.6
		160	0	21.8	21.9	21.9	21.5	21.6	21.6
	256QAM	1	0	19.8	20.1	20.0	19.6	19.6	19.4
		1	1	19.7	20.0	19.6	19.6	19.5	19.0
		1	158	19.9	<b>20.2</b>	19.6	19.6	19.6	19.3
		1	159	19.8	20.0	19.6	19.7	<b>19.7</b>	19.4
		80	40	19.8	19.9	19.8	19.5	19.5	19.6
		160	0	19.9	19.8	19.9	19.6	19.5	19.5

**OUTPUT POWER FOR 5G NR n7 (40.0 MHz)**

Bandwidth (MHz)	Modulation	RB Allocation	RB Offset	Conducted Average (dBm)					
				ANT 2			ANT 0		
				504000	507000	510000	504000	507000	510000
				2520.0	2535.0	2550.0	2520.0	2535.0	2550.0
40.0	BPSK	1	0	24.0	23.9	23.9	23.6	23.6	23.5
		1	1	24.5	24.4	24.4	24.2	24.1	24.0
		1	214	<b>24.5</b>	24.5	<b>24.5</b>	24.2	<b>24.2</b>	24.1
		1	215	24.1	23.9	24.0	23.7	23.7	23.7
		108	54	24.4	24.3	24.5	24.1	24.0	24.1
		216	0	24.0	23.9	23.9	23.6	23.5	23.7
	QPSK	1	0	23.4	23.3	23.4	23.0	23.0	23.0
		1	1	24.5	24.4	24.4	24.2	24.1	24.0
		1	214	24.5	24.4	24.4	24.1	24.1	24.2
		1	215	23.5	23.6	23.4	23.1	23.2	23.1
		108	54	<b>24.5</b>	24.4	24.5	24.1	24.0	<b>24.2</b>
		216	0	23.4	23.3	23.4	23.0	23.1	23.1
	16QAM	1	0	22.2	22.3	22.5	22.1	22.1	21.7
		1	1	23.5	23.6	23.1	22.9	23.2	23.1
		1	214	23.3	<b>23.8</b>	23.6	23.0	23.2	23.2
		1	215	22.5	22.7	22.6	22.1	22.0	22.1
		108	54	23.5	23.3	23.6	23.1	23.0	<b>23.2</b>
		216	0	22.5	22.4	22.5	22.1	21.9	22.1
	64QAM	1	0	21.8	21.7	21.6	21.5	21.7	21.6
		1	1	21.9	21.9	21.8	21.5	21.3	<b>21.9</b>
		1	214	21.8	21.6	22.0	21.2	21.3	<b>21.9</b>
		1	215	22.0	<b>22.1</b>	21.6	21.3	21.8	21.6
		108	54	22.0	21.9	21.9	21.6	21.5	21.6
		216	0	21.8	21.9	21.9	21.5	21.6	21.6
	256QAM	1	0	19.7	20.1	20.3	19.3	19.5	19.1
		1	1	19.8	19.9	19.7	19.4	19.4	19.0
		1	214	19.8	20.0	<b>20.4</b>	<b>20.1</b>	19.6	20.0
		1	215	20.4	19.4	20.3	19.6	19.5	19.4
		108	54	19.9	19.8	19.9	19.5	19.5	19.7
		216	0	20.0	19.8	19.9	19.6	19.4	19.6

**OUTPUT POWER FOR 5G NR n7 (50.0 MHz)**

Bandwidth (MHz)	Modulation	RB Allocation	RB Offset	Conducted Average (dBm)					
				ANT 2			ANT 0		
				505000	507000	509000	505000	507000	509000
				2525.0	2535.0	2545.0	2525.0	2535.0	2545.0
50.0	BPSK	1	0	23.9	24.0	23.9	23.7	23.7	23.6
		1	1	24.4	24.4	24.4	23.8	24.2	24.1
		1	268	24.5	<b>24.6</b>	24.4	23.8	<b>24.2</b>	24.2
		1	269	24.0	24.0	24.0	23.7	23.6	23.7
		135	67	24.3	24.4	24.4	23.7	24.1	24.1
		270	0	23.9	23.9	23.9	23.5	23.6	23.6
	QPSK	1	0	23.4	23.3	23.4	23.2	23.0	23.2
		1	1	24.5	24.4	24.4	23.7	24.2	24.1
		1	268	<b>24.5</b>	<b>24.5</b>	24.5	23.8	<b>24.2</b>	24.2
		1	269	23.6	23.5	23.6	23.2	23.2	23.2
		135	67	24.4	24.3	24.5	23.6	24.0	24.1
		270	0	23.3	23.4	23.4	23.1	23.1	23.1
	16QAM	1	0	22.5	22.3	22.3	22.2	22.0	22.3
		1	1	23.2	23.6	23.6	23.3	23.3	23.3
		1	268	<b>23.7</b>	23.4	23.5	23.3	<b>23.4</b>	23.3
		1	269	22.3	22.5	22.7	22.1	22.1	22.2
		135	67	23.4	23.3	23.4	23.0	23.1	23.1
		270	0	22.3	22.3	22.4	22.0	22.0	22.0
	64QAM	1	0	21.9	21.9	21.7	21.5	21.3	21.3
		1	1	21.7	22.1	21.9	21.5	21.5	21.6
		1	268	21.9	<b>22.1</b>	21.9	<b>21.9</b>	21.5	21.8
		1	269	21.7	22.0	21.9	21.6	21.3	21.9
		135	67	21.8	21.9	21.9	21.6	21.5	21.6
		270	0	21.9	21.8	22.0	21.5	21.5	21.6
	256QAM	1	0	20.0	19.9	19.8	<b>20.0</b>	19.5	19.4
		1	1	20.0	20.1	20.0	19.6	19.7	19.7
		1	268	<b>20.4</b>	19.7	20.0	19.7	19.8	19.5
		1	269	20.2	19.9	20.1	19.8	19.6	19.4
		135	67	20.0	19.9	19.8	19.5	19.4	19.6
		270	0	19.9	19.8	19.9	19.5	19.5	19.6

### 8.3. LTE BAND 12 AND 5G NR n12

#### LTE BAND 12

<b>Test Engineer ID:</b>	24522NV and 39005RA	<b>Test Date:</b>	2024-01-19 to 2024-04-02
--------------------------	---------------------	-------------------	--------------------------

#### OUTPUT POWER FOR LTE BAND 12 (1.4 MHz)

Bandwidth (MHz)	Modulation	RB Allocation	RB Offset	Conducted Average (dBm)					
				ANT 0			ANT 1		
				23017	23095	23173	23017	23095	23173
1.4	QPSK	1	0	24.1	24.1	24.1	23.6	24.1	24.2
		1	3	23.9	24.0	24.0	23.6	24.1	24.0
		1	5	24.1	24.1	24.2	23.6	24.1	24.2
		3	0	24.0	24.1	24.1	23.5	24.1	24.1
		3	1	24.0	24.0	24.1	23.5	24.0	24.1
		3	3	24.0	24.0	24.0	23.5	24.0	24.0
	16QAM	6	0	24.1	24.2	<b>24.2</b>	23.6	<b>24.2</b>	<b>24.2</b>
		1	0	23.4	23.3	23.7	23.0	23.4	23.6
		1	3	23.5	23.3	<b>23.7</b>	23.1	23.3	<b>23.6</b>
		1	5	23.4	23.4	23.6	23.0	23.4	23.6
		3	0	23.4	23.2	23.3	22.9	23.2	23.3
		3	1	23.3	23.1	23.3	22.9	23.2	23.3
	64QAM	3	3	23.3	23.2	23.3	22.8	23.2	23.3
		6	0	22.7	22.7	22.6	22.2	22.7	22.5
		1	0	<b>22.9</b>	22.8	22.8	22.2	<b>22.7</b>	22.7
		1	3	22.9	22.7	22.7	22.2	22.7	22.6
		1	5	22.8	22.7	22.7	22.3	22.7	22.6
		3	0	22.6	22.7	22.7	22.1	22.6	22.5
	256QAM	3	1	22.6	22.6	22.6	22.1	22.5	22.5
		3	3	22.5	22.6	22.6	22.1	22.5	22.4
		6	0	21.7	21.7	21.8	21.1	21.6	21.4
		1	0	19.8	19.7	19.8	19.3	19.7	19.4
		1	3	<b>19.9</b>	19.7	19.7	19.2	<b>19.7</b>	19.4
		1	5	19.8	19.7	19.8	19.2	19.6	19.4

#### OUTPUT POWER FOR LTE BAND 12 (3.0 MHz)

Bandwidth (MHz)	Modulation	RB Allocation	RB Offset	Conducted Average (dBm)					
				ANT 0			ANT 1		
				23025	23095	23165	23017	23095	23173
3.0	QPSK	1	0	24.0	24.1	24.1	24.1	24.0	24.2
		1	8	23.9	24.0	23.9	23.9	23.9	24.1
		1	14	23.9	24.1	<b>24.2</b>	24.1	24.0	<b>24.2</b>
		8	0	24.1	24.1	24.1	24.1	24.1	24.1
		8	4	24.0	24.1	24.0	24.1	24.1	24.1
		8	7	24.0	24.1	24.1	24.1	24.1	24.1
	16QAM	15	0	24.1	24.0	24.0	24.1	24.0	24.0
		1	0	<b>23.7</b>	<b>23.7</b>	23.4	23.5	<b>23.7</b>	<b>23.7</b>
		1	8	23.6	23.6	23.2	23.4	23.5	23.5
		1	14	23.7	23.6	23.2	23.4	23.6	23.5
		8	0	22.7	22.7	22.7	22.7	22.7	22.7
		8	4	22.7	22.6	22.7	22.6	22.7	22.6
	64QAM	8	7	22.7	22.6	22.7	22.6	22.6	22.6
		15	0	22.7	22.6	22.6	22.7	22.6	22.6
		1	0	22.7	22.9	22.6	22.1	22.7	<b>22.7</b>
		1	8	22.6	<b>22.8</b>	22.5	22.0	22.4	22.5
		1	14	22.6	<b>22.9</b>	22.6	22.0	22.7	22.6
		8	0	21.7	21.6	21.8	21.1	21.6	21.7
	256QAM	8	4	21.7	21.6	21.7	21.1	21.6	21.6
		8	7	21.7	21.6	21.7	21.1	21.6	21.6
		15	0	21.7	21.6	21.7	21.1	21.5	21.6
		1	0	19.8	<b>20.0</b>	19.9	19.3	19.8	<b>19.8</b>
		1	8	19.7	19.8	19.8	19.2	19.6	19.8
		1	14	19.7	19.9	19.8	19.2	19.6	19.8

**OUTPUT POWER FOR LTE BAND 12 (5.0 MHz)**

Bandwidth (MHz)	Modulation	RB Allocation	RB Offset	Conducted Average (dBm)					
				ANT 0			ANT 1		
				23035 701.5	23095 707.5	23155 713.5	23035 701.5	23095 707.5	23155 713.5
5.0	QPSK	1	0	24.0	24.1	<b>24.1</b>	23.7	<b>24.1</b>	24.0
		1	12	24.0	23.9	24.1	23.6	24.1	24.0
		1	24	24.0	24.0	24.1	23.6	24.1	<b>24.1</b>
		12	0	24.0	24.1	24.1	23.7	24.1	24.1
		12	7	24.0	24.1	24.1	23.6	24.1	24.1
		12	13	24.0	24.1	24.1	23.6	24.1	24.1
	16QAM	25	0	24.0	24.1	24.1	23.7	24.1	24.1
		1	0	23.6	23.7	<b>23.7</b>	23.1	23.6	<b>23.7</b>
		1	12	23.5	23.3	23.5	23.0	23.4	23.4
		1	24	23.5	23.6	23.6	23.1	23.5	23.5
		12	0	22.7	22.7	22.7	22.2	22.7	22.7
		12	7	22.6	22.6	22.7	22.2	22.6	22.7
	64QAM	12	13	22.6	22.6	22.7	22.1	22.6	22.6
		25	0	22.6	22.6	22.6	22.1	22.6	22.6
		1	0	<b>23.1</b>	22.7	22.8	22.4	<b>22.7</b>	22.6
		1	12	22.9	22.6	22.7	22.3	22.7	22.5
		1	24	22.9	22.7	22.6	22.4	22.7	22.5
		12	0	21.7	21.7	21.7	21.1	21.6	21.6
	256QAM	12	7	21.7	21.6	21.7	21.1	21.5	21.6
		12	13	21.6	21.6	21.6	21.1	21.5	21.5
		25	0	21.6	21.7	21.7	21.1	21.6	21.6
		1	0	<b>19.9</b>	19.8	19.7	19.6	19.5	<b>19.8</b>
		1	12	19.8	19.6	19.5	19.4	19.3	19.7
		1	24	19.9	19.7	19.6	19.5	19.4	19.7
	256QAM	12	0	19.6	19.6	19.7	19.1	19.6	19.6
12		7	19.6	19.6	19.6	19.1	19.5	19.5	
12		13	19.6	19.6	19.6	19.0	19.5	19.5	
25		0	19.6	19.6	19.7	19.0	19.6	19.6	

**OUTPUT POWER FOR LTE BAND 12 (10.0 MHz)**

Bandwidth (MHz)	Modulation	RB Allocation	RB Offset	Conducted Average (dBm)					
				ANT 0			ANT 1		
				23060 704.0	23095 707.5	23130 711.0	23060 704.0	23095 707.5	23130 711.0
10.0	QPSK	1	0	24.1	23.4	<b>24.2</b>	<b>24.0</b>	23.7	23.9
		1	25	24.1	23.3	24.1	23.9	23.6	23.8
		1	49	24.1	23.3	24.0	23.8	23.6	23.8
		25	0	23.1	22.4	23.1	22.9	22.7	22.9
		25	12	23.1	22.4	23.1	22.9	22.7	22.8
		25	25	23.1	22.3	23.0	22.8	22.6	22.8
	16QAM	50	0	23.1	22.4	23.1	22.9	22.7	22.8
		1	0	<b>23.8</b>	23.1	23.8	23.1	<b>23.1</b>	23.0
		1	25	23.8	23.1	23.7	23.0	23.1	22.9
		1	49	23.6	23.0	23.6	22.9	23.1	22.8
		25	0	22.5	21.8	22.5	21.9	21.8	21.8
		25	12	22.5	21.7	22.5	21.8	21.7	21.8
	64QAM	25	25	22.5	21.7	22.5	21.8	21.7	21.8
		50	0	22.5	21.7	22.5	21.8	21.7	21.8
		1	0	<b>22.8</b>	22.0	22.8	22.1	22.0	<b>22.2</b>
		1	25	22.7	22.0	22.7	22.0	21.6	22.1
		1	49	22.6	21.8	22.6	21.9	21.6	22.0
		25	0	21.6	20.8	21.6	20.9	20.8	20.9
	256QAM	25	12	21.5	20.8	21.5	20.8	20.7	20.8
		25	25	21.5	20.8	21.5	20.8	20.7	20.8
		50	0	21.5	20.8	21.5	20.8	20.7	20.8
		1	0	19.6	18.7	<b>19.7</b>	19.0	19.3	19.0
		1	25	19.6	18.7	19.6	18.9	<b>19.7</b>	18.9
		1	49	19.6	18.6	19.5	18.8	<b>19.7</b>	18.8
	256QAM	25	0	19.6	18.8	19.6	18.9	19.6	18.9
25		12	19.5	18.8	19.6	18.9	19.6	18.9	
25		25	19.5	18.7	19.5	18.8	19.5	18.8	
50		0	19.5	18.7	19.5	18.8	19.6	18.8	

**5G NR n12**

Test Engineer ID:	19210AL	Test Date:	2024-02-06
-------------------	---------	------------	------------

**OUTPUT POWER FOR 5G NR n12 (5.0 MHz)**

Bandwidth (MHz)	Modulation	RB Allocation	RB Offset	Conducted Average (dBm)					
				ANT 0			ANT 1		
				140300 701.5	141500 707.5	142700 713.5	140300 701.5	141500 707.5	142700 713.5
5.0	BPSK	1	0	23.9	23.8	23.7	23.2	23.7	23.7
		1	1	24.3	<b>24.4</b>	24.2	23.5	24.2	<b>24.2</b>
		1	23	24.2	24.4	24.2	23.4	24.2	<b>24.2</b>
		1	24	23.7	23.8	23.8	23.2	23.7	23.8
		12	6	24.2	24.3	24.3	23.5	24.2	24.2
		25	0	23.8	23.7	23.7	23.3	23.8	23.8
	QPSK	1	0	23.4	23.3	23.3	22.8	23.3	23.2
		1	1	24.3	24.2	24.3	23.4	24.2	24.2
		1	23	<b>24.4</b>	24.2	24.3	23.4	24.3	24.2
		1	24	23.3	23.3	23.3	22.7	23.2	23.2
		12	6	24.3	24.2	24.2	23.4	<b>24.3</b>	24.2
		25	0	23.3	23.3	23.3	22.8	23.3	23.3
	16QAM	1	0	22.1	22.2	22.4	21.6	21.8	22.1
		1	1	<b>23.5</b>	23.3	22.9	22.6	<b>23.6</b>	23.5
		1	23	23.5	23.4	23.5	22.4	23.3	23.3
		1	24	22.0	22.2	22.2	21.7	22.1	22.2
		12	6	23.4	23.4	23.4	22.7	23.3	23.2
		25	0	22.4	22.3	22.3	21.8	22.2	22.3
	64QAM	1	0	21.8	21.9	21.3	21.4	21.8	21.7
		1	1	22.0	21.6	<b>22.0</b>	21.0	21.9	21.8
		1	23	21.8	21.7	21.3	20.9	21.9	<b>22.1</b>
		1	24	21.5	<b>22.0</b>	21.9	21.1	21.4	21.9
		12	6	21.8	21.9	21.8	21.1	21.7	21.8
		25	0	21.9	21.9	21.7	21.2	21.8	21.8
256QAM	1	0	19.7	20.0	19.7	19.1	19.5	20.0	
	1	1	<b>20.2</b>	19.7	19.7	19.3	19.8	19.9	
	1	23	20.1	19.4	19.8	19.1	19.5	19.6	
	1	24	19.9	19.6	19.7	19.2	19.5	<b>20.0</b>	
	12	6	19.8	19.7	19.8	19.2	19.8	19.8	
	25	0	19.9	19.8	19.7	19.3	19.7	19.7	

**OUTPUT POWER FOR 5G NR n12 (10.0 MHz)**

Bandwidth (MHz)	Modulation	RB Allocation	RB Offset	Conducted Average (dBm)					
				ANT 0			ANT 1		
				140800 704.0	141500 707.5	142200 711.0	140800 704.0	141500 707.5	142200 711.0
10.0	BPSK	1	0	23.8	23.8	23.8	23.7	23.7	23.8
		1	1	24.3	24.3	<b>24.3</b>	24.2	24.2	24.2
		1	50	24.3	24.3	24.3	24.2	24.2	<b>24.3</b>
		1	51	23.8	23.8	23.7	23.8	23.7	23.6
		25	12	24.2	24.2	24.3	24.2	24.1	24.2
		50	0	23.7	23.7	23.7	23.6	23.6	23.6
	QPSK	1	0	23.3	23.3	23.2	23.1	23.2	23.2
		1	1	<b>24.3</b>	24.3	24.2	24.2	24.2	24.2
		1	50	24.3	24.2	24.2	<b>24.3</b>	24.2	24.2
		1	51	23.2	23.2	23.2	23.2	23.2	23.2
		25	12	24.2	24.2	24.3	24.1	24.1	24.1
		50	0	23.3	23.3	23.2	23.2	23.1	23.2
	16QAM	1	0	22.4	22.4	22.3	22.2	22.6	22.2
		1	1	23.2	23.0	<b>23.5</b>	23.3	<b>23.4</b>	22.8
		1	50	23.5	23.4	23.3	23.3	22.8	23.3
		1	51	22.4	22.2	22.2	22.2	21.8	22.2
		25	12	23.3	23.3	23.3	23.2	23.3	23.1
		50	0	22.3	22.3	22.2	22.2	22.2	22.1
	64QAM	1	0	21.5	21.8	22.2	21.6	22.0	21.3
		1	1	22.1	21.9	21.9	21.5	21.5	21.5
		1	50	21.8	21.4	<b>22.3</b>	21.7	21.2	<b>22.2</b>
		1	51	22.2	21.8	22.2	21.4	21.9	22.0
		25	12	21.8	21.7	21.8	21.6	21.7	21.7
		50	0	21.7	21.9	21.8	21.7	21.7	21.7
256QAM	1	0	20.1	19.9	19.7	19.9	<b>20.3</b>	19.5	
	1	1	19.5	19.8	19.7	19.5	20.2	19.5	
	1	50	20.0	<b>20.3</b>	19.7	19.1	19.8	19.4	
	1	51	19.5	19.8	20.1	19.8	19.7	19.3	
	25	12	19.7	19.7	19.7	19.7	19.8	19.6	
	50	0	19.7	19.7	19.8	19.7	19.7	19.8	

**OUTPUT POWER FOR 5G NR n12 (15.0 MHz)**

Bandwidth (MHz)	Modulation	RB Allocation	RB Offset	Conducted Average (dBm)					
				ANT 0			ANT 1		
				141300	141500	141700	141300	141500	141700
15.0	BPSK	1	0	23.7	23.8	23.7	23.6	23.7	23.7
		1	1	24.3	<b>24.4</b>	24.2	24.1	24.2	24.1
		1	77	24.2	24.3	24.3	24.2	<b>24.2</b>	24.1
		1	78	23.7	23.9	23.6	23.6	23.7	23.5
		36	18	24.2	24.3	24.2	24.1	24.2	24.2
		75	0	23.8	23.8	23.8	23.7	23.7	23.7
		75	0	23.2	23.2	23.3	23.3	23.0	23.2
	QPSK	1	1	24.2	24.3	<b>24.3</b>	24.2	24.1	24.1
		1	77	24.3	24.3	24.3	24.2	24.1	24.2
		1	78	23.2	23.3	23.3	23.2	23.1	23.2
		36	18	<b>24.3</b>	24.2	24.2	24.1	24.2	<b>24.3</b>
		75	0	23.3	23.3	23.2	23.2	23.2	23.2
		1	0	22.3	22.3	22.3	21.8	22.2	22.3
		1	1	23.1	23.2	<b>23.7</b>	23.2	22.9	<b>23.3</b>
	16QAM	1	77	23.5	23.4	23.3	23.1	23.2	23.0
		1	78	22.5	22.3	22.3	22.1	22.0	22.3
		36	18	23.3	23.2	23.3	23.2	23.2	23.1
		75	0	22.3	22.3	22.3	22.1	22.2	22.2
		1	0	21.8	21.6	22.1	21.8	21.7	21.5
		1	1	<b>22.2</b>	21.6	22.0	<b>21.9</b>	21.7	21.7
		1	77	21.7	21.3	21.7	21.7	21.8	21.4
	64QAM	1	78	21.9	21.8	21.4	21.5	21.5	21.7
		36	18	21.8	21.7	21.7	21.7	21.6	21.7
		75	0	21.8	21.8	21.7	21.7	21.6	21.5
		1	0	19.4	20.1	19.6	19.7	19.9	19.7
		1	1	19.7	19.7	20.0	19.6	20.0	19.5
		1	77	19.7	19.1	19.7	19.6	<b>20.1</b>	19.6
		1	78	<b>20.2</b>	19.4	19.4	19.7	19.5	19.9
	256QAM	36	18	19.8	19.7	19.8	19.7	19.6	19.7
		75	0	19.7	19.8	19.8	19.7	19.8	19.7



### 8.4. LTE BAND 13

<b>Test Engineer ID:</b>	43576TS, 39005RA and 50813CM	<b>Test Date:</b>	2024-01-12 to 2024-04-02
--------------------------	---------------------------------	-------------------	--------------------------

#### OUTPUT POWER FOR LTE BAND 13 (5.0 MHz)

Bandwidth (MHz)	Modulation	RB Allocation	RB Offset	Conducted Average (dBm)					
				ANT 0			ANT 1		
				23205	23230	23255	23205	23230	23255
5.0	QPSK	1	0	24.4	24.1	24.4	<b>24.1</b>	23.7	23.9
		1	12	24.4	24.3	<b>24.4</b>	24.0	23.6	23.9
		1	24	24.4	24.2	24.4	24.0	23.7	23.9
		12	0	23.4	23.2	23.3	23.0	22.6	22.9
		12	6	23.4	23.2	23.3	23.0	22.6	22.9
		12	11	23.4	23.2	23.3	22.9	22.5	22.9
	16QAM	25	0	23.4	23.2	23.5	23.0	22.6	22.9
		1	0	23.5	23.4	23.4	23.4	23.3	23.4
		1	12	<b>23.5</b>	23.4	23.4	23.3	23.1	23.4
		1	24	23.4	23.4	23.4	23.4	23.3	<b>23.5</b>
		12	0	22.4	22.2	22.4	22.5	22.4	22.4
		12	6	22.4	22.2	22.4	22.4	22.3	22.4
	64QAM	12	11	22.4	22.2	22.4	22.4	22.3	22.4
		25	0	22.5	22.2	22.5	22.5	22.4	22.4
		1	0	22.5	22.5	22.6	<b>22.7</b>	22.5	22.6
		1	12	22.6	22.6	22.6	22.6	22.4	22.6
		1	24	22.5	22.5	<b>22.7</b>	22.6	22.4	22.6
		12	0	21.4	21.3	21.5	21.5	21.5	21.4
	256QAM	12	6	21.4	21.3	21.5	21.5	21.4	21.4
		12	11	21.4	21.2	21.5	21.5	21.5	21.4
		25	0	21.4	21.2	21.5	21.5	21.5	21.4
		1	0	19.4	19.4	<b>19.6</b>	<b>19.6</b>	19.6	19.6
		1	12	19.4	19.3	19.5	19.5	19.5	19.5
		1	24	19.4	19.3	19.5	19.5	19.4	19.5

#### OUTPUT POWER FOR LTE BAND 13 (10.0 MHz)

Bandwidth (MHz)	Modulation	RB Allocation	RB Offset	Conducted Average (dBm)					
				ANT 0			ANT 1		
				N/A	23230	N/A	N/A	23230	N/A
10.0	QPSK	1	0		<b>24.5</b>			<b>24.2</b>	
		1	24		<b>24.5</b>			24.1	
		1	49		24.4			24.1	
		25	0		23.3			23.1	
		25	12		23.3			23.1	
		25	24		23.2			23.1	
	16QAM	50	0		23.3			23.1	
		1	0		<b>23.4</b>			23.4	
		1	24		23.4			23.4	
		1	49		<b>23.4</b>			<b>23.4</b>	
		25	0		22.3			22.5	
		25	12		22.3			22.4	
	64QAM	25	24		22.3			22.4	
		50	0		22.3			22.5	
		1	0		22.3			<b>22.5</b>	
		1	24		<b>22.3</b>			22.5	
		1	49		22.2			<b>22.5</b>	
		25	0		21.3			21.5	
	256QAM	25	12		21.3			21.5	
		25	24		21.3			21.5	
		50	0		21.3			21.5	
		1	0		19.4			<b>19.6</b>	
		1	24		<b>19.6</b>			19.5	
		1	49		19.4			19.5	

## 8.5. LTE BAND 14 AND 5G NR n14

### LTE BAND 14

<b>Test Engineer ID:</b>	24937ZM, 39005RA and 50813CM	<b>Test Date:</b>	2024-01-19 to 2024-04-02
--------------------------	---------------------------------	-------------------	--------------------------

### OUTPUT POWER FOR LTE BAND 14 (5.0 MHz)

Bandwidth (MHz)	Modulation	RB Allocation	RB Offset	Conducted Average (dBm)					
				ANT 0			ANT 1		
				23305	23330	23355	23305	23330	23355
5.0	QPSK	1	0	790.5	793.0	795.5	790.5	793.0	795.5
		1	12	24.5	24.3	24.4	24.3	23.8	24.2
		1	24	24.5	24.3	24.5	24.2	23.8	24.1
		12	0	24.5	24.2	24.4	24.2	23.8	24.2
		12	6	23.5	23.6	23.5	23.2	23.1	23.2
		12	11	23.4	23.6	23.5	23.2	23.0	23.2
		25	0	23.4	23.5	23.5	23.2	23.1	23.2
	16QAM	1	0	23.6	23.9	23.5	23.3	23.3	23.3
		1	12	23.5	24.0	23.5	23.1	23.1	23.1
		1	24	23.6	23.8	23.5	23.3	23.4	23.3
		12	0	22.5	23.0	22.5	22.2	22.3	22.2
		12	6	22.5	22.9	22.4	22.2	22.3	22.1
		12	11	22.4	22.9	22.4	22.2	22.3	22.1
		25	0	22.5	22.9	22.5	22.2	22.4	22.2
	64QAM	1	0	22.7	23.0	22.7	22.4	22.4	22.4
		1	12	22.6	23.1	22.7	22.4	22.4	22.4
		1	24	22.7	23.0	22.7	22.4	22.5	22.4
		12	0	21.5	21.8	21.5	21.1	21.3	21.2
		12	6	21.5	21.8	21.5	21.1	21.3	21.2
		12	11	21.5	21.8	21.5	21.1	21.3	21.2
		25	0	21.5	21.9	21.5	21.2	21.3	21.2
	256QAM	1	0	19.6	19.9	19.7	19.3	19.4	19.3
		1	12	19.6	19.8	19.7	19.3	19.2	19.2
		1	24	19.6	19.9	19.7	19.3	19.3	19.2
		12	0	19.5	20.0	19.5	19.2	19.3	19.2
		12	6	19.5	20.0	19.5	19.2	19.3	19.2
		12	11	19.5	20.0	19.5	19.2	19.2	19.1
		25	0	19.5	20.0	19.5	19.2	19.3	19.2

### OUTPUT POWER FOR LTE BAND 14 (10.0 MHz)

Bandwidth (MHz)	Modulation	RB Allocation	RB Offset	Conducted Average (dBm)					
				ANT 0			ANT 1		
				N/A	23330	N/A	N/A	23330	N/A
10.0	QPSK	1	0	N/A	24.4	N/A	N/A	24.0	N/A
		1	24	N/A	24.2	N/A	N/A	23.9	N/A
		1	49	N/A	24.2	N/A	N/A	23.9	N/A
		25	0	N/A	23.5	N/A	N/A	23.1	N/A
		25	12	N/A	23.5	N/A	N/A	23.1	N/A
		25	24	N/A	23.5	N/A	N/A	23.1	N/A
		50	0	N/A	23.5	N/A	N/A	23.1	N/A
	16QAM	1	0	N/A	23.8	N/A	N/A	23.5	N/A
		1	24	N/A	23.7	N/A	N/A	23.5	N/A
		1	49	N/A	23.7	N/A	N/A	23.4	N/A
		25	0	N/A	22.9	N/A	N/A	22.4	N/A
		25	12	N/A	22.9	N/A	N/A	22.4	N/A
		25	24	N/A	22.9	N/A	N/A	22.4	N/A
		50	0	N/A	22.9	N/A	N/A	22.4	N/A
	64QAM	1	0	N/A	22.9	N/A	N/A	22.3	N/A
		1	24	N/A	22.9	N/A	N/A	22.3	N/A
		1	49	N/A	22.9	N/A	N/A	22.3	N/A
		25	0	N/A	22.0	N/A	N/A	21.4	N/A
		25	12	N/A	22.0	N/A	N/A	21.4	N/A
		25	24	N/A	22.0	N/A	N/A	21.3	N/A
		50	0	N/A	22.0	N/A	N/A	21.4	N/A
	256QAM	1	0	N/A	20.0	N/A	N/A	19.4	N/A
		1	24	N/A	19.9	N/A	N/A	19.3	N/A
		1	49	N/A	19.8	N/A	N/A	19.3	N/A
		25	0	N/A	20.0	N/A	N/A	19.4	N/A
		25	12	N/A	20.0	N/A	N/A	19.3	N/A
		25	24	N/A	19.9	N/A	N/A	19.3	N/A
		50	0	N/A	19.9	N/A	N/A	19.3	N/A

**5G NR n14**

<b>Test Engineer ID:</b>	27966PV	<b>Test Date:</b>	2024-03-06
--------------------------	---------	-------------------	------------

**OUTPUT POWER FOR 5G NR n14 (5.0 MHz)**

Bandwidth (MHz)	Modulation	RB Allocation	RB Offset	Conducted Average (dBm)					
				ANT 0			ANT 1		
				158100 790.5	158600 793.0	159100 795.5	158100 790.5	158600 793.0	159100 795.5
5.0	BPSK	1	0	23.8	23.7	23.8	23.5	23.6	23.6
		1	1	24.3	24.3	24.3	24.0	24.1	24.0
		1	23	24.3	24.3	24.2	24.0	23.9	24.0
		1	24	23.7	23.7	23.7	23.5	23.5	23.4
		12	6	24.3	24.2	24.2	24.0	24.1	23.9
		25	0	23.7	23.8	23.7	23.5	23.5	23.5
	QPSK	1	0	23.3	23.2	23.2	23.0	23.1	23.1
		1	1	24.3	24.3	24.3	24.0	24.0	24.0
		1	23	24.3	24.2	24.2	24.0	24.1	24.0
		1	24	23.2	23.2	23.1	22.9	23.1	23.0
		12	6	24.1	24.3	24.1	24.0	24.0	24.0
		25	0	23.2	23.2	23.2	23.0	23.0	22.9
	16QAM	1	0	22.2	22.2	22.6	22.1	22.2	21.8
		1	1	23.4	23.2	23.5	22.8	23.0	23.1
		1	23	23.1	23.6	23.2	22.8	22.7	23.0
		1	24	22.1	22.2	22.2	22.1	21.9	22.1
		12	6	23.3	23.2	23.2	22.9	23.0	23.0
		25	0	22.2	22.2	22.1	21.9	21.9	21.9
	64QAM	1	0	21.6	21.7	21.7	21.4	21.7	20.9
		1	1	21.5	21.7	21.5	21.8	21.7	21.4
		1	23	21.4	21.8	21.5	21.2	21.3	20.9
		1	24	21.5	21.6	21.9	21.7	21.3	21.8
		12	6	21.7	21.7	21.7	21.4	21.4	21.4
		25	0	21.8	21.7	21.7	21.4	21.4	21.4
	256QAM	1	0	19.5	20.0	19.3	19.1	19.3	19.4
1		1	20.2	19.2	19.2	19.8	19.6	19.1	
1		23	19.7	19.8	19.9	19.2	19.5	19.3	
1		24	19.5	20.0	20.2	19.9	19.8	19.8	
12		6	19.8	19.7	19.7	19.4	19.4	19.4	
25		0	19.8	19.7	19.7	19.6	19.5	19.4	

**OUTPUT POWER FOR 5G NR n14 (10.0 MHz)**

Bandwidth (MHz)	Modulation	RB Allocation	RB Offset	Conducted Average (dBm)					
				ANT 0			ANT 1		
				N/A	158600 793.0	N/A	N/A	158600 793.0	N/A
10.0	BPSK	1	0		23.8			23.5	
		1	1		24.3			24.0	
		1	50		24.2			24.0	
		1	51		23.7			23.5	
		25	12		24.3			23.9	
		50	0		23.6			23.5	
	QPSK	1	0		23.3			23.0	
		1	1		24.2			24.0	
		1	50		24.2			23.9	
		1	51		23.2			22.9	
		25	12		24.2			24.0	
		50	0		23.1			22.9	
	16QAM	1	0		21.9			22.2	
		1	1		23.2			23.0	
		1	50		23.3			22.9	
		1	51		21.8			21.8	
		25	12		23.2			23.0	
		50	0		22.2			21.9	
	64QAM	1	0		21.6			21.4	
		1	1		21.8			21.8	
		1	50		21.5			21.6	
		1	51		21.5			21.5	
		25	12		21.7			21.4	
		50	0		21.7			21.5	
	256QAM	1	0		19.8			20.1	
1		1		19.8			19.5		
1		50		19.7			19.5		
1		51		20.2			19.3		
25		12		19.7			19.5		
50		0		19.7			19.6		

### 8.6. LTE BAND 17

<b>Test Engineer ID:</b>	39005RA and 24522NV	<b>Test Date:</b>	2024-01-19 to 2024-04-02
--------------------------	---------------------	-------------------	--------------------------

#### OUTPUT POWER FOR LTE BAND 17 (5.0 MHz)

Bandwidth (MHz)	Modulation	RB Allocation	RB Offset	Conducted Average (dBm)					
				ANT 0			ANT 1		
				23755 706.5	23790 710.0	23825 713.5	23755 706.5	23790 710.0	23825 713.5
5.0	QPSK	1	0	24.3	24.3	<b>24.3</b>	<b>23.9</b>	23.7	<b>23.9</b>
		1	12	24.3	24.3	24.1	23.8	23.6	23.8
		1	24	24.3	24.3	24.3	23.8	23.6	23.8
		12	0	23.3	23.3	23.3	22.9	22.7	22.9
		12	6	23.3	23.3	23.3	22.9	22.7	22.9
		12	11	23.3	23.3	23.3	22.9	22.7	22.9
	16QAM	25	0	23.3	23.3	23.3	22.9	22.7	22.9
		1	0	<b>23.7</b>	23.7	<b>23.7</b>	23.0	23.0	<b>23.1</b>
		1	12	23.6	23.5	23.6	22.8	22.8	22.9
		1	24	23.7	23.6	23.5	22.9	<b>23.1</b>	22.9
		12	0	22.5	22.5	22.6	21.9	22.0	21.8
		12	6	22.5	22.4	22.5	21.9	22.0	21.8
	64QAM	12	11	22.5	22.4	22.5	21.9	22.0	21.8
		25	0	22.5	22.5	22.5	21.9	22.0	21.9
		1	0	22.8	22.6	<b>22.8</b>	<b>22.1</b>	21.9	22.1
		1	12	22.7	22.5	22.8	22.0	21.8	22.1
		1	24	22.7	22.6	22.7	22.1	22.0	22.1
		12	0	21.6	21.5	21.5	20.9	21.0	20.8
	256QAM	12	6	21.6	21.5	21.5	20.9	21.0	20.8
		12	11	21.5	21.5	21.5	20.9	21.0	20.8
		25	0	21.5	21.5	21.6	20.9	21.0	20.9
		1	0	19.6	<b>19.7</b>	<b>19.7</b>	19.0	<b>19.3</b>	19.1
		1	12	19.6	19.6	19.6	18.9	19.2	19.0
		1	24	19.5	19.6	19.6	18.9	19.2	19.0

#### OUTPUT POWER FOR LTE BAND 17 (10.0 MHz)

Bandwidth (MHz)	Modulation	RB Allocation	RB Offset	Conducted Average (dBm)					
				ANT 0			ANT 1		
				23780 709.0	23790 710.0	23800 711.0	23780 709.0	23790 710.0	23800 711.0
10.0	QPSK	1	0	<b>24.3</b>	24.2	24.2	<b>23.9</b>	23.8	<b>23.9</b>
		1	24	24.2	24.2	24.1	23.8	23.7	23.9
		1	49	24.1	24.1	24.1	23.8	23.6	23.8
		25	0	23.2	23.2	23.2	22.9	22.8	22.9
		25	12	23.2	23.2	23.2	22.9	22.7	22.9
		25	24	23.2	23.2	23.2	22.8	22.7	22.8
	16QAM	50	0	23.2	23.2	23.2	22.9	22.8	22.9
		1	0	23.6	23.6	<b>23.7</b>	23.2	<b>23.3</b>	23.0
		1	24	23.5	23.5	23.5	23.0	23.2	22.9
		1	49	23.5	23.6	23.5	22.9	23.1	22.8
		25	0	22.5	22.5	22.5	21.9	22.1	21.9
		25	12	22.5	22.4	22.5	21.9	22.0	21.9
	64QAM	25	24	22.4	22.4	22.5	21.8	22.0	21.8
		50	0	22.5	22.5	22.5	21.9	22.1	21.9
		1	0	<b>22.8</b>	22.7	22.8	<b>22.2</b>	22.2	22.2
		1	24	22.7	22.7	22.7	22.1	22.1	22.1
		1	49	22.7	22.7	22.7	22.1	22.1	22.0
		25	0	21.6	21.4	21.5	20.9	21.1	20.9
	256QAM	25	12	21.5	21.4	21.5	20.9	21.1	20.9
		25	24	21.5	21.4	21.5	20.8	21.0	20.9
		50	0	21.5	21.5	21.6	20.9	21.1	20.9
		1	0	<b>19.7</b>	19.5	19.6	19.3	<b>19.3</b>	19.0
		1	24	19.6	19.5	19.6	19.2	19.1	18.9
		1	49	19.6	19.5	19.5	19.1	19.1	18.9

## 8.7. LTE BAND 25 AND 5G NR n25

### LTE BAND 25

<b>Test Engineer ID:</b>	43576TS, 50813CM and 28529JB	<b>Test Date:</b>	2024-01-12 to 2024-03-19
--------------------------	---------------------------------	-------------------	--------------------------

### OUTPUT POWER FOR LTE BAND 25 (1.4 MHz)

Bandwidth (MHz)	Modulation	RB Allocation	RB Offset	Conducted Average (dBm)												
				ANT 2			ANT 0			ANT 1			ANT 5			
				26047	26365	26683	26047	26365	26683	26047	26365	26683	26047	26365	26683	
1.4	QPSK	1	0	24.2	24.2	24.0	23.9	<b>24.0</b>	23.7	<b>23.3</b>	23.2	23.1	23.5	<b>23.5</b>	23.4	
		1	2	24.1	<b>24.2</b>	23.8	23.8	<b>24.0</b>	23.6	23.1	23.3	23.0	23.3	23.3	23.3	
		1	5	24.2	24.2	24.0	23.9	23.9	23.7	23.2	23.2	23.0	23.4	23.4	23.3	
		3	0	24.0	24.1	23.9	23.8	23.8	23.7	23.1	23.2	23.0	23.3	23.4	23.2	
		3	1	24.0	24.1	23.9	23.7	23.8	23.7	23.1	23.1	23.0	23.3	23.3	23.2	
		3	2	23.9	24.0	23.8	23.7	23.8	23.6	23.1	23.0	23.0	23.3	23.3	23.1	
	16QAM	6	0	23.1	23.1	23.0	22.9	23.0	22.7	22.1	22.2	22.0	22.9	22.7	22.9	
		1	0	23.2	23.2	23.3	23.0	22.9	22.9	22.4	22.4	22.4	22.5	22.5	22.4	
		1	2	23.3	23.2	<b>23.4</b>	<b>23.0</b>	23.0	<b>23.0</b>	<b>22.5</b>	22.3	22.3	<b>22.6</b>	22.6	22.2	
		1	5	23.2	23.3	23.4	<b>23.0</b>	23.0	23.0	22.4	22.4	22.4	22.6	22.5	22.4	
		3	0	23.2	23.1	22.9	22.9	22.8	22.7	22.3	22.3	22.1	22.4	22.4	22.2	
		3	1	23.1	22.9	23.0	22.8	22.8	22.7	22.2	22.3	22.1	22.3	22.3	22.1	
	64QAM	3	2	23.1	23.0	22.9	22.8	22.8	22.7	22.2	22.3	22.0	22.3	22.3	22.2	
		6	0	22.2	22.2	21.9	22.0	21.9	21.8	21.2	21.2	21.1	22.0	21.7	21.9	
		1	0	22.3	<b>22.6</b>	22.0	22.0	<b>22.0</b>	21.8	21.7	21.3	21.2	21.8	22.0	<b>22.1</b>	
		1	2	22.5	<b>22.6</b>	22.0	22.0	22.0	21.8	<b>21.7</b>	21.3	21.3	22.0	22.0	22.1	
		1	5	22.3	22.5	22.0	22.0	22.0	21.9	21.6	21.2	21.2	22.0	21.9	22.0	
		3	0	22.2	22.4	22.0	<b>22.0</b>	21.9	21.7	21.3	21.2	21.0	21.7	21.8	22.1	
	256QAM	3	1	22.3	22.3	22.0	22.0	21.9	21.7	21.2	21.3	21.0	21.7	21.9	22.1	
		3	2	22.2	22.3	22.0	22.0	21.8	21.7	21.2	21.2	20.9	21.8	21.9	22.0	
		6	0	21.2	21.2	21.1	20.9	20.9	20.7	20.1	20.3	20.0	20.5	20.5	20.4	
		1	0	19.2	19.1	19.1	18.9	<b>19.0</b>	18.8	18.3	18.5	18.3	18.6	18.5	18.5	
		1	2	19.3	19.2	19.1	18.9	<b>19.0</b>	18.9	18.6	<b>18.6</b>	18.2	18.6	18.5	18.4	
		1	5	19.2	19.1	19.1	18.9	<b>19.0</b>	18.8	18.4	18.5	18.3	<b>18.7</b>	18.4	18.5	
	3.0	QPSK	3	0	<b>19.3</b>	19.2	19.0	18.9	18.8	18.8	18.3	18.2	18.3	18.4	18.5	18.3
			3	1	19.2	19.2	19.0	18.8	18.8	18.7	18.2	18.1	18.3	18.4	18.5	18.3
			3	2	19.2	19.1	19.0	18.8	18.8	18.7	18.1	18.1	18.3	18.4	18.5	18.3
			6	0	19.1	19.2	18.9	19.0	18.9	18.6	18.2	18.2	18.1	18.4	18.6	18.4
			1	0	24.2	24.2	24.0	<b>24.0</b>	24.0	23.8	23.0	<b>23.2</b>	23.1	23.1	<b>23.4</b>	23.3
			1	7	24.2	24.3	24.0	23.8	23.8	23.7	23.0	23.1	23.0	23.0	23.3	23.0
16QAM		1	14	24.2	<b>24.3</b>	23.9	23.9	<b>24.0</b>	23.9	23.8	22.9	23.2	23.0	23.2	23.3	23.2
		8	0	23.2	23.2	23.0	23.0	22.9	22.7	22.0	22.1	22.0	22.9	22.7	22.9	
		8	4	23.1	23.2	23.0	22.9	22.9	22.7	22.0	22.1	22.0	23.0	22.7	22.9	
		8	7	23.2	23.2	23.0	22.9	22.9	22.7	22.0	22.1	22.0	23.0	22.7	22.8	
		15	0	23.1	23.2	23.0	22.9	22.9	22.7	22.0	22.1	22.0	23.0	22.7	22.9	
		1	0	23.5	23.3	23.4	<b>23.0</b>	<b>23.0</b>	<b>23.0</b>	22.5	22.5	22.3	22.3	<b>22.4</b>	22.4	
64QAM	1	7	<b>23.5</b>	23.3	23.4	23.0	<b>23.0</b>	23.0	22.5	22.5	22.3	22.3	22.4	<b>22.4</b>		
	1	14	23.5	23.2	23.4	23.0	<b>23.0</b>	22.9	<b>22.5</b>	22.4	22.1	22.2	22.4	22.3		
	8	0	22.2	22.2	22.1	22.0	22.0	21.8	21.1	21.3	21.1	21.8	21.7	21.9		
	8	4	22.2	22.2	22.1	22.0	22.0	21.8	21.2	21.3	21.1	21.9	21.7	21.8		
	8	7	22.2	22.2	22.1	22.0	22.0	21.8	21.2	21.3	21.1	21.9	21.7	21.8		
	15	0	22.2	22.1	22.1	21.9	22.0	21.8	21.1	21.2	21.1	21.9	21.7	21.8		
256QAM	1	0	22.2	22.4	22.2	22.0	<b>22.0</b>	22.0	21.4	21.4	<b>21.6</b>	21.8	21.9	<b>22.2</b>		
	1	7	22.2	22.4	22.2	21.9	22.0	21.9	21.4	21.4	21.5	22.0	22.0	22.1		
	1	14	22.1	<b>22.4</b>	22.2	21.9	<b>22.0</b>	<b>22.0</b>	21.4	21.3	21.5	22.1	22.0	22.0		
	8	0	21.2	21.2	21.0	21.0	20.9	20.7	20.2	20.2	20.2	20.4	20.5	20.4		
	8	4	21.2	21.2	21.1	21.0	20.9	20.6	20.2	20.2	20.1	20.4	20.6	20.4		
	8	7	21.2	21.2	21.1	21.0	20.9	20.7	20.2	20.2	20.1	20.4	20.5	20.4		
3.0	256QAM	15	0	21.2	21.2	21.1	20.9	20.8	20.8	20.2	20.2	20.1	20.4	20.4	20.3	
		1	0	19.3	<b>19.5</b>	19.1	18.9	19.0	18.9	18.3	<b>18.4</b>	18.3	18.5	18.8	18.5	
		1	7	19.2	19.4	19.1	18.8	18.9	18.8	18.3	18.3	18.1	18.5	18.6	18.4	
		1	14	19.2	<b>19.5</b>	19.1	18.9	19.0	18.8	18.3	18.3	18.2	18.6	<b>18.8</b>	18.5	
		8	0	19.2	19.3	19.0	<b>19.0</b>	19.0	18.7	18.3	18.3	18.3	18.5	18.6	18.5	
		8	4	19.2	19.3	19.0	19.0	18.9	18.7	18.2	18.2	18.2	18.5	18.6	18.4	
8	7	19.2	19.3	19.0	19.0	19.0	18.7	18.3	18.2	18.3	18.5	18.6	18.4			
15	0	19.2	19.3	19.1	19.0	18.9	18.8	18.3	18.3	18.2	18.4	18.5	18.4			

### OUTPUT POWER FOR LTE BAND 25 (3.0 MHz)

**OUTPUT POWER FOR LTE BAND 25 (5.0 MHz)**

Bandwidth (MHz)	Modulation	RB Allocation	RB Offset	Conducted Average (dBm)											
				ANT 2			ANT 0			ANT 1			ANT 5		
				26065	26365	26665	26065	26365	26665	26065	26365	26665	26065	26365	26665
5.0	QPSK	1	0	24.1	24.2	24.0	23.9	24.0	23.7	23.0	23.1	22.9	23.1	23.2	23.2
		1	12	24.1	24.1	24.0	23.9	23.9	23.5	23.0	22.9	22.9	23.1	23.3	23.2
		1	24	24.1	24.2	24.0	23.9	24.0	23.7	23.0	23.0	23.0	23.0	23.2	23.1
		12	0	23.1	23.2	23.0	22.9	22.9	22.7	22.0	22.0	22.0	22.7	22.7	23.0
		12	6	23.1	23.2	23.0	22.9	22.9	22.7	22.0	22.1	22.0	22.8	22.8	22.9
		12	11	23.1	23.2	23.0	22.9	22.9	22.7	22.0	22.1	22.0	22.9	22.8	22.9
		25	0	23.1	23.2	23.0	22.9	22.9	22.7	22.1	22.1	22.0	22.8	22.8	22.9
	16QAM	1	0	23.5	23.7	23.3	23.0	23.0	23.0	22.5	22.7	22.4	22.5	22.5	22.3
		1	12	23.4	23.5	23.3	23.0	23.0	22.8	22.5	22.7	22.4	22.6	22.7	22.4
		1	24	23.4	23.6	23.3	23.0	23.0	23.0	22.5	22.7	22.3	22.5	22.6	22.3
		12	0	22.2	22.2	22.0	21.9	21.9	21.8	21.2	21.3	21.0	21.7	21.7	22.0
		12	6	22.2	22.2	22.0	21.9	21.9	21.8	21.2	21.3	21.0	21.8	21.7	21.9
		12	11	22.2	22.2	22.0	21.9	21.9	21.7	21.2	21.2	21.0	21.9	21.7	21.8
		25	0	22.2	22.2	22.0	21.9	21.9	21.7	21.1	21.2	21.0	21.8	21.8	21.9
	64QAM	1	0	22.3	22.5	22.2	22.0	22.0	21.9	21.3	21.6	21.4	21.7	21.9	22.5
		1	12	22.2	22.4	22.2	21.9	22.0	21.9	21.2	21.5	21.3	22.0	22.0	22.4
		1	24	22.3	22.4	22.2	22.0	22.0	22.0	21.3	21.5	21.3	22.0	22.1	22.3
		12	0	21.1	21.2	20.9	20.9	20.9	20.7	20.2	20.2	20.2	20.3	20.4	20.4
		12	6	21.1	21.2	20.9	20.9	20.9	20.7	20.2	20.2	20.1	20.3	20.4	20.4
		12	11	21.1	21.2	20.9	20.9	20.9	20.7	20.2	20.2	20.1	20.3	20.4	20.4
		25	0	21.2	21.2	21.0	20.9	20.9	20.7	20.2	20.2	20.1	20.3	20.5	20.4
	256QAM	1	0	19.2	19.5	19.1	19.0	19.0	18.7	18.4	18.6	18.3	18.5	18.4	18.6
		1	12	19.0	19.5	19.1	18.9	19.0	18.6	18.3	18.5	18.2	18.3	18.4	18.6
		1	24	19.2	19.5	19.1	19.0	19.0	18.8	18.4	18.5	18.3	18.5	18.4	18.6
		12	0	19.2	19.3	18.9	18.9	19.0	18.7	18.2	18.3	18.2	18.3	18.5	18.4
		12	6	19.2	19.3	19.0	18.9	19.0	18.7	18.2	18.3	18.2	18.3	18.5	18.4
		12	11	19.1	19.2	19.0	18.9	18.9	18.7	18.2	18.3	18.2	18.3	18.5	18.4
		25	0	19.2	19.2	19.1	18.9	18.9	18.7	18.3	18.2	18.2	18.4	18.5	18.3

**OUTPUT POWER FOR LTE BAND 25 (10.0 MHz)**

Bandwidth (MHz)	Modulation	RB Allocation	RB Offset	Conducted Average (dBm)											
				ANT 2			ANT 0			ANT 1			ANT 5		
				26090	26365	26640	26090	26365	26640	26090	26365	26640	26090	26365	26640
10.0	QPSK	1	0	24.2	24.3	24.1	24.0	24.0	23.8	23.0	23.1	23.1	23.2	23.3	23.1
		1	24	24.1	24.4	24.0	24.0	23.8	23.7	22.9	23.1	22.9	23.1	23.2	23.1
		1	49	24.2	24.2	24.0	24.0	24.0	23.7	23.0	23.0	23.0	23.1	23.2	23.1
		25	0	23.2	23.2	23.1	22.9	22.9	22.8	22.0	22.1	22.0	22.7	22.7	23.2
		25	12	23.2	23.2	23.1	22.9	22.9	22.8	22.0	22.1	22.0	22.8	22.8	23.0
		25	24	23.2	23.2	23.1	22.9	22.9	22.7	22.0	22.1	22.0	22.8	22.9	22.9
		50	0	23.2	23.2	23.1	22.9	22.9	22.7	22.1	22.1	22.1	22.8	22.8	23.1
	16QAM	1	0	23.4	23.5	23.5	23.0	23.0	22.9	22.3	22.3	22.6	22.5	22.4	22.3
		1	24	23.5	23.6	23.4	23.0	23.0	23.0	22.4	22.4	22.5	22.6	22.4	22.4
		1	49	23.3	23.5	23.4	23.0	23.0	22.8	22.3	22.3	22.4	22.4	22.3	22.2
		25	0	22.1	22.2	22.1	21.9	21.9	21.7	21.1	21.2	21.1	21.7	21.7	22.3
		25	12	22.1	22.2	22.0	21.9	21.9	21.7	21.1	21.2	21.1	21.7	21.7	22.1
		25	24	22.1	22.2	22.0	21.9	21.9	21.7	21.1	21.2	21.1	21.8	21.8	21.9
		50	0	22.2	22.2	22.0	21.9	21.9	21.7	21.1	21.2	21.1	21.8	21.7	22.1
	64QAM	1	0	22.2	22.4	22.2	21.9	21.9	21.8	21.4	21.4	21.3	21.7	21.8	22.5
		1	24	22.2	22.4	22.2	21.9	21.9	21.9	21.5	21.4	21.2	21.9	21.9	22.3
		1	49	22.2	22.3	22.1	21.9	21.9	21.9	21.4	21.4	21.1	22.0	22.1	22.0
		25	0	21.2	21.2	21.0	20.9	20.9	20.7	20.3	20.3	20.2	20.4	20.5	20.4
		25	12	21.2	21.2	21.0	20.9	20.9	20.7	20.2	20.3	20.1	20.4	20.5	20.4
		25	24	21.2	21.2	21.0	20.9	20.9	20.7	20.3	20.2	20.1	20.4	20.5	20.4
		50	0	21.2	21.2	21.0	20.9	20.9	20.8	20.2	20.3	20.1	20.4	20.5	20.4
	256QAM	1	0	19.1	19.4	19.2	19.0	19.0	18.8	18.5	18.4	18.3	18.7	18.7	18.4
		1	24	19.1	19.4	19.2	19.0	19.0	18.7	18.5	18.5	18.2	18.7	18.8	18.5
		1	49	19.1	19.3	19.1	19.0	19.0	18.8	18.4	18.4	18.2	18.7	18.8	18.4
		25	0	19.2	19.4	19.1	19.0	19.0	18.7	18.3	18.3	18.2	18.4	18.5	18.4
		25	12	19.2	19.3	19.1	19.0	19.0	18.8	18.3	18.3	18.2	18.4	18.5	18.4
		25	24	19.2	19.3	19.1	19.0	19.0	18.8	18.3	18.3	18.1	18.4	18.5	18.4
		50	0	19.2	19.3	19.0	19.0	18.9	18.7	18.3	18.3	18.1	18.4	18.5	18.4

**OUTPUT POWER FOR LTE BAND 25 (15.0 MHz)**

Bandwidth (MHz)	Modulation	RB Allocation	RB Offset	Conducted Average (dBm)											
				ANT 2			ANT 0			ANT 1			ANT 5		
				26115	26365	26615	26115	26365	26615	26115	26365	26615	26115	26365	26615
15.0	QPSK	1	0	24.3	24.3	24.2	24.0	24.0	23.8	23.1	23.2	23.2	23.2	23.3	23.2
		1	37	24.2	24.3	24.2	23.9	23.9	23.6	23.0	23.1	23.1	23.0	23.2	23.0
		1	74	24.2	24.2	24.1	23.9	24.0	23.7	23.0	23.1	22.9	23.1	23.2	23.0
		36	0	23.3	23.3	23.1	23.0	23.0	22.8	22.1	22.1	22.0	22.9	22.9	22.7
		36	16	23.2	23.2	23.1	22.9	22.9	22.7	22.1	22.1	22.0	22.9	23.0	22.6
		36	35	23.2	23.2	23.1	22.9	22.9	22.7	22.1	22.1	22.0	22.8	23.1	22.4
		75	0	23.2	23.2	23.1	22.9	22.9	22.7	22.1	22.1	22.1	22.8	23.0	22.5
		1	0	23.6	23.5	23.4	23.0	23.0	23.0	22.4	22.5	22.5	22.3	22.7	22.5
		1	37	23.6	23.5	23.4	23.0	23.0	22.8	22.4	22.5	22.4	22.3	22.7	22.5
	1	74	23.5	23.4	23.3	23.0	23.0	22.9	22.4	22.4	22.3	22.2	22.7	22.4	
	36	0	22.3	22.3	22.1	22.0	21.9	21.7	21.1	21.2	21.1	21.9	21.9	21.6	
	36	16	22.2	22.2	22.0	21.9	21.9	21.7	21.1	21.2	21.1	21.8	22.0	21.6	
	36	35	22.2	22.2	22.0	21.9	21.9	21.7	21.1	21.2	21.1	21.8	22.0	21.4	
	75	0	22.2	22.2	22.1	21.9	21.9	21.7	21.1	21.1	21.1	21.8	22.0	21.5	
	1	0	22.4	22.4	22.2	22.0	22.0	21.9	21.5	21.6	21.4	21.8	22.0	21.9	
	1	37	22.3	22.1	22.2	22.0	21.8	21.7	21.3	21.5	21.2	21.9	22.3	22.0	
	1	74	22.3	22.4	22.2	22.0	21.9	21.8	21.4	21.4	21.1	21.8	22.3	21.6	
	36	0	21.3	21.2	21.1	21.0	21.0	20.8	20.2	20.2	20.2	20.4	20.5	20.3	
	36	16	21.3	21.2	21.0	21.0	20.9	20.8	20.2	20.2	20.2	20.4	20.5	20.2	
	36	35	21.3	21.2	21.0	20.9	20.9	20.8	20.1	20.2	20.1	20.4	20.5	20.2	
	75	0	21.2	21.2	21.0	21.0	20.9	20.7	20.2	20.2	20.1	20.3	20.4	20.3	
	1	0	19.3	19.3	19.3	19.0	19.0	18.8	18.4	18.5	18.3	18.5	18.6	18.5	
	1	37	19.1	19.3	19.1	19.0	19.0	18.7	18.4	18.4	18.2	18.5	18.5	18.5	
	1	74	19.2	19.2	19.3	19.0	19.0	18.7	18.3	18.5	18.1	18.5	18.6	18.4	
	36	0	19.2	19.2	19.0	19.0	18.9	18.7	18.2	18.3	18.2	18.4	18.5	18.3	
	36	16	19.2	19.2	19.0	18.9	18.9	18.7	18.3	18.2	18.1	18.3	18.5	18.3	
	36	35	19.2	19.2	19.0	18.9	18.9	18.7	18.2	18.2	18.1	18.3	18.5	18.3	
	75	0	19.2	19.2	19.0	19.0	18.9	18.7	18.3	18.2	18.1	18.3	18.5	18.3	

**OUTPUT POWER FOR LTE BAND 25 (20.0 MHz)**

Bandwidth (MHz)	Modulation	RB Allocation	RB Offset	Conducted Average (dBm)											
				ANT 2			ANT 0			ANT 1			ANT 5		
				26140	26365	26590	26140	26365	26590	26140	26365	26590	26140	26365	26590
20.0	QPSK	1	0	24.3	24.3	24.2	24.0	24.0	23.9	23.1	23.2	23.2	23.2	23.3	23.3
		1	49	24.1	24.5	23.7	24.0	23.6	23.7	23.1	23.3	23.0	22.9	23.4	23.4
		1	99	24.2	24.2	24.1	23.9	23.9	23.7	23.0	23.1	23.0	23.1	23.2	23.1
		50	0	23.2	23.3	23.1	23.0	22.9	22.8	22.1	22.1	22.1	22.9	22.9	22.7
		50	24	23.2	23.2	23.1	23.0	22.9	22.7	22.1	22.1	22.1	22.8	23.0	22.7
		50	49	23.2	23.2	23.1	22.9	22.9	22.7	22.1	22.1	22.1	22.7	23.1	22.5
		100	0	23.2	23.2	23.1	23.0	22.9	22.8	22.1	22.2	22.1	22.8	23.0	22.6
		1	0	23.6	23.8	23.6	23.0	23.0	23.0	22.2	22.5	22.6	22.5	22.6	22.6
		1	49	23.7	23.6	23.6	23.0	23.0	23.0	22.4	22.4	22.5	22.3	22.5	22.4
	1	99	23.5	23.7	23.5	23.0	23.0	22.9	22.1	22.4	22.3	22.4	22.6	22.4	
	50	0	22.2	22.2	22.1	21.9	22.0	21.8	21.2	21.2	21.2	21.9	21.9	21.7	
	50	24	22.2	22.2	22.1	21.9	21.9	21.7	21.1	21.1	21.1	21.8	22.0	21.6	
	50	49	22.2	22.2	22.1	21.9	21.9	21.7	21.1	21.1	21.1	21.7	22.0	21.5	
	100	0	22.2	22.2	22.1	21.9	21.9	21.7	21.1	21.2	21.1	21.8	22.0	21.6	
	1	0	22.5	22.5	22.4	22.0	22.0	22.0	21.6	21.4	21.5	22.2	22.0	21.8	
	1	49	22.6	22.6	22.4	22.0	22.0	21.8	21.6	21.3	21.4	22.0	22.3	22.0	
	1	99	22.4	22.5	22.3	22.0	22.0	21.9	21.5	21.2	21.2	22.1	22.4	21.8	
	50	0	21.2	21.3	21.1	20.9	20.9	20.8	20.3	20.3	20.3	20.4	20.4	20.4	
	50	24	21.2	21.2	21.0	20.9	20.9	20.7	20.3	20.3	20.2	20.4	20.4	20.3	
	50	49	21.2	21.2	21.0	21.0	20.9	20.7	20.3	20.3	20.1	20.4	20.4	20.3	
	100	0	21.2	21.3	21.0	20.9	20.9	20.7	20.3	20.2	20.2	20.4	20.4	20.3	
	1	0	19.5	19.6	19.4	19.0	19.0	19.0	18.5	18.5	18.5	18.6	18.7	18.6	
	1	49	19.5	19.4	19.5	19.0	19.0	18.9	18.3	18.6	18.5	18.6	18.7	18.6	
	1	99	19.4	19.5	19.3	19.0	19.0	19.0	18.5	18.5	18.3	18.5	18.6	18.5	
	50	0	19.3	19.3	19.1	19.0	19.0	18.8	18.3	18.3	18.2	18.4	18.5	18.4	
	50	24	19.3	19.3	19.1	19.0	18.9	18.8	18.3	18.3	18.2	18.4	18.5	18.3	
	50	49	19.3	19.2	19.1	19.0	18.9	18.7	18.3	18.2	18.2	18.4	18.5	18.3	
	100	0	19.3	19.3	19.1	19.0	18.9	18.8	18.3	18.3	18.3	18.4	18.5	18.3	



**5G NR n25**

<b>Test Engineer ID:</b>	19210AL and 28498AC	<b>Test Date:</b>	2024-02-14 to 2024-04-19
--------------------------	---------------------	-------------------	--------------------------

**OUTPUT POWER FOR 5G NR n25 (5.0 MHz)**

Bandwidth (MHz)	Modulation	RB Allocation	RB Offset	Conducted Average (dBm)											
				ANT 2			ANT 0			ANT 1			ANT 5		
				370500	376500	382500	370500	376500	382500	370500	376500	382500	370500	376500	382500
5.0	BPSK	1	0	23.9	23.8	23.5	23.4	23.4	23.2	23.6	23.5	23.5	22.6	22.8	23.0
		1	1	24.2	<b>24.3</b>	24.1	23.9	23.9	23.7	24.1	23.9	24.0	23.0	23.3	23.5
		1	23	24.2	24.2	24.1	<b>23.9</b>	23.9	23.7	23.9	24.0	<b>24.2</b>	23.5	23.4	23.6
		1	24	23.8	23.8	23.5	23.3	23.4	23.2	23.3	23.5	23.8	22.7	22.9	22.9
		12	6	24.2	24.2	24.0	23.9	23.8	23.7	24.0	23.9	24.1	23.0	23.3	<b>23.6</b>
		25	0	23.7	23.7	23.6	23.5	23.3	23.2	23.4	23.4	23.6	22.5	22.8	23.1
	QPSK	1	0	23.2	23.3	23.1	22.9	22.9	22.8	23.2	23.1	23.1	22.4	22.2	22.5
		1	1	<b>24.3</b>	24.2	24.1	23.9	23.9	23.7	24.1	23.9	24.0	23.1	23.4	23.5
		1	23	24.3	24.2	24.1	<b>24.0</b>	24.0	23.7	23.9	23.9	<b>24.2</b>	23.1	23.4	23.5
		1	24	23.3	23.2	23.0	22.9	22.8	22.7	23.0	23.0	23.3	22.1	22.5	22.5
		12	6	24.2	24.1	24.1	23.9	23.8	23.7	23.9	23.9	24.2	23.0	23.3	<b>23.6</b>
		25	0	23.2	23.1	23.0	22.9	22.8	22.7	22.9	23.0	23.2	22.0	22.3	22.6
	16QAM	1	0	22.1	22.2	22.2	22.0	21.8	22.1	22.4	22.2	22.1	21.0	21.2	21.6
		1	1	23.2	23.1	23.0	<b>23.0</b>	22.9	22.6	23.2	23.1	23.0	22.0	22.2	22.6
		1	23	<b>23.3</b>	23.1	23.1	<b>23.0</b>	22.6	22.7	23.1	23.1	23.2	22.0	22.3	22.6
		1	24	22.1	22.4	22.2	22.2	21.8	21.8	22.1	22.2	22.4	21.0	21.3	21.6
		12	6	23.2	23.2	23.0	22.9	22.8	22.7	23.1	23.0	<b>23.3</b>	22.0	22.2	<b>22.6</b>
		25	0	22.1	22.1	22.0	21.9	21.8	21.6	22.0	22.0	22.1	21.0	21.3	21.6
	64QAM	1	0	21.4	21.8	21.7	21.4	21.4	21.5	21.7	21.6	21.5	20.7	20.8	21.1
		1	1	21.7	<b>22.0</b>	21.4	21.3	<b>21.7</b>	21.1	21.7	21.6	21.6	20.6	20.8	21.1
		1	23	<b>22.0</b>	21.5	21.2	21.4	21.6	21.4	21.5	21.6	21.8	20.6	20.9	21.1
		1	24	21.5	21.8	21.2	21.5	21.7	21.4	21.5	21.5	<b>21.8</b>	20.6	20.9	<b>21.2</b>
		12	6	21.6	21.6	21.5	21.5	21.3	21.2	21.6	21.5	21.8	20.5	20.7	21.1
		25	0	21.7	21.7	21.4	21.4	21.2	21.2	21.6	21.5	21.7	20.5	20.8	21.1
	256QAM	1	0	19.8	19.1	19.5	19.4	19.2	19.0	19.5	19.4	19.3	18.5	18.8	19.0
		1	1	19.7	19.9	19.7	19.3	19.3	19.4	19.6	19.5	19.4	18.5	18.8	18.9
		1	23	19.7	<b>20.0</b>	19.5	19.6	19.6	19.3	19.5	19.5	19.5	18.4	18.8	19.0
		1	24	19.9	19.4	19.7	<b>19.7</b>	19.2	19.2	19.4	19.4	19.5	18.5	18.8	19.0
		12	6	19.7	19.6	19.5	19.4	19.3	19.2	19.6	19.6	<b>19.8</b>	18.4	18.8	<b>19.2</b>
		25	0	19.6	19.6	19.5	19.4	19.2	19.1	19.6	19.6	19.8	18.4	18.8	19.1

**OUTPUT POWER FOR 5G NR n25 (10.0 MHz)**

Bandwidth (MHz)	Modulation	RB Allocation	RB Offset	Conducted Average (dBm)											
				ANT 2			ANT 0			ANT 1			ANT 5		
				371000	376500	382000	371000	376500	382000	371000	376500	382000	371000	376500	382000
10.0	BPSK	1	0	23.6	23.7	23.6	23.2	23.3	23.2	23.7	23.6	23.5	22.6	22.8	23.0
		1	1	24.1	24.2	24.2	23.7	23.8	23.7	24.2	24.1	24.0	23.0	23.2	23.5
		1	50	<b>24.3</b>	24.2	24.1	<b>23.8</b>	23.8	23.7	23.9	24.1	<b>24.3</b>	23.2	23.3	<b>23.6</b>
		1	51	23.7	23.7	23.6	23.4	23.2	23.1	23.4	23.6	23.8	22.7	23.0	23.0
		25	12	24.1	24.1	24.2	23.8	23.7	23.5	24.0	24.0	24.1	23.0	23.3	23.5
		50	0	23.6	23.6	23.6	23.3	23.2	23.0	23.4	23.5	23.6	22.5	22.8	23.0
	QPSK	1	0	23.1	23.3	23.1	22.7	22.8	22.7	23.3	23.1	23.2	22.1	22.3	22.6
		1	1	24.0	24.2	<b>24.3</b>	23.8	23.8	23.6	24.2	24.1	24.1	23.2	23.2	<b>23.6</b>
		1	50	24.2	24.2	24.1	23.8	<b>23.8</b>	23.6	23.9	24.0	<b>24.3</b>	23.1	23.6	<b>23.7</b>
		1	51	23.1	23.2	23.1	22.8	22.8	22.5	23.0	23.1	23.4	22.1	22.6	22.8
		25	12	24.1	24.1	24.2	23.7	23.6	23.5	24.0	24.0	24.1	23.1	23.3	23.5
		50	0	23.1	23.1	23.1	22.7	22.7	22.5	23.0	23.0	23.1	22.0	22.3	22.5
	16QAM	1	0	22.0	22.2	22.0	21.6	22.1	21.3	22.3	22.1	22.3	21.1	21.2	21.1
		1	1	23.2	23.3	<b>23.4</b>	22.5	22.5	<b>22.8</b>	<b>23.4</b>	23.1	23.4	21.9	22.4	22.5
		1	50	23.0	23.4	22.9	22.6	22.7	22.5	23.0	23.0	23.4	22.3	22.2	<b>22.5</b>
		1	51	22.4	22.3	22.2	21.8	21.9	21.2	22.0	22.1	22.5	20.8	21.0	21.2
		25	12	23.2	23.0	23.1	22.7	22.6	22.5	23.0	23.0	23.0	22.0	22.3	22.5
		50	0	22.1	22.1	22.1	21.8	21.6	21.5	22.0	22.0	22.1	21.0	21.3	21.4
	64QAM	1	0	21.6	<b>22.2</b>	21.9	21.2	21.0	21.1	<b>22.0</b>	21.6	21.7	20.8	20.9	20.8
		1	1	21.3	21.5	21.3	21.0	<b>21.7</b>	21.0	21.9	21.6	21.7	20.8	20.6	20.8
		1	50	21.8	21.6	21.9	21.3	21.4	21.2	21.6	21.5	21.8	20.7	20.8	20.9
		1	51	21.4	21.8	21.6	21.3	20.8	21.3	21.7	21.5	21.9	20.7	20.6	20.9
		25	12	21.6	21.5	21.6	21.2	21.2	21.0	21.6	21.5	21.7	20.5	20.8	<b>20.9</b>
		50	0	21.6	21.6	21.6	21.2	21.1	21.1	21.5	21.5	21.6	20.5	20.8	<b>20.9</b>
	256QAM	1	0	19.4	19.5	19.5	19.0	18.8	19.3	19.6	19.4	19.3	18.6	18.8	<b>19.1</b>
		1	1	19.6	19.4	19.6	19.4	19.4	18.6	19.8	19.6	19.6	18.8	18.8	18.9
		1	50	19.3	19.5	19.3	19.2	19.0	18.8	19.6	19.5	<b>19.9</b>	18.7	18.9	18.9
		1	51	19.6	19.4	19.3	18.9	<b>19.4</b>	18.8	19.3	19.4	19.7	18.7	18.9	19.0
		25	12	<b>19.7</b>	19.5	19.5	19.2	19.1	19.1	19.6	19.6	19.6	18.4	18.7	19.0
		50	0	19.6	19.5	19.7	19.1	19.1	18.9	19.6	19.6	19.7	18.5	18.7	19.0



**OUTPUT POWER FOR 5G NR n25 (15.0 MHz)**

Bandwidth (MHz)	Modulation	RB Allocation	RB Offset	Conducted Average (dBm)											
				ANT 2			ANT 0			ANT 1			ANT 5		
				371500	376500	381500	371500	376500	381500	371500	376500	381500	371500	376500	381500
15.0	BPSK	1	0	23.6	23.7	23.7	23.3	23.3	23.2	23.7	23.5	23.5	22.2	22.5	22.9
		1	1	24.1	24.3	24.2	23.7	23.8	23.7	24.2	24.0	24.0	22.8	23.2	23.4
		1	77	24.2	24.3	24.1	23.7	23.8	23.7	23.9	24.0	24.2	23.4	23.3	23.5
		1	78	23.7	23.8	23.6	23.2	23.4	23.2	23.4	23.5	23.6	22.5	22.8	23.0
		36	18	24.2	24.2	24.3	23.8	23.7	23.8	24.0	23.9	24.0	23.0	23.3	23.6
		75	0	23.7	23.7	23.8	23.3	23.3	23.3	23.5	23.5	23.5	22.5	22.8	23.1
	QPSK	1	0	23.1	23.2	23.2	22.7	22.8	22.8	23.1	22.9	22.8	22.0	22.1	22.6
		1	1	24.2	24.1	24.2	23.7	23.9	23.7	24.1	24.0	23.9	23.0	23.4	23.6
		1	77	24.2	24.2	24.1	23.7	23.8	23.7	23.9	24.0	24.1	23.2	23.4	23.6
		1	78	23.3	23.2	23.2	22.8	22.8	22.7	22.9	23.0	23.1	22.1	22.3	22.5
		36	18	24.2	24.2	24.2	23.7	23.8	23.8	24.0	24.0	24.0	23.0	23.3	23.6
		75	0	23.2	23.2	23.3	22.8	22.8	22.8	23.0	23.0	23.0	22.0	22.3	22.6
	16QAM	1	0	22.0	22.4	22.0	21.7	21.6	21.7	22.1	22.0	21.9	21.2	21.2	21.3
		1	1	23.0	23.3	23.2	22.9	22.9	22.7	23.1	23.0	22.8	22.2	22.4	22.3
		1	77	23.4	23.1	22.7	22.6	22.5	22.9	22.9	23.0	23.0	22.4	22.6	22.4
		1	78	22.5	22.2	22.2	21.6	21.5	21.9	21.8	22.0	22.2	21.1	21.5	21.4
		36	18	23.2	23.1	23.2	22.8	22.8	22.8	23.1	23.0	23.2	21.9	22.3	22.5
		75	0	22.2	22.1	22.2	21.8	21.8	21.8	22.2	22.1	22.2	21.0	21.3	21.6
	64QAM	1	0	21.6	21.6	21.8	21.0	21.9	21.1	21.4	21.4	21.6	20.2	20.7	21.1
		1	1	21.8	21.7	21.9	21.5	21.4	21.2	21.6	21.6	21.6	20.2	20.7	21.1
		1	77	21.8	21.6	21.5	21.2	21.3	21.2	21.3	21.6	21.9	20.4	20.8	21.2
		1	78	21.6	21.6	21.6	21.2	21.3	21.4	21.1	21.5	21.8	20.5	20.7	21.2
		36	18	21.7	21.8	21.7	21.3	21.3	21.3	21.6	21.6	21.8	20.5	20.8	21.1
		75	0	21.7	21.7	21.6	21.2	21.2	21.2	21.6	21.5	21.6	20.5	20.8	21.0
	256QAM	1	0	19.8	19.8	20.0	18.9	19.4	19.1	19.7	19.5	19.6	18.5	18.6	18.7
		1	1	19.6	19.5	19.6	19.1	19.0	19.2	19.8	19.6	19.6	18.5	18.6	18.6
		1	77	19.9	19.8	19.4	19.0	19.3	19.3	19.7	19.6	19.9	18.5	18.8	18.7
		1	78	19.6	19.8	19.6	19.2	18.9	19.3	19.6	19.6	20.0	18.4	18.7	18.8
		36	18	19.7	19.6	19.7	19.3	19.3	19.2	19.6	19.5	19.7	18.5	18.8	19.0
		75	0	19.7	19.7	19.6	19.4	19.3	19.3	19.6	19.6	19.7	18.4	18.8	19.0

**OUTPUT POWER FOR 5G NR n25 (20.0 MHz)**

Bandwidth (MHz)	Modulation	RB Allocation	RB Offset	Conducted Average (dBm)											
				ANT 2			ANT 0			ANT 1			ANT 5		
				372000	376500	381000	372000	376500	381000	372000	376500	381000	372000	376500	381000
20.0	BPSK	1	0	23.6	23.7	23.7	23.4	23.3	23.3	23.5	23.4	23.4	22.3	22.6	22.7
		1	1	24.2	24.2	24.2	23.9	23.8	23.8	24.1	24.0	24.1	22.8	23.2	23.2
		1	104	24.2	24.2	24.3	23.9	23.8	23.8	24.0	24.1	24.3	23.2	23.4	23.5
		1	105	23.6	23.7	23.7	23.3	23.2	23.3	23.4	23.5	23.7	22.5	22.8	23.0
		50	25	24.3	24.2	24.1	23.8	23.8	23.7	24.0	23.9	24.1	23.0	23.3	23.5
		100	0	23.7	23.7	23.7	23.4	23.3	23.3	23.5	23.6	23.5	22.5	22.8	23.0
	QPSK	1	0	23.1	23.1	23.3	22.7	22.8	22.8	23.0	23.0	23.0	22.0	22.1	22.5
		1	1	24.1	24.3	24.2	23.8	23.8	23.8	24.0	23.9	24.0	23.0	23.1	23.3
		1	104	24.2	24.2	24.2	23.8	23.8	23.7	23.9	24.0	24.0	23.2	23.4	23.4
		1	105	23.2	23.3	23.1	22.7	22.8	22.8	23.0	22.9	23.0	22.2	22.4	22.4
		50	25	24.2	24.1	24.1	23.8	23.8	23.8	24.0	23.8	24.1	23.0	23.3	23.5
		100	0	23.2	23.1	23.2	22.9	22.7	22.8	23.0	23.0	23.1	22.0	22.3	22.5
	16QAM	1	0	22.1	22.1	22.0	22.0	21.7	21.9	22.2	22.1	22.1	21.1	21.1	21.4
		1	1	23.0	23.3	23.3	22.7	22.7	22.8	23.1	23.0	23.1	22.1	22.0	22.4
		1	104	23.0	23.3	23.0	23.0	22.7	22.9	23.0	23.1	23.2	22.1	22.4	22.5
		1	105	22.1	22.5	22.0	21.8	21.8	22.0	22.1	22.2	22.1	21.1	21.4	21.6
		50	25	23.3	23.2	23.1	23.0	22.7	22.7	23.1	23.0	23.1	22.0	22.2	22.5
		100	0	22.2	22.2	22.2	21.9	21.8	21.8	22.0	22.0	22.1	21.0	21.3	21.5
	64QAM	1	0	21.7	21.7	21.7	21.7	21.3	21.3	21.7	21.8	21.5	20.3	20.7	20.8
		1	1	21.7	21.7	21.8	21.1	21.1	21.3	21.7	21.8	21.4	20.4	20.7	20.8
		1	104	21.8	21.7	21.7	21.4	21.3	21.0	21.6	21.4	21.9	20.6	20.9	20.9
		1	105	22.0	21.7	21.7	21.6	21.2	21.1	21.6	21.6	21.9	20.7	20.9	21.0
		50	25	21.7	21.6	21.7	21.4	21.3	21.2	21.6	21.5	21.6	20.4	20.7	20.9
		100	0	21.7	21.7	21.7	21.4	21.3	21.3	21.6	21.6	21.7	20.5	20.8	20.9
	256QAM	1	0	19.3	19.8	19.6	19.3	19.4	19.3	19.8	19.9	19.7	18.4	18.6	18.8
		1	1	19.1	19.7	19.6	18.9	19.3	18.9	19.7	19.7	19.7	18.3	18.6	18.8
		1	104	19.9	19.6	19.2	19.3	19.0	19.1	19.5	19.6	19.7	18.5	18.9	19.0
		1	105	19.4	19.9	19.5	19.2	19.2	18.9	19.5	19.5	19.7	18.5	18.9	19.0
		50	25	19.7	19.7	19.7	19.3	19.2	19.3	19.6	19.6	19.7	18.5	18.7	19.0
		100	0	19.8	19.6	19.7	19.4	19.2	19.2	19.6	19.6	19.6	18.4	18.7	19.0

**OUTPUT POWER FOR 5G NR n25 (25.0 MHz)**

Bandwidth (MHz)	Modulation	RB Allocation	RB Offset	Conducted Average (dBm)														
				ANT 2			ANT 0			ANT 1			ANT 5					
				372500 1862.5	376500 1882.5	380500 1902.5	372500 1862.5	376500 1882.5	380500 1902.5	372500 1862.5	376500 1882.5	380500 1902.5	372500 1862.5	376500 1882.5	380500 1902.5			
25.0	BPSK	1	0	23.8	23.9	24.0	23.3	23.3	23.4	23.6	23.4	23.5	22.4	22.6	22.8			
		1	1	24.4	24.4	24.4	23.9	23.9	23.8	24.1	24.0	24.0	22.9	23.1	23.4			
		1	131	24.4	24.5	24.4	23.8	23.9	23.8	24.0	24.0	24.0	24.3	23.1	23.4	23.6		
		1	132	23.9	24.0	23.9	23.4	23.3	23.4	23.4	23.5	23.8	22.6	22.9	23.1			
		64	32	24.3	24.4	24.3	23.8	23.9	23.8	24.0	23.9	24.1	23.0	23.3	23.5			
		128	0	23.9	23.9	23.9	23.3	23.3	23.4	23.4	23.4	23.6	22.6	22.8	23.0			
	QPSK	1	0	23.3	23.5	23.5	22.9	22.8	22.9	23.1	23.0	23.0	22.0	22.1	22.3			
		1	1	24.4	24.5	24.5	23.9	23.8	23.9	24.1	24.0	24.0	23.0	23.1	23.4			
		1	131	24.4	24.5	24.4	23.9	23.9	23.8	24.0	23.9	24.0	24.3	23.1	23.4	23.5		
		1	132	23.4	23.5	23.5	22.9	22.9	22.8	23.0	22.9	23.3	22.1	22.4	22.6			
		64	32	24.3	24.4	24.3	23.8	23.9	23.8	23.9	23.9	24.1	23.0	23.3	23.4			
		128	0	23.4	23.4	23.3	22.8	22.9	22.7	22.9	22.9	23.1	22.1	22.3	22.4			
	16QAM	1	0	22.4	22.4	22.4	22.0	22.1	21.9	22.3	22.1	22.0	20.9	20.9	21.3			
		1	1	23.6	23.6	23.7	22.9	23.1	23.1	23.2	23.0	23.0	22.1	21.7	22.5			
		1	131	23.6	23.5	23.4	22.8	22.7	23.2	23.1	23.1	23.0	22.1	22.2	22.7			
		1	132	22.4	22.5	22.4	21.8	21.7	21.4	22.1	22.1	22.3	21.1	21.2	21.5			
		64	32	23.3	23.4	23.4	22.8	22.8	22.7	23.0	22.9	23.1	22.0	22.3	22.5			
		128	0	22.4	22.4	22.4	21.9	21.8	21.8	21.9	21.9	22.1	21.0	21.2	21.4			
	64QAM	1	0	22.1	21.7	22.0	21.3	21.3	21.6	21.5	21.4	21.4	20.3	20.5	20.8			
		1	1	22.0	21.9	22.2	21.3	21.5	21.3	21.5	21.5	21.4	20.5	20.5	20.8			
		1	131	21.7	22.0	21.8	21.2	21.4	21.4	21.3	21.4	21.6	20.6	20.6	21.1			
		1	132	22.1	21.9	22.3	21.1	21.3	21.5	21.3	21.4	21.6	20.6	20.8	21.0			
		64	32	21.8	21.9	21.9	21.3	21.3	21.2	21.4	21.3	21.5	20.5	20.8	21.0			
		128	0	21.8	21.9	21.9	21.3	21.3	21.2	21.4	21.3	21.5	20.5	20.8	21.0			
	256QAM	1	0	19.9	19.7	20.0	19.6	19.6	19.6	19.6	19.5	19.4	18.5	18.7	18.8			
		1	1	19.9	19.9	20.1	19.2	19.2	19.3	19.7	19.6	19.5	18.6	18.7	18.8			
		1	131	20.1	19.7	19.9	19.6	19.5	19.4	19.7	19.6	19.6	18.6	19.1	18.9			
		1	132	19.9	19.8	19.8	19.3	19.1	19.4	19.5	19.5	19.6	18.6	18.8	19.0			
		64	32	19.9	19.9	19.8	19.3	19.3	19.2	19.3	19.3	19.5	18.5	18.7	19.0			
		128	0	19.9	19.8	19.8	19.3	19.3	19.2	19.3	19.3	19.5	18.5	18.8	19.0			

**OUTPUT POWER FOR 5G NR n25 (30.0 MHz)**

Bandwidth (MHz)	Modulation	RB Allocation	RB Offset	Conducted Average (dBm)														
				ANT 2			ANT 0			ANT 1			ANT 5					
				373000 1865.0	376500 1882.5	380000 1900.0	373000 1865.0	376500 1882.5	380000 1900.0	373000 1865.0	376500 1882.5	380000 1900.0	373000 1865.0	376500 1882.5	380000 1900.0			
30.0	BPSK	1	0	23.9	23.8	23.9	23.5	23.4	23.5	23.6	23.5	23.4	22.4	22.6	22.9			
		1	1	24.4	24.5	24.5	23.8	23.8	23.9	24.1	24.0	24.0	23.0	23.0	23.3			
		1	158	24.5	24.6	24.4	23.9	23.9	23.8	24.0	24.1	24.3	23.1	23.4	23.6			
		1	159	24.0	23.9	23.8	23.4	23.3	23.3	23.5	23.6	23.8	22.7	22.9	23.1			
		80	40	24.5	24.5	24.5	23.8	23.9	23.8	24.0	24.0	24.2	23.1	23.3	23.5			
		160	0	23.9	23.9	23.9	23.4	23.3	23.3	23.5	23.5	23.6	22.6	22.8	23.0			
	QPSK	1	0	23.4	23.5	23.4	22.8	22.9	22.9	23.1	22.9	23.0	21.9	22.0	22.4			
		1	1	24.4	24.5	24.5	23.8	23.9	23.9	24.2	24.0	24.0	23.0	23.1	23.4			
		1	158	24.5	24.4	24.3	23.9	23.9	23.8	24.0	24.1	24.3	23.2	23.4	23.6			
		1	159	23.5	23.5	23.3	22.9	22.9	22.8	23.0	23.0	23.3	22.2	22.4	22.7			
		80	40	24.4	24.5	24.4	23.8	23.9	23.8	24.0	24.0	24.2	23.1	23.3	23.5			
		160	0	23.4	23.4	23.4	22.9	22.8	22.8	23.0	23.0	23.1	22.1	22.3	22.5			
	16QAM	1	0	22.5	22.6	22.5	22.1	21.7	21.7	22.1	21.8	22.0	21.0	21.0	21.3			
		1	1	23.1	23.3	23.4	22.9	22.9	22.9	23.1	22.8	23.0	22.0	22.0	22.3			
		1	158	23.6	23.3	23.2	22.9	22.8	22.9	23.0	23.0	23.4	22.3	22.6	22.6			
		1	159	22.5	22.1	22.2	21.8	21.9	21.7	21.9	22.0	22.4	21.2	21.6	21.5			
		80	40	23.4	23.5	23.4	22.9	22.9	22.8	23.0	23.1	23.1	22.1	22.3	22.4			
		160	0	22.4	22.3	22.4	21.9	21.9	21.8	22.1	22.0	22.1	21.1	21.3	21.5			
	64QAM	1	0	22.0	21.8	22.0	21.8	21.2	21.6	21.7	21.3	21.4	20.4	20.6	20.9			
		1	1	21.9	21.9	21.8	21.6	21.5	21.6	21.8	21.4	21.5	20.5	20.6	20.9			
		1	158	22.0	22.0	21.7	21.4	21.5	21.5	21.6	21.5	21.7	20.7	21.0	21.1			
		1	159	21.9	22.2	21.6	21.6	21.4	20.9	21.6	21.4	21.8	20.7	21.0	21.1			
		80	40	22.0	22.0	21.3	21.3	21.3	21.3	21.5	21.4	21.6	20.5	20.8	21.0			
		160	0	22.0	21.9	21.3	21.4	21.4	21.4	21.5	21.5	21.6	20.6	20.8	21.0			
	256QAM	1	0	20.2	20.2	19.8	19.3	19.4	19.9	19.6	19.4	19.3	18.5	18.4	18.8			
		1	1	20.2	19.8	19.5	19.5	19.4	19.4	19.6	19.4	19.4	18.5	18.5	18.8			
		1	158	19.7	20.0	20.0	19.5	19.6	19.1	19.4	19.4	19.7	18.6	18.8	19.1			
		1	159	19.9	19.7	19.8	19.3	19.6	19.6	19.3	19.4	19.7	18.6	18.8	19.1			
		80	40	20.0	19.9	19.9	19.4	19.3	19.3	19.5	19.5	19.5	18.6	18.8	19.0			
		160	0	20.0	19.9	19.8	19.4	19.2	19.4	19.5	19.5	19.5	18.6	18.8	18.9			

**OUTPUT POWER FOR 5G NR n25 (35.0 MHz)**

Bandwidth (MHz)	Modulation	RB Allocation	RB Offset	Conducted Average (dBm)											
				ANT 2			ANT 0			ANT 1			ANT 5		
				373500	376500	379500	373500	376500	379500	373500	376500	379500	373500	376500	379500
35.0	BPSK	1	0	23.8	24.1	24.0	23.5	23.6	23.6	23.7	23.5	23.5	22.5	22.5	22.8
		1	1	24.4	24.5	24.4	23.9	23.9	23.8	24.2	24.1	24.0	23.0	23.1	23.3
		1	186	24.5	24.5	24.4	23.7	23.9	23.9	24.1	24.2	24.4	23.2	23.5	23.7
		1	187	23.9	24.0	23.9	23.5	23.6	23.5	23.6	23.7	23.8	22.6	23.0	23.2
		90	45	24.0	24.0	23.9	23.5	23.5	23.5	24.1	24.1	24.2	23.1	23.4	23.5
		180	0	24.0	23.9	24.0	23.6	23.5	23.5	23.6	23.6	23.7	22.6	22.9	23.0
	QPSK	1	0	23.4	23.5	23.5	23.0	23.0	23.0	23.2	23.1	23.0	21.9	22.1	22.3
		1	1	24.4	24.4	24.5	23.9	23.9	23.8	24.2	24.0	24.0	23.0	23.1	23.3
		1	186	24.4	24.5	24.5	23.9	23.8	23.8	24.1	24.2	24.3	23.2	23.5	23.7
		1	187	23.5	23.4	23.4	23.2	23.1	23.0	23.1	23.2	23.3	22.2	22.5	22.7
		90	45	23.4	23.4	23.6	23.1	22.9	23.1	24.1	24.1	24.2	23.1	23.4	23.5
		180	0	23.5	23.4	23.4	23.0	23.0	23.1	23.1	23.1	23.1	22.1	22.4	22.5
	16QAM	1	0	22.4	22.3	22.8	22.0	21.7	22.0	22.3	22.2	22.0	21.0	21.1	21.3
		1	1	23.4	23.5	23.6	22.8	23.0	23.1	23.3	23.2	23.1	22.0	22.0	22.3
		1	186	23.5	23.4	23.3	23.3	23.4	22.6	23.2	23.3	23.3	22.2	22.4	22.7
		1	187	22.1	22.5	22.4	21.9	21.9	21.9	22.1	22.3	22.5	21.1	21.5	21.7
		90	45	22.4	22.5	22.5	22.0	22.0	22.0	23.1	23.0	23.2	22.1	22.3	22.5
		180	0	22.5	22.4	22.4	22.1	22.0	22.0	22.1	22.0	22.2	21.1	21.3	21.5
	64QAM	1	0	22.1	22.1	22.1	21.4	21.6	21.5	21.6	21.6	21.7	20.4	20.6	20.7
		1	1	21.5	21.9	22.0	21.6	21.7	21.3	21.7	21.6	21.7	20.5	20.6	20.7
		1	186	21.9	22.1	21.8	21.5	21.6	21.2	21.5	21.8	22.1	20.7	21.0	21.1
		1	187	21.8	22.0	21.4	21.6	21.6	21.7	21.3	21.7	22.0	20.6	21.1	21.1
		90	45	21.9	21.9	22.0	21.5	21.4	21.5	21.6	21.5	21.7	20.6	20.8	21.0
		180	0	22.0	21.9	22.0	21.6	21.5	21.4	21.6	21.5	21.6	20.6	20.8	21.0
	256QAM	1	0	20.0	19.5	20.0	19.8	19.5	19.6	19.7	19.5	19.6	18.4	18.5	18.7
		1	1	19.8	19.6	19.7	19.5	19.3	19.3	19.8	19.5	19.6	18.5	18.5	18.7
		1	186	20.1	19.7	20.0	19.6	19.2	19.8	19.7	19.7	20.0	18.6	18.9	19.0
		1	187	20.0	19.8	19.8	19.6	19.9	19.3	19.6	19.6	20.0	18.6	19.0	19.0
		90	45	19.9	19.9	19.9	19.6	19.4	19.5	19.5	19.5	19.7	18.6	18.8	19.0
		180	0	19.9	19.9	19.9	19.6	19.3	19.5	19.5	19.5	19.6	18.6	18.8	18.9

**OUTPUT POWER FOR 5G NR n25 (40.0 MHz)**

Bandwidth (MHz)	Modulation	RB Allocation	RB Offset	Conducted Average (dBm)											
				ANT 2			ANT 0			ANT 1			ANT 5		
				374000	376500	379000	374000	376500	379000	374000	376500	379000	374000	376500	379000
40.0	BPSK	1	0	23.9	23.9	24.1	23.6	23.6	23.5	23.7	23.5	23.5	22.5	22.5	22.7
		1	1	24.4	24.4	24.6	24.0	23.9	23.9	24.2	24.1	24.2	23.0	23.0	23.2
		1	214	24.5	24.4	24.4	23.9	23.9	23.9	24.1	24.2	24.4	23.3	23.5	23.7
		1	215	24.0	23.9	23.9	23.6	23.5	23.6	23.6	23.7	23.9	22.8	23.0	23.2
		108	54	24.4	24.4	24.5	23.8	23.8	23.8	24.1	24.0	24.1	23.1	23.3	23.5
		216	0	23.9	23.8	23.9	23.6	23.5	23.6	23.6	23.6	23.6	22.7	22.8	23.0
	QPSK	1	0	23.4	23.4	23.5	23.2	23.0	23.1	23.1	23.0	23.0	22.0	22.0	22.2
		1	1	24.4	24.5	24.6	23.9	23.8	23.8	24.1	24.0	24.1	23.1	23.1	23.2
		1	214	24.5	24.5	24.4	23.9	23.7	24.0	24.1	24.2	24.2	23.4	23.5	23.7
		1	215	23.5	23.4	23.5	23.0	23.0	23.1	23.0	23.0	23.1	22.4	22.5	22.6
		108	54	24.4	24.5	24.4	23.9	23.8	23.8	24.1	23.9	24.1	23.2	23.3	23.5
		216	0	23.5	23.4	23.4	23.0	23.0	23.0	23.1	23.1	23.1	22.2	22.4	22.4
	16QAM	1	0	22.2	22.7	22.3	22.0	22.2	22.1	22.2	22.1	22.1	21.1	21.0	21.3
		1	1	23.4	23.2	23.4	23.1	23.3	23.2	23.2	23.0	23.2	22.1	22.1	22.3
		1	214	23.3	23.2	23.5	23.1	22.9	23.0	23.1	23.2	23.3	22.3	22.5	22.8
		1	215	22.5	22.3	22.3	22.2	22.0	22.1	22.1	22.2	22.1	21.3	21.5	21.7
		108	54	23.4	23.4	23.5	23.0	23.0	23.1	23.1	23.0	23.1	22.1	22.3	22.5
		216	0	22.4	22.5	22.4	22.0	22.0	22.0	22.1	22.1	22.1	21.2	21.3	21.5
	64QAM	1	0	21.8	21.8	21.8	21.9	21.6	21.5	21.7	21.8	21.5	20.5	20.5	20.8
		1	1	22.0	21.7	22.2	21.8	21.2	21.4	21.8	21.8	21.5	20.4	20.5	20.8
		1	214	22.0	22.1	22.1	21.8	21.7	21.1	21.6	21.4	21.9	20.9	21.0	21.2
		1	215	21.8	22.2	21.8	21.7	21.5	21.4	21.6	21.6	21.9	20.9	21.0	21.2
		108	54	21.9	21.9	21.9	21.6	21.5	21.4	21.6	21.6	21.6	20.6	20.8	20.9
		216	0	21.9	21.9	21.9	21.6	21.4	21.6	21.6	21.6	21.6	20.6	20.8	20.9
	256QAM	1	0	20.0	20.0	20.2	19.9	19.7	19.6	19.5	19.5	19.4	18.4	18.5	18.7
		1	1	19.4	19.7	19.9	19.5	19.5	19.7	19.6	19.6	19.5	18.4	18.5	18.7
		1	214	19.8	19.8	19.6	19.5	19.3	19.6	19.6	19.6	19.8	18.7	19.0	19.2
		1	215	20.1	20.2	20.3	19.5	19.5	19.7	19.5	19.6	19.7	18.6	19.0	19.1
		108	54	19.8	19.9	20.0	19.4	19.4	19.4	19.6	19.6	19.6	18.6	18.8	19.0
		216	0	19.9	19.9	20.0	19.5	19.4	19.5	19.6	19.6	19.6	18.6	18.8	18.9

### 8.8. LTE BAND 26 AND 5G NR 26 (Part 90S)

#### LTE BAND 26

<b>Test Engineer ID:</b>	28529JB and 39005RA	<b>Test Date:</b>	2024-01-22 to 2024-04-02
--------------------------	---------------------	-------------------	--------------------------

#### OUTPUT POWER FOR LTE BAND 26 (1.4 MHz)

Bandwidth (MHz)	Modulation	RB Allocation	RB Offset	Conducted Average (dBm)					
				ANT 0			ANT 1		
				26697	26740	26783	26697	26740	26783
1.4	QPSK	1	0	24.9	25.0	24.9	24.2	24.1	24.1
		1	2	24.9	24.9	25.0	24.1	24.0	23.9
		1	5	24.9	25.0	24.9	24.2	24.1	24.1
		3	0	24.8	24.8	24.8	24.1	24.1	24.1
		3	1	24.8	24.8	24.8	24.1	24.1	24.0
		3	2	24.7	24.8	24.8	24.1	24.0	24.0
	16QAM	6	0	23.9	24.0	23.9	23.2	23.1	23.1
		1	0	24.0	24.0	23.8	23.1	23.0	23.0
		1	2	23.9	24.1	23.9	23.2	23.2	23.1
		1	5	24.0	24.0	23.9	23.1	23.0	23.1
		3	0	23.8	23.8	23.9	23.2	23.2	23.2
		3	1	23.8	23.9	23.9	23.1	23.2	23.1
	64QAM	3	2	23.7	23.8	23.9	23.1	23.1	23.1
		6	0	22.9	23.0	22.9	22.1	22.1	22.0
		1	0	22.7	22.9	22.9	22.1	22.0	22.1
		1	2	23.0	23.1	23.1	22.3	22.2	22.2
		1	5	22.8	23.0	23.0	22.2	22.1	22.2
		3	0	22.8	22.8	22.8	22.0	22.1	22.1
	256QAM	3	1	22.9	22.8	22.8	22.0	22.0	22.0
		3	2	22.8	22.8	22.8	22.0	21.9	22.0
		6	0	21.9	21.9	21.9	21.1	21.0	21.1
		1	0	19.8	19.9	19.8	19.0	19.0	19.1
		1	2	19.6	19.9	20.0	19.2	19.1	19.2
		1	5	19.8	19.9	19.8	19.0	18.9	19.1

#### OUTPUT POWER FOR LTE BAND 26 (3.0 MHz)

Bandwidth (MHz)	Modulation	RB Allocation	RB Offset	Conducted Average (dBm)					
				ANT 0			ANT 1		
				26705	26740	26775	26705	26740	26775
3.0	QPSK	1	0	24.9	24.9	24.9	24.2	24.0	24.1
		1	7	24.7	24.7	24.8	24.1	23.9	24.0
		1	14	25.0	24.9	24.9	24.3	24.2	24.0
		8	0	23.9	23.9	23.9	23.3	23.1	23.1
		8	4	23.9	23.9	23.9	23.3	23.1	23.0
		8	7	23.9	23.9	23.9	23.0	23.0	23.1
	16QAM	15	0	23.9	23.9	23.8	23.0	23.1	23.1
		1	0	24.1	23.7	23.9	23.2	23.0	23.3
		1	7	24.0	23.7	23.9	23.1	22.9	23.1
		1	14	24.0	23.6	23.8	23.1	22.9	23.3
		8	0	22.9	22.9	22.9	22.1	22.1	22.1
		8	4	22.9	22.9	22.9	22.1	22.1	22.0
	64QAM	8	7	22.9	22.9	22.9	22.0	22.0	22.1
		15	0	22.9	22.9	22.9	22.0	22.1	22.0
		1	0	23.0	22.9	22.9	22.2	22.2	22.2
		1	7	23.0	22.8	23.0	22.2	22.1	22.1
		1	14	23.1	23.0	22.9	22.1	22.2	22.3
		8	0	21.9	21.9	21.8	21.1	21.0	21.1
	256QAM	8	4	21.9	21.8	21.8	21.0	21.0	21.0
		8	7	21.9	21.8	21.8	21.0	21.0	21.0
		15	0	21.8	21.7	21.8	21.0	21.0	21.0
		1	0	20.0	19.9	19.8	19.1	19.4	19.1
		1	7	20.0	19.8	19.7	19.1	19.3	18.8
		1	14	20.0	19.8	19.7	19.1	19.3	19.0

**OUTPUT POWER FOR LTE BAND 26 (5.0 MHz)**

Bandwidth (MHz)	Modulation	RB Allocation	RB Offset	Conducted Average (dBm)					
				ANT 0			ANT 1		
				26715	26740	26765	26715	26740	26765
5.0	QPSK	1	0	24.7	24.7	24.7	23.9	24.0	24.0
		1	12	24.7	24.7	24.7	23.9	23.9	23.9
		1	24	24.7	<b>24.7</b>	24.7	23.9	24.0	<b>24.0</b>
		12	0	23.7	23.8	23.7	23.0	23.0	23.0
		12	6	23.7	23.8	23.7	22.9	23.0	23.0
		12	11	23.7	23.8	23.7	22.9	23.0	23.0
		25	0	23.7	23.8	23.7	22.9	23.0	23.0
	16QAM	1	0	23.8	<b>23.9</b>	23.8	22.9	<b>23.1</b>	23.1
		1	12	23.8	23.7	23.8	22.9	23.1	23.1
		1	24	23.8	23.8	23.8	22.9	23.1	23.1
		12	0	22.8	22.7	22.7	21.9	22.0	22.0
		12	6	22.7	22.7	22.6	21.8	22.0	22.0
		12	11	22.7	22.7	22.7	21.9	22.0	21.9
		25	0	22.7	22.8	22.7	22.0	22.0	22.0
	64QAM	1	0	23.0	22.9	22.9	22.2	22.2	22.2
		1	12	23.0	22.9	22.8	22.1	22.1	22.2
		1	24	<b>23.1</b>	22.9	22.9	22.2	22.2	<b>22.2</b>
		12	0	21.7	21.7	21.7	20.9	21.0	21.0
		12	6	21.7	21.7	21.7	20.9	21.0	21.0
		12	11	21.7	21.7	21.7	20.9	21.0	21.0
		25	0	21.7	21.7	21.6	20.9	21.0	21.0
	256QAM	1	0	19.8	<b>19.8</b>	19.8	<b>19.2</b>	<b>19.2</b>	19.1
		1	12	19.7	19.7	19.7	19.0	19.1	19.0
		1	24	19.7	19.8	19.8	19.1	19.1	19.1
		12	0	19.7	19.8	19.7	18.9	19.0	19.0
12		6	19.7	19.7	19.6	18.9	19.0	19.0	
12		11	19.7	19.7	19.7	18.9	19.0	19.0	
25		0	19.7	19.7	19.7	19.0	19.0	19.0	

**OUTPUT POWER FOR LTE BAND 26 (10.0 MHz)**

Bandwidth (MHz)	Modulation	RB Allocation	RB Offset	Conducted Average (dBm)					
				ANT 0			ANT 1		
				N/A	26740	N/A	N/A	26740	N/A
10.0	QPSK	1	0		<b>24.7</b>			<b>24.1</b>	
		1	24		24.5			24.0	
		1	49		24.7			24.0	
		25	0		23.7			23.1	
		25	12		23.6			23.0	
		25	24		23.6			23.0	
		50	0		23.7			23.1	
	16QAM	1	0		<b>23.9</b>			<b>23.2</b>	
		1	24		<b>23.9</b>			23.0	
		1	49		23.8			23.0	
		25	0		22.7			22.0	
		25	12		22.6			22.0	
		25	24		22.6			22.0	
		50	0		22.7			22.0	
	64QAM	1	0		<b>22.9</b>			<b>22.2</b>	
		1	24		22.9			22.2	
		1	49		22.8			22.0	
		25	0		21.7			21.1	
		25	12		21.7			21.0	
		25	24		21.7			21.0	
		50	0		21.6			21.0	
	256QAM	1	0		19.7			<b>19.2</b>	
		1	24		19.5			19.1	
		1	49		19.6			19.1	
		25	0		<b>19.7</b>			19.1	
25		12		19.7			19.1		
25		24		19.7			19.0		
50		0		19.6			19.0		

**5G NR n26**

Test Engineer ID:	19210AL	Test Date:	2024-02-15
-------------------	---------	------------	------------

**OUTPUT POWER FOR 5G NR n26 (5.0 MHz)**

Bandwidth (MHz)	Modulation	RB Allocation	RB Offset	Conducted Average (dBm)					
				ANT 0			ANT 1		
				163300	163800	164300	163300	163800	164300
5.0	BPSK	1	0	23.8	23.8	23.7	23.3	23.5	<b>23.8</b>
		1	1	<b>24.4</b>	24.3	24.2	23.5	23.6	23.8
		1	23	24.3	24.2	24.2	23.5	23.6	23.8
		1	24	23.9	23.7	23.6	23.4	23.4	23.8
		12	6	24.2	24.3	24.2	23.6	23.5	23.8
	QPSK	25	0	23.7	23.8	23.7	23.4	23.3	23.7
		1	0	23.3	23.2	23.3	22.8	22.9	23.4
		1	1	24.3	24.2	24.2	23.5	23.6	<b>23.6</b>
		1	23	<b>24.3</b>	24.2	24.2	23.6	23.5	<b>23.6</b>
		1	24	23.3	23.2	23.3	22.8	22.8	23.3
	16QAM	12	6	24.2	24.3	24.2	23.5	23.5	<b>23.6</b>
		25	0	23.2	23.3	23.2	22.7	22.9	23.4
		1	0	22.0	22.3	22.0	22.0	22.1	22.6
		1	1	23.3	23.4	<b>23.5</b>	22.7	<b>22.9</b>	<b>22.9</b>
		1	23	23.3	23.3	23.4	22.7	22.8	<b>22.9</b>
	64QAM	1	24	22.1	22.2	22.6	21.5	21.7	22.6
		12	6	23.2	23.3	23.3	22.8	22.8	<b>22.9</b>
		25	0	22.3	22.2	22.0	21.8	21.8	22.2
		1	0	21.7	21.9	21.8	<b>21.8</b>	21.1	21.7
		1	1	21.9	21.6	21.9	21.0	21.6	21.8
	256QAM	1	23	21.8	21.9	21.9	21.5	21.7	21.8
		1	24	21.9	21.6	<b>22.1</b>	21.3	21.6	21.7
		12	6	21.7	21.7	21.7	21.3	21.5	21.7
		25	0	21.7	21.8	21.7	21.3	21.3	21.7
		1	0	19.9	19.4	19.6	19.3	18.9	<b>20.2</b>
	1	1	19.8	<b>20.2</b>	19.8	19.4	19.7	19.6	
	1	23	19.9	19.4	19.7	19.6	19.1	19.8	
	1	24	19.8	20.1	20.0	19.7	19.4	19.9	
	12	6	19.7	19.8	19.6	19.5	19.3	19.8	
	25	0	19.7	19.8	19.7	19.5	19.4	19.8	

**OUTPUT POWER FOR 5G NR n26 (10.0 MHz)**

Bandwidth (MHz)	Modulation	RB Allocation	RB Offset	Conducted Average (dBm)					
				ANT 0			ANT 1		
				N/A	163800	N/A	N/A	163800	N/A
10.0	BPSK	1	0		23.8			23.3	
		1	1		24.2			23.5	
		1	50		24.2			23.4	
		1	51		23.8			23.3	
		25	12		<b>24.3</b>			<b>23.5</b>	
	QPSK	50	0		23.8			23.2	
		1	0		23.2			22.8	
		1	1		24.2			23.5	
		1	50		24.2			<b>23.5</b>	
		1	51		23.3			22.8	
	16QAM	25	12		<b>24.3</b>			23.5	
		50	0		23.3			22.7	
		1	0		22.1			21.8	
		1	1		23.0			<b>22.7</b>	
		1	50		23.1			22.7	
	64QAM	1	51		22.2			21.7	
		25	12		<b>23.2</b>			<b>22.7</b>	
		50	0		22.3			21.8	
		1	0		21.9			21.1	
		1	1		22.0			21.2	
	256QAM	1	50		<b>22.1</b>			21.0	
		1	51		21.6			<b>21.4</b>	
		25	12		21.8			21.2	
		50	0		21.8			21.3	
		1	0		19.4			19.5	
	1	1		19.6			19.5		
	1	50		19.7			<b>19.6</b>		
	1	51		19.8			19.3		
	25	12		19.8			19.5		
	50	0		<b>19.9</b>			19.4		

### 8.9. LTE BAND 26 AND 5G NR n26 (Part 22)

#### LTE BAND 26

<b>Test Engineer ID:</b>	28529JB and 39005RA	<b>Test Date:</b>	2024-01-22 to 2024-04-02
--------------------------	---------------------	-------------------	--------------------------

#### OUTPUT POWER FOR LTE BAND 26 (1.4 MHz)

Bandwidth (MHz)	Modulation	RB Allocation	RB Offset	Conducted Average (dBm)					
				ANT 0			ANT 1		
				26797	26915	27033	26797	26915	27033
1.4	QPSK	1	0	24.5	24.4	24.4	24.1	24.0	24.0
		1	2	24.4	24.3	24.3	23.9	23.8	23.8
		1	5	24.5	24.4	24.4	24.0	24.0	23.9
		3	0	23.4	23.3	23.3	24.0	23.9	23.9
		3	1	23.4	23.2	23.3	24.0	23.9	23.9
		3	2	23.4	23.2	23.2	23.9	23.9	23.9
	16QAM	6	0	23.5	23.3	23.4	23.0	23.0	23.0
		1	0	23.6	23.5	23.5	23.2	23.1	23.2
		1	2	23.8	23.6	23.5	23.1	23.2	23.2
		1	5	23.7	23.5	23.6	23.0	23.3	23.2
		3	0	23.6	23.5	23.4	23.0	23.0	23.0
		3	1	23.5	23.4	23.3	23.0	23.0	22.9
	64QAM	3	2	23.5	23.3	23.4	23.0	23.1	23.0
		6	0	22.9	22.7	22.7	22.1	22.0	22.0
		1	0	22.9	22.8	23.1	22.2	22.3	22.2
		1	2	22.8	22.8	22.6	22.2	22.0	22.0
		1	5	22.9	22.8	23.1	22.2	22.2	22.0
		3	0	23.0	22.8	22.9	22.2	22.1	21.9
	256QAM	3	1	23.0	22.8	22.9	21.9	21.9	21.9
		3	2	23.0	22.8	22.9	21.9	22.0	21.8
		6	0	21.7	21.6	21.5	20.9	21.0	21.0
		1	0	20.0	19.7	20.1	19.7	19.7	19.2
		1	2	20.0	19.7	20.0	19.7	19.7	19.1
		1	5	20.0	19.7	20.0	19.7	19.7	19.1

#### OUTPUT POWER FOR LTE BAND 26 (3.0 MHz)

Bandwidth (MHz)	Modulation	RB Allocation	RB Offset	Conducted Average (dBm)					
				ANT 0			ANT 1		
				26805	26915	27025	26805	26915	27025
3.0	QPSK	1	0	24.4	24.4	24.3	24.1	24.0	24.0
		1	7	24.4	24.3	24.3	24.0	24.0	23.9
		1	14	24.5	24.4	24.4	24.1	24.1	24.1
		8	0	23.5	23.4	23.4	23.0	23.0	23.0
		8	4	23.5	23.4	23.4	23.0	23.0	23.0
		8	7	23.5	23.4	23.4	23.0	23.0	23.0
	16QAM	15	0	23.5	23.3	23.3	23.0	23.0	23.0
		1	0	23.6	23.7	23.7	23.3	23.3	23.3
		1	7	23.5	23.6	23.6	23.2	23.2	23.3
		1	14	23.5	23.7	23.7	23.2	23.2	23.3
		8	0	22.9	22.8	22.7	22.1	22.0	22.0
		8	4	22.9	22.7	22.7	22.0	21.9	21.9
	64QAM	8	7	22.8	22.7	22.7	22.0	21.9	21.9
		15	0	22.8	22.7	22.7	21.9	22.0	22.0
		1	0	22.9	22.8	22.6	22.0	22.1	22.0
		1	7	22.8	22.7	22.6	21.9	22.1	21.9
		1	14	22.9	22.9	22.5	21.9	22.2	22.0
		8	0	21.8	21.7	21.7	21.0	21.0	21.0
	256QAM	8	4	21.8	21.7	21.6	21.0	20.9	21.0
		8	7	21.8	21.7	21.7	20.9	21.0	21.0
		15	0	21.8	21.7	21.6	21.0	20.9	21.0
		1	0	20.0	20.1	19.8	19.7	19.7	19.2
		1	7	20.0	19.9	19.8	19.7	19.7	19.1
		1	14	20.0	20.0	19.8	19.7	19.7	19.1

**OUTPUT POWER FOR LTE BAND 26 (5.0 MHz)**

Bandwidth (MHz)	Modulation	RB Allocation	RB Offset	Conducted Average (dBm)					
				ANT 0			ANT 1		
				26815 826.5	26915 836.5	27015 846.5	26815 826.5	26915 836.5	27015 846.5
5.0	QPSK	1	0	24.5	24.4	24.4	24.0	24.0	24.0
		1	12	24.3	24.3	24.3	24.0	24.0	24.0
		1	24	24.4	24.4	24.4	24.0	24.0	23.9
		12	0	23.4	23.4	23.4	23.0	23.0	23.0
		12	6	23.4	23.4	23.4	22.9	23.0	22.9
		12	11	23.4	23.4	23.4	22.9	23.0	22.9
		25	0	23.4	23.4	23.4	22.9	23.0	22.9
	16QAM	1	0	23.9	23.9	23.7	23.3	23.4	23.3
		1	12	23.8	23.8	23.7	23.2	23.2	23.1
		1	24	23.9	23.8	23.8	23.3	23.3	23.1
		12	0	22.7	22.8	22.6	22.1	22.1	22.0
		12	6	22.6	22.8	22.6	22.1	22.0	22.0
		12	11	22.6	22.7	22.6	22.0	22.0	22.0
		25	0	22.8	22.8	22.8	22.0	21.9	22.0
	64QAM	1	0	23.0	23.0	22.8	22.1	22.0	22.1
		1	12	22.8	23.0	22.8	22.0	22.1	22.2
		1	24	22.9	23.0	22.9	21.9	22.1	22.2
		12	0	21.6	21.7	21.6	20.9	21.1	21.0
		12	6	21.6	21.7	21.6	20.9	21.0	21.0
		12	11	21.6	21.7	21.5	20.9	21.0	20.9
		25	0	21.9	21.7	21.7	20.9	21.0	21.0
	256QAM	1	0	19.9	19.8	20.1	19.7	19.7	19.3
		1	12	19.9	19.8	20.0	19.7	19.7	19.1
		1	24	19.8	19.8	19.9	19.7	19.7	19.1
		12	0	19.8	19.8	19.8	19.7	19.7	19.2
12		6	19.8	19.7	19.8	19.7	19.6	19.2	
12		11	19.8	19.7	19.7	19.7	19.6	19.2	
25		0	19.8	19.7	19.7	19.6	19.7	19.1	

**OUTPUT POWER FOR LTE BAND 26 (10.0 MHz)**

Bandwidth (MHz)	Modulation	RB Allocation	RB Offset	Conducted Average (dBm)					
				ANT 0			ANT 1		
				26840 829.0	26915 836.5	26990 844.0	26840 829.0	26915 836.5	26990 844.0
10.0	QPSK	1	0	24.5	24.5	24.5	24.1	24.1	24.0
		1	24	24.4	24.4	24.4	24.0	24.0	23.9
		1	49	24.4	24.4	24.4	24.0	23.9	24.0
		25	0	23.5	23.5	23.4	23.0	23.0	23.0
		25	12	23.5	23.4	23.4	22.9	23.0	23.0
		25	24	23.4	23.4	23.4	22.9	22.9	23.0
		50	0	23.5	23.4	23.4	22.9	23.0	23.0
	16QAM	1	0	23.8	23.9	23.7	23.2	23.3	23.4
		1	24	23.8	23.9	23.8	23.2	23.2	23.3
		1	49	23.7	23.7	23.6	23.1	23.2	23.2
		25	0	22.8	22.8	22.8	22.0	22.0	22.0
		25	12	22.8	22.8	22.7	22.0	21.9	22.0
		25	24	22.8	22.8	22.7	21.9	21.9	21.9
		50	0	22.8	22.8	22.7	22.0	21.9	22.0
	64QAM	1	0	23.1	23.1	22.9	22.1	22.1	22.1
		1	24	23.0	23.1	23.0	22.0	22.0	22.0
		1	49	23.1	22.9	22.8	22.0	22.0	22.0
		25	0	21.9	21.8	21.7	21.0	21.0	21.0
		25	12	21.8	21.8	21.7	20.9	21.0	21.0
		25	24	21.8	21.7	21.6	20.9	20.9	20.9
		50	0	21.8	21.8	21.7	20.9	20.9	20.9
	256QAM	1	0	19.8	19.6	20.0	19.7	19.7	19.4
		1	24	19.9	19.5	19.9	19.6	19.7	19.3
		1	49	19.7	19.5	19.9	19.6	19.7	19.2
		25	0	19.9	19.8	19.8	19.7	19.7	19.3
25		12	19.9	19.8	19.7	19.7	19.7	19.2	
25		24	19.8	19.7	19.7	19.7	19.7	19.2	
50		0	19.8	19.7	19.7	19.7	19.7	19.1	



**OUTPUT POWER FOR LTE BAND 26 (15.0 MHz)**

Bandwidth (MHz)	Modulation	RB Allocation	RB Offset	Conducted Average (dBm)					
				ANT 0			ANT 1		
				26865 831.5	26915 836.5	26965 841.5	26865 831.5	26915 836.5	26965 841.5
10.0	QPSK	1	0	24.4	24.0	24.4	24.2	24.1	24.1
		1	24	24.1	23.8	24.4	24.0	23.9	23.9
		1	49	24.3	23.8	24.3	24.0	24.0	24.0
		25	0	23.5	23.0	23.5	23.2	23.0	23.2
		25	12	23.4	23.0	23.5	23.1	22.9	23.1
		25	24	23.4	22.9	23.4	23.1	22.9	23.1
		50	0	23.4	23.0	23.5	23.1	22.9	23.1
	16QAM	1	0	23.5	23.3	23.4	23.3	23.3	23.3
		1	24	23.3	23.1	23.3	23.2	23.1	23.1
		1	49	23.3	23.1	23.2	23.1	23.1	23.1
		25	0	22.3	22.2	22.4	22.1	22.3	22.1
		25	12	22.3	22.2	22.3	22.1	22.3	22.1
		25	24	22.3	22.1	22.3	22.0	22.2	22.0
		50	0	22.3	22.2	22.4	22.1	22.2	22.1
	64QAM	1	0	22.4	22.4	22.4	22.4	22.3	22.4
		1	24	22.2	22.3	22.3	22.1	22.0	22.1
		1	49	22.4	22.4	22.4	22.4	22.1	22.2
		25	0	21.3	21.2	21.3	21.1	21.3	21.1
		25	12	21.3	21.2	21.3	21.0	21.3	21.1
		25	24	21.2	21.1	21.3	21.0	21.2	21.0
		50	0	21.3	21.2	21.3	21.1	21.2	21.1
	256QAM	1	0	19.9	20.1	20.0	19.3	19.4	19.4
		1	24	19.8	20.0	20.0	19.2	19.2	19.2
		1	49	19.8	19.9	19.9	19.2	19.2	19.2
		25	0	19.9	19.8	19.9	19.1	19.3	19.0
		25	12	19.9	19.7	19.9	19.0	19.2	19.0
		25	24	19.8	19.7	19.8	19.0	19.2	19.0
		50	0	19.9	19.7	19.9	19.0	19.2	19.0

**5G NR n26**

<b>Test Engineer ID:</b>	19210AL and 32934IG	<b>Test Date:</b>	2024-02-15 to 2024-04-09
--------------------------	---------------------	-------------------	--------------------------

**OUTPUT POWER FOR 5G NR n26 (5.0 MHz)**

Bandwidth (MHz)	Modulation	RB Allocation	RB Offset	Conducted Average (dBm)					
				ANT 0			ANT 1		
				165300	167300	169300	165300	167300	169300
5.0	BPSK	1	0	23.9	23.8	23.8	23.4	23.2	23.3
		1	1	24.3	24.2	24.3	23.6	23.5	23.4
		1	23	24.3	24.4	24.3	23.5	23.5	23.5
		1	24	23.9	23.9	23.8	23.4	23.3	23.2
		12	6	24.3	24.4	24.3	23.6	23.5	23.6
		25	0	23.8	23.8	23.8	23.4	23.2	23.2
	QPSK	1	0	23.3	23.3	23.3	22.9	22.7	22.9
		1	1	24.4	24.4	24.3	23.6	23.4	23.5
		1	23	24.4	24.4	24.4	23.5	23.5	23.5
		1	24	23.2	23.5	23.4	22.8	22.9	22.8
		12	6	24.3	24.4	24.4	23.6	23.4	23.5
		25	0	23.3	23.4	23.3	22.9	22.7	22.7
	16QAM	1	0	22.3	22.3	22.7	21.9	21.5	21.7
		1	1	23.5	23.4	23.3	22.8	22.4	23.1
		1	23	23.4	23.4	23.3	22.9	22.8	23.3
		1	24	22.5	22.6	22.3	22.0	21.6	22.0
		12	6	23.4	23.3	23.4	22.9	22.7	22.8
		25	0	22.3	22.2	22.3	21.9	21.7	21.8
	64QAM	1	0	21.6	22.0	21.7	21.3	21.3	21.4
		1	1	21.7	22.0	21.9	21.2	21.4	21.0
		1	23	22.0	22.0	22.0	21.2	21.2	21.2
		1	24	21.9	22.1	21.8	21.1	20.5	21.4
		12	6	21.8	21.8	21.8	21.6	21.2	21.3
		25	0	21.8	21.8	21.9	21.4	21.2	21.2
	256QAM	1	0	19.9	19.5	19.9	19.7	19.0	19.8
		1	1	19.8	19.5	19.6	19.2	19.1	19.6
		1	23	19.6	20.0	19.6	19.5	19.7	19.2
		1	24	19.8	19.7	20.1	19.6	18.9	19.0
		12	6	19.9	19.8	19.9	19.4	19.2	19.3
		25	0	19.7	19.7	19.9	19.3	19.2	19.2

**OUTPUT POWER FOR 5G NR n26 (10.0 MHz)**

Bandwidth (MHz)	Modulation	RB Allocation	RB Offset	Conducted Average (dBm)					
				ANT 0			ANT 1		
				165800	167300	168800	165800	167300	168800
10.0	BPSK	1	0	23.9	23.9	24.0	23.4	23.5	23.4
		1	1	24.4	24.4	24.4	23.6	23.7	23.5
		1	50	24.3	24.3	24.4	23.5	23.6	23.4
		1	51	23.7	23.9	23.9	23.3	23.3	23.2
		25	12	24.3	24.3	24.4	23.6	23.4	23.5
		50	0	23.8	23.9	23.8	23.3	23.4	23.3
	QPSK	1	0	23.3	23.3	23.3	22.8	22.8	22.7
		1	1	24.4	24.4	24.3	23.6	23.6	23.4
		1	50	24.3	24.3	24.3	23.5	23.5	23.5
		1	51	23.3	23.3	23.3	22.9	22.7	22.7
		25	12	24.3	24.4	24.4	23.6	23.5	23.4
		50	0	23.3	23.4	23.3	22.8	22.7	22.8
	16QAM	1	0	22.5	22.4	22.3	21.8	21.7	21.7
		1	1	23.2	23.6	23.6	23.2	22.9	22.9
		1	50	23.6	23.3	23.3	22.7	23.2	22.8
		1	51	22.6	22.6	22.1	22.0	21.6	21.7
		25	12	23.3	23.3	23.5	22.9	22.9	22.7
		50	0	22.2	22.4	22.3	21.9	21.8	21.7
	64QAM	1	0	21.9	21.7	21.8	21.5	21.5	21.3
		1	1	21.6	21.8	21.8	21.4	21.7	21.4
		1	50	21.8	21.8	21.9	21.3	21.4	21.4
		1	51	21.9	22.2	22.0	21.4	21.2	21.2
		25	12	21.8	21.8	22.0	21.4	21.2	21.2
		50	0	21.9	21.9	21.9	21.3	21.3	21.3
	256QAM	1	0	20.1	19.9	20.2	19.9	19.3	19.1
		1	1	20.0	19.6	20.1	19.8	19.3	19.1
		1	50	20.0	20.2	20.1	19.2	18.9	19.1
		1	51	19.8	19.7	19.6	19.1	18.8	19.3
		25	12	19.9	19.8	19.8	19.3	19.2	19.2
		50	0	19.8	19.8	19.9	19.4	19.2	19.2

**OUTPUT POWER FOR 5G NR n26 (15.0 MHz)**

Bandwidth (MHz)	Modulation	RB Allocation	RB Offset	Conducted Average (dBm)					
				ANT 0			ANT 1		
				166300	167300	168300	166300	167300	168300
15.0	BPSK	1	0	23.9	23.8	23.9	23.7	23.6	23.4
		1	1	<b>24.4</b>	24.3	24.3	<b>24.1</b>	24.1	<b>24.1</b>
		1	77	24.4	24.3	24.2	24.0	23.6	23.9
		1	78	23.8	23.6	23.6	23.6	23.3	23.3
		36	18	24.3	24.3	24.3	24.1	24.0	24.1
		75	0	23.8	23.8	23.8	23.6	23.6	23.6
	QPSK	1	0	23.3	23.3	23.1	23.2	23.1	22.9
		1	1	24.2	24.4	24.2	<b>24.2</b>	24.1	23.9
		1	77	<b>24.4</b>	24.3	24.1	24.2	24.0	23.9
		1	78	23.3	23.3	23.1	23.2	23.1	22.9
		36	18	24.3	24.3	24.3	24.1	24.1	24.1
		75	0	23.3	23.3	23.3	23.1	23.1	23.0
	16QAM	1	0	22.1	22.3	22.4	22.0	22.0	22.1
		1	1	23.2	23.3	23.4	22.9	23.0	23.1
		1	77	23.1	23.2	<b>23.4</b>	23.0	23.0	23.1
		1	78	22.2	22.0	22.3	22.0	21.9	22.0
		36	18	23.3	23.3	23.3	<b>23.1</b>	23.1	23.1
		75	0	22.3	22.3	22.3	22.1	22.0	22.0
	64QAM	1	0	21.9	21.7	21.8	21.9	21.6	21.4
		1	1	21.8	21.6	21.6	<b>21.9</b>	21.6	21.5
		1	77	21.9	21.6	21.6	21.8	21.6	21.5
		1	78	21.7	21.6	<b>22.0</b>	21.9	21.5	21.4
		36	18	21.8	21.7	21.8	21.6	21.6	21.5
		75	0	21.8	21.8	21.9	21.6	21.6	21.6
	256QAM	1	0	19.9	19.5	19.8	19.4	19.5	19.6
		1	1	19.8	19.4	19.9	19.4	19.6	19.6
		1	77	19.7	19.6	<b>20.1</b>	19.4	19.3	19.6
		1	78	20.0	19.5	19.9	19.4	19.6	19.6
		36	18	19.8	19.8	19.9	19.6	19.6	<b>19.7</b>
		75	0	19.8	19.9	19.9	<b>19.7</b>	19.6	19.6

**OUTPUT POWER FOR 5G NR n26 (20.0 MHz)**

Bandwidth (MHz)	Modulation	RB Allocation	RB Offset	Conducted Average (dBm)					
				ANT 0			ANT 1		
				166800	167300	167800	166800	167300	167800
20.0	BPSK	1	0	23.7	23.8	23.8	23.6	23.6	23.5
		1	1	24.2	<b>24.3</b>	24.3	23.9	<b>24.1</b>	24.1
		1	104	24.2	24.2	24.2	23.8	23.9	24.0
		1	105	23.5	23.6	23.6	23.3	23.4	23.3
		50	25	24.3	24.3	24.3	24.1	24.1	24.0
		100	0	23.8	23.8	23.8	23.6	23.6	23.5
	QPSK	1	0	23.4	23.3	23.4	23.1	23.1	23.2
		1	1	24.0	<b>24.3</b>	24.3	24.1	24.2	<b>24.2</b>
		1	104	24.3	24.3	24.2	24.0	23.9	24.0
		1	105	23.4	23.3	23.1	23.0	23.1	23.0
		50	25	24.3	24.3	24.3	24.0	24.0	24.0
		100	0	23.3	23.3	23.3	23.1	23.1	23.1
	16QAM	1	0	22.1	22.5	22.3	22.3	21.9	22.2
		1	1	23.2	<b>23.4</b>	23.3	23.0	<b>23.2</b>	23.0
		1	104	23.3	23.3	23.3	23.0	23.2	23.1
		1	105	22.4	22.2	22.3	22.0	22.3	21.9
		50	25	23.3	23.3	23.4	23.0	23.0	23.1
		100	0	22.3	22.3	22.3	22.0	22.0	22.0
	64QAM	1	0	21.9	21.7	21.7	<b>21.7</b>	21.7	21.6
		1	1	21.8	21.7	<b>22.0</b>	21.6	21.6	21.5
		1	104	21.9	21.5	21.9	21.5	21.7	21.7
		1	105	21.8	21.6	21.9	21.6	21.5	21.7
		50	25	21.8	21.8	21.8	21.5	21.6	21.5
		100	0	21.8	21.8	21.8	21.6	21.5	21.6
	256QAM	1	0	19.7	19.7	19.9	<b>19.7</b>	19.7	19.5
		1	1	19.5	<b>20.1</b>	19.9	19.3	19.7	19.5
		1	104	19.6	19.8	19.7	19.4	19.4	19.4
		1	105	19.3	19.8	19.7	19.4	19.6	19.5
		50	25	19.8	19.8	19.8	19.5	19.6	19.6
		100	0	19.7	19.8	19.8	19.6	19.6	19.6

### 8.10. LTE BAND 30 AND 5G NR n30

#### LTE BAND 30

Test Engineer ID:	39005RA	Test Date:	2024-04-05
-------------------	---------	------------	------------

#### OUTPUT POWER FOR LTE BAND 30 (5.0 MHz)

Bandwidth (MHz)	Modulation	RB Allocation	RB Offset	Conducted Average (dBm)					
				ANT 2			ANT 0		
				27685	27710	27735	27685	27710	27735
5.0	QPSK	1	0	23.7	23.8	23.5	22.4	22.3	22.3
		1	12	<b>23.8</b>	23.8	23.5	22.3	22.4	22.3
		1	24	23.7	23.6	23.5	22.3	22.4	<b>22.4</b>
		12	0	23.2	23.2	23.0	22.3	22.3	22.3
		12	6	23.2	23.2	23.0	22.3	22.3	22.3
		12	11	23.2	23.1	23.0	22.3	22.3	22.3
		25	0	23.2	23.2	23.0	22.3	22.3	22.3
	16QAM	1	0	23.0	23.3	23.0	22.3	22.3	22.3
		1	12	23.1	<b>23.3</b>	23.1	22.2	22.2	22.3
		1	24	23.0	23.3	23.0	22.3	<b>22.3</b>	22.2
		12	0	21.9	21.9	21.8	22.1	22.2	22.1
		12	6	21.9	21.9	21.9	22.1	22.2	22.1
		12	11	21.9	21.9	21.8	22.1	22.1	22.1
		25	0	21.9	21.9	21.9	22.1	22.1	22.2
	64QAM	1	0	21.8	21.9	21.9	22.4	22.3	22.4
		1	12	21.8	22.0	<b>22.0</b>	<b>22.6</b>	22.3	22.4
		1	24	21.8	21.9	21.9	22.4	22.2	22.4
		12	0	20.7	20.7	20.6	21.4	21.5	21.5
		12	6	20.7	20.7	20.6	21.5	21.5	21.5
		12	11	20.7	20.7	20.6	21.5	21.4	21.5
		25	0	20.7	20.7	20.6	21.4	21.4	21.5
	256QAM	1	0	19.4	19.3	19.4	19.6	19.7	19.8
		1	12	<b>19.5</b>	19.4	19.5	19.8	<b>19.9</b>	19.8
		1	24	19.4	19.3	19.3	19.6	19.6	19.7
		12	0	19.2	19.2	19.2	19.5	19.5	19.5
12		6	19.2	19.2	19.2	19.5	19.5	19.5	
12		11	19.2	19.2	19.2	19.5	19.5	19.5	
25		0	19.2	19.2	19.2	19.5	19.5	19.5	

#### OUTPUT POWER FOR LTE BAND 30 (10.0 MHz)

Bandwidth (MHz)	Modulation	RB Allocation	RB Offset	Conducted Average (dBm)					
				ANT 2			ANT 0		
				N/A	27710	N/A	N/A	27710	N/A
10.0	QPSK	1	0		<b>23.7</b>			<b>22.5</b>	
		1	24		23.6			22.4	
		1	49		23.6			22.4	
		25	0		23.1			22.3	
		25	12		23.1			22.3	
		25	24		23.1			22.3	
		50	0		23.1			22.3	
	16QAM	1	0		23.2			<b>22.4</b>	
		1	24		<b>23.3</b>			22.4	
		1	49		23.1			22.4	
		25	0		22.2			22.3	
		25	12		22.2			22.3	
		25	24		22.2			22.3	
		50	0		22.1			22.3	
	64QAM	1	0		22.4			<b>22.4</b>	
		1	24		<b>22.5</b>			22.3	
		1	49		22.3			<b>22.4</b>	
		25	0		21.2			21.5	
		25	12		21.2			21.5	
		25	24		21.2			21.5	
		50	0		21.2			21.5	
	256QAM	1	0		19.3			19.7	
		1	24		<b>19.4</b>			<b>19.8</b>	
		1	49		19.3			19.6	
		25	0		19.3			19.7	
25		12		19.3			19.6		
25		24		19.3			19.6		
50		0		19.2			19.6		

**5G NR n30**

Test Engineer ID:	19210AL	Test Date:	2024-02-16
-------------------	---------	------------	------------

**OUTPUT POWER FOR 5G NR n30 (5.0 MHz)**

Bandwidth (MHz)	Modulation	RB Allocation	RB Offset	Conducted Average (dBm)					
				ANT 2			ANT 0		
				461500 2307.5	462000 2310.0	462500 2312.5	461500 2307.5	462000 2310.0	462500 2312.5
5.0	BPSK	1	0	23.6	23.7	23.5	22.5	22.6	22.4
		1	1	23.7	<b>23.7</b>	23.5	22.5	22.5	22.4
		1	23	23.6	23.5	23.5	22.5	22.4	22.3
		1	24	23.6	23.7	23.5	22.5	22.4	22.4
		12	6	23.6	23.6	23.5	22.5	22.5	22.3
	25	0	23.6	23.5	23.6	<b>22.6</b>	22.4	22.3	
	QPSK	1	0	23.0	23.1	23.1	22.5	22.4	22.4
		1	1	23.6	<b>23.7</b>	23.7	<b>22.5</b>	22.5	22.3
		1	23	23.6	23.5	23.5	22.5	22.4	22.3
		1	24	23.1	23.1	23.1	22.5	22.3	22.3
		12	6	23.6	23.6	23.5	<b>22.5</b>	22.4	22.3
	25	0	23.1	23.0	23.1	22.5	22.4	22.4	
	16QAM	1	0	22.1	21.8	21.7	22.5	22.5	22.6
		1	1	23.1	23.2	23.2	22.3	<b>22.8</b>	22.2
		1	23	<b>23.4</b>	23.2	23.0	22.2	22.6	22.5
		1	24	22.1	22.2	21.7	22.7	22.4	22.1
		12	6	23.0	23.1	23.1	22.5	22.5	22.3
	25	0	22.1	22.1	22.0	22.5	22.4	22.3	
	64QAM	1	0	22.2	22.2	22.1	22.1	22.4	22.1
		1	1	21.9	<b>22.4</b>	22.1	22.4	22.2	<b>22.5</b>
		1	23	22.1	22.1	22.0	22.5	21.9	22.2
		1	24	22.3	21.9	22.1	22.5	22.1	21.8
		12	6	22.1	22.1	21.9	22.3	22.1	22.0
	25	0	22.0	22.1	22.0	22.2	22.2	22.1	
	256QAM	1	0	20.1	20.1	20.3	<b>20.4</b>	20.2	19.8
1		1	20.0	19.7	20.2	20.2	19.8	20.1	
1		23	20.3	<b>20.6</b>	20.2	20.2	20.4	20.2	
1		24	20.1	19.8	20.3	20.0	19.9	19.7	
12		6	20.1	20.1	20.0	20.2	20.1	20.0	
25	0	20.1	20.1	20.1	20.1	20.0	20.0		

**OUTPUT POWER FOR 5G NR n30 (10.0 MHz)**

Bandwidth (MHz)	Modulation	RB Allocation	RB Offset	Conducted Average (dBm)					
				ANT 2			ANT 0		
				N/A N/A	462000 2310.0	N/A N/A	N/A N/A	462000 2310.0	N/A N/A
10.0	BPSK	1	0		23.7			22.3	
		1	1		<b>23.7</b>			22.4	
		1	50		23.6			22.3	
		1	51		23.6			22.4	
		25	12		23.6			22.4	
	50	0		<b>23.7</b>			<b>22.5</b>		
	QPSK	1	0		23.2			22.4	
		1	1		<b>23.7</b>			22.5	
		1	50		23.6			22.4	
		1	51		23.2			22.3	
		25	12		23.7			<b>22.5</b>	
	50	0		23.1			22.4		
	16QAM	1	0		22.3			22.4	
		1	1		22.8			22.3	
		1	50		23.0			22.2	
		1	51		22.2			22.3	
		25	12		<b>23.1</b>			22.4	
	50	0		22.2			<b>22.4</b>		
	64QAM	1	0		<b>22.4</b>			<b>22.4</b>	
		1	1		22.3			22.1	
		1	50		22.3			21.9	
		1	51		22.1			21.5	
		25	12		22.0			22.0	
	50	0		22.0			22.1		
	256QAM	1	0		20.0			<b>20.3</b>	
1		1		<b>20.2</b>			20.0		
1		50		20.0			19.9		
1		51		19.5			<b>20.3</b>		
25		12		20.1			20.1		
50	0		20.1			20.1			

### 8.11. LTE BAND 41 AND 5G NR n41

#### LTE BAND 41

<b>Test Engineer ID:</b>	28686RL and 28529JB	<b>Test Date:</b>	2024-01-19 to 2024-01-23
--------------------------	---------------------	-------------------	--------------------------

#### OUTPUT POWER FOR LTE BAND 41 (5.0 MHz)

Bandwidth (MHz)	Modulation	RB Allocation	RB Offset	Conducted Average (dBm)					
				ANT 2			ANT 0		
				39675	40620	41565	39675	40620	41565
5.0	QPSK	1	0	23.3	23.3	23.3	<b>24.0</b>	23.9	23.5
		1	12	23.1	23.1	23.1	23.9	23.7	23.5
		1	24	23.2	23.3	23.2	23.9	23.8	23.5
		12	0	23.3	23.2	23.2	22.8	22.9	22.4
		12	6	23.3	23.2	23.2	22.8	22.9	22.4
		12	11	23.3	23.2	23.2	22.8	22.9	22.4
		25	0	<b>23.3</b>	23.2	23.2	22.9	22.9	22.4
	16QAM	1	0	23.1	23.2	23.3	<b>22.9</b>	22.8	22.5
		1	12	23.0	23.2	23.1	22.8	22.7	22.5
		1	24	23.1	<b>23.3</b>	23.3	22.9	22.9	22.4
		12	0	22.5	22.5	22.4	22.1	22.1	21.6
		12	6	22.5	22.5	22.4	22.1	22.1	21.6
		12	11	22.5	22.5	22.3	22.1	22.1	21.6
		25	0	22.5	22.5	22.4	22.1	22.1	21.6
	64QAM	1	0	22.4	<b>22.5</b>	22.5	22.1	<b>22.2</b>	21.6
		1	12	22.3	22.4	22.4	22.0	22.0	21.6
		1	24	22.3	22.4	22.4	22.1	22.1	21.5
		12	0	21.3	21.3	21.3	21.1	21.0	20.5
		12	6	21.3	21.3	21.3	21.1	21.0	20.5
		12	11	21.3	21.3	21.3	21.1	21.0	20.5
		25	0	21.4	21.4	21.2	21.1	21.1	20.5
	256QAM	1	0	<b>19.4</b>	19.4	19.4	<b>19.2</b>	19.0	18.6
		1	12	19.3	19.2	19.3	19.1	18.9	18.4
		1	24	19.4	19.4	19.3	<b>19.2</b>	18.9	18.5
		12	0	19.3	19.3	19.2	19.0	19.0	18.5
12		6	19.3	19.3	19.2	19.1	19.0	18.5	
12		11	19.3	19.3	19.2	19.0	19.0	18.5	
25		0	19.3	19.2	19.2	19.0	19.0	18.4	

#### OUTPUT POWER FOR LTE BAND 41 (10.0 MHz)

Bandwidth (MHz)	Modulation	RB Allocation	RB Offset	Conducted Average (dBm)					
				ANT 2			ANT 0		
				39700	40620	41540	39700	40620	41540
10.0	QPSK	1	0	23.3	23.2	23.2	<b>24.0</b>	23.9	23.6
		1	24	<b>23.4</b>	23.1	23.1	<b>24.0</b>	23.7	23.4
		1	49	23.3	23.2	23.1	24.0	23.8	23.4
		25	0	23.3	23.2	23.2	23.0	23.0	22.5
		25	12	23.3	23.2	23.2	23.0	22.9	22.5
		25	24	23.3	23.2	23.2	22.9	22.9	22.4
		50	0	23.3	23.2	23.2	23.0	22.9	22.4
	16QAM	1	0	23.3	23.4	23.3	23.1	23.0	22.5
		1	24	23.3	23.3	23.3	<b>23.3</b>	23.2	22.7
		1	49	23.4	<b>23.4</b>	23.3	23.1	23.0	22.4
		25	0	22.5	22.5	22.4	22.2	22.2	21.7
		25	12	22.5	22.5	22.4	22.2	22.1	21.7
		25	24	22.5	22.5	22.4	22.2	22.1	21.6
		50	0	22.5	22.5	22.4	22.2	22.2	21.6
	64QAM	1	0	<b>22.5</b>	22.3	22.3	22.3	22.0	21.6
		1	24	22.4	22.3	22.2	<b>22.3</b>	21.8	21.4
		1	49	22.5	22.4	22.3	22.2	22.1	21.5
		25	0	21.4	21.3	21.2	21.2	21.0	20.6
		25	12	21.4	21.3	21.2	21.2	21.0	20.5
		25	24	21.4	21.3	21.2	21.1	21.0	20.5
		50	0	21.4	21.3	21.3	21.1	21.0	20.5
	256QAM	1	0	19.3	19.3	19.2	18.8	19.0	18.5
		1	24	19.2	19.2	19.2	18.6	<b>19.2</b>	18.6
		1	49	19.3	19.3	19.2	18.8	18.9	18.4
		25	0	<b>19.4</b>	19.3	19.3	19.1	19.0	18.5
25		12	19.4	19.3	19.2	19.1	19.0	18.5	
25		24	19.3	19.3	19.2	19.1	19.0	18.4	
50		0	19.3	19.3	19.2	19.0	19.0	18.4	

**OUTPUT POWER FOR LTE BAND 41 (15.0 MHz)**

Bandwidth (MHz)	Modulation	RB Allocation	RB Offset	Conducted Average (dBm)					
				ANT 2			ANT 0		
				39725	40620	41515	39725	40620	41515
				2503.5	2593.0	2682.5	2503.5	2593.0	2682.5
15.0	QPSK	1	0	23.3	23.3	23.2	<b>24.0</b>	23.8	23.6
		1	37	23.2	23.1	23.2	23.9	23.8	23.5
		1	74	23.3	23.3	23.2	23.9	23.8	23.5
		36	0	<b>23.3</b>	23.3	23.2	23.0	23.0	22.5
		36	16	23.3	23.3	23.2	23.0	23.0	22.5
		36	35	23.3	23.3	23.2	23.0	22.9	22.4
		75	0	23.3	23.3	23.2	23.0	22.9	22.5
	16QAM	1	0	23.2	22.6	23.1	<b>23.1</b>	22.8	22.6
		1	37	23.0	23.1	<b>23.3</b>	22.7	22.7	22.4
		1	74	23.2	23.0	22.4	23.0	22.8	22.4
		36	0	22.6	22.5	22.4	22.2	22.2	21.7
		36	16	22.5	22.4	22.4	22.2	22.2	21.6
		36	35	22.6	22.4	22.4	22.2	22.1	21.6
		75	0	22.5	22.4	22.4	22.2	22.1	21.7
	64QAM	1	0	<b>22.5</b>	22.4	21.7	<b>22.5</b>	22.0	21.9
		1	37	21.9	22.3	22.0	<b>22.5</b>	21.9	21.6
		1	74	22.1	22.3	22.5	22.3	22.1	21.7
		36	0	21.4	21.4	21.4	21.1	21.1	20.6
		36	16	21.4	21.4	21.4	21.1	21.0	20.6
		36	35	21.4	21.4	21.4	21.1	21.0	20.5
		75	0	21.4	21.4	21.3	21.2	21.1	20.6
	256QAM	1	0	<b>19.5</b>	19.3	19.5	19.0	19.1	18.6
		1	37	19.5	19.1	19.2	18.8	18.7	18.3
		1	74	19.3	18.9	19.4	19.0	18.8	18.7
36		0	19.4	19.3	19.3	<b>19.1</b>	19.0	18.6	
36		16	19.4	19.3	19.3	19.0	19.0	18.5	
36		35	19.4	19.3	19.3	19.0	19.0	18.5	
75		0	19.4	19.3	19.3	19.1	19.0	18.5	

**OUTPUT POWER FOR LTE BAND 41 (20.0 MHz)**

Bandwidth (MHz)	Modulation	RB Allocation	RB Offset	Conducted Average (dBm)					
				ANT 2			ANT 0		
				39750	40620	41490	39750	40620	41490
				2506.0	2593.0	2680.0	2506.0	2593.0	2680.0
20.0	QPSK	1	0	<b>23.3</b>	23.2	23.2	<b>24.0</b>	23.8	23.6
		1	49	23.2	23.2	23.2	24.0	23.8	23.5
		1	99	23.3	23.2	23.1	24.0	23.7	23.4
		50	0	<b>23.3</b>	23.2	23.2	23.0	23.0	22.6
		50	24	23.3	23.2	23.2	23.0	22.9	22.5
		50	49	23.3	23.2	23.2	23.0	22.9	22.5
		100	0	23.3	23.2	23.2	23.0	23.0	22.5
	16QAM	1	0	23.4	22.4	23.2	23.0	22.6	22.5
		1	49	23.0	<b>23.5</b>	23.3	23.2	23.0	22.7
		1	99	23.3	22.8	23.1	<b>23.3</b>	22.6	22.3
		50	0	22.5	22.4	22.4	22.3	22.1	21.7
		50	24	22.5	22.4	22.4	22.3	22.1	21.7
		50	49	22.5	22.4	22.4	22.3	22.1	21.6
		100	0	22.5	22.4	22.4	22.2	22.1	21.7
	64QAM	1	0	22.3	22.4	22.3	22.0	21.9	22.0
		1	49	22.2	22.0	22.2	<b>22.4</b>	21.6	22.0
		1	99	<b>22.6</b>	22.4	22.1	21.9	22.1	21.4
		50	0	21.5	21.4	21.3	21.2	21.1	20.7
		50	24	21.5	21.3	21.3	21.2	21.0	20.6
		50	49	21.4	21.3	21.3	21.2	21.0	20.6
		100	0	21.5	21.3	21.3	21.2	21.0	20.6
	256QAM	1	0	<b>19.8</b>	19.7	19.2	<b>19.4</b>	19.1	18.9
		1	49	19.4	19.3	19.2	19.1	18.7	18.7
		1	99	19.4	19.2	19.2	19.4	18.7	18.6
50		0	19.4	19.3	19.3	19.1	19.1	18.6	
50		24	19.4	19.3	19.2	19.1	19.0	18.5	
50		49	19.3	19.3	19.2	19.1	19.0	18.5	
100		0	19.4	19.3	19.3	19.1	19.0	18.5	

**5G NR n41**

<b>Test Engineer ID:</b>	19210AL and 27966PV	<b>Test Date:</b>	2024-02-23 to 2024-05-01
--------------------------	---------------------	-------------------	--------------------------

**OUTPUT POWER FOR 5G NR n41 (10.0 MHz)**

Bandwidth (MHz)	Modulation	RB Allocation	RB Offset	Conducted Average (dBm)												
				ANT 2			ANT 0			ANT 1			ANT 5			
				500200 2501.0	518600 2593.0	537000 2685.0	500200 2501.0	518600 2593.0	537000 2685.0	500200 2501.0	518600 2593.0	537000 2685.0	500200 2501.0	518600 2593.0	537000 2685.0	
10.0	BPSK	1	0	24.1	23.9	24.1	23.9	23.9	23.3	22.8	22.5	22.4	24.1	24.1	24.0	
		1	1	24.7	24.5	24.5	24.5	24.3	23.9	24.5	24.2	24.1	24.2	24.2	24.0	
		1	22	24.7	24.4	24.5	24.5	24.3	23.7	24.3	24.2	24.2	24.2	24.1	24.2	24.1
		1	23	24.2	23.9	24.1	23.9	23.9	23.1	22.6	22.6	22.3	24.0	24.0	24.0	24.0
		12	6	24.6	24.5	24.5	24.3	24.3	23.7	24.4	24.2	24.1	24.0	24.2	24.2	24.0
		24	0	24.1	24.0	24.0	23.9	23.7	23.3	23.7	23.7	23.7	24.0	24.2	24.0	24.0
	QPSK	1	0	23.7	23.5	23.6	23.5	23.4	22.8	22.7	22.5	22.5	23.7	23.6	23.5	
		1	1	24.6	24.5	24.6	24.4	24.4	24.0	24.4	24.1	24.2	24.2	24.2	24.1	
		1	22	24.6	24.4	24.5	24.4	24.3	23.7	24.2	24.1	24.2	24.2	24.2	24.0	
		1	23	23.6	23.4	23.5	23.3	23.2	22.7	22.5	22.5	22.5	23.5	23.6	23.4	
		12	6	24.6	24.5	24.5	24.4	24.3	23.8	24.2	24.3	24.0	24.1	24.1	24.0	
		24	0	23.6	23.5	23.6	23.3	23.3	22.7	23.8	23.1	23.0	23.4	23.6	23.3	
	16QAM	1	0	22.3	22.5	22.7	22.5	22.3	21.6	22.1	22.5	22.1	22.6	22.2	22.5	
		1	1	23.6	23.5	23.7	23.5	22.9	22.6	23.4	23.2	22.9	23.9	23.7	23.3	
		1	22	23.6	23.5	23.5	23.5	23.1	22.4	23.1	23.2	23.3	23.6	23.5	23.3	
		1	23	22.6	22.3	22.4	22.4	22.5	21.3	22.3	22.5	22.4	22.4	22.7	22.3	
		12	6	23.6	23.4	23.5	23.3	23.3	22.7	23.4	23.3	23.0	23.5	23.5	23.4	
		24	0	22.6	22.4	22.5	22.3	22.3	21.7	22.2	22.3	22.1	22.4	22.5	22.4	
	64QAM	1	0	22.1	21.9	21.9	22.1	21.7	21.3	22.8	22.8	22.3	21.8	21.8	22.1	
		1	1	22.1	21.7	22.0	22.0	21.8	21.2	22.2	21.9	21.7	21.6	21.7	22.3	
		1	22	22.0	22.0	22.0	22.1	21.7	21.2	22.0	22.2	21.7	21.5	22.0	22.0	
		1	23	21.9	22.3	22.1	22.0	21.6	21.1	22.7	22.8	22.3	21.6	21.9	22.2	
		12	6	22.0	21.9	21.9	21.9	21.8	21.2	22.0	22.0	21.8	21.9	22.0	21.9	
		24	0	22.0	21.9	22.0	22.0	21.8	21.1	22.1	22.0	21.7	21.9	22.0	21.9	
256QAM	1	0	20.0	19.9	20.1	19.9	19.7	19.4	20.0	20.6	19.7	19.8	19.7	19.9		
	1	1	20.0	19.8	19.9	20.1	19.7	19.4	20.2	20.0	19.9	19.9	19.9	20.0		
	1	22	20.0	19.9	20.0	20.2	19.7	19.0	20.0	19.9	19.8	20.0	20.5	19.8		
	1	23	19.9	19.9	20.0	20.1	19.6	19.0	20.0	20.1	19.9	19.9	20.1	19.9		
	12	6	20.0	19.9	19.9	19.9	19.8	19.2	20.0	20.0	19.9	19.9	20.1	19.9		
	24	0	20.0	20.0	19.9	19.8	19.8	19.2	20.0	20.0	19.8	20.0	20.1	19.9		

**OUTPUT POWER FOR 5G NR n41 (15.0 MHz)**

Bandwidth (MHz)	Modulation	RB Allocation	RB Offset	Conducted Average (dBm)											
				ANT 2			ANT 0			ANT 1			ANT 5		
				500700 2503.5	518600 2593.0	536500 2682.5	500700 2503.5	518600 2593.0	536500 2682.5	500700 2503.5	518600 2593.0	536500 2682.5	500700 2503.5	518600 2593.0	536500 2682.5
15.0	BPSK	1	0	24.1	24.0	24.1	23.9	23.9	23.4	22.6	22.7	22.4	24.0	24.0	24.1
		1	1	24.7	24.6	24.6	24.4	24.3	24.0	24.5	24.3	24.2	24.2	24.2	24.2
		1	36	24.6	24.4	24.5	24.5	24.2	23.7	24.4	24.4	24.2	24.0	24.1	24.0
		1	37	24.1	23.9	24.0	23.9	23.7	23.1	22.6	22.6	22.3	23.9	24.1	23.9
		18	9	24.6	24.5	24.5	24.4	24.4	23.8	24.4	24.3	24.2	24.0	24.1	24.0
		36	0	24.1	24.0	24.1	23.8	23.8	23.3	23.9	23.8	23.6	23.9	24.0	24.0
	QPSK	1	0	23.6	23.6	23.6	23.5	23.3	22.9	22.6	22.6	22.2	23.6	23.5	23.5
		1	1	24.7	24.5	24.6	24.3	24.4	23.8	24.6	24.2	24.2	24.1	24.2	24.2
		1	36	24.7	24.4	24.6	24.4	24.2	23.7	24.4	24.3	24.1	24.0	24.2	24.0
		1	37	23.7	23.4	23.6	23.3	23.2	22.6	22.5	22.6	22.2	23.4	23.5	23.4
		18	9	24.6	24.5	24.5	24.3	24.3	23.9	24.4	24.3	24.2	24.0	24.2	24.0
		36	0	23.6	23.4	23.6	23.4	23.3	22.8	23.3	23.4	23.2	23.4	23.5	23.5
	16QAM	1	0	22.5	22.6	22.6	22.3	22.2	21.9	22.5	22.6	22.4	22.6	22.5	22.6
		1	1	23.6	23.5	23.5	23.6	23.3	22.9	23.7	23.5	23.3	23.8	23.4	23.5
		1	36	23.5	23.4	23.6	23.4	23.4	22.3	23.1	23.5	23.3	23.5	23.5	23.5
		1	37	22.8	22.4	22.7	22.5	22.2	21.7	22.3	22.7	22.4	22.2	22.5	22.6
		18	9	23.4	23.4	23.6	23.4	23.2	22.8	23.4	23.3	23.1	23.5	23.6	23.5
		36	0	22.5	22.5	22.5	22.3	22.2	21.8	22.3	22.2	22.1	22.3	22.4	22.4
	64QAM	1	0	22.1	21.6	22.1	22.0	21.8	21.7	22.3	22.1	22.3	22.1	21.9	22.3
		1	1	22.2	22.0	22.4	21.9	21.8	21.4	22.1	22.2	22.1	22.1	21.9	22.1
		1	36	22.2	21.9	22.1	22.0	21.7	21.1	22.4	22.1	21.8	21.8	22.0	22.2
		1	37	22.1	22.0	22.3	21.9	21.7	21.4	21.1	21.2	20.9	22.0	22.0	22.3
		18	9	22.0	22.0	22.0	21.9	21.9	21.5	22.3	22.2	22.1	21.9	22.0	21.8
		36	0	22.0	21.9	22.1	21.8	21.8	21.3	22.2	22.2	22.1	21.8	22.1	21.9
256QAM	1	0	20.0	22.0	20.3	20.1	19.6	19.6	20.5	20.1	20.5	20.1	20.2	19.8	
	1	1	20.1	19.9	20.0	20.1	20.0	19.6	20.5	20.2	20.0	19.9	19.7	20.2	
	1	36	20.1	19.5	19.8	20.0	19.9	19.1	19.9	20.0	19.9	20.0	20.3	20.0	
	1	37	20.3	20.2	20.2	20.1	20.1	19.4	20.4	20.2	19.9	19.8	20.2	20.0	
	18	9	19.9	20.0	20.1	19.8	19.8	19.3	20.2	20.3	20.1	19.9	20.1	19.8	
	36	0	20.0	19.9	20.0	19.8	19.7	19.3	20.2	20.2	20.0	20.0	20.1	20.0	



**OUTPUT POWER FOR 5G NR n41 (20.0 MHz)**

Bandwidth (MHz)	Modulation	RB Allocation	RB Offset	Conducted Average (dBm)											
				ANT 2			ANT 0			ANT 1			ANT 5		
				501200 2506.0	518600 2593.0	536000 2680.0	501200 2506.0	518600 2593.0	536000 2680.0	501200 2506.0	518600 2593.0	536000 2680.0	501200 2506.0	518600 2593.0	536000 2680.0
20.0	BPSK	1	0	24.1	24.1	24.1	23.9	23.9	23.5	23.6	23.4	23.3	24.0	24.1	24.0
		1	1	24.7	24.5	24.7	24.4	24.3	24.0	24.2	23.8	23.9	24.1	24.2	24.1
		1	49	24.9	24.5	24.5	24.3	24.2	23.7	24.1	23.7	23.8	24.1	24.1	24.0
		1	50	24.2	23.9	24.0	23.8	23.8	23.1	23.7	23.3	23.1	24.0	24.0	23.9
		25	12	24.6	24.5	24.6	24.3	24.3	23.9	24.0	23.9	23.8	24.0	24.2	24.1
	QPSK	50	0	24.2	24.0	24.1	23.8	23.8	23.4	23.6	23.4	23.2	24.0	24.1	24.0
		1	0	23.7	23.5	23.8	23.4	23.3	23.1	23.1	22.8	22.9	23.6	23.5	23.5
		1	1	24.6	24.4	24.8	24.4	24.3	23.9	24.2	23.9	23.8	24.1	24.0	24.2
		1	49	24.6	24.5	24.7	24.3	24.2	23.8	24.2	23.7	23.8	24.0	24.1	24.0
		1	50	23.6	23.5	23.6	23.3	23.2	22.8	23.1	22.8	22.7	23.4	23.5	23.4
	16QAM	25	12	24.7	24.5	24.7	24.4	24.3	23.9	24.0	23.9	23.7	24.1	24.1	24.1
		50	0	23.7	23.6	23.6	23.4	23.3	22.9	23.0	22.7	22.7	23.4	23.5	23.5
		1	0	22.5	22.2	22.6	22.4	22.4	22.1	21.9	22.0	21.6	22.7	22.6	22.2
		1	1	23.7	23.5	23.7	23.3	23.3	23.2	23.1	22.7	22.7	23.5	23.5	23.5
		1	49	23.8	23.6	23.7	23.2	23.1	22.8	22.9	23.0	22.7	23.4	23.6	23.2
	64QAM	1	50	22.8	22.4	22.5	22.1	22.3	21.8	22.1	22.0	21.6	22.5	22.7	22.5
		25	12	23.6	23.5	23.6	23.3	23.3	22.8	23.1	22.9	22.8	23.4	23.6	23.5
		50	0	22.7	22.4	22.6	22.3	22.3	21.8	22.0	21.8	21.6	22.3	22.5	22.4
		1	0	22.3	21.8	22.1	22.0	21.9	21.9	21.7	21.4	21.1	22.0	22.0	22.2
		1	1	22.3	22.1	22.0	21.9	22.0	21.8	21.7	21.3	21.0	22.1	22.1	22.2
	256QAM	1	49	22.3	22.0	21.9	21.6	21.9	21.5	21.4	21.1	21.0	21.7	21.9	22.1
		1	50	21.9	22.1	22.0	21.5	21.8	21.7	21.4	21.0	21.3	21.7	22.0	22.1
		25	12	22.1	22.0	22.1	21.7	21.8	21.4	21.4	21.3	21.2	21.8	21.9	22.0
		50	0	22.1	22.0	22.1	21.9	21.8	21.4	21.5	21.3	21.2	21.9	21.9	22.0
		1	0	20.2	20.3	20.2	19.9	20.1	19.4	19.6	18.9	19.5	19.9	19.8	20.1

**OUTPUT POWER FOR 5G NR n41 (25.0 MHz)**

Bandwidth (MHz)	Modulation	RB Allocation	RB Offset	Conducted Average (dBm)											
				ANT 2			ANT 0			ANT 1			ANT 5		
				501702 2508.5	518600 2593.0	535500 2677.5	501702 2508.5	518600 2593.0	535500 2677.5	501702 2508.5	518600 2593.0	535500 2677.5	501702 2508.5	518600 2593.0	535500 2677.5
25.0	BPSK	1	0	24.2	24.1	24.2	23.8	23.8	23.5	23.6	23.3	23.4	24.2	24.1	24.1
		1	1	24.8	24.5	24.7	24.4	24.3	24.0	24.2	23.9	23.9	24.3	24.2	24.1
		1	63	24.7	24.4	24.4	24.3	24.1	23.6	24.0	23.7	23.7	24.0	24.3	24.0
		1	64	24.3	24.0	24.0	23.7	23.7	23.1	23.6	23.2	23.2	24.0	24.1	24.1
		32	16	24.7	24.5	24.6	24.4	24.3	23.9	24.1	23.9	23.9	24.2	24.4	24.3
	QPSK	64	0	24.2	24.0	24.2	23.8	23.7	23.3	23.6	23.3	23.2	24.1	24.0	24.2
		1	0	23.7	23.5	23.7	23.2	23.3	23.1	23.2	22.8	22.8	23.7	23.6	23.5
		1	1	24.7	24.5	24.6	24.4	24.3	24.1	24.1	23.8	23.8	24.2	24.1	24.2
		1	63	24.8	24.5	24.5	24.3	24.2	23.6	24.0	23.7	23.6	23.9	24.1	24.1
		1	64	23.8	23.5	23.5	23.1	23.1	22.7	23.0	22.8	22.6	23.4	23.5	23.4
	16QAM	32	16	24.8	24.5	24.7	24.4	24.3	23.9	24.1	23.9	23.8	24.2	24.2	24.3
		64	0	23.7	23.5	23.6	23.3	23.2	22.9	23.1	22.8	22.8	23.5	23.6	23.7
		1	0	22.4	22.3	22.7	22.2	22.1	22.0	22.0	22.2	21.9	22.6	22.7	22.7
		1	1	23.5	23.7	23.6	23.6	23.1	23.1	23.0	22.7	22.8	23.7	23.9	23.9
		1	63	23.6	23.7	23.6	23.4	23.0	22.6	22.8	23.0	22.6	23.6	23.6	23.6
	64QAM	1	64	22.7	22.5	22.3	22.2	22.0	21.7	22.1	21.9	21.6	22.4	22.6	22.9
		32	16	23.7	23.5	23.6	23.4	23.3	22.8	23.1	22.8	22.7	23.4	23.7	23.4
		64	0	22.6	22.5	22.7	22.3	22.2	21.9	22.0	21.8	21.8	22.5	22.5	22.6
		1	0	21.7	21.8	22.0	21.5	21.8	21.2	21.5	21.3	21.6	22.3	22.1	21.9
		1	1	21.7	22.0	22.1	21.6	21.8	21.2	21.5	21.3	21.2	22.2	21.9	22.4
	256QAM	1	63	21.8	21.9	21.9	21.5	21.7	21.1	21.5	21.0	21.2	21.9	22.2	22.4
		1	64	22.1	22.0	21.8	21.4	21.8	21.1	21.1	21.3	21.1	22.0	22.2	22.4
		32	16	22.1	22.1	22.0	21.8	21.6	21.4	21.5	21.3	21.3	22.0	22.2	22.0
		64	0	22.1	22.0	22.0	21.7	21.7	21.3	21.6	21.3	21.3	21.9	22.1	22.1
		1	0	20.3	20.2	20.1	19.7	19.7	19.5	20.0	19.3	19.4	20.3	19.9	20.4

**OUTPUT POWER FOR 5G NR n41 (30.0 MHz)**

Bandwidth (MHz)	Modulation	RB Allocation	RB Offset	Conducted Average (dBm)											
				ANT 2			ANT 0			ANT 1			ANT 5		
				502200	518600	525000	502200	518600	525000	502200	518600	525000	502200	518600	525000
30.0	BPSK	1	0	24.3	24.1	24.2	23.9	23.9	23.5	23.7	23.3	23.4	24.1	24.1	24.0
		1	1	<b>24.8</b>	24.5	24.8	24.4	24.4	24.0	<b>24.2</b>	23.9	23.9	24.2	24.1	24.1
		1	76	24.8	24.4	24.5	24.3	24.1	23.7	24.1	23.8	23.7	23.9	24.2	24.0
		1	77	24.3	24.0	24.0	23.8	23.8	23.2	23.6	23.3	23.2	23.9	24.0	24.0
		36	18	24.7	24.5	24.7	<b>24.4</b>	24.3	24.0	24.1	23.9	23.9	24.1	<b>24.3</b>	24.2
		75	0	24.2	24.0	24.2	23.9	23.8	23.4	23.6	23.3	23.2	24.0	24.0	24.1
	QPSK	1	0	23.7	23.5	23.7	23.3	23.4	23.1	23.2	22.8	22.9	23.6	23.5	23.4
		1	1	24.7	24.5	24.7	<b>24.5</b>	24.4	24.1	<b>24.1</b>	23.9	23.8	24.2	24.1	24.2
		1	76	<b>24.9</b>	24.5	24.5	24.3	24.2	23.7	24.1	23.7	23.6	23.9	24.1	24.0
		1	77	23.8	23.5	23.5	23.2	23.2	22.7	23.0	22.8	22.7	23.3	23.4	23.4
		36	18	24.8	24.5	24.7	24.4	24.3	24.0	24.1	23.9	23.9	24.1	<b>24.2</b>	<b>24.2</b>
		75	0	23.7	23.5	23.6	23.4	23.3	23.0	23.1	22.9	22.8	23.5	23.5	23.6
	16QAM	1	0	22.4	22.4	22.7	22.3	22.2	22.0	22.1	22.2	22.0	22.5	22.6	22.7
		1	1	23.6	<b>23.8</b>	23.6	<b>23.6</b>	23.1	23.2	23.0	22.8	22.9	23.6	<b>23.8</b>	<b>23.9</b>
		1	76	23.7	23.7	23.6	23.5	23.1	22.7	22.8	23.0	22.7	23.5	23.5	23.5
		1	77	22.7	22.5	22.3	22.3	22.0	21.8	22.1	21.9	21.7	22.3	22.5	22.8
		36	18	23.7	23.5	23.6	23.5	23.3	22.9	<b>23.1</b>	22.9	22.7	23.3	23.6	23.4
		75	0	22.7	22.6	22.7	22.4	22.3	22.0	22.1	21.8	21.8	22.4	22.5	22.6
	64QAM	1	0	21.7	21.8	22.1	21.6	<b>21.9</b>	21.2	21.6	21.3	<b>21.6</b>	22.2	22.0	21.8
		1	1	21.8	22.1	22.1	21.7	21.8	21.2	21.6	21.3	21.2	22.1	21.8	<b>22.4</b>
		1	76	21.9	21.9	21.9	21.6	21.7	21.2	21.5	21.0	21.3	21.8	22.2	22.3
		1	77	22.1	22.1	21.8	21.5	21.8	21.2	21.2	21.4	21.1	21.9	22.2	22.3
		36	18	22.1	22.1	22.0	<b>21.9</b>	21.7	21.4	21.5	21.4	21.3	21.9	22.1	21.9
		75	0	<b>22.2</b>	22.0	22.1	21.8	21.8	21.4	21.6	21.3	21.3	21.9	22.1	22.0
	256QAM	1	0	<b>20.4</b>	20.2	20.1	19.8	19.8	19.6	<b>20.0</b>	19.3	19.5	20.3	19.8	<b>20.4</b>
		1	1	20.1	20.0	20.2	19.8	19.8	19.7	19.6	19.3	19.2	20.1	20.0	19.8
		1	76	20.2	19.6	20.0	<b>20.0</b>	19.5	19.2	19.4	19.2	19.0	20.1	19.9	19.8
		1	77	20.1	19.8	20.3	20.0	19.4	19.4	19.9	19.3	18.9	20.0	20.3	19.7
		36	18	20.1	20.0	20.1	19.9	19.8	19.4	19.6	19.3	19.3	20.0	20.1	20.0
		75	0	20.1	20.0	20.1	19.9	19.8	19.4	19.6	19.3	19.3	19.9	20.0	19.9

**OUTPUT POWER FOR 5G NR n41 (40.0 MHz)**

Bandwidth (MHz)	Modulation	RB Allocation	RB Offset	Conducted Average (dBm)											
				ANT 2			ANT 0			ANT 1			ANT 5		
				503200	518600	534000	503200	518600	534000	503200	518600	534000	503200	518600	534000
40.0	BPSK	1	0	24.2	24.1	24.3	24.0	23.9	23.6	23.7	23.4	23.5	24.1	24.0	24.1
		1	1	24.7	24.6	24.7	<b>24.4</b>	24.3	24.2	24.1	24.0	23.8	<b>24.3</b>	24.2	24.2
		1	104	<b>24.9</b>	24.5	24.4	24.4	24.1	23.7	<b>24.2</b>	23.9	23.7	24.1	24.1	24.0
		1	105	24.3	24.0	24.0	23.9	23.7	23.2	23.7	23.2	23.2	23.9	24.0	24.1
		50	25	24.7	24.6	24.7	<b>24.4</b>	24.3	24.0	24.1	23.9	23.8	23.9	24.1	24.1
		100	0	24.3	24.1	24.1	23.8	23.8	23.5	23.6	23.4	23.3	23.9	24.1	24.0
	QPSK	1	0	23.7	23.7	23.8	23.4	23.3	23.1	23.2	23.1	22.9	23.6	23.6	23.5
		1	1	24.8	24.6	24.7	24.4	24.4	24.1	<b>24.2</b>	24.1	23.9	<b>24.2</b>	24.0	24.2
		1	104	<b>25.0</b>	24.6	24.6	24.3	24.3	23.7	24.1	23.8	23.7	24.0	24.1	24.2
		1	105	23.9	23.6	23.6	23.3	23.1	22.7	23.2	22.8	22.6	23.3	23.5	23.5
		50	25	24.7	24.5	24.7	<b>24.4</b>	24.4	24.0	24.1	23.9	23.9	23.9	24.1	24.2
		100	0	23.8	23.6	23.7	23.3	23.4	23.0	23.2	22.8	22.8	23.4	23.6	23.4
	16QAM	1	0	22.6	22.7	23.2	22.6	22.2	22.1	21.9	22.5	22.0	22.1	22.4	22.4
		1	1	23.9	23.6	23.6	23.5	23.4	23.4	22.9	<b>23.3</b>	22.8	23.3	23.8	23.3
		1	104	<b>24.0</b>	23.4	23.6	<b>23.6</b>	23.4	22.5	22.8	22.9	22.4	23.1	<b>23.8</b>	23.7
		1	105	22.9	22.6	22.5	22.2	22.0	21.5	22.0	21.7	21.7	22.3	22.4	22.5
		50	25	23.8	23.5	23.7	23.3	23.3	23.0	23.1	23.0	22.8	23.3	23.6	23.6
		100	0	22.7	22.5	22.7	22.4	22.2	21.9	22.0	22.0	21.9	22.3	22.5	22.6
	64QAM	1	0	22.3	22.2	<b>22.4</b>	21.5	21.5	21.4	21.6	<b>21.7</b>	21.4	21.8	21.9	21.9
		1	1	22.0	22.1	22.4	21.8	21.5	21.4	21.6	21.5	21.7	21.8	21.9	22.0
		1	104	22.4	22.3	22.1	21.6	21.4	21.1	21.5	20.8	21.3	22.0	21.9	22.0
		1	105	22.4	22.2	22.2	21.8	21.4	21.1	21.5	21.0	21.2	21.6	<b>22.2</b>	21.8
		50	25	22.2	22.0	22.1	21.8	21.8	21.6	21.6	21.3	21.4	21.8	22.0	22.1
		100	0	22.2	22.0	22.1	<b>21.9</b>	21.7	21.4	21.6	21.4	21.2	21.8	22.1	22.0
	256QAM	1	0	20.0	20.2	20.3	20.1	<b>20.4</b>	19.6	19.8	19.3	19.4	19.8	20.0	20.2
		1	1	20.0	19.9	20.2	19.9	19.9	19.8	<b>19.9</b>	19.7	19.4	20.0	20.0	20.2
		1	104	<b>20.2</b>	19.9	20.1	19.7	19.7	19.2	19.8	19.4	19.3	19.7	20.1	<b>20.3</b>
		1	105	<b>20.6</b>	19.8	20.3	19.9	20.2	19.3	19.7	19.5	19.5	19.8	20.0	19.8
		50	25	20.2	20.0	20.1	19.9	19.8	19.4	19.6	19.4	19.3	19.9	20.1	20.0
		100	0	20.2	20.0	20.2	19.9	19.8	19.5	19.6	19.4	19.3	19.9	20.1	20.1

**OUTPUT POWER FOR 5G NR n41 (50.0 MHz)**

Bandwidth (MHz)	Modulation	RB Allocation	RB Offset	Conducted Average (dBm)											
				ANT 2			ANT 0			ANT 1			ANT 5		
				504200	518600	533000	504200	518600	533000	504200	518600	533000	504200	518600	533000
50.0	BPSK	1	0	24.3	24.3	24.3	24.1	24.0	23.7	23.7	23.7	23.3	24.0	24.0	24.0
		1	1	24.7	24.8	24.8	24.5	24.5	24.1	24.3	24.2	23.8	24.2	24.1	24.2
		1	131	24.8	24.7	24.7	24.4	24.2	23.7	24.2	23.8	23.8	24.1	24.4	24.3
		1	132	24.3	24.1	24.1	23.9	23.7	23.2	23.6	23.4	23.2	24.1	24.2	24.0
		64	32	24.8	24.6	24.7	24.3	24.4	24.1	24.1	24.0	23.8	24.0	24.2	24.1
		128	0	24.3	24.1	24.1	23.9	23.9	23.5	23.5	23.3	23.2	23.9	24.0	24.1
	QPSK	1	0	23.8	23.7	23.7	23.4	23.4	23.2	23.2	23.1	22.8	23.5	23.4	23.5
		1	1	24.7	24.8	24.7	24.5	24.5	24.1	24.2	24.1	23.8	24.2	24.2	24.2
		1	131	24.8	24.7	24.5	24.3	24.1	23.8	24.1	23.9	23.8	24.1	24.2	24.1
		1	132	23.9	23.7	23.6	23.3	23.2	22.7	23.1	22.8	22.7	23.4	23.7	23.4
		64	32	24.7	24.5	24.8	24.4	24.3	24.0	24.0	23.9	23.8	23.9	24.2	24.1
		128	0	23.8	23.6	23.7	23.4	23.3	23.0	23.1	22.9	22.7	23.5	23.5	23.4
	16QAM	1	0	23.0	22.7	22.8	22.5	22.4	22.0	22.3	22.1	22.2	22.5	22.4	22.8
		1	1	23.4	23.6	23.9	23.1	23.5	23.2	23.0	22.9	23.1	23.7	23.9	23.6
		1	131	23.7	23.8	23.5	23.3	23.3	22.7	23.2	22.5	22.7	23.4	23.4	23.6
		1	132	23.0	22.4	22.6	22.6	22.2	21.7	22.2	21.6	21.8	22.1	23.0	22.7
		64	32	23.7	23.6	23.7	23.3	23.2	23.0	23.1	22.9	22.7	23.4	23.5	23.4
		128	0	22.8	22.6	22.6	22.3	22.3	22.0	22.1	21.9	21.7	22.3	22.6	22.5
	64QAM	1	0	22.4	22.4	22.0	21.8	21.7	21.5	21.8	21.6	21.6	21.7	22.1	22.1
		1	1	22.3	22.1	22.2	21.7	21.6	21.4	21.7	21.7	21.3	21.8	22.2	21.8
		1	131	22.4	22.1	21.7	21.8	21.4	20.9	21.3	21.6	21.4	21.8	22.4	22.5
		1	132	22.2	22.1	21.9	21.8	21.4	21.1	21.4	21.4	21.1	21.6	22.0	22.1
		64	32	22.3	22.0	22.0	21.8	21.8	21.5	21.4	21.4	21.2	21.8	22.0	22.0
		128	0	22.3	22.1	22.1	21.8	21.7	21.4	21.5	21.4	21.3	21.8	22.1	21.9
	256QAM	1	0	20.3	20.2	20.6	19.7	20.2	19.5	19.5	19.7	19.4	19.9	19.8	19.9
		1	1	19.9	20.2	20.1	19.9	20.2	19.5	19.5	19.4	19.4	19.8	19.8	19.9
		1	131	20.3	20.3	20.1	19.9	19.9	19.3	19.6	19.1	19.2	19.8	19.8	19.8
		1	132	20.1	19.9	19.9	19.8	19.9	19.2	19.6	19.1	19.2	19.8	19.8	19.9
		64	32	20.3	20.1	20.2	19.8	19.8	19.6	19.5	19.3	19.2	19.8	20.1	19.9
		128	0	20.2	20.1	20.1	19.9	19.7	19.4	19.5	19.4	19.2	20.0	20.0	19.9

**OUTPUT POWER FOR 5G NR n41 (60.0 MHz)**

Bandwidth (MHz)	Modulation	RB Allocation	RB Offset	Conducted Average (dBm)											
				ANT 2			ANT 0			ANT 1			ANT 5		
				505200	518600	532000	505200	518600	532000	505200	518600	532000	505200	518600	532000
60.0	BPSK	1	0	24.2	24.2	24.3	24.0	23.9	23.6	23.7	23.6	23.2	24.1	24.0	24.0
		1	1	24.7	24.8	24.7	24.5	24.5	24.1	24.2	24.1	23.8	24.2	24.1	24.1
		1	160	24.9	24.7	24.6	24.4	24.2	23.8	24.2	23.7	23.6	24.2	24.1	24.0
		1	161	24.3	24.1	24.1	23.9	23.6	23.1	23.7	23.2	23.0	24.1	24.0	24.1
		81	40	24.9	24.6	24.6	24.3	24.2	24.1	24.1	23.9	23.8	24.0	24.1	24.2
		162	0	24.2	24.1	24.2	23.8	23.8	23.5	23.6	23.3	23.2	24.0	24.0	24.0
	QPSK	1	0	23.7	23.8	23.7	23.4	23.3	23.2	23.2	23.1	22.9	23.6	23.5	23.6
		1	1	24.8	24.8	24.7	24.4	24.4	24.2	24.2	24.1	23.8	24.1	24.1	24.0
		1	160	24.9	24.7	24.6	24.4	24.1	23.8	24.3	23.8	23.6	24.2	24.1	24.0
		1	161	23.8	23.6	23.6	23.4	23.0	22.8	23.0	22.7	22.7	23.6	23.5	23.5
		81	40	24.9	24.6	24.7	24.4	24.2	24.1	24.0	23.9	23.8	23.9	24.2	24.1
		162	0	23.8	23.5	23.7	23.4	23.3	23.0	23.0	22.8	22.6	23.4	23.5	23.5
	16QAM	1	0	22.6	23.0	22.6	22.6	22.0	22.0	21.9	21.7	21.7	22.6	22.6	22.7
		1	1	23.6	24.0	23.5	23.5	23.4	22.9	23.2	23.3	22.9	23.8	23.6	24.0
		1	160	23.7	23.7	23.6	23.5	22.8	22.8	23.1	23.0	22.8	23.8	23.9	23.3
		1	161	22.8	22.8	22.3	22.4	22.0	21.5	22.2	21.4	21.3	22.6	22.5	22.5
		81	40	23.7	23.6	23.7	23.4	23.3	23.2	23.0	22.8	22.8	23.4	23.5	23.4
		162	0	22.8	22.5	22.6	22.3	22.4	22.0	22.1	21.7	21.8	22.2	22.4	22.4
	64QAM	1	0	22.0	22.2	21.9	21.7	21.8	21.6	21.5	21.5	21.5	22.0	22.2	22.0
		1	1	22.3	22.3	22.0	22.0	22.1	21.5	21.6	21.3	21.2	22.2	21.9	22.1
		1	160	22.3	22.0	21.8	21.9	21.8	21.2	21.4	21.0	21.2	22.2	21.9	21.9
		1	161	22.3	22.1	22.0	21.8	21.3	21.2	21.5	21.3	21.2	22.2	21.9	21.9
		81	40	22.3	22.0	22.3	21.8	21.7	21.5	21.5	21.3	21.3	21.7	22.0	21.9
		162	0	22.2	22.0	22.2	21.8	21.7	21.5	21.6	21.3	21.3	21.8	22.1	21.9
	256QAM	1	0	20.0	20.0	20.0	19.8	20.0	19.6	19.6	19.4	19.6	19.7	20.4	20.1
		1	1	20.0	20.1	20.3	19.7	20.0	19.3	19.6	19.4	19.3	19.9	20.2	19.8
		1	160	20.5	20.1	20.2	19.9	19.7	19.3	19.4	19.7	19.3	20.0	20.2	19.7
		1	161	20.2	20.0	20.2	19.7	19.4	19.0	19.5	18.9	19.0	19.9	20.4	20.1
		81	40	20.2	20.1	20.2	19.8	19.8	19.5	19.6	19.3	19.2	19.8	20.0	20.0
		162	0	20.2	20.1	20.1	19.8	19.7	19.5	19.5	19.3	19.2	19.8	20.1	19.8

**OUTPUT POWER FOR 5G NR n41 (70.0 MHz)**

Bandwidth (MHz)	Modulation	RB Allocation	RB Offset	Conducted Average (dBm)											
				ANT 2			ANT 0			ANT 1			ANT 5		
				506200 2531.0	518600 2593.0	531000 2655.0	506200 2531.0	518600 2593.0	531000 2655.0	506200 2531.0	518600 2593.0	531000 2655.0	506200 2531.0	518600 2593.0	531000 2655.0
70.0	BPSK	1	0	24.3	24.3	24.1	24.1	24.1	23.7	23.7	23.7	23.4	24.1	24.1	24.1
		1	1	24.8	24.9	24.7	24.5	24.5	24.2	24.3	24.1	23.9	24.1	24.2	24.2
		1	187	24.9	24.7	24.6	24.5	24.2	23.7	23.7	23.7	24.2	24.3	24.3	24.2
		1	188	24.4	24.2	24.1	24.0	23.7	23.3	23.7	23.3	23.2	24.1	24.2	24.1
		90	45	24.8	24.6	24.7	24.4	24.3	24.0	24.2	23.8	23.8	24.0	24.3	24.0
		180	0	24.4	24.0	24.2	24.0	23.7	23.5	23.6	23.3	23.3	23.9	24.0	23.9
	QPSK	1	0	23.9	23.9	23.7	23.4	23.5	23.1	23.2	23.1	22.7	23.6	23.5	23.6
		1	1	24.8	24.8	24.7	24.5	24.6	24.2	24.2	24.2	23.8	24.2	24.2	24.2
		1	187	24.8	24.8	24.6	24.4	24.3	23.8	24.1	23.8	23.7	24.3	24.3	24.1
		1	188	23.9	23.7	23.7	23.5	23.3	22.8	23.2	22.8	22.7	23.6	23.6	23.6
		90	45	24.8	24.6	24.7	24.4	24.3	24.1	24.2	23.9	23.8	23.9	24.1	24.2
		180	0	23.8	23.6	23.7	23.4	23.4	23.1	23.1	23.0	22.8	23.2	23.6	23.4
	16QAM	1	0	22.7	22.9	22.8	22.5	22.5	22.4	22.3	22.0	21.7	22.8	22.3	22.8
		1	1	23.4	24.1	23.7	23.8	23.7	23.3	23.2	23.1	22.8	23.6	23.8	23.5
		1	187	23.8	23.8	23.8	23.8	23.5	23.0	23.3	22.7	22.7	23.6	23.7	23.2
		1	188	22.8	22.6	22.8	22.3	22.3	21.9	22.0	21.6	21.6	22.5	22.5	22.4
		90	45	23.8	23.5	23.7	23.4	23.3	23.1	23.2	22.9	22.7	23.3	23.6	23.4
		180	0	22.7	22.6	22.7	22.3	22.2	22.1	22.1	21.9	21.8	22.3	22.6	22.3
	64QAM	1	0	22.0	22.6	22.4	21.9	22.0	21.7	21.6	21.7	21.3	21.8	21.9	22.1
		1	1	21.9	22.3	21.9	22.0	22.0	21.7	21.6	21.5	21.0	21.9	22.2	22.2
		1	187	22.2	22.5	22.0	22.0	21.7	21.4	21.5	21.4	20.8	21.7	22.2	21.8
		1	188	22.0	22.2	21.9	22.0	21.7	21.2	21.5	21.2	20.9	21.5	21.6	22.0
		90	45	22.3	22.0	22.1	21.9	21.8	21.5	21.7	21.4	21.2	21.7	22.0	22.0
		180	0	22.3	22.1	22.2	21.9	21.8	21.5	21.6	21.4	21.3	21.7	22.1	21.9
	256QAM	1	0	20.4	20.5	20.2	19.9	19.8	19.8	20.0	19.8	19.5	20.0	20.1	19.9
		1	1	20.4	20.3	20.3	20.0	19.8	19.8	19.7	19.8	19.3	20.0	20.3	19.9
		1	187	20.4	20.3	20.0	20.0	19.5	19.3	19.9	19.3	19.2	20.1	20.3	20.3
		1	188	20.2	20.2	20.0	20.2	19.6	19.2	19.6	19.0	19.2	19.8	20.3	20.1
		90	45	20.3	19.9	20.2	19.8	19.9	19.5	19.7	19.3	19.2	19.8	20.1	19.9
		180	0	20.2	20.0	20.2	19.9	19.7	19.4	19.7	19.4	19.2	19.8	20.1	20.0

**OUTPUT POWER FOR 5G NR n41 (80.0 MHz)**

Bandwidth (MHz)	Modulation	RB Allocation	RB Offset	Conducted Average (dBm)											
				ANT 2			ANT 0			ANT 1			ANT 5		
				507200 2536.0	518600 2593.0	530000 2650.0	507200 2536.0	518600 2593.0	530000 2650.0	507200 2536.0	518600 2593.0	530000 2650.0	507200 2536.0	518600 2593.0	530000 2650.0
80.0	BPSK	1	0	24.3	24.6	24.1	24.1	24.0	23.7	23.8	23.8	23.4	24.2	24.1	24.2
		1	1	24.9	25.1	24.7	24.6	24.5	24.3	24.4	24.2	24.0	24.3	24.3	24.3
		1	215	24.8	24.8	24.8	24.5	24.2	23.8	24.1	23.8	23.7	24.4	24.3	24.2
		1	216	24.2	24.3	24.1	24.0	23.7	23.3	23.6	23.4	23.1	24.2	24.1	24.0
		108	54	24.7	24.6	24.7	24.4	24.3	24.0	24.2	24.0	23.7	24.1	24.2	24.1
		216	0	24.2	24.2	24.2	24.0	23.7	23.6	23.8	23.5	23.3	24.1	24.2	24.0
	QPSK	1	0	23.8	23.9	23.7	23.6	23.5	23.3	23.2	23.3	23.0	23.8	23.6	23.7
		1	1	24.8	25.0	24.7	24.6	24.4	24.4	24.3	24.3	23.9	24.3	24.3	24.3
		1	215	24.8	24.9	24.7	24.5	24.3	23.9	24.2	23.9	23.8	24.3	24.2	24.2
		1	216	23.8	23.8	23.7	23.5	23.2	22.8	23.1	22.8	22.7	23.7	23.6	23.6
		108	54	24.9	24.6	24.7	24.3	24.3	24.0	24.2	23.9	23.8	24.1	24.2	24.0
		216	0	23.9	23.7	23.8	23.4	23.3	23.1	23.1	22.8	22.8	23.5	23.5	23.5
	16QAM	1	0	22.9	23.0	23.0	22.9	22.4	22.3	22.3	22.1	21.7	22.5	22.6	22.5
		1	1	23.7	24.0	23.9	23.8	23.4	23.5	23.3	23.3	22.7	23.6	23.7	23.7
		1	215	23.7	23.8	23.9	23.8	23.1	23.0	23.2	23.1	22.7	24.0	23.4	23.5
		1	216	22.8	22.9	22.9	22.7	22.1	21.9	22.0	21.6	21.9	22.5	22.6	22.2
		108	54	23.8	23.6	23.7	23.4	23.3	23.1	23.3	22.8	22.8	23.4	23.5	23.4
		216	0	22.8	22.8	22.7	22.4	22.3	22.0	22.1	21.9	21.7	22.5	22.6	22.4
	64QAM	1	0	22.3	22.5	22.1	22.0	22.1	21.6	21.8	21.8	21.6	22.0	22.6	22.1
		1	1	22.0	22.6	22.3	22.1	22.3	21.6	22.2	21.9	21.6	22.0	22.4	22.3
		1	215	22.1	22.6	22.1	22.0	22.0	21.2	21.9	21.4	21.4	21.9	22.3	22.3
		1	216	21.9	22.3	22.4	21.9	21.6	21.2	21.9	21.4	21.3	22.0	22.7	22.0
		108	54	22.3	22.1	22.2	21.8	21.8	21.5	21.7	21.4	21.3	22.0	22.1	21.9
		216	0	22.3	22.2	22.2	21.8	21.7	21.6	21.7	21.4	21.3	21.9	22.0	21.9
	256QAM	1	0	20.2	20.5	20.4	20.1	20.0	20.0	20.1	19.7	19.6	20.5	20.1	20.3
		1	1	20.3	20.5	20.1	19.9	20.0	20.0	19.9	19.5	19.4	20.1	20.1	20.3
		1	215	20.2	20.3	20.3	19.9	19.7	19.2	19.7	19.1	19.5	20.2	20.1	19.9
		1	216	20.1	20.3	20.1	20.1	19.6	19.3	19.6	19.5	19.2	20.0	20.4	20.1
		108	54	20.3	20.1	20.1	19.8	19.8	19.5	19.8	19.3	19.3	20.0	20.1	19.9
		216	0	20.3	20.2	20.2	19.8	19.7	19.5	19.7	19.4	19.2	20.0	20.2	19.9

**OUTPUT POWER FOR 5G NR n41 (90.0 MHz)**

Bandwidth (MHz)	Modulation	RB Allocation	RB Offset	Conducted Average (dBm)											
				ANT 2			ANT 0			ANT 1			ANT 5		
				508200	518600	529000	508200	518600	529000	508200	518600	529000	508200	518600	529000
90.0	BPSK	1	0	24.3	24.5	24.2	24.0	24.0	23.8	23.8	23.8	23.2	24.2	24.3	24.2
		1	1	24.9	25.1	24.8	24.7	24.6	24.4	24.4	24.4	23.8	24.3	24.4	24.3
		1	243	24.8	24.9	24.8	24.5	24.2	23.9	24.0	24.0	23.8	24.3	24.4	24.2
		1	244	24.1	24.3	24.1	24.0	23.7	23.3	23.4	23.3	23.1	24.2	24.2	24.0
		120	60	24.8	24.7	24.7	24.3	24.3	24.0	24.2	23.8	23.7	24.0	24.2	24.0
		243	0	24.3	24.2	24.3	23.9	23.8	23.5	23.7	23.5	23.2	24.0	24.1	24.0
	QPSK	1	0	23.8	24.0	23.6	23.5	23.5	23.2	23.3	23.3	22.9	23.6	23.7	23.6
		1	1	25.0	25.2	24.8	24.5	24.6	24.3	24.4	24.4	23.8	24.3	24.4	24.3
		1	243	24.8	24.8	24.7	24.5	24.3	23.8	24.0	23.9	23.7	24.3	24.3	24.2
		1	244	23.7	23.8	23.6	23.5	23.2	22.7	22.9	22.9	22.6	23.6	23.7	23.5
		120	60	24.8	24.6	24.7	24.3	24.3	24.1	24.3	23.9	23.8	24.0	24.2	24.0
		243	0	23.8	23.6	23.8	23.4	23.3	23.0	23.2	22.9	22.7	23.5	23.6	23.4
	16QAM	1	0	22.6	23.1	22.4	22.6	22.6	22.2	22.3	22.2	22.0	22.5	22.4	22.6
		1	1	23.7	24.1	23.6	23.7	23.7	23.2	23.7	23.6	23.2	23.6	23.8	23.8
		1	243	23.9	23.8	24.1	23.6	23.4	22.7	22.9	23.1	22.8	23.6	23.8	23.7
		1	244	22.8	22.7	22.5	22.6	22.4	21.6	21.7	21.9	21.8	22.7	22.3	22.6
		120	60	23.8	23.5	23.7	23.3	23.4	23.1	23.3	22.9	22.8	23.5	23.6	23.4
		243	0	22.7	22.7	22.6	22.4	22.3	22.1	22.3	21.9	21.8	22.6	22.5	22.4
	64QAM	1	0	22.6	22.6	22.0	21.9	22.1	21.6	21.7	21.3	21.2	22.2	21.8	22.4
		1	1	22.1	22.6	22.1	22.0	22.1	21.9	22.0	21.7	21.2	22.4	21.9	22.4
		1	243	22.0	22.4	22.2	22.1	21.8	21.2	21.6	21.5	21.2	22.5	21.8	22.4
		1	244	22.4	22.5	22.2	21.9	21.6	21.1	21.2	21.2	21.1	22.3	21.7	22.2
		120	60	22.2	22.1	22.2	21.9	21.8	21.6	21.7	21.4	21.2	21.9	22.0	21.9
		243	0	22.3	22.2	22.1	21.9	21.7	21.6	21.7	21.5	21.3	22.0	22.1	21.8
	256QAM	1	0	20.1	20.3	20.4	20.1	20.1	19.9	19.5	19.9	19.3	20.1	20.6	20.1
		1	1	20.6	20.3	20.3	20.3	20.3	20.0	20.0	20.1	19.5	20.2	20.6	20.1
		1	243	20.4	20.0	20.1	20.3	19.9	19.5	19.3	19.5	19.0	20.4	20.6	20.0
		1	244	20.4	20.2	20.2	20.2	19.6	19.5	19.4	19.5	19.4	20.3	20.4	19.6
		120	60	20.3	20.1	20.1	19.8	19.8	19.5	19.7	19.3	19.2	19.9	20.0	19.9
		243	0	20.3	20.2	20.3	19.9	19.9	19.6	19.7	19.4	19.2	20.1	20.2	19.9

**OUTPUT POWER FOR 5G NR n41 (100.0 MHz)**

Bandwidth (MHz)	Modulation	RB Allocation	RB Offset	Conducted Average (dBm)											
				ANT 2			ANT 0			ANT 1			ANT 5		
				509200	528600	528000	509200	528600	528000	509200	528600	528000	509200	528600	528000
100.0	BPSK	1	0	24.2	24.4	24.1	23.9	23.8	24.0	23.6	23.6	23.4	24.2	23.9	24.2
		1	1	24.9	25.1	24.8	24.6	24.6	24.6	24.4	24.3	24.0	24.4	24.2	24.4
		1	271	24.8	24.9	24.7	24.5	24.2	24.0	24.1	24.0	23.7	24.4	24.3	24.3
		1	272	24.1	24.3	24.1	23.9	23.6	23.3	23.4	23.3	23.1	24.1	24.0	24.0
		135	67	24.9	24.5	24.7	24.4	24.3	24.1	24.1	24.0	23.7	24.2	24.2	24.1
		270	0	24.4	24.2	24.2	23.9	23.8	23.7	23.6	23.4	23.3	24.2	24.2	24.0
	QPSK	1	0	23.8	23.8	23.6	23.4	23.4	23.4	23.2	23.1	22.9	23.6	23.4	23.6
		1	1	25.0	25.0	24.8	24.6	24.5	24.6	24.4	24.4	24.0	24.3	24.3	24.4
		1	271	24.9	24.8	24.8	24.6	24.4	24.0	24.0	23.9	23.6	24.4	24.2	24.1
		1	272	23.7	23.7	23.6	23.3	23.1	22.7	22.9	22.6	22.5	23.6	23.5	23.4
		135	67	24.9	24.5	24.8	24.4	24.3	24.1	24.2	23.9	23.8	24.1	24.2	24.0
		270	0	23.9	23.6	23.6	23.4	23.3	23.2	23.1	23.0	22.8	23.6	23.6	23.5
	16QAM	1	0	22.6	22.8	22.6	22.5	22.5	22.7	22.5	22.2	22.0	22.6	22.7	22.6
		1	1	23.9	23.9	23.7	23.6	23.4	23.6	23.4	23.4	23.1	23.6	23.9	23.5
		1	271	23.7	24.0	23.8	23.5	23.5	23.1	23.2	23.1	22.9	23.9	23.6	23.4
		1	272	22.5	23.0	22.6	22.6	22.2	21.9	22.0	21.8	21.7	22.5	22.6	22.5
		135	67	23.8	23.6	23.7	23.3	23.3	23.2	23.2	23.0	22.8	23.4	23.6	23.4
		270	0	22.9	22.6	22.7	22.5	22.4	22.3	22.0	21.9	21.8	22.5	22.6	22.5
	64QAM	1	0	22.0	22.4	22.3	22.1	22.0	21.9	21.7	21.3	21.4	22.2	21.9	22.0
		1	1	22.5	22.6	22.3	22.2	22.0	21.8	21.9	21.6	21.5	22.3	22.0	22.2
		1	271	22.5	22.6	22.4	22.3	21.9	21.5	21.4	21.4	21.4	22.2	22.3	22.0
		1	272	22.2	22.4	22.2	22.0	21.8	21.1	21.3	21.3	21.6	22.2	22.3	21.8
		135	67	22.3	22.0	22.1	21.9	21.8	21.6	21.7	21.3	21.3	21.8	22.1	21.8
		270	0	22.2	22.2	22.2	21.8	21.9	21.6	21.6	21.5	21.3	22.0	22.1	21.9
	256QAM	1	0	20.2	20.3	20.1	19.5	20.3	19.9	19.9	19.6	19.5	19.9	20.3	20.2
		1	1	20.6	20.6	20.7	19.7	20.3	19.8	19.8	19.9	19.8	20.0	20.2	20.4
		1	271	20.4	20.5	20.4	19.6	20.2	19.3	19.6	19.5	19.3	20.3	20.4	20.1
		1	272	20.0	20.3	20.2	19.5	19.9	19.4	19.4	19.4	19.4	20.2	19.9	20.1
		135	67	20.3	19.9	20.2	19.8	19.8	19.7	19.6	19.4	19.2	19.9	20.0	20.0
		270	0	20.3	20.1	20.1	19.9	19.8	19.7	19.6	19.5	19.2	20.1	20.1	20.0

## 8.12. LTE BAND 41 AND 5G NR n41 HPUE

### LTE BAND 41

Test Engineer ID:	19210AL	Test Date:	2024-03-04
-------------------	---------	------------	------------

### OUTPUT POWER FOR LTE BAND 41 (5.0 MHz)

Bandwidth (MHz)	Modulation	RB Allocation	RB Offset	Conducted Average (dBm)					
				ANT 2			ANT 0		
				39675	40620	41565	39675	40620	41565
5.0	QPSK	1	0	25.6	25.6	25.8	25.3	25.1	23.6
		1	12	25.9	25.7	25.8	25.4	25.5	23.4
		1	24	25.7	25.5	25.7	25.2	25.0	23.5
		12	0	24.6	24.6	24.8	24.3	22.6	22.6
		12	6	24.6	24.6	24.8	24.3	22.6	22.6
		12	11	24.6	24.9	24.8	24.3	22.6	22.6
		25	0	24.6	24.9	24.9	24.3	22.6	22.7
	16QAM	1	0	24.8	25.1	25.2	24.4	22.7	22.6
		1	12	25.1	25.1	24.9	24.7	22.7	22.4
		1	24	25.0	25.3	25.3	24.3	22.5	22.9
		12	0	23.6	25.0	23.9	23.1	21.5	21.6
		12	6	23.6	23.9	23.9	23.2	21.5	21.6
		12	11	23.6	23.9	23.8	23.3	21.5	21.6
		25	0	23.6	23.8	23.9	23.3	21.5	21.7
	64QAM	1	0	24.4	24.3	24.7	24.1	21.9	22.2
		1	12	24.8	24.7	24.9	24.4	22.1	21.9
		1	24	24.5	24.7	24.4	24.0	21.9	22.2
		12	0	23.0	24.8	23.4	22.7	20.9	21.0
		12	6	23.0	23.4	23.3	22.7	20.9	21.0
		12	11	23.0	23.3	23.3	22.7	21.0	21.0
		25	0	23.0	23.3	23.2	22.7	21.0	20.9
	256QAM	1	0	21.4	21.2	21.8	21.3	19.4	19.4
		1	12	21.8	21.7	22.1	21.6	19.6	19.4
		1	24	21.6	21.8	21.3	20.9	19.3	19.4
		12	0	21.4	21.6	21.6	21.0	19.4	19.4
12		6	21.4	21.6	21.6	21.1	19.3	19.4	
12		11	21.3	21.7	21.6	21.1	19.3	19.3	
25		0	21.3	21.6	21.5	21.0	19.3	19.3	

### OUTPUT POWER FOR LTE BAND 41 (10.0 MHz)

Bandwidth (MHz)	Modulation	RB Allocation	RB Offset	Conducted Average (dBm)					
				ANT 2			ANT 0		
				39700	40620	41540	39700	40620	41540
10.0	QPSK	1	0	25.7	25.9	25.7	25.3	25.5	25.3
		1	24	25.5	25.5	25.7	25.1	25.1	25.3
		1	49	25.7	25.8	25.8	25.3	25.4	25.4
		25	0	24.8	24.8	24.8	24.4	24.4	24.4
		25	12	24.7	24.7	24.7	24.3	24.3	24.3
		25	24	24.8	24.7	24.7	24.4	24.3	24.3
		50	0	24.8	24.7	24.8	24.4	24.3	24.4
	16QAM	1	0	24.8	24.5	24.5	24.4	24.1	24.1
		1	24	24.7	24.9	24.9	24.3	24.5	24.5
		1	49	24.6	24.8	25.0	24.2	24.4	24.6
		25	0	23.8	23.7	23.7	23.4	23.3	23.3
		25	12	23.8	23.7	23.8	23.4	23.3	23.4
		25	24	23.7	23.7	23.7	23.3	23.3	23.3
		50	0	23.8	23.7	23.8	23.4	23.3	23.4
	64QAM	1	0	24.1	23.7	24.1	23.7	23.3	23.7
		1	24	23.7	23.6	23.8	23.3	23.2	23.4
		1	49	24.1	24.0	23.9	23.7	23.6	23.5
		25	0	22.8	22.7	22.8	22.4	22.3	22.4
		25	12	22.8	22.7	22.7	22.4	22.3	22.3
		25	24	22.8	22.7	22.7	22.4	22.3	22.3
		50	0	22.8	22.7	22.7	22.4	22.3	22.3
	256QAM	1	0	21.4	21.5	21.6	21.0	21.1	21.2
		1	24	21.6	21.2	21.9	21.2	20.8	21.5
		1	49	21.6	21.6	21.5	21.2	21.2	21.1
		25	0	21.5	21.4	21.4	21.1	21.0	21.0
25		12	21.4	21.4	21.4	21.0	21.0	21.0	
25		24	21.5	21.3	21.4	21.1	20.9	21.0	
50		0	21.4	21.3	21.3	21.0	20.9	20.9	



**OUTPUT POWER FOR LTE BAND 41 (15.0 MHz)**

Bandwidth (MHz)	Modulation	RB Allocation	RB Offset	Conducted Average (dBm)					
				ANT 2			ANT 0		
				39725	40620	41515	39725	40620	41515
15.0	QPSK	1	0	25.8	25.7	25.8	25.4	25.3	25.4
		1	37	<b>25.9</b>	25.8	25.9	<b>25.5</b>	25.4	25.5
		1	74	25.7	25.6	25.6	25.3	25.2	25.2
		36	0	24.8	24.7	24.8	24.4	24.3	24.4
		36	16	24.8	24.7	24.7	24.4	24.3	24.3
		36	35	24.8	24.7	24.7	24.4	24.3	24.3
		75	0	24.8	24.7	24.8	24.4	24.3	24.4
	16QAM	1	0	24.7	25.0	25.0	24.3	24.6	24.6
		1	37	24.4	25.0	<b>25.1</b>	24.0	24.6	<b>24.7</b>
		1	74	24.8	24.9	24.7	24.4	24.5	24.3
		36	0	23.8	23.7	23.7	23.4	23.3	23.3
		36	16	23.8	23.7	23.7	23.4	23.3	23.3
		36	35	23.7	23.6	23.8	23.3	23.2	23.4
		75	0	23.8	23.7	23.8	23.4	23.3	23.4
	64QAM	1	0	24.1	24.2	24.2	23.7	23.8	23.8
		1	37	24.2	<b>24.3</b>	24.1	23.8	<b>23.9</b>	23.7
		1	74	24.1	24.0	24.0	23.7	23.6	23.6
		36	0	22.8	22.7	22.7	22.4	22.3	22.3
		36	16	22.7	22.7	22.7	22.3	22.3	22.3
		36	35	22.8	22.7	22.7	22.4	22.3	22.3
		75	0	22.7	22.7	22.8	22.3	22.3	22.4
	256QAM	1	0	<b>22.0</b>	21.5	21.6	<b>21.6</b>	21.1	21.2
		1	37	21.7	21.2	21.6	21.3	20.8	21.2
		1	74	21.6	21.3	21.8	21.2	20.9	21.4
		36	0	21.4	21.4	21.5	21.0	21.0	21.1
		36	16	21.4	21.4	21.4	21.0	21.0	21.0
		36	35	21.4	21.4	21.4	21.0	21.0	21.0
		75	0	21.4	21.4	21.4	21.0	21.0	21.0

**OUTPUT POWER FOR LTE BAND 41 (20.0 MHz)**

Bandwidth (MHz)	Modulation	RB Allocation	RB Offset	Conducted Average (dBm)					
				ANT 2			ANT 0		
				39750	40620	41490	39750	40620	41490
20.0	QPSK	1	0	<b>25.9</b>	25.7	25.8	24.9	24.9	24.9
		1	49	25.6	25.7	25.7	<b>25.0</b>	24.8	24.9
		1	99	25.8	25.8	25.7	24.9	24.8	24.9
		50	0	24.8	24.8	24.8	23.9	23.8	23.9
		50	24	24.8	24.8	24.8	23.9	23.8	23.9
		50	49	24.8	24.8	24.8	23.9	23.8	23.8
		100	0	24.8	24.7	24.8	23.9	23.8	23.9
	16QAM	1	0	24.8	24.6	<b>24.9</b>	24.0	23.6	<b>24.2</b>
		1	49	24.7	24.9	24.8	23.4	23.8	23.8
		1	99	24.8	24.6	24.8	23.8	23.8	23.8
		50	0	23.9	23.8	23.9	22.9	22.8	22.9
		50	24	23.9	23.8	23.9	22.9	22.8	22.9
		50	49	23.8	23.7	23.9	22.9	22.8	22.8
		100	0	23.8	23.7	23.8	22.9	22.8	22.8
	64QAM	1	0	23.8	23.8	24.1	23.0	22.9	22.8
		1	49	<b>24.1</b>	23.7	24.1	<b>23.1</b>	22.4	23.1
		1	99	24.0	23.7	23.8	22.9	22.8	22.7
		50	0	22.9	22.7	22.8	21.8	21.7	21.8
		50	24	22.8	22.7	22.8	21.8	21.7	21.8
		50	49	22.8	22.7	22.8	21.8	21.7	21.8
		100	0	22.8	22.7	22.8	21.9	21.7	21.8
	256QAM	1	0	21.6	21.2	<b>21.8</b>	<b>20.1</b>	20.0	20.0
		1	49	21.5	20.9	21.1	19.7	19.6	20.0
		1	99	21.3	21.6	21.2	19.8	19.6	19.9
		50	0	21.3	21.2	21.3	19.9	19.7	19.8
		50	24	21.3	21.2	21.2	19.8	19.7	19.8
		50	49	21.3	21.2	21.2	19.8	19.7	19.8
		100	0	21.3	21.2	21.3	19.9	19.7	19.8

**5G NR n41**

<b>Test Engineer ID:</b>	19210AL and 27966PV	<b>Test Date:</b>	2024-02-07 to 2024-05-01
--------------------------	---------------------	-------------------	--------------------------

**OUTPUT POWER FOR 5G NR n41 (10.0 MHz)**

Bandwidth (MHz)	Modulation	RB Allocation	RB Offset	Conducted Average (dBm)											
				ANT 2			ANT 0			ANT 1			ANT 5		
				500200 2501.0	518600 2593.0	537000 2685.0	500200 2501.0	518600 2593.0	537000 2685.0	500200 2501.0	518600 2593.0	537000 2685.0	500200 2501.0	518600 2593.0	537000 2685.0
10.0	BPSK	1	0	22.3	22.2	21.9	22.3	22.2	21.7	22.3	22.0	21.9	22.8	22.8	22.6
		1	1	<b>25.9</b>	25.7	25.5	<b>25.5</b>	25.4	25.0	<b>25.9</b>	25.6	25.5	24.8	25.8	25.9
		1	22	25.7	25.7	25.5	25.4	25.3	24.7	25.7	25.6	25.6	24.6	25.8	25.8
		1	23	22.1	22.1	21.9	22.2	22.1	21.7	22.1	22.1	21.8	22.7	22.9	22.8
		12	6	25.7	25.7	25.5	25.4	25.3	24.9	25.8	25.6	25.5	24.7	25.8	25.7
	QPSK	24	0	25.2	25.1	25.0	25.2	25.3	24.7	25.1	25.1	25.1	24.7	<b>25.9</b>	25.8
		1	0	22.2	22.3	22.0	22.2	22.3	21.8	22.2	22.0	22.0	22.2	22.2	22.2
		1	1	<b>25.9</b>	25.8	25.5	<b>25.4</b>	25.4	25.0	<b>25.8</b>	25.5	25.6	24.7	25.8	25.7
		1	22	25.9	25.7	25.5	<b>25.4</b>	25.3	24.9	25.6	25.5	25.6	24.7	25.8	25.6
		1	23	22.2	22.2	21.9	22.2	22.2	21.7	22.0	22.0	22.0	22.2	22.3	22.1
	16QAM	12	6	25.8	25.8	25.5	25.4	25.4	24.8	25.6	25.7	25.4	24.8	25.8	25.8
		24	0	24.7	24.8	24.5	24.7	24.7	24.3	25.2	24.5	24.4	24.7	<b>25.9</b>	25.8
		1	0	22.6	22.4	22.3	22.3	22.1	21.7	22.0	22.4	22.0	22.8	22.6	22.6
		1	1	<b>25.3</b>	25.2	25.0	<b>25.0</b>	24.6	24.3	<b>25.2</b>	25.0	24.7	<b>25.4</b>	25.1	25.2
		1	22	25.1	25.1	25.1	24.8	24.7	24.2	24.9	25.0	25.1	25.3	25.3	24.9
	64QAM	1	23	22.5	22.4	22.4	22.3	22.0	21.4	22.2	22.4	22.3	22.8	22.0	21.2
		12	6	25.2	25.1	25.1	24.9	24.7	24.2	25.2	25.1	24.8	25.3	25.2	25.1
		24	0	24.1	24.0	23.8	23.8	23.7	23.2	24.0	24.1	23.9	25.2	24.6	24.6
		1	0	22.4	22.5	22.5	22.1	22.3	21.6	22.7	22.7	22.2	22.1	22.0	22.0
		1	1	23.7	23.8	23.4	23.2	23.3	22.6	<b>23.7</b>	23.4	23.2	23.5	<b>23.9</b>	23.7
	256QAM	1	22	23.4	<b>23.9</b>	23.4	23.2	23.1	22.5	23.5	23.7	23.2	23.5	23.9	23.8
		1	23	22.5	22.6	22.5	22.1	22.1	21.6	22.6	22.7	22.2	21.1	21.1	20.9
		12	6	23.6	23.6	23.3	<b>23.4</b>	23.3	22.7	23.5	23.5	23.3	23.3	23.9	23.9
		24	0	23.6	23.5	23.4	23.2	23.2	22.7	23.6	23.5	23.2	23.3	23.4	23.3
1		0	21.6	<b>21.6</b>	21.3	21.1	21.2	21.0	21.5	<b>22.1</b>	21.2	20.7	20.9	20.8	
10.0	256QAM	1	1	21.6	21.3	21.4	21.2	21.2	21.0	21.7	21.5	21.4	20.8	20.9	20.9
		1	22	21.6	21.4	21.3	21.0	21.3	20.8	21.5	21.4	21.3	20.7	20.9	20.6
		1	23	21.6	21.4	21.4	21.1	21.2	20.8	21.5	21.6	21.4	20.9	20.8	20.7
		12	6	21.6	21.6	21.4	<b>21.4</b>	21.2	20.7	21.5	21.5	21.4	20.8	<b>21.0</b>	20.8
		24	0	21.6	21.6	21.3	21.3	21.3	20.7	21.5	21.5	21.3	20.9	20.9	20.8

**OUTPUT POWER FOR 5G NR n41 (15.0 MHz)**

Bandwidth (MHz)	Modulation	RB Allocation	RB Offset	Conducted Average (dBm)											
				ANT 2			ANT 0			ANT 1			ANT 5		
				500700 2503.5	518600 2593.0	536500 2682.5	500700 2503.5	518600 2593.0	536500 2682.5	500700 2503.5	518600 2593.0	536500 2682.5	500700 2503.5	518600 2593.0	536500 2682.5
15.0	BPSK	1	0	22.3	22.2	22.0	22.3	22.2	21.8	22.2	22.3	22.0	22.5	22.4	22.5
		1	1	25.8	25.9	25.6	<b>25.5</b>	25.4	24.9	<b>25.9</b>	25.7	25.6	24.6	25.6	25.5
		1	36	25.8	<b>25.9</b>	25.6	25.4	25.2	24.8	25.8	25.8	25.6	24.5	<b>25.7</b>	25.6
		1	37	22.3	22.3	22.1	22.2	22.2	21.6	22.2	22.2	21.9	22.5	22.7	22.6
		18	9	25.8	25.8	25.7	25.3	25.4	24.8	25.8	25.7	25.6	24.4	25.5	25.5
	QPSK	36	0	25.3	25.2	25.2	25.2	25.3	24.7	25.3	25.2	25.0	24.4	25.6	25.5
		1	0	22.4	22.3	22.0	22.1	22.2	21.7	22.2	22.2	21.8	21.9	22.0	22.0
		1	1	<b>25.9</b>	25.9	25.7	25.4	25.4	24.9	<b>25.9</b>	25.6	25.6	24.6	25.6	25.5
		1	36	25.9	25.9	25.7	25.3	25.3	24.8	25.8	25.7	25.5	24.5	<b>25.7</b>	25.5
		1	37	22.2	22.3	22.1	22.1	22.0	21.6	22.1	22.2	21.8	22.0	22.3	21.9
	16QAM	18	9	25.8	25.9	25.6	25.4	<b>25.5</b>	24.9	25.8	25.7	25.6	24.4	25.6	25.7
		36	0	24.8	24.7	24.7	24.7	24.8	24.2	24.7	24.8	24.6	24.5	25.6	25.6
		1	0	22.5	22.7	22.2	22.0	22.5	21.4	22.5	22.6	22.4	22.7	22.9	22.9
		1	1	<b>25.2</b>	25.1	24.7	24.6	<b>24.9</b>	24.5	25.3	25.3	25.1	25.5	25.4	25.3
		1	36	25.0	25.1	24.8	24.6	24.7	24.4	24.9	<b>25.3</b>	25.1	25.5	<b>25.6</b>	25.6
	64QAM	1	37	22.6	22.6	22.3	22.1	22.3	21.5	22.3	22.7	22.4	22.7	22.0	21.9
		18	9	25.1	25.1	24.9	24.8	24.8	24.3	25.2	25.1	24.9	25.4	25.5	25.5
		36	0	24.0	24.1	24.0	23.8	23.7	23.2	24.1	24.0	23.9	25.5	25.1	25.0
		1	0	22.6	22.5	22.4	22.1	22.1	21.7	22.6	22.6	22.5	23.1	23.0	22.9
		1	1	23.4	23.4	23.4	23.1	23.3	22.7	23.5	23.6	23.5	23.6	23.8	23.8
	256QAM	1	36	23.5	<b>23.6</b>	23.4	23.0	23.3	22.8	<b>23.7</b>	23.5	23.2	23.7	<b>23.8</b>	23.7
		1	37	22.6	22.4	22.6	22.1	22.2	21.9	22.5	22.6	22.3	21.1	20.8	20.6
		18	9	23.6	23.5	23.5	23.2	<b>23.4</b>	22.7	23.7	23.6	23.5	23.6	23.6	23.6
		36	0	23.6	23.6	23.4	23.2	22.7	23.6	23.6	23.5	23.5	23.5	23.1	23.2
1		0	<b>22.1</b>	21.7	21.4	21.1	21.4	20.8	21.9	21.5	21.9	<b>22.2</b>	21.9	21.7	
15.0	256QAM	1	1	21.5	21.5	21.6	21.2	<b>21.5</b>	20.9	<b>21.9</b>	21.6	21.4	22.0	21.8	21.8
		1	36	21.6	21.5	21.2	21.2	21.2	20.7	21.3	21.4	21.3	21.9	21.8	21.7
		1	37	21.4	21.8	21.2	21.1	21.0	20.4	21.8	21.6	21.3	22.1	21.9	<b>22.2</b>
		18	9	21.6	21.6	21.3	21.2	21.2	20.7	21.6	21.7	21.5	21.9	22.0	21.8
		36	0	21.5	21.5	21.4	21.1	21.3	20.7	21.6	21.6	21.4	21.8	22.0	21.9



**OUTPUT POWER FOR 5G NR n41 (20.0 MHz)**

Bandwidth (MHz)	Modulation	RB Allocation	RB Offset	Conducted Average (dBm)											
				ANT 2			ANT 0			ANT 1			ANT 5		
				501200 2506.0	518600 2593.0	536000 2680.0	501200 2506.0	518600 2593.0	536000 2680.0	501200 2506.0	518600 2593.0	536000 2680.0	501200 2506.0	518600 2593.0	536000 2680.0
20.0	BPSK	1	0	22.3	22.3	22.1	22.3	22.1	21.7	22.3	22.2	22.0	22.7	22.6	22.7
		1	1	<b>25.9</b>	25.7	25.7	<b>25.4</b>	25.4	25.0	<b>25.9</b>	25.7	25.6	24.7	<b>25.8</b>	25.7
		1	49	25.9	25.7	25.7	25.3	25.3	24.8	25.8	25.6	25.5	24.7	25.8	25.6
		1	50	22.4	22.3	22.1	22.2	22.0	21.5	22.3	22.2	21.9	22.7	22.6	22.6
		25	12	25.9	25.9	25.7	25.4	25.3	24.8	25.8	25.8	25.5	24.7	25.7	25.7
	QPSK	50	0	25.3	25.3	25.2	25.2	25.3	24.7	25.3	25.3	25.1	24.6	25.7	25.7
		1	0	22.4	22.2	22.2	22.2	22.3	21.7	22.3	22.1	22.2	22.2	22.2	22.0
		1	1	25.8	25.8	25.6	<b>25.4</b>	25.3	24.9	<b>25.8</b>	25.7	25.7	24.7	25.7	25.6
		1	49	25.8	25.8	25.5	25.2	25.2	24.7	25.7	25.6	25.6	24.7	25.8	25.5
		1	50	22.2	22.2	22.1	22.2	22.0	21.5	22.3	22.0	21.9	22.1	22.2	22.2
	16QAM	25	12	25.8	<b>25.9</b>	25.8	<b>25.4</b>	25.3	24.9	25.8	25.7	25.6	24.7	25.8	<b>25.8</b>
		50	0	24.8	24.8	24.8	24.8	24.8	24.2	24.8	24.8	24.5	24.8	25.8	25.7
		1	0	22.2	22.3	22.4	22.4	22.2	21.8	22.7	22.3	21.9	22.1	22.2	22.0
		1	1	24.7	<b>24.9</b>	24.8	<b>24.5</b>	24.5	24.3	24.6	<b>24.9</b>	24.5	24.4	24.7	24.3
		1	49	24.8	24.9	24.7	24.4	24.5	24.1	24.7	24.7	24.6	24.5	24.4	24.5
	64QAM	1	50	22.3	22.1	22.2	22.2	22.2	21.6	22.4	22.2	22.1	21.9	22.4	22.0
		25	12	24.9	24.9	24.7	24.3	24.3	24.3	24.8	24.8	24.6	24.7	24.6	24.6
		50	0	23.7	24.0	23.6	23.7	23.7	23.3	23.7	23.7	23.6	<b>24.8</b>	24.5	24.5
		1	0	22.5	22.7	22.6	22.3	22.4	21.6	22.5	22.9	22.5	22.5	22.0	21.9
		1	1	23.6	23.5	23.4	<b>23.3</b>	23.2	22.7	<b>23.7</b>	23.4	23.7	23.4	23.5	23.1
	256QAM	1	49	<b>24.1</b>	24.1	23.6	23.3	23.1	22.4	23.5	23.5	23.7	<b>23.7</b>	23.5	23.3
		1	50	22.6	23.0	22.8	22.2	22.3	21.5	22.5	22.5	22.2	20.9	20.5	20.1
		25	12	23.7	23.7	23.6	23.2	23.1	22.8	23.5	23.6	23.5	23.4	23.6	23.4
		50	0	23.8	23.8	23.6	23.2	23.2	22.7	23.6	23.6	23.4	23.3	23.0	23.0
		1	0	21.6	21.6	21.6	21.4	21.2	20.6	<b>21.8</b>	21.3	21.6	21.4	21.3	21.5
256QAM	1	1	21.6	21.6	21.8	21.6	21.4	20.7	21.8	21.7	21.3	21.6	21.4	21.3	
	1	49	21.7	21.7	21.5	<b>21.7</b>	21.1	20.5	21.6	21.3	21.2	21.6	21.3	21.2	
	1	50	21.6	<b>21.8</b>	21.6	21.5	21.2	20.5	21.5	21.3	21.5	21.4	21.3	<b>21.6</b>	
	25	12	21.6	21.7	21.6	21.2	21.2	20.7	21.6	21.6	21.4	21.4	21.4	21.3	
	50	0	21.6	21.7	21.5	21.2	21.1	20.8	21.6	21.5	21.4	21.4	21.3	21.3	

**OUTPUT POWER FOR 5G NR n41 (25.0 MHz)**

Bandwidth (MHz)	Modulation	RB Allocation	RB Offset	Conducted Average (dBm)											
				ANT 2			ANT 0			ANT 1			ANT 5		
				501702 2508.5	518600 2593.0	535500 2677.5	501702 2508.5	518600 2593.0	535500 2677.5	501702 2508.5	518600 2593.0	535500 2677.5	501702 2508.5	518600 2593.0	535500 2677.5
25.0	BPSK	1	0	22.7	22.7	22.6	22.5	22.4	21.9	22.6	22.6	22.5	23.3	23.5	23.4
		1	1	<b>26.3</b>	<b>26.3</b>	26.1	<b>25.6</b>	<b>25.6</b>	25.2	<b>26.3</b>	<b>26.3</b>	26.0	25.5	26.4	<b>26.5</b>
		1	63	<b>26.3</b>	<b>26.3</b>	26.0	25.5	25.4	24.9	26.0	26.1	26.0	25.4	<b>26.5</b>	26.4
		1	64	22.8	22.7	22.5	22.4	22.2	21.8	22.5	22.4	22.3	23.3	23.4	23.2
		32	16	26.2	26.2	26.1	25.5	<b>25.6</b>	25.1	26.1	26.2	26.0	25.4	<b>26.5</b>	26.4
	QPSK	64	0	25.8	25.8	25.6	25.4	25.4	25.0	25.6	25.6	25.5	25.3	<b>26.5</b>	<b>26.5</b>
		1	0	22.8	22.7	22.5	22.4	22.3	22.0	22.7	22.5	22.4	22.7	23.0	22.9
		1	1	<b>26.4</b>	26.2	26.1	<b>25.7</b>	25.5	25.2	<b>26.2</b>	<b>26.2</b>	26.0	25.3	<b>26.6</b>	26.4
		1	63	<b>26.4</b>	26.3	26.1	25.6	25.3	25.0	26.1	26.1	25.9	25.3	<b>26.6</b>	26.3
		1	64	22.7	22.7	22.4	22.3	22.2	21.9	22.4	22.3	22.4	22.7	22.9	22.8
	16QAM	32	16	26.3	26.3	26.2	25.5	25.6	25.1	<b>26.2</b>	26.1	26.1	25.3	26.5	26.4
		64	0	25.3	25.2	25.1	24.9	25.0	24.5	25.1	25.1	25.0	25.4	26.4	26.4
		1	0	22.8	22.7	22.6	22.4	22.4	22.2	22.4	22.7	22.2	22.7	22.9	22.8
		1	1	25.3	<b>25.5</b>	25.1	24.7	<b>24.9</b>	24.6	<b>25.3</b>	<b>25.3</b>	24.9	25.3	<b>26.7</b>	26.5
		1	63	25.3	25.2	25.1	24.7	24.5	24.9	24.9	24.9	24.9	25.1	26.4	26.4
	64QAM	1	64	22.5	22.6	22.6	21.9	22.2	21.7	22.6	22.5	22.3	22.7	23.0	22.8
		32	16	25.2	25.2	25.0	<b>24.9</b>	<b>24.9</b>	24.6	25.1	25.1	25.0	25.4	26.5	26.4
		64	0	24.3	24.2	24.1	24.0	23.8	23.5	24.1	24.2	24.0	25.3	26.0	25.9
		1	0	22.7	22.7	22.7	22.7	22.3	21.9	22.7	22.4	22.3	23.0	22.9	22.8
		1	1	23.7	<b>24.0</b>	<b>24.0</b>	<b>23.5</b>	<b>23.5</b>	23.1	<b>23.9</b>	<b>23.9</b>	23.5	23.4	25.3	<b>26.0</b>
	256QAM	1	63	23.7	<b>24.0</b>	23.8	23.4	23.0	22.9	23.6	23.8	23.4	25.3	25.6	25.9
		1	64	23.0	22.6	22.7	22.7	21.9	22.0	22.3	22.5	22.6	22.7	22.8	22.6
		32	16	23.8	23.7	23.6	23.4	23.4	22.9	23.7	23.6	23.4	25.4	<b>26.0</b>	25.9
		64	0	23.7	23.8	23.6	23.4	23.4	23.0	23.6	23.5	23.5	25.4	25.5	25.4
		1	0	21.8	21.8	21.4	21.4	21.2	20.9	21.6	21.4	21.5	22.8	22.8	<b>23.1</b>
256QAM	1	1	21.9	21.7	21.7	<b>21.7</b>	21.2	21.3	21.5	21.7	21.5	22.8	22.8	22.6	
	1	63	21.8	21.8	21.5	21.3	21.3	20.7	21.5	<b>21.8</b>	21.3	22.8	23.0	23.0	
	1	64	21.6	22.0	<b>22.1</b>	21.3	20.9	21.0	21.1	21.5	21.3	22.8	<b>23.1</b>	22.9	
	32	16	21.7	21.8	21.5	21.3	21.4	21.0	21.5	21.5	21.4	22.8	22.9	22.9	
	64	0	21.8	21.7	21.6	21.4	21.4	20.9	21.5	21.5	21.5	22.9	23.0	22.9	

**OUTPUT POWER FOR 5G NR n41 (30.0 MHz)**

Bandwidth (MHz)	Modulation	RB Allocation	RB Offset	Conducted Average (dBm)											
				ANT 2			ANT 0			ANT 1			ANT 5		
				502200	518600	525000	502200	518600	525000	502200	518600	525000	502200	518600	525000
30.0	BPSK	1	0	22.2	22.2	22.1	22.3	22.2	21.8	22.2	22.2	22.1	22.6	22.7	22.6
		1	1	25.9	25.8	25.6	25.4	25.5	25.0	25.9	25.9	25.6	24.7	25.6	25.7
		1	76	25.9	25.8	25.6	25.4	25.2	24.7	25.6	25.7	25.6	24.6	25.8	25.6
		1	77	22.3	22.3	22.0	22.2	22.0	21.6	22.1	22.0	21.9	22.5	22.6	22.4
		36	18	25.8	25.7	25.6	25.3	25.4	24.9	25.7	25.8	25.6	24.6	25.7	25.7
		75	0	25.4	25.3	25.1	25.2	25.2	24.8	25.3	25.2	25.1	24.6	25.8	25.7
	QPSK	1	0	22.3	22.2	22.0	22.2	22.2	21.8	22.3	22.2	22.1	22.0	22.2	22.2
		1	1	25.9	25.8	25.6	25.5	25.3	25.1	25.8	25.8	25.6	24.5	25.8	25.6
		1	76	25.9	25.8	25.6	25.4	25.2	24.8	25.7	25.7	25.5	24.6	25.8	25.6
		1	77	22.3	22.2	22.0	22.1	22.0	21.7	22.0	22.0	22.0	21.9	22.1	22.1
		36	18	25.8	25.8	25.7	25.4	25.4	25.0	25.8	25.7	25.7	24.6	25.7	25.7
		75	0	24.8	24.7	24.6	24.7	24.8	24.3	24.7	24.7	24.6	24.6	25.6	25.7
	16QAM	1	0	22.8	22.7	22.6	22.2	22.2	22.0	22.5	22.7	22.2	21.9	22.1	22.0
		1	1	25.3	25.3	25.0	24.6	24.7	24.4	25.3	24.9	24.5	24.5	25.0	24.8
		1	76	25.3	25.2	25.2	24.5	24.5	24.4	24.9	24.9	24.9	24.4	24.7	24.7
		1	77	22.6	22.7	22.6	21.8	22.1	21.5	22.7	22.5	22.3	21.9	22.3	22.0
		36	18	25.3	25.3	25.0	24.8	24.7	24.5	25.1	25.1	25.1	24.7	24.8	24.7
		75	0	24.3	24.2	24.1	23.8	23.7	23.3	24.1	24.2	24.0	24.6	24.3	24.2
	64QAM	1	0	22.8	22.7	22.7	22.5	22.1	21.8	22.7	22.4	22.3	22.3	22.1	22.1
		1	1	23.7	24.0	24.0	23.3	23.3	22.9	24.0	23.5	23.4	23.4	23.5	23.5
		1	76	23.7	24.0	23.8	23.3	22.8	22.8	23.7	23.8	23.5	23.3	23.1	23.4
		1	77	23.0	22.7	22.7	22.5	21.8	21.8	22.3	22.6	22.6	20.7	20.3	20.1
		36	18	23.8	23.7	23.6	23.2	23.2	22.8	23.7	23.6	23.5	23.4	23.5	23.4
		75	0	23.7	23.8	23.6	23.2	23.2	22.9	23.6	23.5	23.6	23.4	23.5	23.5
	256QAM	1	0	21.8	21.9	21.4	21.3	21.0	20.8	21.7	21.5	21.5	22.1	22.1	22.3
		1	1	21.9	21.7	21.8	21.5	21.0	21.1	21.5	21.7	21.5	22.0	22.1	21.8
		1	76	21.8	21.8	21.5	21.1	21.1	20.5	21.5	21.8	21.4	22.0	22.3	22.2
		1	77	21.6	22.0	22.2	21.1	20.8	20.9	21.1	21.5	21.3	22.0	22.3	22.2
		36	18	21.7	21.8	21.6	21.2	21.2	20.8	21.5	21.6	21.4	22.1	22.1	22.1
		75	0	21.8	21.7	21.6	21.2	21.2	20.7	21.6	21.6	21.5	22.1	22.2	22.1

**OUTPUT POWER FOR 5G NR n41 (40.0 MHz)**

Bandwidth (MHz)	Modulation	RB Allocation	RB Offset	Conducted Average (dBm)											
				ANT 2			ANT 0			ANT 1			ANT 5		
				503200	518600	534000	503200	518600	534000	503200	518600	534000	503200	518600	534000
40.0	BPSK	1	0	22.2	22.3	22.2	22.2	22.3	21.8	22.2	22.1	21.8	22.7	22.7	22.6
		1	1	25.9	25.9	25.8	25.4	25.5	25.0	25.8	25.6	25.3	24.7	25.7	25.8
		1	104	25.9	25.9	25.7	25.4	25.3	24.7	25.7	25.5	25.5	24.7	25.7	25.7
		1	105	22.3	22.3	22.1	22.2	22.1	21.7	22.0	22.0	21.7	22.6	22.5	22.6
		50	25	25.8	25.9	25.8	25.4	25.3	25.0	25.6	25.5	25.4	24.6	25.7	25.7
		100	0	25.3	25.3	25.2	25.2	25.2	24.8	24.9	25.1	24.9	24.7	25.7	25.6
	QPSK	1	0	22.3	22.3	22.3	22.3	22.3	21.8	22.2	22.0	21.8	22.1	22.2	22.1
		1	1	25.8	25.9	25.8	25.4	25.5	25.2	25.7	25.6	25.4	24.6	25.9	25.6
		1	104	25.9	25.9	25.7	25.5	25.2	24.9	25.6	25.5	25.4	24.6	25.8	25.6
		1	105	22.4	22.3	22.2	22.2	22.1	21.6	22.0	22.0	21.8	22.1	22.1	22.0
		50	25	25.9	25.9	25.7	25.4	25.4	24.9	25.5	25.5	25.5	24.7	25.7	25.7
		100	0	24.8	24.9	24.8	24.7	24.7	24.3	24.5	24.5	24.5	24.5	25.7	25.7
	16QAM	1	0	22.4	22.2	22.5	22.1	22.3	21.8	22.0	21.7	21.7	21.5	21.8	21.3
		1	1	24.9	24.8	24.6	24.9	24.9	24.2	24.6	24.4	24.5	24.0	23.7	23.4
		1	104	24.9	25.1	24.4	24.8	24.7	24.0	24.7	24.3	24.4	24.7	24.3	24.4
		1	105	22.3	22.4	22.0	22.2	21.9	21.5	22.2	22.1	21.6	21.4	20.3	19.8
		50	25	24.8	24.8	24.8	24.8	24.8	24.3	24.5	24.5	24.3	24.0	24.1	24.5
		100	0	23.8	23.9	23.8	23.7	23.8	23.2	23.5	23.5	23.4	24.0	23.0	23.0
	64QAM	1	0	22.9	22.8	22.6	22.4	22.2	21.6	22.4	22.0	21.9	21.7	20.0	20.0
		1	1	23.9	24.0	23.6	23.1	23.4	22.9	23.3	23.0	22.9	24.0	23.0	23.0
		1	104	23.9	24.2	23.6	23.3	23.1	22.7	23.0	23.0	22.6	24.1	23.2	23.0
		1	105	22.9	22.9	22.7	22.5	22.2	21.6	21.4	21.9	21.8	21.4	21.6	21.5
		50	25	23.8	23.8	23.7	23.2	23.3	22.9	23.0	23.1	22.9	23.9	24.0	24.1
		100	0	23.7	23.9	23.8	23.2	23.2	22.8	23.0	23.0	22.9	24.0	24.0	23.8
	256QAM	1	0	21.9	22.1	21.9	21.7	21.3	20.6	21.7	21.6	21.6	21.3	21.3	21.4
		1	1	21.9	22.0	21.9	21.1	21.3	21.2	21.7	22.0	21.5	22.0	21.5	21.4
		1	104	21.9	21.8	21.9	21.7	21.1	20.6	21.8	21.8	21.3	21.5	21.3	21.1
		1	105	21.9	21.9	21.8	21.1	21.1	21.0	21.6	21.7	21.6	21.5	21.6	21.6
		50	25	21.7	21.8	21.7	21.2	21.2	20.8	21.7	21.6	21.5	21.4	21.4	21.3
		100	0	21.8	21.8	21.6	21.1	21.2	20.8	21.6	21.5	21.5	21.4	21.5	21.4

**OUTPUT POWER FOR 5G NR n41 (50.0 MHz)**

Bandwidth (MHz)	Modulation	RB Allocation	RB Offset	Conducted Average (dBm)											
				ANT 2			ANT 0			ANT 1			ANT 5		
				504200	518600	533000	504200	518600	533000	504200	518600	533000	504200	518600	533000
50.0	BPSK	1	0	22.2	22.4	22.3	22.1	22.2	21.8	22.1	22.1	21.8	23.4	23.4	23.5
		1	1	25.8	25.9	25.8	25.3	25.4	25.0	25.6	25.6	25.4	25.5	25.5	25.6
		1	131	25.9	25.8	25.7	25.4	25.1	24.8	25.6	25.7	25.4	25.4	25.5	25.4
		1	132	22.4	22.3	22.1	22.1	21.9	21.6	22.1	22.0	21.8	23.4	23.4	23.4
		64	32	25.8	25.8	25.7	25.3	25.2	24.9	25.5	25.5	25.4	25.5	25.6	25.4
		128	0	25.3	25.3	25.1	25.2	25.1	24.8	25.0	25.0	24.9	25.5	25.5	25.4
	QPSK	1	0	22.3	22.4	22.2	22.1	22.2	21.9	22.1	22.1	21.8	23.0	22.9	23.1
		1	1	25.8	25.9	25.9	25.3	25.3	25.1	25.7	25.6	25.4	25.5	25.4	25.6
		1	131	25.9	25.9	25.7	25.3	25.1	24.9	25.7	25.6	25.4	25.4	25.6	25.5
		1	132	22.4	22.3	22.1	22.1	21.8	21.6	22.0	22.0	21.8	22.8	23.0	22.9
		64	32	25.8	25.8	25.7	25.3	25.2	24.9	25.5	25.5	25.5	25.5	25.4	25.3
		128	0	24.8	24.8	24.7	24.6	24.6	24.3	24.5	24.5	24.4	25.4	25.5	25.4
	16QAM	1	0	22.5	22.6	22.4	22.5	22.5	22.0	22.6	22.8	22.7	22.3	22.6	22.3
		1	1	24.9	25.1	25.3	24.9	24.8	24.3	25.1	25.2	25.0	24.8	24.8	25.0
		1	131	25.0	25.0	24.8	24.8	24.2	24.1	25.0	25.0	24.7	25.1	24.9	25.1
		1	132	22.7	22.1	22.4	22.3	22.1	21.5	22.8	22.6	22.3	22.5	22.4	22.1
		64	32	25.0	25.0	24.8	24.6	24.6	24.2	25.1	25.1	24.9	25.0	24.9	24.8
		128	0	24.0	24.0	23.9	23.7	23.7	23.2	24.1	24.2	24.0	24.9	25.0	24.8
	64QAM	1	0	22.9	23.1	23.1	22.2	22.0	21.6	22.4	22.7	22.2	22.1	22.3	22.4
		1	1	23.9	24.1	23.7	23.0	23.2	22.7	24.0	23.7	23.6	23.4	23.8	23.8
		1	131	23.8	24.0	23.5	23.1	22.6	22.4	24.1	23.6	23.7	23.3	23.8	23.6
		1	132	23.2	22.9	22.5	21.9	21.7	21.7	22.3	22.5	22.5	20.8	21.1	21.0
		64	32	23.8	23.9	23.7	23.1	23.1	22.8	23.4	23.5	23.4	23.6	23.7	23.5
		128	0	23.9	23.9	23.8	23.2	23.1	22.8	23.6	23.6	23.5	23.7	23.7	23.6
	256QAM	1	0	21.9	21.7	21.7	21.3	21.2	20.9	21.6	21.8	21.3	21.7	21.9	22.1
		1	1	22.1	21.7	22.1	21.3	21.4	21.2	21.4	21.6	21.8	21.7	21.9	21.7
		1	131	21.9	21.9	21.7	21.2	21.2	20.7	21.6	21.3	21.8	22.0	21.8	22.1
		1	132	22.0	21.9	21.8	21.2	21.1	21.0	21.6	21.6	21.5	21.8	22.0	21.8
		64	32	21.8	21.8	21.6	21.1	21.1	20.7	21.4	21.6	21.4	21.7	21.7	21.6
		128	0	21.9	21.8	21.7	21.0	21.1	20.8	21.6	21.7	21.4	21.7	21.8	21.6

**OUTPUT POWER FOR 5G NR n41 (60.0 MHz)**

Bandwidth (MHz)	Modulation	RB Allocation	RB Offset	Conducted Average (dBm)											
				ANT 2			ANT 0			ANT 1			ANT 5		
				505200	518600	532000	505200	518600	532000	505200	518600	532000	505200	518600	532000
60.0	BPSK	1	0	22.1	22.2	22.3	22.2	22.2	21.8	22.0	22.0	21.9	22.5	22.7	22.6
		1	1	25.7	25.9	25.8	25.2	25.4	25.0	25.7	25.8	25.7	24.6	24.8	25.7
		1	160	25.8	25.7	25.5	25.3	25.1	24.7	25.6	25.5	25.5	24.6	24.5	25.6
		1	161	22.2	22.1	22.0	22.2	21.9	21.6	22.1	21.9	21.8	22.6	22.5	22.3
		81	40	25.7	25.7	25.6	25.3	25.2	25.0	25.4	25.5	25.5	24.6	24.5	25.5
		162	0	25.2	25.2	25.1	25.2	25.2	24.9	25.0	25.0	25.0	24.5	24.6	25.6
	QPSK	1	0	22.1	22.2	22.2	22.1	22.2	21.9	22.1	22.2	22.0	21.9	22.1	21.9
		1	1	25.6	25.8	25.8	25.3	25.4	25.1	25.8	25.6	25.5	24.5	24.7	25.4
		1	160	25.8	25.8	25.7	25.4	25.1	24.8	25.8	25.5	25.4	24.5	24.7	25.6
		1	161	22.3	22.2	22.0	22.2	21.9	21.7	22.1	22.0	21.8	21.9	22.1	21.9
		81	40	25.7	25.7	25.6	25.3	25.3	25.0	25.5	25.6	25.5	24.5	24.7	25.6
		162	0	24.7	24.7	24.6	24.7	24.7	24.3	24.4	24.5	24.7	24.5	24.6	25.7
	16QAM	1	0	22.2	22.2	22.3	22.1	22.3	22.1	21.9	21.9	22.0	22.0	22.2	21.8
		1	1	24.7	24.5	24.8	24.7	24.7	24.4	24.5	24.7	24.5	23.4	23.7	24.5
		1	160	25.0	24.7	24.3	24.7	24.5	24.5	24.4	24.5	24.5	23.5	23.6	24.7
		1	161	22.5	22.1	22.2	22.3	22.2	21.7	21.8	21.8	21.8	21.3	21.1	20.9
		81	40	24.6	24.6	24.6	24.6	24.7	24.3	24.4	24.5	24.6	23.7	23.7	24.6
		162	0	23.7	23.7	23.6	23.7	23.6	23.4	23.5	23.6	23.3	23.6	23.7	24.1
	64QAM	1	0	22.6	23.1	22.9	21.9	22.2	22.0	22.6	22.5	22.4	21.2	21.3	20.9
		1	1	23.6	23.9	23.9	23.0	23.2	23.1	23.8	23.6	23.9	23.8	23.8	24.0
		1	160	23.8	24.1	23.7	23.3	23.0	22.7	23.9	23.3	23.1	23.8	23.7	24.0
		1	161	23.0	22.8	23.0	22.0	21.8	21.8	22.9	22.2	22.3	21.4	21.1	20.6
		81	40	23.8	23.9	23.8	23.1	23.2	22.8	23.4	23.6	23.5	23.6	23.7	24.1
		162	0	23.8	23.9	23.8	23.2	23.1	22.8	23.4	23.6	23.4	23.5	23.7	23.6
	256QAM	1	0	21.9	22.2	21.7	21.3	21.2	21.0	21.8	21.6	21.5	21.1	21.1	21.2
		1	1	21.8	21.8	21.7	21.2	21.2	21.1	21.6	21.7	21.5	21.2	21.3	21.5
		1	160	21.9	22.1	21.5	21.2	20.7	20.9	21.6	21.6	21.3	21.2	21.2	21.1
		1	161	21.9	21.6	21.6	21.1	20.8	20.8	21.7	21.6	21.4	21.1	21.0	21.4
		81	40	21.9	21.9	21.8	21.0	21.1	20.8	21.4	21.5	21.6	21.1	21.1	21.1
		162	0	21.9	21.9	21.8	21.2	21.1	20.8	21.4	21.6	21.4	21.0	21.0	21.1

**OUTPUT POWER FOR 5G NR n41 (70.0 MHz)**

Bandwidth (MHz)	Modulation	RB Allocation	RB Offset	Conducted Average (dBm)											
				ANT 2			ANT 0			ANT 1			ANT 5		
				506200	518600	531000	506200	518600	531000	506200	518600	531000	506200	518600	531000
70.0	BPSK	1	0	22.2	22.3	22.2	22.2	22.1	21.7	22.0	22.0	22.6	22.6	22.6	
		1	1	25.8	<b>25.9</b>	25.8	25.3	25.2	25.0	25.6	<b>25.7</b>	25.4	24.6	<b>25.8</b>	25.6
		1	187	25.8	25.9	25.6	<b>25.4</b>	24.9	24.6	25.6	25.4	25.4	24.8	25.6	25.7
		1	188	22.3	22.2	21.9	22.1	21.7	21.4	22.1	21.8	21.9	22.7	22.5	22.6
		90	45	25.7	25.7	25.5	25.1	25.1	24.9	25.3	25.5	25.3	24.4	25.6	25.5
		180	0	25.3	25.2	25.1	25.1	25.1	24.7	24.9	25.0	24.9	24.5	25.5	25.6
	QPSK	1	0	22.2	22.3	22.3	22.2	22.1	21.8	22.0	22.2	21.9	22.1	22.2	22.1
		1	1	25.8	25.9	<b>25.9</b>	25.4	25.3	24.9	25.6	<b>25.7</b>	25.5	24.6	<b>25.7</b>	25.6
		1	187	25.9	25.8	25.7	<b>25.4</b>	25.0	24.6	25.6	25.4	25.4	24.8	25.5	25.6
		1	188	22.3	22.3	22.0	22.3	21.7	21.4	22.0	21.9	21.9	22.3	22.1	22.0
		90	45	25.7	25.8	25.6	25.2	25.2	24.8	25.4	25.6	25.4	24.4	25.6	25.6
		180	0	24.7	24.8	24.6	24.5	24.6	24.1	24.3	24.5	24.3	24.6	25.6	25.6
	16QAM	1	0	23.3	22.6	22.2	22.2	22.0	22.2	22.0	22.2	22.1	21.9	22.2	22.1
		1	1	24.8	<b>24.9</b>	24.3	24.4	<b>24.9</b>	24.2	24.7	<b>24.7</b>	24.5	24.4	24.8	24.6
		1	187	24.8	24.9	24.4	24.6	24.3	24.0	24.6	24.4	24.4	24.7	<b>24.9</b>	24.5
		1	188	22.3	22.4	21.7	22.2	21.8	21.5	22.2	21.7	21.9	22.3	21.9	21.6
		90	45	24.7	24.7	24.6	24.5	24.6	24.2	24.4	24.6	24.3	24.5	24.7	24.7
		180	0	23.8	23.7	23.6	23.6	23.5	23.2	23.4	23.5	23.3	24.4	24.2	24.1
	64QAM	1	0	23.0	22.8	22.7	22.2	22.0	21.9	22.6	22.9	22.5	21.7	22.0	21.8
		1	1	<b>24.1</b>	23.9	23.9	23.3	23.0	23.1	23.6	<b>23.8</b>	23.5	23.7	23.8	23.7
		1	187	24.0	24.0	23.6	<b>23.4</b>	22.7	22.7	23.8	23.5	23.6	<b>23.8</b>	23.5	23.4
		1	188	23.1	22.7	22.4	22.2	21.7	21.5	22.5	22.8	22.7	22.3	21.0	21.3
		90	45	23.9	23.8	23.7	23.0	23.0	22.6	23.5	23.7	23.6	23.7	23.6	23.5
		180	0	24.0	23.9	23.8	23.1	23.0	22.6	23.6	23.7	23.5	23.7	23.0	23.0
	256QAM	1	0	22.0	22.1	21.9	21.1	<b>21.6</b>	20.8	21.7	21.7	21.7	21.9	<b>22.2</b>	22.2
		1	1	22.2	21.8	21.9	21.2	21.5	20.8	21.5	21.6	21.3	21.8	22.0	21.8
		1	187	<b>22.2</b>	22.1	21.7	21.0	21.1	20.5	<b>21.8</b>	21.5	21.5	21.9	22.1	22.1
		1	188	22.2	22.0	21.5	21.1	20.7	20.5	21.4	21.5	21.3	22.2	22.1	21.9
		90	45	21.9	21.9	21.8	21.0	21.0	20.6	21.6	21.6	21.4	21.9	22.1	22.0
		180	0	21.9	21.9	21.9	21.1	21.0	20.6	21.5	21.6	21.4	21.9	22.1	22.1

**OUTPUT POWER FOR 5G NR n41 (80.0 MHz)**

Bandwidth (MHz)	Modulation	RB Allocation	RB Offset	Conducted Average (dBm)											
				ANT 2			ANT 0			ANT 1			ANT 5		
				507200	518600	530000	507200	518600	530000	507200	518600	530000	507200	518600	530000
80.0	BPSK	1	0	22.2	22.4	22.2	22.2	22.1	22.0	22.3	22.2	22.0	22.7	22.8	22.7
		1	1	25.9	<b>25.9</b>	25.9	25.2	25.3	25.2	<b>25.9</b>	25.9	25.7	24.8	<b>25.8</b>	25.7
		1	215	25.9	25.8	25.6	<b>25.4</b>	25.0	24.8	25.8	25.7	25.6	24.8	25.7	25.7
		1	216	22.2	22.2	22.0	22.3	21.8	21.6	22.1	22.1	21.8	22.8	22.5	22.7
		108	54	25.8	25.6	25.7	25.1	25.2	24.8	25.7	25.6	25.3	24.7	25.8	25.6
		216	0	25.2	25.2	25.2	25.1	25.0	24.7	25.2	25.0	24.9	24.7	25.7	25.6
	QPSK	1	0	22.2	22.2	22.1	22.2	22.2	22.0	22.3	22.1	22.1	22.2	22.2	22.2
		1	1	25.8	25.8	25.7	<b>25.4</b>	25.3	25.3	<b>25.9</b>	25.9	25.7	24.7	25.8	25.8
		1	215	<b>25.9</b>	25.7	25.5	25.3	25.1	24.8	25.9	25.6	25.6	24.9	25.7	<b>25.8</b>
		1	216	22.2	22.0	21.9	22.2	21.8	21.7	22.1	22.0	21.9	22.2	22.2	22.1
		108	54	25.5	25.5	25.4	25.1	25.1	24.9	25.6	25.7	25.4	24.6	25.8	25.7
		216	0	24.6	24.5	24.4	24.6	24.5	24.2	24.7	24.6	24.4	24.7	25.7	25.6
	16QAM	1	0	22.5	23.1	22.6	22.3	22.1	22.0	22.4	22.3	21.9	22.3	22.7	22.2
		1	1	24.9	<b>25.2</b>	25.1	<b>24.8</b>	24.8	24.4	<b>25.0</b>	24.5	24.5	24.7	25.1	24.9
		1	215	25.0	25.1	24.9	24.7	24.3	24.0	24.8	24.5	24.5	24.8	<b>25.2</b>	24.9
		1	216	22.6	22.7	22.3	22.3	21.6	21.2	22.3	22.1	21.9	21.9	22.6	22.0
		108	54	25.0	24.9	24.9	24.6	24.6	24.2	24.6	24.6	24.4	24.6	24.7	24.6
		216	0	23.9	24.0	23.9	23.6	23.5	23.2	23.7	23.7	23.4	24.7	24.3	24.2
	64QAM	1	0	23.4	23.2	23.1	22.3	22.3	21.8	22.9	22.6	22.7	22.2	22.5	22.3
		1	1	24.3	24.3	24.1	23.2	<b>23.3</b>	23.1	<b>23.8</b>	23.8	23.7	24.0	<b>24.5</b>	24.3
		1	215	<b>24.4</b>	24.2	23.5	23.3	22.9	22.5	23.8	23.6	23.6	24.1	24.5	24.2
		1	216	23.0	23.2	22.7	22.2	22.1	21.6	22.7	22.7	22.6	21.4	21.1	21.3
		108	54	24.0	23.9	23.8	23.1	23.0	22.6	23.7	23.7	23.5	23.9	24.2	24.1
		216	0	24.0	24.0	23.8	23.1	23.1	22.7	23.7	23.6	23.6	23.9	23.7	23.6
	256QAM	1	0	22.1	<b>22.4</b>	21.8	<b>21.7</b>	21.1	21.1	21.8	21.9	21.7	<b>21.7</b>	21.1	21.5
		1	1	22.0	22.3	21.9	21.6	21.4	21.3	21.7	22.0	21.8	21.2	21.2	21.5
		1	215	22.2	22.1	21.8	21.4	21.0	20.9	21.9	<b>22.1</b>	21.8	21.1	21.5	21.5
		1	216	21.9	22.0	21.6	21.4	20.7	20.9	21.8	21.7	21.7	21.5	21.0	21.5
		108	54	21.9	21.8	21.9	20.9	20.9	20.9	21.7	21.6	21.5	21.3	21.2	21.1
		216	0	21.9	21.9	21.7	21.1	21.0	20.7	21.7	21.6	21.6	21.3	21.1	21.1

**OUTPUT POWER FOR 5G NR n41 (90.0 MHz)**

Bandwidth (MHz)	Modulation	RB Allocation	RB Offset	Conducted Average (dBm)											
				ANT 2			ANT 0			ANT 1			ANT 5		
				508200 2541.0	518600 2593.0	529000 2645.0	508200 2541.0	518600 2593.0	529000 2645.0	508200 2541.0	518600 2593.0	529000 2645.0	508200 2541.0	518600 2593.0	529000 2645.0
90.0	BPSK	1	0	22.2	22.3	22.0	22.2	22.1	22.0	22.2	22.2	21.9	22.5	22.5	22.6
		1	1	<b>25.9</b>	25.9	25.7	25.5	25.4	25.3	25.8	<b>25.8</b>	25.7	24.7	25.6	<b>25.7</b>
		1	243	25.8	25.8	25.5	<b>25.5</b>	25.0	24.8	25.7	25.7	25.7	24.6	25.6	25.6
		1	244	22.1	22.1	21.9	22.1	21.9	21.6	22.1	22.0	21.9	22.5	22.5	22.4
		120	60	25.6	25.5	25.6	25.1	25.1	24.8	25.6	25.6	25.4	24.5	25.4	25.5
		243	0	25.2	25.1	25.1	25.1	25.1	24.7	25.1	25.1	24.9	24.6	25.5	25.5
	QPSK	1	0	22.2	<b>22.2</b>	22.1	22.3	22.1	22.1	22.2	<b>22.3</b>	21.8	22.0	<b>22.0</b>	22.0
		1	1	25.9	<b>25.9</b>	25.7	<b>25.5</b>	25.4	25.3	25.9	<b>25.9</b>	25.6	24.5	<b>25.6</b>	25.6
		1	243	25.8	25.8	25.5	25.5	25.1	24.9	25.8	25.8	25.5	24.7	<b>25.6</b>	25.6
		1	244	22.2	22.2	21.8	22.3	21.7	21.6	22.1	22.1	21.9	21.9	21.9	21.9
		120	60	25.6	25.6	25.5	25.1	25.2	24.9	25.6	25.6	25.4	24.4	25.4	25.5
		243	0	24.7	24.6	24.5	24.6	24.5	24.3	24.6	24.6	24.4	24.6	25.6	25.6
	16QAM	1	0	22.6	22.5	22.2	22.1	22.0	22.2	22.4	22.2	22.1	22.1	22.0	21.8
		1	1	24.9	<b>25.3</b>	25.0	24.7	<b>25.0</b>	24.6	25.2	<b>25.2</b>	24.9	24.1	<b>25.1</b>	25.0
		1	243	25.1	25.2	25.0	24.8	24.6	24.2	25.1	24.8	24.9	24.0	<b>25.1</b>	25.0
		1	244	22.6	22.6	22.3	21.8	21.7	21.5	22.2	22.2	22.2	22.1	22.0	21.5
		120	60	25.0	24.9	24.8	24.6	24.6	24.2	24.7	24.7	24.6	23.8	24.3	24.3
		243	0	24.0	23.9	23.9	23.6	23.5	23.3	23.9	23.7	23.6	23.9	23.8	23.8
	64QAM	1	0	22.9	23.2	22.8	22.2	22.2	21.9	23.2	22.8	22.5	21.5	21.3	21.3
		1	1	<b>24.4</b>	24.2	23.8	<b>23.5</b>	23.0	23.1	<b>24.3</b>	24.1	23.8	23.5	23.9	24.2
		1	243	24.0	24.2	24.0	23.2	22.7	22.8	23.9	23.8	23.9	23.4	23.7	23.8
		1	244	22.7	22.7	23.0	22.2	21.9	21.6	22.6	22.5	22.6	21.2	21.1	21.1
		120	60	23.8	23.8	23.8	23.0	23.0	22.7	23.7	23.8	23.5	24.0	<b>24.2</b>	24.1
		243	0	24.0	23.9	23.8	23.2	23.0	22.8	23.7	23.8	23.5	23.9	23.9	24.0
	256QAM	1	0	22.0	22.1	22.0	21.3	21.3	21.0	22.1	22.0	21.9	22.1	21.8	<b>22.1</b>
		1	1	<b>22.3</b>	22.1	22.1	21.4	<b>21.5</b>	21.1	<b>22.4</b>	22.1	21.8	21.9	22.0	<b>22.1</b>
		1	243	22.0	22.0	21.8	21.4	21.1	21.0	21.7	21.9	21.8	22.0	21.9	22.0
		1	244	22.1	21.9	21.7	21.3	20.9	20.5	21.8	21.8	21.8	22.0	21.7	21.9
		120	60	22.0	21.8	21.8	21.0	21.0	20.7	21.6	21.6	21.5	21.9	22.0	22.0
		243	0	22.0	21.9	21.7	21.1	20.9	20.7	21.7	21.6	21.5	21.9	22.0	21.9

**OUTPUT POWER FOR 5G NR n41 (100.0 MHz)**

Bandwidth (MHz)	Modulation	RB Allocation	RB Offset	Conducted Average (dBm)											
				ANT 2			ANT 0			ANT 1			ANT 5		
				509200 2546.0	528600 2593.0	528000 2640.0	509200 2546.0	528600 2593.0	528000 2640.0	509200 2546.0	528600 2593.0	528000 2640.0	509200 2546.0	528600 2593.0	528000 2640.0
100.0	BPSK	1	0	22.2	22.2	22.0	21.5	21.4	21.3	21.9	21.8	21.7	22.5	22.2	22.3
		1	1	25.9	<b>25.9</b>	25.9	<b>25.4</b>	25.2	25.1	<b>25.8</b>	25.6	25.5	24.6	25.5	25.7
		1	271	25.8	25.9	25.7	25.1	25.1	25.0	25.5	25.5	25.4	24.6	<b>25.7</b>	25.6
		1	272	22.1	22.1	21.9	21.4	21.2	21.2	21.8	21.6	21.6	22.4	22.5	22.3
		135	67	25.7	25.6	25.5	25.0	24.9	24.7	25.4	25.3	25.1	24.5	25.5	25.6
		270	0	25.2	25.2	25.1	24.6	24.4	24.4	25.0	24.8	24.8	24.6	25.5	25.6
	QPSK	1	0	22.3	22.1	22.1	21.5	21.4	21.5	21.9	21.8	21.9	21.8	21.8	21.9
		1	1	25.9	<b>25.9</b>	25.9	<b>25.3</b>	25.2	25.2	<b>25.7</b>	25.6	25.6	24.7	25.6	<b>25.7</b>
		1	271	25.8	25.8	25.6	25.1	25.0	25.1	25.5	25.4	25.5	24.6	25.7	25.7
		1	272	22.2	22.1	21.9	21.4	21.2	21.2	21.8	21.6	21.6	21.9	22.0	21.9
		135	67	25.7	25.7	25.6	25.1	25.0	24.7	25.5	25.4	25.1	24.5	25.5	25.5
		270	0	24.7	24.7	24.6	24.0	23.9	23.7	24.4	24.3	24.1	24.4	25.6	25.6
	16QAM	1	0	22.5	22.6	22.6	22.0	22.0	22.0	22.3	22.4	22.0	21.8	22.0	22.0
		1	1	25.1	25.2	25.2	24.6	24.6	<b>24.7</b>	25.0	24.9	<b>25.0</b>	23.7	24.6	<b>24.9</b>
		1	271	<b>25.2</b>	25.1	25.1	<b>24.7</b>	24.4	24.4	25.0	24.8	25.0	23.7	24.7	24.5
		1	272	22.4	22.5	22.4	22.1	21.6	21.3	22.2	22.0	21.9	21.9	21.9	21.4
		135	67	24.9	25.0	24.9	24.7	24.6	24.2	24.9	24.9	24.7	23.7	24.7	24.7
		270	0	24.0	24.0	23.8	23.7	23.6	23.4	23.9	23.8	23.7	23.7	24.2	24.3
	64QAM	1	0	22.9	23.0	22.8	22.2	22.1	22.2	22.9	22.7	22.8	21.8	21.9	21.9
		1	1	24.2	24.1	23.8	<b>23.4</b>	23.4	23.2	<b>24.1</b>	23.9	23.9	23.8	24.2	<b>24.3</b>
		1	271	<b>24.4</b>	23.8	24.1	23.3	22.9	22.7	23.9	23.7	23.6	23.8	24.1	24.1
		1	272	23.0	22.6	22.6	22.0	21.9	21.4	22.6	22.5	22.5	21.2	21.2	21.3
		135	67	23.9	23.8	23.8	23.1	23.0	22.8	23.7	23.7	23.6	23.6	24.2	24.0
		270	0	23.9	23.9	23.7	23.1	23.0	22.9	23.8	23.7	23.5	23.7	23.7	23.8
	256QAM	1	0	21.7	21.9	22.1	21.5	21.1	21.2	22.1	21.7	21.5	22.2	21.7	22.1
		1	1	22.2	<b>22.3</b>	21.7	21.2	21.2	21.4	<b>22.2</b>	21.7	22.1	<b>22.2</b>	21.9	22.1
		1	271	22.0	22.2	22.1	<b>21.5</b>	21.3	20.5	22.0	21.6	21.9	22.2	22.1	22.1
		1	272	22.0	22.0	21.8	20.9	20.8	20.4	21.9	21.8	21.8	22.0	22.0	22.0
		135	67	21.8	21.7	21.7	21.0	21.0	20.7	21.6	21.7	21.5	22.0	22.0	22.0
		270	0	21.9	21.9	21.7	21.0	21.0	20.9	21.8	21.7	21.5	21.8	22.0	22.1

### 8.13. LTE BAND 48 AND 5G NR n48

#### LTE BAND 48

Test Engineer ID:	50813CM	Test Date:	2024-03-25
-------------------	---------	------------	------------

#### OUTPUT POWER FOR LTE BAND 48 (5.0 MHz)

Bandwidth (MHz)	Modulation	RB Allocation	RB Offset	Conducted Average (dBm)					
				ANT 6			ANT 7		
				55265	55990	56715	55260	55990	56715
5.0	QPSK	1	0	21.5	21.5	21.6	22.9	22.9	22.9
		1	12	21.4	21.5	21.5	22.8	22.8	22.8
		1	24	21.5	21.5	21.6	22.9	22.9	22.9
		12	0	21.5	21.5	21.6	21.9	21.9	21.9
		12	6	21.5	21.5	21.6	21.9	21.9	21.9
		12	11	21.5	21.5	21.6	21.9	21.9	21.9
		25	0	21.5	21.5	21.6	21.9	21.9	21.9
		25	0	21.5	21.5	21.6	21.9	21.9	21.9
	16QAM	1	0	21.2	21.4	21.4	22.4	22.5	22.3
		1	12	21.1	21.3	21.2	22.3	22.4	22.1
		1	24	21.3	21.5	21.4	22.4	22.4	22.3
		12	0	21.4	21.5	21.6	20.9	20.9	20.9
		12	6	21.4	21.5	21.6	20.9	20.9	20.9
		12	11	21.4	21.5	21.6	20.9	20.9	20.9
		25	0	21.5	21.5	21.6	20.9	20.9	20.9
		25	0	21.5	21.5	21.6	20.9	20.9	20.9
	64QAM	1	0	21.3	21.4	21.6	21.5	21.4	21.6
		1	12	21.3	21.4	21.6	21.5	21.2	21.5
		1	24	21.3	21.3	21.5	21.5	21.3	21.5
		12	0	20.7	20.8	20.8	19.8	19.9	20.0
		12	6	20.7	20.7	20.8	19.8	19.9	19.9
		12	11	20.7	20.8	20.8	19.8	19.9	19.9
		25	0	20.7	20.7	20.8	19.8	19.9	19.9
		25	0	20.7	20.7	20.8	19.8	19.9	19.9
	256QAM	1	0	19.2	19.3	19.4	18.4	18.5	18.5
		1	12	19.1	19.2	19.4	18.4	18.4	18.5
		1	24	19.3	19.3	19.4	18.4	18.5	18.5
		12	0	19.2	19.2	19.4	18.3	18.4	18.4
		12	6	19.2	19.3	19.4	18.3	18.4	18.4
		12	11	19.2	19.3	19.4	18.3	18.4	18.4
		25	0	19.2	19.2	19.3	18.3	18.3	18.4
		25	0	19.2	19.2	19.3	18.3	18.3	18.4

#### OUTPUT POWER FOR LTE BAND 48 (10.0 MHz)

Bandwidth (MHz)	Modulation	RB Allocation	RB Offset	Conducted Average (dBm)					
				ANT 6			ANT 7		
				55290	55990	56690	55290	55990	56690
10.0	QPSK	1	0	21.5	21.7	21.6	22.9	23.0	22.9
		1	24	21.3	21.5	21.7	22.7	22.9	23.0
		1	49	21.5	21.7	21.6	22.8	23.0	23.0
		25	0	21.5	21.7	21.6	21.9	22.0	21.9
		25	12	21.5	21.7	21.6	21.9	22.0	21.9
		25	24	21.5	21.7	21.6	21.9	22.0	21.9
		50	0	21.5	21.7	21.6	21.9	22.0	21.9
		50	0	21.5	21.7	21.6	21.9	22.0	21.9
	16QAM	1	0	21.4	21.6	21.2	22.5	22.7	22.3
		1	24	21.4	21.7	21.3	22.5	22.7	22.3
		1	49	21.4	21.6	21.1	22.5	22.7	22.2
		25	0	21.3	21.5	21.4	20.9	21.0	20.9
		25	12	21.3	21.5	21.4	20.8	21.0	20.9
		25	24	21.3	21.5	21.4	20.8	21.0	20.9
		50	0	21.3	21.6	21.4	20.9	21.0	20.8
		50	0	21.3	21.6	21.4	20.9	21.0	20.8
	64QAM	1	0	21.0	21.3	21.3	21.2	21.4	21.2
		1	24	20.9	21.2	21.2	21.1	21.3	21.1
		1	49	21.1	21.4	21.4	21.3	21.5	21.3
		25	0	20.8	21.0	21.0	19.9	20.0	20.0
		25	12	20.8	21.1	21.0	19.8	20.0	20.0
		25	24	20.8	21.0	21.0	19.8	20.0	20.0
		50	0	20.8	21.0	21.0	19.8	20.0	19.9
		50	0	20.8	21.0	21.0	19.8	20.0	19.9
	256QAM	1	0	19.4	19.5	19.4	18.2	18.5	18.4
		1	24	19.5	19.7	19.5	18.4	18.7	18.5
		1	49	19.4	19.5	19.4	18.3	18.5	18.4
		25	0	19.3	19.5	19.5	18.3	18.5	18.5
		25	12	19.3	19.5	19.5	18.3	18.5	18.5
		25	24	19.3	19.5	19.5	18.3	18.5	18.4
		50	0	19.3	19.5	19.5	18.3	18.5	18.4
		50	0	19.3	19.5	19.5	18.3	18.5	18.4

**OUTPUT POWER FOR LTE BAND 48 (15.0 MHz)**

Bandwidth (MHz)	Modulation	RB Allocation	RB Offset	Conducted Average (dBm)					
				ANT 6			ANT 7		
				55315	55990	56665	55315	55990	56665
15.0	QPSK	1	0	21.5	21.7	21.6	22.9	23.0	23.0
		1	37	21.4	21.6	21.6	22.8	22.9	22.8
		1	74	21.5	<b>21.8</b>	21.6	23.0	<b>23.0</b>	23.0
		36	0	21.5	21.7	21.6	21.9	21.9	21.9
		36	16	21.5	21.7	21.6	21.8	21.9	21.9
		36	35	21.5	21.7	21.6	21.9	21.9	21.9
		75	0	21.5	21.7	21.6	21.9	21.9	21.9
	16QAM	1	0	21.4	21.7	21.5	22.4	22.1	22.5
		1	37	21.1	21.4	20.9	22.2	<b>22.5</b>	22.4
		1	74	21.0	21.6	21.5	22.4	22.4	22.4
		36	0	21.5	<b>21.8</b>	21.6	20.9	20.9	20.9
		36	16	21.4	21.7	21.6	20.9	20.9	20.9
		36	35	21.5	21.8	21.6	20.9	20.9	20.9
		75	0	21.5	21.7	21.6	20.9	20.9	20.9
	64QAM	1	0	21.5	21.4	21.7	21.4	21.3	21.1
		1	37	21.4	<b>21.8</b>	21.6	21.0	21.1	21.4
		1	74	21.5	21.3	21.4	21.4	<b>21.5</b>	21.4
		36	0	21.0	21.2	21.2	19.9	19.9	20.0
		36	16	21.0	21.2	21.2	19.9	19.9	19.9
		36	35	21.0	21.2	21.2	19.9	19.9	20.0
		75	0	21.0	21.2	21.2	19.8	19.9	20.0
	256QAM	1	0	19.9	19.5	19.6	18.4	18.6	<b>18.6</b>
		1	37	19.6	19.8	<b>20.0</b>	18.3	18.3	18.5
		1	74	19.6	19.7	19.9	18.3	18.4	18.3
36		0	19.4	19.7	19.6	18.3	18.3	18.4	
36		16	19.5	19.7	19.6	18.3	18.4	18.4	
36		35	19.4	19.7	19.6	18.3	18.3	18.4	
75		0	19.5	19.7	19.7	18.3	18.4	18.4	

**OUTPUT POWER FOR LTE BAND 48 (20.0 MHz)**

Bandwidth (MHz)	Modulation	RB Allocation	RB Offset	Conducted Average (dBm)					
				ANT 6			ANT 7		
				55340	55990	56640	55340	55990	56640
20.0	QPSK	1	0	21.7	21.8	21.8	22.8	22.9	22.8
		1	49	21.7	21.8	21.8	22.8	<b>23.0</b>	22.9
		1	99	21.6	<b>22.1</b>	21.7	22.8	22.9	22.8
		50	0	21.7	21.8	21.8	21.8	21.9	21.8
		50	24	21.7	21.8	21.8	21.8	21.9	21.8
		50	49	21.7	21.9	21.7	21.8	21.9	21.8
		100	0	21.7	21.8	21.8	21.8	21.9	21.8
	16QAM	1	0	21.4	<b>22.0</b>	21.8	<b>22.7</b>	22.5	22.1
		1	49	21.7	21.9	21.8	22.5	22.6	22.5
		1	99	21.6	21.6	21.7	22.6	22.6	22.1
		50	0	21.6	21.7	21.6	20.9	21.0	20.9
		50	24	21.6	21.7	21.5	20.8	20.9	20.9
		50	49	21.6	21.8	21.6	20.9	20.9	20.9
		100	0	21.5	21.8	21.6	20.9	20.9	20.9
	64QAM	1	0	21.4	21.7	21.6	21.4	21.8	21.5
		1	49	21.5	<b>21.9</b>	21.7	21.8	21.8	21.6
		1	99	21.5	21.9	21.5	21.3	<b>21.9</b>	21.4
		50	0	21.0	21.1	21.0	19.9	20.0	20.0
		50	24	21.0	21.1	21.0	19.9	20.1	20.0
		50	49	21.0	21.1	21.0	19.9	20.0	20.0
		100	0	21.0	21.1	21.0	19.9	20.0	20.0
	256QAM	1	0	19.3	19.5	19.7	18.7	18.4	18.6
		1	49	19.8	19.8	19.9	18.3	18.6	18.3
		1	99	19.6	<b>19.9</b>	19.6	18.7	<b>19.0</b>	18.6
50		0	19.4	19.5	19.5	18.4	18.5	18.5	
50		24	19.4	19.5	19.5	18.4	18.5	18.5	
50		49	19.5	19.6	19.5	18.4	18.5	18.5	
100		0	19.4	19.5	19.5	18.4	18.5	18.5	



**5G NR n48**

<b>Test Engineer ID:</b>	19210AL and 27966PV	<b>Test Date:</b>	2024-02-29 to 2024-03-06
--------------------------	---------------------	-------------------	--------------------------

**OUTPUT POWER FOR 5G NR n48 (10.0 MHz)**

Bandwidth (MHz)	Modulation	RB Allocation	RB Offset	Conducted Average (dBm)													
				ANT 6			ANT 7			ANT 1			ANT 5				
				637000	641666	646333	637000	641666	646333	637000	641666	646333	637000	641666	646333		
10.0	BPSK	1	0	22.0	21.9	21.8	21.7	21.6	21.5	21.4	21.4	21.6	21.5	21.6	21.6	21.9	21.7
		1	1	21.8	21.9	21.9	21.7	21.6	21.6	21.6	21.4	21.5	21.5	21.6	21.6	21.9	21.7
		1	22	21.8	21.9	21.9	21.8	21.6	21.5	21.3	21.6	21.5	21.6	21.5	21.6	21.9	21.8
		1	23	22.0	21.9	21.9	21.9	21.7	21.4	21.3	21.6	21.6	21.7	21.6	21.7	21.8	21.7
		12	6	21.9	22.0	21.8	21.7	21.7	21.4	21.3	21.6	21.6	21.6	21.6	21.6	21.7	21.8
		24	0	21.8	22.0	21.8	21.7	21.7	21.5	21.4	21.5	21.6	21.6	21.6	21.6	21.8	21.7
	QPSK	1	0	22.0	21.9	21.9	21.7	21.6	21.5	21.2	21.6	21.6	21.7	21.8	21.8	21.8	21.8
		1	1	21.8	21.9	21.9	21.8	21.7	21.6	21.3	21.5	21.6	21.7	21.8	21.8	21.8	21.8
		1	22	21.9	21.9	21.8	21.8	21.7	21.4	21.2	21.6	21.5	21.7	21.9	21.8	21.8	21.8
		1	23	21.8	21.9	21.9	21.7	21.5	21.5	21.2	21.6	21.6	21.6	21.9	21.9	21.7	21.7
		12	6	21.9	21.8	21.8	21.7	21.6	21.4	21.3	21.5	21.6	21.7	21.8	21.8	21.7	21.7
		24	0	21.9	21.8	21.8	21.8	21.6	21.5	21.3	21.6	21.4	21.7	21.8	21.8	21.7	21.7
	16QAM	1	0	21.4	21.7	21.7	21.4	21.5	21.3	21.1	21.1	21.2	21.4	21.5	21.4	21.5	21.4
		1	1	21.3	21.4	21.5	21.4	21.1	21.0	21.1	21.5	21.2	21.5	21.6	21.5	21.5	21.5
		1	22	21.8	21.6	21.8	21.5	21.4	21.0	21.0	21.6	21.0	21.6	21.4	21.4	21.4	21.4
		1	23	21.2	21.8	21.4	21.4	21.1	21.0	20.9	21.0	21.1	21.5	21.4	21.6	21.6	21.6
		12	6	21.4	21.4	21.3	21.5	21.3	21.1	21.0	21.3	21.3	21.2	21.4	21.6	21.6	21.6
		24	0	21.5	21.5	21.5	21.4	21.4	21.1	21.1	21.2	21.3	21.2	21.3	21.2	21.3	21.4
	64QAM	1	0	21.4	21.4	21.2	21.5	21.1	21.3	20.9	21.5	21.4	21.4	21.2	21.0	21.4	21.4
		1	1	21.3	21.5	21.2	21.5	21.2	21.2	21.4	21.3	21.0	21.2	21.5	21.5	21.5	21.5
		1	22	21.5	21.4	21.9	21.6	21.2	21.3	20.9	21.3	21.1	21.1	21.3	21.3	21.6	21.6
		1	23	21.3	21.3	21.7	21.5	21.2	21.0	20.9	21.4	21.7	21.2	21.3	21.3	21.4	21.4
		12	6	21.5	21.5	21.4	21.3	21.2	21.1	21.0	21.3	21.4	21.3	21.3	21.5	21.6	21.6
		24	0	21.4	21.4	21.6	21.4	21.2	21.1	21.0	21.1	21.3	21.4	21.4	21.4	21.5	21.5
256QAM	1	0	19.9	19.8	19.7	19.3	19.1	19.5	19.3	19.4	19.8	19.4	19.6	19.6	21.6	21.6	
	1	1	19.8	20.0	20.0	19.4	19.4	19.5	19.5	19.5	19.8	19.7	19.3	21.6	21.6	21.6	
	1	22	20.0	19.9	19.8	19.2	19.1	19.3	19.3	19.9	19.7	19.6	19.6	21.5	21.5	21.5	
	1	23	20.4	19.9	19.9	19.3	19.4	19.5	19.5	19.3	19.8	19.3	19.3	21.5	21.5	21.5	
	12	6	20.0	20.0	20.0	19.4	19.2	19.2	19.5	19.7	19.8	19.4	19.4	21.5	21.5	21.5	
	24	0	19.9	19.9	20.0	19.3	19.2	19.2	19.5	19.7	19.8	19.4	19.5	21.6	21.6	21.6	

**OUTPUT POWER FOR 5G NR n48 (15.0 MHz)**

Bandwidth (MHz)	Modulation	RB Allocation	RB Offset	Conducted Average (dBm)												
				ANT 6			ANT 7			ANT 1			ANT 5			
				637166	641333	646166	637166	641333	646166	637166	641333	646166	637166	641333	646166	
15.0	BPSK	1	0	21.9	21.7	21.9	21.6	21.6	21.6	21.4	21.5	21.5	21.6	21.7	21.6	21.6
		1	1	22.0	21.8	21.8	21.7	21.6	21.5	21.4	21.5	21.5	21.6	21.7	21.8	21.8
		1	36	21.8	21.9	21.9	21.7	21.5	21.6	21.3	21.6	21.5	21.5	21.8	21.7	21.7
		1	37	21.9	21.9	21.8	21.9	21.6	21.5	21.3	21.7	21.5	21.6	21.9	21.7	21.7
		18	9	21.8	21.8	21.7	21.7	21.6	21.7	21.3	21.5	21.6	21.5	21.8	21.6	21.6
		36	0	21.8	21.9	21.8	21.7	21.7	21.6	21.2	21.5	21.5	21.6	21.8	21.6	21.6
	QPSK	1	0	21.9	21.9	21.7	21.8	21.7	21.6	21.3	21.6	21.5	21.6	21.7	21.6	21.6
		1	1	21.8	22.0	21.7	21.7	21.6	21.5	21.4	21.5	21.5	21.5	21.7	21.6	21.6
		1	36	21.8	21.9	21.8	21.9	21.6	21.5	21.3	21.6	21.4	21.4	21.5	21.7	21.6
		1	37	21.9	21.8	21.8	21.7	21.6	21.6	21.2	21.7	21.4	21.4	21.8	21.6	21.6
		18	9	21.7	21.9	21.7	21.7	21.7	21.5	21.3	21.5	21.5	21.6	21.8	21.7	21.7
		36	0	21.8	21.8	21.8	21.8	21.6	21.7	21.3	21.5	21.4	21.5	21.8	21.6	21.6
	16QAM	1	0	21.4	21.6	21.4	21.3	21.2	21.5	20.9	21.1	21.0	21.1	21.4	21.4	21.4
		1	1	21.7	21.7	21.4	21.4	21.3	21.5	20.9	21.3	21.3	21.2	21.4	21.3	21.3
		1	36	21.5	21.7	21.5	21.3	21.3	21.1	20.9	21.3	21.4	21.3	21.4	21.1	21.1
		1	37	21.8	21.8	21.5	21.0	21.2	21.1	21.0	21.1	21.0	21.2	21.5	21.5	21.5
		18	9	21.6	21.7	21.6	21.5	21.3	21.3	21.0	21.3	21.2	21.2	21.4	21.3	21.3
		36	0	21.6	21.7	21.6	21.4	21.3	21.3	20.9	21.2	21.2	21.2	21.5	21.3	21.3
	64QAM	1	0	21.7	21.8	21.5	21.3	21.4	21.0	21.1	21.2	21.4	21.0	21.5	21.5	21.5
		1	1	21.9	21.9	21.5	21.4	21.5	21.1	21.2	21.2	21.5	21.3	21.5	21.5	21.5
		1	36	21.4	22.1	21.5	21.6	21.1	21.2	21.2	21.2	20.9	21.1	21.3	21.5	21.5
		1	37	22.0	21.7	21.7	21.1	21.3	21.1	21.0	21.0	21.5	21.1	21.2	21.6	21.6
		18	9	21.7	21.6	21.5	21.4	21.3	21.3	21.1	21.2	21.2	21.1	21.6	21.3	21.3
		36	0	21.6	21.7	21.6	21.4	21.4	21.2	21.0	21.2	21.3	21.3	21.4	21.2	21.2
256QAM	1	0	20.0	20.2	20.4	19.6	19.6	19.4	19.6	19.6	20.2	19.2	19.3	19.3	19.3	
	1	1	20.4	20.4	20.2	19.2	19.5	19.3	19.6	19.8	20.0	19.3	19.2	19.1	19.1	
	1	36	20.1	20.2	20.3	19.3	19.4	19.1	19.4	19.9	20.0	19.0	19.5	19.5	19.5	
	1	37	19.9	20.2	19.9	19.3	19.4	19.2	19.4	19.9	19.7	19.2	19.1	19.3	19.3	
	18	9	20.2	20.2	20.1	19.4	19.3	19.2	19.6	19.6	19.9	19.3	19.4	19.4	19.4	
	36	0	20.1	20.1	20.1	19.4	19.3	19.2	19.5	19.7	19.7	19.3	19.5	19.3	19.3	



**OUTPUT POWER FOR 5G NR n48 (20.0 MHz)**

Bandwidth (MHz)	Modulation	RB Allocation	RB Offset	Conducted Average (dBm)												
				ANT 6			ANT 7			ANT 1			ANT 5			
				637333	641333	646000	637333	641333	646000	637333	641333	646000	637333	641333	646000	
20.0	BPSK	1	0	21.8	21.9	21.7	21.8	21.7	21.6	21.4	21.6	21.6	21.6	21.7	21.8	
		1	1	21.8	21.8	21.7	21.8	21.7	21.6	21.5	21.5	21.5	21.5	21.6	21.8	21.8
		1	49	21.7	21.9	21.9	21.8	21.7	21.5	21.3	21.7	21.6	21.5	21.5	21.8	21.8
		1	50	21.9	21.9	21.8	21.7	21.9	21.5	21.3	21.6	21.6	21.5	21.5	21.7	21.7
		25	12	21.9	21.7	21.8	21.8	21.8	21.5	21.3	21.5	21.5	21.5	21.6	21.8	21.7
		50	0	21.9	21.8	21.7	21.7	21.7	21.5	21.4	21.5	21.5	21.5	21.5	21.8	21.7
	QPSK	1	0	21.9	21.7	21.7	21.8	21.7	21.5	21.2	21.5	21.6	21.6	21.6	21.6	21.8
		1	1	21.8	21.7	21.6	21.8	21.7	21.5	21.4	21.5	21.7	21.7	21.7	21.9	21.9
		1	49	21.7	21.8	21.7	21.8	21.7	21.5	21.2	21.6	21.7	21.5	21.6	21.7	21.7
		1	50	21.9	21.8	21.7	21.7	21.8	21.6	21.3	21.6	21.6	21.6	21.4	21.8	21.7
		25	12	21.9	21.9	21.7	21.8	21.6	21.5	21.3	21.5	21.6	21.6	21.6	21.7	21.6
		50	0	21.9	21.8	21.6	21.8	21.7	21.5	21.2	21.6	21.5	21.5	21.5	21.8	21.7
	16QAM	1	0	21.5	21.4	21.5	21.5	21.9	21.0	21.5	21.2	21.2	21.1	21.5	21.2	
		1	1	21.5	21.6	21.3	21.7	21.8	21.1	21.0	21.2	21.2	21.1	21.3	21.3	
		1	49	21.4	21.5	21.4	21.5	21.8	21.0	21.1	21.2	21.1	21.0	21.4	21.2	
		1	50	21.6	21.6	21.6	21.9	21.8	21.1	21.2	21.2	21.4	21.1	21.4	21.2	
		25	12	21.6	21.5	21.4	21.5	21.3	21.2	21.0	21.3	21.3	21.3	21.4	21.4	
		50	0	21.6	21.6	21.5	21.5	21.3	21.2	20.9	21.2	21.3	21.3	21.4	21.4	
	64QAM	1	0	21.6	21.5	21.5	21.4	20.9	21.3	21.4	21.1	21.2	21.1	21.1	21.5	
		1	1	21.2	21.4	21.5	21.3	21.5	21.4	21.0	21.0	21.1	21.1	21.3	21.3	
		1	49	21.4	21.5	21.5	21.3	21.2	21.1	21.1	21.3	21.3	21.2	21.3	21.3	
		1	50	21.8	21.5	21.8	21.5	21.3	21.4	21.0	21.1	21.2	21.2	21.3	21.2	
		25	12	21.6	21.5	21.4	21.5	21.3	21.2	20.9	21.3	21.3	21.2	21.5	21.3	
		50	0	21.4	21.6	21.4	21.5	21.3	21.2	20.9	21.2	21.3	21.2	21.4	21.3	
	256QAM	1	0	20.4	20.2	20.0	19.6	19.2	19.3	19.8	19.9	19.6	19.6	19.3	19.2	
		1	1	20.2	20.1	19.9	20.0	19.1	19.5	19.7	19.5	19.7	19.5	19.0	19.3	
		1	49	20.2	20.1	19.7	19.4	19.2	19.2	19.6	19.7	19.9	19.4	19.1	19.1	
		1	50	20.0	19.9	20.0	19.6	19.5	19.2	19.7	20.0	19.6	19.4	19.1	18.9	
		25	12	20.0	19.9	19.9	19.5	19.4	19.3	19.4	19.7	19.8	19.2	19.4	19.3	
		50	0	20.1	20.0	20.0	19.5	19.4	19.2	19.6	19.7	19.8	19.3	19.5	19.3	

**OUTPUT POWER FOR 5G NR n48 (30.0 MHz)**

Bandwidth (MHz)	Modulation	RB Allocation	RB Offset	Conducted Average (dBm)											
				ANT 6			ANT 7			ANT 1			ANT 5		
				637666	641666	645666	637666	641666	645666	637666	641666	645666	637666	641666	645666
30.0	BPSK	1	0	13.9	20.7	14.2	13.8	20.7	13.7	13.5	20.2	13.4	13.2	20.0	13.2
		1	1	13.8	20.7	14.2	13.8	20.7	13.9	13.6	20.2	13.4	13.1	20.0	13.2
		1	76	13.8	20.9	14.2	14.0	20.4	13.8	13.5	20.1	13.6	13.3	19.9	13.2
		1	77	13.9	20.9	14.3	13.9	20.4	13.8	13.7	20.1	13.6	13.4	20.1	13.2
		36	18	13.7	20.9	14.2	14.0	21.9	13.8	13.7	21.2	13.6	13.4	21.9	13.2
		75	0	13.8	21.9	14.2	14.0	20.6	13.7	13.7	20.2	13.6	13.3	20.0	13.2
	QPSK	1	0	14.0	20.7	14.2	13.9	20.6	13.8	13.2	20.3	13.6	13.1	19.8	13.1
		1	1	13.8	20.6	14.0	14.0	20.6	13.8	13.4	20.2	13.6	13.1	19.8	13.2
		1	76	13.8	20.9	14.1	14.1	20.4	13.7	13.6	20.1	13.6	13.4	19.9	13.2
		1	77	13.8	20.8	14.3	14.0	20.3	13.8	13.7	20.1	13.6	13.3	19.9	13.1
		36	18	13.7	21.9	14.2	13.9	21.9	13.8	13.7	21.2	13.6	13.5	21.5	13.2
		75	0	13.8	20.9	14.2	14.0	20.6	13.7	13.7	20.2	13.6	13.4	20.0	13.2
	16QAM	1	0	13.5	20.7	13.7	13.5	20.6	13.4	13.1	20.2	13.0	12.6	19.8	12.7
		1	1	13.4	20.5	13.7	13.5	20.4	13.4	13.1	20.1	13.0	12.7	19.8	12.9
		1	76	13.4	20.8	13.8	13.6	20.4	13.5	13.3	19.9	13.2	12.9	19.8	12.9
		1	77	13.4	20.8	13.8	13.6	20.2	13.3	13.4	20.2	13.0	12.8	19.8	12.7
		36	18	13.3	21.8	13.8	13.4	21.6	13.5	13.2	21.1	13.2	12.9	21.5	12.9
		75	0	13.4	20.8	13.7	13.4	20.5	13.2	13.2	20.1	13.1	12.8	19.9	12.7
	64QAM	1	0	13.4	20.5	13.7	13.3	20.6	13.5	13.0	20.2	13.0	12.4	19.9	12.5
		1	1	13.3	20.4	13.6	13.4	20.5	13.6	13.1	20.2	12.8	12.6	20.0	12.7
		1	76	13.3	20.7	13.5	13.6	20.5	13.5	13.2	20.0	12.9	12.8	20.0	12.8
		1	77	13.4	20.7	13.7	13.6	20.4	13.5	13.4	20.0	12.9	12.5	20.0	12.7
		36	18	13.3	21.8	13.7	13.5	21.5	13.5	13.2	21.1	12.9	12.8	21.5	12.8
		75	0	13.3	20.8	13.7	13.4	20.5	13.2	13.2	20.1	12.9	12.7	20.0	12.6
	256QAM	1	0	13.2	20.2	13.5	13.2	20.2	13.2	12.9	19.7	12.9	12.5	19.6	12.8
		1	1	13.1	20.2	13.5	13.3	20.2	13.2	12.9	19.6	12.9	12.7	19.6	12.8
		1	76	13.1	20.4	13.6	13.4	20.1	13.2	13.1	19.5	13.0	12.9	19.6	12.9
		1	77	13.1	20.4	13.6	13.4	20.1	13.0	13.1	19.5	13.0	12.8	19.6	12.8
		36	18	13.3	20.4	13.6	13.5	20.0	13.2	13.2	19.7	13.0	12.9	19.5	12.8
		75	0	13.3	20.4	13.6	13.5	20.0	13.2	13.1	19.7	13.1	12.8	19.5	12.6

**OUTPUT POWER FOR 5G NR n48 (40.0 MHz)**

Bandwidth (MHz)	Modulation	RB Allocation	RB Offset	Conducted Average (dBm)											
				ANT 6			ANT 7			ANT 1			ANT 5		
				638000	641333	645333	638000	641333	645333	638000	641333	645333	638000	641333	645333
40.0	BPSK	1	0	13.9	21.7	14.2	13.9	20.6	13.9	13.5	21.2	13.5	13.1	21.9	13.4
		1	1	13.9	21.6	14.1	14.0	20.6	14.0	13.7	21.2	13.4	13.2	21.9	13.5
		1	104	14.0	22.0	14.2	14.2	20.4	13.9	13.7	21.0	13.6	13.2	21.9	13.5
		1	105	13.9	22.0	14.2	14.2	20.4	13.8	13.6	21.1	13.5	13.1	21.9	13.4
		50	25	13.7	21.8	14.0	14.0	21.9	13.7	13.8	21.2	13.5	13.6	21.8	13.3
		100	0	13.8	22.0	14.1	14.0	20.0	13.7	13.8	21.1	13.5	13.4	21.8	13.3
	QPSK	1	0	14.0	21.6	14.1	13.9	20.7	13.8	13.5	21.1	13.5	13.3	21.8	13.2
		1	1	13.9	21.7	14.1	13.9	20.7	14.0	13.6	21.2	13.5	13.3	21.7	13.3
		1	104	13.9	21.9	14.1	14.2	20.5	13.9	13.7	21.2	13.6	13.5	21.8	13.2
		1	105	14.0	21.9	14.2	14.2	20.5	13.7	13.7	21.1	13.7	13.3	21.8	13.1
		50	25	13.7	21.8	14.0	14.0	21.7	13.7	13.8	21.2	13.5	13.6	21.8	13.3
		100	0	13.8	21.8	14.0	14.0	20.0	13.7	13.8	21.2	13.5	13.4	21.8	13.3
	16QAM	1	0	13.6	21.5	13.8	13.4	20.5	13.3	13.1	21.1	13.2	12.7	20.2	12.6
		1	1	13.4	21.5	13.7	13.3	20.5	13.6	13.0	21.1	13.1	12.9	20.2	12.9
		1	104	13.7	21.8	13.7	13.7	20.4	13.5	13.1	20.9	13.1	12.9	20.2	12.9
		1	105	13.8	21.8	13.9	13.7	20.3	13.3	13.3	21.0	13.0	12.9	20.3	12.6
		50	25	13.2	21.7	13.5	13.5	21.5	13.2	13.3	21.1	12.9	13.1	20.4	12.8
		100	0	13.2	21.8	13.6	13.5	20.0	13.3	13.2	21.2	13.0	13.0	20.3	12.8
	64QAM	1	0	13.4	21.8	13.5	13.5	20.8	13.0	13.0	21.0	13.0	12.5	20.1	12.7
		1	1	13.3	21.8	13.5	13.4	20.8	13.1	13.0	21.1	13.0	12.7	20.3	12.8
		1	104	13.4	21.7	13.5	13.5	20.6	13.1	13.2	20.8	13.1	13.0	20.3	12.7
		1	105	13.4	21.7	13.5	13.5	20.5	13.1	13.2	20.9	13.1	13.3	20.3	12.5
		50	25	13.1	21.8	13.4	13.4	21.2	13.2	13.3	21.0	13.0	13.0	20.3	12.7
		100	0	13.2	21.8	13.5	13.5	20.1	13.2	13.2	21.1	13.0	13.0	20.3	12.8
	256QAM	1	0	13.2	20.2	13.4	13.4	20.4	13.1	12.9	19.6	13.0	12.6	20.0	12.4
		1	1	13.2	20.1	13.5	13.4	20.3	13.2	12.9	19.5	13.0	12.9	19.9	12.7
		1	104	13.1	20.3	13.5	13.4	20.1	13.2	13.0	19.5	13.0	13.0	20.1	12.7
		1	105	13.3	20.5	13.5	13.4	20.1	13.1	13.0	19.6	13.0	12.7	20.0	12.7
		50	25	13.2	20.3	13.4	13.4	20.1	13.1	13.3	19.6	13.0	13.2	19.8	12.8
		100	0	13.2	20.3	13.5	13.4	20.1	13.2	13.3	19.7	13.0	13.0	19.8	12.8

### 8.14. LTE BAND 66 AND 5G NR n66

#### LTE BAND 66

<b>Test Engineer ID:</b>	43576TS, 27915TT, and 52300CK	<b>Test Date:</b>	2024-01-12 to 2024-02-09
--------------------------	----------------------------------	-------------------	--------------------------

#### OUTPUT POWER FOR LTE BAND 66 (1.4 MHz)

Bandwidth (MHz)	Modulation	RB Allocation	RB Offset	Conducted Average (dBm)											
				ANT 2			ANT 0			ANT 1			ANT 5		
				131979	132322	132665	131979	132322	132665	131979	132322	132665	131979	132322	132665
1.4	QPSK	1	0	24.0	24.2	24.2	23.5	23.7	<b>23.8</b>	<b>24.0</b>	24.0	23.9	<b>23.9</b>	23.8	23.6
		1	2	23.8	24.2	<b>24.2</b>	23.5	23.5	23.6	24.0	23.8	23.8	23.6	23.6	23.7
		1	5	24.0	24.2	24.1	23.5	23.7	23.7	23.9	24.0	23.9	23.8	23.7	23.6
		3	0	23.9	24.0	24.0	23.5	23.6	23.6	23.9	23.9	23.9	23.7	23.7	23.6
		3	1	23.9	24.0	24.0	23.4	23.6	23.6	23.9	23.9	23.8	23.6	23.7	23.5
		3	2	23.8	24.0	24.0	23.4	23.5	23.6	23.8	23.8	23.8	23.7	23.5	23.5
	16QAM	6	0	23.0	23.1	23.1	22.4	22.6	22.7	22.9	23.0	22.8	23.0	22.7	23.0
		1	0	23.3	23.2	23.2	22.4	<b>23.0</b>	22.8	22.9	23.3	23.0	22.9	23.0	22.8
		1	2	<b>23.5</b>	23.3	23.0	22.4	<b>23.0</b>	<b>23.0</b>	23.0	23.2	23.2	<b>23.0</b>	23.0	22.6
		1	5	23.4	23.2	23.2	22.5	<b>23.0</b>	22.9	23.0	<b>23.3</b>	23.1	22.9	<b>23.0</b>	22.8
		3	0	22.9	23.2	23.2	22.6	22.6	22.7	23.0	22.9	23.1	22.9	22.7	22.6
		3	1	22.9	23.1	23.1	22.5	22.6	22.6	22.9	23.0	23.0	22.8	22.7	22.5
	64QAM	3	2	22.8	23.0	23.2	22.6	22.6	22.6	23.0	22.9	23.0	22.8	22.6	22.6
		6	0	21.9	22.2	22.2	21.6	21.6	21.8	21.9	21.9	21.9	22.2	21.8	22.1
		1	0	<b>22.2</b>	22.1	21.9	<b>21.9</b>	21.6	21.7	<b>22.3</b>	22.0	22.0	22.2	<b>22.4</b>	22.2
		1	2	22.1	22.1	22.1	21.8	21.6	21.7	<b>22.3</b>	21.9	22.1	22.3	22.3	22.2
		1	5	22.1	22.1	22.0	21.8	21.6	21.7	22.2	21.9	22.0	22.3	22.3	22.2
		3	0	22.0	22.1	22.0	21.6	21.7	21.6	22.0	22.1	21.9	22.1	22.0	22.0
	256QAM	3	1	21.9	22.1	22.0	21.5	21.6	21.7	21.9	22.0	21.9	22.1	22.0	21.9
		3	2	21.9	22.0	22.0	21.4	21.6	21.7	21.9	22.0	21.8	22.1	21.9	21.9
		6	0	20.9	21.0	21.0	20.5	20.5	20.6	20.9	21.0	20.9	20.8	20.8	20.7
		1	0	19.0	19.1	<b>19.2</b>	18.5	18.9	18.8	18.9	19.0	19.0	<b>18.9</b>	18.8	18.7
		1	2	19.0	19.2	19.1	18.5	18.9	18.7	19.1	<b>19.2</b>	18.7	18.8	18.9	18.6
		1	5	19.0	19.2	19.2	18.5	<b>18.9</b>	18.7	18.9	19.0	19.0	<b>18.9</b>	18.8	18.7

#### OUTPUT POWER FOR LTE BAND 66 (3.0 MHz)

Bandwidth (MHz)	Modulation	RB Allocation	RB Offset	Conducted Average (dBm)											
				ANT 2			ANT 0			ANT 1			ANT 5		
				131987	132322	132657	131987	132322	132657	131987	132322	132657	131987	132322	132657
3.0	QPSK	1	0	24.1	24.1	24.2	23.6	23.8	24.0	24.0	23.9	23.8	23.8	23.6	
		1	7	23.8	24.1	<b>24.2</b>	23.3	23.6	<b>23.8</b>	23.9	23.8	23.9	23.6	<b>23.8</b>	23.3
		1	14	24.1	24.1	<b>24.2</b>	23.6	23.6	23.8	24.0	<b>24.1</b>	23.8	23.8	23.7	23.7
		8	0	23.1	23.2	23.1	22.5	22.6	22.7	22.9	23.0	22.9	22.7	22.6	22.9
		8	4	23.0	23.1	23.1	22.5	22.6	22.7	22.9	23.0	22.9	22.6	22.6	22.9
		8	7	23.0	23.1	23.2	22.5	22.6	22.7	22.9	23.0	22.9	22.6	22.7	22.9
	16QAM	15	0	23.0	23.1	23.1	22.5	22.6	22.7	22.8	22.9	22.9	22.7	22.7	22.9
		1	0	23.1	23.5	23.5	22.8	23.0	<b>23.0</b>	23.2	23.0	23.3	22.8	<b>22.9</b>	22.8
		1	7	23.1	23.6	23.5	22.7	23.0	<b>23.0</b>	23.3	23.1	<b>23.3</b>	22.9	22.9	22.8
		1	14	23.0	<b>23.6</b>	23.4	22.6	<b>23.0</b>	23.0	23.2	23.0	23.3	22.7	22.9	22.7
		8	0	22.1	22.3	22.2	21.6	21.7	21.7	21.9	22.0	21.9	21.8	21.8	21.9
		8	4	22.1	22.3	22.2	21.6	21.7	21.7	21.8	22.0	21.9	21.8	21.7	22.0
	64QAM	8	7	22.1	22.3	22.2	21.6	21.7	21.7	21.8	22.0	21.9	21.8	21.7	22.0
		15	0	22.0	22.1	22.1	21.6	21.7	21.7	21.8	21.8	21.9	21.7	21.8	21.9
		1	0	22.2	22.2	22.1	21.5	21.8	21.8	22.2	22.0	22.0	22.4	22.1	22.1
		1	7	22.1	22.2	22.0	21.3	21.7	21.7	22.2	22.0	22.0	<b>22.5</b>	22.0	22.1
		1	14	22.1	<b>22.3</b>	22.2	21.4	<b>21.9</b>	21.9	<b>22.2</b>	22.1	21.9	22.5	22.1	22.2
		8	0	21.1	21.1	21.0	20.6	20.5	20.6	20.9	20.9	20.9	20.8	20.9	20.8
	256QAM	8	4	21.0	21.1	21.0	20.5	20.5	20.6	20.9	20.9	20.9	20.8	20.8	20.8
		8	7	21.1	21.1	21.0	20.6	20.5	20.6	20.9	20.9	20.9	20.8	20.9	20.8
		15	0	21.0	21.0	21.0	20.5	20.5	20.6	20.8	20.9	20.8	20.8	20.9	20.7
		1	0	19.2	19.4	19.3	18.6	<b>19.0</b>	18.8	<b>19.3</b>	19.1	19.0	18.8	18.8	18.9
		1	7	19.0	19.2	19.3	18.4	18.9	18.7	19.2	19.1	19.0	18.8	18.8	18.8
		1	14	19.2	<b>19.4</b>	19.3	18.5	19.0	18.8	19.3	19.1	19.0	18.9	18.8	18.9

**OUTPUT POWER FOR LTE BAND 66 (5.0 MHz)**

Bandwidth (MHz)	Modulation	RB Allocation	RB Offset	Conducted Average (dBm)											
				ANT 2			ANT 0			ANT 1			ANT 5		
				131997	132322	132647	131997	132322	132647	131997	132322	132647	131997	132322	132647
5.0	QPSK	1	0	24.0	24.1	24.1	23.4	23.5	23.6	23.8	23.9	23.9	23.7	23.7	23.5
		1	12	23.9	<b>24.2</b>	<b>24.2</b>	23.4	23.5	23.5	23.8	<b>24.0</b>	<b>24.0</b>	23.7	<b>23.8</b>	23.6
		1	24	24.0	24.1	24.2	23.5	23.5	<b>23.6</b>	23.9	23.9	23.9	23.7	23.7	23.5
		12	0	23.0	23.1	23.1	22.4	22.5	22.6	22.8	22.9	22.9	22.7	22.7	23.0
		12	6	23.0	23.1	23.1	22.4	22.5	22.6	22.8	22.9	22.9	23.0	22.7	22.9
		12	11	23.0	23.1	23.1	22.4	22.5	22.6	22.8	22.9	22.9	22.9	22.7	23.0
	16QAM	25	0	23.0	23.2	23.1	22.4	22.6	22.6	22.8	22.9	22.9	22.7	22.7	23.0
		1	0	23.4	23.5	23.4	22.8	22.9	<b>23.0</b>	23.3	23.3	23.3	23.0	23.0	22.9
		1	12	23.3	23.5	23.4	22.6	22.9	22.7	<b>23.2</b>	<b>23.4</b>	23.2	22.9	<b>23.1</b>	22.9
		1	24	23.4	<b>23.6</b>	23.4	22.8	22.9	23.0	23.3	23.3	23.2	22.9	23.0	22.9
		12	0	22.1	22.1	22.2	21.5	21.6	21.7	21.9	21.9	21.9	21.8	21.8	22.0
		12	6	22.1	22.1	22.2	21.5	21.6	21.7	21.9	21.9	21.9	22.4	21.8	21.9
	64QAM	12	11	22.1	22.1	22.2	21.5	21.6	21.7	21.9	21.9	21.9	22.4	21.8	21.9
		25	0	22.0	<b>22.2</b>	22.1	21.5	21.6	21.7	21.8	21.9	21.9	22.3	21.8	21.8
		1	0	21.9	<b>22.2</b>	22.1	21.7	21.6	<b>22.0</b>	21.9	<b>22.3</b>	22.2	22.3	22.2	22.1
		1	12	21.7	22.1	22.2	21.6	21.4	21.9	21.9	22.2	22.1	<b>22.5</b>	22.1	22.1
		1	24	21.9	22.1	22.2	21.6	21.6	22.0	22.0	22.2	22.2	<b>22.5</b>	22.2	22.2
		12	0	20.9	20.9	21.0	20.4	20.5	20.6	20.9	20.9	20.9	20.8	20.9	20.8
	256QAM	12	6	20.9	20.9	20.9	20.4	20.5	20.6	20.9	20.9	20.9	20.8	20.8	20.8
		12	11	20.9	20.9	20.9	20.4	20.5	20.6	20.9	20.9	20.9	20.8	20.8	20.7
		25	0	20.9	20.9	21.0	20.5	20.5	20.6	20.8	20.9	20.9	20.8	20.8	20.8
		1	0	19.1	<b>19.3</b>	19.2	18.7	18.9	18.8	19.0	19.1	19.0	<b>19.0</b>	18.9	18.8
		1	12	18.9	19.2	19.1	18.6	18.6	18.7	18.8	<b>19.1</b>	19.0	18.9	18.9	18.7
		1	24	19.0	19.2	19.2	18.7	18.8	<b>18.9</b>	19.0	19.1	19.0	18.9	18.9	18.8
		12	0	19.0	19.1	19.0	18.6	18.6	18.7	18.8	19.0	18.9	18.8	18.8	18.7
12		6	19.0	19.1	19.0	18.6	18.6	18.8	18.9	19.0	18.9	18.8	18.8	18.7	
12		11	19.0	19.0	19.0	18.6	18.6	18.7	18.8	18.9	18.9	18.8	18.8	18.7	
25		0	19.0	19.0	19.1	18.6	18.6	18.6	18.9	18.9	18.9	18.8	18.8	18.7	

**OUTPUT POWER FOR LTE BAND 66 (10.0 MHz)**

Bandwidth (MHz)	Modulation	RB Allocation	RB Offset	Conducted Average (dBm)											
				ANT 2			ANT 0			ANT 1			ANT 5		
				132022	132322	132622	132022	132322	132622	132022	132322	132622	132022	132322	132622
10.0	QPSK	1	0	24.1	24.2	<b>24.2</b>	23.5	23.6	<b>23.7</b>	23.9	24.0	<b>24.0</b>	23.7	<b>23.8</b>	23.7
		1	24	24.0	24.1	<b>24.2</b>	23.4	23.5	23.7	23.7	24.0	24.0	23.7	23.6	23.7
		1	49	24.1	24.2	24.1	23.5	23.6	23.7	23.9	23.9	23.9	23.7	23.7	23.6
		25	0	23.1	23.1	23.2	22.5	22.6	22.7	22.9	22.9	22.9	23.4	22.7	23.0
		25	12	23.1	23.2	23.2	22.5	22.5	22.7	22.9	22.9	22.9	23.4	22.7	23.0
		25	24	23.0	23.1	23.1	22.5	22.5	22.7	22.8	22.9	22.9	23.4	22.7	23.0
	16QAM	50	0	23.1	23.1	23.1	22.5	22.5	22.7	22.8	22.9	22.9	23.4	22.7	23.0
		1	0	23.6	23.3	23.5	22.9	22.8	22.9	23.3	23.1	23.5	<b>23.2</b>	22.9	22.9
		1	24	23.5	23.4	<b>23.7</b>	22.9	22.9	<b>23.0</b>	23.3	23.2	<b>23.5</b>	23.0	23.0	22.9
		1	49	23.5	23.2	23.5	22.8	22.7	22.9	23.3	23.0	23.4	23.1	22.8	22.8
		25	0	22.0	22.1	22.1	21.5	21.5	21.6	21.9	21.9	21.9	22.4	21.8	22.0
		25	12	22.0	22.1	22.2	21.4	21.5	21.6	21.9	21.9	21.9	22.4	21.8	22.0
	64QAM	25	24	22.0	22.1	22.1	21.4	21.5	21.7	21.9	21.9	21.9	22.5	21.8	22.0
		50	0	22.0	22.1	22.2	21.5	21.6	21.7	21.8	21.9	21.9	22.4	21.8	22.0
		1	0	21.9	22.2	22.2	21.6	21.6	21.8	21.9	22.1	22.1	<b>22.5</b>	22.2	22.3
		1	24	22.0	<b>22.2</b>	22.2	21.5	21.7	<b>21.8</b>	21.9	<b>22.1</b>	22.0	<b>22.5</b>	22.1	22.2
		1	49	21.9	22.2	22.2	21.4	21.7	21.8	22.0	22.0	22.0	<b>22.5</b>	22.0	22.2
		25	0	21.0	21.0	21.1	20.6	20.5	20.6	20.9	20.9	20.9	20.9	20.9	20.9
	256QAM	25	12	20.9	21.0	21.1	20.5	20.5	20.7	20.9	20.9	20.9	20.8	20.9	20.8
		25	24	20.9	21.0	21.1	20.5	20.5	20.7	20.8	20.9	20.9	20.8	20.9	20.8
		50	0	20.9	21.0	21.1	20.5	20.5	20.7	20.9	20.9	20.9	20.8	20.9	20.8
		1	0	19.4	<b>19.5</b>	19.1	18.6	18.9	18.9	18.9	19.1	19.2	<b>19.1</b>	18.7	18.7
		1	24	19.4	<b>19.5</b>	19.0	18.5	18.9	18.9	18.9	19.1	<b>19.4</b>	<b>19.1</b>	18.6	18.6
		1	49	19.3	19.5	19.0	18.4	<b>18.9</b>	18.9	18.9	19.1	19.3	19.0	18.7	18.7
		25	0	19.1	19.2	19.1	18.7	18.7	18.7	19.0	19.0	19.0	18.9	18.9	18.8
25		12	19.1	19.1	19.1	18.7	18.7	18.7	18.9	19.0	19.0	18.9	18.9	18.8	
25	24	19.1	19.1	19.1	18.6	18.7	18.7	18.9	19.0	19.0	18.8	18.9	18.8		
50	0	19.1	19.1	19.1	18.6	18.6	18.7	18.9	18.9	19.0	18.8	18.8	18.7		

**OUTPUT POWER FOR LTE BAND 66 (15.0 MHz)**

Bandwidth (MHz)	Modulation	RB Allocation	RB Offset	Conducted Average (dBm)												
				ANT 2			ANT 0			ANT 1			ANT 5			
				132047	132322	132597	132047	132322	132597	132047	132322	132597	132047	132322	132597	
15.0	QPSK	1	0	24.1	24.2	24.3	23.5	23.6	23.7	23.9	24.0	24.0	23.7	23.8	23.7	
		1	37	24.0	24.2	24.3	23.4	23.4	23.5	24.0	23.9	24.0	23.8	23.7	23.6	
		1	74	24.1	24.2	24.2	23.5	23.6	23.7	23.9	23.9	23.9	23.7	23.7	23.6	
		36	0	23.1	23.2	23.2	22.5	22.6	22.7	23.0	23.0	23.0	22.6	22.6	23.0	
		36	16	23.1	23.2	23.2	22.5	22.5	22.6	22.9	23.0	23.0	22.6	22.6	22.9	
		36	35	23.1	23.1	23.2	22.5	22.5	22.7	22.9	22.9	22.9	22.5	22.5	22.8	
	16QAM	75	0	23.1	23.2	23.2	22.5	22.5	22.7	22.9	22.9	22.9	22.6	22.5	22.8	
		1	0	23.4	23.5	23.7	22.9	22.8	22.9	23.2	23.3	23.3	23.0	23.0	23.1	
		1	37	23.4	23.5	23.7	22.8	22.8	22.9	23.2	23.3	23.3	23.0	22.9	23.0	
		1	74	23.3	23.4	23.6	22.8	22.7	23.0	23.2	23.2	23.2	22.9	22.9	23.0	
		36	0	22.1	22.2	22.2	21.5	21.5	21.7	21.9	22.0	21.9	21.8	21.8	21.8	
		36	16	22.1	22.2	22.2	21.5	21.5	21.7	21.9	21.9	21.9	21.7	21.7	21.8	
	64QAM	36	35	22.1	22.1	22.1	21.5	21.5	21.7	21.9	21.9	21.9	21.7	21.7	21.8	
		75	0	22.1	22.1	22.2	21.5	21.5	21.6	21.9	21.9	21.9	21.7	21.7	21.9	
		1	0	22.3	22.2	22.2	21.8	21.7	21.7	22.3	22.1	22.1	21.9	22.1	22.1	
		1	37	22.0	22.1	22.1	21.6	21.5	21.5	22.0	22.1	22.1	21.7	21.9	22.0	
		1	74	22.3	22.1	22.1	21.7	21.6	21.7	22.3	22.1	22.0	21.8	21.9	21.9	
		36	0	21.0	21.1	21.1	20.5	20.6	20.7	20.9	21.0	21.0	20.9	20.9	20.8	
	256QAM	36	16	20.9	21.1	21.1	20.4	20.6	20.7	20.9	21.0	21.0	20.9	20.9	20.8	
		36	35	20.9	21.1	21.1	20.4	20.6	20.7	20.9	21.0	21.0	20.9	20.9	20.8	
		75	0	21.0	21.0	21.0	20.5	20.5	20.6	20.9	20.9	20.9	20.8	20.8	20.8	
		1	0	19.2	19.5	18.9	18.7	18.9	18.7	19.1	19.0	18.8	18.7	18.8	19.1	
		1	37	19.1	19.4	18.8	18.5	18.8	18.6	19.2	18.9	18.8	18.6	18.6	19.0	
		1	74	19.1	19.5	18.9	18.5	18.9	18.7	19.1	19.0	18.8	18.7	18.7	19.1	
	20.0	QPSK	36	0	19.0	19.1	19.1	18.5	18.6	18.6	18.9	19.0	19.0	18.9	18.9	18.8
			36	16	19.0	19.1	19.1	18.5	18.6	18.6	18.9	19.0	18.9	18.9	18.9	18.8
			36	35	18.9	19.1	19.1	18.4	18.5	18.6	18.9	19.0	18.9	18.9	18.9	18.7
			75	0	19.0	19.1	19.1	18.5	18.5	18.6	18.9	19.0	18.9	18.9	18.8	18.8
			1	0	24.1	24.2	24.2	23.5	23.6	23.6	23.9	23.9	23.9	23.7	23.7	23.7
			1	49	24.3	23.6	24.1	23.5	23.3	23.6	24.2	23.4	23.9	23.4	23.7	23.9
16QAM		1	99	24.1	24.2	24.1	23.5	23.6	23.6	23.9	23.9	23.9	23.7	23.7	23.7	
		50	0	23.1	23.2	23.2	22.5	22.6	22.6	22.9	23.0	23.0	22.9	22.9	22.9	
		50	24	23.1	23.1	23.2	22.5	22.6	22.6	22.9	22.9	22.9	22.8	22.8	22.9	
		50	49	23.1	23.1	23.1	22.4	22.6	22.6	22.9	22.9	22.9	22.8	22.8	22.8	
	100	0	23.1	23.2	23.2	22.5	22.6	22.7	22.9	23.0	23.0	22.8	22.8	22.9		
	1	0	23.5	23.5	23.6	22.8	22.9	23.0	23.4	23.4	23.3	23.2	23.1	23.2		
64QAM	1	49	23.3	23.3	23.7	22.8	22.8	23.0	23.3	23.3	23.2	23.1	23.2	23.2		
	1	99	23.4	23.5	23.5	22.7	22.9	23.0	23.3	23.4	23.2	23.2	23.0	23.0		
	50	0	22.1	22.1	22.2	21.5	21.6	21.6	21.9	22.0	21.9	22.0	21.9	21.9		
	50	24	22.0	22.1	22.2	21.4	21.6	21.6	21.9	21.9	21.9	21.9	21.9	21.9		
	50	49	22.0	22.1	22.2	21.4	21.6	21.6	21.9	21.9	21.9	21.9	21.9	21.8		
	100	0	22.1	22.1	22.1	21.4	21.6	21.6	21.9	21.9	21.9	21.9	21.9	21.9		
256QAM	1	0	22.2	22.3	22.3	21.8	21.8	21.9	22.3	22.2	22.1	22.2	22.4	22.3		
	1	49	22.3	22.3	22.2	21.7	21.8	21.7	22.3	22.3	22.1	22.3	22.1	22.2		
	1	99	22.1	22.3	22.2	21.7	21.8	21.9	22.2	22.2	22.0	22.2	22.2	22.2		
	50	0	21.0	21.1	21.0	20.5	20.5	20.6	20.9	20.9	20.9	20.9	20.9	20.9		
	50	24	21.0	21.0	21.0	20.4	20.6	20.6	20.9	20.9	20.9	20.9	20.9	20.8		
	50	49	21.0	21.0	21.0	20.4	20.6	20.6	20.9	20.9	20.9	20.9	20.9	20.8		
256QAM	100	0	21.0	21.0	21.0	20.5	20.6	20.6	20.9	20.9	20.9	20.9	20.8	20.8		
	1	0	19.2	19.5	19.2	18.9	18.7	18.9	19.1	19.1	19.2	19.1	19.3	19.0		
	1	49	19.2	19.4	19.2	18.6	18.8	18.7	19.2	19.1	19.2	19.0	19.2	19.0		
	1	99	19.1	19.4	19.2	18.7	18.7	19.0	19.1	19.1	19.2	19.1	19.2	19.0		
	50	0	19.1	19.2	19.1	18.7	18.6	18.6	19.0	19.0	19.0	18.9	18.9	18.8		
	50	24	19.1	19.2	19.1	18.6	18.6	18.6	19.0	19.0	18.9	18.8	18.9	18.8		
256QAM	50	49	19.0	19.1	19.0	18.5	18.7	18.6	18.9	18.9	18.9	18.9	18.8	18.7		
	100	0	19.1	19.1	19.1	18.6	18.6	18.6	19.0	18.9	18.9	18.9	18.9	18.8		

**OUTPUT POWER FOR LTE BAND 66 (20.0 MHz)**

Bandwidth (MHz)	Modulation	RB Allocation	RB Offset	Conducted Average (dBm)											
				ANT 2			ANT 0			ANT 1			ANT 5		
				132072	132322	132572	132072	132322	132572	132072	132322	132572	132072	132322	132572
20.0	QPSK	1	0	24.1	24.2	24.2	23.5	23.6	23.7	23.9	24.0	24.1	23.8	23.9	23.8
		1	49	24.3	23.6	24.1	23.5	23.3	23.6	24.2	23.4	23.9	23.4	23.7	23.9
		1	99	24.1	24.2	24.1	23.5	23.6	23.6	23.9	23.9	23.9	23.7	23.7	23.7
		50	0	23.1	23.2	23.2	22.5	22.6	22.6	22.9	23.0	23.0	22.9	22.9	22.9
		50	24	23.1	23.1	23.2	22.5	22.6	22.6	22.9	22.9	22.9	22.8	22.8	22.9
		50	49	23.1	23.1	23.1	22.4	22.6	22.6	22.9	22.9	22.9	22.8	22.8	22.8
	16QAM	100	0	23.1	23.2	23.2	22.5	22.6	22.7	22.9	23.0	23.0	22.8	22.8	22.9
		1	0	23.5	23.5	23.6	22.8	22.9	23.0	23.4	23.4	23.3	23.2	23.1	23.2
		1	49	23.3	23.3	23.7	22.8	22.8	23.0	23.3	23.3	23.2	23.1	23.2	23.2
		1	99	23.4	23.5	23.5	22.7	22.9	23.0	23.3	23.4	23.2	23.2	23.0	23.0
		50	0	22.1	22.1	22.2	21.5	21.6	21.6	21.9	22.0	21.9	22.0	21.9	21.9
		50	24	22.0	22.1	22.2	21.4	21.6	21.6	21.9	21.9	21.9	21.9	21.9	21.9
	64QAM	50	49	22.0	22.1	22.2	21.4	21.6	21.6	21.9	21.9	21.9	21.9	21.9	21.8
		100	0	22.1	22.1	22.1	21.4	21.6	21.6	21.9	21.9	21.9	21.9	21.9	21.9
		1	0	22.2	22.3	22.3	21.8	21.8	21.9	22.3	22.2	22.1	22.2	22.4	22.3
		1	49	22.3	22.3	22.2	21.7	21.8	21.7	22.3	22.3	22.1	22.3	22.1	22.2
		1	99	22.1	22.3	22.2	21.7	21.8	21.9	22.2	22.2	22.0	22.2	22.2	22.2
		50	0	21.0	21.1	21.0	20.5	20.5	20.6	20.9	20.9	20.9	20.9	20.9	20.9
	256QAM	50	24	21.0	21.0	21.0	20.4	20.6	20.6	20.9	20.9	20.9	20.9	20.9	20.8
		100	0	21.0	21.0	21.0	20.5	20.6	20.6	20.9	20.9	20.9	20.9	20.8	20.8
		1	0	19.2	19.5	19.2	18.9	18.7	18.9	19.1	19.1	19.2	19.1	19.3	19.0
		1	49	19.2	19.4	19.2	18.6	18.8	18.7	19.2	19.1	19.2	19.0	19.2	19.0
		1	99	19.1	19.4	19.2	18.7	18.7	19.0	19.1	19.1	19.2	19.1	19.2	19.0
		50	0	19.1	19.2	19.1									

**5G NR n66**

<b>Test Engineer ID:</b>	19210AL and 27966PV	<b>Test Date:</b>	2024-02-16 to 2024-03-06
--------------------------	---------------------	-------------------	--------------------------

**OUTPUT POWER FOR 5G NR n66 (5.0 MHz)**

Bandwidth (MHz)	Modulation	RB Allocation	RB Offset	Conducted Average (dBm)											
				ANT 2			ANT 0			ANT 1			ANT 5		
				342500	349000	355500	342500	349000	355500	342500	349000	355500	342500	349000	355500
5.0	BPSK	1	0	23.8	24.0	23.9	23.2	23.5	23.3	23.2	23.4	23.3	23.5	23.6	23.4
		1	1	24.3	24.4	24.3	23.4	<b>23.8</b>	23.7	23.7	23.9	23.8	23.9	24.0	23.9
		1	23	24.4	<b>24.5</b>	24.3	23.5	23.8	23.6	23.7	<b>24.0</b>	23.8	23.9	24.1	23.8
		1	24	23.9	23.9	23.8	23.2	23.5	23.3	23.2	23.5	23.4	23.4	23.6	23.4
		12	6	24.4	24.4	24.3	23.4	<b>23.8</b>	23.6	23.7	23.9	23.9	24.0	24.0	23.8
	25	0	23.8	23.9	23.8	23.1	23.6	23.3	23.2	23.4	23.3	23.5	23.5	23.4	
	QPSK	1	0	23.3	<b>23.5</b>	23.2	22.6	23.0	22.8	22.7	22.9	22.8	23.0	23.1	22.9
		1	1	24.3	<b>24.5</b>	24.3	23.5	23.8	23.7	23.7	23.9	23.8	23.9	<b>24.1</b>	23.9
		1	23	24.4	24.4	24.3	23.5	<b>23.8</b>	23.6	23.7	<b>24.0</b>	23.8	23.9	24.1	23.8
		1	24	23.3	23.4	23.2	22.7	23.1	22.9	22.7	22.9	22.8	22.9	23.0	22.9
		12	6	24.3	24.3	24.3	23.4	23.7	23.7	23.8	23.9	23.8	23.9	24.0	23.8
	25	0	23.3	23.3	23.2	22.6	23.0	22.8	22.7	22.9	22.8	22.9	23.0	22.8	
	16QAM	1	0	22.2	<b>22.1</b>	22.2	22.0	22.1	22.0	21.7	22.2	22.0	22.1	21.9	21.7
		1	1	23.3	<b>23.5</b>	23.3	22.4	22.9	22.8	22.9	22.8	22.6	22.9	23.0	22.6
		1	23	23.5	23.5	23.2	22.6	22.9	22.8	22.9	22.6	22.7	22.9	<b>23.1</b>	22.9
		1	24	22.1	22.4	22.0	22.1	21.9	21.6	22.1	22.1	21.9	21.8	22.2	21.9
		12	6	23.3	23.4	23.3	22.7	<b>23.0</b>	22.9	22.7	<b>23.0</b>	22.8	23.0	23.0	22.9
	25	0	22.2	22.4	22.2	21.5	22.0	21.8	21.8	21.8	21.8	21.8	22.0	21.8	
	64QAM	1	0	21.6	22.1	21.3	21.2	21.6	21.4	20.9	21.5	21.5	21.3	21.7	21.5
		1	1	<b>22.1</b>	21.6	22.0	21.1	<b>21.6</b>	21.5	21.2	21.1	21.4	21.4	21.4	21.5
		1	23	21.9	21.7	21.6	21.3	21.3	21.5	21.3	21.4	21.3	21.4	21.2	21.4
		1	24	21.8	21.7	21.9	21.2	21.4	21.3	20.5	<b>21.5</b>	21.4	21.5	21.4	<b>21.8</b>
		12	6	21.7	21.8	21.7	21.1	21.5	21.3	21.3	21.4	21.3	21.4	21.5	21.3
	25	0	21.8	21.9	21.7	21.2	21.5	21.4	21.2	21.3	21.3	21.5	21.4	21.3	
	256QAM	1	0	20.0	20.0	19.9	19.2	<b>19.7</b>	19.6	19.2	19.4	19.4	19.6	19.3	19.2
1		1	20.0	19.9	20.0	19.0	19.3	19.4	19.4	<b>19.6</b>	19.4	19.6	19.3	19.5	
1		23	19.8	19.8	<b>20.1</b>	19.0	19.4	19.3	19.2	19.5	19.5	19.6	19.2	19.6	
1		24	20.0	19.7	19.7	19.2	19.2	19.6	19.3	19.5	19.5	<b>19.7</b>	19.3	19.5	
12		6	19.9	19.9	19.7	19.2	19.5	19.3	19.3	19.3	19.3	19.6	19.4	19.3	
25	0	19.9	19.9	19.7	19.2	19.4	19.3	19.3	19.3	19.3	19.6	19.4	19.3		

**OUTPUT POWER FOR 5G NR n66 (10.0 MHz)**

Bandwidth (MHz)	Modulation	RB Allocation	RB Offset	Conducted Average (dBm)											
				ANT 2			ANT 0			ANT 1			ANT 5		
				343000	349000	355000	343000	349000	355000	343000	349000	355000	343000	349000	355000
10.0	BPSK	1	0	24.0	24.0	23.9	23.1	23.4	23.4	23.4	23.5	23.5	23.5	23.5	23.3
		1	1	24.4	24.4	24.4	23.4	23.8	23.7	23.8	24.0	23.9	23.9	<b>23.9</b>	23.9
		1	50	<b>24.4</b>	24.4	24.3	23.5	<b>23.8</b>	23.6	23.8	<b>24.0</b>	23.8	23.9	23.9	23.8
		1	51	24.0	23.8	23.8	23.2	23.4	23.2	23.4	23.5	23.4	23.4	23.5	23.2
		25	12	24.3	24.3	24.3	23.5	23.7	23.6	23.8	23.9	23.8	23.8	23.8	23.8
	50	0	23.9	23.9	23.7	23.1	23.5	23.3	23.2	23.4	23.2	23.3	23.4	23.2	
	QPSK	1	0	23.3	23.5	23.4	22.7	23.0	22.9	22.7	23.0	22.8	22.8	22.9	22.8
		1	1	24.3	24.4	24.3	23.4	<b>23.8</b>	23.7	23.8	<b>24.0</b>	23.9	23.9	<b>24.0</b>	23.8
		1	50	<b>24.4</b>	24.4	24.2	23.5	23.8	23.6	23.9	<b>24.0</b>	23.8	23.9	23.9	23.7
		1	51	23.5	23.3	23.3	22.8	23.0	22.8	22.9	22.9	22.8	22.9	22.9	22.7
		25	12	24.4	24.3	24.3	23.4	23.7	23.6	23.8	23.9	23.8	23.8	23.8	23.7
	50	0	23.4	23.3	23.2	22.6	23.0	22.8	22.8	22.8	22.8	22.8	22.9	22.7	
	16QAM	1	0	22.4	22.4	22.4	21.3	22.3	21.8	21.6	21.7	21.8	21.9	22.3	21.8
		1	1	23.3	23.3	23.6	22.7	<b>23.0</b>	22.8	<b>22.9</b>	22.5	22.9	22.7	22.6	22.9
		1	50	23.8	23.2	<b>23.8</b>	22.7	23.0	22.5	22.8	22.6	22.8	22.9	<b>23.0</b>	22.7
		1	51	22.6	22.2	22.6	22.0	22.0	21.8	21.9	22.3	21.6	22.1	21.6	21.6
		25	12	23.4	23.3	23.4	22.7	23.0	22.9	22.8	22.8	22.8	22.8	22.7	22.8
	50	0	22.4	22.2	22.2	21.6	21.9	21.8	21.8	21.8	21.7	21.9	21.7	21.7	
	64QAM	1	0	22.0	21.7	21.5	21.2	21.6	21.5	21.1	21.2	21.5	21.1	21.7	21.5
		1	1	21.7	<b>22.4</b>	22.0	21.2	21.3	21.1	21.1	<b>21.6</b>	21.4	21.3	<b>21.8</b>	21.6
		1	50	22.1	21.9	21.6	21.2	<b>21.7</b>	21.4	21.5	<b>21.6</b>	21.1	21.5	21.8	21.1
		1	51	21.6	21.7	21.6	21.1	21.3	21.1	21.3	21.4	21.2	21.7	21.0	21.3
		25	12	21.9	21.7	21.7	21.2	21.4	21.4	21.2	21.3	21.2	21.2	21.3	21.2
	50	0	21.9	21.8	21.7	21.1	21.5	21.3	21.3	21.4	21.3	21.3	21.2	21.2	
	256QAM	1	0	19.7	20.0	19.5	19.0	19.5	19.3	19.1	19.4	19.5	19.6	19.5	19.1
1		1	20.0	19.8	19.5	19.6	<b>19.7</b>	19.4	19.4	19.5	19.4	19.5	19.4	<b>19.6</b>	
1		50	19.8	<b>20.0</b>	19.9	19.6	19.7	19.5	19.2	19.5	18.9	19.2	19.5	19.0	
1		51	19.5	19.9	19.7	19.1	19.4	19.4	19.0	<b>19.6</b>	19.5	19.2	19.5	19.1	
25		12	19.9	19.9	19.7	19.1	19.5	19.3	19.2	19.4	19.2	19.4	19.2	19.2	
50	0	19.8	19.9	19.7	19.1	19.4	19.2	19.2	19.3	19.3	19.4	19.3	19.2		

**OUTPUT POWER FOR 5G NR n66 (15.0 MHz)**

Bandwidth (MHz)	Modulation	RB Allocation	RB Offset	Conducted Average (dBm)											
				ANT 2			ANT 0			ANT 1			ANT 5		
				343500	349000	354500	343500	349000	354500	343500	349000	354500	343500	349000	354500
15.0	BPSK	1	0	23.8	24.0	23.9	23.1	23.3	23.4	23.2	23.4	23.3	23.4	23.5	23.3
		1	1	24.3	24.4	24.3	23.4	23.6	23.7	23.7	23.9	23.8	24.0	24.0	23.9
		1	77	24.4	24.4	24.2	23.4	23.8	23.6	23.7	24.0	23.8	23.8	23.9	23.8
		1	78	23.8	24.0	23.7	23.2	23.4	23.2	23.3	23.5	23.3	23.3	23.6	23.3
		36	18	24.3	24.3	24.3	23.5	23.8	23.6	23.7	23.9	23.9	23.9	24.0	23.9
		75	0	23.8	23.9	23.8	23.1	23.5	23.4	23.3	23.4	23.4	23.5	23.5	23.5
	QPSK	1	0	23.4	23.4	23.3	22.5	22.8	22.9	22.7	22.9	22.8	23.0	22.9	22.8
		1	1	24.2	24.3	24.3	23.3	23.7	23.7	23.8	23.9	23.8	23.9	24.0	23.8
		1	77	24.3	24.3	24.2	23.6	23.7	23.6	23.7	23.9	23.8	23.9	23.9	23.8
		1	78	23.2	23.3	23.3	22.8	22.9	22.8	22.7	22.9	22.8	22.8	22.9	22.9
		36	18	24.3	24.4	24.3	23.5	23.8	23.6	23.7	23.8	23.9	23.9	24.0	23.9
		75	0	23.3	23.4	23.3	22.7	22.9	22.9	22.7	22.9	22.9	22.9	22.9	22.8
	16QAM	1	0	22.2	22.5	22.5	21.6	22.0	22.0	21.6	21.7	22.1	21.8	22.1	21.9
		1	1	23.2	23.1	23.1	22.4	22.9	22.9	23.0	22.8	22.7	23.1	22.9	22.9
		1	77	23.4	23.3	23.3	22.6	22.9	22.8	22.9	22.5	22.6	22.5	23.0	22.8
		1	78	22.3	22.4	22.2	21.5	21.9	22.0	21.8	21.8	22.1	21.7	22.0	21.6
		36	18	23.2	23.4	23.3	22.6	22.8	22.9	22.7	22.8	22.8	22.9	22.9	22.9
		75	0	22.3	22.3	22.3	21.7	21.9	21.9	21.6	21.8	21.9	22.0	22.0	21.9
	64QAM	1	0	22.0	21.6	21.9	21.2	21.3	21.6	21.2	21.4	21.3	21.8	21.4	21.4
		1	1	21.9	21.5	21.8	21.2	21.7	21.2	21.1	21.5	21.5	21.1	21.2	21.0
		1	77	21.6	21.8	21.8	21.3	21.4	21.1	21.3	21.4	21.1	21.6	21.6	21.3
		1	78	21.5	22.0	21.5	21.1	21.3	21.5	21.4	21.5	21.3	21.1	21.4	21.5
		36	18	21.8	21.9	21.7	21.1	21.4	21.4	21.3	21.3	21.4	21.4	21.5	21.4
		75	0	21.8	21.9	21.7	21.1	21.4	21.3	21.2	21.4	21.3	21.4	21.4	21.3
	256QAM	1	0	19.9	20.0	19.5	19.1	19.5	19.2	19.1	19.2	19.1	19.7	19.3	19.4
		1	1	19.7	19.7	19.7	19.0	19.2	19.6	19.2	19.3	19.3	19.3	19.3	19.2
		1	77	19.7	19.6	19.4	19.5	19.6	19.5	19.4	19.4	19.1	19.3	19.4	19.4
		1	78	19.6	20.0	19.8	19.3	19.6	19.0	19.1	19.5	19.1	19.3	19.3	19.4
		36	18	19.9	19.9	19.7	19.1	19.4	19.4	19.2	19.3	19.4	19.4	19.4	19.4
		75	0	19.9	19.9	19.7	19.1	19.5	19.3	19.2	19.4	19.3	19.4	19.4	19.3

**OUTPUT POWER FOR 5G NR n66 (20.0 MHz)**

Bandwidth (MHz)	Modulation	RB Allocation	RB Offset	Conducted Average (dBm)											
				ANT 2			ANT 0			ANT 1			ANT 5		
				344000	349000	354000	344000	349000	354000	344000	349000	354000	344000	349000	354000
20.0	BPSK	1	0	23.9	23.9	23.9	23.1	23.4	23.3	23.3	23.4	23.5	23.5	23.4	23.5
		1	1	24.4	24.4	24.4	23.4	23.7	23.7	23.8	23.9	24.0	24.0	24.0	24.0
		1	104	24.4	24.4	24.3	23.6	23.8	23.5	24.0	23.9	23.9	24.0	24.0	24.0
		1	105	23.9	23.8	23.8	23.3	23.5	23.3	23.4	23.5	23.4	23.6	23.4	23.5
		50	25	24.4	24.4	24.2	23.5	23.6	23.7	23.8	23.9	24.0	23.9	24.0	24.0
		100	0	23.9	23.9	23.7	23.2	23.3	23.4	23.3	23.4	23.5	23.5	23.5	23.5
	QPSK	1	0	23.3	23.3	23.3	22.6	22.9	23.0	22.7	23.0	23.0	23.0	23.0	23.0
		1	1	24.3	24.3	24.3	23.4	23.7	23.7	23.8	23.9	24.0	23.9	24.0	23.9
		1	104	24.4	24.3	24.2	23.6	23.8	23.6	23.9	24.0	23.9	23.9	24.0	23.9
		1	105	23.3	23.3	23.2	22.9	22.9	22.7	22.9	22.9	22.8	22.9	23.0	22.9
		50	25	24.3	24.4	24.2	23.5	23.7	23.7	23.8	23.9	23.9	24.0	24.1	24.0
		100	0	23.4	23.3	23.2	22.7	22.9	22.9	22.7	23.0	23.0	22.9	23.0	23.0
	16QAM	1	0	22.3	22.4	22.2	21.6	22.0	21.8	21.8	22.2	22.0	21.9	22.1	21.6
		1	1	23.3	23.5	23.3	22.5	22.4	22.9	22.6	23.1	23.4	23.0	22.9	23.1
		1	104	23.4	23.1	23.0	23.1	22.7	22.9	22.9	23.3	22.4	23.0	22.5	22.9
		1	105	22.2	22.2	22.4	21.9	22.1	21.8	21.9	21.9	21.8	21.9	22.0	22.0
		50	25	23.4	23.3	23.3	22.7	22.9	22.9	22.8	22.9	22.9	22.9	23.0	23.0
		100	0	22.3	22.3	22.2	21.7	21.9	21.9	21.8	21.9	22.0	21.9	21.9	21.9
	64QAM	1	0	21.8	21.7	21.8	21.4	21.3	21.4	21.1	21.3	21.6	21.3	21.4	21.5
		1	1	21.8	21.7	21.9	21.1	21.3	21.2	21.0	21.4	21.4	21.3	21.3	21.7
		1	104	21.7	22.0	21.9	21.4	21.2	21.5	21.3	21.1	21.4	21.2	21.2	21.3
		1	105	21.7	21.7	22.0	21.4	21.8	20.9	21.0	21.3	21.4	21.3	21.4	21.3
		50	25	21.9	21.8	21.8	21.2	21.4	21.4	21.3	21.4	21.4	21.4	21.5	21.5
		100	0	21.9	21.8	21.7	21.1	21.4	21.4	21.3	21.4	21.5	21.5	21.5	21.4
	256QAM	1	0	19.4	19.6	19.7	19.1	19.1	19.5	19.4	19.5	19.6	19.7	19.7	19.8
		1	1	20.1	20.2	19.5	19.4	19.2	19.5	19.3	19.4	19.1	19.5	19.9	19.0
		1	104	20.1	20.0	19.7	19.5	19.3	19.2	19.1	19.5	19.5	19.6	19.7	19.8
		1	105	20.3	20.0	19.5	19.3	19.3	19.2	19.3	19.5	19.7	19.3	19.7	19.4
		50	25	19.9	19.9	19.8	19.2	19.4	19.4	19.3	19.4	19.4	19.4	19.4	19.4
		100	0	19.9	19.9	19.7	19.2	19.4	19.3	19.3	19.4	19.5	19.5	19.5	19.4



**OUTPUT POWER FOR 5G NR n66 (25.0 MHz)**

Bandwidth (MHz)	Modulation	RB Allocation	RB Offset	Conducted Average (dBm)											
				ANT 2			ANT 0			ANT 1			ANT 5		
				344500	349000	353500	344500	349000	353500	344500	349000	353500	344500	349000	353500
25.0	BPSK	1	0	23.8	24.0	24.0	23.2	23.3	23.5	23.3	23.5	23.6	23.5	23.6	23.5
		1	1	24.4	24.4	24.4	23.5	23.7	<b>23.8</b>	23.7	24.0	24.0	24.1	24.1	<b>24.1</b>
		1	131	<b>24.5</b>	24.3	24.3	23.7	23.8	23.7	23.9	<b>24.1</b>	24.0	23.9	24.0	23.9
		1	132	24.0	23.9	23.8	23.5	23.4	23.3	23.5	23.6	23.3	23.4	23.5	23.5
		64	32	24.4	24.4	24.4	23.5	23.8	23.7	23.8	23.9	23.9	24.0	24.0	23.9
		180	0	23.9	23.8	23.8	23.3	23.4	23.4	23.3	23.4	23.4	23.6	23.4	23.4
	QPSK	1	0	23.3	23.5	23.4	22.6	22.9	22.9	22.9	22.9	23.0	23.1	22.9	23.1
		1	1	24.4	24.4	<b>24.4</b>	23.4	23.7	23.7	23.9	23.9	23.9	<b>24.0</b>	24.0	23.9
		1	131	24.4	24.2	24.4	<b>23.8</b>	<b>23.8</b>	23.7	24.0	<b>24.0</b>	23.8	23.9	24.0	23.8
		1	132	23.5	23.3	23.3	23.0	22.9	22.9	23.0	22.9	22.8	23.1	23.0	22.9
		64	32	24.3	24.3	24.3	23.5	23.8	23.7	23.8	23.8	23.9	24.0	23.9	23.9
		180	0	23.3	23.3	23.3	22.7	23.0	22.9	22.8	23.0	22.9	23.0	22.9	22.9
	16QAM	1	0	22.2	22.8	22.3	22.0	21.9	22.1	21.8	21.8	22.2	21.9	22.3	21.7
		1	1	<b>23.4</b>	23.2	<b>23.4</b>	23.0	23.0	23.3	22.9	23.1	<b>23.1</b>	<b>23.3</b>	23.0	23.2
		1	131	23.4	22.9	23.2	22.9	<b>23.3</b>	22.7	22.9	22.9	23.0	23.1	22.8	22.7
		1	132	22.2	22.1	21.9	21.8	22.0	21.6	21.7	22.0	22.2	22.0	22.3	21.6
		64	32	23.3	23.3	23.3	22.8	22.9	22.9	22.9	22.9	22.9	22.9	22.9	22.8
		180	0	22.4	22.3	22.3	21.7	22.0	21.9	21.8	21.8	21.9	21.9	21.9	21.9
	64QAM	1	0	22.1	21.7	21.8	21.4	21.3	<b>21.7</b>	21.2	21.4	21.4	21.6	21.8	21.6
		1	1	<b>22.1</b>	21.7	21.7	21.2	21.4	21.2	21.1	21.5	21.5	21.8	21.7	<b>21.9</b>
		1	131	21.8	21.6	22.1	21.6	21.7	21.1	21.2	21.3	<b>21.7</b>	21.0	21.4	21.5
		1	132	21.8	22.0	21.9	21.1	21.5	21.3	21.3	21.5	21.5	21.4	21.5	21.3
		64	32	21.8	21.8	21.8	21.3	21.4	21.4	21.4	21.4	21.5	21.5	21.4	21.4
		180	0	21.9	21.9	21.8	21.2	21.4	21.4	21.3	21.4	21.4	21.5	21.4	21.4
	256QAM	1	0	19.7	19.5	19.7	19.0	19.6	19.4	19.5	19.3	19.6	19.7	19.4	19.7
		1	1	19.8	19.6	19.9	19.4	19.5	19.1	19.4	19.5	19.5	<b>19.8</b>	19.6	19.3
		1	131	19.8	<b>20.1</b>	19.7	19.4	19.5	19.1	19.6	19.4	19.4	19.5	19.1	19.4
		1	132	19.8	19.9	19.9	19.2	19.7	<b>19.7</b>	<b>19.7</b>	19.5	19.6	19.7	19.4	19.6
		64	32	19.8	19.9	19.7	19.3	19.4	19.4	19.3	19.4	19.4	19.4	19.5	19.3
		180	0	20.0	19.9	19.8	19.3	19.5	19.4	19.3	19.4	19.5	19.5	19.5	19.3

**OUTPUT POWER FOR 5G NR n66 (30.0 MHz)**

Bandwidth (MHz)	Modulation	RB Allocation	RB Offset	Conducted Average (dBm)											
				ANT 2			ANT 0			ANT 1			ANT 5		
				345000	349000	353000	345000	349000	353000	345000	349000	353000	345000	349000	353000
30.0	BPSK	1	0	23.9	23.9	24.0	23.1	23.3	23.4	23.3	23.4	23.5	23.5	23.4	
		1	1	24.3	24.4	<b>24.4</b>	23.4	23.6	23.6	23.8	23.8	<b>24.1</b>	23.9	23.9	<b>24.1</b>
		1	158	24.4	24.3	24.3	23.7	<b>23.8</b>	23.5	24.0	23.9	23.9	24.0	23.9	23.9
		1	159	24.0	23.9	23.7	23.4	23.4	23.3	23.4	23.5	23.4	23.6	23.4	23.4
		80	40	24.3	24.4	24.3	23.5	23.7	23.6	23.8	24.0	23.9	23.9	23.9	23.9
		160	0	23.9	23.9	23.9	23.2	23.4	23.3	23.3	23.4	23.4	23.3	23.4	23.3
	QPSK	1	0	23.3	23.4	23.4	22.7	22.7	22.9	22.8	22.9	22.9	22.8	23.0	22.9
		1	1	24.3	<b>24.3</b>	24.2	23.4	23.6	23.6	23.7	23.9	23.9	23.9	<b>23.9</b>	23.8
		1	158	24.3	24.3	24.2	<b>23.7</b>	<b>23.7</b>	23.5	24.0	<b>24.0</b>	23.8	23.8	23.8	23.7
		1	159	23.4	23.3	23.2	22.9	22.9	22.8	23.0	23.1	22.8	22.9	22.9	22.8
		80	40	24.3	24.3	24.3	23.5	23.6	23.6	23.7	24.0	23.9	23.9	<b>23.9</b>	23.8
		160	0	23.2	23.3	23.3	22.8	22.9	22.9	22.8	22.9	23.0	22.9	22.9	22.8
	16QAM	1	0	22.5	22.5	22.1	21.6	22.1	22.0	21.9	21.8	22.3	21.7	22.2	21.7
		1	1	23.1	23.3	<b>23.3</b>	22.6	22.7	22.8	22.7	22.9	23.0	22.5	22.9	22.4
		1	158	23.3	23.2	22.9	<b>23.0</b>	22.5	22.6	22.8	<b>23.1</b>	23.0	22.9	<b>23.1</b>	22.5
		1	159	22.5	22.3	22.2	21.8	21.6	21.5	22.1	22.0	22.2	22.2	22.0	21.9
		80	40	23.3	23.3	23.2	22.8	22.9	22.8	22.7	22.8	22.8	22.8	22.9	22.9
		160	0	22.3	22.3	22.3	21.7	21.8	21.9	21.8	21.9	22.0	21.8	21.9	21.8
	64QAM	1	0	21.9	21.9	21.6	21.1	21.2	21.3	21.6	21.4	21.4	21.5	21.1	21.3
		1	1	21.7	22.0	21.7	20.8	21.4	21.3	21.3	21.5	21.2	21.5	21.5	21.2
		1	158	21.5	21.7	21.8	21.3	21.4	<b>21.5</b>	21.5	<b>21.6</b>	<b>21.6</b>	21.3	21.4	21.3
		1	159	<b>22.3</b>	21.4	21.6	21.5	21.1	21.3	21.4	21.3	21.6	21.4	<b>21.6</b>	21.6
		80	40	21.8	21.8	21.7	21.2	21.3	21.3	21.2	21.4	21.4	21.3	21.3	21.4
		160	0	21.8	21.8	21.8	21.2	21.3	21.3	21.3	21.4	21.4	21.3	21.4	21.3
	256QAM	1	0	19.7	19.6	19.6	19.1	19.0	19.5	19.1	19.6	19.3	19.6	19.4	19.5
		1	1	19.6	19.8	19.6	19.2	19.5	19.5	19.6	19.5	<b>19.7</b>	19.6	19.4	19.2
		1	158	19.7	19.8	19.5	19.5	19.2	19.5	19.5	19.7	18.9	<b>19.8</b>	19.3	19.1
		1	159	<b>20.0</b>	<b>20.0</b>	19.4	<b>19.6</b>	19.4	19.2	19.6	19.6	19.4	19.7	19.5	19.5
		80	40	19.9	19.9	19.8	19.3	19.4	19.4	19.2	19.4	19.4	19.4	19.4	19.4
		160	0	19.8	19.9	19.8	19.3	19.3	19.3	19.2	19.4	19.5	19.4	19.4	19.3



**OUTPUT POWER FOR 5G NR n66 (40.0 MHz)**

Bandwidth (MHz)	Modulation	RB Allocation	RB Offset	Conducted Average (dBm)														
				ANT 2			ANT 0			ANT 1			ANT 5					
				346000	349000	352000	346000	349000	352000	346000	349000	352000	346000	349000	352000			
40.0	BPSK	1	0	23.9	23.9	24.0	23.2	23.3	23.5	23.3	23.3	23.4	23.4	23.3	23.5			
		1	1	24.4	24.4	24.4	23.4	23.7	23.7	23.8	23.8	24.0	24.0	23.8	24.0			
		1	214	24.4	24.4	24.2	23.8	23.7	23.7	24.0	23.9	23.9	24.0	23.9	23.8			
		1	215	23.9	23.8	23.8	23.4	23.4	23.4	23.5	23.4	23.5	23.5	23.4	23.3			
		108	54	24.4	24.4	24.2	23.5	23.7	23.8	23.9	23.8	24.0	23.8	23.9	24.0			
		216	0	23.8	23.9	23.7	23.2	23.4	23.4	23.4	23.3	23.5	23.5	23.4	23.4			
	QPSK	1	0	23.3	23.4	23.4	22.5	22.8	22.9	22.7	22.8	23.0	22.9	22.9	23.0			
		1	1	24.3	24.4	24.3	23.4	23.6	23.8	23.8	23.8	24.0	23.9	23.8	24.0			
		1	214	24.3	24.3	24.2	23.7	23.8	23.7	24.0	23.9	24.0	23.9	23.8	23.8			
		1	215	23.3	23.2	23.2	22.9	22.9	22.8	23.0	22.8	22.9	22.9	22.9	22.8			
		108	54	24.3	24.3	24.3	23.6	23.7	23.7	23.9	23.8	24.0	23.8	23.9	23.9			
		216	0	23.3	23.3	23.2	22.8	22.9	23.0	22.8	22.8	22.9	22.9	22.9	22.9			
	16QAM	1	0	22.4	22.6	22.3	21.4	21.7	21.9	21.6	21.5	21.8	22.3	21.6	22.0			
		1	1	23.6	23.3	23.7	22.6	22.1	22.7	22.8	22.7	22.7	22.9	22.8	23.0			
		1	214	23.0	23.4	23.3	23.5	23.0	22.7	22.8	23.1	22.5	22.8	23.0	22.9			
		1	215	22.1	22.3	21.7	22.0	21.7	21.7	22.1	21.6	21.8	22.0	21.9	21.8			
		108	54	23.3	23.3	23.2	22.8	23.0	23.0	22.9	22.8	22.9	22.9	22.9	23.0			
		216	0	22.3	22.3	22.2	21.7	21.8	21.9	21.8	21.8	21.9	21.8	22.0	22.0			
	64QAM	1	0	21.7	21.7	22.1	21.5	21.4	21.4	21.0	20.8	21.2	21.6	21.3	21.2			
		1	1	21.7	21.9	21.6	21.3	21.2	21.1	21.2	21.5	21.3	21.4	21.3	21.7			
		1	214	21.7	21.5	22.1	21.5	21.5	20.7	21.3	21.3	20.9	21.3	21.7	21.5			
		1	215	22.2	22.3	21.7	21.6	21.5	21.3	21.4	21.6	21.4	21.3	21.6	21.3			
		108	54	21.8	21.7	21.8	21.2	21.4	21.4	21.2	21.4	21.5	21.4	21.4	21.5			
		216	0	21.8	21.8	21.7	21.3	21.3	21.5	21.3	21.3	21.5	21.4	21.4	21.5			
256QAM	1	0	19.6	20.0	20.1	19.0	19.1	19.1	19.7	19.5	19.7	19.5	19.5	19.6				
	1	1	19.6	19.9	20.2	19.1	19.3	19.3	19.6	19.3	19.1	19.4	19.3	19.4				
	1	214	20.0	20.0	19.9	19.5	19.2	19.2	19.4	19.3	19.1	19.6	19.5	19.3				
	1	215	19.6	20.2	19.4	19.2	19.4	19.7	19.2	19.4	19.0	19.4	19.5	19.3				
	108	54	19.9	19.9	19.8	19.3	19.5	19.4	19.3	19.4	19.4	19.5	19.5	19.5				
	216	0	19.9	19.9	19.8	19.2	19.4	19.4	19.4	19.4	19.4	19.5	19.4	19.5				

### 8.15. 5G NR n70

Test Engineer ID:	27966PV	Test Date:	2024-02-09 to 2024-02-14
-------------------	---------	------------	--------------------------

#### OUTPUT POWER FOR 5G NR n70 (5.0 MHz)

Bandwidth (MHz)	Modulation	RB Allocation	RB Offset	Conducted Average (dBm)					
				ANT 2			ANT 0		
				339500	340500	341500	339500	340500	341500
5.0	BPSK	1	0	23.9	23.9	24.0	23.2	23.3	23.2
		1	1	<b>24.5</b>	24.4	24.5	23.3	23.8	23.8
		1	23	24.4	24.4	<b>24.5</b>	23.2	<b>23.9</b>	23.8
		1	24	23.9	23.9	23.9	23.2	23.4	23.3
		12	6	24.4	24.4	24.4	23.2	23.8	23.8
		25	0	23.8	23.9	24.0	23.2	23.2	23.3
	QPSK	1	0	23.4	23.3	23.5	22.7	22.8	22.7
		1	1	24.4	24.4	<b>24.5</b>	23.3	23.8	23.8
		1	23	24.4	24.4	24.4	23.3	23.8	<b>23.8</b>
		1	24	23.4	23.4	23.4	22.7	22.8	22.8
		12	6	24.4	24.3	24.4	23.2	23.7	23.8
		25	0	23.4	23.4	23.4	22.7	22.8	22.8
	16QAM	1	0	22.4	22.4	22.4	21.8	21.8	21.5
		1	1	23.4	23.3	<b>23.6</b>	22.8	22.8	22.8
		1	23	23.3	23.3	23.4	22.7	23.0	<b>23.0</b>
		1	24	22.1	22.5	22.4	21.3	21.7	21.5
		12	6	23.5	23.3	23.3	22.6	22.8	22.9
		25	0	22.3	22.3	22.3	21.6	21.8	21.7
	64QAM	1	0	21.8	22.0	21.9	21.5	21.1	21.7
		1	1	22.1	22.0	<b>22.1</b>	21.0	<b>21.9</b>	21.3
		1	23	21.7	21.9	21.5	21.0	21.2	21.7
		1	24	21.8	22.1	22.0	21.4	21.0	21.4
		12	6	21.8	22.0	21.8	21.1	21.2	21.3
		25	0	21.8	21.9	21.8	21.1	21.2	21.3
	256QAM	1	0	<b>20.4</b>	19.8	19.8	19.1	<b>19.6</b>	19.5
1		1	19.9	20.0	20.0	19.3	19.1	19.3	
1		23	20.1	20.0	20.2	19.2	19.2	19.5	
1		24	20.1	19.8	20.2	19.1	19.1	19.5	
12		6	19.9	20.0	20.0	19.2	19.3	19.4	
25		0	19.9	20.0	20.0	19.1	19.3	19.2	

#### OUTPUT POWER FOR 5G NR n70 (10.0 MHz)

Bandwidth (MHz)	Modulation	RB Allocation	RB Offset	Conducted Average (dBm)					
				ANT 2			ANT 0		
				340000	340500	341000	340000	340500	341000
10.0	BPSK	1	0	23.9	23.9	23.9	23.3	23.2	23.2
		1	1	24.4	24.4	24.4	23.7	23.7	23.7
		1	50	24.4	24.4	<b>24.5</b>	<b>23.9</b>	23.7	23.8
		1	51	24.0	24.0	23.9	23.4	23.2	23.4
		25	12	24.4	24.4	24.4	23.8	23.7	23.8
		50	0	23.8	23.9	23.9	23.2	23.3	23.3
	QPSK	1	0	23.5	23.4	23.4	22.8	22.6	22.7
		1	1	24.4	24.4	24.4	23.7	23.7	23.7
		1	50	24.4	24.4	<b>24.4</b>	<b>23.8</b>	23.8	23.8
		1	51	23.4	23.5	23.4	22.8	22.8	22.8
		25	12	24.3	24.4	24.3	23.8	23.7	23.8
		50	0	23.3	23.4	23.4	22.7	22.7	22.7
	16QAM	1	0	22.5	22.3	22.1	21.3	21.5	21.6
		1	1	23.4	23.3	23.3	22.8	22.7	22.8
		1	50	23.4	<b>23.6</b>	23.2	22.8	<b>22.9</b>	22.9
		1	51	22.3	22.4	22.4	21.5	21.7	22.1
		25	12	23.4	23.3	23.4	22.7	22.7	22.7
		50	0	22.3	22.4	22.4	21.8	21.8	21.7
	64QAM	1	0	21.7	22.0	<b>22.1</b>	21.3	21.1	21.2
		1	1	21.7	21.7	21.9	21.2	21.2	<b>21.5</b>
		1	50	21.9	21.9	22.0	21.4	21.4	21.4
		1	51	21.7	21.9	21.9	21.4	21.1	21.1
		25	12	21.8	21.8	21.8	21.2	21.3	21.2
		50	0	21.9	21.8	21.9	21.2	21.3	21.3
	256QAM	1	0	20.3	20.1	19.9	<b>19.7</b>	19.2	19.3
1		1	19.8	19.7	20.0	19.2	19.2	19.1	
1		50	20.2	19.8	19.7	19.5	19.3	19.4	
1		51	<b>20.4</b>	19.8	19.8	19.1	19.3	19.7	
25		12	19.9	19.9	19.9	19.2	19.2	19.3	
50		0	19.9	20.0	19.9	19.2	19.3	19.2	

**OUTPUT POWER FOR 5G NR n70 (15.0 MHz)**

Bandwidth (MHz)	Modulation	RB Allocation	RB Offset	Conducted Average (dBm)					
				ANT 2			ANT 0		
				N/A	340500	N/A	N/A	340500	N/A
15.0	BPSK	1	0	N/A	1702.5	N/A	N/A	1702.5	N/A
		1	1		23.9			23.2	
		1	77		24.4			23.7	
		1	78		24.4			23.8	
		1	78		23.9			23.2	
		36	18		24.3			23.7	
	75	0		23.9			23.3		
	1	0		23.5			22.8		
	1	1		24.4			23.8		
	1	77		24.4			23.7		
	1	78		23.4			22.8		
	36	18		24.4			23.7		
	75	0		23.4			22.7		
	1	0		22.5			21.8		
	1	1		23.5			22.6		
	1	77		23.5			22.7		
	1	78		22.2			21.8		
	36	18		23.2			22.8		
	75	0		22.4			21.8		
	1	0		21.5			21.3		
	1	1		21.8			20.9		
	1	77		21.7			21.0		
	1	78		22.0			21.3		
	36	18		21.7			21.3		
	75	0		21.9			21.2		
	1	0		19.9			19.4		
	1	1		20.0			19.0		
	1	77		20.0			19.4		
	1	78		19.8			19.5		
	36	18		20.0			19.3		
75	0		19.9			19.2			

### 8.16. LTE BAND 71 AND 5G NR n71

#### LTE BAND 71

Test Engineer ID:	39005RA	Test Date:	2024-04-03
-------------------	---------	------------	------------

#### OUTPUT POWER FOR LTE BAND 71 (5.0 MHz)

Bandwidth (MHz)	Modulation	RB Allocation	RB Offset	Conducted Average (dBm)					
				ANT 0			ANT 1		
				133147	133297	133447	133147	133297	133447
5.0	QPSK	1	0	24.3	24.3	24.3	<b>24.4</b>	<b>24.4</b>	24.3
		1	12	24.2	24.3	24.3	24.2	24.2	24.3
		1	24	24.3	24.3	<b>24.4</b>	24.3	24.2	24.3
		12	0	23.5	23.5	23.5	23.2	23.3	23.3
		12	6	23.5	23.5	23.5	23.2	23.3	23.3
		12	11	23.5	23.4	23.4	23.2	23.3	23.2
		25	0	23.5	23.5	23.5	23.2	23.3	23.3
	16QAM	1	0	<b>23.8</b>	23.8	23.8	23.4	23.7	<b>23.7</b>
		1	12	23.6	23.6	23.6	23.3	23.7	23.4
		1	24	23.7	23.7	23.7	23.5	<b>23.7</b>	23.3
		12	0	23.0	22.8	22.8	22.5	22.4	22.3
		12	6	22.9	22.8	22.7	22.5	22.4	22.3
		12	11	22.9	22.8	22.7	22.5	22.4	22.3
		25	0	22.8	22.9	22.8	22.5	22.3	22.3
	64QAM	1	0	22.9	22.9	22.9	22.4	22.6	<b>22.7</b>
		1	12	22.9	22.9	23.0	22.3	22.4	22.5
		1	24	23.0	22.9	<b>23.0</b>	22.5	22.5	22.5
		12	0	21.9	21.8	21.8	21.5	21.4	21.3
		12	6	21.9	21.8	21.8	21.5	21.4	21.3
		12	11	21.8	21.7	21.7	21.5	21.3	21.3
		25	0	21.9	21.8	21.8	21.5	21.3	21.3
	256QAM	1	0	19.9	19.9	<b>20.0</b>	19.6	<b>19.7</b>	<b>19.7</b>
		1	12	19.9	19.8	19.8	19.5	<b>19.7</b>	<b>19.7</b>
		1	24	19.9	19.8	19.8	19.6	<b>19.7</b>	<b>19.7</b>
		12	0	19.9	19.8	19.9	19.4	<b>19.7</b>	<b>19.7</b>
12		6	19.9	19.8	19.8	19.4	19.7	<b>19.7</b>	
12		11	19.9	19.8	19.8	19.4	19.7	<b>19.7</b>	
25		0	19.9	19.8	19.8	19.5	19.7	<b>19.7</b>	

#### OUTPUT POWER FOR LTE BAND 71 (10.0 MHz)

Bandwidth (MHz)	Modulation	RB Allocation	RB Offset	Conducted Average (dBm)					
				ANT 0			ANT 1		
				133172	133322	133422	133172	133322	133422
10.0	QPSK	1	0	24.9	24.3	24.9	24.4	24.4	<b>24.4</b>
		1	24	<b>24.9</b>	24.2	24.9	24.2	24.3	24.4
		1	49	24.7	24.3	24.8	24.2	24.3	24.4
		25	0	23.8	23.4	23.9	23.3	23.7	23.4
		25	12	23.8	23.4	23.8	23.3	23.6	23.4
		25	24	23.8	23.3	23.7	23.2	23.6	23.3
		50	0	23.8	23.4	23.8	23.3	23.6	23.4
	16QAM	1	0	23.8	23.8	<b>23.9</b>	23.4	<b>23.6</b>	23.5
		1	24	<b>23.9</b>	23.8	23.8	23.4	23.5	23.5
		1	49	23.8	23.6	23.6	23.3	23.5	23.3
		25	0	22.8	22.8	22.9	22.3	22.7	22.4
		25	12	22.8	22.8	22.8	22.2	22.7	22.3
		25	24	22.8	22.7	22.7	22.2	22.6	22.3
		50	0	22.8	22.8	22.8	22.3	22.7	22.4
	64QAM	1	0	23.0	<b>23.1</b>	23.0	22.5	<b>22.7</b>	22.7
		1	24	23.0	22.9	23.0	22.4	<b>22.7</b>	22.6
		1	49	22.9	22.8	22.7	22.4	<b>22.7</b>	22.4
		25	0	21.8	21.8	21.9	21.3	21.7	21.4
		25	12	21.8	21.7	21.8	21.3	21.7	21.4
		25	24	21.8	21.7	21.8	21.3	21.6	21.3
		50	0	21.8	21.7	21.8	21.3	21.7	21.4
	256QAM	1	0	20.0	<b>20.1</b>	20.0	19.5	<b>19.7</b>	19.5
		1	24	19.9	20.1	19.8	19.4	<b>19.7</b>	19.4
		1	49	19.9	19.9	19.7	19.3	<b>19.7</b>	19.3
		25	0	19.9	19.9	19.9	19.4	<b>19.7</b>	19.4
25		12	19.8	19.8	19.8	19.3	<b>19.7</b>	19.4	
25		24	19.8	19.7	19.8	19.3	19.7	19.3	
50		0	19.8	19.8	19.8	19.3	19.7	19.3	

**OUTPUT POWER FOR LTE BAND 71 (15.0 MHz)**

Bandwidth (MHz)	Modulation	RB Allocation	RB Offset	Conducted Average (dBm)					
				ANT 0			ANT 1		
				133197 670.5	133297 680.5	133397 690.5	133197 670.5	133297 680.5	133397 690.5
15.0	QPSK	1	0	24.9	24.6	24.8	24.6	24.4	24.4
		1	37	24.6	24.4	24.4	24.3	24.2	24.1
		1	74	24.7	24.4	24.6	24.3	24.2	24.3
		36	0	23.9	23.5	23.8	23.6	23.5	23.4
		36	16	23.9	23.4	23.7	23.5	23.7	23.4
		36	35	23.8	23.4	23.7	23.4	23.7	23.4
	16QAM	75	0	23.9	23.5	23.7	23.5	23.7	23.4
		1	0	24.0	23.8	23.9	23.6	23.7	23.6
		1	37	23.9	23.6	23.7	23.4	23.7	23.3
		1	74	23.8	23.6	23.5	23.3	23.7	23.3
		36	0	22.9	22.8	22.8	22.5	22.7	22.4
		36	16	22.8	22.7	22.7	22.4	22.7	22.4
	64QAM	36	35	22.8	22.7	22.7	22.4	22.7	22.3
		75	0	22.8	22.8	22.7	22.5	22.7	22.3
		1	0	23.1	23.1	23.1	22.4	22.7	22.7
		1	37	23.0	23.0	22.9	22.2	22.5	22.5
		1	74	23.0	23.0	22.8	22.2	22.5	22.5
		36	0	21.9	21.8	21.8	21.4	21.5	21.4
	256QAM	36	16	21.9	21.8	21.7	21.3	21.4	21.4
		36	35	21.8	21.7	21.6	21.3	21.3	21.3
		75	0	21.8	21.8	21.7	21.3	21.3	21.4
		1	0	20.1	20.0	20.0	19.6	19.7	19.5
		1	37	20.0	19.7	19.8	19.5	19.7	19.2
		1	74	20.0	19.7	19.7	19.4	19.7	19.2
256QAM	36	0	19.9	19.8	19.7	19.4	19.7	19.4	
	36	16	19.8	19.7	19.7	19.3	19.7	19.3	
	36	35	19.8	19.7	19.6	19.2	19.6	19.3	
	75	0	19.8	19.7	19.7	19.3	19.6	19.4	

**OUTPUT POWER FOR LTE BAND 71 (20.0 MHz)**

Bandwidth (MHz)	Modulation	RB Allocation	RB Offset	Conducted Average (dBm)					
				ANT 0			ANT 1		
				133222 673.0	133322 683.0	133372 688.0	133222 673.0	133322 683.0	133372 688.0
20.0	QPSK	1	0	24.8	24.6	24.8	24.6	24.4	24.6
		1	49	24.8	24.4	24.8	24.5	24.0	24.1
		1	99	24.5	24.4	24.5	24.2	24.1	24.3
		50	0	23.8	23.5	23.8	23.5	23.7	23.5
		50	24	23.7	23.4	23.7	23.4	23.7	23.4
		50	49	23.7	23.3	23.6	23.4	23.6	23.4
	16QAM	100	0	23.7	23.4	23.7	23.4	23.7	23.5
		1	0	24.1	23.9	24.1	23.7	23.7	23.7
		1	49	24.1	23.9	24.1	23.7	23.7	23.6
		1	99	23.9	23.6	23.7	23.6	23.6	23.4
		50	0	22.8	22.9	22.8	22.5	22.7	22.5
		50	24	22.7	22.8	22.7	22.4	22.7	22.4
	64QAM	50	49	22.7	22.7	22.6	22.3	22.6	22.4
		100	0	22.8	22.8	22.8	22.5	22.7	22.4
		1	0	23.0	23.0	23.1	22.7	22.7	22.7
		1	49	23.1	22.8	23.0	22.6	22.6	22.7
		1	99	22.9	22.9	22.7	22.7	22.6	22.4
		50	0	21.8	21.9	21.9	21.5	21.5	21.6
	256QAM	50	24	21.8	21.8	21.8	21.5	21.5	21.4
		50	49	21.7	21.7	21.7	21.4	21.4	21.4
		100	0	21.8	21.8	21.8	21.5	21.5	21.5
		1	0	19.9	20.1	19.9	19.7	19.7	19.7
		1	49	19.8	19.9	19.8	19.7	19.6	19.6
		1	99	19.6	19.9	19.5	19.4	19.5	19.4
256QAM	50	0	19.8	19.9	19.8	19.5	19.5	19.5	
	50	24	19.7	19.8	19.7	19.4	19.5	19.4	
	50	49	19.7	19.7	19.6	19.3	19.4	19.3	
	100	0	19.7	19.8	19.7	19.4	19.5	19.4	

**5G NR n71**

<b>Test Engineer ID:</b>	27966PV	<b>Test Date:</b>	2024-02-09
--------------------------	---------	-------------------	------------

**OUTPUT POWER FOR 5G NR n71 (5.0 MHz)**

Bandwidth (MHz)	Modulation	RB Allocation	RB Offset	Conducted Average (dBm)					
				ANT 0			ANT 1		
				133100 665.5	136100 680.5	139100 695.5	133100 665.5	136100 680.5	139100 695.5
5.0	BPSK	1	0	23.6	24.1	24.1	23.9	24.0	23.9
		1	1	23.8	<b>24.7</b>	24.6	24.4	<b>24.5</b>	24.4
		1	23	23.8	<b>24.7</b>	24.5	24.4	<b>24.5</b>	24.2
		1	24	23.6	24.1	24.1	23.9	23.9	23.8
		12	6	23.8	24.6	24.6	24.5	24.3	24.2
	25	0	23.6	24.1	24.1	24.0	23.9	23.8	
	QPSK	1	0	23.1	23.7	23.6	23.5	23.5	23.4
		1	1	23.9	24.7	<b>24.7</b>	24.4	<b>24.5</b>	24.4
		1	23	23.8	24.6	24.6	24.3	24.4	24.4
		1	24	23.1	23.6	23.6	23.3	23.4	23.2
		12	6	23.8	24.6	24.5	24.4	24.4	24.3
	25	0	23.1	23.6	23.6	23.4	23.4	23.3	
	16QAM	1	0	22.3	22.6	22.8	22.7	22.2	22.1
		1	1	23.2	23.5	<b>23.7</b>	<b>23.6</b>	23.4	23.5
		1	23	22.9	23.3	23.5	23.3	23.4	23.2
		1	24	22.1	22.2	22.6	22.5	22.4	22.1
		12	6	23.1	23.6	<b>23.7</b>	23.5	23.3	23.2
	25	0	22.1	22.7	22.6	22.4	22.5	22.3	
	64QAM	1	0	21.9	22.3	22.2	21.8	21.8	21.8
		1	1	21.9	22.2	22.2	22.0	21.9	<b>22.2</b>
		1	23	21.5	<b>22.3</b>	21.9	22.1	21.9	22.0
		1	24	21.7	22.3	22.0	22.1	21.6	21.8
		12	6	21.7	22.1	22.1	22.0	22.0	21.7
	25	0	21.6	22.0	22.1	21.9	21.9	21.7	
	256QAM	1	0	19.6	<b>20.3</b>	20.0	20.2	19.9	20.1
1		1	19.5	20.2	20.1	20.1	20.0	<b>20.2</b>	
1		23	19.8	20.0	20.2	20.0	20.0	20.0	
1		24	19.8	20.1	20.2	19.8	20.2	20.1	
12		6	19.7	20.1	20.1	19.9	19.9	19.8	
25	0	19.7	20.2	20.1	19.9	19.9	19.8		

**OUTPUT POWER FOR 5G NR n71 (10.0 MHz)**

Bandwidth (MHz)	Modulation	RB Allocation	RB Offset	Conducted Average (dBm)					
				ANT 0			ANT 1		
				133600 668.0	136600 683.0	138600 693.0	133600 668.0	136600 683.0	138600 693.0
10.0	BPSK	1	0	24.2	24.0	24.2	23.9	23.8	23.8
		1	1	<b>24.7</b>	24.5	24.6	<b>24.5</b>	24.4	24.4
		1	50	<b>24.7</b>	24.6	24.6	24.4	24.4	24.3
		1	51	24.2	24.1	24.0	23.9	23.9	23.8
		25	12	24.5	24.6	24.6	24.4	24.4	24.4
	50	0	24.1	24.0	24.1	23.8	23.9	23.9	
	QPSK	1	0	23.6	23.6	23.6	23.4	23.4	23.3
		1	1	24.6	24.6	24.6	24.4	24.3	24.3
		1	50	24.6	24.6	24.5	24.4	24.3	24.2
		1	51	23.6	23.7	23.5	23.3	23.4	23.3
		25	12	24.6	24.6	<b>24.7</b>	24.3	24.4	<b>24.5</b>
	50	0	23.5	23.5	23.6	23.3	23.4	23.4	
	16QAM	1	0	22.7	22.7	22.7	22.3	22.4	22.0
		1	1	23.5	23.5	23.6	23.4	23.0	23.1
		1	50	23.5	<b>23.8</b>	23.4	23.3	23.3	23.1
		1	51	22.7	22.6	22.6	22.2	22.2	22.3
		25	12	23.6	23.5	23.7	<b>23.4</b>	23.3	<b>23.4</b>
	50	0	22.6	22.5	22.6	22.4	22.3	22.3	
	64QAM	1	0	22.0	22.0	22.2	21.5	21.9	21.9
		1	1	22.0	21.9	22.0	21.9	<b>22.3</b>	22.1
		1	50	<b>22.6</b>	22.2	22.0	21.7	21.7	21.5
		1	51	22.5	21.9	22.4	21.7	21.7	21.6
		25	12	22.0	22.0	22.1	21.8	21.8	21.8
	50	0	22.0	22.0	22.1	21.9	21.8	21.9	
	256QAM	1	0	<b>20.5</b>	20.1	19.8	19.9	<b>20.2</b>	19.8
1		1	20.1	20.2	20.1	19.9	19.9	20.1	
1		50	20.5	20.3	20.3	19.8	19.8	19.7	
1		51	19.9	20.1	19.9	20.1	19.9	19.4	
25		12	20.1	20.2	20.1	19.8	19.9	19.8	
50	0	20.0	20.1	20.2	20.0	19.9	19.9		

**OUTPUT POWER FOR 5G NR n71 (15.0 MHz)**

Bandwidth (MHz)	Modulation	RB Allocation	RB Offset	Conducted Average (dBm)					
				ANT 0			ANT 1		
				134100	136100	138100	134100	136100	138100
15.0	BPSK	1	0	24.1	24.1	24.1	23.9	23.9	23.8
		1	1	24.6	24.6	24.6	24.3	24.4	24.3
		1	77	24.7	24.6	24.5	24.3	24.2	24.2
		1	78	24.1	24.2	24.0	23.8	23.8	23.7
		36	18	24.5	24.5	24.7	24.4	24.3	24.3
		75	0	24.1	24.1	24.2	23.9	23.9	23.9
	QPSK	1	0	23.6	23.5	23.6	23.4	23.3	23.3
		1	1	24.6	24.5	24.7	24.4	24.3	24.3
		1	77	24.6	24.6	24.6	24.3	24.3	24.2
		1	78	23.6	23.5	23.6	23.3	23.2	23.2
		36	18	24.6	24.6	24.6	24.4	24.4	24.4
		75	0	23.6	23.6	23.6	23.4	23.3	23.4
	16QAM	1	0	22.7	22.7	22.5	22.3	22.3	22.2
		1	1	23.4	23.6	23.4	23.3	23.2	23.3
		1	77	23.4	23.5	23.6	23.6	23.0	23.2
		1	78	22.7	22.4	22.3	22.7	22.2	22.1
		36	18	23.7	23.7	23.5	23.4	23.4	23.4
		75	0	22.6	22.6	22.7	22.5	22.4	22.3
	64QAM	1	0	22.0	22.2	21.9	22.0	21.6	22.1
		1	1	22.3	22.1	22.3	22.0	21.8	22.0
		1	77	22.0	22.1	22.3	22.3	21.5	21.8
		1	78	22.1	22.1	22.1	22.0	21.6	21.5
		36	18	22.1	22.1	22.1	21.8	21.9	21.9
		75	0	22.1	22.0	22.1	21.8	21.9	21.9
	256QAM	1	0	20.5	20.2	20.0	19.9	20.0	19.7
		1	1	20.2	20.0	20.1	20.0	19.7	19.8
		1	77	19.9	20.0	20.2	20.0	19.9	20.0
		1	78	20.3	20.0	20.1	19.9	20.0	19.7
		36	18	20.1	20.1	20.2	19.8	19.9	19.9
		75	0	20.2	20.0	20.1	19.9	19.9	19.8

**OUTPUT POWER FOR 5G NR n71 (20.0 MHz)**

Bandwidth (MHz)	Modulation	RB Allocation	RB Offset	Conducted Average (dBm)					
				ANT 0			ANT 1		
				134600	136600	137600	134600	136600	137600
20.0	BPSK	1	0	24.2	24.1	24.2	24.0	23.9	23.9
		1	1	24.6	24.6	24.6	24.4	24.5	24.5
		1	104	24.6	24.7	24.6	24.4	24.4	24.2
		1	105	24.0	24.1	24.1	23.9	23.9	23.8
		50	25	24.6	24.6	24.6	24.4	24.3	24.3
		100	0	24.1	24.0	24.0	23.9	23.8	23.8
	QPSK	1	0	23.7	23.7	23.6	23.4	23.4	23.4
		1	1	24.7	24.7	24.6	24.4	24.4	24.3
		1	104	24.6	24.7	24.6	24.3	24.4	24.2
		1	105	23.6	23.7	23.5	23.3	23.4	23.3
		50	25	24.7	24.6	24.6	24.4	24.3	24.3
		100	0	23.6	23.5	23.5	23.4	23.3	23.4
	16QAM	1	0	22.7	22.7	22.5	22.6	22.5	22.5
		1	1	23.7	23.5	23.7	23.6	23.4	23.6
		1	104	23.6	23.5	23.5	23.3	23.5	23.1
		1	105	22.2	22.7	22.4	22.1	22.2	22.1
		50	25	23.6	23.6	23.5	23.4	23.3	23.3
		100	0	22.5	22.6	22.5	22.4	22.4	22.3
	64QAM	1	0	22.3	22.0	21.8	22.0	21.7	22.0
		1	1	22.4	22.0	22.3	21.9	22.2	21.7
		1	104	22.3	22.0	22.3	21.8	21.6	21.8
		1	105	22.3	22.1	22.0	21.7	21.7	21.7
		50	25	22.0	22.1	22.1	21.8	21.9	21.8
		100	0	22.1	22.1	22.0	21.9	21.8	21.8
	256QAM	1	0	19.8	20.0	20.2	19.8	19.9	19.8
		1	1	19.9	20.3	20.0	20.0	20.0	20.0
		1	104	20.1	20.1	19.9	20.0	20.0	19.8
		1	105	20.4	20.3	20.5	20.3	19.9	19.7
		50	25	20.1	20.0	20.0	19.9	19.9	19.8
		100	0	20.1	20.0	20.0	20.0	19.9	19.8

### 8.17. 5G NR n77 (Part 27 3450-3550MHz)

<b>Test Engineer ID:</b>	32934IG, 27979HN and 27966PV	<b>Test Date:</b>	2024-03-08 to 2024-03-26
--------------------------	---------------------------------	-------------------	--------------------------

#### OUTPUT POWER FOR 5G NR n77 (10.0 MHz)

Bandwidth (MHz)	Modulation	RB Allocation	RB Offset	Conducted Average (dBm)											
				ANT 6			ANT 7			ANT 1			ANT 5		
				630333	633332	636333	630333	633332	636333	630333	633332	636333	630333	633332	636333
10.0	BPSK	1	0	24.3	24.3	23.9	22.7	22.8	22.6	24.2	24.0	23.8	23.4	23.5	23.2
		1	1	24.9	24.8	24.4	23.4	23.2	23.0	24.5	24.5	24.5	24.1	24.1	23.8
		1	22	24.9	24.7	24.4	23.4	23.3	23.0	24.6	24.4	24.4	24.0	24.1	23.8
		1	23	24.3	24.2	24.1	22.9	22.7	22.5	24.2	24.1	23.9	23.6	23.5	23.3
		12	6	24.8	24.8	24.5	23.3	23.3	23.0	24.6	24.5	24.4	24.0	24.0	23.8
		24	0	24.4	24.2	23.9	22.9	22.7	22.5	24.0	24.0	23.9	23.6	23.6	23.3
	QPSK	1	0	23.8	23.6	23.4	22.4	22.3	21.9	23.5	23.5	23.3	22.9	23.2	22.7
		1	1	24.9	24.8	24.5	23.3	23.3	23.0	24.6	24.5	24.4	24.0	24.2	23.8
		1	22	24.9	24.7	24.4	23.4	23.1	22.9	24.6	24.5	24.4	24.1	24.0	23.8
		1	23	23.8	23.6	23.4	22.3	22.2	22.0	23.6	23.6	23.3	23.1	23.0	22.8
		12	6	24.8	24.7	24.4	23.3	23.2	23.0	24.6	24.5	24.4	24.2	24.0	23.8
		24	0	23.8	23.7	23.4	22.3	22.3	22.0	23.7	23.4	23.3	23.0	23.1	22.7
	16QAM	1	0	23.0	22.6	22.6	21.2	21.3	20.7	22.6	22.6	22.7	22.0	22.2	21.7
		1	1	23.9	23.6	23.1	22.3	22.2	22.0	23.7	23.4	23.4	22.9	22.9	22.6
		1	22	23.7	23.6	23.7	22.2	22.1	21.9	23.2	23.7	23.2	23.0	23.1	22.7
		1	23	22.6	23.1	22.4	21.1	21.1	20.9	22.6	22.4	22.1	22.2	21.9	21.6
		12	6	23.9	23.7	23.4	22.5	22.3	22.0	23.7	23.5	23.5	23.2	23.0	22.9
		24	0	22.8	22.7	22.4	21.4	21.2	21.0	22.6	22.5	22.4	22.1	22.1	21.7
	64QAM	1	0	22.6	22.2	21.9	21.2	20.7	20.8	22.2	22.0	22.1	21.3	21.9	21.3
		1	1	22.2	22.3	22.0	20.7	20.7	20.6	22.1	21.9	21.8	21.5	21.5	21.2
		1	22	22.2	22.3	22.0	20.8	20.5	20.8	22.1	21.9	21.7	21.5	22.0	21.3
		1	23	22.4	22.4	21.8	20.6	20.6	20.8	22.1	21.9	21.9	21.4	21.9	21.4
		12	6	22.2	22.2	22.0	20.8	20.7	20.6	22.1	22.0	21.9	21.4	21.6	21.1
		24	0	22.3	22.2	21.8	20.9	20.8	20.4	22.1	22.0	21.9	21.6	21.6	21.3
	256QAM	1	0	20.2	20.3	19.9	18.8	18.8	18.6	20.0	20.1	19.9	19.7	19.5	19.3
		1	1	20.3	20.2	19.9	18.5	18.5	18.9	19.9	20.0	19.7	19.7	19.7	19.1
		1	22	20.6	20.2	19.9	18.8	18.4	18.8	20.0	20.0	20.0	19.4	19.4	19.1
		1	23	20.1	20.2	19.9	18.7	18.4	18.8	20.1	20.2	19.7	19.8	19.7	19.4
		12	6	20.3	20.3	19.9	18.9	18.8	18.5	20.0	20.0	19.8	19.5	19.5	19.2
		24	0	20.3	20.3	20.2	18.8	18.7	18.5	20.1	19.9	19.9	19.6	19.5	19.3

#### OUTPUT POWER FOR 5G NR n77 (15.0 MHz)

Bandwidth (MHz)	Modulation	RB Allocation	RB Offset	Conducted Average (dBm)											
				ANT 6			ANT 7			ANT 1			ANT 5		
				630500	633332	636166	630500	633332	636166	630500	633332	636166	630500	633332	636166
15.0	BPSK	1	0	24.3	24.3	23.9	22.9	22.7	22.5	24.0	24.1	23.9	23.6	24.1	23.3
		1	1	24.8	24.8	24.5	23.4	23.3	23.0	24.5	24.5	24.3	24.1	24.1	23.8
		1	36	24.8	24.7	24.5	23.4	23.3	23.1	24.6	24.6	24.3	24.1	24.1	23.8
		1	37	24.3	24.2	23.9	22.9	22.6	22.6	24.0	24.0	23.9	23.6	23.6	23.4
		18	9	24.9	24.7	24.4	23.3	23.2	23.1	24.5	24.5	24.4	24.2	24.1	23.9
		36	0	24.4	24.1	23.9	23.0	22.8	22.6	24.0	24.0	23.9	23.7	23.6	23.3
	QPSK	1	0	23.8	23.8	23.5	22.3	22.2	22.0	23.4	23.5	23.4	23.0	23.2	22.8
		1	1	24.8	24.8	24.6	23.3	23.3	23.1	24.4	24.7	24.3	24.1	24.0	23.8
		1	36	24.8	24.6	24.5	23.3	23.1	23.1	24.5	24.6	24.4	24.1	24.1	23.8
		1	37	23.8	23.5	23.5	22.3	22.2	22.0	23.6	23.5	23.4	23.2	23.1	22.6
		18	9	24.8	24.8	24.4	23.4	23.3	23.1	24.4	24.5	24.4	24.1	24.1	23.7
		36	0	23.8	23.7	23.5	22.4	22.2	22.1	23.6	23.5	23.4	23.2	23.0	22.8
	16QAM	1	0	22.8	22.5	22.3	21.1	21.3	21.1	22.4	22.8	22.5	22.2	22.3	21.5
		1	1	23.7	23.6	23.5	22.0	22.2	22.0	23.3	23.3	23.4	23.0	23.2	22.5
		1	36	23.8	23.6	23.5	22.5	22.2	22.0	23.4	23.5	23.5	23.1	23.2	22.8
		1	37	22.7	22.6	22.6	21.3	20.9	21.1	22.5	22.4	22.3	22.0	22.0	21.6
		18	9	23.9	23.8	23.5	22.4	22.3	21.9	23.4	23.6	23.3	23.2	23.0	22.8
		36	0	22.9	22.8	22.5	21.3	21.2	21.0	22.4	22.4	22.3	22.1	22.0	21.8
	64QAM	1	0	22.1	22.3	22.0	20.7	20.9	20.4	22.2	21.9	22.1	21.5	21.6	21.6
		1	1	22.2	22.4	22.0	20.8	20.9	20.7	21.7	22.0	22.2	21.3	21.6	21.5
		1	36	22.5	22.1	22.1	21.0	20.8	20.7	22.3	22.2	22.0	21.6	21.6	21.7
		1	37	22.3	22.2	22.0	21.0	20.8	20.7	21.6	22.0	21.9	21.5	21.5	21.4
		18	9	22.3	22.2	22.0	20.8	20.7	20.4	21.9	22.0	21.9	21.6	21.6	21.3
		36	0	22.3	22.2	21.9	20.8	20.7	20.4	22.0	21.9	21.9	21.6	21.6	21.2
	256QAM	1	0	20.3	20.6	19.7	19.1	18.7	18.7	19.9	20.0	20.0	19.4	19.6	19.2
		1	1	20.6	20.5	19.7	19.1	18.8	18.8	19.8	20.0	19.9	19.7	19.6	19.4
		1	36	20.1	20.3	20.1	19.0	18.7	18.7	20.1	20.0	20.0	19.8	19.5	19.2
		1	37	20.5	20.4	20.1	19.0	18.7	18.8	19.9	19.6	20.1	19.8	19.4	19.2
		18	9	20.3	20.2	19.9	18.9	18.7	18.4	20.1	20.0	20.0	19.6	19.6	19.3
		36	0	20.3	20.2	20.3	18.9	18.6	18.4	20.0	20.0	19.9	19.7	19.6	19.3



**OUTPUT POWER FOR 5G NR n77 (20.0 MHz)**

Bandwidth (MHz)	Modulation	RB Allocation	RB Offset	Conducted Average (dBm)											
				ANT 6			ANT 7			ANT 1			ANT 5		
				630666	633332	635998	630666	633332	635998	630666	633332	635998	630666	633332	635998
20.0	BPSK	1	0	24.3	24.3	24.0	22.8	22.7	22.5	24.0	23.9	23.8	23.6	23.6	23.4
		1	1	24.8	24.9	24.5	23.4	23.2	23.0	24.5	24.5	24.3	24.1	24.2	23.8
		1	49	25.0	24.7	24.4	23.3	23.1	23.1	24.6	24.4	24.3	24.2	24.0	23.7
		1	50	24.5	24.1	23.9	22.8	22.6	22.6	24.1	23.9	23.8	23.7	23.5	23.3
		25	12	24.9	24.6	24.5	23.3	23.2	23.1	24.5	24.6	24.4	24.1	24.2	23.8
	QPSK	50	0	24.3	24.2	24.0	22.9	22.8	22.6	24.1	24.1	23.8	23.7	23.6	23.2
		1	0	23.9	23.8	23.3	22.4	22.4	22.0	23.4	23.6	23.3	23.1	23.1	22.7
		1	1	24.8	24.9	24.4	23.2	23.3	23.0	24.6	24.5	24.3	24.0	24.2	23.8
		1	49	24.9	24.6	24.4	23.3	23.1	23.0	24.5	24.4	24.3	24.2	24.0	23.8
		1	50	23.9	23.7	23.4	22.5	22.1	22.1	23.6	23.5	23.3	23.2	23.0	22.8
	16QAM	25	12	24.9	24.8	24.5	23.5	23.2	23.1	24.5	24.6	24.4	24.2	24.2	23.8
		50	0	23.8	23.6	23.4	22.4	22.2	22.0	23.6	23.4	23.4	23.2	23.1	22.8
		1	0	23.0	23.2	22.5	21.2	21.4	20.8	22.3	22.6	22.2	22.1	22.0	21.9
		1	1	23.7	23.8	23.2	22.3	22.3	22.0	23.8	23.6	23.3	23.0	23.2	22.9
		1	49	23.7	23.6	23.6	22.3	22.2	21.8	23.6	23.4	23.5	23.2	22.9	22.9
	64QAM	1	50	22.9	23.3	22.4	21.4	20.9	21.0	22.4	22.4	22.5	22.3	21.9	21.7
		25	12	23.8	23.7	23.4	22.3	22.1	22.0	23.6	23.6	23.4	23.2	23.1	22.8
		50	0	22.8	22.6	22.4	21.4	21.3	21.0	22.5	22.5	22.3	22.2	22.1	21.8
		1	0	22.4	22.1	22.0	20.9	20.8	20.2	22.1	22.0	22.1	21.5	21.7	21.5
		1	1	22.4	22.2	22.0	20.9	20.8	20.3	21.8	21.8	21.9	21.3	21.7	21.4
	256QAM	1	49	22.7	22.6	21.7	21.0	20.7	20.2	22.1	21.6	22.0	21.6	21.5	21.2
		1	50	22.4	22.0	22.3	21.0	20.6	20.3	22.1	22.0	22.1	22.0	21.5	21.5
		25	12	22.4	22.2	22.0	20.9	20.8	20.5	22.0	22.0	21.9	21.7	21.5	21.3
		50	0	22.4	22.2	21.9	20.9	20.7	20.6	22.0	22.0	21.9	21.7	21.7	21.3
		1	0	20.2	20.4	19.9	18.8	18.7	18.5	20.0	20.0	19.9	19.4	19.5	19.4
	256QAM	1	1	20.7	20.4	19.9	18.8	18.8	18.8	19.9	20.0	20.0	19.4	19.5	19.4
		1	49	20.2	20.1	19.7	18.8	19.0	18.6	20.2	19.9	19.6	19.9	19.4	19.6
		1	50	20.6	20.3	19.9	18.8	18.9	18.5	20.0	20.0	19.6	20.0	19.3	19.3
		25	12	20.3	20.2	19.9	18.9	18.6	18.5	20.0	19.9	19.8	19.7	19.5	19.3
		50	0	20.3	20.2	20.4	18.8	18.8	18.5	19.9	19.9	19.9	19.5	19.7	19.2

**OUTPUT POWER FOR 5G NR n77 (25.0 MHz)**

Bandwidth (MHz)	Modulation	RB Allocation	RB Offset	Conducted Average (dBm)											
				ANT 6			ANT 7			ANT 1			ANT 5		
				630833	633332	635833	630833	633332	635833	630833	633332	635833	630833	633332	635833
25.0	BPSK	1	0	24.3	24.3	24.0	22.8	22.9	22.5	24.1	24.1	23.9	23.7	23.6	23.4
		1	1	24.9	24.8	24.5	23.4	23.3	23.1	24.6	24.6	24.4	24.1	24.2	24.0
		1	63	24.9	24.6	24.4	23.4	23.2	23.0	24.5	24.5	24.5	24.2	24.0	23.9
		1	64	24.4	24.1	24.0	23.0	22.6	22.5	24.0	24.1	24.0	23.9	23.5	23.4
		32	16	24.8	24.8	24.5	23.4	23.2	23.1	24.6	24.5	24.4	24.2	24.2	23.9
	QPSK	64	0	24.3	24.2	24.0	22.9	22.7	22.6	24.1	24.1	23.9	23.7	23.5	23.4
		1	0	23.9	23.9	23.6	22.5	22.4	22.0	23.5	23.6	23.4	23.1	23.3	22.9
		1	1	24.8	24.8	24.5	23.4	23.3	23.1	24.5	24.6	24.5	24.1	24.2	23.8
		1	63	24.9	24.7	24.5	23.4	23.2	23.1	24.6	24.6	24.6	24.3	24.0	23.9
		1	64	23.9	23.7	23.5	22.4	22.1	22.1	23.7	23.5	23.5	23.3	23.0	22.9
	16QAM	32	16	24.8	24.7	24.5	23.4	23.3	23.1	24.6	24.6	24.4	24.2	24.0	23.9
		64	0	23.9	23.8	23.4	22.5	22.2	22.1	23.5	23.5	23.6	23.2	23.2	22.9
		1	0	22.6	23.1	22.6	21.4	21.4	21.0	22.3	22.6	22.6	22.3	22.2	21.8
		1	1	23.6	23.7	23.5	22.5	22.2	21.9	23.4	23.5	23.3	23.2	23.1	23.1
		1	63	23.8	23.5	23.5	22.6	22.3	21.9	23.8	23.5	23.7	23.2	23.0	22.9
	64QAM	1	64	22.8	22.6	22.7	21.5	21.1	20.9	22.8	22.4	22.6	22.4	22.1	21.8
		32	16	23.9	23.7	23.5	22.4	22.2	22.0	23.5	23.6	23.5	23.2	23.1	22.8
		64	0	22.8	22.7	22.5	21.3	21.2	21.0	22.5	22.6	22.4	22.1	22.0	21.8
		1	0	22.3	22.6	22.0	20.8	20.9	20.7	21.8	22.3	21.7	21.6	21.9	21.5
		1	1	22.3	22.2	22.0	20.6	21.1	20.4	22.0	22.3	21.9	21.6	21.8	21.3
	256QAM	1	63	22.4	22.2	22.0	20.6	20.6	20.6	22.0	22.1	22.2	21.6	21.7	21.5
		1	64	22.4	22.2	21.9	20.8	20.8	20.5	22.0	22.1	22.0	21.7	21.6	21.4
		32	16	22.3	22.2	21.9	20.8	20.8	20.5	22.0	22.1	21.9	21.7	21.7	21.3
		64	0	22.3	22.2	22.1	20.8	20.6	20.5	22.1	22.1	21.9	21.8	21.6	21.4
		1	0	20.3	20.3	19.8	18.8	19.1	18.4	20.2	20.0	19.9	19.6	19.6	19.5
	256QAM	1	1	20.2	20.3	20.3	19.0	19.1	18.4	20.2	20.1	20.0	19.6	19.6	19.4
		1	63	20.3	19.8	20.1	19.2	18.8	18.8	20.1	20.2	20.1	19.5	19.5	19.4
		1	64	20.8	20.3	20.1	19.2	18.9	18.6	20.1	20.1	20.2	19.5	19.5	19.4
		32	16	20.3	20.1	19.9	18.9	18.7	18.5	20.2	20.1	19.9	19.7	19.6	19.3
		64	0	20.3	20.3	20.3	18.9	18.7	18.5	20.1	20.0	19.9	19.7	19.6	19.2

**OUTPUT POWER FOR 5G NR n77 (30.0 MHz)**

Bandwidth (MHz)	Modulation	RB Allocation	RB Offset	Conducted Average (dBm)											
				ANT 6			ANT 7			ANT 1			ANT 5		
				631000	633332	635666	631000	633332	635666	631000	633332	635666	631000	633332	635666
30.0	BPSK	1	0	23.7	23.7	23.4	22.8	22.8	22.5	24.1	24.0	23.8	23.5	23.6	23.4
		1	1	24.1	24.3	23.9	23.3	23.4	23.0	24.7	24.6	24.4	24.1	24.1	24.0
		1	76	24.4	24.0	24.0	23.4	23.0	23.1	24.6	24.4	24.5	24.2	24.0	23.8
		1	77	23.8	23.4	23.3	22.9	22.7	22.5	24.1	24.0	24.0	23.8	23.6	23.3
		36	18	24.3	24.3	24.0	23.5	23.2	22.9	24.6	24.6	24.4	24.3	24.2	23.7
		75	0	23.8	23.7	23.5	22.8	22.8	22.5	24.0	24.1	23.9	23.7	23.7	23.3
	QPSK	1	0	23.2	23.2	23.0	22.2	22.2	22.0	23.4	23.5	23.5	23.1	23.3	22.7
		1	1	24.3	24.3	23.9	23.3	23.3	22.9	24.5	24.7	24.3	24.1	24.2	23.7
		1	76	24.2	24.1	23.8	23.3	23.0	23.0	24.5	24.4	24.5	24.2	24.1	23.8
		1	77	23.4	23.0	23.0	22.4	22.1	22.0	23.4	23.5	23.5	23.2	23.1	22.8
		36	18	24.3	24.2	24.0	23.4	23.3	23.0	24.6	24.6	24.4	24.2	24.2	23.8
		75	0	23.3	23.2	23.0	22.4	22.2	22.0	23.6	23.5	23.5	23.2	23.0	22.9
	16QAM	1	0	22.4	22.4	22.0	21.4	21.6	21.0	22.6	22.5	22.5	22.0	22.1	21.7
		1	1	22.7	23.3	23.1	22.1	22.6	22.0	23.8	23.6	23.3	22.9	23.0	22.9
		1	76	23.0	23.1	23.0	22.3	21.9	22.1	24.0	23.4	23.4	23.4	23.2	22.6
		1	77	22.6	21.9	21.9	21.7	21.4	21.1	22.5	22.4	22.5	22.2	21.9	21.8
		36	18	23.3	23.3	22.9	22.5	22.2	22.1	23.6	23.6	23.5	23.2	23.1	22.9
		75	0	22.3	22.2	22.0	21.3	21.3	21.1	22.5	22.6	22.4	22.2	22.1	21.8
	64QAM	1	0	21.8	22.2	21.3	20.9	20.9	20.5	22.0	22.2	21.9	21.6	21.8	21.3
		1	1	21.9	21.9	21.3	21.0	20.8	20.4	22.0	22.1	22.0	21.6	21.6	21.5
		1	76	21.7	21.7	21.8	21.3	20.6	20.4	21.9	22.0	21.9	21.8	21.6	21.5
		1	77	21.6	21.1	21.3	20.9	20.6	20.6	22.1	21.9	21.9	21.7	21.5	21.5
		36	18	21.8	21.7	21.4	20.9	20.8	20.4	22.0	22.1	21.8	21.7	21.7	21.3
		75	0	21.8	21.7	21.4	20.9	20.6	20.5	22.1	22.1	21.9	21.7	21.6	21.3
	256QAM	1	0	19.9	19.8	19.6	18.8	18.8	18.3	20.2	20.0	19.8	19.7	20.1	19.4
		1	1	19.7	19.8	19.6	18.8	18.9	18.6	19.9	19.9	20.1	19.8	19.8	19.4
		1	76	20.0	19.6	19.6	18.8	18.7	18.5	20.1	19.8	19.8	20.1	19.6	19.4
		1	77	19.8	19.3	19.6	18.8	19.0	18.5	20.2	19.9	20.0	19.9	19.8	19.4
		36	18	19.7	19.6	19.5	18.9	18.7	18.5	19.9	20.1	19.9	19.7	19.6	19.4
		75	0	19.8	19.5	19.5	18.9	18.7	18.6	20.0	20.1	19.8	19.7	19.6	19.3

**OUTPUT POWER FOR 5G NR n77 (40.0 MHz)**

Bandwidth (MHz)	Modulation	RB Allocation	RB Offset	Conducted Average (dBm)											
				ANT 6			ANT 7			ANT 1			ANT 5		
				631332	633332	635332	631332	633332	635332	631332	633332	635332	631332	633332	635332
40.0	BPSK	1	0	23.8	23.8	23.5	22.9	22.8	22.7	24.0	24.1	23.9	23.6	23.6	23.5
		1	1	24.2	24.3	24.0	23.4	23.3	23.0	24.7	24.6	24.5	24.2	24.2	24.1
		1	104	24.2	24.0	24.0	23.4	23.0	23.1	24.6	24.5	24.4	24.2	24.0	23.9
		1	105	23.7	23.4	23.6	22.9	22.6	22.6	24.0	24.1	23.9	23.7	23.5	23.3
		50	25	24.3	24.1	23.9	23.4	23.2	23.0	24.7	24.5	24.3	24.2	24.2	23.9
		100	0	23.8	23.5	23.4	22.9	22.8	22.4	24.1	24.1	24.0	23.7	23.6	23.4
	QPSK	1	0	23.2	23.2	23.1	22.3	22.4	22.1	23.6	23.6	23.4	23.1	23.2	23.1
		1	1	24.2	24.3	24.1	23.4	23.4	23.0	24.6	24.6	24.4	24.2	24.1	23.9
		1	104	24.2	24.0	24.0	23.5	23.1	23.0	24.5	24.5	24.5	24.2	24.1	23.9
		1	105	23.2	23.0	22.9	22.2	21.9	22.0	23.5	23.4	23.5	23.1	23.0	22.8
		50	25	24.3	24.1	23.8	23.5	23.2	23.1	24.5	24.6	24.5	24.2	24.1	24.0
		100	0	23.1	23.1	23.0	22.3	22.2	22.0	23.5	23.6	23.5	23.2	23.1	22.9
	16QAM	1	0	22.3	22.7	22.1	21.1	21.4	20.9	22.4	22.6	22.5	22.2	21.9	21.9
		1	1	23.0	23.3	23.0	22.1	22.3	22.2	23.6	23.7	23.6	23.1	22.7	23.0
		1	104	23.6	23.1	22.8	22.4	21.9	21.9	23.4	23.6	23.5	23.1	22.8	22.9
		1	105	22.4	22.0	22.2	21.0	20.9	21.0	22.7	22.3	22.3	22.2	21.7	22.0
		50	25	23.3	23.1	22.9	22.3	22.3	22.0	23.6	23.6	23.5	23.3	23.1	22.9
		100	0	22.2	22.3	21.9	21.4	21.2	21.0	22.5	22.6	22.4	22.3	22.0	21.9
	64QAM	1	0	21.5	21.9	21.6	20.7	21.3	20.5	22.0	22.2	21.9	21.3	21.4	21.5
		1	1	21.6	21.9	21.6	20.7	20.7	20.6	22.0	22.0	21.9	21.4	21.8	21.5
		1	104	21.6	21.4	21.4	20.8	21.1	20.5	22.2	22.2	22.1	21.3	21.6	21.3
		1	105	21.6	21.4	21.5	20.7	20.4	20.6	22.1	22.1	21.9	21.3	21.3	21.5
		50	25	21.8	21.8	21.5	20.9	20.6	20.5	22.2	22.0	21.9	21.8	21.7	21.4
		100	0	21.8	21.7	21.5	20.8	20.7	20.5	22.1	22.1	22.0	21.8	21.5	21.4
	256QAM	1	0	19.6	19.6	19.6	18.8	19.0	18.2	19.9	20.5	20.0	19.7	19.4	19.4
		1	1	19.4	19.6	19.5	18.5	18.7	18.3	19.9	20.3	20.1	19.7	19.7	19.6
		1	104	19.6	19.8	19.4	18.5	18.3	18.3	20.0	20.4	19.9	19.5	19.2	19.3
		1	105	19.7	19.4	19.6	19.0	18.6	18.5	20.3	20.2	19.6	19.5	19.7	19.5
		50	25	19.8	19.7	19.4	18.9	18.6	18.5	20.1	20.1	19.9	19.7	19.5	19.4
		100	0	19.8	19.7	19.4	19.0	18.7	18.5	20.2	20.0	19.9	19.7	19.6	19.3

**OUTPUT POWER FOR 5G NR n77 (50.0 MHz)**

Bandwidth (MHz)	Modulation	RB Allocation	RB Offset	Conducted Average (dBm)											
				ANT 6			ANT 7			ANT 1			ANT 5		
				631666	633332	634998	631666	633332	634998	631666	633332	634998	631666	633332	634998
50.0	BPSK	1	0	24.4	24.3	24.2	23.0	23.0	22.8	24.1	24.1	24.1	23.7	23.8	23.6
		1	1	<b>24.8</b>	24.7	24.6	23.4	<b>23.5</b>	23.3	24.6	24.7	24.7	24.2	24.3	24.1
		1	131	24.7	24.4	24.5	23.3	23.1	23.2	24.7	24.5	24.5	24.2	23.9	23.8
		1	132	24.2	24.0	24.0	22.8	22.7	22.7	24.1	24.0	24.0	23.7	23.6	23.5
		64	32	24.8	24.7	24.5	23.4	23.2	23.0	<b>24.7</b>	24.6	24.6	<b>24.3</b>	24.1	24.0
		128	0	24.3	24.2	24.0	23.0	22.8	22.5	24.1	24.1	24.0	23.7	23.6	23.5
	QPSK	1	0	23.8	23.9	23.7	22.4	22.4	22.1	23.6	23.6	23.6	23.2	23.3	23.1
		1	1	24.8	<b>24.8</b>	24.7	<b>23.5</b>	<b>23.5</b>	23.1	24.5	24.6	<b>24.7</b>	24.1	24.2	24.1
		1	131	24.7	24.6	24.5	23.3	23.2	23.2	24.5	24.5	24.5	24.2	24.0	24.0
		1	132	23.6	23.6	23.5	22.3	22.1	22.1	23.5	23.5	23.4	23.2	22.9	22.9
		64	32	24.8	24.6	24.5	23.4	23.2	23.2	24.6	24.6	24.5	<b>24.3</b>	24.2	24.1
		128	0	23.8	23.6	23.4	22.3	22.2	22.1	23.6	23.6	23.6	23.3	23.2	23.0
	16QAM	1	0	22.6	22.8	22.8	21.3	21.5	21.2	22.6	22.7	22.5	22.1	22.1	22.3
		1	1	<b>23.9</b>	23.8	23.3	22.3	<b>22.5</b>	22.1	23.7	23.4	23.4	23.1	<b>23.3</b>	23.0
		1	131	23.7	23.5	23.3	22.5	22.5	22.3	23.7	23.2	<b>23.8</b>	23.1	23.0	22.7
		1	132	22.6	22.5	22.3	21.3	21.4	21.3	22.7	22.5	22.8	22.1	22.0	21.5
		64	32	23.9	23.7	23.5	22.4	22.2	22.1	23.7	23.6	23.5	23.2	23.1	23.1
		128	0	22.8	22.7	22.5	21.4	21.3	21.1	22.6	22.6	22.5	22.3	22.2	21.9
	64QAM	1	0	22.3	22.4	22.0	21.1	<b>21.4</b>	21.0	22.1	22.0	<b>22.4</b>	21.5	21.6	21.8
		1	1	22.3	21.9	22.2	21.1	21.2	20.8	21.9	21.9	22.3	21.4	21.6	21.8
		1	131	22.2	22.2	22.0	20.9	20.6	20.7	22.2	21.4	22.1	21.4	21.6	21.7
		1	132	22.2	21.9	22.0	21.0	20.7	20.8	21.9	21.9	<b>22.4</b>	21.4	21.5	21.6
		64	32	<b>22.4</b>	22.2	21.9	20.9	20.8	20.6	22.2	22.1	22.0	<b>21.8</b>	21.7	21.4
		128	0	22.3	22.1	22.0	20.8	20.7	20.5	22.1	22.1	22.0	21.7	21.6	21.5
	256QAM	1	0	20.2	20.4	20.3	19.0	<b>19.0</b>	18.6	<b>20.5</b>	20.2	19.9	19.4	<b>19.9</b>	19.5
		1	1	20.3	20.3	20.1	18.8	19.0	18.7	20.3	20.4	20.1	19.7	19.8	19.6
		1	131	20.3	20.2	20.0	18.6	18.7	18.7	20.4	20.1	20.3	19.4	19.3	19.3
		1	132	20.3	20.0	20.2	18.6	18.6	18.4	20.1	19.8	20.2	19.5	19.7	19.4
		64	32	20.3	20.3	20.0	18.9	18.6	18.5	20.1	20.1	19.9	19.8	19.6	19.5
		128	0	20.3	20.2	<b>20.4</b>	18.9	18.6	18.6	20.1	20.0	20.0	19.8	19.5	19.4

**OUTPUT POWER FOR 5G NR n77 (60.0 MHz)**

Bandwidth (MHz)	Modulation	RB Allocation	RB Offset	Conducted Average (dBm)											
				ANT 6			ANT 7			ANT 1			ANT 5		
				632000	633332	634666	632000	633332	634666	632000	633332	634666	632000	633332	634666
60.0	BPSK	1	0	24.1	24.2	24.2	22.8	23.0	22.8	24.0	24.1	23.9	23.6	23.8	23.7
		1	1	24.7	<b>24.8</b>	24.8	23.4	23.4	23.3	<b>24.7</b>	<b>24.7</b>	24.6	24.1	24.2	24.1
		1	160	24.6	24.4	24.4	23.3	23.0	23.0	24.5	24.3	24.5	24.0	24.0	23.9
		1	161	24.0	24.0	23.9	22.7	22.5	22.6	24.0	23.8	23.9	23.5	23.4	23.3
		81	40	24.7	24.6	24.5	<b>23.5</b>	23.3	23.0	24.6	24.6	24.4	<b>24.3</b>	24.1	24.0
		162	0	24.3	24.2	24.0	22.9	22.7	22.6	24.1	23.9	24.1	23.7	23.7	23.6
	QPSK	1	0	23.7	23.6	23.8	22.3	22.5	22.3	23.6	23.6	23.6	23.2	23.3	23.1
		1	1	24.7	24.7	24.7	23.4	23.4	23.3	24.5	24.5	<b>24.6</b>	24.2	24.2	24.1
		1	160	24.6	24.2	24.4	23.2	23.0	23.2	24.6	24.6	24.5	24.0	23.9	23.8
		1	161	23.3	23.4	23.4	22.2	22.0	22.0	23.6	23.4	23.5	23.0	22.8	22.8
		81	40	<b>24.9</b>	24.6	24.5	<b>23.5</b>	23.1	23.1	24.6	24.6	24.4	<b>24.2</b>	24.1	24.0
		162	0	23.8	23.6	23.5	22.4	22.3	22.1	23.7	23.5	23.5	23.1	23.1	23.1
	16QAM	1	0	22.7	23.0	22.7	21.8	21.1	21.1	22.5	22.6	22.4	22.0	22.0	21.7
		1	1	23.7	<b>23.8</b>	23.7	<b>22.7</b>	22.2	22.1	23.3	23.4	23.4	23.1	23.1	<b>23.2</b>
		1	160	23.8	23.3	23.2	22.5	22.2	22.0	23.5	23.5	<b>23.6</b>	23.1	22.7	22.9
		1	161	22.5	22.5	22.4	21.5	21.1	21.0	22.8	22.6	22.6	21.8	22.0	21.8
		81	40	23.8	23.6	23.5	22.5	22.2	22.1	23.6	23.5	23.5	23.2	23.1	22.9
		162	0	22.7	22.6	22.5	21.5	21.2	21.0	22.6	22.6	22.5	22.1	22.2	22.0
	64QAM	1	0	21.9	<b>22.3</b>	22.3	20.8	20.7	20.7	22.4	22.4	22.1	21.6	<b>21.8</b>	21.7
		1	1	22.3	22.3	22.2	21.0	20.8	<b>21.2</b>	<b>22.5</b>	22.2	22.1	21.6	21.4	21.8
		1	160	22.0	21.6	21.9	20.7	20.6	20.6	22.0	21.9	22.1	21.2	21.4	21.3
		1	161	22.2	21.7	21.9	20.7	20.3	20.5	22.3	21.9	22.0	21.4	21.3	21.4
		81	40	22.3	22.1	22.0	20.9	20.7	20.5	22.1	22.0	22.0	21.7	21.7	21.5
		162	0	22.2	22.1	22.0	20.9	20.8	20.6	22.0	21.9	22.0	21.6	21.6	21.5
	256QAM	1	0	20.2	20.2	20.0	<b>19.2</b>	18.9	19.0	20.3	<b>20.3</b>	19.7	<b>19.9</b>	19.8	19.9
		1	1	20.1	20.0	20.1	19.0	18.9	19.0	20.3	20.0	19.8	19.5	19.5	19.9
		1	160	<b>20.3</b>	20.0	19.9	19.0	18.6	18.7	20.3	20.2	20.0	19.7	19.3	19.4
		1	161	19.9	20.0	20.1	19.0	18.6	18.9	20.3	19.9	19.8	19.5	19.5	19.4
		81	40	20.3	20.1	20.0	18.9	18.7	18.6	20.0	20.0	19.9	19.7	19.7	19.6
		162	0	20.2	20.1	20.3	18.8	18.7	18.6	20.0	20.0	20.1	19.7	19.6	19.5

**OUTPUT POWER FOR 5G NR n77 (70.0 MHz)**

Bandwidth (MHz)	Modulation	RB Allocation	RB Offset	Conducted Average (dBm)											
				ANT 6			ANT 7			ANT 1			ANT 5		
				632333	633332	634333	632333	633332	634333	632333	633332	634333	632333	633332	634333
70.0	BPSK	1	0	24.2	24.3	24.3	22.9	22.7	22.9	24.1	24.1	24.1	23.7	23.6	23.7
		1	1	24.8	24.7	24.9	23.5	23.4	23.5	24.7	24.5	24.5	24.3	24.2	24.3
		1	187	24.6	24.5	24.4	23.2	23.1	23.1	24.6	24.6	24.4	24.1	24.0	24.0
		1	188	24.0	23.9	23.9	22.6	22.6	22.7	24.0	24.0	24.0	23.5	23.4	23.4
		90	45	24.8	24.7	24.5	23.3	23.3	23.1	24.5	24.5	24.5	24.3	24.2	24.0
		180	0	24.4	24.2	24.1	22.9	22.7	22.7	24.1	24.0	24.0	23.6	23.6	23.6
	QPSK	1	0	23.6	23.7	23.8	22.4	22.4	22.4	23.5	23.7	23.7	23.1	23.2	23.2
		1	1	24.7	24.7	24.9	23.4	23.4	23.5	24.6	24.6	24.6	24.3	24.3	24.2
		1	187	24.6	24.5	24.3	23.1	23.2	23.2	24.6	24.5	24.4	24.1	24.1	23.9
		1	188	23.5	23.5	23.5	22.2	22.1	22.1	23.5	23.6	23.4	23.0	23.0	22.9
		90	45	24.7	24.6	24.5	23.4	23.3	23.0	24.6	24.7	24.5	24.3	24.1	24.0
		180	0	23.7	23.6	23.5	22.4	22.3	22.2	23.6	23.6	23.4	23.2	23.0	23.1
	16QAM	1	0	22.6	23.1	22.8	21.3	21.3	21.4	22.8	22.7	22.7	22.4	22.3	22.4
		1	1	23.4	23.7	23.6	22.5	22.2	22.2	23.8	24.1	23.9	23.1	23.4	23.1
		1	187	23.6	23.8	23.4	22.2	21.8	22.1	23.7	23.5	23.8	23.2	23.2	22.7
		1	188	22.4	22.5	22.3	21.4	21.0	21.1	22.6	22.8	22.3	22.1	22.0	21.9
		90	45	23.8	23.6	23.6	22.4	22.2	22.1	23.6	23.5	23.4	23.2	23.2	23.1
		180	0	22.6	22.6	22.6	21.4	21.2	21.1	22.6	22.6	22.5	22.1	22.0	22.1
	64QAM	1	0	22.2	22.3	22.4	20.9	20.7	21.0	22.3	22.0	22.1	21.9	21.5	22.0
		1	1	22.5	22.3	22.2	21.0	20.7	21.0	22.2	22.2	21.9	22.0	21.5	21.9
		1	187	22.2	21.9	21.9	20.6	20.4	20.8	22.1	21.9	22.1	21.9	21.2	21.7
		1	188	22.1	21.7	22.0	20.7	20.4	20.8	21.9	22.0	22.1	21.9	21.1	21.6
		90	45	22.2	22.1	22.1	20.9	20.6	20.6	22.1	22.1	21.9	21.7	21.6	21.6
		180	0	22.2	22.1	21.9	20.8	20.7	20.6	22.0	22.0	22.0	21.8	21.6	21.5
	256QAM	1	0	20.2	20.0	20.2	18.5	18.9	18.9	20.2	20.1	20.0	19.7	19.6	19.8
		1	1	20.2	20.1	20.3	19.1	18.7	18.9	19.9	20.0	19.9	19.6	19.6	20.0
		1	187	20.2	20.0	19.9	18.3	18.6	18.9	20.3	20.0	20.1	19.4	19.5	19.4
		1	188	20.4	19.8	19.7	18.9	18.6	18.7	20.2	19.9	20.0	19.6	19.0	19.7
		90	45	20.2	20.2	20.1	18.8	18.7	18.6	20.0	19.9	19.9	19.7	19.7	19.5
		180	0	20.1	20.1	20.4	18.8	18.6	18.7	20.1	20.0	19.9	19.7	19.6	19.5

**OUTPUT POWER FOR 5G NR n77 (80.0 MHz)**

Bandwidth (MHz)	Modulation	RB Allocation	RB Offset	Conducted Average (dBm)											
				ANT 6			ANT 7			ANT 1			ANT 5		
				632666	633332	633998	632666	633332	633998	632666	633332	633998	632666	633332	633998
80.0	BPSK	1	0	24.3	24.3	24.3	22.9	22.8	23.0	24.0	24.1	24.2	23.6	23.7	23.8
		1	1	24.7	24.8	24.8	23.5	23.4	23.4	24.5	24.6	24.7	24.3	24.3	24.2
		1	215	24.5	24.6	24.5	23.1	23.3	23.1	24.4	24.4	24.6	24.1	24.1	24.1
		1	216	24.0	24.1	24.0	22.6	22.7	22.7	23.9	24.0	24.0	23.5	23.4	23.4
		108	54	24.8	24.5	24.7	23.3	23.2	23.1	24.6	24.6	24.5	24.3	24.1	24.1
		216	0	24.1	24.0	24.0	22.9	22.7	22.7	24.0	24.0	24.1	23.7	23.7	23.5
	QPSK	1	0	23.6	23.8	23.9	22.4	22.3	22.5	23.5	23.7	23.6	23.2	23.2	23.3
		1	1	24.8	24.8	24.8	23.3	23.5	23.4	24.6	24.7	24.7	24.3	24.4	24.4
		1	215	24.5	24.5	24.5	23.1	23.2	23.3	24.5	24.6	24.4	24.1	24.0	24.0
		1	216	23.5	23.5	23.5	22.1	22.2	22.2	23.5	23.5	23.4	23.0	23.0	22.9
		108	54	24.6	24.7	24.6	23.3	23.2	23.3	24.5	24.5	24.5	24.2	24.1	24.0
		216	0	23.6	23.6	23.6	22.3	22.2	22.2	23.5	23.6	23.5	23.1	23.2	23.0
	16QAM	1	0	22.8	22.7	22.9	21.2	21.4	21.6	22.5	22.9	22.6	22.3	21.9	22.2
		1	1	23.7	23.7	24.1	22.4	22.4	22.4	23.3	23.4	23.8	23.3	23.2	23.1
		1	215	23.3	23.5	23.4	22.0	22.2	22.3	23.5	23.7	23.1	23.0	23.0	23.0
		1	216	22.7	22.5	22.5	20.9	21.2	21.0	22.5	22.3	22.0	21.8	21.8	21.8
		108	54	23.7	23.6	23.5	22.3	22.3	22.2	23.5	23.6	23.4	23.2	23.2	23.1
		216	0	22.7	22.6	22.6	21.4	21.3	21.2	22.5	22.5	22.5	22.1	22.1	22.1
	64QAM	1	0	22.1	22.1	22.4	20.7	20.9	21.0	22.2	22.2	22.2	21.9	21.8	21.7
		1	1	22.1	22.3	22.3	20.9	20.7	20.9	22.3	22.2	22.2	21.6	21.8	22.0
		1	215	21.9	22.2	21.6	20.6	20.6	20.5	22.1	22.4	22.0	21.7	21.2	21.4
		1	216	21.8	22.0	22.1	20.6	20.7	20.6	22.1	21.7	21.6	21.7	21.3	21.6
		108	54	22.2	22.0	22.1	20.8	20.7	20.7	22.1	22.1	22.0	21.7	21.7	21.5
		216	0	22.2	22.2	22.1	20.8	20.8	20.6	22.0	22.0	22.0	21.6	21.6	21.4
	256QAM	1	0	20.5	20.2	20.3	18.8	18.9	18.5	20.1	20.2	20.1	19.7	19.6	19.5
		1	1	20.5	20.5	20.6	18.9	19.0	18.7	20.1	20.0	20.2	19.6	19.9	19.4
		1	215	20.1	19.8	20.1	18.7	18.7	18.4	20.0	19.9	20.0	19.2	19.5	19.3
		1	216	20.1	19.9	19.8	18.7	18.8	18.5	19.8	19.9	20.2	19.4	19.3	19.3
		108	54	20.2	20.1	20.1	18.8	18.7	18.6	20.0	20.1	19.9	19.6	19.6	19.6
		216	0	20.3	20.1	20.3	18.7	18.7	18.7	19.9	20.0	20.0	19.6	19.6	19.6

**OUTPUT POWER FOR 5G NR n77 (90.0 MHz)**

Bandwidth (MHz)	Modulation	RB Allocation	RB Offset	Conducted Average (dBm)											
				ANT 6			ANT 7			ANT 1			ANT 5		
				633000	633332	633666	633000	633332	633666	633000	633332	633666	633000	633332	633666
90.0	BPSK	1	0	24.2	24.1	24.3	22.8	22.9	23.0	24.0	24.1	23.9	23.7	23.6	23.6
		1	1	24.7	24.9	24.9	23.4	23.3	23.5	24.6	24.7	24.8	24.2	24.2	24.3
		1	243	24.5	24.5	24.5	23.2	23.3	23.2	24.7	24.6	24.6	24.1	23.9	24.0
		1	244	24.0	24.0	24.1	22.7	22.6	22.6	23.9	24.0	24.0	23.4	23.5	23.4
		120	60	24.7	24.6	24.6	23.3	23.1	23.2	24.6	24.5	24.5	24.2	24.1	24.2
		243	0	24.2	24.2	24.0	22.9	22.8	22.7	24.1	24.1	23.9	23.7	23.7	23.6
	QPSK	1	0	23.6	23.6	23.8	22.3	22.3	22.3	23.5	23.5	23.6	23.1	23.0	23.2
		1	1	24.8	24.9	24.9	23.4	23.5	23.4	24.6	24.7	24.7	24.2	24.2	24.3
		1	243	24.6	24.4	24.5	23.2	23.3	23.1	24.4	24.7	24.5	24.1	24.0	24.0
		1	244	23.6	23.4	23.6	22.2	22.2	22.1	23.4	23.5	23.6	22.9	23.0	23.0
		120	60	24.7	24.5	24.6	23.3	23.3	23.2	24.4	24.6	24.6	24.1	24.1	24.2
		243	0	23.6	23.7	23.7	22.3	22.3	22.2	23.6	23.6	23.6	23.2	23.2	23.1
	16QAM	1	0	22.7	22.8	22.6	21.6	21.1	21.4	22.7	22.5	22.6	22.2	22.0	21.9
		1	1	23.9	23.9	23.7	22.7	22.1	22.5	23.4	23.7	23.7	23.1	23.1	23.1
		1	243	23.9	23.5	23.5	22.4	21.8	22.3	23.5	24.0	23.8	22.8	22.8	22.8
		1	244	22.5	22.7	22.4	21.3	21.2	21.1	22.8	22.6	22.7	22.0	22.0	21.8
		120	60	23.7	23.7	23.6	22.3	22.2	22.3	23.6	23.5	23.5	23.2	23.1	23.1
		243	0	22.7	22.6	22.6	21.3	21.2	21.3	22.4	22.6	22.6	22.1	22.1	22.2
	64QAM	1	0	22.1	22.0	22.3	20.8	20.6	20.7	22.1	22.0	22.0	21.4	21.7	21.7
		1	1	21.9	22.4	22.6	21.2	20.8	20.7	22.2	22.1	22.4	21.7	21.7	21.9
		1	243	21.8	21.8	22.0	20.6	20.5	20.5	22.1	22.1	22.1	21.6	21.5	21.2
		1	244	21.7	22.1	22.2	20.7	20.4	20.5	21.7	22.0	22.0	21.3	21.4	21.2
		120	60	22.1	22.2	22.1	20.7	20.8	20.7	22.1	21.9	22.0	21.7	21.7	21.6
		243	0	22.3	22.1	22.1	20.8	20.8	20.7	22.0	22.0	22.1	21.6	21.7	21.6
	256QAM	1	0	20.1	19.9	20.1	19.1	18.9	18.9	20.3	19.9	20.0	19.8	19.6	19.9
		1	1	20.2	20.0	19.9	18.8	18.9	19.0	20.1	20.0	20.3	19.7	19.7	19.9
		1	243	19.9	19.8	20.0	19.1	18.7	18.6	20.0	19.8	19.9	19.3	19.2	19.5
		1	244	19.6	20.6	20.3	19.1	18.6	18.7	20.1	19.9	19.7	19.2	19.3	19.5
		120	60	20.2	20.0	20.1	18.7	18.7	18.6	20.0	20.0	20.1	19.6	19.5	19.6
		243	0	20.1	20.2	20.3	18.8	18.7	18.8	20.1	19.9	20.0	19.6	19.6	19.6

**OUTPUT POWER FOR 5G NR n77 (100.0 MHz)**

Bandwidth (MHz)	Modulation	RB Allocation	RB Offset	Conducted Average (dBm)											
				ANT 6			ANT 7			ANT 1			ANT 5		
				N/A	633332	N/A	N/A	633332	N/A	N/A	633332	N/A	N/A	633332	N/A
100.0	BPSK	1	0		24.0			22.7			23.9				
		1	1		24.8			23.4			24.7			24.3	
		1	271		24.6			23.3			24.6			24.0	
		1	272		23.9			22.5			23.9			23.3	
		135	67		24.5			23.2			24.6			24.1	
		270	0		24.1			22.7			24.1			23.7	
	QPSK	1	0		23.5			22.1			23.4			23.0	
		1	1		24.7			23.4			24.6			24.2	
		1	271		24.5			23.3			24.7			24.0	
		1	272		23.3			21.9			23.5			22.8	
		135	67		24.6			23.2			24.5			24.1	
		270	0		23.6			22.3			23.5			23.2	
	16QAM	1	0		22.5			21.2			22.5			22.2	
		1	1		23.9			22.4			23.7			23.1	
		1	271		23.6			22.3			23.5			22.9	
		1	272		22.7			21.1			22.2			22.1	
		135	67		23.6			22.2			23.6			23.1	
		270	0		22.5			21.3			22.6			22.1	
	64QAM	1	0		22.0			20.6			21.9			21.5	
		1	1		22.1			20.7			22.0			21.5	
		1	271		22.0			20.9			22.1			21.3	
		1	272		22.0			20.7			21.8			21.3	
		135	67		22.1			20.7			22.0			21.6	
		270	0		22.1			20.8			22.1			21.6	
	256QAM	1	0		20.2			19.1			20.0			20.0	
		1	1		20.4			18.9			19.8			19.9	
		1	271		19.9			18.8			20.0			19.4	
		1	272		20.1			18.6			19.9			19.6	
		135	67		20.1			18.7			20.2			19.6	
		270	0		20.0			18.6			20.0			19.6	

### 8.18. 5G NR n77 ( Part 27 3450-3550MHz) HPUE

<b>Test Engineer ID:</b>	32934IG, 19210AL and 28498AC	<b>Test Date:</b>	2024-03-01 to 2024-03-28
--------------------------	------------------------------	-------------------	--------------------------

#### OUTPUT POWER FOR 5G NR n77 (10.0 MHz)

Bandwidth (MHz)	Modulation	RB Allocation	RB Offset	Conducted Average (dBm)												
				ANT 6			ANT 7			ANT 1			ANT 5			
				630333	633332	636333	630333	633332	636333	630333	633332	636333	630333	633332	636333	
10.0	BPSK	1	0	23.9	24.1	24.0	22.4	22.1	22.0	21.8	21.5	21.5	21.9	21.8	21.6	
		1	1	25.8	26.1	25.9	<b>25.9</b>	25.7	25.3	25.3	25.0	25.0	25.2	25.3	25.1	
		1	22	25.8	<b>26.1</b>	26.0	<b>25.9</b>	25.6	25.3	<b>25.4</b>	24.9	24.8	<b>25.4</b>	25.2	25.1	
		1	23	23.9	24.0	24.1	22.4	22.0	21.9	21.9	21.4	21.3	21.9	21.8	21.4	
		12	6	25.9	26.0	26.0	25.9	25.6	25.4	25.4	25.0	24.9	25.3	25.3	24.9	
		24	0	25.8	26.0	26.0	24.4	24.0	24.0	24.9	24.5	24.4	24.9	24.8	24.6	
		QPSK	1	0	23.3	23.5	23.5	22.6	22.1	22.0	21.8	21.6	21.4	21.9	21.7	21.7
			1	1	25.8	26.0	26.0	<b>26.0</b>	25.6	25.4	<b>25.3</b>	25.3	24.8	<b>25.4</b>	25.2	25.0
	1		22	25.8	26.0	26.1	25.9	25.5	25.5	25.3	25.0	24.8	25.3	25.3	24.9	
	1		23	23.5	23.5	23.5	22.4	22.0	22.0	21.8	21.4	21.2	21.9	21.8	21.3	
	12		6	25.9	<b>26.1</b>	26.0	25.9	25.5	25.4	25.3	25.0	24.9	25.3	25.3	25.0	
	24		0	25.9	26.0	26.0	23.9	23.6	23.4	24.4	24.0	23.9	24.3	24.2	24.0	
	16QAM		1	0	22.1	22.5	22.4	22.7	22.5	21.8	22.0	21.6	21.2	21.9	21.5	21.5
			1	1	24.7	25.0	25.0	24.7	<b>25.0</b>	24.2	<b>24.4</b>	23.9	23.8	24.1	24.2	24.0
		1	22	24.7	24.7	24.7	24.8	24.7	24.1	24.4	24.0	23.9	<b>24.4</b>	24.3	23.9	
		1	23	22.2	22.5	22.7	22.3	22.2	21.7	21.9	21.4	21.1	21.9	21.8	21.4	
		12	6	24.9	25.0	25.0	24.9	24.7	24.4	24.3	23.9	23.8	24.4	24.2	23.9	
		24	0	24.9	<b>25.0</b>	25.0	22.9	22.6	22.5	23.3	23.0	22.8	23.4	23.3	23.0	
		64QAM	1	0	22.2	22.6	22.5	22.6	22.1	22.3	21.9	21.5	21.4	21.9	21.7	21.6
			1	1	24.9	<b>24.9</b>	24.9	23.4	23.2	23.1	22.9	22.6	22.3	22.9	23.0	22.5
	1		22	24.8	24.8	24.9	<b>23.7</b>	22.9	23.0	<b>22.9</b>	22.2	22.4	22.7	<b>23.2</b>	22.6	
	1		23	22.1	22.5	22.6	22.6	22.0	22.2	21.8	21.5	21.3	21.6	22.2	21.5	
	12		6	24.8	24.9	<b>24.9</b>	23.2	23.1	22.8	22.8	22.6	22.4	22.8	22.8	22.5	
	24		0	24.9	24.9	<b>24.9</b>	22.4	22.1	21.8	22.9	22.5	22.3	22.9	22.8	22.4	
	256QAM		1	0	22.2	22.6	22.1	21.5	21.5	20.7	21.1	20.5	20.2	<b>21.2</b>	20.9	20.6
			1	1	22.4	22.7	22.4	21.5	<b>21.5</b>	20.7	<b>21.2</b>	20.5	20.2	21.1	20.8	20.5
		1	22	22.3	22.5	<b>22.8</b>	21.4	21.3	21.0	20.9	20.5	20.2	21.1	20.8	20.4	
		1	23	22.2	22.5	22.5	21.5	21.3	20.7	20.9	20.3	20.2	21.1	20.7	20.5	
		12	6	22.1	22.5	22.4	21.4	21.1	20.9	21.0	20.5	20.3	20.9	20.8	20.4	
		24	0	22.2	22.5	22.4	21.4	21.0	20.8	20.9	20.5	20.4	20.8	20.8	20.5	

#### OUTPUT POWER FOR 5G NR n77 (15.0 MHz)

Bandwidth (MHz)	Modulation	RB Allocation	RB Offset	Conducted Average (dBm)												
				ANT 6			ANT 7			ANT 1			ANT 5			
				630500	633332	636166	630500	633332	636166	630500	633332	636166	630500	633332	636166	
15.0	BPSK	1	0	23.9	24.1	24.0	22.5	22.1	21.9	21.8	21.5	21.2	21.6	21.7	21.4	
		1	1	26.0	<b>26.2</b>	26.1	<b>26.1</b>	25.6	25.5	25.3	25.0	24.7	25.2	25.2	24.9	
		1	36	26.0	26.2	26.0	25.8	25.4	25.4	24.6	24.8	24.8	<b>25.3</b>	25.1	24.6	
		1	37	23.9	24.1	24.2	22.3	21.8	21.9	21.8	21.6	21.1	21.8	21.8	21.3	
		18	9	25.9	26.0	26.1	25.8	25.5	25.4	<b>25.3</b>	24.9	24.9	<b>25.3</b>	25.3	25.0	
		36	0	26.0	26.1	26.1	24.3	24.0	23.9	24.9	24.6	24.4	24.8	24.8	24.5	
		QPSK	1	0	23.4	23.6	23.5	22.4	22.1	22.1	21.9	21.5	21.1	21.8	21.8	21.3
			1	1	25.9	26.1	26.1	<b>25.9</b>	25.6	25.5	<b>25.4</b>	25.0	24.6	25.4	25.3	24.9
	1		36	25.9	26.1	<b>26.2</b>	25.8	25.3	25.7	25.3	24.9	24.6	25.4	<b>25.5</b>	24.8	
	1		37	23.4	23.5	23.6	22.2	21.9	21.9	21.8	21.4	21.1	21.8	21.8	21.2	
	18		9	25.9	26.0	26.1	25.8	25.5	25.4	25.3	25.0	24.9	25.3	25.3	25.0	
	36		0	25.9	26.1	26.1	23.8	23.5	23.4	24.4	24.0	23.9	24.3	24.3	23.9	
	16QAM		1	0	22.4	22.8	22.6	22.5	22.0	21.7	21.6	21.6	21.3	21.9	21.5	21.5
			1	1	25.0	25.0	25.1	24.7	24.5	24.2	<b>24.4</b>	24.1	23.8	24.4	24.0	<b>24.5</b>
		1	36	24.8	25.1	<b>25.2</b>	24.6	24.3	24.2	<b>24.4</b>	23.9	23.7	24.4	24.0	24.2	
		1	37	22.6	22.7	22.7	22.2	21.8	22.0	21.7	21.3	21.4	21.9	21.4	21.4	
		18	9	24.9	25.1	25.1	<b>24.9</b>	24.6	24.5	24.4	24.0	23.9	24.3	24.3	24.0	
		36	0	24.8	25.1	25.0	22.8	22.6	22.3	23.3	23.0	22.9	23.3	23.2	23.0	
		64QAM	1	0	22.6	22.8	22.7	22.6	22.2	22.0	21.9	21.4	21.4	22.1	21.9	21.4
			1	1	24.9	25.1	<b>25.1</b>	<b>23.6</b>	23.2	23.0	23.0	22.3	22.2	23.1	23.0	22.4
	1		36	24.9	25.1	25.1	23.5	22.8	23.0	<b>23.0</b>	22.1	22.1	<b>23.1</b>	22.9	22.3	
	1		37	22.6	22.5	22.7	22.3	21.8	22.0	21.8	21.2	21.2	22.1	21.9	20.9	
	18		9	25.0	25.1	25.0	23.3	23.0	22.9	22.9	22.6	22.3	22.9	22.8	22.5	
	36		0	25.0	25.1	25.1	22.4	22.0	21.9	22.8	22.5	22.4	22.8	22.8	22.5	
	256QAM		1	0	22.5	22.5	22.4	21.2	<b>21.4</b>	20.7	<b>20.8</b>	20.5	20.2	20.6	20.6	20.4
			1	1	22.6	22.5	22.5	21.2	21.4	20.7	<b>20.9</b>	20.6	20.2	20.6	20.8	20.4
		1	36	22.8	22.6	<b>22.8</b>	21.0	21.2	20.8	20.8	20.5	20.2	20.6	20.7	20.3	
		1	37	22.7	22.6	22.5	21.1	21.3	20.8	20.8	20.4	20.1	20.6	20.8	20.2	
		18	9	22.6	22.6	22.6	21.3	21.0	20.9	20.9	20.5	20.3	<b>20.9</b>	20.7	20.6	
		36	0	22.4	22.6	22.6	21.4	21.0	20.9	20.9	20.5	20.5	20.8	20.8	20.6	



**OUTPUT POWER FOR 5G NR n77 (20.0 MHz)**

Bandwidth (MHz)	Modulation	RB Allocation	RB Offset	Conducted Average (dBm)											
				ANT 6			ANT 7			ANT 1			ANT 5		
				630666	633332	635998	630666	633332	635998	630666	633332	635998	630666	633332	635998
20.0	BPSK	1	0	24.0	24.1	24.0	22.3	22.2	21.8	22.0	21.7	21.4	21.8	21.8	21.6
		1	1	26.1	26.2	26.1	25.8	25.7	25.4	25.5	25.2	24.9	25.3	25.3	25.1
		1	49	26.1	26.3	26.2	25.7	25.4	25.2	24.8	25.0	25.0	25.3	25.2	24.9
		1	50	24.1	24.1	24.2	22.3	21.9	21.7	22.0	21.8	21.3	21.7	21.6	21.4
		25	12	26.1	26.2	26.1	25.8	25.6	25.4	25.5	25.1	25.1	25.3	25.3	25.0
		50	0	26.0	26.0	26.1	24.3	24.0	23.9	25.1	24.8	24.6	24.8	24.7	24.5
	QPSK	1	0	23.5	23.7	23.6	22.4	22.3	21.9	22.1	21.7	21.3	21.7	21.6	21.8
		1	1	26.2	26.1	26.1	25.8	25.7	25.3	25.6	25.2	24.8	25.2	25.2	25.3
		1	49	26.2	26.1	26.1	25.7	25.5	25.4	25.5	25.1	24.8	25.3	25.2	25.1
		1	50	23.7	23.6	23.6	22.2	22.0	21.8	22.0	21.6	21.3	21.9	21.8	21.4
		25	12	26.1	26.1	26.1	25.8	25.5	25.4	25.5	25.2	25.1	25.3	25.2	25.0
		50	0	26.0	26.0	26.1	23.8	23.5	23.4	24.6	24.2	24.1	24.3	24.3	24.0
	16QAM	1	0	22.6	22.4	22.8	22.3	22.2	21.9	21.8	21.8	21.5	21.9	21.8	21.5
		1	1	25.2	24.9	25.0	24.8	24.6	24.4	24.6	24.3	24.0	24.4	24.2	24.0
		1	49	25.0	25.0	25.0	24.7	24.5	24.5	24.6	24.1	23.9	24.5	24.1	23.8
		1	50	22.6	22.4	22.7	22.3	22.0	21.9	21.9	21.5	21.6	21.7	21.7	21.3
		25	12	25.1	25.1	25.1	24.8	24.5	24.4	24.6	24.2	24.1	24.3	24.2	24.1
		50	0	25.0	25.0	25.0	22.9	22.4	22.3	23.5	23.2	23.1	23.4	23.2	23.0
	64QAM	1	0	22.3	22.3	22.4	22.6	22.2	22.0	22.1	21.6	21.6	22.4	21.9	21.5
		1	1	25.0	25.0	25.0	23.5	23.0	22.9	23.2	22.5	22.4	22.7	22.9	22.4
		1	49	25.0	25.0	25.0	23.4	22.9	22.9	23.2	22.3	22.3	22.9	22.8	22.3
		1	50	22.4	22.4	22.4	22.4	21.9	22.0	22.0	21.4	21.4	22.8	21.8	21.4
		25	12	25.0	25.0	25.0	23.3	23.0	22.8	23.1	22.8	22.5	21.7	22.8	22.6
		50	0	25.0	25.0	25.0	22.3	22.1	21.9	23.0	22.7	22.6	22.8	22.8	22.5
	256QAM	1	0	22.9	22.6	22.8	21.4	21.5	20.7	21.0	20.7	20.4	20.6	20.6	20.3
		1	1	22.9	22.7	22.5	21.3	21.4	20.6	21.1	20.8	20.4	20.7	20.6	20.5
		1	49	22.6	22.8	22.8	21.2	21.3	20.7	21.0	20.7	20.4	20.6	20.5	20.2
		1	50	22.9	22.7	22.8	21.2	21.3	20.7	21.1	20.6	20.3	20.7	20.6	20.1
		25	12	22.5	22.6	22.6	21.3	21.0	20.9	21.1	20.7	20.5	20.7	20.8	20.5
		50	0	22.5	22.6	22.6	21.3	21.0	20.9	21.1	20.7	20.7	20.7	20.7	20.5

**OUTPUT POWER FOR 5G NR n77 (25.0 MHz)**

Bandwidth (MHz)	Modulation	RB Allocation	RB Offset	Conducted Average (dBm)											
				ANT 6			ANT 7			ANT 1			ANT 5		
				630833	633332	635833	630833	633332	635833	630833	633332	635833	630833	633332	635833
25.0	BPSK	1	0	23.9	24.0	23.9	22.2	22.1	21.7	22.0	21.6	21.5	21.7	21.7	21.5
		1	1	26.0	26.1	26.0	25.7	25.6	25.3	25.4	25.2	25.0	25.2	25.2	25.0
		1	63	26.0	26.2	26.1	25.6	25.3	25.1	25.3	24.9	25.0	25.2	25.1	24.8
		1	64	24.0	24.0	24.1	22.2	21.8	21.6	21.7	21.4	21.4	21.6	21.5	21.3
		32	16	26.0	26.1	26.0	25.7	25.5	25.3	25.0	25.1	25.0	25.1	25.2	24.9
		64	0	25.9	25.9	26.0	24.2	23.9	23.8	24.9	24.6	24.4	24.7	24.6	24.4
	QPSK	1	0	23.4	23.6	23.5	22.3	22.2	21.8	21.9	21.6	21.3	21.6	21.5	21.7
		1	1	26.1	26.0	26.0	25.7	25.6	25.2	25.1	25.2	24.9	25.1	25.1	25.2
		1	63	26.1	26.0	26.0	25.6	25.4	25.3	25.4	25.0	24.9	25.2	25.1	25.0
		1	64	23.6	23.5	23.5	22.1	21.9	21.7	21.8	21.5	21.5	21.8	21.7	21.3
		32	16	26.0	26.0	26.0	25.7	25.4	25.3	25.4	25.1	24.9	25.1	25.1	24.9
		64	0	25.9	25.9	26.0	23.7	23.4	23.3	24.4	24.1	24.0	24.2	24.2	23.9
	16QAM	1	0	22.5	22.3	22.7	22.2	22.1	21.8	21.9	21.6	21.5	21.8	21.7	21.4
		1	1	24.9	24.8	24.9	24.7	24.5	24.3	24.3	24.1	24.0	24.3	24.1	23.9
		1	63	24.9	24.9	24.9	24.6	24.4	24.4	24.2	23.9	23.9	24.4	24.0	23.7
		1	64	22.5	22.3	22.6	22.2	21.9	21.8	21.6	21.4	21.5	21.6	21.6	21.2
		32	16	25.0	25.0	25.0	24.7	24.4	24.3	24.4	24.2	24.0	24.2	24.1	24.0
		64	0	24.9	24.9	24.9	22.8	22.3	22.2	23.4	23.1	22.9	23.3	23.1	22.9
	64QAM	1	0	22.2	22.2	22.3	22.5	22.1	21.9	21.8	21.6	21.8	22.3	21.8	21.4
		1	1	24.8	24.9	24.9	23.4	22.9	22.8	22.8	22.6	22.8	22.6	22.8	22.3
		1	63	24.7	24.9	24.9	23.3	22.8	22.8	22.8	22.4	22.7	22.8	22.7	22.2
		1	64	22.3	22.3	22.3	22.3	21.8	21.9	21.8	21.4	21.7	22.7	21.7	21.3
		32	16	24.7	24.9	24.9	23.2	22.9	22.7	22.9	22.7	22.5	21.6	22.7	22.5
		64	0	24.9	24.9	24.9	22.2	22.0	21.8	23.0	22.6	22.4	22.7	22.7	22.4
	256QAM	1	0	22.8	22.5	22.7	21.3	21.4	20.6	20.9	20.4	20.5	20.5	20.5	20.2
		1	1	22.8	22.6	22.4	21.2	21.3	20.5	20.9	20.4	20.5	20.6	20.5	20.4
		1	63	22.5	22.7	22.7	21.1	21.2	20.6	20.8	20.2	20.5	20.5	20.4	20.1
		1	64	22.8	22.6	22.7	21.1	21.2	20.6	20.8	20.3	20.5	20.6	20.5	20.0
		32	16	22.4	22.5	22.5	21.2	20.9	20.8	20.9	20.6	20.5	20.6	20.7	20.4
		64	0	22.4	22.5	22.5	21.2	20.9	20.8	20.9	20.6	20.4	20.6	20.6	20.4

**OUTPUT POWER FOR 5G NR n77 (30.0 MHz)**

Bandwidth (MHz)	Modulation	RB Allocation	RB Offset	Conducted Average (dBm)											
				ANT 6			ANT 7			ANT 1			ANT 5		
				631000	633332	635666	631000	633332	635666	631000	633332	635666	631000	633332	635666
30.0	BPSK	1	0	24.1	24.2	24.1	22.2	22.1	21.8	22.1	21.9	21.5	21.8	21.7	21.6
		1	1	26.0	26.1	26.2	25.7	25.6	25.3	25.5	25.4	25.1	25.3	25.3	25.1
		1	76	26.2	26.1	26.3	25.7	25.4	25.4	25.4	25.1	25.0	25.3	25.2	24.9
		1	77	24.2	24.2	24.2	22.2	21.9	21.9	21.9	21.6	21.5	21.8	21.7	21.4
		36	18	26.2	26.1	26.1	25.7	25.5	25.4	25.5	25.2	25.1	25.3	25.3	25.1
		75	0	26.0	26.2	26.2	24.3	24.1	23.9	25.0	24.7	24.6	24.8	24.8	24.5
	QPSK	1	0	23.5	23.6	23.7	22.4	22.1	21.8	22.0	21.8	21.6	21.7	21.9	21.7
		1	1	26.2	26.0	26.2	25.9	25.7	25.3	25.4	25.4	25.0	25.3	25.2	25.2
		1	76	26.1	26.1	26.3	25.7	25.5	25.3	25.3	25.1	25.0	25.2	25.2	24.9
		1	77	23.6	23.6	23.7	22.2	22.0	21.8	21.9	21.6	21.5	21.9	21.8	21.5
		36	18	26.1	26.2	26.2	25.8	25.6	25.5	25.4	25.2	25.1	25.3	25.3	25.1
		75	0	26.1	26.1	26.2	23.8	23.5	23.4	24.5	24.2	24.1	24.3	24.3	24.1
	16QAM	1	0	22.4	22.5	22.3	22.4	22.4	21.9	22.1	22.0	21.8	21.9	21.8	21.7
		1	1	24.9	24.9	24.9	24.9	24.8	24.3	24.5	24.5	24.2	24.4	24.1	24.3
		1	76	25.2	25.0	25.1	24.7	24.5	24.3	24.5	24.2	24.2	24.4	24.1	23.9
		1	77	22.6	22.4	22.5	22.1	22.1	21.9	21.9	21.6	21.8	21.9	21.6	21.4
		36	18	25.1	25.2	25.2	24.7	24.5	24.3	24.5	24.2	24.0	24.3	24.3	24.1
		75	0	25.1	25.2	25.2	22.8	22.5	22.3	23.5	23.2	23.1	23.4	23.3	23.1
	64QAM	1	0	22.3	22.9	22.3	22.2	22.0	21.6	22.1	21.9	21.7	21.9	22.0	21.5
		1	1	25.0	25.0	25.1	23.2	23.1	22.7	22.9	23.1	22.8	23.0	22.8	22.5
		1	76	25.1	25.1	25.1	23.0	22.8	22.7	22.8	23.0	22.7	23.0	22.7	22.4
		1	77	22.4	22.8	22.5	22.0	21.9	21.7	21.8	21.8	21.7	21.8	21.9	21.5
		36	18	25.0	25.0	25.1	23.3	23.0	22.9	23.0	22.7	22.6	22.8	22.8	22.6
		75	0	25.1	25.1	24.9	22.3	22.0	21.9	22.9	22.7	22.6	22.9	22.8	22.6
	256QAM	1	0	22.4	22.7	22.7	21.4	21.3	21.0	21.0	21.0	20.7	20.7	20.9	20.6
		1	1	22.6	22.9	22.8	21.4	21.2	21.0	21.1	20.7	20.7	20.8	20.9	20.5
		1	76	22.5	22.6	22.8	21.4	20.8	21.0	21.0	20.5	20.5	20.8	20.8	20.3
		1	77	22.5	22.6	22.8	21.2	21.0	21.0	20.8	20.6	20.6	20.8	20.8	20.3
		36	18	22.6	22.7	22.6	21.3	21.0	20.9	21.0	20.7	20.6	20.8	20.8	20.6
		75	0	22.5	22.7	22.6	21.2	21.0	20.9	21.0	20.7	20.6	20.9	20.7	20.6

**OUTPUT POWER FOR 5G NR n77 (40.0 MHz)**

Bandwidth (MHz)	Modulation	RB Allocation	RB Offset	Conducted Average (dBm)											
				ANT 6			ANT 7			ANT 1			ANT 5		
				631332	633332	635332	631332	633332	635332	631332	633332	635332	631332	633332	635332
40.0	BPSK	1	0	24.0	24.2	24.2	22.4	22.1	21.9	22.1	22.1	21.5	21.8	21.7	21.6
		1	1	26.0	26.2	26.3	25.9	25.7	25.5	25.6	25.5	25.0	25.3	25.2	25.0
		1	104	26.2	26.1	26.3	25.6	25.4	25.6	25.3	25.3	25.0	25.3	25.4	24.8
		1	105	24.0	24.1	24.2	22.0	21.8	22.1	22.0	21.7	21.7	21.9	21.6	21.5
		50	25	26.1	26.2	26.2	25.8	25.5	25.4	25.5	25.3	25.2	25.3	25.3	25.1
		100	0	26.1	26.1	26.1	24.2	24.0	23.8	25.0	24.8	24.7	24.8	24.8	24.6
	QPSK	1	0	23.5	23.6	23.7	22.4	22.1	21.9	22.2	22.0	21.7	21.8	21.7	21.8
		1	1	26.1	26.2	26.2	25.9	25.6	25.4	25.7	25.5	25.2	25.3	25.2	25.2
		1	104	26.2	26.3	26.3	25.7	25.4	25.4	25.5	25.2	25.2	25.4	25.2	24.9
		1	105	23.7	23.7	23.7	22.2	21.9	21.9	22.0	21.6	21.7	21.9	21.7	21.5
		50	25	26.1	26.1	26.2	25.7	25.5	25.4	25.5	25.3	25.2	25.4	25.3	25.1
		100	0	26.1	26.2	26.1	23.7	23.5	23.4	24.5	24.3	24.2	24.4	24.3	24.1
	16QAM	1	0	22.5	22.7	22.5	22.2	22.1	21.7	22.2	21.9	21.5	21.9	22.0	21.6
		1	1	24.6	24.9	25.0	24.7	24.5	24.1	24.6	24.4	24.0	24.4	24.4	24.0
		1	104	24.6	25.2	25.2	24.6	24.3	24.3	24.4	24.2	24.1	24.3	24.1	23.8
		1	105	22.5	22.6	22.5	22.0	21.9	21.7	21.7	21.6	21.5	21.8	21.6	21.3
		50	25	25.2	25.1	25.2	24.7	24.5	24.4	24.5	24.4	24.2	24.4	24.3	24.1
		100	0	25.2	25.1	25.2	22.7	22.6	22.3	23.5	23.3	23.2	23.4	23.2	23.1
	64QAM	1	0	22.6	22.7	22.5	22.3	21.9	21.8	22.1	22.1	21.5	21.9	21.7	21.8
		1	1	25.1	24.9	25.0	23.4	22.8	22.7	23.1	23.0	22.5	22.8	22.7	22.8
		1	104	25.0	25.0	25.0	23.1	22.7	22.8	22.9	22.7	22.6	22.8	22.6	22.5
		1	105	22.5	22.8	22.6	22.0	21.7	21.8	21.9	21.7	21.6	21.8	21.6	21.5
		50	25	25.1	25.1	25.2	23.2	23.0	22.9	23.1	22.8	22.7	22.9	22.7	22.6
		100	0	25.0	25.2	25.1	22.2	21.9	21.9	23.0	22.9	22.7	22.8	22.8	22.6
	256QAM	1	0	22.4	22.3	22.7	21.5	20.9	20.9	21.3	21.1	20.7	20.7	20.6	20.6
		1	1	22.5	22.7	22.6	21.4	20.9	20.9	21.3	21.0	20.6	20.8	20.7	20.6
		1	104	22.5	22.7	22.9	21.3	20.7	20.7	21.0	20.7	20.7	20.7	20.5	20.3
		1	105	22.5	22.8	22.8	21.2	20.7	20.9	21.1	20.8	20.7	20.7	20.5	20.3
		50	25	22.5	22.6	22.7	21.1	21.1	20.9	21.0	20.8	20.7	20.9	20.7	20.7
		100	0	22.6	22.6	22.7	21.1	21.0	20.9	21.0	20.8	20.7	20.8	20.8	20.6



**OUTPUT POWER FOR 5G NR n77 (50.0 MHz)**

Bandwidth (MHz)	Modulation	RB Allocation	RB Offset	Conducted Average (dBm)											
				ANT 6			ANT 7			ANT 1			ANT 5		
				631666	633332	634998	631666	633332	634998	631666	633332	634998	631666	633332	634998
50.0	BPSK	1	0	24.2	24.1	24.2	22.3	22.1	22.0	22.2	21.5	21.8	21.8	21.8	21.8
		1	1	26.1	26.1	26.2	25.8	25.6	25.5	25.7	25.6	25.3	25.3	25.3	25.3
		1	131	26.3	26.1	26.2	25.5	25.4	25.4	25.4	25.2	25.2	25.2	25.2	25.0
		1	132	24.3	24.1	24.2	22.0	21.9	21.9	21.9	21.7	21.6	21.8	21.7	21.4
		64	32	26.1	26.0	26.0	25.7	25.6	25.4	25.5	25.3	25.3	25.3	19.3	25.2
		128	0	26.0	26.0	26.1	24.2	24.0	23.9	25.1	24.8	24.7	24.8	24.8	24.7
	QPSK	1	0	23.5	23.7	23.7	22.4	22.2	22.0	22.2	22.0	21.8	21.8	21.9	21.8
		1	1	26.0	26.1	26.0	25.9	25.7	25.5	25.6	25.5	25.3	25.3	25.4	25.2
		1	131	26.2	26.3	26.3	25.6	25.4	25.4	25.3	25.2	25.2	25.3	25.3	24.9
		1	132	23.7	23.6	23.7	22.1	21.9	21.9	21.8	21.8	21.6	21.8	21.7	21.4
		64	32	26.1	26.1	26.3	25.7	25.5	25.4	25.5	25.3	25.3	25.3	25.3	25.2
		128	0	26.0	26.0	26.1	23.7	23.6	23.4	24.6	24.3	24.2	24.3	24.3	24.2
	16QAM	1	0	22.5	22.8	22.6	22.6	22.2	22.0	22.2	22.1	21.6	22.1	21.7	21.6
		1	1	25.0	25.1	25.1	25.1	24.8	24.6	24.7	24.6	24.1	24.6	24.1	24.0
		1	131	25.1	25.0	25.3	24.6	24.5	24.5	24.3	24.3	24.0	24.5	24.4	23.9
		1	132	22.5	22.8	22.6	22.3	22.0	21.9	21.8	21.8	21.5	21.9	21.9	21.4
		64	32	25.2	25.2	25.0	24.7	24.5	24.4	24.5	24.3	24.2	24.3	24.3	24.2
		128	0	25.0	25.2	25.1	22.7	22.6	22.4	23.5	23.3	23.2	23.4	23.4	23.1
	64QAM	1	0	22.6	23.1	22.5	22.3	22.0	21.8	22.3	22.1	21.6	21.7	21.9	21.7
		1	1	25.0	25.2	25.0	23.3	23.0	22.8	23.2	23.0	22.5	22.7	22.9	22.7
		1	131	25.1	25.3	25.1	22.9	22.8	22.9	22.9	22.8	22.5	22.7	22.8	22.4
		1	132	22.9	23.0	22.8	21.9	21.8	21.8	21.8	21.6	21.6	21.6	21.8	21.4
		64	32	25.1	25.1	25.1	23.2	23.1	22.9	23.1	22.8	22.7	22.9	22.8	22.7
		128	0	25.2	25.1	25.1	22.2	22.0	21.9	23.0	22.8	22.7	22.8	22.8	22.7
	256QAM	1	0	22.6	22.9	22.6	21.5	21.0	21.1	21.3	21.0	20.8	21.1	21.0	21.0
		1	1	22.5	22.7	22.6	21.5	21.0	21.0	21.3	21.0	20.6	21.0	21.0	20.9
		1	131	22.7	23.0	22.8	21.1	20.8	20.9	20.9	20.7	20.7	21.0	20.8	20.6
		1	132	22.6	22.7	22.9	21.2	20.8	20.9	20.9	20.8	20.6	21.0	20.8	20.7
		64	32	22.6	22.6	22.7	21.1	21.0	20.9	21.0	20.8	20.7	20.9	20.8	20.7
		128	0	22.6	22.6	22.7	21.2	21.0	20.9	21.0	20.9	20.7	20.9	20.8	20.7

**OUTPUT POWER FOR 5G NR n77 (60.0 MHz)**

Bandwidth (MHz)	Modulation	RB Allocation	RB Offset	Conducted Average (dBm)											
				ANT 6			ANT 7			ANT 1			ANT 5		
				632000	633332	634666	632000	633332	634666	632000	633332	634666	632000	633332	634666
60.0	BPSK	1	0	24.2	24.1	24.2	22.3	22.1	22.0	22.1	21.9	21.8	21.8	21.8	21.7
		1	1	26.1	26.1	26.2	25.8	25.6	25.5	25.6	25.4	25.4	25.3	25.4	25.0
		1	160	26.3	26.1	26.2	25.5	25.4	25.4	25.1	25.1	25.0	25.2	25.1	25.0
		1	161	24.3	24.1	24.2	22.0	21.9	21.9	21.6	21.6	21.5	21.7	21.6	21.4
		81	40	26.1	26.0	26.0	25.7	25.6	25.4	25.5	25.2	25.1	25.3	25.3	25.2
		162	0	26.0	26.0	26.1	24.2	24.0	23.9	25.0	24.8	24.7	24.8	24.8	24.8
	QPSK	1	0	23.5	23.7	23.7	22.4	22.2	22.0	22.0	21.9	21.8	21.8	21.8	21.7
		1	1	26.0	26.1	26.0	25.9	25.7	25.5	25.6	25.4	25.3	25.3	25.4	25.2
		1	160	26.2	26.3	26.3	25.6	25.4	25.4	25.2	25.1	25.1	25.2	25.2	25.0
		1	161	23.7	23.6	23.7	22.1	21.9	21.9	21.6	21.6	21.5	21.7	21.7	21.4
		81	40	26.1	26.1	26.3	25.7	25.5	25.4	25.5	25.2	25.2	25.3	25.3	25.2
		162	0	26.0	26.0	26.1	23.7	23.6	23.4	24.5	24.2	24.2	24.3	24.3	24.2
	16QAM	1	0	22.5	22.8	22.6	22.6	22.2	22.0	22.0	21.9	21.9	21.9	21.9	21.8
		1	1	25.0	25.1	25.1	25.1	24.8	24.6	24.7	24.5	24.4	24.4	24.3	24.4
		1	160	25.1	25.0	25.3	24.6	24.5	24.5	24.1	24.1	24.1	24.3	24.1	24.1
		1	161	22.5	22.8	22.6	22.3	22.0	21.9	21.7	21.5	21.6	21.8	21.5	21.4
		81	40	25.2	25.2	25.0	24.7	24.5	24.4	24.5	24.2	24.2	24.3	24.2	24.3
		162	0	25.0	25.2	25.1	22.7	22.6	22.4	23.5	23.3	23.2	23.4	23.3	23.2
	64QAM	1	0	22.6	23.1	22.5	22.3	22.0	21.8	22.1	21.7	21.8	22.0	21.7	21.8
		1	1	25.0	25.2	25.0	23.3	23.0	22.8	23.1	22.7	23.0	22.9	22.8	22.9
		1	160	25.1	25.3	25.1	22.9	22.8	22.9	22.8	22.5	22.7	22.7	22.6	22.5
		1	161	22.9	23.0	22.8	21.9	21.8	21.8	21.6	21.5	21.8	21.6	21.6	21.5
		81	40	25.1	25.1	25.1	23.2	23.1	22.9	23.0	22.7	22.7	22.8	22.8	22.7
		162	0	25.2	25.1	25.1	22.2	22.0	21.9	23.0	22.8	22.7	22.9	22.8	22.7
	256QAM	1	0	22.6	22.9	22.6	21.5	21.0	21.1	21.0	21.0	20.8	21.0	20.8	20.9
		1	1	22.5	22.7	22.6	21.5	21.0	21.0	21.0	21.0	20.8	21.1	20.9	20.8
		1	160	22.7	23.0	22.8	21.1	20.8	20.9	20.6	20.6	20.6	20.9	20.7	20.5
		1	161	22.6	22.7	22.9	21.2	20.8	20.9	20.7	20.6	20.5	20.8	20.6	20.4
		81	40	22.6	22.6	22.7	21.1	21.0	20.9	21.0	20.7	20.6	20.8	20.7	20.7
		162	0	22.6	22.6	22.7	21.2	21.0	20.9	21.0	20.8	20.7	20.8	20.8	20.7

**OUTPUT POWER FOR 5G NR n77 (70.0 MHz)**

Bandwidth (MHz)	Modulation	RB Allocation	RB Offset	Conducted Average (dBm)											
				ANT 6			ANT 7			ANT 1			ANT 5		
				632333	633332	634333	632333	633332	634333	632333	633332	634333	632333	633332	634333
70.0	BPSK	1	0	24.0	24.1	24.1	22.3	22.2	22.0	22.0	22.0	21.5	21.8	21.8	21.4
		1	1	26.1	26.1	26.1	25.9	25.7	25.5	25.5	25.1	25.2	25.2	25.4	24.9
		1	187	26.2	26.1	26.4	25.5	25.4	25.4	25.1	25.2	25.2	25.2	25.1	24.9
		1	188	24.2	24.2	24.3	21.9	21.9	21.9	21.6	21.6	21.6	21.7	21.6	21.3
		90	45	26.1	26.2	26.1	25.7	25.6	25.4	25.5	25.3	25.1	25.3	25.3	24.9
		180	0	26.1	26.1	26.2	24.2	24.1	24.0	24.9	24.8	24.6	24.8	24.8	24.5
	QPSK	1	0	23.5	23.6	23.6	22.3	22.3	21.9	22.0	21.9	21.5	21.8	21.9	21.3
		1	1	26.1	26.1	26.1	25.9	25.8	25.4	25.6	25.5	25.1	25.3	25.3	24.9
		1	187	26.2	26.2	26.2	25.4	25.4	25.4	25.1	25.2	25.2	25.2	25.1	24.9
		1	188	23.6	23.8	23.7	21.9	21.9	21.8	21.7	21.5	21.6	21.7	21.7	21.4
		90	45	26.1	26.2	26.1	25.6	25.5	25.4	25.4	25.2	25.1	25.3	25.3	24.9
		180	0	26.1	26.1	26.2	23.6	23.6	23.5	24.5	24.3	24.1	24.4	24.3	23.9
	16QAM	1	0	22.7	22.5	22.6	22.4	22.1	21.9	22.1	22.0	21.9	21.8	21.9	21.4
		1	1	25.0	24.9	25.2	24.9	24.6	24.4	24.6	24.5	23.9	24.4	24.5	24.0
		1	187	25.2	25.0	25.1	24.4	24.3	24.3	24.2	24.1	24.1	24.2	24.3	23.9
		1	188	22.7	22.5	22.8	21.9	21.8	21.8	21.6	21.7	21.7	21.7	21.8	21.4
		90	45	25.1	25.1	25.1	24.6	24.5	24.4	24.5	24.2	24.0	24.3	24.3	23.9
		180	0	25.2	25.0	25.2	22.6	22.6	22.4	23.5	23.3	23.1	23.3	23.3	22.9
	64QAM	1	0	22.4	22.6	22.5	22.5	22.2	21.9	22.0	22.0	21.6	21.9	21.9	21.3
		1	1	24.9	25.0	25.0	23.3	23.3	22.9	23.1	23.0	22.5	22.9	22.9	22.4
		1	187	24.7	24.9	25.0	23.0	22.9	22.8	22.6	22.7	22.7	22.8	22.7	22.3
		1	188	22.7	22.9	23.0	21.9	21.8	21.8	21.7	21.7	21.6	21.7	21.7	21.3
		90	45	25.0	25.0	25.0	23.2	23.1	22.9	23.0	22.7	22.6	22.9	22.8	22.4
		180	0	25.1	25.0	25.0	22.2	22.0	22.0	23.0	22.8	22.6	22.9	22.7	22.4
	256QAM	1	0	22.9	22.3	22.4	21.3	21.3	21.1	21.2	20.9	20.4	21.1	20.9	20.5
		1	1	22.4	22.3	22.6	21.4	21.4	21.1	21.3	21.0	20.5	21.1	21.0	20.5
		1	187	22.8	22.8	22.5	20.9	21.0	21.0	20.9	20.6	20.6	20.9	20.8	20.4
		1	188	22.5	22.7	22.6	20.9	21.0	21.0	20.9	20.7	20.5	20.9	20.7	20.4
		90	45	22.5	22.6	22.7	21.2	21.0	20.9	20.9	20.8	20.6	20.8	20.8	20.4
		180	0	22.5	22.6	22.6	21.2	21.1	21.0	21.0	20.8	20.6	20.8	20.8	20.4

**OUTPUT POWER FOR 5G NR n77 (80.0 MHz)**

Bandwidth (MHz)	Modulation	RB Allocation	RB Offset	Conducted Average (dBm)											
				ANT 6			ANT 7			ANT 1			ANT 5		
				632666	633332	633998	632666	633332	633998	632666	633332	633998	632666	633332	633998
80.0	BPSK	1	0	24.0	24.2	24.2	22.3	22.3	22.1	22.0	22.0	21.9	21.7	21.8	21.8
		1	1	26.2	26.2	26.2	25.9	25.8	25.7	25.7	25.6	25.5	25.3	25.4	25.4
		1	215	26.2	26.2	26.4	25.5	25.4	25.4	25.1	25.1	25.1	25.2	25.1	25.0
		1	216	24.4	24.2	24.1	21.9	21.9	21.9	21.7	21.7	21.6	21.7	21.6	21.4
		108	54	26.1	26.1	26.1	25.7	25.5	25.4	25.3	25.3	25.1	25.3	25.3	25.2
		216	0	26.2	26.2	26.3	24.2	24.0	23.9	24.8	24.7	24.6	24.8	24.8	24.7
	QPSK	1	0	23.6	23.6	23.5	22.3	22.2	22.1	22.1	22.1	21.8	21.8	21.9	21.8
		1	1	26.1	26.0	26.3	25.9	25.8	25.7	25.7	25.6	25.4	25.4	25.3	25.4
		1	215	26.2	26.4	26.2	25.4	25.4	25.4	25.1	25.2	25.1	25.3	25.2	25.1
		1	216	23.6	23.8	23.8	21.9	21.9	21.9	21.7	21.7	21.6	21.7	21.6	21.5
		108	54	26.1	26.2	26.1	25.6	25.5	25.4	25.4	25.3	25.1	25.3	25.3	25.2
		216	0	26.2	26.1	26.1	23.6	23.5	23.4	24.4	24.3	24.2	24.3	24.2	24.2
	16QAM	1	0	22.2	22.3	22.4	22.2	22.1	22.3	22.3	22.2	21.9	21.8	21.8	21.9
		1	1	25.0	25.0	25.0	24.8	24.7	24.8	24.8	24.8	24.5	24.5	24.4	24.5
		1	215	24.8	25.1	24.9	24.3	24.3	24.6	24.3	24.3	24.1	24.2	24.2	24.1
		1	216	22.3	22.7	23.0	21.7	21.7	22.0	21.7	21.7	21.6	21.7	21.6	21.6
		108	54	25.2	25.1	25.0	24.7	24.4	24.4	24.4	24.3	24.1	24.3	24.3	24.2
		216	0	25.2	25.1	25.1	22.6	22.5	22.4	23.4	23.3	23.2	23.3	23.3	23.3
	64QAM	1	0	22.4	22.7	22.5	22.2	22.2	22.2	22.0	22.2	22.1	22.0	21.9	22.1
		1	1	24.9	25.1	25.1	23.2	23.6	23.3	23.1	23.3	23.1	23.1	23.0	23.1
		1	215	25.0	25.1	25.1	22.8	23.2	23.0	22.7	22.9	22.8	22.9	22.7	22.8
		1	216	22.5	22.7	23.0	21.7	22.1	22.0	21.6	21.9	21.7	21.9	21.6	21.6
		108	54	25.0	25.1	25.1	23.1	23.0	22.8	22.9	22.7	22.5	22.8	22.8	22.7
		216	0	25.1	25.0	25.1	22.2	22.0	21.9	22.9	22.8	22.7	22.8	22.8	22.7
	256QAM	1	0	22.8	22.4	22.7	21.4	21.1	21.2	21.1	20.9	20.9	21.0	20.8	20.8
		1	1	22.9	22.4	22.8	21.4	21.2	21.3	21.2	21.0	21.0	21.1	20.7	20.9
		1	215	23.2	22.6	22.8	20.9	21.0	21.1	20.7	20.6	20.7	20.9	20.5	20.6
		1	216	23.0	22.6	22.7	20.9	20.8	21.0	20.6	20.5	20.7	20.8	20.4	20.5
		108	54	22.6	22.6	22.7	21.1	21.0	20.9	20.8	20.8	20.7	20.8	20.8	20.8
		216	0	22.5	22.6	22.7	21.1	21.1	20.9	20.9	20.8	20.7	20.8	20.8	20.7

**OUTPUT POWER FOR 5G NR n77 (90.0 MHz)**

Bandwidth (MHz)	Modulation	RB Allocation	RB Offset	Conducted Average (dBm)											
				ANT 6			ANT 7			ANT 1			ANT 5		
				633000	633332	633666	633000	633332	633666	633000	633332	633666	633000	633332	633666
90.0	BPSK	1	0	24.2	24.1	24.1	22.3	22.3	22.2	22.1	22.1	22.0	21.8	21.8	21.8
		1	1	26.1	26.3	26.2	25.9	25.9	25.9	25.7	25.7	25.7	25.4	25.4	25.4
		1	243	26.4	26.3	26.4	25.5	25.5	25.5	25.2	25.2	25.2	25.2	25.1	25.0
		1	244	24.2	24.2	24.4	21.9	21.9	21.9	21.7	21.6	21.6	21.6	21.5	21.5
		120	60	26.1	26.1	26.2	25.6	25.5	25.5	25.3	25.2	25.2	25.3	25.3	25.3
		243	0	26.1	26.1	26.1	24.1	24.0	24.0	24.9	24.8	24.7	24.8	24.8	24.8
	QPSK	1	0	23.5	23.6	23.6	22.4	22.3	22.2	22.1	22.0	22.0	21.8	21.8	21.8
		1	1	26.1	26.1	26.3	26.0	25.9	25.8	25.8	25.7	25.7	25.5	25.5	25.4
		1	243	26.2	26.4	26.3	25.5	25.5	25.5	25.2	25.2	25.2	25.2	25.2	25.1
		1	244	23.7	23.8	23.7	21.9	21.9	22.0	21.7	21.6	21.6	21.6	21.6	21.4
		120	60	26.1	26.1	26.2	25.6	25.5	25.4	25.3	25.2	25.2	25.4	25.3	25.3
		243	0	26.3	26.1	26.2	23.6	23.6	23.4	24.4	24.3	24.3	24.3	24.3	24.3
	16QAM	1	0	22.2	22.3	22.4	22.4	22.3	22.2	22.2	22.2	22.1	21.8	21.8	21.8
		1	1	25.0	25.0	25.0	25.0	24.9	24.8	24.7	24.8	24.7	24.5	24.4	24.5
		1	243	24.8	25.1	24.9	24.5	24.5	24.6	24.2	24.3	24.1	24.2	24.1	24.1
		1	244	22.3	22.7	23.0	21.9	21.9	21.9	21.7	21.8	21.7	21.6	21.6	21.5
		120	60	25.2	25.1	25.0	24.6	24.5	24.5	24.4	24.2	24.2	24.3	24.4	24.3
		243	0	25.2	25.1	25.1	22.6	22.5	22.5	23.4	23.4	23.2	23.3	23.3	23.3
	64QAM	1	0	22.4	22.7	22.5	22.2	22.4	22.4	22.2	22.2	22.1	21.8	21.8	21.7
		1	1	24.9	25.1	25.1	23.3	23.5	23.5	23.2	23.3	23.1	22.9	22.9	22.8
		1	243	25.0	25.1	25.1	22.9	23.1	23.1	22.8	22.8	22.7	22.7	22.6	22.5
		1	244	22.5	22.7	23.0	21.8	22.0	22.0	21.7	21.8	21.6	21.5	21.5	21.4
		120	60	25.0	25.1	25.1	23.1	23.0	23.0	22.8	22.7	22.7	22.9	22.7	22.8
		243	0	25.1	25.0	25.1	22.1	22.1	22.0	22.8	22.9	22.7	22.8	22.8	22.8
	256QAM	1	0	22.8	22.4	22.7	21.3	21.6	21.2	21.2	21.1	21.0	21.0	20.7	20.7
		1	1	22.9	22.4	22.8	21.4	21.6	21.3	21.3	21.2	21.1	21.1	21.0	20.9
		1	243	23.2	22.6	22.8	21.0	21.1	21.0	20.8	20.9	20.7	20.8	20.7	20.6
		1	244	23.0	22.6	22.7	20.9	21.1	20.9	20.7	20.7	20.7	20.7	20.7	20.4
		120	60	22.6	22.6	22.7	21.0	21.0	21.0	20.9	20.8	20.8	20.8	20.8	20.8
		243	0	22.5	22.6	22.7	21.1	21.1	21.0	20.8	20.8	20.7	20.8	20.8	20.8

**OUTPUT POWER FOR 5G NR n77 (100.0 MHz)**

Bandwidth (MHz)	Modulation	RB Allocation	RB Offset	Conducted Average (dBm)											
				ANT 6			ANT 7			ANT 1			ANT 5		
				N/A	633332	N/A	N/A	633332	N/A	N/A	633332	N/A	N/A	633332	N/A
100.0	BPSK	1	0		24.0			22.3			22.1			21.7	
		1	1		26.2			26.0			25.7			25.4	
		1	271		26.3			25.6			25.2			25.1	
		1	272		24.3			21.9			21.6			21.4	
		135	67		26.2			25.5			25.2			25.3	
		270	0		26.1			24.0			24.8			24.9	
	QPSK	1	0		23.6			22.3			22.1			21.7	
		1	1		26.2			26.0			25.8			25.4	
		1	271		26.3			25.6			25.2			25.1	
		1	272		23.6			22.0			21.6			21.5	
		135	67		26.1			25.5			25.3			25.3	
		270	0		26.3			23.6			24.4			24.3	
	16QAM	1	0		22.5			22.5			22.1			21.7	
		1	1		25.2			25.2			24.8			24.3	
		1	271		25.3			24.7			24.3			23.9	
		1	272		22.8			22.1			21.5			21.3	
		135	67		25.0			24.5			24.3			24.2	
		270	0		25.2			22.6			23.4			23.3	
	64QAM	1	0		22.3			22.3			22.3			21.9	
		1	1		24.9			23.4			23.4			23.1	
		1	271		25.2			23.0			23.0			22.8	
		1	272		22.6			21.8			21.8			21.5	
		135	67		25.0			23.0			22.8			22.8	
		270	0		25.1			22.1			22.9			22.8	
	256QAM	1	0		22.7			21.2			21.3			20.9	
		1	1		22.6			21.4			21.4			21.1	
		1	271		23.0			20.9			20.8			20.7	
		1	272		22.6			20.8			20.6			20.5	
		135	67		22.6			21.0			20.8			20.9	
		270	0		22.6			21.1			20.9			20.8	

### 8.19. 5G NR n77 (Part 27 3700-3980MHz)

<b>Test Engineer ID:</b>	32934IG, 27979HN and 27966PV	<b>Test Date:</b>	2024-02-26 to 2024-03-27
--------------------------	---------------------------------	-------------------	--------------------------

#### OUTPUT POWER FOR 5G NR n77 (10.0 MHz)

Bandwidth (MHz)	Modulation	RB Allocation	RB Offset	Conducted Average (dBm)											
				ANT 6			ANT 7			ANT 1			ANT 5		
				647000	656000	665000	647000	656000	665000	647000	656000	665000	647000	656000	665000
10.0	BPSK	1	0	24.4	24.6	24.5	23.1	23.3	23.2	23.9	24.3	24.2	23.6	24.1	24.3
		1	1	24.8	25.1	25.0	23.8	23.8	23.7	24.5	24.9	24.7	24.1	24.6	24.9
		1	22	24.9	25.2	25.0	23.5	24.0	23.7	24.3	24.9	24.6	24.2	24.6	24.7
		1	23	24.3	24.7	24.4	23.2	23.4	23.2	23.8	24.3	24.1	23.5	24.2	24.1
		12	6	24.8	25.2	25.0	23.5	24.0	23.6	24.4	24.9	24.8	24.1	24.6	24.7
		24	0	24.3	24.6	24.4	23.1	23.4	23.2	23.8	24.4	24.2	23.6	24.0	24.2
	QPSK	1	0	24.0	24.1	23.9	22.6	22.8	22.7	23.4	23.9	23.6	23.0	23.6	23.7
		1	1	24.9	25.1	24.9	23.6	23.9	23.7	24.5	24.8	24.5	24.0	24.7	24.7
		1	22	24.9	25.2	24.9	23.6	24.0	23.6	24.3	24.9	24.5	24.1	24.6	24.8
		1	23	23.8	24.1	23.9	22.7	23.0	22.6	23.4	24.0	23.6	23.1	23.6	23.6
		12	6	24.8	25.2	24.9	23.5	23.9	23.7	24.4	24.9	24.8	24.0	24.5	24.6
		24	0	23.8	24.1	23.9	22.5	22.9	22.8	23.3	23.8	23.7	23.0	23.5	23.7
	16QAM	1	0	22.7	23.0	22.9	21.8	21.9	21.6	22.6	23.0	23.1	22.0	22.4	22.6
		1	1	23.8	24.0	23.9	22.8	23.0	22.7	23.4	24.0	23.6	23.2	23.5	23.6
		1	22	23.9	24.3	23.7	22.8	23.1	22.7	23.6	24.1	23.9	23.0	23.9	23.4
		1	23	22.8	23.0	22.9	21.5	21.9	21.5	22.7	22.9	22.6	22.0	22.5	22.5
		12	6	23.7	24.1	23.9	22.6	22.8	22.8	23.4	23.8	23.6	23.1	23.6	23.7
		24	0	22.9	23.2	23.0	21.6	22.0	21.6	22.3	22.9	22.8	22.1	22.5	22.7
	64QAM	1	0	22.1	22.4	22.8	20.9	21.3	20.9	22.0	22.5	22.3	21.5	22.0	22.3
		1	1	21.7	22.3	22.1	20.8	21.3	21.1	22.0	22.7	22.0	21.5	22.4	22.3
		1	22	22.2	22.5	22.5	20.7	21.2	21.1	22.0	22.8	22.3	21.5	22.2	22.2
		1	23	22.5	22.6	22.5	21.0	21.5	21.1	22.0	22.5	22.5	21.3	22.4	21.8
		12	6	22.2	22.7	22.3	21.1	21.3	21.1	22.0	22.4	22.2	21.5	21.9	22.1
		24	0	22.3	22.5	22.5	21.1	21.4	21.2	22.0	22.3	22.2	21.6	22.0	22.2
	256QAM	1	0	20.4	20.4	20.5	19.2	19.8	19.2	19.7	20.5	20.4	19.3	19.6	20.3
		1	1	20.5	20.5	20.5	19.3	19.8	19.1	20.1	20.2	19.9	19.4	19.9	20.0
		1	22	20.4	20.6	20.5	19.3	19.5	19.2	20.0	20.5	20.3	19.5	20.0	20.1
		1	23	20.5	20.6	20.5	19.0	19.5	19.1	20.1	20.6	20.4	19.7	19.8	20.3
		12	6	20.4	20.6	20.4	19.2	19.5	19.1	19.8	20.4	20.2	19.4	20.0	20.2
		24	0	20.3	20.7	20.3	19.2	19.5	19.1	19.8	20.4	20.1	19.5	19.9	20.1

#### OUTPUT POWER FOR 5G NR n77 (15.0 MHz)

Bandwidth (MHz)	Modulation	RB Allocation	RB Offset	Conducted Average (dBm)											
				ANT 6			ANT 7			ANT 1			ANT 5		
				647166	656000	664833	647166	656000	664833	647166	656000	664833	647166	656000	664833
15.0	BPSK	1	0	24.5	24.5	24.5	23.2	23.4	23.3	24.1	24.4	24.3	23.6	23.9	24.1
		1	1	24.9	25.0	25.0	23.8	23.9	23.7	24.7	25.0	24.8	24.1	24.4	24.6
		1	36	25.0	25.1	24.9	23.7	24.0	23.7	24.6	25.0	24.8	24.2	24.6	24.5
		1	37	24.4	24.7	24.3	23.1	23.4	23.1	24.2	24.5	24.2	23.5	24.1	24.2
		18	9	25.0	25.2	25.0	23.6	24.0	23.8	24.6	24.9	24.8	24.0	24.5	24.7
		36	0	24.5	24.6	24.5	23.2	23.4	23.1	24.2	24.4	24.3	23.6	24.1	24.2
	QPSK	1	0	23.9	24.1	24.0	22.8	22.8	22.7	23.8	23.8	23.9	23.1	23.5	23.5
		1	1	25.0	24.9	24.8	23.6	23.8	23.7	24.7	24.9	24.9	24.1	24.4	24.6
		1	36	25.0	25.1	24.9	23.7	23.9	23.6	24.7	25.1	24.7	24.2	24.5	24.6
		1	37	23.9	24.2	23.9	22.6	22.9	22.5	23.8	24.0	23.7	23.2	23.6	23.5
		18	9	24.9	25.0	25.0	23.6	23.9	23.6	24.6	24.9	24.7	24.1	24.5	24.7
		36	0	23.8	24.0	24.0	22.6	22.9	22.7	23.6	24.0	23.8	23.1	23.5	23.8
	16QAM	1	0	22.8	22.8	22.9	22.1	21.7	21.4	22.7	22.8	22.8	21.8	22.3	22.6
		1	1	23.7	24.1	24.0	23.0	22.5	22.5	23.5	23.8	23.8	22.8	23.3	23.5
		1	36	23.7	24.2	23.7	23.0	23.0	22.3	23.5	24.0	24.0	22.8	23.5	23.5
		1	37	22.8	22.8	22.8	22.1	22.0	21.3	22.7	22.8	22.8	21.9	22.5	22.5
		18	9	23.9	24.1	23.9	22.8	23.0	22.6	23.7	23.9	23.7	23.1	23.5	23.7
		36	0	22.9	23.2	22.9	21.7	21.8	21.6	22.6	22.9	22.8	22.1	22.5	22.7
	64QAM	1	0	22.4	22.8	22.4	21.1	21.2	21.1	22.0	22.1	22.4	21.6	21.7	22.0
		1	1	22.0	22.3	22.4	21.0	21.2	21.0	21.8	22.2	22.6	21.6	21.8	22.1
		1	36	22.6	22.5	22.7	21.4	21.4	20.9	22.2	22.1	22.1	21.7	21.8	22.1
		1	37	22.3	22.7	22.3	21.4	21.3	21.0	21.9	22.4	22.5	21.6	21.9	22.1
		18	9	22.4	22.7	22.5	21.1	21.4	21.1	22.1	22.4	22.2	21.5	22.1	22.1
		36	0	22.4	22.6	22.5	21.1	21.4	21.2	22.2	22.4	22.2	21.6	22.0	22.2
	256QAM	1	0	20.2	20.4	20.6	19.2	19.4	19.3	20.0	20.4	20.2	19.3	19.9	20.1
		1	1	20.4	20.5	20.7	19.2	19.4	19.4	20.0	20.2	20.3	19.3	19.9	20.1
		1	36	20.5	20.4	20.6	19.2	19.4	19.3	20.2	20.3	19.8	19.4	19.9	20.0
		1	37	20.3	20.9	20.4	19.2	19.4	19.1	20.3	20.9	20.3	19.2	20.0	20.1
		18	9	20.3	20.6	20.4	19.1	19.5	19.2	20.1	20.5	20.2	19.5	20.1	20.3
		36	0	20.4	20.5	20.3	19.1	19.5	19.2	20.2	20.5	20.2	19.5	20.0	20.2

**OUTPUT POWER FOR 5G NR n77 (20.0 MHz)**

Bandwidth (MHz)	Modulation	RB Allocation	RB Offset	Conducted Average (dBm)											
				ANT 6			ANT 7			ANT 1			ANT 5		
				647333	656000	664666	647333	656000	664666	647333	656000	664666	647333	656000	664666
20.0	BPSK	1	0	24.3	24.6	24.4	23.2	23.3	23.4	24.1	24.4	24.2	23.5	23.9	24.1
		1	1	24.9	25.1	25.0	23.6	23.9	23.9	24.6	24.9	24.6	24.0	24.4	24.7
		1	49	25.0	25.2	24.9	23.6	24.1	23.8	24.6	25.0	24.7	24.1	24.6	24.7
		1	50	24.3	24.6	24.4	23.2	23.4	23.2	24.2	24.4	24.2	23.4	24.0	24.1
		25	12	24.8	25.2	24.9	23.7	24.0	23.7	24.6	25.0	24.7	24.0	24.5	24.7
		50	0	24.3	24.7	24.4	23.1	23.4	23.1	24.1	24.4	24.1	23.5	24.0	24.2
	QPSK	1	0	23.8	24.1	23.9	22.7	22.8	22.9	23.6	24.0	23.7	23.0	23.4	23.6
		1	1	24.8	25.2	25.0	23.6	23.8	23.8	24.6	24.7	24.5	24.0	24.4	24.6
		1	49	24.9	25.2	24.9	23.7	23.9	23.6	24.5	24.8	24.6	24.0	24.6	24.7
		1	50	23.8	24.2	23.9	22.7	23.0	22.6	23.6	23.9	23.6	22.9	23.6	23.7
		25	12	24.8	25.2	24.9	23.7	24.0	23.8	24.6	24.9	24.7	24.1	24.5	24.7
		50	0	23.9	24.1	23.9	22.6	22.9	22.8	23.6	24.0	23.8	23.1	23.5	23.7
	16QAM	1	0	22.4	22.8	23.0	21.5	22.0	21.7	22.8	23.0	22.9	21.9	22.6	22.8
		1	1	23.9	23.8	24.1	22.1	22.9	23.0	23.7	23.7	23.7	23.0	23.6	23.7
		1	49	23.9	24.2	24.0	22.2	23.2	22.8	23.8	23.9	23.6	22.9	23.7	23.8
		1	50	23.0	23.1	23.0	21.6	22.3	21.7	22.7	23.2	22.7	22.0	22.8	22.7
		25	12	23.9	24.2	24.0	22.8	22.9	22.8	23.6	23.8	23.7	23.0	23.5	23.7
		50	0	22.8	23.2	22.9	21.5	21.9	21.7	22.7	22.9	22.7	22.1	22.4	22.7
	64QAM	1	0	22.7	22.6	22.3	21.1	21.4	21.0	22.0	22.4	22.2	21.4	22.2	22.1
		1	1	22.5	22.5	22.6	21.2	21.2	21.1	21.7	22.2	22.2	21.4	22.0	22.0
		1	49	22.4	22.7	22.4	21.4	21.5	21.0	22.0	22.4	22.1	21.5	22.2	22.0
		1	50	22.2	22.8	22.4	21.2	21.5	21.0	22.1	22.5	22.1	21.5	22.2	22.1
		25	12	22.3	22.6	22.4	21.3	21.3	21.3	22.0	22.4	22.2	21.5	22.1	22.1
		50	0	22.4	22.7	22.4	21.1	21.5	21.3	22.2	22.4	22.2	21.6	22.0	22.2
	256QAM	1	0	20.4	20.5	20.3	19.0	19.5	19.6	19.8	20.4	20.0	19.4	20.0	20.1
		1	1	20.2	20.6	20.6	18.9	19.6	19.1	20.2	20.2	19.8	19.3	19.9	20.1
		1	49	20.5	21.0	20.6	18.9	19.7	19.0	19.8	20.4	20.3	19.6	20.1	20.3
		1	50	20.3	20.9	20.1	18.9	19.8	19.1	20.2	20.5	20.3	19.6	20.1	19.9
		25	12	20.3	20.7	20.3	19.1	19.4	19.2	20.0	20.3	20.1	19.5	19.9	20.2
		50	0	20.4	20.6	20.5	19.2	19.5	19.1	20.1	20.4	20.2	19.5	20.0	20.1

**OUTPUT POWER FOR 5G NR n77 (25.0 MHz)**

Bandwidth (MHz)	Modulation	RB Allocation	RB Offset	Conducted Average (dBm)											
				ANT 6			ANT 7			ANT 1			ANT 5		
				647500	656000	664500	647500	656000	664500	647500	656000	664500	647500	656000	664500
25.0	BPSK	1	0	24.2	24.5	24.3	23.1	23.2	23.3	24.0	24.3	24.1	23.4	23.8	24.0
		1	1	24.8	25.0	24.9	23.5	23.8	23.8	24.5	24.8	24.5	23.9	24.3	24.6
		1	63	24.9	25.2	24.8	23.5	24.0	23.7	24.5	25.0	24.6	24.0	24.7	24.6
		1	64	24.2	24.5	24.3	23.1	23.3	23.1	24.1	24.3	24.1	23.3	23.9	24.0
		32	16	24.7	25.1	24.8	23.6	24.1	23.6	24.5	24.9	24.6	23.9	24.4	24.6
		64	0	24.2	24.6	24.3	23.0	23.3	23.0	24.0	24.3	24.0	23.4	23.9	24.1
	QPSK	1	0	23.7	24.0	23.8	22.6	22.7	22.8	23.5	23.9	23.6	22.9	23.3	23.5
		1	1	24.7	25.1	24.9	23.5	23.7	23.7	24.5	24.6	24.4	23.9	24.3	24.5
		1	49	24.8	25.2	24.8	23.6	23.9	23.5	24.4	24.9	24.5	23.9	24.7	24.6
		1	50	23.7	24.1	23.8	22.6	22.9	22.5	23.5	23.8	23.5	22.8	23.5	23.6
		25	12	24.7	25.1	24.8	23.6	23.8	23.7	24.5	24.8	24.6	24.0	24.4	24.6
		50	0	23.8	24.0	23.8	22.5	22.8	22.7	23.5	23.9	23.7	23.0	23.4	23.6
	16QAM	1	0	22.3	22.7	22.9	21.4	21.9	21.6	22.7	22.9	22.8	21.8	22.5	22.7
		1	1	23.8	23.7	24.0	22.0	22.8	23.0	23.6	23.6	23.6	22.9	23.5	23.6
		1	49	23.8	24.3	23.9	22.1	22.9	22.7	23.7	23.7	23.5	22.8	23.6	23.5
		1	50	22.9	23.0	22.9	21.5	22.2	21.6	22.6	23.1	22.6	21.9	22.7	22.6
		25	12	23.8	24.1	23.9	22.7	22.8	22.7	23.5	23.8	23.6	22.9	23.4	23.6
		50	0	22.7	23.1	22.8	21.4	21.8	21.6	22.6	22.8	22.6	22.0	22.3	22.6
	64QAM	1	0	22.6	22.5	22.2	21.0	21.3	20.9	21.9	22.3	22.1	21.3	22.1	22.0
		1	1	22.4	22.4	22.5	21.1	21.1	21.0	21.6	22.1	22.1	21.3	21.9	21.9
		1	49	22.3	22.6	22.3	21.3	21.4	20.9	21.9	22.3	22.0	21.4	22.1	21.9
		1	50	22.1	22.7	22.3	21.1	21.4	20.9	22.0	22.3	22.0	21.4	22.1	22.0
		25	12	22.2	22.5	22.3	21.2	21.2	21.2	21.9	22.3	22.1	21.4	22.0	22.1
		50	0	22.3	22.6	22.3	21.0	21.4	21.2	22.1	22.3	22.1	21.5	21.9	22.1
	256QAM	1	0	20.3	20.4	20.2	18.9	19.4	19.5	19.7	20.3	19.9	19.3	19.9	20.0
		1	1	20.1	20.5	20.5	18.8	19.5	19.0	20.1	20.1	19.7	19.2	19.8	20.0
		1	49	20.4	20.9	20.5	18.8	19.6	18.9	19.7	20.3	20.2	19.5	20.0	20.2
		1	50	20.2	20.8	20.0	18.8	19.7	19.0	20.1	20.4	20.2	19.5	20.0	19.8
		25	12	20.2	20.6	20.2	19.0	19.3	19.1	19.9	20.2	20.0	19.4	19.8	20.1
		50	0	20.3	20.5	20.4	19.1	19.4	19.0	20.0	20.3	20.1	19.4	19.9	20.0

**OUTPUT POWER FOR 5G NR n77 (30.0 MHz)**

Bandwidth (MHz)	Modulation	RB Allocation	RB Offset	Conducted Average (dBm)											
				ANT 6			ANT 7			ANT 1			ANT 5		
				647666	656000	664333	647666	656000	664333	647666	656000	664333	647666	656000	664333
30.0	BPSK	1	0	24.4	24.5	24.5	23.2	23.3	23.3	24.0	24.3	24.2	23.5	23.8	24.1
		1	1	24.9	25.0	25.0	23.7	23.8	23.8	24.5	24.6	24.6	24.0	24.3	24.6
		1	76	25.0	<b>25.2</b>	24.9	23.9	<b>24.1</b>	23.6	24.6	<b>25.0</b>	24.4	24.0	24.6	24.6
		1	77	24.5	24.7	24.4	23.2	23.6	23.2	24.0	24.4	24.2	23.5	24.1	24.1
		36	18	24.8	25.2	24.9	23.8	23.9	23.7	24.6	24.9	24.5	24.1	24.5	<b>24.7</b>
		75	0	24.3	24.6	24.4	23.3	23.4	23.2	24.1	24.4	24.1	23.5	24.0	24.2
	QPSK	1	0	23.8	23.8	24.0	22.7	22.8	22.8	23.5	23.8	23.8	22.9	23.5	23.6
		1	1	24.8	25.0	24.9	23.7	23.8	23.9	24.6	24.8	24.7	23.9	24.4	24.6
		1	76	24.8	<b>25.2</b>	24.9	23.8	<b>24.1</b>	23.6	24.6	<b>25.1</b>	24.5	24.0	24.6	24.5
		1	77	24.0	24.1	23.8	22.8	23.1	22.6	23.6	24.0	23.6	22.8	23.5	23.5
		36	18	24.9	25.1	24.9	23.7	23.9	23.7	24.4	24.9	24.8	24.1	24.5	<b>24.7</b>
		75	0	23.9	24.0	24.0	22.7	22.9	22.8	23.5	23.9	23.6	23.1	23.5	23.7
	16QAM	1	0	22.9	22.8	23.2	21.8	21.9	21.8	22.8	22.6	22.4	21.9	22.2	22.6
		1	1	24.0	<b>24.2</b>	24.1	22.8	23.1	22.8	23.7	23.8	23.4	23.0	23.5	23.6
		1	76	24.2	24.1	24.1	22.7	<b>23.2</b>	22.8	23.4	23.6	23.6	23.0	23.5	23.7
		1	77	22.8	23.3	23.1	21.9	22.2	21.6	22.4	22.9	22.6	21.9	22.5	22.7
		36	18	23.8	24.1	24.0	22.7	22.9	22.8	23.6	<b>24.0</b>	23.7	23.0	23.6	<b>23.7</b>
		75	0	22.9	23.1	22.9	21.7	22.0	21.8	22.5	22.9	22.6	22.0	22.5	22.7
	64QAM	1	0	22.0	22.4	22.6	21.1	21.4	21.0	22.1	22.1	<b>22.5</b>	21.6	21.9	22.0
		1	1	22.4	22.4	22.6	21.1	21.2	21.1	22.1	22.2	22.5	21.5	21.8	<b>22.2</b>
		1	76	22.6	<b>22.7</b>	22.4	21.3	<b>22.0</b>	20.9	22.0	22.4	22.0	21.5	22.0	22.1
		1	77	22.4	22.3	22.2	21.1	21.5	21.3	22.0	22.4	22.1	21.4	22.1	22.2
		36	18	22.4	22.5	22.6	21.2	21.5	21.3	22.0	22.3	22.1	21.5	22.0	22.1
		75	0	22.5	22.6	22.4	21.2	21.5	21.2	22.0	22.4	22.1	21.6	22.0	22.2
	256QAM	1	0	20.1	20.8	20.4	19.2	19.0	19.0	19.9	20.5	20.1	19.5	19.8	20.1
		1	1	20.5	20.5	20.3	19.3	19.6	19.0	19.6	<b>20.5</b>	20.1	19.4	19.9	19.9
		1	76	20.5	20.7	20.4	19.4	19.4	18.9	19.7	20.3	20.1	19.4	20.0	20.0
		1	77	20.2	<b>20.9</b>	20.3	19.2	<b>19.8</b>	19.0	20.0	20.4	20.1	19.5	20.2	20.1
		36	18	20.4	20.7	20.4	19.2	19.4	19.3	20.1	20.5	20.2	19.5	19.9	<b>20.2</b>
		75	0	20.4	20.6	20.5	19.3	19.4	19.2	20.1	20.3	20.2	19.6	20.0	20.2

**OUTPUT POWER FOR 5G NR n77 (40.0 MHz)**

Bandwidth (MHz)	Modulation	RB Allocation	RB Offset	Conducted Average (dBm)											
				ANT 6			ANT 7			ANT 1			ANT 5		
				648000	656000	664000	648000	656000	664000	648000	656000	664000	648000	656000	664000
40.0	BPSK	1	0	24.3	24.6	24.5	23.1	23.4	23.4	23.9	23.8	24.0	23.5	23.7	23.9
		1	1	24.8	24.9	25.0	23.8	23.8	23.9	24.3	24.2	24.6	24.0	24.2	24.4
		1	104	25.0	<b>25.3</b>	25.0	23.9	<b>24.1</b>	23.7	24.2	<b>24.6</b>	24.4	24.0	24.5	24.4
		1	105	24.5	24.8	24.3	23.4	23.7	23.3	23.7	24.0	23.9	23.7	24.0	24.2
		50	25	24.9	25.0	24.9	23.8	23.9	23.8	24.4	24.6	24.5	24.1	24.5	<b>24.6</b>
		100	0	24.4	24.6	24.4	23.2	23.5	23.3	23.8	23.9	23.9	23.5	24.0	24.1
	QPSK	1	0	23.8	24.0	23.9	22.9	22.7	23.0	23.3	23.5	23.1	23.2	23.5	
		1	1	24.9	25.0	24.9	23.7	23.7	23.9	24.2	24.4	24.5	24.0	24.3	24.6
		1	104	25.0	<b>25.3</b>	24.9	24.1	<b>24.1</b>	23.7	24.3	<b>24.5</b>	24.4	24.1	24.6	24.6
		1	105	24.0	24.3	24.0	22.9	23.1	22.8	23.2	23.6	23.4	23.0	23.5	23.7
		50	25	24.9	25.1	24.9	23.7	23.9	23.8	24.4	24.5	24.5	24.1	24.5	<b>24.7</b>
		100	0	23.9	24.2	23.9	22.7	22.9	22.7	23.3	23.4	23.5	23.1	23.5	23.7
	16QAM	1	0	23.0	23.3	22.8	21.7	21.8	21.9	22.2	22.3	22.5	21.9	22.1	22.8
		1	1	23.8	24.0	24.1	22.7	22.6	23.0	23.2	23.3	<b>23.6</b>	22.8	23.1	23.8
		1	104	24.0	24.1	23.7	<b>23.3</b>	23.0	22.7	23.0	<b>23.6</b>	23.1	22.8	23.4	<b>23.8</b>
		1	105	23.3	23.0	22.8	21.8	22.2	21.8	22.3	22.6	22.4	21.6	22.4	22.8
		50	25	23.9	<b>24.1</b>	24.0	22.7	22.9	22.8	23.2	23.4	23.5	23.1	23.6	23.7
		100	0	22.8	23.1	23.0	21.7	21.8	21.7	22.2	22.6	22.5	22.1	22.5	22.7
	64QAM	1	0	22.6	22.7	22.5	21.1	21.7	21.1	21.9	22.0	21.9	21.4	21.9	22.3
		1	1	22.7	22.4	22.6	21.3	21.2	21.2	21.8	21.5	<b>21.8</b>	21.5	21.8	22.1
		1	104	22.5	22.7	22.6	21.6	<b>22.0</b>	21.2	21.3	22.1	<b>22.1</b>	21.5	22.1	<b>22.4</b>
		1	105	<b>22.8</b>	22.7	22.7	21.6	21.6	20.8	21.7	22.1	21.7	21.4	22.1	22.2
		50	25	22.4	22.6	22.5	21.3	21.5	21.4	21.7	22.0	22.0	21.6	22.0	22.1
		100	0	22.4	22.6	22.5	21.2	21.4	21.2	21.9	22.0	22.0	21.5	22.0	22.2
	256QAM	1	0	20.2	20.8	20.3	19.4	19.4	19.5	19.6	19.9	20.0	19.6	19.9	20.1
		1	1	20.1	<b>20.8</b>	20.2	19.3	19.2	19.3	19.7	20.0	20.0	19.6	19.8	20.1
		1	104	20.5	20.7	20.2	19.6	19.5	19.4	19.8	<b>20.3</b>	19.8	19.6	20.1	<b>20.1</b>
		1	105	20.7	20.7	20.6	19.5	<b>19.7</b>	19.1	19.7	20.1	19.6	19.5	20.1	20.1
		50	25	20.4	20.6	20.4	19.1	19.6	19.3	19.7	20.0	19.9	19.6	20.0	20.1
		100	0	20.3	20.6	20.4	19.3	19.6	19.2	19.8	19.9	20.0	19.5	19.9	20.1



**OUTPUT POWER FOR 5G NR n77 (50.0 MHz)**

Bandwidth (MHz)	Modulation	RB Allocation	RB Offset	Conducted Average (dBm)											
				ANT 6			ANT 7			ANT 1			ANT 5		
				648333	656000	663666	648333	656000	663666	648333	656000	663666	648333	656000	663666
50.0	BPSK	1	0	24.4	24.6	24.6	23.4	23.3	23.4	23.8	23.7	24.0	23.6	23.7	24.0
		1	1	24.9	25.0	25.2	23.8	23.7	23.8	24.2	24.1	24.6	24.0	24.2	24.5
		1	131	25.2	25.3	25.1	24.0	24.1	23.8	24.4	24.6	24.4	24.0	24.5	24.5
		1	132	24.7	24.8	24.6	23.5	23.7	23.3	23.8	24.2	23.9	23.6	24.0	24.0
		64	32	25.0	25.2	24.9	23.8	24.0	23.8	24.3	24.5	24.5	24.0	24.5	24.7
		128	0	24.4	24.7	24.5	23.2	23.4	23.3	23.8	24.0	24.2	23.5	24.0	24.2
	QPSK	1	0	23.9	24.1	24.1	22.6	22.8	22.8	23.4	23.2	23.7	23.0	23.2	23.5
		1	1	24.9	24.9	25.0	23.7	23.7	23.8	24.5	24.2	24.6	24.0	24.3	24.5
		1	131	25.2	25.3	25.0	23.8	24.2	23.8	24.4	24.5	24.5	24.1	24.6	24.5
		1	132	24.2	24.3	24.0	22.9	23.1	22.9	23.2	23.6	23.4	23.1	23.5	23.5
		64	32	25.0	25.1	24.9	23.7	24.0	23.9	24.3	24.5	24.6	24.1	24.5	24.7
		128	0	24.0	24.1	24.0	22.8	22.9	22.8	23.3	23.5	23.5	23.0	23.5	23.6
	16QAM	1	0	22.9	23.1	23.0	21.6	21.9	21.7	22.3	22.0	22.4	22.1	22.2	22.5
		1	1	24.0	24.2	23.9	22.6	22.8	22.7	23.5	23.5	23.4	23.2	23.3	23.4
		1	131	24.2	24.4	23.9	22.9	23.1	22.6	23.3	23.4	23.5	23.2	23.5	23.5
		1	132	23.3	23.5	22.8	21.9	22.3	22.1	22.3	22.4	22.5	22.1	22.6	22.5
		64	32	24.0	24.2	24.1	22.6	22.9	22.9	23.2	23.5	23.5	23.1	23.5	23.7
		128	0	22.9	23.2	23.0	21.8	22.0	21.8	22.3	22.4	22.4	22.1	22.4	22.6
	64QAM	1	0	22.3	22.6	22.4	20.9	21.0	21.2	22.0	21.8	21.9	21.4	21.8	22.0
		1	1	22.6	22.7	22.5	21.0	21.2	21.2	22.1	21.5	22.1	21.4	21.9	21.9
		1	131	22.8	22.6	22.6	21.2	21.6	21.2	21.6	21.9	21.9	21.5	22.2	22.2
		1	132	22.8	22.8	22.4	21.1	21.6	21.0	21.6	22.1	22.0	21.5	22.2	22.0
		64	32	22.5	22.6	22.6	21.3	21.4	21.3	21.6	22.1	22.0	21.6	22.0	22.2
		128	0	22.4	22.6	22.5	21.3	21.4	21.3	21.7	21.9	21.9	21.5	22.0	22.1
	256QAM	1	0	20.3	20.9	20.4	19.0	19.3	19.6	19.6	19.8	20.4	19.6	20.1	19.8
		1	1	20.1	20.7	20.8	19.0	19.3	19.5	19.8	19.9	20.4	19.5	20.0	19.9
		1	131	20.7	20.8	20.4	19.3	19.7	19.4	19.7	20.3	20.2	19.6	20.4	20.1
		1	132	20.4	21.1	20.6	19.3	19.3	19.5	19.8	20.2	19.6	19.5	20.3	20.0
		64	32	20.5	20.7	20.4	19.2	19.5	19.3	19.8	20.0	20.0	19.5	19.9	20.2
		128	0	20.4	20.6	20.4	19.2	19.5	19.2	19.7	19.9	20.0	19.4	20.0	20.1

**OUTPUT POWER FOR 5G NR n77 (60.0 MHz)**

Bandwidth (MHz)	Modulation	RB Allocation	RB Offset	Conducted Average (dBm)											
				ANT 6			ANT 7			ANT 1			ANT 5		
				648666	656000	663333	648666	656000	663333	648666	656000	663333	648666	656000	663333
60.0	BPSK	1	0	24.3	24.4	24.6	23.3	23.1	23.3	23.8	23.6	24.1	23.4	23.6	23.7
		1	1	24.8	24.9	24.9	23.7	23.7	23.8	24.3	24.0	24.7	23.8	24.0	24.2
		1	160	25.2	25.3	25.1	24.1	24.2	23.9	24.2	24.6	24.4	23.9	24.5	24.4
		1	161	24.6	24.8	24.4	23.4	23.5	23.4	23.6	24.1	24.0	23.4	23.9	23.9
		81	40	25.0	25.1	24.8	23.8	24.0	23.8	24.2	24.5	24.6	24.0	24.4	24.5
		162	0	24.5	24.7	24.4	23.3	23.4	23.3	23.6	24.0	24.3	23.5	23.9	24.1
	QPSK	1	0	23.8	23.9	23.9	22.6	22.5	22.7	23.3	23.1	23.6	23.0	23.1	23.4
		1	1	24.8	24.9	24.9	23.8	23.8	23.6	24.3	24.0	24.6	23.9	24.1	24.4
		1	160	25.1	25.1	25.0	24.0	24.1	23.7	24.1	24.5	24.4	23.9	24.4	24.5
		1	161	24.2	24.3	24.0	23.0	23.0	22.7	23.1	23.5	23.5	22.9	23.4	23.6
		81	40	25.0	25.0	25.0	23.8	23.9	23.8	24.3	24.4	24.6	23.9	24.4	24.7
		162	0	24.0	24.0	23.9	22.8	23.0	22.8	23.2	23.4	23.7	22.9	23.4	23.7
	16QAM	1	0	22.9	23.1	23.2	21.7	21.5	21.7	22.4	22.0	22.5	21.8	22.1	22.3
		1	1	23.9	23.8	24.1	22.7	22.6	22.6	23.3	23.1	23.6	22.9	23.1	23.3
		1	160	24.3	24.2	24.2	22.6	23.0	22.6	23.3	23.7	23.7	22.9	23.5	23.5
		1	161	22.9	23.3	22.7	21.7	22.2	21.7	22.3	22.4	22.8	21.8	22.4	22.5
		81	40	24.0	24.1	24.1	22.8	23.0	22.8	23.3	23.5	23.7	23.0	23.4	23.5
		162	0	22.9	23.1	23.0	21.8	22.0	21.8	22.2	22.4	22.6	21.9	22.4	22.6
	64QAM	1	0	22.1	22.4	22.7	21.4	21.0	21.1	21.8	21.5	22.4	21.4	21.6	21.7
		1	1	22.2	22.6	22.8	21.3	21.0	21.2	21.7	21.5	22.7	21.4	21.5	21.7
		1	160	22.5	23.0	22.7	21.3	21.5	21.0	21.4	22.1	22.0	21.4	21.7	21.9
		1	161	22.7	22.9	22.6	21.6	21.5	21.2	21.7	22.0	21.9	21.3	21.8	21.8
		81	40	22.4	22.5	22.4	21.2	21.4	21.2	21.6	21.9	22.0	21.4	21.9	22.1
		162	0	22.3	22.5	22.5	21.3	21.4	21.3	21.7	21.9	22.2	21.5	21.9	22.0
	256QAM	1	0	20.4	20.2	20.5	19.4	19.4	19.0	19.5	19.6	20.6	19.5	19.7	19.8
		1	1	20.4	20.6	20.4	19.2	19.2	19.3	19.6	19.4	20.1	19.5	19.7	19.8
		1	160	20.6	20.5	20.7	19.8	19.8	19.4	19.7	19.9	19.9	19.4	20.0	19.9
		1	161	20.9	20.7	20.7	19.7	19.8	19.4	19.6	20.2	19.8	19.4	20.1	19.8
		81	40	20.5	20.7	20.4	19.3	19.6	19.3	19.8	19.9	20.1	19.4	19.9	20.1
		162	0	20.5	20.7	20.5	19.3	19.5	19.2	19.8	19.9	20.1	19.4	19.9	20.0

**OUTPUT POWER FOR 5G NR n77 (70.0 MHz)**

Bandwidth (MHz)	Modulation	RB Allocation	RB Offset	Conducted Average (dBm)											
				ANT 6			ANT 7			ANT 1			ANT 5		
				649000	656000	663000	649000	656000	663000	649000	656000	663000	649000	656000	663000
70.0	BPSK	1	0	24.4	24.7	24.5	23.2	23.1	23.0	24.4	24.0	24.2	23.4	23.5	23.7
		1	1	24.9	25.0	24.9	23.7	23.7	23.7	24.6	24.5	24.7	24.0	24.1	24.2
		1	187	25.2	25.2	25.3	23.9	24.2	23.8	24.6	24.9	24.5	23.9	24.4	24.4
		1	188	24.7	24.7	24.6	23.4	23.5	23.4	24.1	24.4	24.1	23.4	23.8	23.8
		90	45	25.0	25.0	25.0	23.8	23.9	23.9	24.6	24.9	24.8	24.1	24.5	24.5
		180	0	24.6	24.7	24.5	23.3	23.4	23.2	24.1	24.2	24.1	23.5	23.9	24.0
	QPSK	1	0	23.9	23.9	24.1	22.7	22.7	22.6	23.7	23.6	23.6	22.9	23.1	23.3
		1	1	24.8	25.0	24.9	23.8	23.8	23.5	24.6	24.4	24.7	23.9	24.1	24.3
		1	187	25.1	25.2	25.0	24.0	24.1	23.8	24.5	24.9	24.6	23.9	24.5	24.4
		1	188	24.2	24.1	24.0	22.9	23.0	22.8	23.6	23.9	23.6	23.0	23.4	23.4
		90	45	25.0	25.0	25.0	23.7	24.0	23.7	24.6	24.7	24.8	23.9	24.5	24.5
		180	0	24.0	23.9	23.9	22.8	22.9	22.7	23.6	23.8	23.8	23.0	23.4	23.4
	16QAM	1	0	23.3	22.6	22.9	21.7	21.8	21.5	23.1	22.2	22.7	22.0	22.3	22.1
		1	1	24.1	23.9	24.0	22.7	23.0	22.6	24.0	23.5	23.5	23.1	23.3	23.2
		1	187	24.1	23.8	23.9	23.1	23.2	22.9	23.8	23.8	23.6	23.1	23.6	23.3
		1	188	23.3	23.0	23.5	21.9	22.1	21.7	22.9	22.9	22.4	22.1	22.5	22.5
		90	45	24.0	24.0	24.0	22.7	22.9	22.8	23.6	23.7	23.8	23.1	23.4	23.5
		180	0	22.9	23.1	23.0	21.8	21.9	21.7	22.6	22.7	22.8	21.9	22.4	22.4
	64QAM	1	0	22.5	22.5	22.6	21.0	21.1	21.3	22.2	21.9	22.2	21.6	21.5	21.7
		1	1	22.5	22.5	22.4	21.0	21.1	21.3	22.5	22.0	22.4	21.7	21.6	21.7
		1	187	22.8	22.5	22.7	21.5	21.5	21.6	22.4	22.4	21.8	21.7	21.9	21.9
		1	188	22.9	23.0	22.5	21.3	21.4	21.5	22.3	22.4	22.3	21.7	21.9	21.9
		90	45	22.5	22.5	22.5	21.2	21.4	21.2	22.1	22.2	22.3	21.5	21.9	22.0
		180	0	22.5	22.6	22.5	21.3	21.4	21.3	21.9	22.3	22.2	21.5	22.0	22.0
	256QAM	1	0	20.4	20.4	20.6	19.6	19.1	19.2	20.3	20.1	20.0	19.8	19.8	19.8
		1	1	20.2	20.2	20.4	19.3	19.1	19.2	20.4	19.9	20.1	19.8	19.6	19.8
		1	187	20.6	20.4	20.8	19.8	19.5	19.4	20.4	20.7	20.2	19.7	20.0	20.0
		1	188	20.7	20.5	20.8	19.6	19.4	19.5	20.1	20.5	19.9	19.6	20.0	19.9
		90	45	20.5	20.6	20.4	19.3	19.4	19.3	20.0	20.2	20.3	19.4	19.9	20.1
		180	0	20.5	20.5	20.5	19.4	19.4	19.3	20.0	20.3	20.3	19.5	19.9	20.0

**OUTPUT POWER FOR 5G NR n77 (80.0 MHz)**

Bandwidth (MHz)	Modulation	RB Allocation	RB Offset	Conducted Average (dBm)											
				ANT 6			ANT 7			ANT 1			ANT 5		
				649333	656000	662666	649333	656000	662666	649333	656000	662666	649333	656000	662666
80.0	BPSK	1	0	24.5	24.7	24.6	23.3	23.3	23.4	24.0	23.9	24.2	23.4	23.6	23.8
		1	1	25.0	25.0	25.2	23.8	23.9	23.9	24.5	24.5	24.6	24.0	24.2	24.4
		1	215	25.1	25.2	25.2	24.0	24.0	23.9	24.5	24.8	24.5	24.0	24.4	24.5
		1	216	24.8	24.7	24.6	23.5	23.5	23.5	24.1	24.4	24.0	23.6	23.9	23.9
		108	54	24.9	25.1	24.9	23.8	24.0	23.8	24.3	24.8	24.6	24.1	24.4	24.6
		216	0	24.4	24.7	24.5	23.3	23.3	23.4	24.1	24.3	24.1	23.6	23.8	24.1
	QPSK	1	0	23.8	24.2	24.2	22.7	22.9	22.8	23.4	23.4	23.7	23.0	23.1	23.3
		1	1	25.0	25.1	25.2	23.8	23.9	23.8	24.5	24.5	24.7	24.1	24.1	24.4
		1	215	25.1	25.2	25.3	23.9	24.0	24.0	24.5	25.0	24.4	24.2	24.4	24.5
		1	216	24.2	24.1	24.2	23.0	23.0	22.9	23.6	23.9	23.5	23.0	23.4	23.5
		108	54	25.0	25.0	24.9	23.8	23.8	23.7	24.6	24.9	24.7	24.0	24.4	24.4
		216	0	23.9	24.0	24.0	22.8	22.9	22.7	23.5	23.9	23.7	22.9	23.4	23.6
	16QAM	1	0	23.0	23.2	23.2	21.6	21.8	21.8	22.6	22.4	22.4	22.0	22.1	22.2
		1	1	23.7	23.9	23.9	22.4	22.9	22.7	23.6	23.4	23.5	23.0	23.1	23.3
		1	215	24.2	24.0	24.3	22.9	23.1	22.9	23.7	23.9	23.2	23.1	23.4	23.3
		1	216	22.9	23.4	23.2	22.0	22.0	21.9	22.7	22.8	22.3	22.0	22.4	22.4
		108	54	24.0	24.1	24.0	22.8	22.9	22.8	23.5	23.8	23.5	23.1	23.4	23.4
		216	0	23.0	23.2	22.9	21.7	21.9	21.8	22.5	22.9	22.6	22.0	22.4	22.5
	64QAM	1	0	22.1	22.7	22.5	21.2	21.5	21.3	22.3	21.7	22.3	21.4	21.8	21.7
		1	1	22.3	22.6	22.6	21.5	21.2	21.2	21.8	21.9	22.3	21.4	21.9	21.9
		1	215	22.5	22.6	22.5	21.4	21.7	21.6	22.4	22.3	22.2	21.4	22.1	22.0
		1	216	22.5	22.6	22.7	21.4	21.4	21.5	22.3	22.5	22.0	21.3	22.2	21.8
		108	54	22.6	22.6	22.5	21.3	21.5	21.3	21.9	22.3	22.3	21.6	21.9	21.9
		216	0	22.4	22.5	22.5	21.3	21.3	21.3	22.1	22.3	22.2	21.6	21.9	21.9
	256QAM	1	0	20.8	20.6	20.4	19.2	19.5	19.1	20.0	20.1	20.1	19.4	19.4	19.5
		1	1	20.4	20.6	20.9	19.1	19.3	19.3	20.3	20.0	20.1	19.5	19.6	19.6
		1	215	20.8	20.8	20.9	19.5	19.8	19.2	20.0	20.4	19.8	19.4	19.8	19.8
		1	216	20.9	20.9	21.0	19.5	19.6	19.1	20.1	20.5	19.7	19.4	19.8	19.8
		108	54	20.5	20.5	20.4	19.3	19.4	19.3	20.0	20.3	20.1	19.5	19.8	20.0
		216	0	20.6	20.6	20.4	19.2	19.5	19.3	20.0	20.3	20.2	19.4	19.9	19.9



**OUTPUT POWER FOR 5G NR n77 (90.0 MHz)**

Bandwidth (MHz)	Modulation	RB Allocation	RB Offset	Conducted Average (dBm)											
				ANT 6			ANT 7			ANT 1			ANT 5		
				649666	656000	662333	649666	656000	662333	649666	656000	662333	649666	656000	662333
90.0	BPSK	1	0	24.4	24.5	24.6	23.3	23.2	23.3	24.1	23.8	24.2	23.5	23.6	23.7
		1	1	25.0	25.2	25.2	23.9	23.9	23.8	24.6	24.5	24.9	24.1	24.2	24.3
		1	243	25.2	25.2	25.4	23.9	23.9	24.0	24.5	24.9	24.5	24.3	24.5	24.4
		1	244	24.6	24.7	24.7	23.4	23.5	23.4	24.1	24.3	23.8	23.6	23.8	23.8
		120	60	25.0	25.2	24.9	23.9	23.9	23.7	24.5	24.8	24.6	24.1	24.4	24.4
		243	0	24.4	24.7	24.5	23.2	23.4	23.3	23.9	24.4	24.2	23.6	23.9	23.9
	QPSK	1	0	24.0	23.9	24.1	22.7	22.8	22.8	23.4	23.2	23.7	22.9	23.0	23.2
		1	1	24.8	25.1	25.0	23.8	23.8	23.8	24.6	24.5	24.9	24.1	24.1	24.3
		1	243	25.1	25.2	25.3	23.8	24.0	23.9	24.6	24.9	24.3	24.1	24.4	24.4
		1	244	24.1	24.2	24.1	22.8	22.9	22.8	23.4	23.8	23.3	23.1	23.3	23.3
		120	60	25.0	25.1	24.9	23.7	23.9	23.7	24.5	24.7	24.6	24.1	24.5	24.4
		243	0	23.9	24.1	24.0	22.8	22.9	22.7	23.5	23.7	23.7	23.1	23.4	23.4
	16QAM	1	0	22.7	23.1	23.1	21.2	21.8	21.7	22.4	22.2	22.7	22.0	22.1	22.3
		1	1	23.9	24.1	24.0	22.4	23.0	22.8	23.2	23.2	23.6	23.1	23.2	23.4
		1	243	24.0	24.1	24.1	22.6	23.1	22.9	23.6	23.7	23.4	23.2	23.5	23.5
		1	244	23.1	22.8	23.2	21.5	22.0	22.1	22.8	22.8	22.5	22.0	22.4	22.3
		120	60	24.0	24.1	23.9	22.7	23.0	22.7	23.6	23.7	23.7	23.1	23.4	23.5
		243	0	23.0	23.2	22.9	21.8	21.9	21.8	22.5	22.8	22.7	22.0	22.4	22.4
	64QAM	1	0	22.6	22.5	22.6	21.0	21.3	21.5	22.0	22.0	22.2	21.6	21.4	21.7
		1	1	22.7	22.6	23.2	21.3	21.3	21.5	22.2	22.0	22.3	21.7	21.3	21.8
		1	243	22.9	22.8	22.6	21.3	21.5	21.4	21.8	22.6	22.0	21.7	21.6	21.9
		1	244	22.8	22.9	22.9	21.1	21.3	21.2	21.6	22.3	21.8	21.6	21.6	21.8
		120	60	22.5	22.6	22.4	21.2	21.5	21.2	22.2	22.3	22.1	21.5	21.9	21.9
		243	0	22.5	22.6	22.4	21.3	21.4	21.2	22.0	22.3	22.1	21.5	22.0	21.9
	256QAM	1	0	20.3	20.9	20.1	19.4	19.0	19.4	19.8	19.6	20.2	19.5	19.5	19.8
		1	1	20.6	21.1	20.5	19.4	19.3	19.4	20.1	19.6	20.4	19.6	19.6	19.9
		1	243	20.5	20.5	20.8	19.3	19.3	19.6	20.3	20.1	20.0	19.7	19.9	20.0
		1	244	20.6	20.3	20.8	19.3	19.4	19.5	20.0	20.4	19.9	19.6	19.9	19.8
		120	60	20.5	20.7	20.4	19.3	19.5	19.1	20.1	20.4	20.1	19.5	19.9	20.0
		243	0	20.4	20.6	20.4	19.3	19.4	19.3	20.0	20.4	20.1	19.5	19.9	19.9

**OUTPUT POWER FOR 5G NR n77 (100.0 MHz)**

Bandwidth (MHz)	Modulation	RB Allocation	RB Offset	Conducted Average (dBm)											
				ANT 6			ANT 7			ANT 1			ANT 5		
				650000	656000	662000	650000	656000	662000	650000	656000	662000	650000	656000	662000
100.0	BPSK	1	0	24.3	24.4	24.5	23.2	23.2	23.4	23.9	23.8	24.2	23.4	23.5	23.8
		1	1	25.0	25.0	25.1	23.8	23.9	24.1	24.5	24.5	24.9	24.1	24.1	24.3
		1	271	25.2	25.1	25.1	24.0	24.0	24.1	24.5	24.7	24.3	24.3	24.4	24.5
		1	272	24.5	24.6	24.5	23.4	23.4	23.4	23.9	24.2	23.8	23.6	23.8	23.8
		135	67	25.0	25.1	24.7	23.8	23.9	23.7	24.4	24.8	24.6	24.0	24.5	24.4
		270	0	24.3	24.5	24.5	23.2	23.4	23.3	24.0	24.2	24.3	23.5	23.9	24.0
	QPSK	1	0	23.8	23.9	24.0	22.6	22.7	22.8	23.4	23.2	23.6	22.9	22.9	23.2
		1	1	24.9	25.3	25.2	23.9	23.9	24.1	24.5	24.5	24.9	24.1	24.1	24.5
		1	271	25.1	25.2	25.2	24.0	23.9	23.9	24.5	25.0	24.3	24.3	24.4	24.6
		1	272	24.1	24.0	24.0	22.9	22.8	22.8	23.4	23.6	23.1	23.1	23.2	23.3
		135	67	25.0	25.0	24.8	23.7	23.9	23.6	24.5	24.9	24.6	24.1	24.5	24.4
		270	0	23.8	24.1	23.8	22.7	23.0	22.8	23.6	23.8	23.7	23.0	23.4	23.5
	16QAM	1	0	22.7	23.0	23.3	21.6	21.6	22.0	22.3	22.5	22.5	21.9	22.0	22.2
		1	1	23.9	24.4	24.4	22.6	22.9	22.9	23.3	23.3	23.8	23.1	23.1	23.4
		1	271	24.0	24.4	24.3	22.9	23.1	22.9	23.4	23.8	23.1	23.2	23.4	23.4
		1	272	22.8	23.3	23.2	21.7	22.0	21.8	22.3	22.7	22.1	22.1	22.2	22.3
		135	67	23.9	24.1	23.7	22.7	22.9	22.6	23.5	23.9	23.6	23.1	23.4	23.4
		270	0	22.9	23.1	22.8	21.8	21.9	21.7	22.4	22.8	22.7	22.0	22.3	22.5
	64QAM	1	0	22.4	22.2	22.3	21.2	21.5	21.1	21.9	21.9	22.3	21.2	21.3	21.7
		1	1	22.4	22.5	22.5	21.2	21.3	21.2	22.1	22.0	22.6	21.4	21.4	21.9
		1	271	22.9	22.5	22.7	21.5	21.4	21.2	21.9	22.2	22.1	21.5	21.8	22.0
		1	272	22.4	22.5	22.4	21.4	21.3	21.0	21.9	22.0	21.9	21.4	21.6	21.7
		135	67	22.4	22.6	22.3	21.3	21.4	21.2	22.0	22.3	22.0	21.5	21.9	21.9
		270	0	22.3	22.5	22.4	21.2	21.5	21.2	21.9	22.4	22.1	21.5	22.0	22.0
	256QAM	1	0	19.9	20.5	20.7	19.1	19.4	19.4	19.8	19.8	20.2	19.4	19.4	19.6
		1	1	20.7	20.8	20.8	19.1	19.6	19.5	20.2	20.0	20.4	19.6	19.6	19.8
		1	271	21.0	20.7	20.5	19.5	19.6	19.5	20.0	20.3	20.0	19.7	19.9	19.9
		1	272	20.8	20.7	20.2	19.3	19.4	19.4	19.8	19.9	19.7	19.5	19.7	19.7
		135	67	20.3	20.5	20.2	19.2	19.4	19.2	20.0	20.2	20.0	19.5	19.9	19.9
		270	0	20.4	20.6	20.4	19.2	19.5	19.3	20.0	20.4	20.1	19.5	19.9	19.9

### 8.20. 5G NR n77 (Part 27 3700-3980MHz) HPUE

Test Engineer ID:	32934IG and 28498AC	Test Date:	2024-03-11 to 2024-03-28
-------------------	---------------------	------------	--------------------------

#### OUTPUT POWER FOR 5G NR n77 (10.0 MHz)

Bandwidth (MHz)	Modulation	RB Allocation	RB Offset	Conducted Average (dBm)											
				ANT 6			ANT 7			ANT 1			ANT 5		
				647000 3705.0	656000 3840.0	665000 3975.0	647000 3705.0	656000 3840.0	665000 3975.0	647000 3705.0	656000 3840.0	665000 3975.0	647000 3705.0	656000 3840.0	665000 3975.0
10.0	BPSK	1	0	23.8	24.1	24.0	22.3	22.5	22.4	22.3	22.6	22.8	21.5	21.9	22.0
		1	1	25.9	26.1	26.1	25.8	26.0	25.9	25.7	26.0	26.1	25.1	25.5	25.5
		1	22	26.0	26.2	25.9	25.6	26.0	25.7	26.2	26.1	24.9	25.6	25.6	
		1	23	23.9	24.1	24.0	22.1	22.4	22.3	22.2	22.6	22.7	21.3	22.0	22.0
		12	6	25.8	26.2	26.0	25.7	25.9	25.8	25.8	26.1	26.2	25.0	25.4	25.6
		24	0	25.8	26.1	26.0	24.2	24.3	24.3	25.2	25.6	25.7	24.5	25.0	25.1
	QPSK	1	0	23.3	23.5	23.6	22.2	22.4	22.0	22.2	22.6	22.6	21.4	21.9	21.9
		1	1	25.8	26.1	26.1	25.7	25.9	25.6	25.6	26.0	26.1	24.9	25.6	25.4
		1	22	26.0	26.2	26.1	25.6	26.0	25.9	25.7	26.2	25.1	24.9	25.6	25.5
		1	23	23.4	23.7	23.4	22.1	22.4	22.4	22.3	22.4	22.7	21.4	22.1	22.0
		12	6	25.9	26.2	26.1	25.7	25.9	25.8	25.8	26.0	26.2	24.9	25.4	25.5
		24	0	25.9	26.1	26.1	23.7	23.8	23.8	24.8	25.0	25.2	24.0	24.5	24.6
	16QAM	1	0	22.2	22.6	22.7	22.2	22.2	22.5	22.3	22.7	22.8	21.7	21.9	22.0
		1	1	24.8	25.2	25.1	24.8	24.7	24.8	25.0	25.1	25.2	24.2	24.7	24.7
		1	22	25.1	25.1	24.9	24.6	24.6	25.1	24.9	25.2	25.4	23.8	24.7	24.7
		1	23	22.3	22.8	22.4	22.4	22.1	22.4	22.5	22.7	22.8	21.6	22.1	22.0
		12	6	24.8	25.1	25.0	24.8	24.8	24.8	24.7	25.1	25.1	23.9	24.4	24.6
		24	0	24.9	25.2	25.0	22.7	22.8	22.8	23.7	24.0	24.2	22.9	23.5	23.5
	64QAM	1	0	22.5	22.6	22.5	22.2	22.0	22.3	22.2	22.5	22.5	21.2	22.2	21.6
		1	1	25.0	25.1	25.0	23.1	23.4	23.6	23.2	23.6	23.3	22.4	23.0	22.6
		1	22	24.9	25.0	25.0	23.2	23.1	23.4	23.2	23.6	23.5	22.6	22.8	23.1
		1	23	22.6	22.8	22.5	22.1	22.5	22.7	22.2	22.5	22.5	21.4	21.8	21.6
		12	6	24.9	25.0	25.1	23.2	23.3	23.3	23.2	23.6	23.7	22.4	23.0	23.1
		24	0	24.9	25.1	25.0	22.2	22.3	22.3	23.2	23.5	23.7	22.4	23.0	23.1
256QAM	1	0	22.1	22.4	22.7	21.3	21.3	21.0	21.3	21.6	21.8	20.4	20.8	21.1	
	1	1	22.4	22.3	22.3	21.1	21.5	21.2	21.3	21.6	22.0	20.3	20.9	21.1	
	1	22	22.3	22.4	22.4	21.6	21.8	20.9	21.3	21.7	22.0	20.9	21.0	21.3	
	1	23	22.3	22.5	22.6	21.3	21.6	20.9	21.4	21.7	21.8	20.5	21.0	21.3	
	12	6	22.3	22.6	22.5	21.1	21.3	21.3	21.2	21.5	21.6	20.4	21.0	21.1	
	24	0	22.4	22.7	22.5	21.1	21.3	21.3	21.2	21.5	21.7	20.5	20.9	21.0	

#### OUTPUT POWER FOR 5G NR n77 (15.0 MHz)

Bandwidth (MHz)	Modulation	RB Allocation	RB Offset	Conducted Average (dBm)											
				ANT 6			ANT 7			ANT 1			ANT 5		
				647166 3707.5	656000 3840.0	664833 3972.5	647166 3707.5	656000 3840.0	664833 3972.5	647166 3707.5	656000 3840.0	664833 3972.5	647166 3707.5	656000 3840.0	664833 3972.5
15.0	BPSK	1	0	23.7	24.1	24.0	22.3	22.3	22.1	22.4	22.4	22.5	21.5	21.8	21.8
		1	1	25.9	26.1	26.2	25.9	25.8	25.6	25.9	26.0	26.0	25.1	25.4	25.4
		1	36	26.1	26.3	26.0	25.8	25.9	25.8	26.1	26.2	25.0	25.4	25.5	
		1	37	24.0	24.2	24.0	22.2	22.4	22.3	22.6	22.7	21.4	22.0	22.1	
		18	9	26.0	26.2	26.0	25.7	25.8	25.7	25.8	26.0	26.2	25.0	25.4	25.5
		36	0	25.9	26.2	26.1	24.2	24.3	24.2	25.3	25.5	25.7	24.4	24.9	25.0
	QPSK	1	0	23.4	23.6	23.6	22.3	22.1	22.0	22.4	22.3	22.3	21.3	21.7	21.8
		1	1	25.9	26.1	26.1	25.7	25.6	25.7	25.9	25.8	25.8	25.1	25.2	25.5
		1	36	26.0	26.2	26.0	25.8	25.8	25.8	25.9	26.2	26.2	25.2	25.3	25.6
		1	37	23.5	23.7	23.4	22.2	22.2	22.3	22.5	22.5	22.8	21.5	21.8	22.0
		18	9	25.8	26.2	26.1	25.7	25.8	25.8	25.8	26.0	26.1	24.9	25.4	25.5
		36	0	25.9	26.3	26.1	23.7	23.8	23.7	24.8	25.0	25.2	24.0	24.5	24.5
	16QAM	1	0	22.2	22.8	22.5	22.1	22.2	22.1	22.2	22.4	22.7	21.4	21.9	22.0
		1	1	24.8	25.1	25.1	24.5	24.6	24.4	24.7	24.9	25.0	23.9	24.4	24.5
		1	36	25.0	25.2	24.9	24.6	24.8	24.7	24.7	25.0	25.2	23.9	24.5	24.5
		1	37	22.3	22.7	22.6	22.0	22.3	22.2	22.2	22.6	22.5	21.4	21.9	21.9
		18	9	24.9	25.2	25.0	24.7	24.9	24.7	24.8	25.0	25.1	23.9	24.4	24.6
		36	0	24.9	25.1	25.0	22.8	22.8	22.8	23.8	24.1	24.2	23.0	23.4	23.5
	64QAM	1	0	22.4	22.7	22.6	22.3	22.4	22.1	22.4	22.3	22.5	21.6	21.8	21.8
		1	1	25.0	25.0	25.1	23.3	23.4	23.0	23.4	23.3	23.4	22.6	22.7	22.8
		1	36	25.0	25.1	24.8	23.4	23.5	23.2	23.4	23.5	23.5	22.5	22.8	22.9
		1	37	22.7	22.5	22.7	22.3	22.5	22.2	21.9	22.4	22.5	21.7	21.9	22.1
		18	9	24.9	25.1	25.0	23.2	23.4	23.2	23.3	23.0	23.6	22.3	22.9	23.0
		36	0	24.9	25.1	25.0	22.2	22.3	22.2	23.3	23.5	23.6	22.4	22.9	23.0
256QAM	1	0	22.5	22.4	22.7	20.9	21.2	21.0	21.4	21.4	21.5	20.7	21.0	21.0	
	1	1	22.6	22.9	22.8	20.9	21.2	21.0	21.4	21.3	21.9	20.6	21.0	21.0	
	1	36	22.6	22.7	22.6	20.8	21.3	21.1	21.4	21.5	22.0	20.6	21.1	21.0	
	1	37	22.7	22.6	22.7	20.8	21.3	21.2	21.3	21.5	22.0	20.6	21.1	21.1	
	18	9	22.3	22.6	22.4	21.2	21.3	21.2	21.5	21.7	21.8	20.5	20.9	21.1	
	36	0	22.4	22.6	22.5	21.1	21.3	21.3	21.2	21.5	21.7	20.3	20.9	21.0	

**OUTPUT POWER FOR 5G NR n77 (20.0 MHz)**

Bandwidth (MHz)	Modulation	RB Allocation	RB Offset	Conducted Average (dBm)											
				ANT 6			ANT 7			ANT 1			ANT 5		
				647333	656000	664666	647333	656000	664666	647333	656000	664666	647333	656000	664666
20.0	BPSK	1	0	23.8	24.1	24.1	22.2	22.3	22.2	22.3	22.4	22.6	21.4	21.8	21.9
		1	1	25.8	26.0	26.0	25.7	<b>25.9</b>	25.7	25.8	25.9	<b>26.2</b>	24.9	25.3	<b>25.6</b>
		1	49	26.0	26.1	26.0	25.6	<b>25.9</b>	25.8	25.7	26.1	<b>26.2</b>	25.0	25.4	25.6
		1	50	24.1	24.3	24.0	22.1	22.3	22.3	22.2	22.6	22.7	21.3	21.9	22.0
		25	12	26.0	26.1	26.1	25.7	25.8	25.7	25.8	26.0	26.1	25.0	25.4	25.5
	QPSK	1	0	23.2	23.6	23.6	22.2	22.2	22.2	22.3	22.4	22.4	21.4	21.7	22.0
		1	1	25.8	26.0	26.0	25.7	25.7	25.6	25.8	25.9	26.0	24.9	25.3	25.5
		1	49	26.0	26.1	26.0	25.7	25.9	<b>25.9</b>	25.8	26.0	26.1	24.9	25.4	<b>25.5</b>
		1	50	23.6	23.7	23.5	22.1	22.4	22.4	22.2	22.5	22.6	21.5	22.0	22.1
		25	12	26.1	26.2	26.0	25.7	25.9	25.7	25.8	26.0	<b>26.1</b>	24.9	25.4	25.5
	16QAM	1	0	22.3	22.6	22.4	22.1	22.4	21.9	22.2	22.3	22.7	21.3	21.8	22.2
		1	1	25.0	25.0	25.1	24.6	24.7	24.5	24.6	24.8	25.1	23.8	24.0	24.7
		1	49	24.9	<b>25.1</b>	25.1	24.7	<b>25.0</b>	24.7	24.6	25.0	<b>25.3</b>	23.9	24.6	<b>24.7</b>
		1	50	22.6	22.7	22.6	22.1	22.5	22.3	22.2	22.6	22.8	21.4	22.0	22.2
		25	12	24.9	25.1	25.0	24.7	24.9	24.7	24.8	25.0	25.1	23.9	24.3	24.5
	64QAM	1	0	22.2	22.5	22.8	22.3	22.5	22.1	22.2	22.3	22.4	21.4	21.5	22.1
		1	1	24.6	25.0	25.0	23.3	23.4	23.1	23.3	23.4	23.3	22.3	22.8	23.0
		1	49	25.1	<b>25.1</b>	25.0	<b>23.4</b>	23.4	23.3	23.3	23.6	23.4	22.3	22.9	22.9
		1	50	22.4	23.0	22.8	22.2	22.4	22.4	22.2	22.6	22.5	21.4	21.9	22.0
		25	12	25.1	25.1	25.0	23.1	23.4	23.2	23.2	23.5	<b>23.7</b>	22.4	22.9	<b>23.1</b>
	256QAM	1	0	22.3	22.9	22.7	21.2	21.3	21.2	21.3	21.3	21.3	21.9	20.2	<b>21.3</b>
		1	1	22.2	22.9	22.5	21.2	21.3	21.2	21.3	21.2	21.7	20.3	20.7	21.3
		1	49	22.4	<b>23.2</b>	22.6	21.2	21.4	21.4	21.3	21.4	21.9	20.3	20.9	21.1
		1	50	22.4	23.1	22.4	21.2	21.4	<b>21.4</b>	21.3	21.4	<b>21.9</b>	20.4	20.9	21.1
		25	12	22.5	22.6	22.5	21.1	21.3	21.2	21.2	21.5	21.6	20.4	20.9	21.0
	50	0	22.5	22.6	22.5	21.2	21.3	21.2	21.2	21.5	21.5	20.4	20.9	20.9	

**OUTPUT POWER FOR 5G NR n77 (25.0 MHz)**

Bandwidth (MHz)	Modulation	RB Allocation	RB Offset	Conducted Average (dBm)											
				ANT 6			ANT 7			ANT 1			ANT 5		
				647500	656000	664500	647500	656000	664500	647500	656000	664500	647500	656000	664500
25.0	BPSK	1	0	23.7	24.0	24.0	22.1	22.2	22.1	22.2	22.3	22.5	21.3	21.7	21.8
		1	1	25.7	25.9	25.9	25.6	25.7	25.6	25.7	25.8	26.0	24.8	25.2	25.3
		1	63	25.9	<b>26.1</b>	25.9	25.5	<b>25.8</b>	25.7	25.6	<b>26.1</b>	26.0	24.9	25.3	<b>25.5</b>
		1	64	24.0	24.2	23.9	22.0	22.2	22.2	22.1	22.5	22.6	21.2	21.8	21.9
		32	16	25.9	26.0	26.0	25.6	25.7	25.6	25.7	25.9	26.0	24.9	25.3	25.4
	QPSK	64	0	25.8	26.0	26.0	24.1	24.2	24.1	25.2	25.4	25.5	24.3	24.8	24.9
		1	0	23.1	23.5	23.5	22.1	22.1	22.1	22.2	22.3	22.3	21.3	21.6	21.9
		1	1	25.7	25.9	25.9	25.6	25.6	25.5	25.7	25.8	25.9	24.8	25.2	25.4
		1	49	25.9	26.0	25.9	25.6	25.7	25.7	25.7	25.9	26.0	24.8	25.3	<b>25.4</b>
		1	50	23.5	23.6	23.4	22.0	22.3	22.3	22.1	22.4	22.5	21.4	21.9	22.0
	16QAM	25	12	26.0	<b>26.1</b>	25.9	25.6	<b>25.8</b>	25.6	25.7	<b>26.0</b>	25.7	24.8	25.3	25.4
		50	0	25.9	26.0	25.9	23.6	23.7	23.6	24.7	24.9	25.0	23.9	24.3	24.4
		1	0	22.2	22.5	22.3	22.0	22.3	21.8	22.1	22.2	22.6	21.2	21.7	22.1
		1	1	24.9	24.9	25.0	24.5	24.6	24.4	24.5	24.7	25.0	23.7	23.9	<b>24.6</b>
		1	49	24.8	24.9	25.0	24.6	24.7	24.6	24.5	24.9	24.9	23.8	24.5	24.5
	64QAM	1	50	22.5	22.6	22.5	22.0	22.4	22.2	22.1	22.5	<b>22.7</b>	21.3	21.9	22.1
		25	12	24.8	25.0	24.9	24.6	<b>24.8</b>	24.6	24.7	24.9	<b>25.0</b>	23.8	24.2	24.4
		50	0	24.9	<b>25.0</b>	24.9	22.6	22.7	22.6	23.7	23.9	24.0	22.8	23.3	23.4
		1	0	22.1	22.4	22.7	22.2	22.4	22.0	22.1	22.2	22.3	21.3	21.4	22.0
		1	1	24.5	24.9	24.9	23.2	<b>23.3</b>	23.0	23.2	23.3	23.2	22.2	22.7	22.9
	256QAM	1	49	25.0	24.9	24.9	23.2	23.3	23.2	23.2	23.5	23.3	22.2	22.8	22.8
		1	50	22.3	22.9	22.7	22.1	22.3	22.3	22.1	22.5	22.4	21.3	21.8	21.9
		25	12	<b>25.0</b>	25.0	24.9	23.0	23.3	23.1	23.1	23.4	<b>23.6</b>	22.3	22.8	<b>23.0</b>
		50	0	24.9	24.8	24.9	22.1	22.2	22.1	23.2	23.4	23.4	22.3	22.8	22.9
		1	0	22.2	22.8	22.6	21.1	21.2	21.1	21.2	21.2	21.8	20.1	20.5	<b>21.2</b>
	256QAM	1	1	22.1	22.8	22.4	21.1	21.2	21.1	21.2	21.1	21.6	20.2	20.6	21.2
		1	49	22.3	22.9	22.5	21.1	21.3	21.3	21.2	21.3	21.8	20.2	20.8	21.0
		1	50	22.3	<b>23.0</b>	22.3	21.1	21.3	<b>21.3</b>	21.2	21.3	<b>21.8</b>	20.3	20.8	21.0
		25	12	22.4	22.5	22.4	21.0	21.2	21.1	21.1	21.4	21.5	20.3	20.8	20.9
		50	0	22.4	22.5	22.4	21.1	21.2	21.1	21.1	21.4	21.4	20.3	20.8	20.8

**OUTPUT POWER FOR 5G NR n77 (30.0 MHz)**

Bandwidth (MHz)	Modulation	RB Allocation	RB Offset	Conducted Average (dBm)											
				ANT 6			ANT 7			ANT 1			ANT 5		
				647666	656000	664333	647666	656000	664333	647666	656000	664333	647666	656000	664333
30.0	BPSK	1	0	23.8	24.1	24.0	22.2	22.3	22.0	22.2	22.4	22.4	21.4	21.8	22.0
		1	1	25.8	26.0	26.3	25.7	25.8	25.6	25.8	25.9	26.0	25.0	25.3	25.5
		1	76	26.1	26.2	25.9	25.8	25.9	25.8	25.7	26.2	26.2	24.9	25.4	25.6
		1	77	24.1	24.1	23.9	22.3	22.5	22.3	22.2	22.6	22.7	21.5	22.1	22.1
		36	18	26.1	26.1	26.0	25.7	25.9	25.6	25.8	26.0	26.0	25.0	25.5	25.6
		75	0	26.1	26.2	26.0	24.3	24.4	24.1	25.3	25.5	25.6	24.5	24.9	25.1
		1	0	23.3	23.5	23.7	22.2	22.3	22.0	22.2	22.4	22.5	21.4	21.8	22.1
	QPSK	1	1	25.7	26.0	26.1	25.7	25.8	25.5	25.8	25.9	26.0	25.0	25.2	25.5
		1	76	26.1	26.2	26.1	25.8	25.9	25.8	25.8	26.1	26.3	25.0	25.3	25.5
		1	77	23.6	23.7	23.5	22.3	22.3	22.3	22.1	22.6	22.7	21.3	21.9	22.1
		36	18	26.1	26.2	26.0	25.7	25.9	25.7	25.9	26.0	26.1	25.0	25.5	25.6
		75	0	25.9	26.2	26.0	23.7	23.9	23.7	24.8	25.0	25.1	24.0	24.5	24.6
		1	0	22.1	22.8	22.9	22.4	22.3	22.1	21.9	22.3	22.3	21.3	21.6	22.2
		1	1	24.8	25.0	25.0	24.8	24.9	24.7	24.7	24.8	25.0	24.1	24.2	24.5
	16QAM	1	76	24.9	25.2	25.2	24.8	24.7	24.8	24.7	25.1	25.3	23.9	24.5	24.5
		1	77	22.5	22.7	22.4	22.4	22.6	22.3	22.2	22.5	22.7	21.3	22.0	22.0
		36	18	25.0	25.1	25.0	24.7	24.8	24.6	24.8	25.0	25.0	24.0	24.4	24.6
		75	0	24.9	25.2	25.0	22.7	22.8	22.6	23.7	24.0	24.1	23.0	23.5	23.6
		1	0	22.4	22.6	22.4	22.2	22.2	22.0	22.4	22.3	22.5	21.5	21.7	21.8
		1	1	24.8	25.1	25.2	23.4	23.3	22.7	23.0	23.3	23.5	22.5	22.7	22.8
		1	76	25.0	25.2	24.8	23.4	23.3	23.5	23.3	23.6	23.7	22.4	22.9	23.3
	64QAM	1	77	22.7	22.5	22.4	22.4	22.6	22.4	22.1	22.5	22.7	21.4	21.9	22.1
		36	18	25.0	25.1	25.0	23.2	23.3	23.1	23.2	23.5	23.5	22.5	23.0	23.1
		75	0	25.0	25.1	25.0	22.3	22.3	22.2	23.3	23.5	23.6	22.5	23.0	23.1
		1	0	22.2	22.7	22.5	21.1	21.3	20.9	21.1	21.7	21.5	20.3	20.7	20.9
		1	1	22.4	22.6	22.7	21.2	21.3	21.1	21.3	21.8	21.5	20.5	20.7	20.9
		1	76	22.5	22.2	22.2	21.3	21.5	21.4	21.2	21.9	21.7	20.5	21.1	21.0
		1	77	22.5	22.8	22.4	21.3	21.5	21.2	21.2	21.9	21.5	20.3	21.1	21.0
	256QAM	36	18	22.4	22.7	22.5	21.2	21.4	21.1	21.2	21.5	21.5	20.4	20.9	21.1
		75	0	22.5	22.6	22.6	21.2	21.3	21.2	21.3	21.5	21.5	20.5	21.0	21.1

**OUTPUT POWER FOR 5G NR n77 (40.0 MHz)**

Bandwidth (MHz)	Modulation	RB Allocation	RB Offset	Conducted Average (dBm)											
				ANT 6			ANT 7			ANT 1			ANT 5		
				648000	656000	664000	648000	656000	664000	648000	656000	664000	648000	656000	664000
40.0	BPSK	1	0	23.7	24.0	24.2	22.2	22.1	21.8	22.2	22.2	22.2	21.4	21.7	22.0
		1	1	25.7	26.0	26.3	25.7	25.6	25.3	25.6	25.7	25.2	24.9	25.1	25.3
		1	104	26.2	26.1	25.8	26.1	25.8	25.8	25.6	26.1	26.3	24.9	25.3	25.6
		1	105	24.2	24.1	23.9	22.6	22.3	22.3	22.4	22.6	22.8	21.6	22.0	22.1
		50	25	26.0	26.2	26.1	25.8	25.9	25.6	25.7	26.0	26.0	25.0	25.4	25.6
		100	0	26.0	26.1	26.1	24.3	24.3	24.1	25.3	25.5	25.5	24.5	24.9	25.1
		1	0	23.3	23.4	23.8	22.1	22.3	21.9	22.2	22.4	22.3	21.5	21.8	21.9
	QPSK	1	1	25.8	25.9	26.3	25.7	25.9	25.4	25.8	25.8	25.8	24.9	25.3	25.4
		1	104	26.2	26.0	26.0	25.9	25.7	25.8	25.7	26.1	26.1	25.0	25.5	25.6
		1	105	23.7	23.7	23.4	22.4	22.3	22.2	22.1	22.5	22.7	21.5	21.9	22.1
		50	25	26.0	26.2	26.0	25.7	25.8	25.6	25.8	26.0	26.0	25.0	25.5	25.6
		100	0	26.1	26.2	26.1	23.8	23.8	23.6	24.8	25.0	25.0	24.0	24.4	24.6
		1	0	22.5	22.4	22.6	22.3	22.2	22.1	22.4	22.3	22.2	21.4	21.6	21.8
		1	1	25.1	24.7	25.1	24.8	24.7	24.7	24.7	24.7	24.7	24.0	24.1	24.3
	16QAM	1	104	25.2	24.8	24.5	25.0	24.7	24.9	24.7	24.9	25.1	24.0	24.4	24.4
		1	105	22.8	22.6	22.3	22.5	22.2	22.3	22.2	22.6	22.7	21.4	21.8	22.0
		50	25	25.0	25.2	24.9	24.8	24.8	24.6	24.7	25.0	25.1	24.0	24.5	24.7
		100	0	25.0	25.2	25.0	22.7	22.8	22.6	23.7	23.9	24.0	23.0	23.4	23.6
		1	0	22.4	22.2	22.5	22.1	22.5	21.8	22.2	22.4	22.3	21.6	21.8	22.0
		1	1	24.6	25.0	25.1	23.1	23.4	22.8	23.1	23.4	23.3	22.5	23.0	23.0
		1	104	25.1	24.9	25.1	23.2	23.6	23.1	23.1	23.7	23.7	22.6	23.2	23.1
	64QAM	1	105	22.6	22.8	22.3	22.2	22.6	22.2	22.1	22.6	22.5	21.5	22.2	22.2
		50	25	25.0	25.0	25.0	23.2	23.3	23.1	23.2	23.5	23.6	22.5	23.0	23.1
		100	0	25.0	25.1	25.1	22.3	22.3	22.1	23.2	23.4	23.6	22.5	23.0	23.0
		1	0	22.5	22.6	22.8	21.0	21.2	20.9	21.1	21.3	21.4	20.3	20.8	20.9
		1	1	22.6	22.6	22.8	21.0	21.2	20.9	21.1	21.3	21.4	20.5	20.7	20.8
		1	104	22.8	22.8	22.7	21.2	21.2	21.3	21.1	21.6	21.6	20.6	21.1	21.0
		1	105	22.4	22.8	22.7	21.2	21.2	21.3	21.2	21.6	21.6	20.6	20.9	21.1
	256QAM	50	25	22.5	22.7	22.5	21.2	21.3	21.1	21.2	21.5	21.6	20.5	21.0	21.1
		100	0	22.4	22.6	22.5	21.2	21.3	21.1	21.2	21.5	21.5	20.5	20.9	21.1

**OUTPUT POWER FOR 5G NR n77 (50.0 MHz)**

Bandwidth (MHz)	Modulation	RB Allocation	RB Offset	Conducted Average (dBm)											
				ANT 6			ANT 7			ANT 1			ANT 5		
				648333	656000	663666	648333	656000	663666	648333	656000	663666	648333	656000	663666
50.0	BPSK	1	0	23.6	23.8	24.1	22.2	22.3	22.0	22.3	22.2	22.3	21.5	21.7	21.8
		1	1	25.5	25.8	26.1	25.7	25.7	25.6	25.8	25.7	25.9	25.0	25.2	25.4
		1	131	25.9	25.9	25.9	26.0	25.8	25.7	26.0	26.3	25.0	25.4	25.7	
		1	132	24.0	23.8	23.7	22.4	22.2	22.3	22.1	22.5	22.7	21.5	21.9	22.2
		64	32	25.8	25.8	25.9	25.8	25.8	25.6	25.7	26.0	26.0	25.1	25.5	25.5
		128	0	25.8	25.9	25.8	24.3	24.3	24.1	25.2	25.4	25.5	24.5	24.9	25.1
	QPSK	1	0	23.1	23.2	23.5	22.3	22.2	22.0	22.3	22.3	22.3	21.4	21.7	21.9
		1	1	25.5	25.9	26.1	25.8	25.8	25.6	25.8	25.8	25.8	24.9	25.2	25.5
		1	131	26.0	26.0	25.8	25.9	25.8	25.8	25.7	26.0	26.3	25.0	25.5	25.7
		1	132	23.4	23.4	23.2	22.4	22.3	22.3	22.2	22.5	22.7	21.5	21.9	22.2
		64	32	25.8	25.8	25.8	25.8	25.9	25.6	25.7	26.0	26.0	25.0	25.5	25.5
		128	0	25.7	25.8	25.8	23.8	23.8	23.6	24.7	25.0	25.0	24.0	24.5	24.5
	16QAM	1	0	22.1	22.3	22.5	22.3	22.3	22.1	22.2	22.4	22.3	21.4	21.9	22.1
		1	1	24.5	24.7	24.7	24.8	24.9	24.6	24.8	24.9	24.8	23.7	24.5	24.6
		1	131	24.9	24.7	24.8	25.1	24.8	24.9	24.7	25.0	25.2	23.9	24.7	24.9
		1	132	22.4	22.1	22.1	22.5	22.4	22.5	22.1	22.5	22.6	21.3	22.2	22.2
		64	32	24.7	24.9	24.8	24.8	24.9	24.6	24.7	25.0	25.1	24.1	24.5	24.6
		128	0	24.7	24.9	24.8	22.8	22.8	22.6	23.7	24.0	24.0	23.0	23.5	23.6
	64QAM	1	0	22.0	22.4	22.4	22.1	22.2	22.1	22.3	22.6	22.4	21.4	21.8	22.0
		1	1	24.7	24.8	24.7	23.1	23.2	23.1	23.2	23.6	23.4	22.5	22.9	22.8
		1	131	24.7	24.8	24.5	23.3	23.2	23.4	23.3	23.8	23.9	22.4	23.1	23.3
		1	132	22.6	22.3	22.3	22.4	22.1	22.3	22.2	22.7	22.7	21.5	22.0	22.2
		64	32	24.8	24.8	24.8	23.3	23.1	23.3	23.4	23.5	22.5	23.0	23.1	
		128	0	24.8	24.8	24.8	22.3	22.4	22.2	23.2	23.5	23.5	22.5	23.0	23.0
	256QAM	1	0	22.1	22.6	22.5	21.2	21.3	20.8	21.1	21.2	21.4	20.4	20.5	20.8
		1	1	22.2	22.6	22.5	21.3	21.4	21.1	21.0	21.2	21.4	20.4	20.5	20.9
		1	131	22.8	22.6	22.4	21.5	21.3	21.2	21.0	21.4	21.9	20.4	20.7	21.0
		1	132	22.7	22.3	22.4	21.4	21.4	21.3	20.9	21.4	21.8	20.4	20.6	21.1
		64	32	22.3	22.4	22.3	21.3	21.3	21.1	21.2	21.4	21.5	20.5	20.9	21.1
		128	0	22.3	22.4	22.3	21.3	21.3	21.1	21.2	21.5	21.5	20.5	20.9	21.1

**OUTPUT POWER FOR 5G NR n77 (60.0 MHz)**

Bandwidth (MHz)	Modulation	RB Allocation	RB Offset	Conducted Average (dBm)											
				ANT 6			ANT 7			ANT 1			ANT 5		
				648666	656000	663333	648666	656000	663333	648666	656000	663333	648666	656000	663333
60.0	BPSK	1	0	23.7	23.9	24.2	22.2	22.3	22.0	22.2	22.1	22.2	21.4	21.5	21.7
		1	1	25.6	25.9	26.2	25.7	25.7	25.6	25.7	25.6	25.7	24.9	25.0	25.2
		1	160	26.0	26.0	26.0	26.0	25.8	25.8	25.5	25.9	26.2	24.8	25.2	25.7
		1	161	24.1	23.9	23.8	22.4	22.2	22.3	22.0	22.3	22.6	21.4	21.7	22.1
		81	40	25.9	25.9	26.0	25.8	25.8	25.6	25.7	26.0	25.9	24.9	25.4	25.5
		162	0	25.9	26.0	25.9	24.3	24.3	24.1	25.1	25.5	25.4	24.4	24.9	25.0
	QPSK	1	0	23.2	23.3	23.6	22.3	22.2	22.0	22.2	22.2	22.2	21.4	21.6	21.7
		1	1	25.6	26.0	26.2	25.8	25.8	25.6	25.7	25.7	25.7	24.9	25.0	25.2
		1	160	26.1	26.1	25.9	25.9	25.8	25.8	25.5	25.9	26.2	24.8	25.3	25.5
		1	161	23.5	23.5	23.3	22.4	22.3	22.3	22.0	22.3	22.7	21.4	21.8	22.0
		81	40	25.9	25.9	25.9	25.8	25.9	25.6	25.6	25.9	25.9	25.0	25.4	25.5
		162	0	25.8	25.9	25.9	23.8	23.8	23.6	24.6	25.0	25.0	23.9	24.4	24.4
	16QAM	1	0	22.2	22.4	22.6	22.3	22.3	22.1	22.4	22.2	22.0	21.4	21.5	21.4
		1	1	24.6	24.8	24.8	24.8	24.9	24.6	25.0	24.7	24.4	23.9	23.9	24.1
		1	160	25.0	24.8	24.9	25.1	24.8	24.9	24.8	25.0	24.8	23.8	24.3	24.4
		1	161	22.5	22.2	22.2	22.5	22.4	22.5	22.3	22.5	22.5	21.3	21.9	22.0
		81	40	24.8	25.0	24.9	24.8	24.9	24.6	24.6	24.9	25.0	23.9	24.4	24.6
		162	0	24.8	25.0	24.9	22.8	22.8	22.6	23.7	24.0	23.9	22.9	23.3	23.5
	64QAM	1	0	22.1	22.5	22.5	22.1	22.2	22.1	22.3	22.1	22.2	21.5	21.4	21.6
		1	1	24.8	24.9	24.8	23.1	23.2	23.1	23.3	23.1	23.5	22.5	22.5	22.7
		1	160	24.8	24.9	24.6	23.3	23.2	23.4	23.2	23.4	23.8	22.4	22.8	23.1
		1	161	22.7	22.4	22.4	22.4	22.1	22.3	22.1	22.3	22.7	21.4	21.7	22.1
		81	40	24.9	24.9	24.9	23.4	23.3	23.1	23.1	23.5	23.5	22.4	22.9	23.0
		162	0	24.9	24.9	24.9	22.3	22.4	22.2	23.1	23.5	23.4	22.5	23.0	23.0
	256QAM	1	0	22.2	22.7	22.6	21.2	21.3	20.8	21.1	21.1	20.9	20.4	20.6	20.9
		1	1	22.3	22.7	22.6	21.3	21.4	21.1	21.2	21.1	21.1	20.4	20.7	20.8
		1	160	22.9	22.7	22.5	21.5	21.3	21.2	20.8	21.3	21.6	20.3	20.8	21.2
		1	161	22.8	22.4	22.5	21.4	21.4	21.3	20.9	21.3	21.4	20.3	20.8	21.1
		81	40	22.4	22.5	22.4	21.3	21.3	21.1	21.1	21.4	21.4	20.5	20.9	21.0
		162	0	22.4	22.5	22.4	21.3	21.3	21.1	21.1	21.5	21.4	20.4	20.9	21.0

**OUTPUT POWER FOR 5G NR n77 (70.0 MHz)**

Bandwidth (MHz)	Modulation	RB Allocation	RB Offset	Conducted Average (dBm)											
				ANT 6			ANT 7			ANT 1			ANT 5		
				649000	656000	663000	649000	656000	663000	649000	656000	663000	649000	656000	663000
70.0	BPSK	1	0	23.7	23.8	24.2	22.3	22.2	22.0	22.2	22.1	22.1	21.4	21.5	21.6
		1	1	25.7	25.9	26.3	25.8	25.7	25.6	25.7	25.7	25.7	25.1	25.0	25.1
		1	187	26.2	26.2	26.0	25.9	25.7	25.9	25.5	25.9	26.1	24.8	25.2	25.6
		1	188	24.0	24.1	24.0	22.3	22.2	22.3	21.9	22.4	22.7	21.3	21.8	22.1
		90	45	26.0	26.0	26.1	25.9	25.9	25.6	25.6	25.9	25.9	25.0	25.3	25.4
		180	0	26.0	25.9	26.1	24.3	24.3	24.1	25.1	25.4	25.3	24.5	24.9	24.9
	QPSK	1	0	23.1	23.4	23.7	22.2	22.2	22.1	22.2	22.1	22.0	21.5	21.5	21.5
		1	1	25.6	25.9	26.2	25.7	25.8	25.6	25.7	25.6	25.7	25.1	25.0	25.0
		1	187	26.1	26.1	26.0	25.8	25.7	25.9	25.4	26.0	26.2	24.8	25.2	25.5
		1	188	23.6	23.6	23.5	22.4	22.2	22.3	22.0	22.3	22.7	21.4	21.9	22.1
		90	45	25.9	26.0	26.1	25.8	25.9	25.6	25.6	26.0	25.9	25.0	25.4	25.4
		180	0	25.9	26.0	26.0	23.8	23.8	23.6	24.7	24.9	24.9	24.0	24.4	24.4
	16QAM	1	0	22.4	22.3	22.6	22.2	22.3	22.1	22.2	22.2	22.1	21.5	21.4	21.4
		1	1	24.9	24.9	24.8	24.7	24.8	24.6	24.7	24.8	24.7	24.0	23.9	24.0
		1	187	25.1	24.9	24.8	24.9	24.7	24.8	24.8	24.4	25.0	25.1	23.8	24.1
		1	188	22.9	22.5	22.3	22.4	22.1	22.3	21.9	22.2	22.7	21.2	21.7	22.0
		90	45	24.9	24.8	25.0	24.8	24.8	24.6	24.6	24.9	24.9	24.1	24.4	24.5
		180	0	24.9	25.0	25.0	22.8	22.8	22.6	23.6	24.0	23.9	23.0	23.3	23.4
	64QAM	1	0	22.2	22.6	22.7	22.0	22.1	22.0	22.2	22.0	22.2	21.4	21.4	21.7
		1	1	24.5	24.8	24.9	23.1	23.2	23.1	23.2	23.1	23.2	22.4	22.7	22.8
		1	187	25.0	24.9	24.7	23.2	23.0	23.3	22.9	23.4	23.6	22.3	22.7	23.2
		1	188	22.7	22.5	22.5	22.2	22.0	22.3	21.9	22.4	22.7	21.2	21.6	22.2
		90	45	25.0	24.9	25.0	23.4	23.3	23.1	23.2	23.4	23.4	22.5	22.9	22.9
		180	0	24.9	25.0	24.8	22.3	22.3	22.2	23.1	23.4	23.4	22.5	22.9	23.0
	256QAM	1	0	22.2	22.2	23.0	21.1	21.2	21.0	21.3	21.3	21.2	20.5	20.6	20.7
		1	1	22.3	22.2	22.8	21.1	21.3	21.1	21.3	21.3	21.3	20.6	20.6	20.5
		1	187	22.8	22.2	22.5	21.2	21.2	21.3	21.0	21.4	21.7	20.4	20.9	21.2
		1	188	22.6	22.5	22.6	21.3	21.2	21.3	21.0	21.4	21.8	20.4	20.8	21.1
		90	45	22.3	22.5	22.5	21.3	21.3	21.1	21.2	21.4	21.4	20.6	20.9	20.9
		180	0	22.4	22.5	22.4	21.3	21.3	21.1	21.1	21.4	21.5	20.5	20.9	21.0

**OUTPUT POWER FOR 5G NR n77 (80.0 MHz)**

Bandwidth (MHz)	Modulation	RB Allocation	RB Offset	Conducted Average (dBm)											
				ANT 6			ANT 7			ANT 1			ANT 5		
				649333	656000	662666	649333	656000	662666	649333	656000	662666	649333	656000	662666
80.0	BPSK	1	0	23.8	23.8	24.2	22.3	22.3	22.1	22.2	22.2	22.1	21.4	21.5	21.6
		1	1	25.7	25.9	26.2	25.8	25.9	25.7	25.8	25.7	25.8	25.1	25.0	25.1
		1	215	26.3	26.1	26.0	25.9	25.7	25.9	25.6	26.0	26.3	25.0	25.3	25.6
		1	216	24.2	24.2	24.1	22.3	22.2	22.4	22.1	22.4	22.6	21.4	21.8	22.1
		108	54	26.0	25.9	26.1	25.9	25.9	25.7	25.6	25.9	25.9	25.0	25.3	25.4
		216	0	26.1	26.0	26.0	24.5	24.3	24.2	25.1	25.5	25.5	24.5	24.8	24.9
	QPSK	1	0	23.2	23.4	23.7	22.2	22.3	22.1	22.2	22.2	22.2	21.5	21.6	21.6
		1	1	25.8	25.9	26.2	25.8	25.9	25.7	25.8	25.8	25.7	24.9	25.0	25.1
		1	215	26.1	26.1	26.1	25.9	25.8	26.0	25.6	26.0	26.3	25.0	25.4	25.6
		1	216	23.6	23.5	23.6	22.3	22.2	22.3	22.0	22.4	22.7	21.5	21.8	22.2
		108	54	26.1	25.9	26.1	25.9	25.9	25.6	25.6	25.9	25.9	25.1	25.4	25.4
		216	0	25.9	26.0	26.1	23.9	23.8	23.6	24.7	24.9	24.9	24.0	24.3	24.4
	16QAM	1	0	22.0	22.0	22.3	22.2	22.1	22.2	22.4	22.2	22.2	21.6	21.5	21.6
		1	1	24.6	25.0	25.0	24.8	24.7	24.8	24.9	24.8	24.8	24.2	24.1	24.2
		1	215	25.1	25.0	24.9	24.9	24.5	25.0	24.7	25.0	25.3	24.2	24.3	24.7
		1	216	22.5	22.4	22.2	22.3	22.0	22.5	22.2	22.4	22.7	21.6	21.8	22.2
		108	54	25.1	25.0	25.0	24.9	24.9	24.7	24.7	25.0	24.9	24.0	24.3	24.4
		216	0	24.9	24.9	25.0	22.9	22.8	22.6	23.6	24.0	23.9	23.0	23.4	23.4
	64QAM	1	0	22.0	22.1	22.6	22.2	22.4	22.1	22.2	22.3	22.2	21.5	21.6	21.5
		1	1	25.0	24.7	25.0	23.3	23.5	23.2	23.3	23.3	23.2	22.7	22.7	22.6
		1	215	25.1	24.9	24.9	23.3	23.4	23.4	23.2	23.7	23.7	22.5	22.9	23.2
		1	216	22.5	22.2	22.3	22.3	22.3	22.4	22.1	22.5	22.7	21.4	21.9	22.1
		108	54	24.9	24.9	25.0	23.4	23.4	23.1	23.2	23.5	23.4	22.6	22.9	23.0
		216	0	25.0	25.0	25.0	22.4	22.3	22.1	23.2	23.5	23.4	22.6	23.0	22.9
	256QAM	1	0	22.2	22.4	22.5	20.9	21.4	21.1	21.2	21.1	21.3	20.5	20.5	20.4
		1	1	22.3	22.7	22.5	21.0	21.4	21.2	21.3	21.2	21.4	20.6	20.4	20.5
		1	215	22.6	22.6	22.6	21.1	21.3	21.5	21.1	21.4	21.8	20.6	20.7	20.9
		1	216	22.6	22.9	22.6	21.0	21.2	21.4	21.1	21.4	21.9	20.5	20.6	20.9
		108	54	22.5	22.4	22.4	21.3	21.3	21.1	21.1	21.4	21.4	20.5	20.9	20.9
		216	0	22.5	22.5	22.5	21.3	21.4	21.1	21.1	21.4	21.4	20.5	20.9	21.0



**OUTPUT POWER FOR 5G NR n77 (90.0 MHz)**

Bandwidth (MHz)	Modulation	RB Allocation	RB Offset	Conducted Average (dBm)											
				ANT 6			ANT 7			ANT 1			ANT 5		
				649666	656000	662333	649666	656000	662333	649666	656000	662333	649666	656000	662333
90.0	BPSK	1	0	23.6	23.8	24.0	22.2	22.3	22.2	22.2	22.1	22.3	21.5	21.5	21.6
		1	1	25.6	26.0	26.1	25.9	25.9	25.8	25.8	25.7	25.8	25.2	25.1	25.2
		1	243	26.1	26.2	26.1	26.0	25.8	26.0	25.6	26.1	26.3	25.1	25.4	25.7
		1	244	24.0	24.1	23.9	22.3	22.1	22.4	22.1	22.4	22.7	21.5	21.8	22.1
		120	60	26.0	26.0	26.1	25.9	25.8	25.6	25.6	26.0	25.9	25.1	25.5	25.4
		243	0	26.0	25.9	26.1	24.4	24.4	24.2	25.2	25.5	25.4	24.6	24.8	24.9
	QPSK	1	0	23.0	23.4	23.5	22.2	22.3	22.1	22.2	22.0	22.3	21.6	21.4	21.6
		1	1	25.6	26.0	26.2	25.8	25.9	25.8	25.8	25.8	25.9	25.1	25.1	25.2
		1	243	26.1	26.2	26.0	26.0	25.8	26.0	25.7	26.0	26.4	25.1	25.3	25.7
		1	244	23.5	23.5	23.4	22.4	22.2	22.4	22.2	22.5	22.7	21.5	21.8	22.1
		120	60	26.1	25.9	26.1	25.9	25.8	25.6	25.6	25.9	25.9	25.1	25.5	25.4
		243	0	26.0	25.9	26.0	23.9	23.8	23.7	24.7	24.9	25.0	24.0	24.4	24.4
	16QAM	1	0	22.0	22.6	22.8	22.3	22.3	22.3	22.3	22.1	22.1	21.6	21.6	21.8
		1	1	24.3	24.9	24.9	24.9	25.0	24.9	24.8	24.8	24.7	24.2	24.2	24.3
		1	243	24.9	24.9	25.0	25.0	24.9	25.1	24.7	25.0	24.2	24.2	24.5	24.9
		1	244	22.4	22.8	22.6	22.4	22.2	22.5	22.0	22.3	22.6	21.6	21.8	22.2
		120	60	24.9	25.0	25.0	24.9	24.9	24.6	24.6	24.9	24.9	24.1	24.5	24.4
		243	0	25.0	24.9	25.0	22.9	22.9	22.6	23.7	24.0	23.9	23.1	23.4	23.4
	64QAM	1	0	21.7	22.2	22.3	22.3	22.4	22.2	22.1	22.2	22.4	21.7	21.3	21.6
		1	1	24.7	25.0	24.9	23.5	23.5	23.3	23.1	23.3	23.5	22.7	22.5	22.8
		1	243	24.9	24.6	24.8	23.5	23.4	23.5	22.9	23.5	23.9	22.7	22.8	23.2
		1	244	22.4	22.5	22.1	22.4	22.3	22.5	21.8	22.5	22.8	21.6	21.7	22.1
		120	60	25.0	25.0	25.0	23.4	23.3	23.1	23.2	23.5	23.4	22.6	22.9	22.9
		243	0	24.8	25.0	24.9	22.4	22.3	22.2	23.2	23.4	23.4	22.5	22.9	22.9
	256QAM	1	0	22.0	22.3	22.3	21.2	21.2	21.2	21.1	21.3	21.2	20.4	20.4	20.8
		1	1	22.3	22.6	22.5	21.3	21.3	21.3	21.3	21.4	21.4	20.5	20.6	20.9
		1	243	22.6	22.7	22.5	21.4	21.2	21.4	21.3	21.5	21.7	20.4	20.8	21.4
		1	244	22.5	22.6	22.4	21.3	21.1	21.3	21.1	21.5	21.6	20.4	20.7	21.5
		120	60	22.5	22.3	22.4	21.4	21.3	21.1	21.1	21.4	21.4	20.6	20.9	20.9
		243	0	22.5	22.5	22.5	21.4	21.3	21.1	21.2	21.4	21.4	20.5	20.8	20.9

**OUTPUT POWER FOR 5G NR n77 (100.0 MHz)**

Bandwidth (MHz)	Modulation	RB Allocation	RB Offset	Conducted Average (dBm)											
				ANT 6			ANT 7			ANT 1			ANT 5		
				650000	656000	662000	650000	656000	662000	650000	656000	662000	650000	656000	662000
100.0	BPSK	1	0	23.4	23.8	24.0	22.1	22.3	22.0	22.1	22.0	22.3	21.5	21.4	21.7
		1	1	25.7	26.0	26.1	25.8	26.0	25.8	25.9	25.7	26.0	25.2	25.1	25.4
		1	271	26.0	26.1	26.1	26.0	25.8	26.0	25.8	26.0	26.3	25.2	25.4	25.8
		1	272	24.0	24.0	23.9	22.3	22.1	22.4	22.2	22.3	22.6	21.5	21.7	22.1
		135	67	26.0	25.9	26.3	25.9	25.9	25.6	25.7	26.0	25.8	25.1	25.5	25.3
		270	0	26.1	25.9	26.1	24.4	24.4	24.1	25.2	25.5	25.4	24.6	25.0	25.0
	QPSK	1	0	22.9	23.4	23.5	22.1	22.3	22.1	22.2	21.9	22.3	21.4	21.4	21.7
		1	1	25.7	26.1	26.3	25.9	26.0	25.8	25.9	25.8	26.0	25.0	25.0	25.3
		1	271	26.0	26.3	26.1	26.0	25.8	26.0	25.8	26.1	26.3	25.3	25.4	25.8
		1	272	23.2	23.6	23.4	22.4	22.2	22.4	22.1	22.3	22.7	21.5	21.7	22.1
		135	67	26.0	26.0	26.2	25.9	25.9	25.6	25.7	26.0	25.9	25.1	25.5	25.5
		270	0	25.9	26.0	26.1	23.9	23.8	23.7	24.7	25.0	24.9	24.0	24.5	24.4
	16QAM	1	0	22.1	22.3	22.2	22.1	22.4	22.2	22.1	22.1	22.5	21.4	21.4	21.5
		1	1	24.7	25.1	25.0	24.8	25.0	24.9	24.8	24.7	25.2	24.1	24.0	24.3
		1	271	25.2	25.2	24.6	24.9	24.9	25.1	24.7	25.0	25.5	24.2	24.2	24.7
		1	272	22.5	22.5	22.2	22.2	22.2	22.5	22.1	22.4	22.5	21.5	21.7	22.0
		135	67	24.9	24.8	25.0	24.9	24.8	24.6	24.7	25.0	24.8	24.1	24.5	24.3
		270	0	25.0	24.9	25.1	22.9	22.9	22.7	23.6	24.0	23.9	23.1	23.5	23.5
	64QAM	1	0	22.0	22.5	22.7	22.1	22.3	22.1	22.2	22.0	22.4	21.5	21.6	21.6
		1	1	24.6	24.8	25.0	23.3	23.6	23.2	23.3	23.2	23.6	22.7	22.8	23.0
		1	271	25.1	25.1	25.0	23.4	23.4	23.4	23.3	23.4	24.0	22.7	23.0	23.3
		1	272	22.4	22.3	22.5	22.3	22.3	22.4	22.2	22.3	22.7	21.6	21.9	22.1
		135	67	24.9	24.8	25.0	23.5	23.3	23.1	23.2	23.5	23.3	22.6	22.9	23.0
		270	0	25.0	25.0	25.0	22.4	22.4	22.2	23.1	23.5	23.4	22.6	22.9	22.9
	256QAM	1	0	21.7	22.2	22.6	21.1	21.2	21.2	21.1	21.1	21.2	20.3	20.5	20.6
		1	1	22.4	22.7	22.7	21.3	21.4	21.4	21.3	21.3	21.4	20.6	20.7	20.7
		1	271	22.4	22.7	22.4	21.4	21.3	21.6	21.2	21.5	21.8	20.6	20.9	21.3
		1	272	22.4	22.6	22.5	21.2	21.2	21.4	21.1	21.4	21.5	20.4	20.7	21.0
		135	67	22.4	22.3	22.6	21.4	21.4	21.1	21.2	21.5	21.3	20.6	21.1	20.9
		270	0	22.5	22.5	22.5	21.4	21.3	21.2	21.1	21.5	21.4	20.5	20.9	20.9

## 9. CONDUCTED TEST RESULTS

### 9.1. OCCUPIED BANDWIDTH

#### RULE PART(S)

FCC: §2.1049

#### LIMITS

For reporting purposes only.

#### TEST PROCEDURE

The transmitter output was connected to a calibrated coaxial cable and coupler, the other end of which was connected to a spectrum analyzer. The occupied bandwidth was measured with the spectrum analyzer at the middle channel in each band. The 99% and -26dB bandwidths was also measured and recorded.

#### RESULTS

There is no limit required and power is the same for low, middle and high channel; therefore, only middle channel was tested except 5G NR n70 where mix of middle/high channels are used. Worst-case plots (highest bandwidth) are reported only.



**LTE BAND 5**

Band	Mode	RB Allocation/RB Offset	f(MHz)	99% BW (MHz)	-26dB BW (MHz)
LTE BAND 5	1.4MHz, QPSK	6/0	836.5	1.0937	1.317
	1.4MHz, 16QAM			1.0882	1.307
	3MHz, QPSK	15/0		2.6996	3.063
	3MHz, 16QAM			2.7053	3.104
	5MHz, QPSK	25/0		4.5026	5.284
	5MHz, 16QAM			4.4934	5.199
	10MHz, QPSK	50/0		8.9862	10.180
	10MHz, 16QAM			9.0046	10.280
	10MHz, QPSK	1/0		0.2420	0.386

**5G NR n5**

Band	Mode	RB Allocation/RB Offset	f(MHz)	99% BW (MHz)	-26dB BW (MHz)
5G NR n5	5MHz, BPSK	25/0	836.5	4.4874	5.191
	5MHz, QPSK			4.4947	5.290
	5MHz, 16QAM			4.5045	5.323
	10MHz, BPSK	50/0		8.9756	9.801
	10MHz, QPSK			8.9509	9.847
	10MHz, 16QAM			8.9687	9.825
	15MHz, BPSK	75/0		13.409	14.490
	15MHz, QPSK			13.427	14.630
	15MHz, 16QAM			13.429	14.480
	20MHz, BPSK	100/0		17.846	19.050
	20MHz, QPSK			17.865	19.140
	20MHz, 16QAM			17.832	19.030
	20MHz, BPSK	1/0		0.2390	0.385

**LTE BAND 7**

Band	Mode	RB Allocation/RB Offset	f(MHz)	99% BW (MHz)	-26dB BW (MHz)
LTE BAND 7	5MHz, QPSK	25/0	2535.0	4.5183	5.288
	5MHz, 16QAM			4.5116	5.330
	10MHz, QPSK	50/0		9.0150	10.340
	10MHz, 16QAM			8.9933	10.400
	15MHz, QPSK	75/0		13.469	15.100
	15MHz, 16QAM			13.454	14.930
	20MHz, QPSK	100/0		17.980	19.960
	20MHz, 16QAM			17.905	18.920
	20MHz, QPSK	1/0		0.2765	0.472

**5G NR n7**

Band	Mode	RB Allocation/RB Offset	f(MHz)	99% BW (MHz)	-26dB BW (MHz)
5G NR n7	5MHz, BPSK	25/0	2535.0	4.5778	5.106
	5MHz, QPSK			4.5063	5.335
	5MHz, 16QAM			4.6134	5.075
	10MHz, BPSK	50/0		8.9867	10.03
	10MHz, QPSK			8.9849	9.912
	10MHz, 16QAM			8.9799	9.913
	15MHz, BPSK	75/0		13.455	14.590
	15MHz, QPSK			13.475	14.670
	15MHz, 16QAM			13.426	14.640
	20MHz, BPSK	100/0		17.962	19.240
	20MHz, QPSK			17.919	19.140
	20MHz, 16QAM			17.972	19.160
	25MHz, BPSK	128/0		22.968	25.000
	25MHz, QPSK			22.935	24.870
	25MHz, 16QAM			22.975	24.790
	30MHz, BPSK	160/0		28.740	31.870
	30MHz, QPSK			28.660	32.150
	30MHz, 16QAM			28.801	32.380
	40MHz, BPSK	216/0		38.755	42.050
	40MHz, QPSK			38.722	42.420
40MHz, 16QAM	38.649		42.060		
50MHz, BPSK	270/0	48.300	52.29		
50MHz, QPSK		48.225	51.74		
50MHz, 16QAM		48.205	51.93		
50MHz, BPSK	1/0	0.2980	0.4509		

**LTE BAND 12**

Band	Mode	RB Allocation/RB Offset	f(MHz)	99% BW (MHz)	-26dB BW (MHz)
LTE BAND 12	1.4MHz, QPSK	6/0	707.5	1.0865	1.291
	1.4MHz, 16QAM			1.0898	1.297
	3MHz, QPSK	15/0		2.7031	3.114
	3MHz, 16QAM			2.7018	3.117
	5MHz, QPSK	25/0		4.5153	5.335
	5MHz, 16QAM			4.4998	5.251
	10MHz, QPSK	50/0		9.0119	10.150
	10MHz, 16QAM			8.9830	10.310
	10MHz, QPSK	1/0		0.2376	0.396

**5G NR n12**

Band	Mode	RB Allocation/RB Offset	f(MHz)	99% BW (MHz)	-26dB BW (MHz)
5G NR n12	5MHz, BPSK	25/0	707.5	4.4921	5.087
	5MHz, QPSK			4.4846	5.180
	5MHz, 16QAM			4.5038	5.261
	10MHz, BPSK	50/0		8.9665	9.846
	10MHz, QPSK			8.9747	9.922
	10MHz, 16QAM			8.9513	9.925
	15MHz, BPSK	75/0		13.437	14.490
	15MHz, QPSK			13.426	14.520
	15MHz, 16QAM			13.413	14.600
	15MHz, BPSK	1/0		0.2417	0.377

**LTE BAND 13**

Band	Mode	RB Allocation/RB Offset	f(MHz)	99% BW (MHz)	-26dB BW (MHz)
LTE BAND 13	5MHz, QPSK	25/0	782.0	4.5037	5.293
	5MHz, 16QAM			4.5049	5.293
	10MHz, QPSK	50/0		8.9736	10.320
	10MHz, 16QAM			8.9670	10.340
	10MHz, QPSK	1/0		0.2339	0.390

**LTE BAND 14**

Band	Mode	RB Allocation/RB Offset	f(MHz)	99% BW (MHz)	-26dB BW (MHz)
LTE BAND 14	5MHz, QPSK	25/0	793.0	4.5124	5.210
	5MHz, 16QAM			4.5026	5.248
	10MHz, QPSK	50/0		9.0042	10.270
	10MHz, 16QAM			8.9822	10.310
	10MHz, QPSK	1/0		0.2359	0.394

**5G NR n14**

Band	Mode	RB Allocation/RB Offset	f(MHz)	99% BW (MHz)	-26dB BW (MHz)
5G NR n14	5MHz, BPSK	25/0	793.0	4.4972	5.292
	5MHz, QPSK			4.4968	5.244
	5MHz, 16QAM			4.5074	5.233
	10MHz, BPSK	50/0		8.9629	9.863
	10MHz, QPSK			8.9802	9.965
	10MHz, 16QAM			8.9625	9.762
	10MHz, BPSK	1/0		0.2380	0.377

**LTE BAND 17**

Band	Mode	RB Allocation/RB Offset	f(MHz)	99% BW (MHz)	-26dB BW (MHz)
LTE BAND 17	5MHz, QPSK	25/0	710.0	4.5281	5.359
	5MHz, 16QAM			4.5230	5.248
	10MHz, QPSK	50/0		9.0104	10.360
	10MHz, 16QAM			9.0070	10.360
	10MHz, QPSK	1/0		0.2347	0.393

**LTE BAND 25**

Band	Mode	RB Allocation/RB Offset	f(MHz)	99% BW (MHz)	-26dB BW (MHz)
LTE BAND 25	1.4MHz, QPSK	6/0	1882.5	1.0895	1.311
	1.4MHz, 16QAM			1.0930	1.311
	3MHz, QPSK	15/0		2.7016	3.110
	3MHz, 16QAM			2.7025	3.077
	5MHz, QPSK	25/0		4.5191	5.219
	5MHz, 16QAM			4.5160	5.278
	10MHz, QPSK	50/0		9.0147	10.280
	10MHz, 16QAM			9.0094	10.190
	15MHz, QPSK	75/0		13.488	15.160
	15MHz, 16QAM			13.467	15.250
	20MHz, QPSK	100/0		17.963	19.860
	20MHz, 16QAM			17.967	19.990
	20MHz, QPSK	1/0		0.2691	0.460

**5G NR n25**

Band	Mode	RB Allocation/RB Offset	f(MHz)	99% BW (MHz)	-26dB BW (MHz)
5G NR n25	5MHz, BPSK	25/0	1882.5	4.5903	5.075
	5MHz, QPSK			4.5030	5.224
	5MHz, 16QAM			4.5865	5.044
	10MHz, BPSK	50/0		8.9724	9.855
	10MHz, QPSK			8.9747	9.994
	10MHz, 16QAM			8.9700	9.860
	15MHz, BPSK	75/0		13.460	14.680
	15MHz, QPSK			13.448	14.590
	15MHz, 16QAM			13.445	14.630
	20MHz, BPSK	100/0		17.915	19.250
	20MHz, QPSK			17.907	19.290
	20MHz, 16QAM			17.914	19.270
	25MHz, BPSK	128/0		22.950	24.920
	25MHz, QPSK			22.933	25.170
	25MHz, 16QAM			22.895	25.090
	30MHz, BPSK	160/0		28.693	31.900
	30MHz, QPSK			28.663	31.830
	30MHz, 16QAM			28.614	31.650
	35MHz, BPSK	180/0		32.262	35.610
	35MHz, QPSK			32.249	36.020
35MHz, 16QAM	32.323		36.120		
40MHz, BPSK	216/0	38.731	42.320		
40MHz, QPSK		38.624	42.270		
40MHz, 16QAM		38.740	40.890		
40MHz, BPSK	1/0	0.2459	0.440		

**LTE BAND 26 (PART 90S)**

Band	Mode	RB Allocation/RB Offset	f(MHz)	99% BW (MHz)	-26dB BW (MHz)
LTE BAND 26	1.4MHz, QPSK	6/0	819.0	1.0921	1.303
	1.4MHz, 16QAM			1.0939	1.341
	3MHz, QPSK	15/0		2.7038	3.108
	3MHz, 16QAM			2.7013	3.097
	5MHz, QPSK	25/0		4.5049	5.254
	5MHz, 16QAM			4.5123	5.385
	10MHz, QPSK	50/0		8.9915	10.380
	10MHz, 16QAM			9.0018	10.370
	10MHz, QPSK	1/0		0.2575	0.411

**5G NR n26 (PART 90S)**

Band	Mode	RB Allocation/RB Offset	f(MHz)	99% BW (MHz)	-26dB BW (MHz)
5G NR n26 (Part 90S)	5MHz, BPSK	25/0	819.0	4.4975	5.294
	5MHz, QPSK			4.5026	5.292
	5MHz, 16QAM			4.4955	5.277
	10MHz, BPSK	50/0		8.9694	10.000
	10MHz, QPSK			8.9805	9.994
	10MHz, 16QAM			8.9576	9.979
	10MHz, BPSK	1/0		0.2215	0.374

**LTE BAND 26 (PART 22)**

Band	Mode	RB Allocation/RB Offset	f(MHz)	99% BW (MHz)	-26dB BW (MHz)
LTE BAND 26	1.4MHz, QPSK	6/0	836.5	1.0875	1.303
	1.4MHz, 16QAM			1.0877	1.325
	3MHz, QPSK	15/0		2.7105	3.071
	3MHz, 16QAM			2.7024	3.095
	5MHz, QPSK	25/0		4.4980	5.153
	5MHz, 16QAM			4.5007	5.191
	10MHz, QPSK	50/0		8.9895	10.440
	10MHz, 16QAM			8.9828	10.370
	15MHz, QPSK	75/0		13.422	15.200
	15MHz, 16QAM			13.433	15.140
	15MHz, QPSK	1/0		0.2689	0.478

**5G NR n26 (PART 22)**

Band	Mode	RB Allocation/RB Offset	f(MHz)	99% BW (MHz)	-26dB BW (MHz)
5G NR n26 (Part 22)	5MHz, BPSK	25/0	836.5	4.4996	5.267
	5MHz, QPSK			4.4906	5.172
	5MHz, 16QAM			4.5009	5.298
	10MHz, BPSK	50/0		8.9623	9.836
	10MHz, QPSK			8.9624	9.826
	10MHz, 16QAM			8.9858	9.847
	15MHz, BPSK	75/0		13.433	14.490
	15MHz, QPSK			13.405	14.470
	15MHz, 16QAM			13.416	14.470
	20MHz, BPSK	100/0		17.920	19.090
	20MHz, QPSK			17.897	19.300
	20MHz, 16QAM			17.890	19.180
	20MHz, BPSK	1/0		0.2388	0.373

**LTE BAND 30**

Band	Mode	RB Allocation/RB Offset	f(MHz)	99% BW (MHz)	-26dB BW (MHz)
LTE BAND 30	5MHz, QPSK	25/0	2310.0	4.5118	5.311
	5MHz, 16QAM			4.5108	5.370
	10MHz, QPSK	50/0		9.0115	10.270
	10MHz, 16QAM			8.9935	10.480
	10MHz, QPSK	1/0		0.2475	0.421

**5G NR n30**

Band	Mode	RB Allocation/RB Offset	f(MHz)	99% BW (MHz)	-26dB BW (MHz)
5G NR n30	5MHz, BPSK	25/0	2310.0	4.4987	5.093
	5MHz, QPSK			4.4938	5.227
	5MHz, 16QAM			4.5038	5.277
	10MHz, BPSK	50/0		8.9679	9.838
	10MHz, QPSK			8.9769	9.964
	10MHz, 16QAM			8.9916	9.930
	10MHz, BPSK			1/0	0.2283

**LTE BAND 41 HPUe**

Band	Mode	RB Allocation/RB Offset	f(MHz)	99% BW (MHz)	-26dB BW (MHz)
LTE BAND 41	5MHz, QPSK	25/0	2593.0	4.5065	5.241
	5MHz, 16QAM			4.5020	5.255
	10MHz, QPSK	50/0		8.9889	10.490
	10MHz, 16QAM			8.9921	10.180
	15MHz, QPSK	75/0		13.450	15.000
	15MHz, 16QAM			13.450	15.070
	20MHz, QPSK	100/0		17.908	19.780
	20MHz, 16QAM			17.962	19.740
	20MHz, QPSK	1/0		0.2872	0.470

**5G NR n41 HPUE**

Band	Mode	RB Allocation/RB Offset	f(MHz)	99% BW (MHz)	-26dB BW (MHz)
5G NR n41 (FCC)	10MHz, BPSK	24/0	2593.0	8.6648	10.07
	10MHz, QPSK			8.6681	10.26
	10MHz, 16QAM			8.6803	10.02
	15MHz, BPSK	36/0		12.922	14.73
	15MHz, QPSK			12.933	14.81
	15MHz, 16QAM			12.907	14.25
	20MHz, BPSK	50/0		17.926	19.48
	20MHz, QPSK			17.889	19.88
	20MHz, 16QAM			17.873	19.50
	25MHz, BPSK	64/0		22.918	24.85
	25MHz, QPSK			22.974	25.07
	25MHz, 16QAM			22.924	25.15
	30MHz, BPSK	75/0		26.960	28.98
	30MHz, QPSK			26.937	29.21
	30MHz, 16QAM			26.892	29.27
	40MHz, BPSK	100/0		35.856	38.02
	40MHz, QPSK			35.799	38.46
	40MHz, 16QAM			35.765	38.10
	50MHz, BPSK	128/0		45.782	49.65
	50MHz, QPSK			45.771	49.98
	50MHz, 16QAM			45.678	49.63
	60MHz, BPSK	162/0		58.026	64.55
	60MHz, QPSK			57.957	63.62
	60MHz, 16QAM			57.955	64.01
	70MHz, BPSK	180/0		64.486	70.33
	70MHz, QPSK			64.580	72.03
	70MHz, 16QAM			64.501	71.70
	80MHz, BPSK	216/0		77.398	84.39
	80MHz, QPSK			77.476	85.73
	80MHz, 16QAM			77.454	84.59
90MHz, BPSK	243/0	87.125	93.50		
90MHz, QPSK		87.144	95.13		
90MHz, 16QAM		87.074	94.72		
100MHz, BPSK	270/0	96.785	104.1		
100MHz, QPSK		96.612	105.9		
100MHz, 16QAM		96.523	105.0		
100MHz, BPSK	1/0	0.5954	0.893		



**LTE BAND 48**

Band	Mode	RB Allocation/RB Offset	f(MHz)	99% BW (MHz)	-26dB BW (MHz)
LTE BAND 48	5MHz, QPSK	25/0	3625.0	4.4897	5.230
	5MHz, 16QAM			4.4884	5.182
	10MHz, QPSK	50/0		8.9758	10.220
	10MHz, 16QAM			9.022	9.972
	15MHz, QPSK	75/0		13.427	14.720
	15MHz, 16QAM			13.406	14.550
	20MHz, QPSK	100/0		17.902	18.850
	20MHz, 16QAM			17.931	18.900
	20MHz, QPSK	1/0		0.2739	0.389

**5G NR n48**

Band	Mode	RB Allocation/RB Offset	f(MHz)	99% BW (MHz)	-26dB BW (MHz)
5G NR n48 (FCC)	10MHz, BPSK	24/0	3625.0	8.6044	9.643
	10MHz, QPSK			8.6318	9.648
	10MHz, 16QAM			8.5934	9.334
	15MHz, BPSK	36/0		12.869	13.770
	15MHz, QPSK			12.828	14.660
	15MHz, 16QAM			12.954	14.170
	20MHz, BPSK	50/0		17.795	18.700
	20MHz, QPSK			17.898	19.140
	20MHz, 16QAM			17.910	18.680
	30MHz, BPSK	75/0		26.795	27.990
	30MHz, QPSK			26.827	27.910
	30MHz, 16QAM			26.895	28.620
	40MHz, BPSK	100/0		35.681	37.910
	40MHz, QPSK			35.695	37.680
	40MHz, 16QAM			35.737	37.590
	40MHz, BPSK	1/0		0.4781	0.750

**LTE BAND 66**

Band	Mode	RB Allocation/RB Offset	f(MHz)	99% BW (MHz)	-26dB BW (MHz)
LTE BAND 66	1.4MHz, QPSK	6/0	1745.0	1.0884	1.340
	1.4MHz, 16QAM			1.0906	1.320
	3MHz, QPSK	15/0		2.6878	2.997
	3MHz, 16QAM			2.6987	3.063
	5MHz, QPSK	25/0		4.5017	5.337
	5MHz, 16QAM			4.4995	5.287
	10MHz, QPSK	50/0		8.9943	10.300
	10MHz, 16QAM			8.9783	10.310
	15MHz, QPSK	75/0		13.453	15.220
	15MHz, 16QAM			13.480	15.140
	20MHz, QPSK	100/0		17.928	19.900
	20MHz, 16QAM			17.913	19.780
	20MHz, QPSK	1/0		0.2449	0.3780

**5G NR n66**

Band	Mode	RB Allocation/RB Offset	f(MHz)	99% BW (MHz)	-26dB BW (MHz)
5G NR n66	5MHz, BPSK	25/0	1745.0	4.5015	5.227
	5MHz, QPSK			4.5031	5.229
	5MHz, 16QAM			4.5135	5.336
	10MHz, BPSK	50/0		8.9816	9.976
	10MHz, QPSK			8.9934	9.971
	10MHz, 16QAM			8.9617	9.930
	15MHz, BPSK	75/0		13.470	14.600
	15MHz, QPSK			13.452	14.490
	15MHz, 16QAM			13.441	14.510
	20MHz, BPSK	100/0		17.896	19.120
	20MHz, QPSK			17.904	19.300
	20MHz, 16QAM			17.857	19.120
	25MHz, BPSK	128/0		22.951	24.840
	25MHz, QPSK			22.952	24.920
	25MHz, 16QAM			23.029	25.090
	30MHz, BPSK	160/0		28.688	32.100
	30MHz, QPSK			28.714	31.980
	30MHz, 16QAM			28.718	31.930
	40MHz, BPSK	216/0		38.698	42.170
	40MHz, QPSK			38.735	42.730
40MHz, 16QAM	38.647		42.580		
40MHz, BPSK	1/0	0.2480	0.477		

**5G NR n70**

Band	Mode	RB Allocation/RB Offset	f(MHz)	99% BW (MHz)	-26dB BW (MHz)
5G NR n70	5MHz, BPSK	25/0	1702.5	4.4911	5.213
	5MHz, QPSK			4.5049	5.244
	5MHz, 16QAM			4.4965	5.182
	10MHz, BPSK	50/0		8.9834	9.980
	10MHz, QPSK			8.9873	9.913
	10MHz, 16QAM			8.9893	9.903
	15MHz, BPSK	75/0		13.442	14.500
	15MHz, QPSK			13.422	14.500
	15MHz, 16QAM			13.405	14.560
	15MHz, BPSK	1/0		0.2337	0.371

**LTE BAND 71**

Band	Mode	RB Allocation/RB Offset	f(MHz)	99% BW (MHz)	-26dB BW (MHz)
LTE BAND 71	5MHz, QPSK	25/0	680.5	4.5114	5.275
	5MHz, 16QAM			4.5115	5.231
	10MHz, QPSK	50/0		8.9832	10.480
	10MHz, 16QAM			8.9973	10.300
	15MHz, QPSK	75/0		13.479	15.240
	15MHz, 16QAM			13.447	15.300
	20MHz, QPSK	100/0		17.905	19.860
	20MHz, 16QAM			17.905	19.880
	20MHz, QPSK	1/0		0.2706	0.480

**5G NR n71**

Band	Mode	RB Allocation/RB Offset	f(MHz)	99% BW (MHz)	-26dB BW (MHz)
5G NR n71	5MHz, BPSK	25/0	680.5	4.4827	5.181
	5MHz, QPSK			4.5076	5.385
	5MHz, 16QAM			4.4791	5.132
	10MHz, BPSK	50/0		8.9561	9.859
	10MHz, QPSK			8.9974	10.010
	10MHz, 16QAM			8.9497	9.803
	15MHz, BPSK	75/0		13.467	14.530
	15MHz, QPSK			13.438	14.570
	15MHz, 16QAM			13.450	14.570
	20MHz, BPSK	100/0		17.907	19.080
	20MHz, QPSK			17.863	19.150
	20MHz, 16QAM			17.861	19.010
	20MHz, BPSK	1/0		0.2393	0.384

**5G NR n77(Part 27 3450-3550MHz) HPUE**

Band	Mode	RB Allocation/RB Offset	f(MHz)	99% BW (MHz)	-26dB BW (MHz)
5G NR n77 (Part 27 3450-3550MHz)	10MHz, BPSK	24/0	3500.0	8.6790	10.16
	10MHz, QPSK			8.6371	10.33
	10MHz, 16QAM			8.6390	10.14
	15MHz, BPSK	36/0		12.925	14.75
	15MHz, QPSK			12.903	14.61
	15MHz, 16QAM			12.924	14.75
	20MHz, BPSK	50/0		17.957	19.77
	20MHz, QPSK			17.879	19.80
	20MHz, 16QAM			17.937	19.71
	25MHz, BPSK	64/0		22.982	24.05
	25MHz, QPSK			23.014	25.41
	25MHz, 16QAM			23.092	24.60
	30MHz, BPSK	75/0		26.883	28.98
	30MHz, QPSK			26.860	29.25
	30MHz, 16QAM			26.905	29.10
	40MHz, BPSK	100/0		35.769	38.27
	40MHz, QPSK			35.816	38.62
	40MHz, 16QAM			35.819	38.52
	50MHz, BPSK	128/0		45.874	49.45
	50MHz, QPSK			45.850	49.72
	50MHz, 16QAM			45.756	49.74
	60MHz, BPSK	162/0		58.008	64.36
	60MHz, QPSK			57.990	64.05
	60MHz, 16QAM			58.014	65.64
	70MHz, BPSK	180/0		64.487	71.29
	70MHz, QPSK			64.474	71.36
	70MHz, 16QAM			64.411	70.81
	80MHz, BPSK	216/0		77.476	85.09
	80MHz, QPSK			77.354	83.58
	80MHz, 16QAM			77.163	84.57
90MHz, BPSK	243/0	85.868	92.94		
90MHz, QPSK		85.825	93.08		
90MHz, 16QAM		85.634	93.02		
100MHz, BPSK	270/0	96.681	105.3		
100MHz, QPSK		96.767	105.2		
100MHz, 16QAM		96.709	104.5		
100MHz, BPSK	1/0	0.5956	0.835		

**5G NR n77(Part 27 3700-3980MHz) HPUE**

Band	Mode	RB Allocation/RB Offset	f(MHz)	99% BW (MHz)	-26dB BW (MHz)
5G NR n77 (FCC Part 27 3700- 3980MHz)	10MHz, BPSK	24/0	3840.0	8.5569	10.08
	10MHz, QPSK			8.6371	9.271
	10MHz, 16QAM			8.6334	9.598
	15MHz, BPSK	36/0		12.808	14.26
	15MHz, QPSK			12.895	13.64
	15MHz, 16QAM			12.822	13.54
	20MHz, BPSK	50/0		17.894	18.87
	20MHz, QPSK			17.842	19.04
	20MHz, 16QAM			17.793	18.58
	25MHz, BPSK	64/0		22.946	25.00
	25MHz, QPSK			22.951	24.45
	25MHz, 16QAM			22.862	23.98
	30MHz, BPSK	75/0		26.703	28.16
	30MHz, QPSK			26.745	28.30
	30MHz, 16QAM			26.805	28.77
	40MHz, BPSK	100/0		35.817	37.61
	40MHz, QPSK			35.881	37.38
	40MHz, 16QAM			35.459	37.24
	50MHz, BPSK	128/0		45.839	47.74
	50MHz, QPSK			45.692	48.33
	50MHz, 16QAM			45.810	49.31
	60MHz, BPSK	162/0		57.435	61.19
	60MHz, QPSK			57.684	62.88
	60MHz, 16QAM			57.913	61.75
	70MHz, BPSK	180/0		64.083	68.89
	70MHz, QPSK			64.437	69.22
	70MHz, 16QAM			64.443	69.14
	80MHz, BPSK	216/0		77.131	82.12
	80MHz, QPSK			77.092	85.13
	80MHz, 16QAM			76.849	80.62
90MHz, BPSK	243/0	87.056	92.53		
90MHz, QPSK		86.563	92.36		
90MHz, 16QAM		86.583	90.75		
100MHz, BPSK	270/0	96.646	101.1		
100MHz, QPSK		96.018	102.2		
100MHz, 16QAM		96.214	101.0		
100MHz, BPSK	1/0	0.6920	1.053		

### 9.1.1. LTE BAND 5 AND 5G NR n5

#### LTE BAND 5

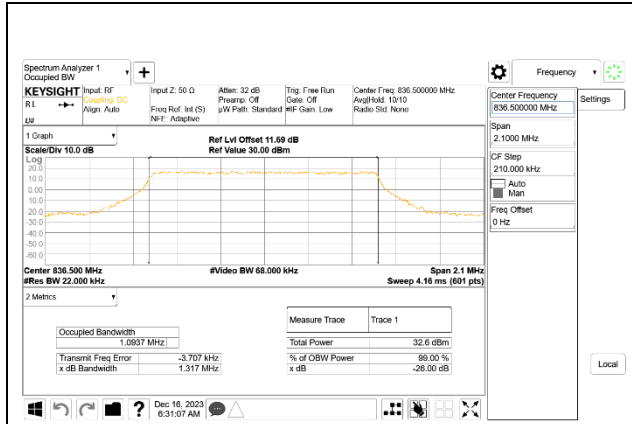

LTE B5 1.4MHz QPSK Middle Channel RB6-0, ID:27979

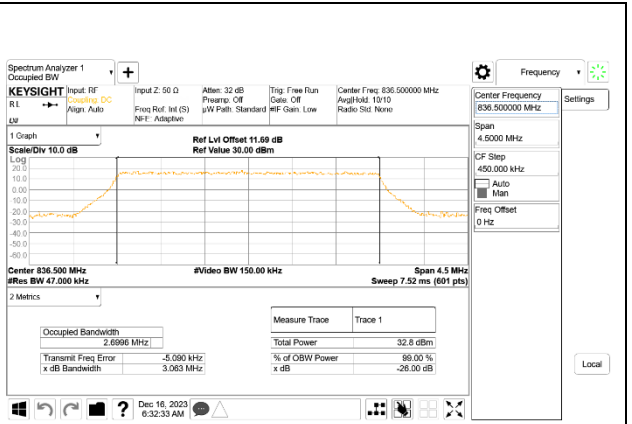

LTE B5 3MHz QPSK Middle Channel RB15-0, ID:27979

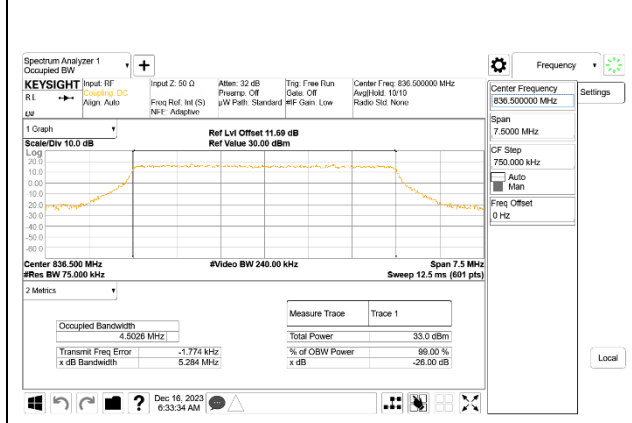

LTE B2 5MHz QPSK Middle Channel RB25-0, ID:27979

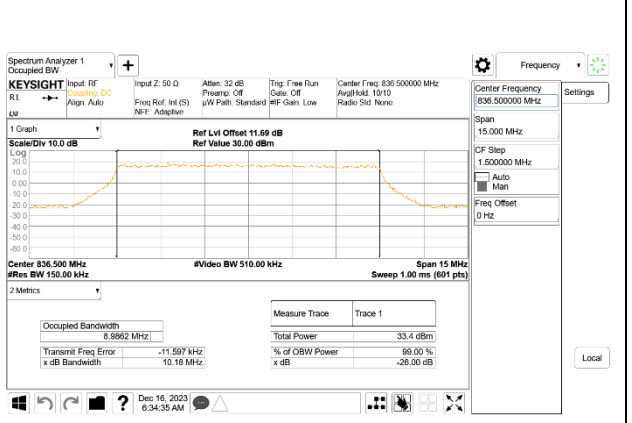

LTE B5 10MHz QPSK Middle Channel RB50-0, ID:27979

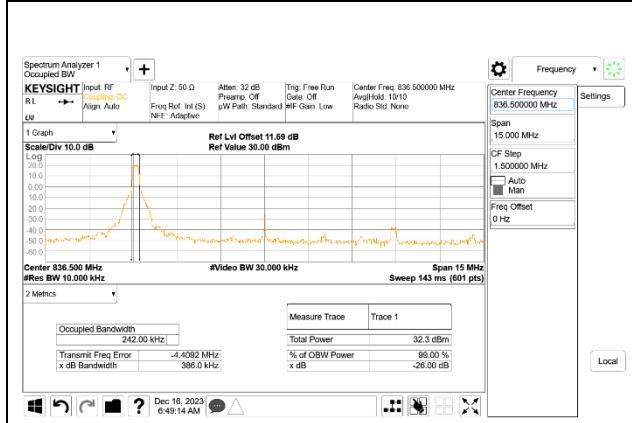

LTE B5 10MHz QPSK Middle Channel RB1-0, ID:27979

Intentionally Blank

5G NR n5

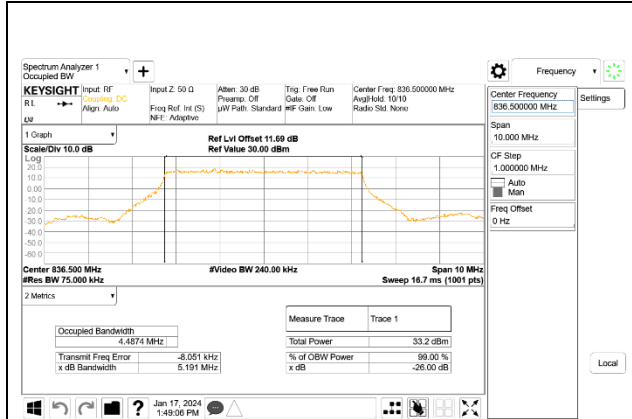

5G NR n5 5MHz BPSK Middle Channel RB25-0, ID:27966

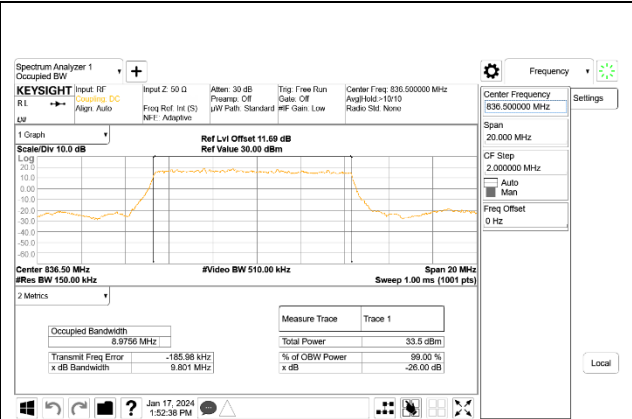

5G NR n5 10MHz BPSK Middle Channel RB50-0, ID:27966

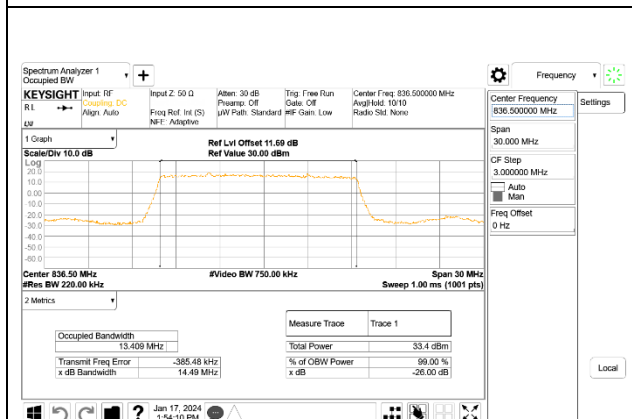

5G NR n5 15MHz BPSK Middle Channel RB75-0, ID:27966

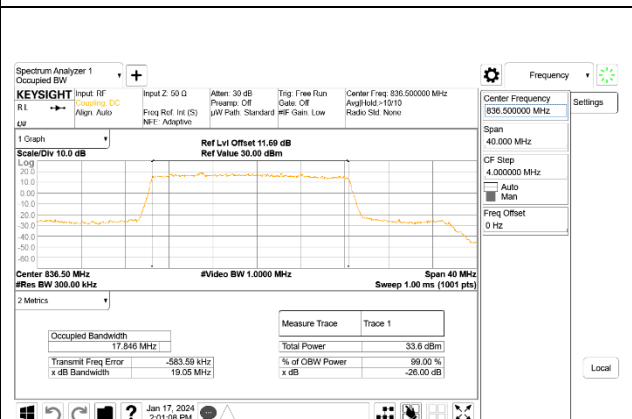

5G NR n5 20MHz BPSK Middle Channel RB100-0, ID:27966

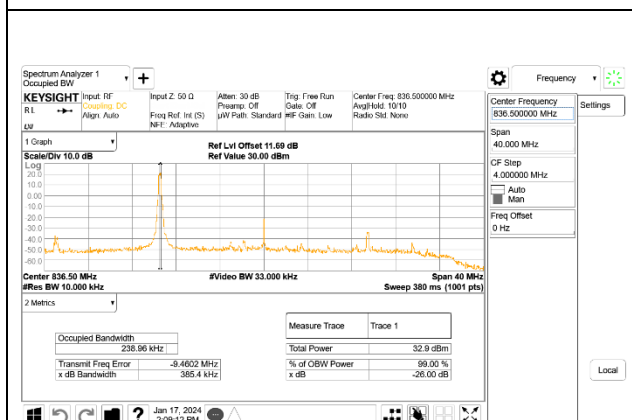

5G NR n5 20MHz BPSK Middle Channel RB1-0, ID:27966

Intentionally Blank

### 9.1.2. LTE BAND 7 AND 5G NR n7

#### LTE BAND 7

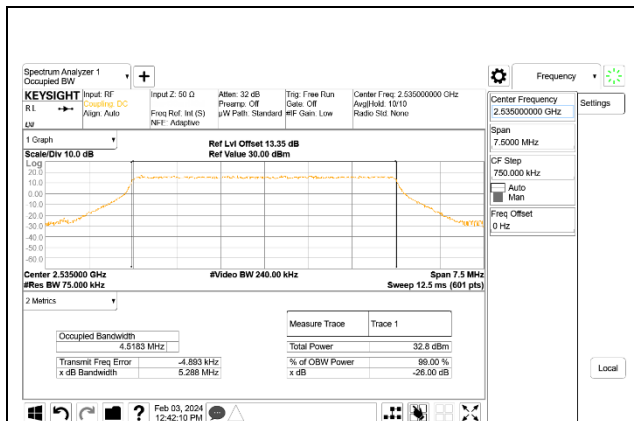

LTE B7 5MHz QPSK Middle Channel RB25-0, ID:39005

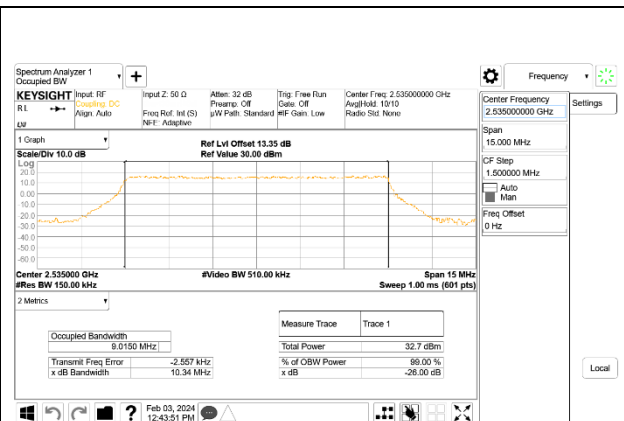

LTE B7 10MHz QPSK Middle Channel RB50-0, ID:39005

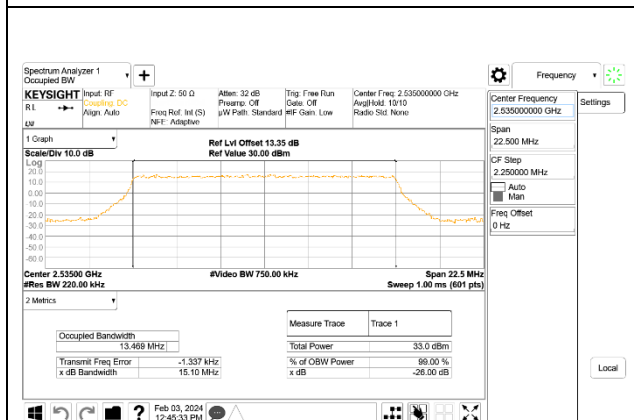

LTE B7 15MHz QPSK Middle Channel RB75-0, ID:39005

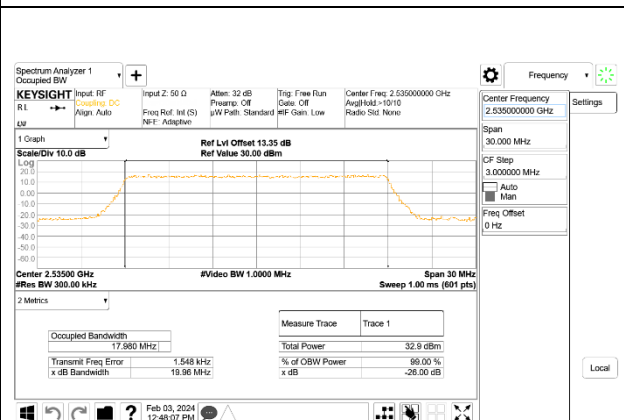

LTE B7 20MHz QPSK Middle Channel RB100-0, ID:39005

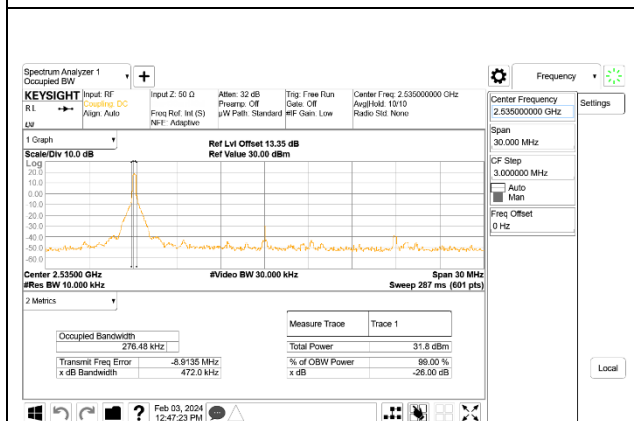

LTE B7 20MHz QPSK Middle Channel RB1-0, ID:39005

Intentionally Blank



5G NR n7

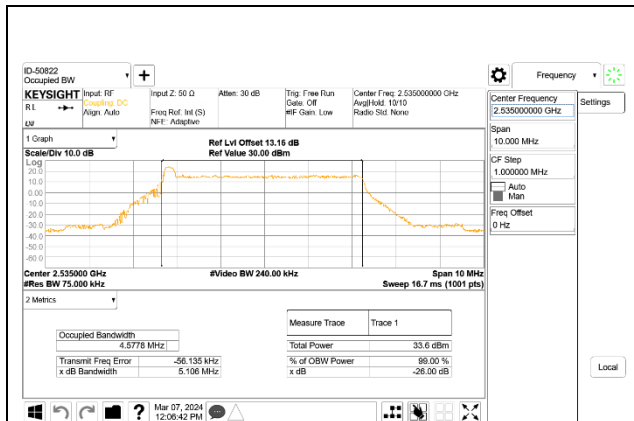

5G NR n7 5MHz BPSK Middle Channel RB25-0, ID:50822

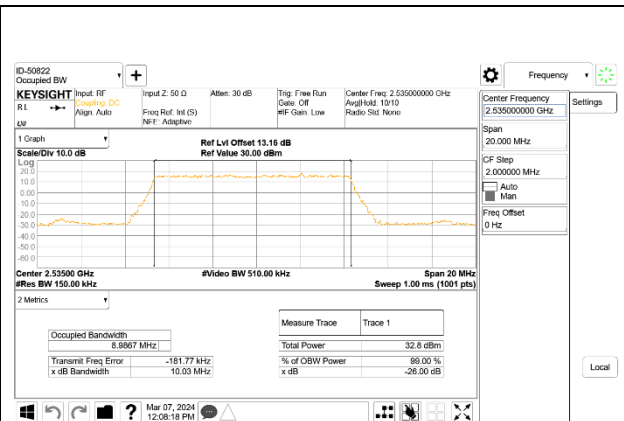

5G NR n7 10MHz BPSK Middle Channel RB50-0, ID:50822

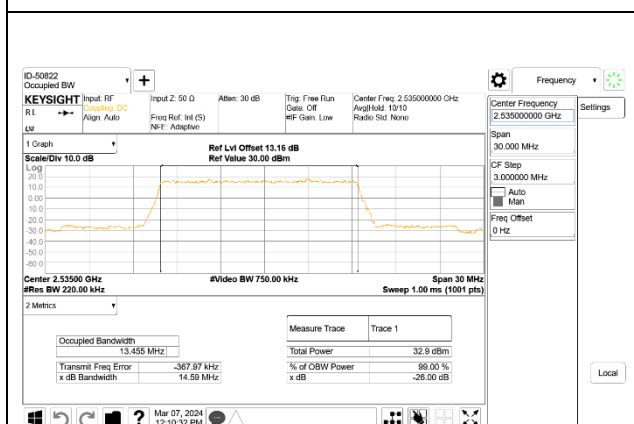

5G NR n7 15MHz BPSK Middle Channel RB75-0, ID:50822

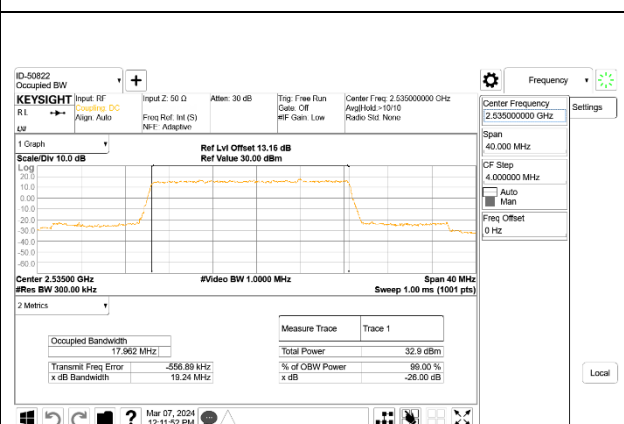

5G NR n7 20MHz BPSK Middle Channel RB100-0, ID:50822

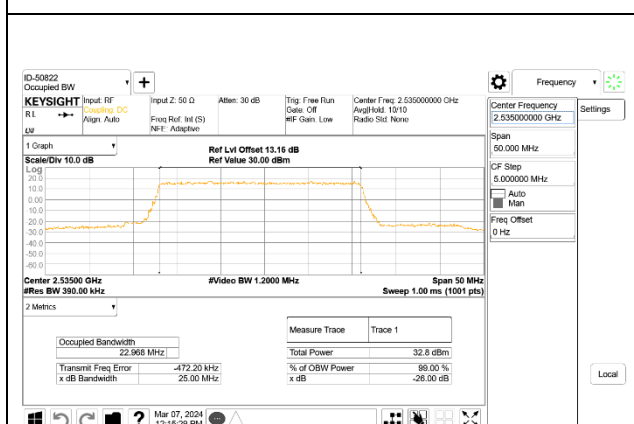

5G NR n7 25MHz BPSK Middle Channel RB128-0, ID:50822

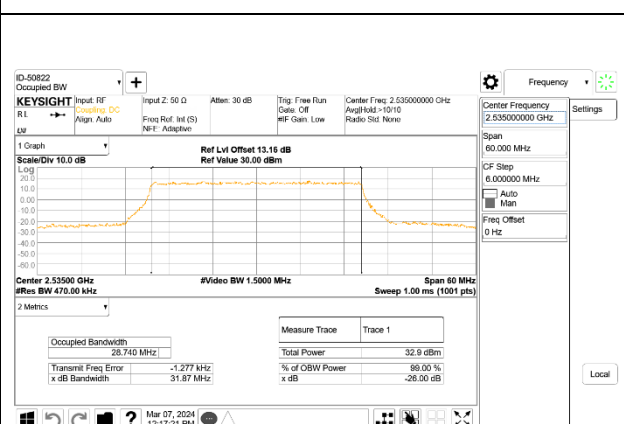

5G NR n7 30MHz BPSK Middle Channel RB160-0, ID:50822

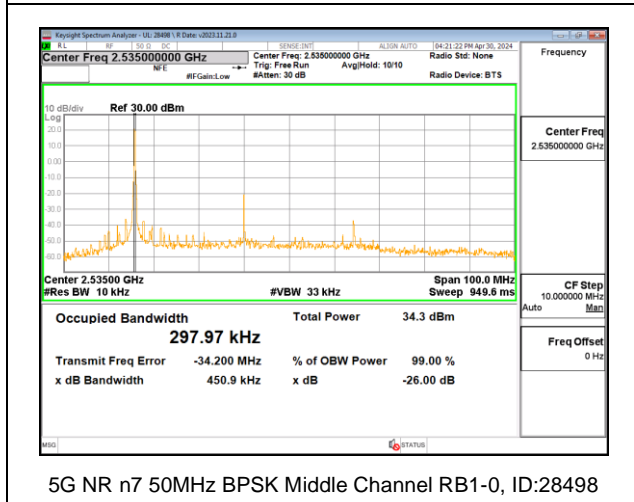
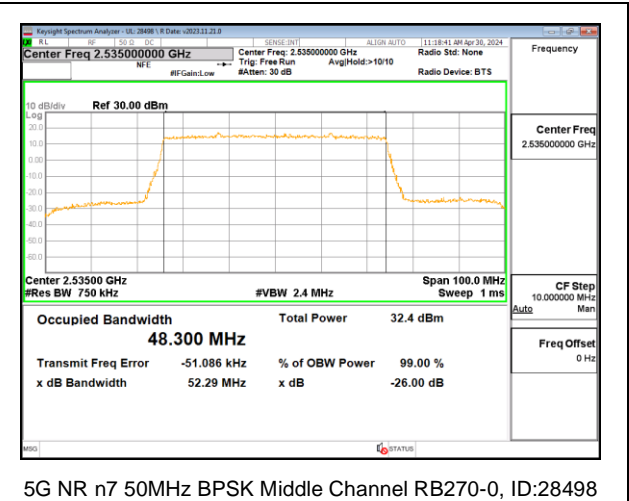
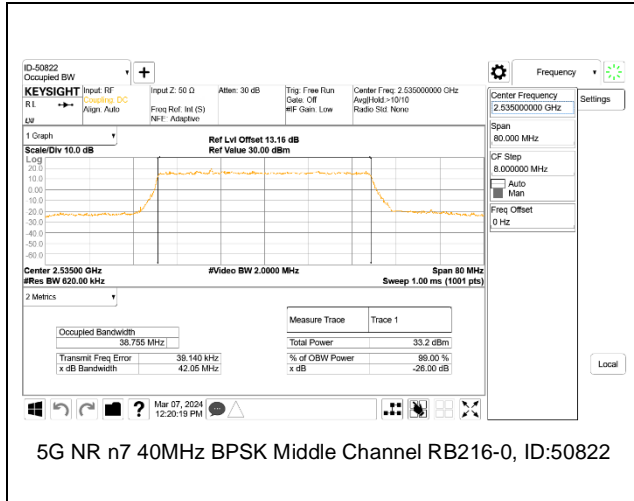

Intentionally Blank

### 9.1.3. LTE BAND 12 AND 5G NR n12

#### LTE BAND 12

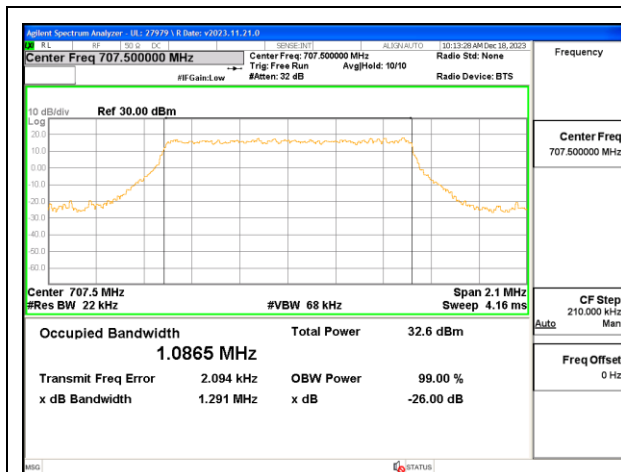

LTE B12 1.4MHz QPSK Middle Channel RB6-0

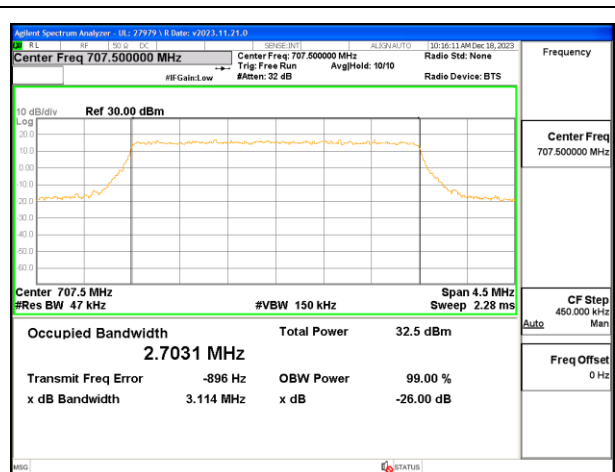

LTE B12 3MHz QPSK Middle Channel RB15-0

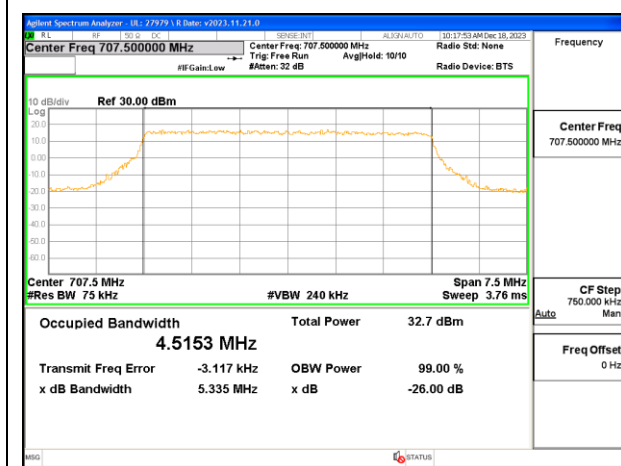

LTE B12 5MHz QPSK Middle Channel RB25-0

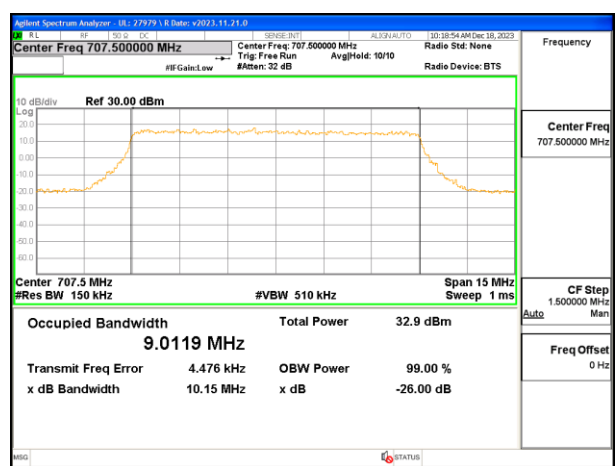

LTE B12 10MHz QPSK Middle Channel RB50-0

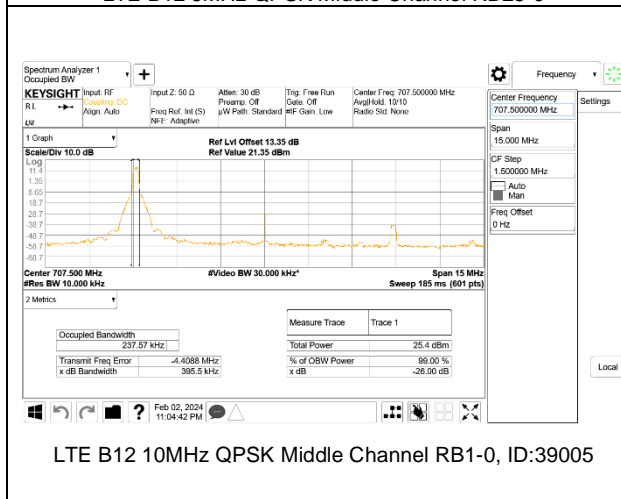

LTE B12 10MHz QPSK Middle Channel RB1-0, ID:39005

Intentionally Blank

**5G NR n12**

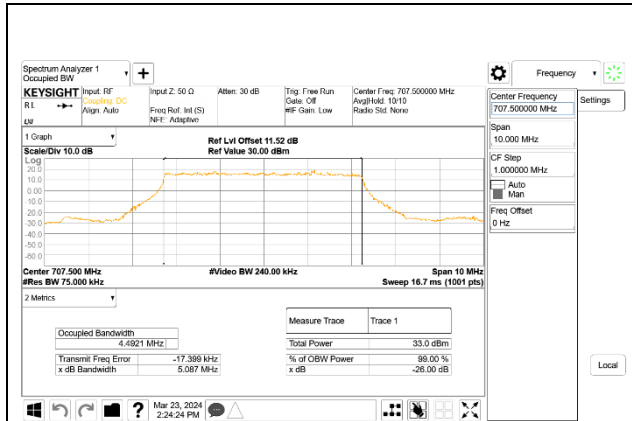

5G NR n12 5MHz BPSK Middle Channel RB25-0, ID:50822

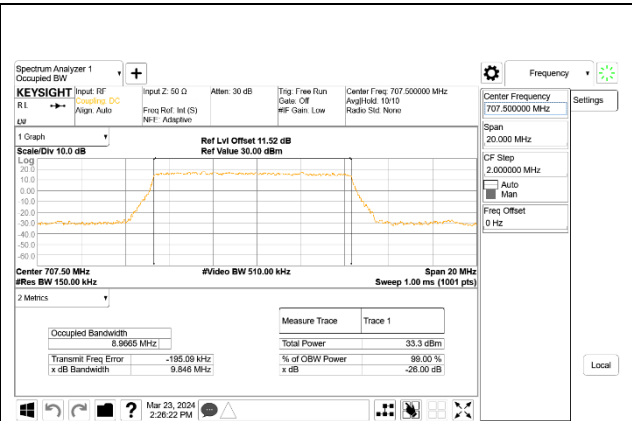

5G NR n12 10MHz BPSK Middle Channel RB50-0, ID:50822

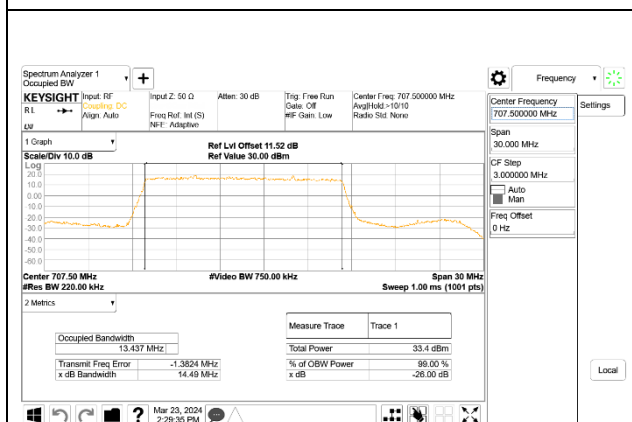

5G NR n12 15MHz BPSK Middle Channel RB75-0, ID:50822

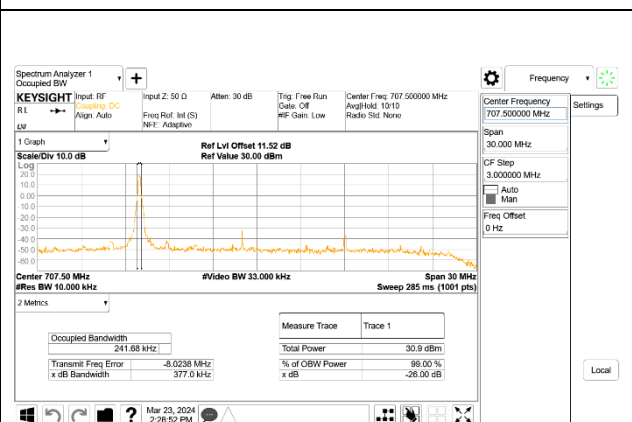

5G NR n12 15MHz BPSK Middle Channel RB1-0, ID:50822

9.1.4. LTE BAND 13

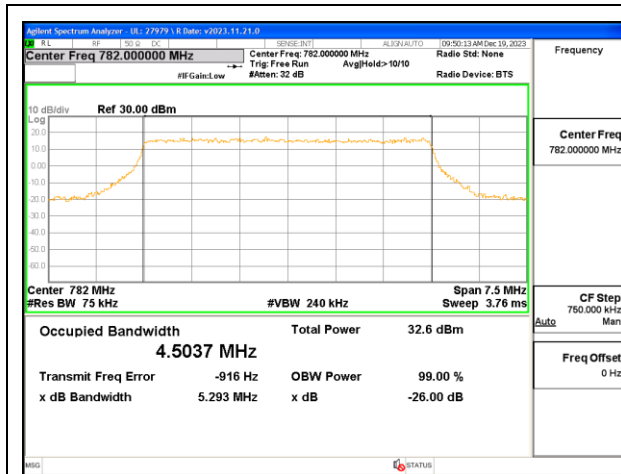

LTE B13 5MHz QPSK Middle Channel RB25-0

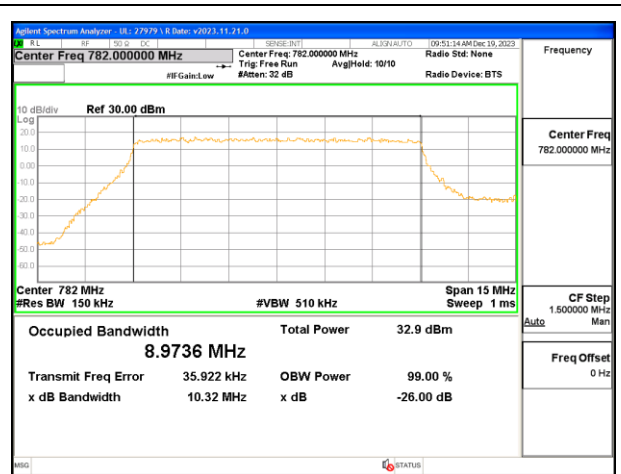

LTE B13 10MHz QPSK Middle Channel RB50-0

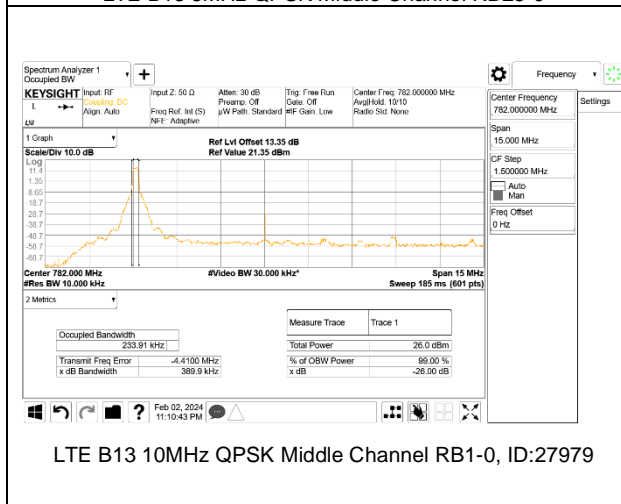

LTE B13 10MHz QPSK Middle Channel RB1-0, ID:27979

Intentionally Blank

### 9.1.5. LTE BAND 14 AND 5G NR n14

#### LTE BAND 14

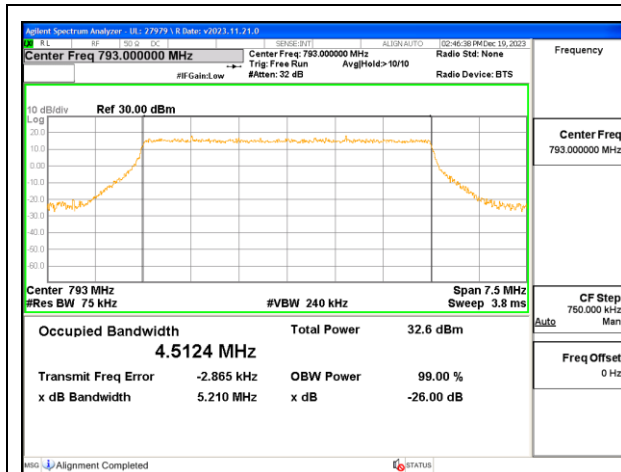

LTE B14 5MHz QPSK Middle Channel RB25-0

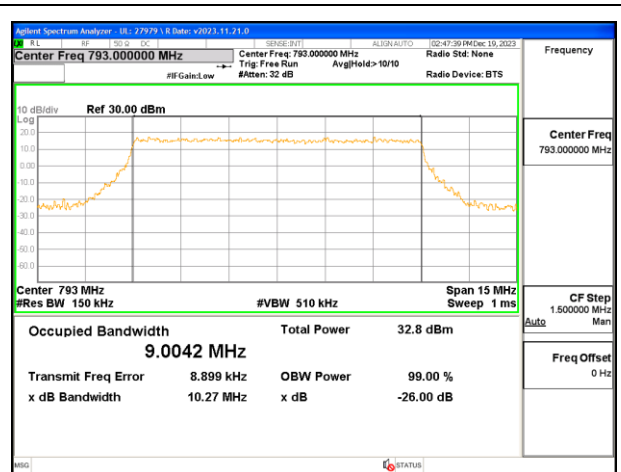

LTE B14 10MHz QPSK Middle Channel RB50-0

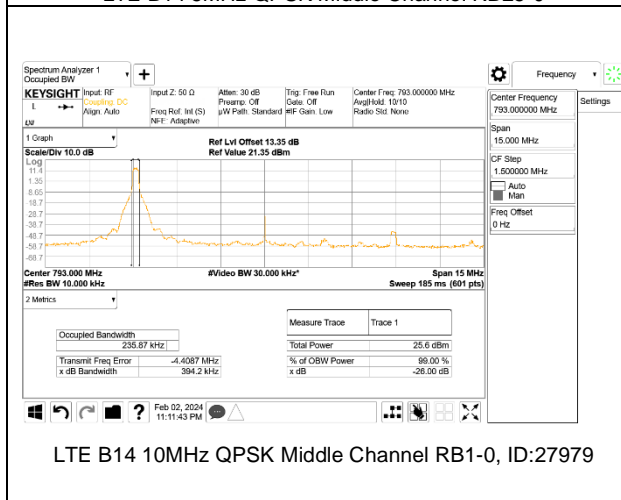

LTE B14 10MHz QPSK Middle Channel RB1-0, ID:27979

Intentionally Blank

**5G NR n14**

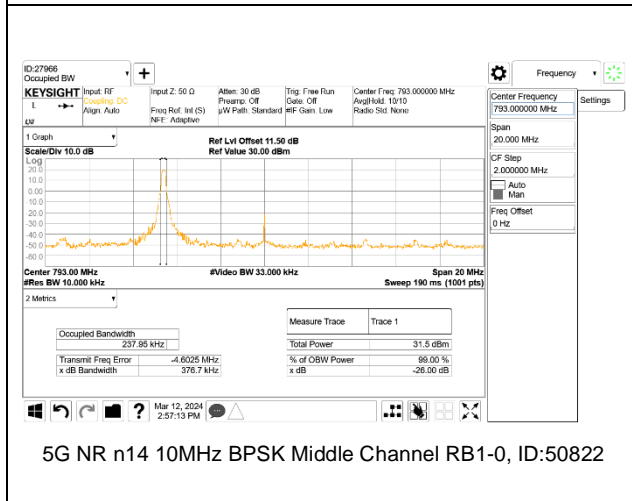
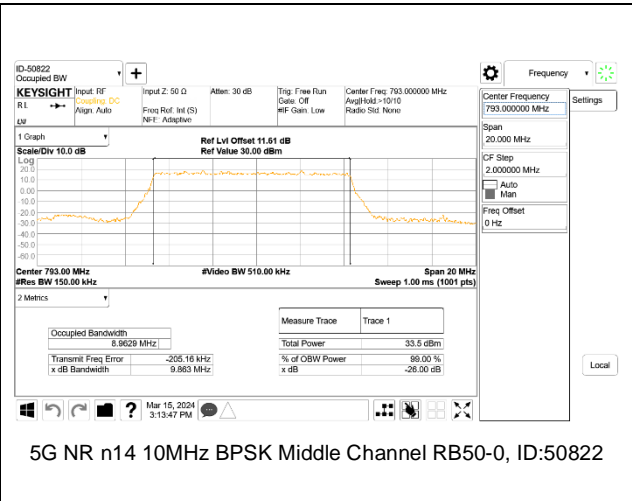
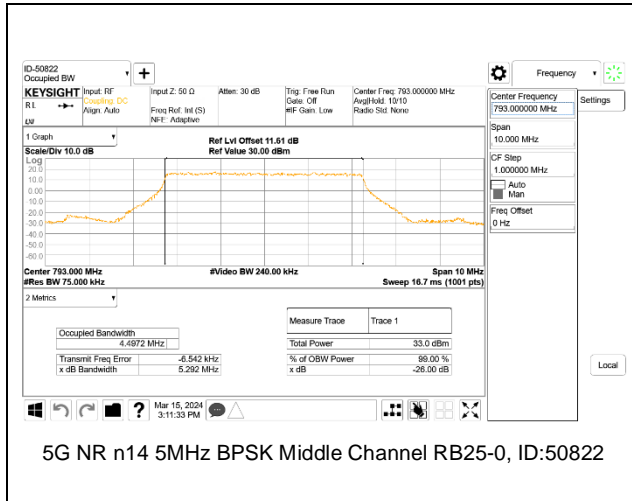

Intentionally Blank

9.1.6. LTE BAND 17

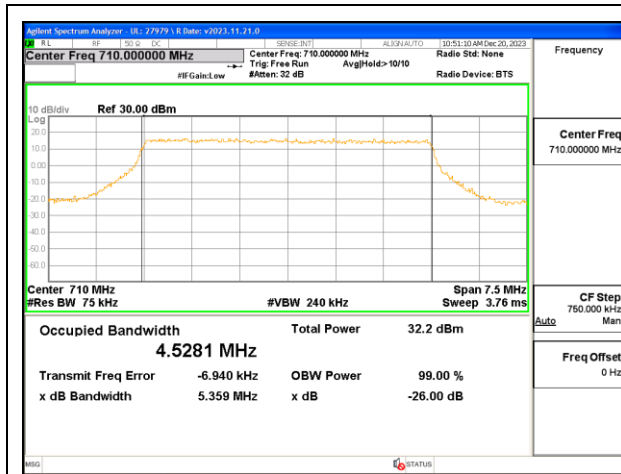

LTE B17 5MHz QPSK Middle Channel RB25-0

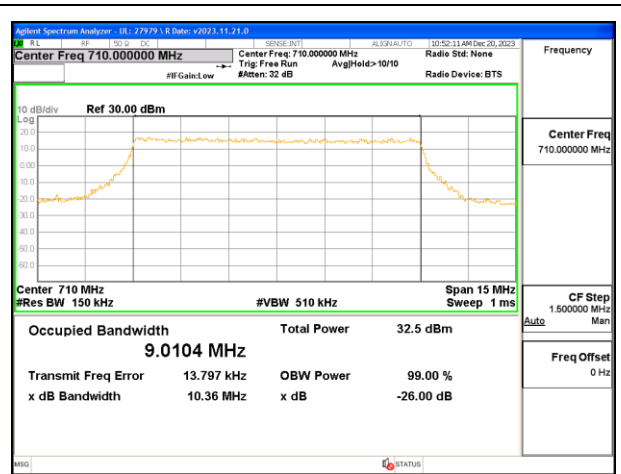

LTE B17 10MHz QPSK Middle Channel RB50-0

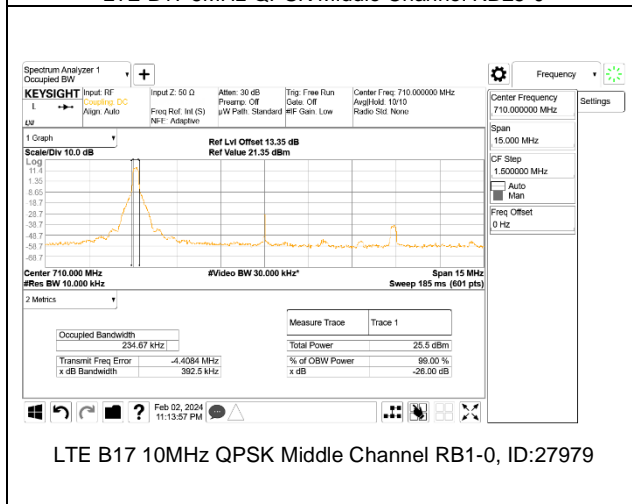

LTE B17 10MHz QPSK Middle Channel RB1-0, ID:27979

Intentionally Blank



### 9.1.7. LTE BAND 25 AND 5G NR n25

#### LTE BAND 25



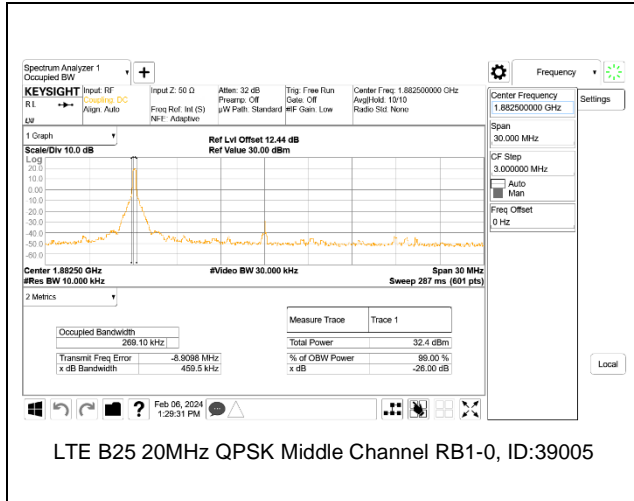

Intentionally Blank

**5G NR n25**

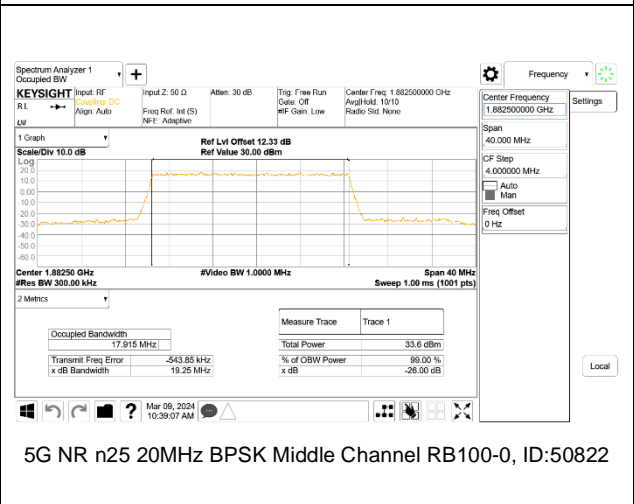
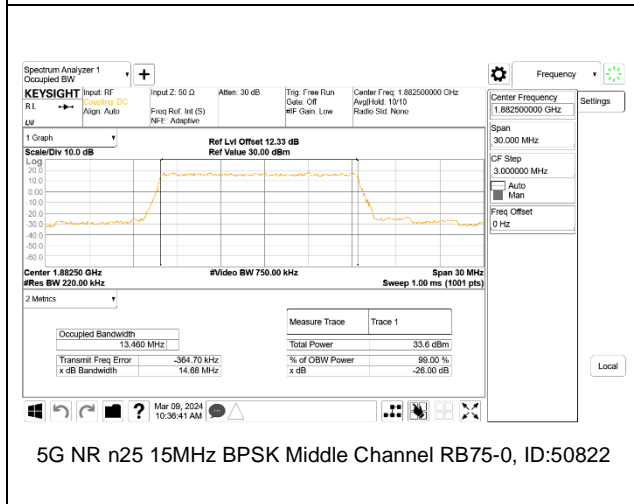
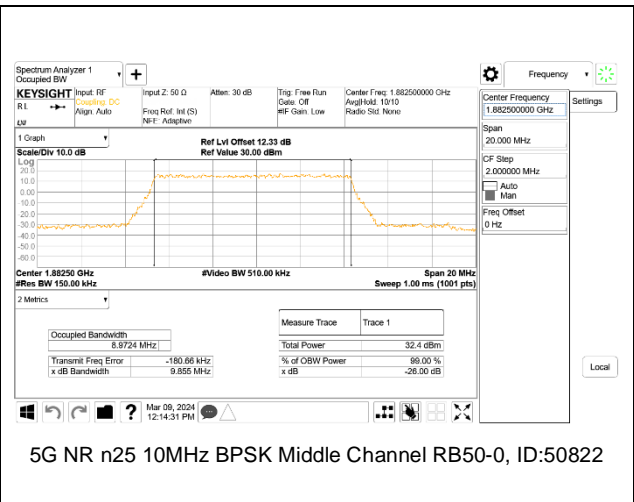
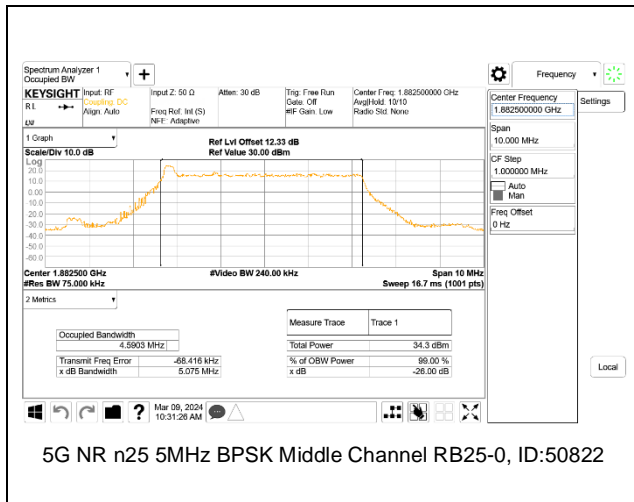

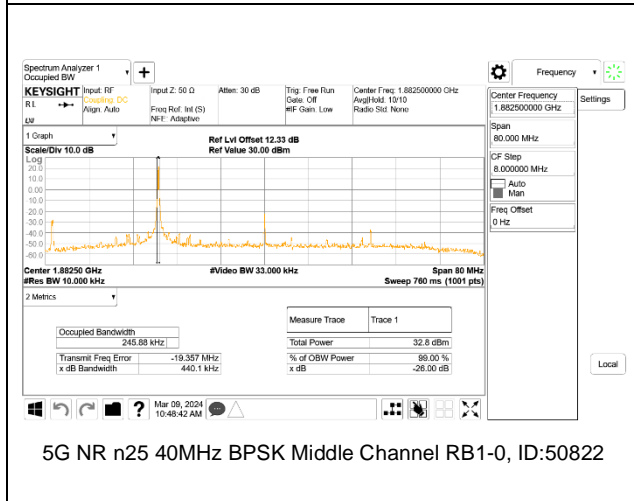
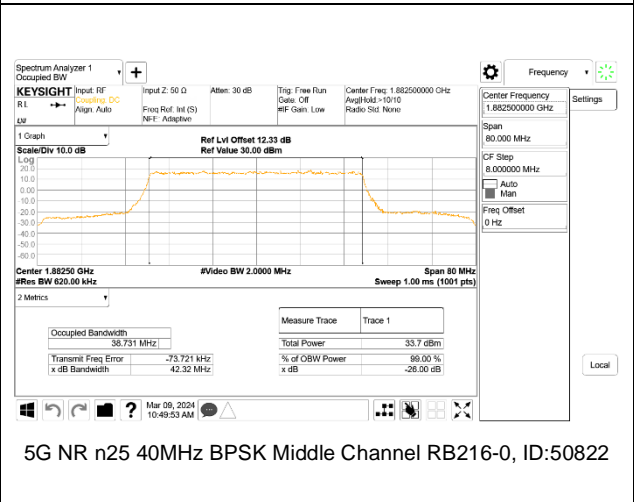
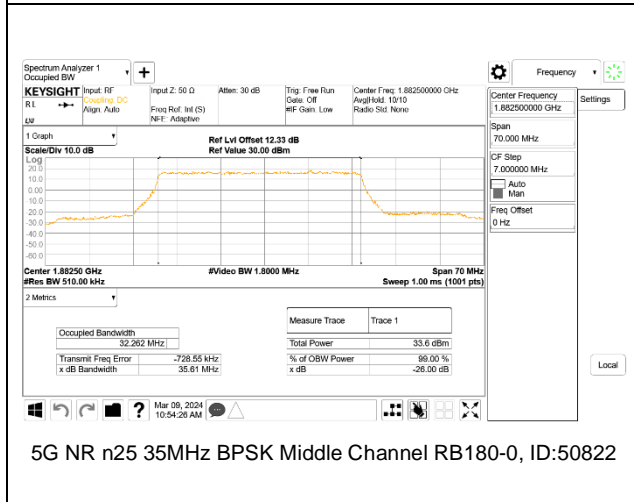
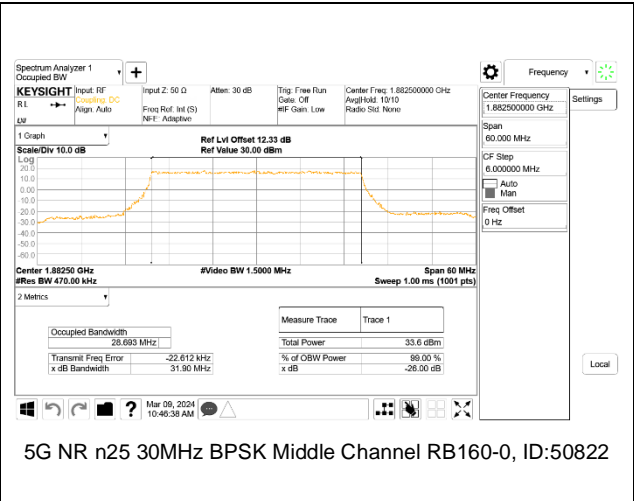
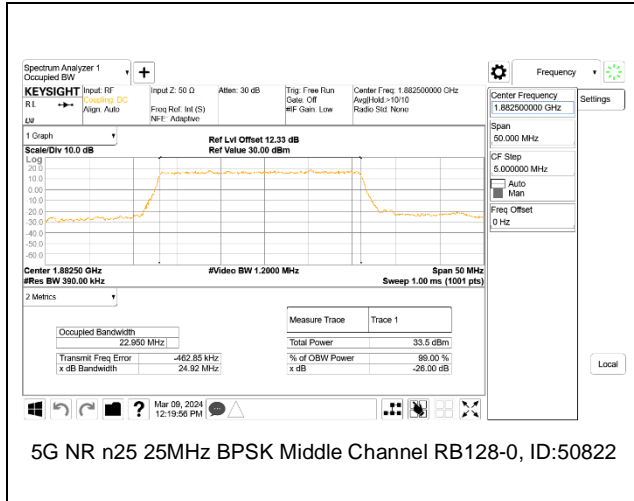

Intentionally Blank