



FCC TAS validation – Part 2: Tests under dynamic transmit power scenarios

FCC ID : A4RG2YBB
Equipment : Phone
Model Name : G2YBB
Applicant : Google LLC
1600 Amphitheatre Parkway,
Mountain View, California, 94043 USA
Standard : FCC 47 CFR Part 2 (2.1093)

The product was received on Mar. 08, 2024 and testing was started from Apr. 19, 2024 and completed on Apr. 23, 2024. We, SPORTON INTERNATIONAL INC., would like to declare that the tested sample provide by manufacturer and the test data has been evaluated in accordance with the test procedures given in 47 CFR Part 2.1093 and FCC KDB and has been pass the FCC requirement.

The test results in this report apply exclusively to the tested model / sample. Without written approval of SPORTON INTERNATIONAL INC. EMC & Wireless Communications Laboratory, the test report shall not be reproduced except in full.

Approved by: Cona Huang / Deputy Manager

Sporton International Inc. EMC & Wireless Communications Laboratory
No.52, Huaya 1st Rd., Guishan Dist., Taoyuan City 333, Taiwan



Table of Contents

1. Introduction 4
2. Tx Varying Transmission Test Cases and Test Proposal 4
3. SAR Time Averaging Validation Test Procedures 6
3.1 Test sequence determination for validation 6
3.2 Test configuration selection criteria for validating TAS 6
3.3 Test procedures for conducted power measurements 7
4. Spatial TAS 12
5. PD Time Averaging Validation Test Procedures 14
5.1 Test sequence determination for validation 14
5.2 Test configuration selection criteria for validating TAS 14
5.3 Test procedures for FR2 radiated power measurements 15
6. Test Configurations 21
6.1 WWAN (sub-6) transmission 21
6.2 Test case list for sub-6GHz transmissions 26
6.3 Test case list for LTE+FR2 transmissions 26
7. Conducted Power Test Results for Sub-6 TAS validation 27
7.1 Measurement set-up 27
7.2 Measured Plimit and Pmax 28
7.2.1 Sub-6 summary test results 29
7.3 Time-varying Tx power measurement results 30
7.4 Change operate states 54
7.5 LTE Handover WCDMA results 56
7.6 Change in call test results 58
7.7 Switch in SAR exposure test results 60
7.8 Re-selection in call test results 62
7.9 LTE Uplink CA 64
8. FR2 Radiated power Test Results for TAS validation 66
8.1 Measurement setup 66
8.2 Time-varying Tx power measurement results 68
8.3 SAR vs. PD exposure switch 70
8.4 FR2 beam change 72
9. Conclusions 74
10. Annex 74
10.1 Test sequence is generated based on below parameters of the DUT: 74
10.2 Test Sequence A waveform: 74
10.3 Test Sequence B waveform: 75
11. Test Equipment List 76

Appendix A. Test Setup Photos



History of this test report

Report No.	Version	Description	Issued Date
FA3N2327B	01	Initial issue of report	Apr. 30, 2024



1. Introduction

This purpose of this Part 2 report is to demonstrate that the DUT complies with FCC RF exposure compliance requirement under varying Tx power transmission scenarios, thus validating the Samsung S.LSI TAS algorithm feature for FCC equipment authorization of the handset.

The values of P_{limit} used in this report per scenario are determined in Part 0 report.

2. Tx Varying Transmission Test Cases and Test Proposal

The following scenarios are covered in this report to demonstrate compliance with FCC RF exposure in Tx varying transmission conditions.

1. During a time-varying Tx power transmission – to prove that TAS feature accounts for Tx power variations in time accurately.
2. During a call disconnect and re-establish scenario – to prove that the TAS feature accounts for history of Tx power from past accurately
3. During a technology/band handover – to prove that TAS feature accounts for history across transitions in band/technology
4. During operating state change – to prove that TAS feature functions correctly to meet compliance limits across operate state changes
5. During time averaging window change – to prove that TAS feature properly handles the change from one time averaging window to another as specified by FCC, and meets the normalized FCC limit of 1.0 at all time

As described in Part 0, the RF exposure is proportional to the Tx power for both FR1 and FR2. Thus, we rely on conducted power measurements (FR1) and radiated power measurements (FR2) in each dynamic case to demonstrate that overall RF exposure is within the FCC limit.

The overall procedure for validating the test is summarized below:

1. Measure conducted power (FR1) over time , denoted as $TxPower(t)$, and radiated power EIRP (FR2) over time, denoted $EIRP(t)$, with time index t
2. Convert measured powers to RF exposure values using linear relationship shown below. In below expression, $P_{limit,sub-6}$ would be the measured power at which FR1 technology meets measured SAR level of SAR_design_target as described in Part 0. Similarly, $P_{limit,2}$ would be the measured EIRP at which FR2 technology meets measured PD level of PD_design_target as described in Part 0.

$$SAR (t) = \frac{TxPower(t)}{P_{limit,sub-6}} * SAR_design_target \tag{2.1.1}$$

$$PD (t) = \frac{EIRP(t)}{P_{limit,FR2}} * PD_design_target \tag{2.1.2}$$

3. Compute the average RF exposure over the most recent measurement duration which are denoted as T_{SAR} and T_{PD} for FR1 and FR2, respectively. These durations are as specified by FCC. This measurement duration interval is then given by $[t - T_{SAR} , t]$ and $[t - T_{PD} , t]$ for FR1 and FR2 respectively



- 4. Divide the RF exposure for FR1 and FR2 by corresponding FCC limits and ensure the sum denoted as TER (total exposure ratio) is less than 1 for all. The following equation describes the calculation of TER and its target constraint, *LSAR* is the number of fixed, mobile or portable RF sources using SAR-based formula and *LPD* is the number of fixed, mobile or portable RF sources using PD (MPE)-based formula.

For sub-6 transmissions only:

$$\sum_{LSAR=0}^{LSAR-1} \frac{SAR_{avr, LSAR}}{FCC SAR} \leq 1 \tag{2.1.3}$$

For sub-6 and mmWave transmission:

$$\sum_{LSAR=0}^{LSAR-1} \frac{SAR_{avr, LSAR}}{FCC SAR} + \sum_{LPD=0}^{LPD-1} \frac{PD_{avr, LPD}}{FCC PDlimit} \leq 1 \tag{2.1.4}$$

Please note that EIRP in this document is the EIRP of bore-sight direction when bore-sight beam is used. Because EIRP can vary according to beam code setting in mmWave, a certain representative metric is required. Therefore, EIRP using bore-sight code at bore-sight direction is defined as Tx EIRP in this report. And the same amount of antenna input power setting is used for other beams as well as bore-sight beam.



3. SAR Time Averaging Validation Test Procedures

Test plan and test procedure for validating Samsung SLSI TAS feature for sub-6 scenarios

3.1 Test sequence determination for validation

Two sequences for time varying Tx power are pre-defined as given below for sub-6 case.

1. Test Sequence A is generated with two power levels. One is maximum power level P_{max} and the other is lower power level. The lower power level is defined as 3dB lower value than maximum power level. At first, maximum power level is applied for 120 seconds. After this, lower power level is used until this test is finished.
2. Test Sequence B is generated at multiple power levels that are specified in the Appendix as a function of P_{max} and P_{limit} .

3.2 Test configuration selection criteria for validating TAS

This section provides general guidance for selecting test cases in TAS feature validation.

3.2.1 Test configuration selection for time-varying Tx power transmission

The Samsung S.LSI TAS algorithm is independent of band, modes or channel of any technology. Hence, we can validate using one or two combinations of band/mode/channel per technology. The criteria for selecting these would be based on the relative value of P_{limit} and P_{max} as determined in Part 0. Essentially, we need to pick this combination such that P_{limit} is less than P_{max} so that the TAS algorithm will enforce power restriction. Two bands can be selected from Part 0 with different values of P_{limit} -select one corresponding to lowest P_{limit} and another being highest but still less than P_{max} .

3.2.2 Test configuration selection for change in call

The criteria to select the technology/band for transition between call setup and call drop is to choose the one with least P_{limit} among all bands in Part 0. The test is performed with DUT requested power at P_{max} so that the Samsung S.LSI TAS feature enforces power restriction for longest duration. The call change is performed when the DUT is operating with restricted power. One such test is sufficient since behavior is not dependent on band/technology.



3.2.3 Test configuration for change in technology/band/window

FCC specifies different measurement durations for time averaging based on operating frequency. The change of operating frequency can result in change of time window for averaging, for e.g. change from 100s averaging for frequency below 3GHz to 60s averaging for frequency above 3-6 GHz, however Samsung S.LSI TAS will use 60sec only for all bands regardless of frequency, because 60s averaging provides more conservative and strict SAR management, TAS feature met the regulatory conditions with 100s averaging will meet the same regulatory condition with more margin if 60s averaging is applied. Therefore 100s to 60s TAS validation is not required.

3.3 Test procedures for conducted power measurements

This section provides general conducted power measurement procedures to perform compliance test under dynamic scenarios described in Section 2.

3.3.1 Time-varying Tx power transmission scenario

This test is performed with two pre-defined test sequences as described in Section 3.1 for all technologies operating on sub-6GHz applying to both LTE and NR as selected in Section 3.2.1. The purpose of the test is to demonstrate the maximum power limiting enforcement and that the time-averaged SAR does not exceed the FCC limit at all times.

3.3.1.1 Test procedure

1. Using the Pmax and Plimit obtained in Part 0/1, generate the test sequence of power levels for each selected technology/band. Both test sequences A and B are generated. Maximum power can be changed according to DUT test results.
2. Establish the connection of the DUT to the call box in the selected RAT, with the call box requesting the DUT Tx power to be according to the sequence determined in Step 1. An initial value of Tx power will be set to 0dBm for 100s before the desired test sequence starts to help with post-processing of the time-average value with the very first value in the sequence. This is illustrated in the figure below

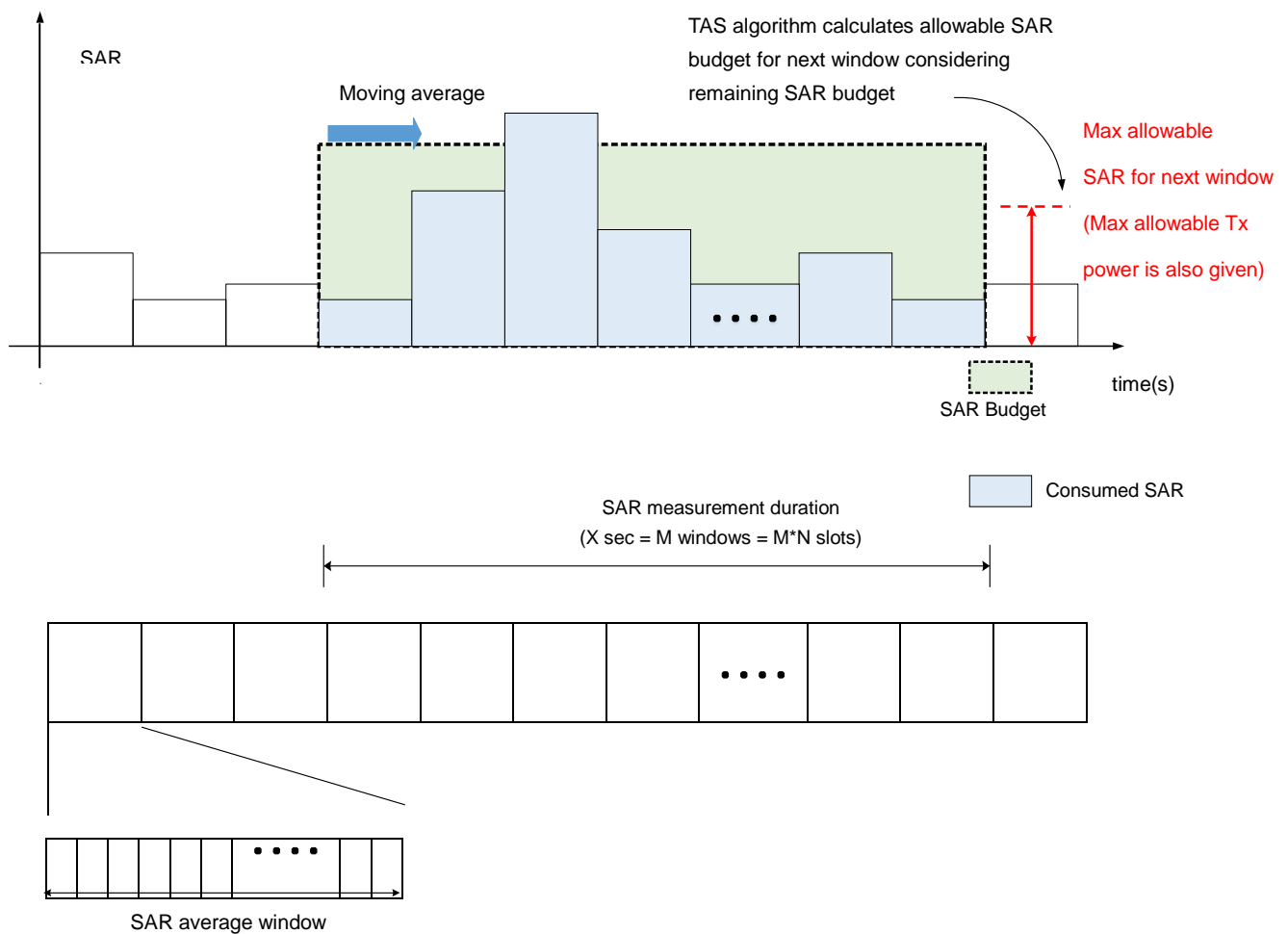

Average SAR value in a slot can be calculated from average Tx power in the slot
 (Assume that SAR vs Tx power relation is obtained from real measurement)

Figure 3.3-1 SAR measurement from Tx power using block-wise processing

3. Release connection.
4. After the completion of the test, prepare one plot with the following information:
 - a. Instantaneous Tx power versus time measured in Step 2
 - b. Requested Tx power versus time used in Step 2
 - c. Time-averaged power over 100s using instantaneous values from Step 2
 - d. Power level Plimit which is determined as meeting SAR target in Part 0/1
5. Make a second plot containing the following information:
 - a. Computed time-averaged 1gSAR versus time determined in Step 2
 - b. FCC 1gSAR limit of 1.6W/kg

The pass condition is to demonstrate time-averaged 1gSAR versus time shown in Step 5 value versus time does not exceed the FCC limit of 1.6 W/kg throughout the test duration. We would also demonstrate that time-averaged power does not exceed the Plimit at any time in the plot in Step 4.

3.3.2 Change in call scenario

This test is to demonstrate that Samsung S.LSI TAS feature correctly accounts for past Tx powers during time- averaging when a new call is established. The call change has to be carried out when the power limit enforcement is ongoing.

3.3.2.1 Test procedure

1. Establish radio connection of DUT with call box e.g. using LTE technology
2. Configure call box to set DUT Tx power to a low value of -10dBm for 100s.
3. Configure call box to send "ALL UP" power control commands and continue LTE transmission from DUT so that maximum power of Pmax is achieved.
4. After 60s of transmission at Pmax power level, release the call from call box.
5. After 10s, re-establish the LTE connection from call box to DUT and repeat sending "ALL UP" power control command to bring the Tx power to Pmax level again.
6. Continue LTE transmission at Pmax level for another 110s.
7. Release LTE connection.
8. After the completion of the test, prepare one plot with the following information (a) Instantaneous Tx power versus time (b) Requested Tx power versus time (c) Time-averaged power over 100s using instantaneous values and (d) Power level Plimit which is determined as meeting SAR target
9. Make a second plot containing the following information (a) Computed time-averaged 1gSAR versus time and (b) FCC 1gSAR limit of 1.6W/kg

Pass condition is to demonstrate time-averaged 1gSAR value versus time does not exceed the FCC limit of 1.6 W/kg throughout the test duration. It is required to check if SAR calculation is accounting for call drop and connection. Current TAS algorithm software makes the UE estimate the exact amount of Tx power and average SAR even during call drop and call re-establishment event. The UE stores time information when it goes into a sleep mode and wake-up to calculate Tx power on / off duration.

3.3.3 Change in technology/band/window

This test is to demonstrate that Samsung S.SLSI TAS feature can properly handle change of technology/band and consequently time window as necessary during handover scenarios. Since both Plimit and window duration can change across bands, we have to use separate equations below for converting Tx power to SAR as well as apply a combined SAR exposure criterion as shown below.

$$SAR\ 1\ (t) = \frac{TxPower(t)}{Plimit,sub6} * SAR_design_target \quad (3.3.1)$$

$$SAR\ 2\ (t) = \frac{TxPower(t)}{Plimit,sub6} * SAR_design_target \quad (3.3.2)$$

where $Plimit,1,FR1$ would correspond to measured power at which first technology/band meets measured SAR level of $SAR_design_target1$ as described in Part 0 and Part 1 with time-averaging duration of $T1,SAR$. Similarly, $Plimit,FR2$ would be the measured EIRP at which FR2 technology meets measured PD level of PD_design_target as described in Part 0. Similarly, the quantities $Plimit,2,FR1, SAR_design_target2, T2,SAR$ are defined for the second technology/band.

3.3.4 Change in Power Index

This test is to demonstrate that Samsung S.LSI TAS feature can properly handle change of RSI resulting from different SAR index state detected by host platform software. It involves changing the Plimit value during the test for the same technology to emulate power Index change.

3.3.5 Test configuration for SAR exposure switching

The criteria for selecting test case is to pick an LTE band and a NR band with Plimit lower than Pmax in each case. The test is performed with both RATs connected in an EN-DC scenario. In the first portion of the test, DUT is requested to transmit at maximum power for NR and minimum power for LTE. In the second portion of the test, DUT is requested to transmit at maximum power for both NR and LTE. In the final portion of the test, DUT is requested to transmit at minimum power for NR and maximum power for LTE.



3.3.6 Test procedure for handover between two TAS RATs

1. Establish radio connection of DUT with call box e.g. using LTE in Band B2
2. Configure call box to set DUT Tx power to a low value of 0dBm for 110s.
3. Configure call box to send "ALL UP" power control commands and continue LTE transmission from DUT so that maximum power of Pmax is achieved. Continue transmission at the maximum power for 120s.
4. Change RAT from LTE to WCDMA in Band B2 while disabling TAS and configure call box to send "ALL UP" power control commands in WCDMA
5. Continue call in WCDMA at maximum power for 400s

3.3.7 Test configuration for Uplink CA

The criteria for selecting this test case is to demonstrate the compliance of the TAS algorithm when an LTE or FR1 transmission is done over multiple CC. This test shows that the TAS algorithm compliance is independent on the Transmission scenarios (single CC or CA), select any one technology that the EUT supports to demonstrate compliance.

4. Spatial TAS

In legacy TAS algorithm (V2.3), it was assumed that all antennas are correlated regardless of their direction of transmission in space. Thus, the main concept was to split the SAR/TER on the transmitting RATs even they are transmitting on different antennas. Such approach is considered as a worst case scenario in terms of transmitting power. Thus, to enhance the performance of the transmission power of RATs, we should consider the spatial properties of each antenna and the correlations between the antennas transmissions. The TAS algorithm from the latest Samsung submission document revision v2.7 is implemented.

For example, consider a DUT with two antennas one at the top and one at the bottom and each are transmitting in two different direction with no common area affected by both. For such DUT architecture, if each antenna utilize the full SAR compliance while transmitting simultaneously, then the power transmission is still under compliance since no area is affected by both transmissions and thus no area will have SAR above SAR compliance.

For a DUT with N antennas, a spatial correlation matrix (R) can be constructed to map the correlation between each two antennas when they transmit simultaneously. Thus this correlation matrix is given as

$$R = \begin{bmatrix} r_{11} & r_{12} & \dots & r_{1N} \\ r_{21} & r_{22} & \dots & r_{2N} \\ \vdots & \vdots & \ddots & \vdots \\ r_{N1} & r_{N2} & \dots & r_{NN} \end{bmatrix}$$

And it has the following characteristics

- a) r_{ij} is the correlation between antenna i and antenna j
- b) The value of r_{ij} is either 0 or 1, where 1 means fully correlated and 0 means fully uncorrelated.
- c) r_{ii} is the self-correlation of each antenna and it is always 1

For ENDC operation, the value of the correlation coefficients (r_{ij}) between the two transmitting antennas (i,j) will determine the splitting ratios between the two operating RATs as follow

- a) If $r_{ij} = 0$ then each antenna will transmit with full SAR compliance
- b) If $r_{ij} = 1$ then the full SAR compliance will be split among both antennas with ration a:b, where $a + b = 1$



Since the R matrix entries depends on the antenna distribution of each DUT, then our spatial TAS algorithm is implemented to operate with any R matrix (antenna distribution agnostic).

The values of the R matrix entries should be determined by the OEM based on the DUT used. One way to determine the values of the R matrix entries is to use the SPLSR test mentioned in FCC KDB 447498 D01, section 4.3.2.

The SPLSR test is done between each pair of antennas as follow

- i. Measure the SAR peak location for each antenna (x_i, y_i, z_i) and (x_j, y_j, z_j)
- ii. Calculate $\Gamma_{ij} = \frac{(SAR_{i,max} + SAR_{j,max})^{1.5}}{D}$, where $SAR_{i,max} = SAR_{j,max} = SAR_{comp}$ and $D = \sqrt{(x_i - x_j)^2 + (y_i - y_j)^2 + (z_i - z_j)^2}$
- iii. Check if the value of $\Gamma_{ij} \leq 0.04$ for 1g and 0.1 for 10g then these two antennas are considered fully uncorrelated and we can set $r_{ij} = 0$. Otherwise, a Volumetric SAR evaluation can be done to check the non-correlation of both antennas and if not set $r_{ij} = 1$
- iv. If volumetric SAR cannot meet FCC SAR compliance requirements, set $r_{ij} = 1$.

NOTE: The antennas corresponding to the selected RSIs or change in technology/band/window should be in the rij=1 if EUT is configured Spatial TAS algorithm.



5. PD Time Averaging Validation Test Procedures

In this section, we cover the test plan and test procedure for validating Samsung SLSI TAS feature for FR2 scenarios. For this DUT, FR2 transmissions are only in non-standalone mode, so it requires LTE or FR1 as an anchor and both SAR for LTE/FR1 and PD for FR2 will be accounted.

5.1 Test sequence determination for validation

In FR2 transmissions, the test sequence for validation is with the callbox requested maximum power for FR2 at all time.

5.2 Test configuration selection criteria for validating TAS

5.2.1 Test configuration selection for time-varying Tx power transmission

Since the TAS feature is independent of band and beams for a given technology, demonstration with one band will be sufficient.

5.2.2 Test configuration selection for time-varying Tx power transmission

The TAS feature works for both types of exposure (SAR or PD) and ensures total time-averaged exposure ratio meets the FCC limit of 1. One scenarios of LTE band and FR2 band time-varying Tx power verification is sufficient, while exposure condition can be varied between SAR dominant, SAR+PD scenario and PD dominant scenarios for demonstration.

5.2.3 Test configuration selection for change of beam

Since the TAS feature is independent of band and beams for a given technology, demonstration with one pair of beams for switching between them will be sufficient.



5.3 Test procedures for FR2 radiated power measurements

For FR2 testing, we need to perform conducted power measurements for LTE and radiated power measurements for FR2. This section provides general procedures for test setup to validate the compliance in dynamic scenarios outlines in Section 2.

5.3.1 FR2 max power transmission

5.3.1.1 Test procedure

1. Select EN-DC (LTE+FR2) or NR-DC(FR1+FR2) to demonstrate TAS validation.
2. Set the phone in an anechoic chamber for FR2 radiated transmission. In a non-signaling transmission mode for FR2 at maximum target EIRP, adjust the position of the DUT via rotation within the chamber to obtain the maximum measured radiated EIRP using the fixed test antenna. Keep the DUT in this fixed position for the remainder of the test.
3. Reset the DUT state to normal signaling mode and establish both LTE and FR2 connections with the call box.
4. Immediately send "ALL DOWN" power control commands from LTE call box to send LTE to the lowest transmission power. Next, configure the FR2 call box to send "ALL UP" power control commands to send FR2 radio to maximum EIRP condition. In this case, the FR2 radio will comprise the dominant exposure condition using PD metric.
5. After 120s, configure LTE call box to send "ALL UP" power control commands and continue transmission.
6. Record the conducted power of LTE and radiated EIRP of FR2 radio at all times during the test.
7. After 200s, release LTE and FR2 connection.
8. After the end of the test, convert the instantaneous LTE Tx power into 1gSAR value using P_{limit} and Eqn (2.1.1), and then divide by FCC limit of 1.6W/Kg to obtain normalized SAR versus time. Perform 100s time averaging to determine normalized average 1gSAR versus time.
9. Similar to Step 7, convert the instantaneous radiated FR2 EIRP into PD value using P_{limit} and Eqn (2.1.2), and then divide by FCC limit of 10W/m² for 4cm² spatial averaging to obtain instantaneous normalized PD versus time. Perform 4s time averaging to determine normalized average PD versus time.
10. Make one plot containing (a) Instantaneous conducted power for LTE, (b) computed 100s time-averaged power for LTE, (c) Instantaneous EIRP for FR2, (d) computed 4s time averaged EIRP for FR2 and (e) P_{limit} for each of LTE and FR2



11. Make a second plot containing (a) normalized 100s time-averaged SAR for LTE computed in Step 7 (b) normalized 4s time-averaged PD for FR2, (c) TER (Total Exposure Ratio) corresponding total normalized time-averaged RF exposure (using sum of 10(a) and 10(b)) versus time

Pass condition is to demonstrate that TER is kept under 1.0 throughout the test. This ensures that criteria defined in is met at all times.



5.3.2 SAR vs PD exposure switch during transmission

This test is to ensure that Samsung S.LSI TAS feature works for any nature of exposure (SAR or PD) and accurately accounts for switching among SAR dominant, SAR+PD, and PD dominant scenarios, and ensured total time-averaged RF exposure compliance at all times.

5.3.2.1 Test procedure

1. Set the DUT in an anechoic chamber for FR2 radiated transmission. In a non-signaling transmission mode for FR2 at maximum target EIRP, adjust the position of the DUT via rotation within the chamber to obtain the maximum measured radiated EIRP using the fixed test antenna. Keep the DUT in this fixed position for the remainder of the test.
2. Reset the DUT state to normal signaling mode and establish both LTE and FR2 connections with the call box.
3. Immediately send “ALL DOWN” power control commands from LTE call box to send LTE to the lowest transmission power. Next, configure the FR2 call box to send “ALL UP” power control commands to send FR2 radio to maximum EIRP condition. In this case, the FR2 radio will comprise the dominant exposure condition using PD metric.
4. After 120s, configure LTE call box to send “ALL UP” power control commands and continue transmission. Now, the RF exposure margin for FR2 should begin to reduce and could cause reduction in EIRP or stopping of FR2 transmissions.
5. After 120s, configure LTE call box to send “ALL DOWN” power control commands and continue transmission. Now, the FR2 radio should begin to obtain more RF exposure margin and start its transmission at higher power again.
6. Record the conducted power of LTE and radiated EIRP of FR2 radio at all times during the test.
7. Release LTE and FR2 connection.
8. After the end of the test, convert the instantaneous LTE Tx power into 1gSAR value using P_{limit} and Eqn (2.1.1), and then divide by FCC limit of 1.6W/Kg to obtain normalized SAR versus time. Perform 100s time averaging to determine normalized average 1gSAR versus time.
9. Similar to Step 7, convert the instantaneous radiated FR2 EIRP into PD value using P_{limit} and Eqn (2.1.2), and then divide by FCC limit of 10W/m² for 4cm² spatial averaging to obtain instantaneous normalized PD versus time. Perform 4s time averaging to determine normalized average PD versus time.
10. Make one plot containing (a) Instantaneous conducted power for LTE, (b) computed 100s time- averaged power for LTE, (c) Instantaneous EIRP for FR2, (d) computed 4s time averaged EIRP for FR2 and (e) P_{limit} for each



of LTE and FR2

11. Make a second plot containing (a) normalized 100s time-averaged SAR for LTE computed in Step 7 (b) normalized 4s time-averaged PD for FR2, (c) TER (Total Exposure Ratio) corresponding total normalized time-averaged RF exposure (using sum of 10(a) and 10(b)) versus time

Pass condition is to demonstrate that TER is kept under 1.0 throughout the test. This ensures that criteria defined in is met at all times.



5.3.3 Change of beam

This test is to demonstrate that Samsung S.LSI TAS feature can account for change of beam in FR2 and still meet total RF exposure compliance.

5.3.3.1 Test procedure

1. Set the DUT in an anechoic chamber for FR2 radiated transmission. In a non-signaling transmission mode for FR2 at beam of maximum target EIRP, adjust the position of the DUT via rotation within the chamber to obtain the maximum measured radiated EIRP using the fixed test antenna.
2. Reset the DUT state to normal signaling mode and establish both LTE and FR2 connections with the call box.
3. Immediately send "ALL DOWN" power control commands from LTE call box to send LTE to the lowest transmission power. Next, configure the FR2 call box to send "ALL UP" power control commands to send FR2 radio to maximum EIRP condition. In this case, the FR2 radio will comprise the dominant exposure condition using PD metric.
4. After 20s, the test equipment turns the DUT by 30 degrees (horizontal=30, vertical=0) to change best module and correspondingly a beam change.
5. After 20s, the test equipment turns the DUT by 60 degrees (horizontal=60, vertical=0) to change best module again and correspondingly a beam change.
6. Continue the LTE and FR2 transmissions for another 20s
7. Record the conducted power of LTE and radiated EIRP of FR2 radio and per beam at all times during the test.
8. Release LTE and FR2 connection.
9. After the end of the test, convert the instantaneous LTE Tx power into 1gSAR value using Plimit and Eqn (2.1.1), and then divide by FCC limit of 1.6W/Kg to obtain normalized SAR versus time. Perform 100s time averaging to determine normalized average 1gSAR versus time.
10. Similar to Step 9, convert the instantaneous radiated FR2 EIRP into PD value using Plimit and Eqn (2.1.2), and then divide by FCC limit of 10W/m² for 4cm² spatial averaging to obtain instantaneous normalized PD versus time for each beam. Perform 4s time averaging to determine normalized average PD versus time. Note that for each beam, we have to use the corresponding Plimit values before converting to the PD values.
11. Make one plot containing (a) Instantaneous conducted power for LTE, (b) computed 100s time- averaged power for LTE, (c) Instantaneous EIRP for FR2 per beam, (d) computed 4s time averaged EIRP for FR2 per beam and (e) Plimit for each of LTE and FR2



12. Make a second plot containing (a) normalized 100s time-averaged SAR for LTE computed in Step 7 (b) normalized 4s time-averaged PD for FR2 per beam, (c) TER (Total Exposure Ratio) corresponding total normalized time-averaged RF exposure (using sum of 12(a) and 12(b)) versus time as computed in left hand side of equation below

Pass condition is to demonstrate time-averaged 1gSAR value and 4cm² PD versus time does not exceed the FCC limits of 1.6 W/kg and 10W/m² throughout the test duration. And TER (Total Exposure Ratio) as in Eqn should be kept under 1.0 throughout the test. It is required to check if power limiting enforcement is operated as expected during the test.



6. Test Configurations

6.1 WWAN (sub-6) transmission

- 1 The Plimit values correspond to SAR_design_target.
- 2 GSM and NTN doesn't support time average feature of dynamic power varying, the power will be fixed at the static reduce power level at different exposure conditions for RF exposure compliance. For the GSM/NTN Plimit power levels in the table correspond to the burst average power levels which don't account for TX duty cycle.
- 3 UMTS, LTE and 5GNR TDD: Plimit power levels in the table correspond to the time-averaged power levels which accounts for TX duty cycle.
- 4 Maximum target power, Pmax, is configured in NV settings in EUT to limit maximum transmitting power. This power is converted into peak power in NV settings for TDD schemes.

Table: P_{limit} for supported technologies and bands (P_{limit} corresponding to SAR design target)

Plimit (dBm)														
Technology	Mode	Antenna	Index 1	Index 2	Index 3	Index 2 Head SAR Design_Target (W/kg)	Index 3 Head SAR Design_Target (W/kg)	Index 5	Index 6	Index 5 Body SAR Design_Target (W/kg)	Index 6 Body SAR Design_Target (W/kg)	Index 4	Index 4 Hotspot SAR Design_Target (W/kg)	Uncertainty (dB)
GSM850	GSM 1TX	ANT1	32.2	29.2	28.5	0.81	0.69	37.0	37.0	0.81	0.69	34.5	0.69	0.9
	GPRS 1TX		32.2	29.2	28.5	0.81	0.69	37.0	37.0	0.81	0.69	34.5	0.69	0.9
	GPRS 2TX		31.2	26.2	25.5	0.81	0.69	34.0	34.0	0.81	0.69	31.5	0.69	0.9
	GPRS 3TX		30.2	24.4	23.7	0.81	0.69	32.2	32.2	0.81	0.69	29.7	0.69	0.9
	GPRS 4TX		29.2	23.2	22.5	0.81	0.69	31.0	31.0	0.81	0.69	28.5	0.69	0.9
	EGPRS 1TX		26.2	29.9	29.9	0.81	0.69	29.9	29.9	0.81	0.69	29.2	0.69	0.9
	EGPRS 2TX		25.2	26.9	26.9	0.81	0.69	26.9	26.9	0.81	0.69	26.2	0.69	0.9
	EGPRS 3TX		24.2	25.1	25.1	0.81	0.69	25.1	25.1	0.81	0.69	24.4	0.69	0.9
	EGPRS 4TX		23.2	23.9	23.9	0.81	0.69	23.9	23.9	0.81	0.69	23.2	0.69	0.9
	GSM 1TX	ANT0	32.5	34.0	34.0	0.79	0.67	33.0	33.0	0.79	0.67	32.2	0.68	1.0
	GPRS 1TX		32.5	34.0	34.0	0.79	0.67	33.0	33.0	0.79	0.67	32.2	0.68	1.0
	GPRS 2TX		31.5	31.0	30.3	0.79	0.67	30.0	29.3	0.79	0.67	29.3	0.68	1.0
	GPRS 3TX		30.5	29.2	28.5	0.79	0.67	28.2	27.5	0.79	0.67	27.5	0.68	1.0
	GPRS 4TX		29.5	28.0	27.3	0.79	0.67	27.0	26.3	0.79	0.67	26.3	0.68	1.0
	EGPRS 1TX		26.5	30.2	30.2	0.79	0.67	30.2	30.2	0.79	0.67	26.5	0.68	1.0
	EGPRS 2TX		25.5	27.2	27.2	0.79	0.67	27.2	27.2	0.79	0.67	25.5	0.68	1.0
	EGPRS 3TX		24.5	25.4	25.4	0.79	0.67	25.4	25.4	0.79	0.67	24.5	0.68	1.0
	EGPRS 4TX		23.5	24.2	24.2	0.79	0.67	24.2	24.2	0.79	0.67	23.5	0.68	1.0
GSM1900	GSM 1TX	ANT0	28.2	45.9	45.9	0.81	0.69	27.7	27.0	0.81	0.69	24.7	0.69	0.9
	GPRS 1TX		28.2	45.9	45.9	0.81	0.69	27.7	27.0	0.81	0.69	24.7	0.69	0.9
	GPRS 2TX		27.2	45.9	45.9	0.81	0.69	24.7	24.0	0.81	0.69	21.7	0.69	0.9
	GPRS 3TX		26.7	45.9	45.9	0.81	0.69	22.9	22.2	0.81	0.69	19.9	0.69	0.9
	GPRS 4TX		25.7	45.9	45.9	0.81	0.69	21.7	21.0	0.81	0.69	18.7	0.69	0.9
	EGPRS 1TX		24.7	25.4	25.4	0.81	0.69	24.7	24.0	0.81	0.69	23.7	0.69	0.9
	EGPRS 2TX		23.7	24.4	24.4	0.81	0.69	23.7	23.0	0.81	0.69	21.7	0.69	0.9
	EGPRS 3TX		22.7	23.4	23.4	0.81	0.69	22.7	22.0	0.81	0.69	19.9	0.69	0.9
	EGPRS 4TX		21.7	22.4	22.4	0.81	0.69	21.7	21.0	0.81	0.69	18.7	0.69	0.9
	GSM 1TX	ANT2	29.0	31.8	31.8	0.79	0.67	28.8	28.1	0.79	0.67	27.6	0.68	1.0
	GPRS 1TX		29.0	31.8	31.8	0.79	0.67	28.8	28.1	0.79	0.67	27.6	0.68	1.0
	GPRS 2TX		28.0	28.8	28.8	0.79	0.67	25.8	25.1	0.79	0.67	25.1	0.68	1.0
	GPRS 3TX		27.5	27.0	26.3	0.79	0.67	24.0	23.3	0.79	0.67	23.3	0.68	1.0
	GPRS 4TX		26.5	25.8	25.1	0.79	0.67	22.8	22.1	0.79	0.67	22.1	0.68	1.0
	EGPRS 1TX		25.5	29.2	29.2	0.79	0.67	28.8	28.8	0.79	0.67	25.5	0.68	1.0
	EGPRS 2TX		24.5	26.2	26.2	0.79	0.67	25.8	25.8	0.79	0.67	24.5	0.68	1.0
	EGPRS 3TX		23.5	24.4	24.4	0.79	0.67	24.0	24.0	0.79	0.67	23.3	0.68	1.0
	EGPRS 4TX		22.5	23.2	23.2	0.79	0.67	22.8	22.8	0.79	0.67	22.1	0.68	1.0



Plimit (dBm)														
Technology	Mode	Antenna	Index 1	Index 2	Index 3	Index 2 Head SAR Design_Target (W/kg)	Index 3 Head SAR Design_Target (W/kg)	Index 5	Index 6	Index 5 Body SAR Design_Target (W/kg)	Index 6 Body SAR Design_Target (W/kg)	Index 4	Index 4 Hotspot SAR Design_Target (W/kg)	Uncertainty (dB)
WCDMA B5	R99	ANT0	24.3	28.8	28.8	0.76	0.64	23.6	26.2	26.2	0.64	25.5	0.64	1.2
	HSDPA		24.3	28.8	28.8	0.76	0.64	23.6	26.2	26.2	0.64	25.5	0.64	1.2
	HSUPA		24.3	28.8	28.8	0.76	0.64	23.6	26.2	26.2	0.64	25.5	0.64	1.2
	DC-HSDPA		24.3	28.8	28.8	0.76	0.64	23.6	26.2	26.2	0.64	25.5	0.64	1.2
	R99	ANT1	24.0	22.1	21.4	0.78	0.66	26.4	27.4	27.4	0.66	26.7	0.66	1.1
	HSDPA		24.0	22.1	21.4	0.78	0.66	26.4	27.4	27.4	0.66	26.7	0.66	1.1
	HSUPA		24.0	22.1	21.4	0.78	0.66	26.4	27.4	27.4	0.66	26.7	0.66	1.1
	DC-HSDPA		24.0	22.1	21.4	0.78	0.66	26.4	27.4	27.4	0.66	26.7	0.66	1.1
WCDMA B4	R99	ANT0	23.2	33.2	33.2	0.78	0.66	18.8	18.1	18.8	0.66	17.5	0.66	1.1
	HSDPA		23.2	33.2	33.2	0.78	0.66	18.8	18.1	18.8	0.66	17.5	0.66	1.1
	HSUPA		23.2	33.2	33.2	0.78	0.66	18.8	18.1	18.8	0.66	17.5	0.66	1.1
	DC-HSDPA		23.2	33.2	33.2	0.78	0.66	18.8	18.1	18.8	0.66	17.5	0.66	1.1
	R99	ANT2	24.0	32.0	32.0	0.76	0.64	22.3	20.1	20.8	0.64	20.1	0.64	1.2
	HSDPA		24.0	32.0	32.0	0.76	0.64	22.3	20.1	20.8	0.64	20.1	0.64	1.2
	HSUPA		24.0	32.0	32.0	0.76	0.64	22.3	20.1	20.8	0.64	20.1	0.64	1.2
	DC-HSDPA		24.0	32.0	32.0	0.76	0.64	22.3	20.1	20.8	0.64	20.1	0.64	1.2
WCDMA B2	R99	ANT0	23.2	34.7	34.7	0.78	0.66	17.8	18.2	18.9	0.66	16.9	0.66	1.1
	HSDPA		23.2	34.7	34.7	0.78	0.66	17.8	18.2	18.9	0.66	16.9	0.66	1.1
	HSUPA		23.2	34.7	34.7	0.78	0.66	17.8	18.2	18.9	0.66	16.9	0.66	1.1
	DC-HSDPA		23.2	34.7	34.7	0.78	0.66	17.8	18.2	18.9	0.66	16.9	0.66	1.1
	R99	ANT2	24.0	23.3	22.6	0.76	0.64	22.1	20.1	20.8	0.64	20.1	0.64	1.2
	HSDPA		24.0	23.3	22.6	0.76	0.64	22.1	20.1	20.8	0.64	20.1	0.64	1.2
	HSUPA		24.0	23.3	22.6	0.76	0.64	22.1	20.1	20.8	0.64	20.1	0.64	1.2
	DC-HSDPA		24.0	23.3	22.6	0.76	0.64	22.1	20.1	20.8	0.64	20.1	0.64	1.2



Plimit (dBm)															
Technology	Band	Power Class	Antenna	Index 1	Index 2	Index 3	Index 2 Head SAR Design_Target (W/kg)	Index 3 Head SAR Design_Target (W/kg)	Index 5	Index 6	Index 5 Body SAR Design_Target (W/kg)	Index 6 Body SAR Design_Target (W/kg)	Index 4	Index 4 Hotspot SAR Design_Target (W/kg)	Uncertainty (dB)
LTE	B71	PC3	ANT0	24.30	29.8	29.8	0.83	0.7	27.5	27.5	0.83	0.7	26.3	0.71	0.8
LTE	B71	PC3	ANT1	24.00	23.3	22.6	0.85	0.72	29.3	29.3	0.85	0.72	28.6	0.72	0.7
LTE	B12	PC3	ANT0	24.30	29.4	29.4	0.83	0.7	27.5	27.5	0.83	0.7	25.6	0.71	0.8
LTE	B12	PC3	ANT1	24.00	22.4	21.7	0.85	0.72	29.2	29.2	0.85	0.72	26.9	0.72	0.7
LTE	B17	PC3	ANT0	24.30	29.36	29.4	0.83	0.7	27.45	27.5	0.83	0.7	25.60	0.71	0.8
LTE	B17	PC3	ANT1	24.00	22.40	21.7	0.85	0.72	29.16	29.2	0.85	0.72	26.88	0.72	0.7
LTE	B13	PC3	ANT0	24.30	27.6	27.6	0.83	0.7	26.1	26.1	0.83	0.7	25.4	0.71	0.8
LTE	B13	PC3	ANT1	24.00	22.0	21.3	0.85	0.72	26.6	26.6	0.85	0.72	25.9	0.72	0.7
LTE	B14	PC3	ANT0	24.30	27.3	27.3	0.83	0.7	26.5	26.5	0.83	0.7	25.8	0.71	0.8
LTE	B14	PC3	ANT1	24.00	22.2	21.5	0.85	0.72	27.1	27.1	0.85	0.72	26.4	0.72	0.7
LTE	B26	PC3	ANT0	24.30	28.9	28.9	0.83	0.7	27.7	27.7	0.83	0.7	27.0	0.71	0.8
LTE	B26	PC3	ANT1	24.00	22.5	21.8	0.85	0.72	27.4	27.4	0.85	0.72	26.7	0.72	0.7
LTE	B5	PC3	ANT0	24.30	28.89	28.9	0.83	0.7	27.69	27.7	0.83	0.7	26.98	0.71	0.8
LTE	B5	PC3	ANT1	24.00	22.50	21.8	0.85	0.72	27.36	27.4	0.85	0.72	26.65	0.72	0.7
LTE	B66	PC3	ANT0	23.20	32.2	32.2	0.83	0.7	19.2	18.5	0.83	0.7	17.8	0.71	0.8
LTE	B66	PC3	ANT1	24.00	18.3	17.6	0.81	0.69	24.7	24.7	0.81	0.69	23.3	0.69	0.9
LTE	B66	PC3	ANT2	24.00	26.1	26.1	0.81	0.69	23.3	22.6	0.81	0.69	22.6	0.69	0.9
LTE	B66	PC3	ANT5	24.00	14.7	14.0	0.89	0.75	19.9	19.2	0.89	0.75	18.6	0.76	0.5
LTE	B4	PC3	ANT0	23.20	32.2	32.2	0.8	0.7	19.2	18.5	0.8	0.7	17.8	0.71	0.8
LTE	B4	PC3	ANT1	24.00	18.3	17.6	0.8	0.69	24.7	24.7	0.8	0.69	23.3	0.69	0.9
LTE	B4	PC3	ANT2	24.00	26.1	26.1	0.8	0.69	23.3	22.6	0.8	0.69	22.6	0.69	0.9
LTE	B4	PC3	ANT5	24.00	14.7	14.0	0.9	0.75	19.9	19.2	0.9	0.75	18.6	0.76	0.5
LTE	B25	PC3	ANT0	23.20	35.7	35.7	0.83	0.7	19.2	18.5	0.83	0.7	17.4	0.71	0.8
LTE	B25	PC3	ANT1	24.00	15.1	14.4	0.81	0.69	20.6	19.9	0.81	0.69	19.9	0.69	0.9
LTE	B25	PC3	ANT2	24.00	23.6	22.9	0.81	0.69	22.8	22.1	0.81	0.69	22.1	0.69	0.9
LTE	B25	PC3	ANT5	24.00	15.8	15.1	0.89	0.75	21.2	20.5	0.89	0.75	19.7	0.76	0.5
LTE	B2	PC3	ANT0	23.20	35.72	35.7	0.83	0.7	19.20	18.5	0.83	0.7	17.40	0.71	0.8
LTE	B2	PC3	ANT1	24.00	15.10	14.4	0.81	0.69	20.60	19.9	0.81	0.69	19.90	0.69	0.9
LTE	B2	PC3	ANT2	24.00	23.60	22.9	0.81	0.69	22.80	22.1	0.81	0.69	22.10	0.69	0.9
LTE	B2	PC3	ANT5	24.00	15.80	15.1	0.89	0.75	21.20	20.5	0.89	0.75	19.70	0.76	0.5
LTE	B30	PC3	ANT0	22.1	31.9	31.9	0.81	0.69	20.6	19.9	0.81	0.69	17.9	0.69	0.9
LTE	B30	PC3	ANT2	23.6	26.8	26.8	0.81	0.69	22.9	22.2	0.81	0.69	22.2	0.69	0.9
LTE	B7	PC3	ANT0	23.80	34.0	34.0	0.81	0.69	21.6	20.9	0.81	0.69	17.6	0.69	0.9
LTE	B7	PC3	ANT2	24.20	22.3	21.6	0.81	0.69	20.9	20.2	0.81	0.69	20.2	0.69	0.9
LTE	B41	PC3	ANT0	21.80	26.3	26.3	0.81	0.69	21.4	20.7	0.81	0.69	19.6	0.69	0.9
LTE	B41	PC2	ANT0	22.40	26.3	26.3	0.81	0.69	21.4	20.7	0.81	0.69	19.6	0.69	0.9
LTE	B41	PC3	ANT2	22.20	22.2	21.5	0.81	0.69	23.6	23.6	0.81	0.69	21.5	0.69	0.9
LTE	B41	PC2	ANT2	22.00	22.5	22.5	0.81	0.69	23.6	23.6	0.81	0.69	21.5	0.69	0.9
LTE	B38	PC3	ANT0	21.80	26.3	26.3	0.8	0.69	21.4	20.7	0.8	0.69	19.6	0.69	0.9
LTE	B38	PC2	ANT0	22.40	26.3	26.3	0.8	0.69	21.4	20.7	0.8	0.69	19.6	0.69	0.9
LTE	B38	PC3	ANT2	22.20	22.2	21.5	0.8	0.69	23.6	23.6	0.8	0.69	21.5	0.69	0.9
LTE	B38	PC2	ANT2	22.00	22.5	22.5	0.8	0.69	23.6	23.6	0.8	0.69	21.5	0.69	0.9
LTE	B48	PC3	ANT6	19.0	31.2	31.2	0.78	0.66	22.5	22.5	0.78	0.66	21.8	0.66	1.1
LTE	B48	PC3	ANT7	19.5	33.8	33.8	0.65	0.54	22.4	22.4	0.65	0.54	21.7	0.55	1.9



Plimit (dBm)															
Technology	Band	Power Class	Antenna	Index 1	Index 2	Index 3	Index 2 Head SAR Design_Target (W/kg)	Index 3 Head SAR Design_Target (W/kg)	Index 5	Index 6	Index 5 Body SAR Design_Target (W/kg)	Index 6 Body SAR Design_Target (W/kg)	Index 4	Index 4 Hotspot SAR Design_Target (W/kg)	Uncertainty (dB)
NR	N71	PC3	ANT0	24.30	31.5	31.5	0.83	0.71	30.0	30.0	0.83	0.71	28.6	0.71	0.8
NR	N71	PC3	ANT1	24.00	26.3	26.3	0.85	0.72	35.4	35.4	0.85	0.72	28.8	0.72	0.7
NR	N12	PC3	ANT0	24.30	30.6	30.6	0.83	0.71	27.7	27.7	0.83	0.71	27.0	0.71	0.8
NR	N12	PC3	ANT1	24.00	22.7	22.0	0.85	0.72	34.3	34.3	0.85	0.72	27.6	0.72	0.7
NR	N14	PC3	ANT0	24.30	28.7	28.7	0.83	0.71	26.8	26.8	0.83	0.71	23.6	0.71	0.8
NR	N14	PC3	ANT1	24.00	23.0	22.3	0.85	0.72	32.0	32.0	0.85	0.72	23.3	0.72	0.7
NR	N26	PC3	ANT0	24.30	30.9	30.9	0.83	0.71	29.6	29.6	0.83	0.71	28.2	0.71	0.8
NR	N26	PC3	ANT1	24.00	22.3	21.6	0.85	0.72	29.0	29.0	0.85	0.72	28.2	0.72	0.7
NR	N5	PC3	ANT0	24.30	30.90	30.9	0.83	0.71	29.64	29.6	0.83	0.71	28.22	0.71	0.8
NR	N5	PC3	ANT1	24.00	22.30	21.6	0.85	0.72	28.97	29.0	0.85	0.72	28.21	0.72	0.7
NR	N70	PC3	ANT0	22.90	32.9	32.9	0.83	0.71	18.7	18.0	0.83	0.71	17.8	0.71	0.8
NR	N70	PC3	ANT2	23.70	28.6	28.6	0.81	0.69	21.6	20.9	0.81	0.69	20.9	0.69	0.9
NR	N66	PC3	ANT0	23.20	34.5	34.5	0.83	0.71	19.8	19.1	0.83	0.71	17.9	0.71	0.8
NR	N66	PC3	ANT1	24.00	19.5	18.8	0.81	0.69	25.7	25.7	0.81	0.69	23.3	0.69	0.9
NR	N66	PC3	ANT2	24.00	27.0	27.0	0.81	0.69	20.7	20.0	0.81	0.69	20.0	0.69	0.9
NR	N66	PC3	ANT5	24.00	16.8	16.1	0.89	0.76	21.6	20.9	0.89	0.76	20.9	0.76	0.5
NR	N25	PC3	ANT0	23.20	34.8	34.8	0.83	0.71	19.1	18.4	0.83	0.71	17.3	0.71	0.8
NR	N25	PC3	ANT1	24.0	14.6	13.9	0.81	0.69	20.9	20.2	0.81	0.69	20.2	0.69	0.9
NR	N25	PC3	ANT2	24.00	23.3	22.6	0.81	0.69	20.6	19.9	0.81	0.69	19.9	0.69	0.9
NR	N25	PC3	ANT5	24.0	17.0	16.3	0.89	0.76	21.6	20.9	0.89	0.76	20.9	0.76	0.5
NR	N2	PC3	ANT0	23.20	34.75	34.8	0.83	0.71	19.10	18.4	0.83	0.71	17.00	0.71	0.8
NR	N2	PC3	ANT1	24.00	14.60	13.9	0.81	0.69	20.90	20.2	0.81	0.69	20.20	0.69	0.9
NR	N2	PC3	ANT2	24.00	23.30	22.6	0.81	0.69	20.60	19.9	0.81	0.69	19.90	0.69	0.9
NR	N2	PC3	ANT5	24.00	17.00	16.3	0.89	0.76	21.60	20.9	0.89	0.76	20.90	0.76	0.5
NR	N30	PC3	ANT0	21.9	35.0	35.0	0.78	0.66	20.4	19.7	0.78	0.66	18.9	0.66	1.1
NR	N30	PC3	ANT2	23.6	26.0	26.0	0.81	0.69	20.6	19.9	0.81	0.69	19.9	0.69	0.9
NR	N7	PC3	ANT0	23.80	32.4	32.4	0.81	0.69	20.3	19.6	0.81	0.69	18.1	0.69	0.9
NR	N7	PC3	ANT2	24.20	21.6	20.9	0.81	0.69	19.0	18.3	0.81	0.69	18.3	0.69	0.9
NR	N41	PC3	ANT0	23.80	32.5	32.5	0.81	0.69	21.1	20.4	0.81	0.69	20.1	0.69	0.9
NR	N41	PC2	ANT0	22.00	32.5	32.5	0.81	0.69	21.1	20.4	0.81	0.69	20.1	0.69	0.9
NR	N41	PC1P5	ANT0	19.00	32.5	32.5	0.81	0.69	21.1	21.1	0.81	0.69	20.1	0.69	0.9
NR	N41	PC3	ANT1	24.10	16.4	15.7	0.81	0.69	25.1	25.1	0.81	0.69	23.1	0.69	0.9
NR	N41	PC2	ANT1	23.00	16.4	15.7	0.81	0.69	25.1	25.1	0.81	0.69	23.1	0.69	0.9
NR	N41	PC1P5	ANT1	20.00	16.4	15.7	0.81	0.69	25.1	25.1	0.81	0.69	23.1	0.69	0.9
NR	N41	PC3	ANT2	24.10	22.1	21.4	0.81	0.69	19.9	19.2	0.81	0.69	19.2	0.69	0.9
NR	N41	PC2	ANT2	23.00	22.1	21.4	0.81	0.69	19.9	19.2	0.81	0.69	19.2	0.69	0.9
NR	N41	PC1P5	ANT2	20.00	22.1	22.1	0.81	0.69	19.9	19.2	0.81	0.69	19.2	0.69	0.9
NR	N41	PC3	ANT5	24.10	18.1	17.4	0.89	0.76	29.6	29.6	0.89	0.76	23.8	0.76	0.5
NR	N41	PC2	ANT5	23.00	18.1	17.4	0.89	0.76	29.6	29.6	0.89	0.76	23.8	0.76	0.5
NR	N41	PC1P5	ANT5	19.00	18.1	17.4	0.71	0.6	29.6	29.6	0.71	0.6	23.8	0.60	1.5
NR	N38	PC3	ANT0	23.80	32.54	32.5	0.81	0.69	21.10	20.4	0.81	0.69	20.10	0.69	0.9
NR	N38	PC3	ANT1	24.20	16.40	15.7	0.81	0.69	25.13	25.1	0.81	0.69	23.10	0.69	0.9
NR	N38	PC3	ANT2	24.20	22.10	21.4	0.81	0.69	19.90	19.2	0.81	0.69	19.20	0.69	0.9
NR	N38	PC3	ANT5	24.20	18.10	17.4	0.89	0.69	29.56	29.6	0.89	0.69	23.80	0.69	0.9
NR	N78	PC3	ANT1	24.00	14.90	14.2	0.78	0.66	22.40	21.7	0.78	0.66	19.90	0.66	1.1
NR	N78	PC2	ANT1	22.00	14.90	14.2	0.78	0.66	22.40	22.4	0.78	0.66	19.90	0.66	1.1
NR	N78	PC1P5	ANT1	19.00	14.90	14.2	0.78	0.66	22.40	22.4	0.78	0.66	19.90	0.66	1.1
NR	N78	PC3	ANT5	24.00	16.60	15.9	0.81	0.69	22.60	21.9	0.81	0.69	21.90	0.69	0.9
NR	N78	PC2	ANT5	21.00	16.60	15.9	0.65	0.55	22.60	22.6	0.65	0.55	21.90	0.55	1.9
NR	N78	PC1P5	ANT5	19.00	16.60	15.9	0.81	0.69	22.60	22.6	0.81	0.69	21.90	0.69	0.9
NR	N78	PC3	ANT6	24.00	23.30	22.6	0.78	0.66	18.50	17.8	0.78	0.66	17.80	0.66	1.1



FCC RF Exposure Report

Report No. : FA3N2327B

NR	N78	PC2	ANT6	23.00	23.30	23.3	0.78	0.66	18.50	17.8	0.78	0.66	17.80	0.66	1.1
NR	N78	PC1P5	ANT6	20.00	23.30	23.3	0.78	0.66	18.50	17.8	0.78	0.66	17.80	0.66	1.1
NR	N78	PC3	ANT7	22.80	28.40	28.4	0.65	0.55	18.10	17.4	0.65	0.55	17.40	0.55	1.9
NR	N78	PC2	ANT7	22.00	28.40	28.4	0.71	0.6	18.10	17.4	0.71	0.6	17.40	0.60	1.5
NR	N78	PC1P5	ANT7	18.80	28.40	28.4	0.68	0.57	18.10	17.4	0.68	0.57	17.40	0.57	1.7
NR	N48	PC3	ANT1	21.0	16.4	15.7	0.78	0.66	23.5	23.5	0.78	0.66	22.8	0.66	1.1
NR	N48	PC3	ANT5	22.5	16.6	15.9	0.81	0.69	25.8	25.8	0.81	0.69	21.5	0.69	0.9
NR	N48	PC3	ANT6	21.0	27.3	27.3	0.78	0.66	18.9	18.2	0.78	0.66	18.2	0.66	1.1
NR	N48	PC3	ANT7	21.5	31.0	31.0	0.65	0.55	18.4	17.7	0.65	0.55	17.7	0.55	1.9
NR	N77	PC3	ANT1	24.00	14.9	14.2	0.78	0.66	22.4	21.7	0.78	0.66	19.9	0.66	1.1
NR	N77	PC2	ANT1	22.00	14.9	14.2	0.78	0.66	22.4	22.4	0.78	0.66	19.9	0.66	1.1
NR	N77	PC1P5	ANT1	19.00	14.9	14.2	0.78	0.66	22.4	22.4	0.78	0.66	19.9	0.66	1.1
NR	N77	PC3	ANT5	24.00	16.6	15.9	0.81	0.69	22.6	21.9	0.81	0.69	21.9	0.69	0.9
NR	N77	PC2	ANT5	21.00	16.6	15.9	0.65	0.55	22.6	22.6	0.65	0.55	21.9	0.55	1.9
NR	N77	PC1P5	ANT5	19.00	16.6	15.9	0.81	0.69	22.6	22.6	0.81	0.69	21.9	0.69	0.9
NR	N77	PC3	ANT6	24.00	23.3	22.6	0.78	0.66	18.5	17.8	0.78	0.66	17.8	0.66	1.1
NR	N77	PC2	ANT6	23.00	23.3	23.3	0.78	0.66	18.5	17.8	0.78	0.66	17.8	0.66	1.1
NR	N77	PC1P5	ANT6	20.00	23.3	23.3	0.78	0.66	18.5	17.8	0.78	0.66	17.8	0.66	1.1
NR	N77	PC3	ANT7	22.80	28.4	28.4	0.65	0.55	18.1	17.4	0.65	0.55	17.4	0.55	1.9
NR	N77	PC2	ANT7	22.00	28.4	28.4	0.71	0.6	18.1	17.4	0.71	0.6	17.4	0.60	1.5
NR	N77	PC1P5	ANT7	18.80	28.4	28.4	0.68	0.57	18.1	17.4	0.68	0.57	17.4	0.57	1.7

Plimit (dBm)						
Technology	Band	Antenna	Index 1	Index 5	Body SAR Design_Target (W/kg)	Uncertainty (dB)
NTN	Band 23	ANT1	22.5	22.00	0.79	1.0
NTN	Band 255	ANT5	23.6	23.60	0.79	1.0

6.2 Test case list for sub-6GHz transmissions

To validate TAS algorithm in various sub-6GHz conditions, the chosen TC (Test Case) list is defined as in Table 6.2.1.

Table 6.2.1 Sub-6GHz TAS validation test case list

No.	Test Scenario	Test case	Test configuration
1	Time-varying Tx power transmission	UMTS_Time_Varying_Tx_Power_Case_1	WCDMA B5
2		UMTS_Time_Varying_Tx_Power_Case_1	WCDMA B2
3		LTE_Time_Varying_Tx_Power_Case_1	LTE B41 pc2
4		LTE_Time_Varying_Tx_Power_Case_1	LTE B7
5		SA_FR1_Time_Varying_Tx_Power_Case_1	n14 (SA Mode)
6		SA_FR1_Time_Varying_Tx_Power_Case_1	n77 pc3 (SA Mode)
7	Time-varying Tx power transmission	UMTS_Time_Varying_Tx_Power_Case_2	WCDMA B5
8		UMTS_Time_Varying_Tx_Power_Case_2	WCDMA B2
9		LTE_Time_Varying_Tx_Power_Case_2	LTE B41 pc2
10		LTE_Time_Varying_Tx_Power_Case_2	LTE B7
11		SA_FR1_Time_Varying_Tx_Power_Case_2	n14 (SA Mode)
12		SA_FR1_Time_Varying_Tx_Power_Case_2	n77 pc3 (SA Mode)
13	Change operate states	SA_FR1_RF_SAR_Index_Change	n77 pc3 (SA Mode) index 4 to index 3
14	Wireless technology Handover	LTE_to_WCDMA_H.O.	LTE B48 pc3 , WCDMA B2
15	Drop call	Call_Disconnect_Reestablishment	LTE B7
16	SAR exposure switch	NSA_FR1_Dominant_Power_Switching	LTE B7 , n77 pc3 (NSA Mode)
17	Re-selection in call	NR_TO_LTE_IRAT_HO	n77 pc3 (NSA Mode) to LTE B7
18	UL CA	LTE Uplink CA	LTE B7

Remark: UL MIMO antenna operating on different antenna groups, therefore TAS validation is not required.

Correlation matrix for Spatial TAS implementation for WWWAN antenna pairs

Antenna Group	AG0	AG1	AG2
	Ant 0, Ant 6	Ant 1, Ant 5	Ant 2, Ant 7

6.3 Test case list for LTE+FR2 transmissions

To validate TAS algorithm in scenarios including FR2, the chosen TC (Test Case) list is defined as in Table 6.3.1.

Table 6.3.1 Sub-6GHz TAS validation test case list

No.	Test Scenario	Test case	Test configuration
1	Time-varying Tx power transmission	mmWave_Max_Tx_Power	LTE B2 + n260 Plane A Beam 1
2	SAR exposure switch	mmWave_Dominant_Power_Switching	LTE B2 + n260 Plane A Beam 1
3	Change of beam	mmWave_Module_Beam_Change	LTE B2 + n260 (Plane A Beam 1 to Plane B Beam 1 to Plane A Beam 1)

7. Conducted Power Test Results for Sub-6 TAS validation

7.1 Measurement set-up

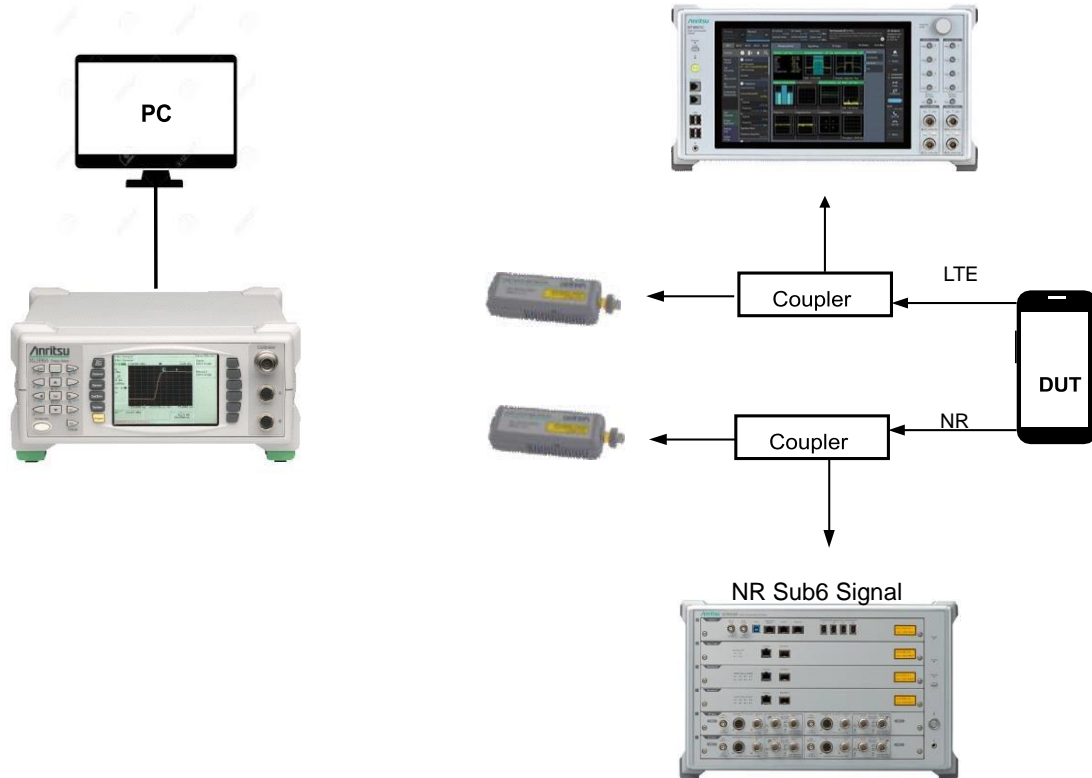

Figure 7.1-1 Test set-up for legacy and sub 6GHz

The test setup for TAS validation with sub-6GHz RATs only is shown in Figure 7.1-1.

Power readings for each active technology are recorded every 100ms and dumped in an excel file. A post-processing tool is used to extract data from the excel file and plot the required metrics such as time-averaged power, SAR and TER values versus time as described in Section 3.3.

In summary, the tests have to be executed as following procedure.

1. Measure conduction sub 6GHz Tx power corresponds to SAR regulation.
2. Execute time-varying test scenarios. And record sub 6GHz power using sub 6GHz power meter equipment.
3. The time interval between subsequent conducted power measurements is 0.1s (typically much less than 1 second)
4. Plot the recorded results over measurement time. And evaluate the results for validation.
5. The required Power level is burst average power level controlled by call box, the power varying measurement correspond to time-average power levels after accounting for duty cycle in the case TDD modulation schemes (e.g. LTE, 5G FR1 TDD bands).



7.2 Measured Plimit and Pmax

The measured Plimit for all the selected radio configurations are listed in Table 7.2.1. Pmax was also measured for radio configurations selected for testing time-varying Tx power transmission scenario in order to generate test sequences following the test procedures.

Table 7.2.1 Measured Plimit and Pmax of selected radio configurations

TC#	Test Scenario	Antenna	Power Index	Test band	Configuration	Pmax Setting (dBm)	measured Pmax (dBm)	Plimit Setting (dBm)	Measured Plimit (dBm)	Total Uncertainty (dB)
1	Time varying Tx power case 1	TX1_Ant 1	2	WCDMA B5	RMC 12.2Kbps	24	23.92	22.1	21.81	1.1
2		TX1_Ant 0	4	WCDMA B2	RMC 12.2Kbps	23.2	23.29	16.9	17.23	1.1
3		TX1_Ant 0	5	LTE B41 pc2	20M/QPSK/1/0	22.4	22.48	21.4	21.22	0.9
4		TX1_Ant 0	4	LTE B7	20M/QPSK/1/0	23.8	23.36	17.6	17.47	0.9
5		TX1_Ant 1	5	n14 (SA Mode)	15M/BPSK/1/1	24	23.81	23	23.06	0.7
6		TX0_Ant 6	4	n77 pc3 (SA Mode)	100M/BPSK/1/271	24	23.72	17.8	17.78	1.1
7	Time varying Tx power case 2	TX1_Ant 1	2	WCDMA B5	RMC 12.2Kbps	24	23.92	22.1	21.81	1.1
8		TX1_Ant 0	4	WCDMA B2	RMC 12.2Kbps	23.2	23.29	16.9	17.23	1.1
9		TX1_Ant 0	5	LTE B41 pc2	20M/QPSK/1/0	22.4	22.48	21.4	21.22	0.9
10		TX1_Ant 0	4	LTE B7	20M/QPSK/1/0	23.8	23.36	17.6	17.47	0.9
11		TX1_Ant 1	5	n14 (SA Mode)	15M/BPSK/1/1	24	23.81	23	23.06	0.7
12		TX0_Ant 6	4	n77 pc3 (NSA Mode)	100M/BPSK/1/271	24	23.72	17.8	17.78	1.1
13	Change in operating state	TX0_Ant 6	4	n77 pc3 (NSA Mode)	100M/BPSK/1/271	24	23.72	17.8	17.78	1.1
		TX0_Ant 6	3	n77 pc3 (NSA Mode)	100M/BPSK/1/271	24	24.33	22.6	22.67	1.1
14	LTE_to_WCDMA_H.O.	TX0_Ant 6	4	LTE B48pc3	20M/QPSK/1/99	21	21.27	21.8	21.27	1.1
		TX1_Ant 0	4	WCDMA B2	RMC 12.2Kbps	23.2	23.29	16.9	17.23	1.1
15	Call_Disconnect_Reestablishment	TX1_Ant 0	4	LTE B7	20M/QPSK/50/0	23.8	23.36	17.6	17.47	0.9
16	NSA_FR1_Dominant_Power_Switching	TX1_Ant 0	4	LTE B7	20M/QPSK/50/0	23.8	23.34	17.6	17.23	0.9
		TX0_Ant 6	4	n77 pc3 (NSA Mode)	100M/BPSK/1/271	24	23.72	17.8	17.78	1.1
17	NR_TO_LTE_IRAT_HO	TX0_Ant 6	4	n77 pc3 (SA Mode)	100M/BPSK/1/271	24	23.72	17.8	17.78	1.1
		TX1_Ant 0	4	LTE B7	20M/QPSK/1/0	23.8	23.34	17.6	17.23	0.9
18	UL CA	TX1_Ant 0	4	LTE B7_PCC	20M/QPSK/1/0	23.8	23.36	17.6	17.47	0.9
				LTE B7_PCC + SCC	20M/QPSK/1/0 + 20M/QPSK/1/99	23.8	23.36		17.47	

Note that the EUT has multiple power indexes to manage the output power for different conditions corresponding to RF exposure conditions in above table, detailed power index trigger conditions are illustrated in the operational description, and 1g and 10g SAR design target are shown in the part 0 report.

TC#	Test Scenario	Antenna	Polarization	Power Index	Test band	Configuration	Pmax Stting (dBm)	measured Pmax (dBm)	Plimit Setting (dBm)	Measured Plimit (dBm)	Measured EIRP (dBm)	Device Uncertainty (dB)
1	Time-varying Tx power transmission	0	-	7	LTE B2	20M/QPSK/1/0	23.2	23.5	17.4	17	-	0.8
		Plane A	H+V	-	n260	100M/QPSK/1/0	-	-	9.68	-	12.3	2.3
2	SAR exposure switch	0	-	7	LTE B2	20M/QPSK/1/0	23.2	23.5	17.4	17	-	0.8
		Plane A	H+V	-	n260	100M/QPSK/1/0	-	-	9.68	-	12.3	2.3
3	Change of beam	Plane A	H+V	-	n260	100M/QPSK/1/0	-	-	9.68	-	12.3	2.3
		Plane B	H+V	-	n260	100M/QPSK/1/0	-	-	10.35	-	12.8	2.3
		Plane A	H+V	-	n260	100M/QPSK/1/0	-	-	9.68	-	12.3	2.3

Plimit setting which can be referenced from Part 0 report is for single polarization, so the dual-pol EIRP target is equivalent to Plimit plus 3dB.



7.2.1 Sub-6 summary test results

TC#	Test Scenario	Antenna	Power Index	Test band	Configuration	Total Uncertainty (dB)	1g SAR design target (W/kg)	1g Time average SAR (W/kg)	deviation (dB)
1	Time varying Tx power case 1	TX1_Ant 1	2	WCDMA B5	RMC 12.2Kbps	1.1	0.78	0.656	-0.75
2		TX1_Ant 0	4	WCDMA B2	RMC 12.2Kbps	1.1	0.66	0.667	0.05
3		TX1_Ant 0	5	LTE B41 pc2	20M/QPSK/1/0	0.9	0.81	0.701	-0.63
4		TX1_Ant 0	4	LTE B7	20M/QPSK/1/0	0.9	0.69	0.624	-0.44
5		TX1_Ant 1	5	n14 (SA Mode)	15M/BPSK/1/1	0.7	0.85	0.77	-0.43
6		TX0_Ant 6	4	n77 pc3 (SA Mode)	100M/BPSK/1/271	1.1	0.66	0.661	0.01
7	Time varying Tx power case 2	TX1_Ant 1	2	WCDMA B5	RMC 12.2Kbps	1.1	0.78	0.629	-0.93
8		TX1_Ant 0	4	WCDMA B2	RMC 12.2Kbps	1.1	0.66	0.631	-0.20
9		TX1_Ant 0	5	LTE B41 pc2	20M/QPSK/1/0	0.9	0.81	0.675	-0.79
10		TX1_Ant 0	4	LTE B7	20M/QPSK/1/0	0.9	0.69	0.58	-0.75
11		TX1_Ant 1	5	n14 (SA Mode)	15M/BPSK/1/1	0.7	0.85	0.731	-0.66
12		TX0_Ant 6	4	n77 pc3 (NSA Mode)	100M/BPSK/1/271	1.1	0.66	0.646	-0.09
13	Change in operating state	TX0_Ant 6	4	n77 pc3 (NSA Mode)	100M/BPSK/1/271	1.1	0.66	0.686	0.17
		TX0_Ant 6	3	n77 pc3 (NSA Mode)	100M/BPSK/1/271	1.1	0.66	0.686	0.17
14	LTE_to_WCDMA_H.O.	TX0_Ant 6	4	LTE B48pc3	20M/QPSK/1/99	1.1	0.66	0.665	0.03
		TX1_Ant 0	4	WCDMA B2	RMC 12.2Kbps	1.1	0.66	0.665	0.03
15	Call_Disconnect_Reestablishment	TX1_Ant 0	4	LTE B7	20M/QPSK/50/0	0.9	0.69	0.576	-0.78
16	NSA_FR1_Dominant_Power_Switching	TX1_Ant 0	4	LTE B7	20M/QPSK/50/0	0.9	0.69	0.609	-0.54
		TX0_Ant 6	4	n77 pc3 (NSA Mode)	100M/BPSK/1/271	1.1	0.66	0.609	-0.35
17	NR_TO_LTE_IRAT_HO	TX0_Ant 6	4	n77 pc3 (SA Mode)	100M/BPSK/1/271	1.1	0.66	0.651	-0.06
		TX1_Ant 0	4	LTE B7	20M/QPSK/1/0	0.9	0.69	0.651	-0.25
18	UL CA	TX1_Ant 0	4	LTE B7_PCC	20M/QPSK/1/0	0.9	0.69	0.627	-0.42
				LTE B7_PCC + SCC	20M/QPSK/1/0 + 20M/QPSK/1/99				

TC#	Test Scenario	Antenna	Power Index	Test band	Configuration	1g SAR design target (W/kg)	PD design target (Mw/cm^2)	TER	PD design target + total uncertainty	Total Uncertainty (dB)
1	Time-varying Tx power transmission 1	0	4	LTE B2	20M_QPSK_1_0	0.71	-	0.539	0.75	2.3
2		Plane A	-	260	100M_QPSK_1_1	-	4.42			
3	SAR exposure switch	0	4	LTE B2	20M_QPSK_1_0	0.63	-	0.508	0.75	2.3
4		Plane A	-	260	100M_QPSK_1_1	-	4.42			
5	Change of beam	0	4	LTE B2	100M_QPSK_1_1	0.63	-	0.652	0.75	2.3
6		Plane A To Plane B	-	260	100M_QPSK_1_1	-	4.42			

7.3 Time-varying Tx power measurement results

Following the test procedure in Section 3, the conducted Tx power measurement results for all selected test cases are listed in this section. In all conducted Tx power plots, the blue line shows the measured instantaneous power using the power meter, the red line shows the time-averaged Tx power and yellow line shows the Plimit value corresponding to design target. In all SAR plots, the dotted blue line shows the time-averaged 1gSAR while the red line shows the corresponding FCC limit of 1.6W/Kg. Time-varying Tx power measurements were conducted for TC#1 - 12 in Table 7.2.1 by generating the test sequence A or B given in Appendix.

7.3.1 TC01: WCDMA B5_Time_Varying_Tx_Power_Case_1

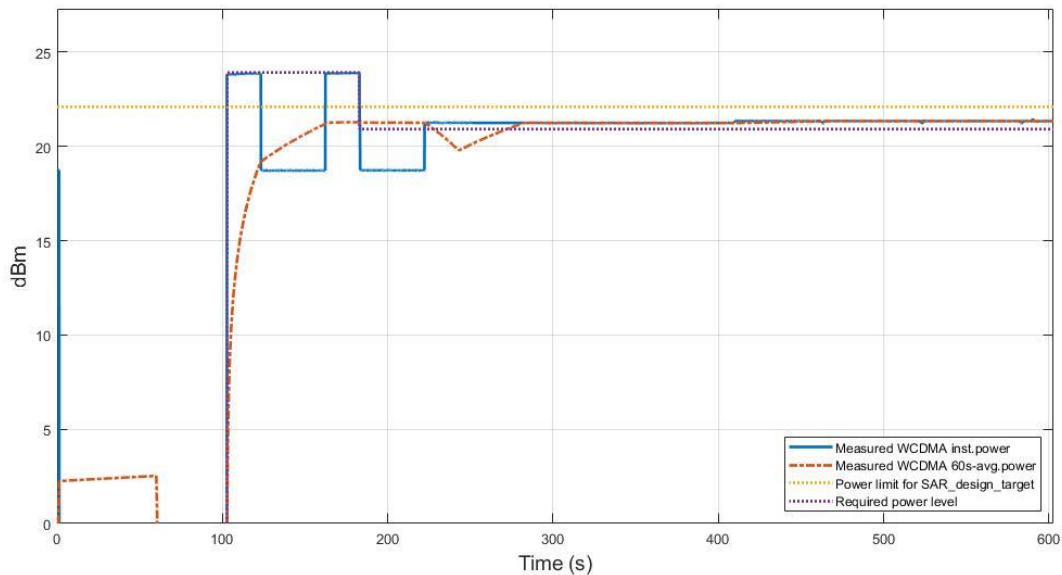

Figure 7.3-1 Time average conducted power

Figure 7.3-1 shows the conducted Tx power plot with calculated time-averaged power based on the measured instantaneous Tx power with 1gSAR FCC Limit value. As shown in Figure 7.3-1, it is confirmed for time- average Tx power that the FCC limit was not exceeded, and that the averaged Tx power is smaller than the target power, and it will saturate to target power with little margin. Figure 7.3-2 shows the plot of calculated time-averaged 1gSAR for this test demonstrating that exposure is well below the FCC limit of 1.6W/Kg.

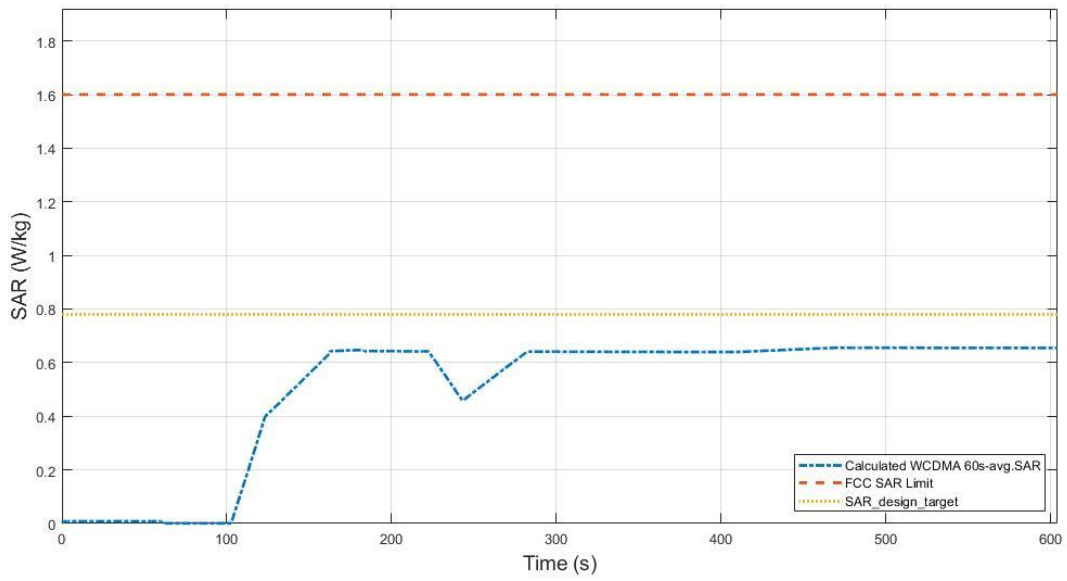

Figure 7.3-2 Total time-averaged SAR

FCC 1gSAR limit	1.6 W/kg
Max time average 1gSAR (blue curve)	0.656 W/kg
Device uncertainty	1.1 dB

7.3.2 TC02: WCDMA B2_Time_Varying_Tx_Power_Case_1

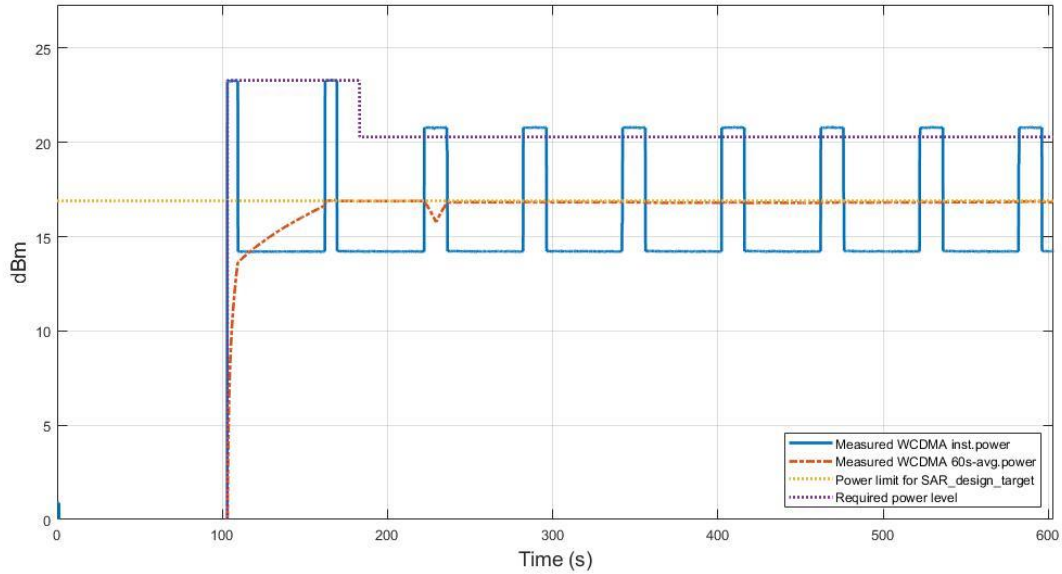

Figure 7.3-3 Time-average conducted power

Figure 7.3-3 shows the instantaneous and time-averaged Tx power for this test. As shown in Figure 7.3-3, it is confirmed for time-average Tx power that the FCC limit was not exceeded, and that the averaged Tx power is lower than the value of P_{limit}. Figure 7.3-4 shows the plot of calculated time-averaged 1gSAR for this test demonstrating that exposure is well below the FCC limit of 1.6W/Kg.

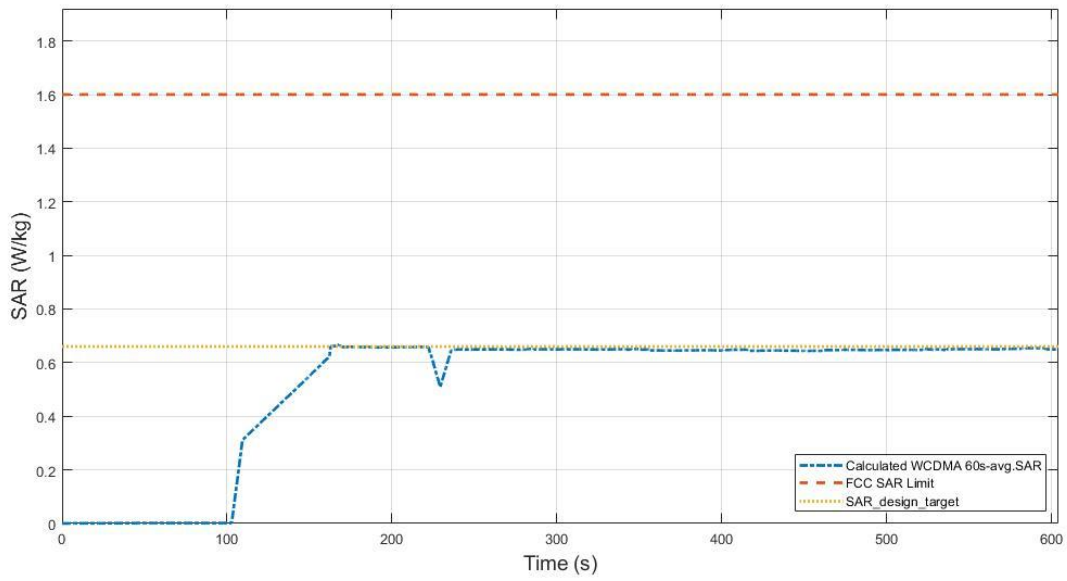

Figure 7.3-4 Total time-averaged SAR

FCC 1gSAR limit	1.6 W/kg
Max time average 1gSAR (blue curve)	0.667 W/kg
Device uncertainty	1.1 dB

7.3.3 TC03: LTE Band 41_Time_Varying_Tx_Power_Case_1

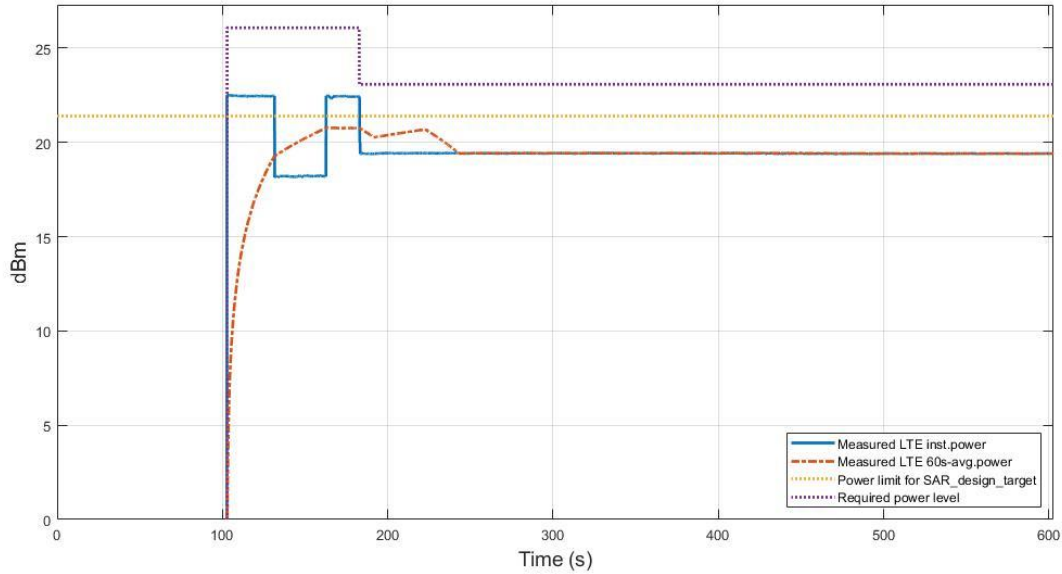

Figure 7.3-5 Time-average conducted power

Figure 7.3-5 shows the instantaneous and time-averaged Tx power for this test. As shown in Figure 7.3-5, it is confirmed for time-average Tx power that the FCC limit was not exceeded, and that the averaged Tx power is lower than the value of P_{limit}. Figure 7.3-6 shows the plot of calculated time-averaged 1gSAR for this test demonstrating that exposure is well below the FCC limit of 1.6W/Kg.

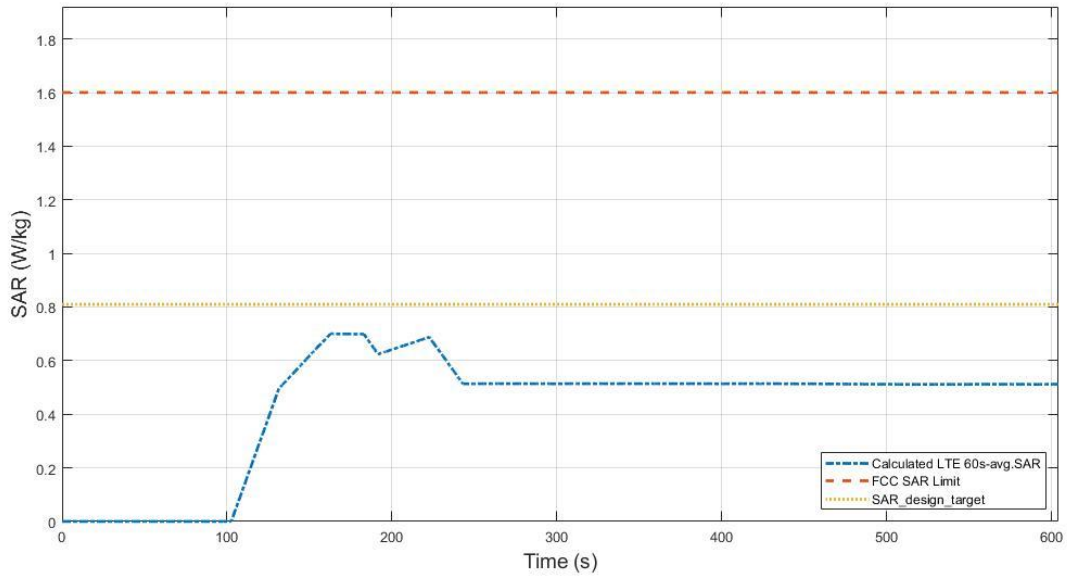

Figure 7.3-6 Total time-averaged SAR

FCC 1gSAR limit	1.6 W/kg
Max time average 1gSAR (blue curve)	0.701 W/kg
Device uncertainty	0.9 dB

7.3.4 TC04: LTE Band 7_Time_Varying_Tx_Power_Case_1

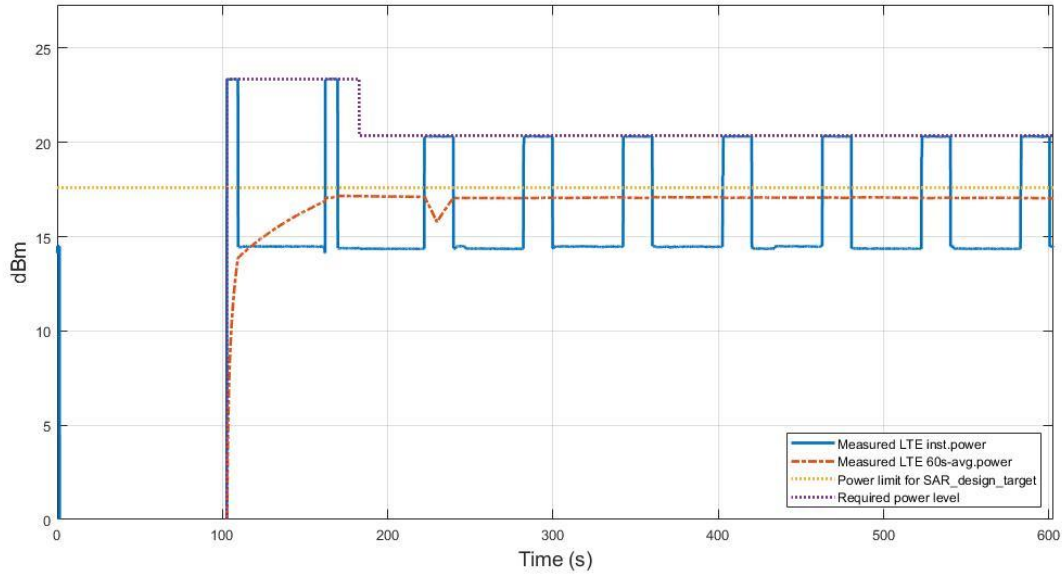

Figure 7.3-7 Time-average conducted power

Figure 7.3-7 shows the instantaneous and time-averaged Tx power for this test. As shown in Figure 7.3-7, it is confirmed for time-average Tx power that the FCC limit was not exceeded, and that the averaged Tx power is lower than the value of P_{limit}. Figure 7.3-8 shows the plot of calculated time-averaged 1gSAR for this test demonstrating that exposure is well below the FCC limit of 1.6W/Kg.

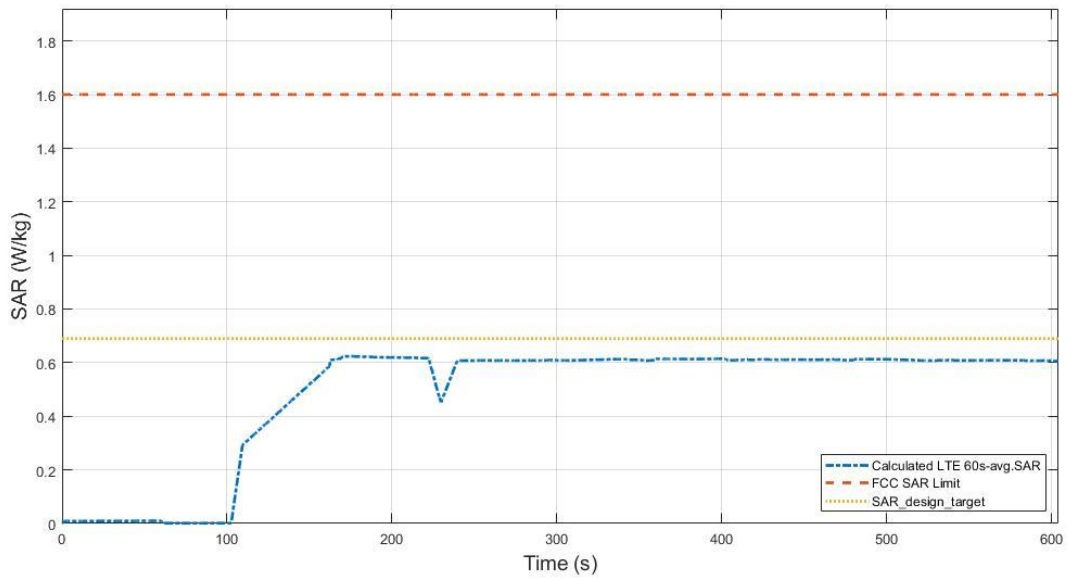

Figure 7.3-8 Total time-averaged SAR

FCC 1gSAR limit	1.6 W/kg
Max time average 1gSAR (blue curve)	0.624 W/kg
Device uncertainty	0.9 dB

7.3.5 TC05: FR1 n14 SA mode_Time_Varying_Tx_Power_Case_1

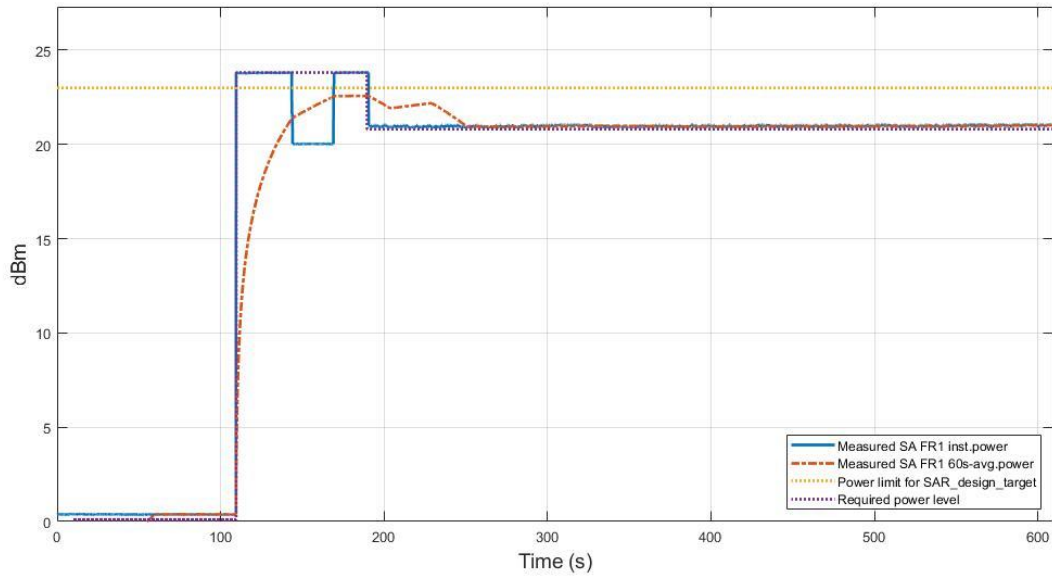

Figure 7.3-9 Conducted Tx power

Figure 7.3-9 shows the instantaneous and time-averaged Tx power with test sequence B. Figure 7.3-10 shows the plot of calculated time-averaged 1gSAR for this test demonstrating that exposure is well below the FCC limit of 1.6W/Kg.

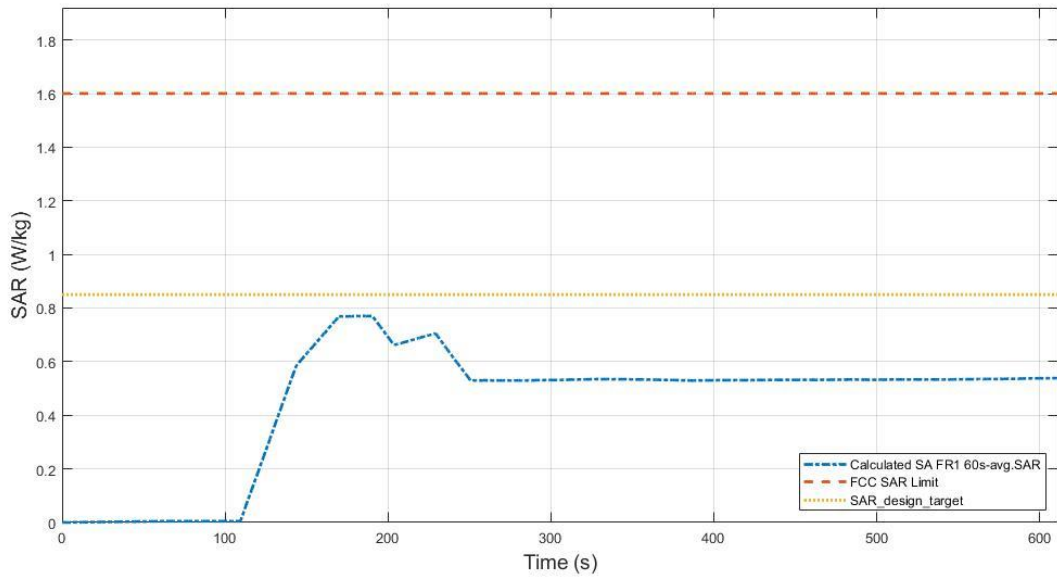

Figure 7.3-10 Total time-averaged SAR

FCC 1gSAR limit	1.6 W/kg
Max time average 1gSAR (blue curve)	0.770 W/kg
Device uncertainty	0.7 dB

7.3.6 TC06: FR1 n77 SA mode_Time_Varying_Tx_Power_Case_1

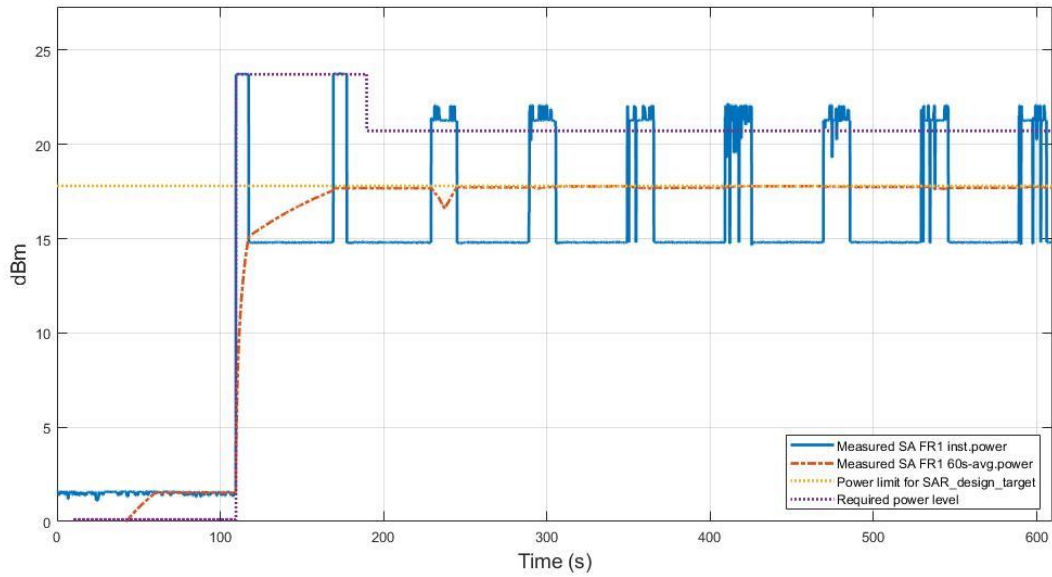

Figure 7.3-11 Conducted Tx power

Figure 7.3-11 shows the instantaneous and time-averaged Tx power with test sequence B. Figure 7.3-12 shows the plot of calculated time-averaged 1gSAR for this test demonstrating that exposure is well below the FCC limit of 1.6W/Kg.

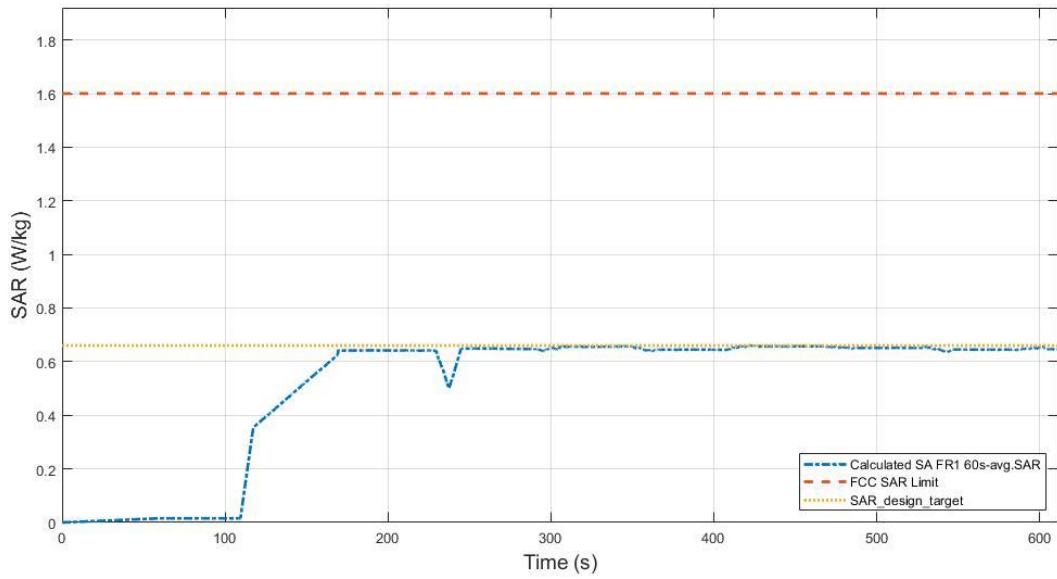

Figure 7.3-12 Total time-averaged SAR in F_TC04

FCC 1gSAR limit	1.6 W/kg
Max time average 1gSAR (blue curve)	0.661 W/kg
Device uncertainty	1.1 dB

7.3.7 TC07: WCDMA B5_Time_Varying_Tx_Power_Case_2

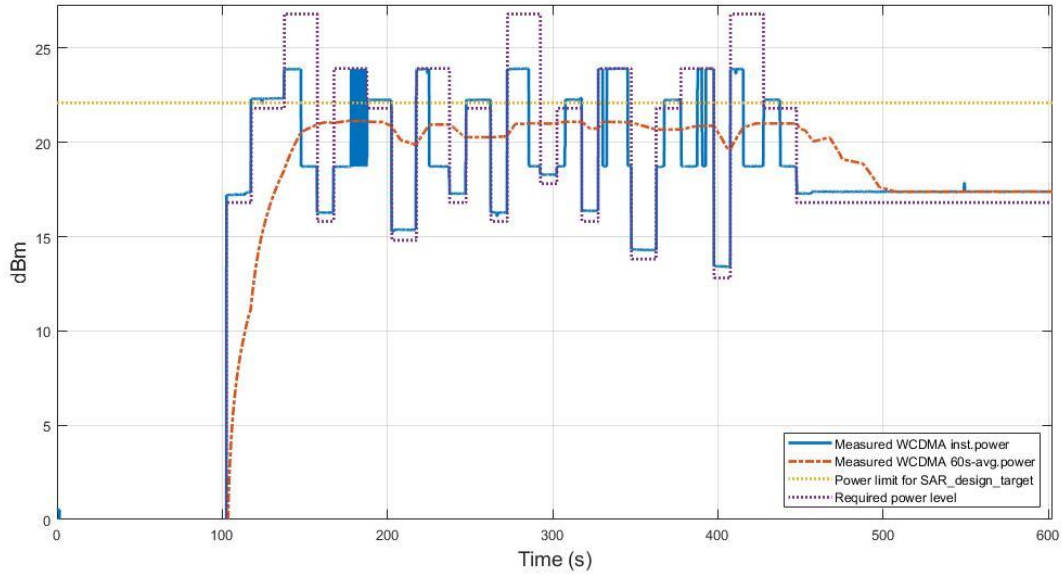

Figure 7.3-13 Conducted Tx power

Figure 7.3-13 shows the instantaneous and time-averaged Tx power with test sequence B. Figure 7.3-14 shows the plot of calculated time-averaged 1gSAR for this test demonstrating that exposure is well below the FCC limit of 1.6W/Kg.

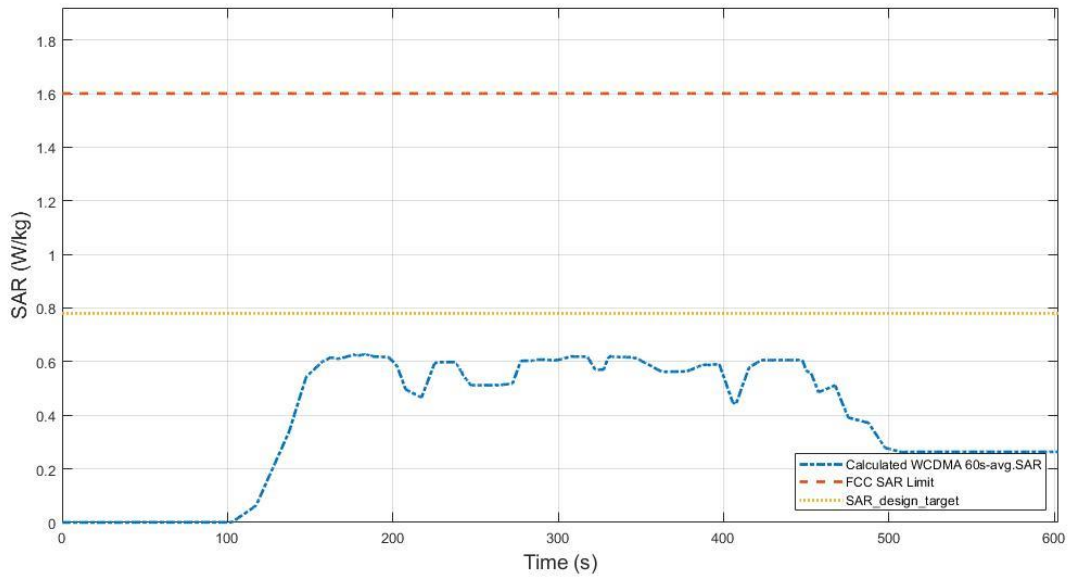

Figure 7.3-14 Total time-averaged SAR

FCC 1gSAR limit	1.6 W/kg
Max time average 1gSAR (blue curve)	0.629 W/kg
Device uncertainty	1.1 dB

7.3.8 TC08: WCDMA B2_Time_Varying_Tx_Power_Case_2

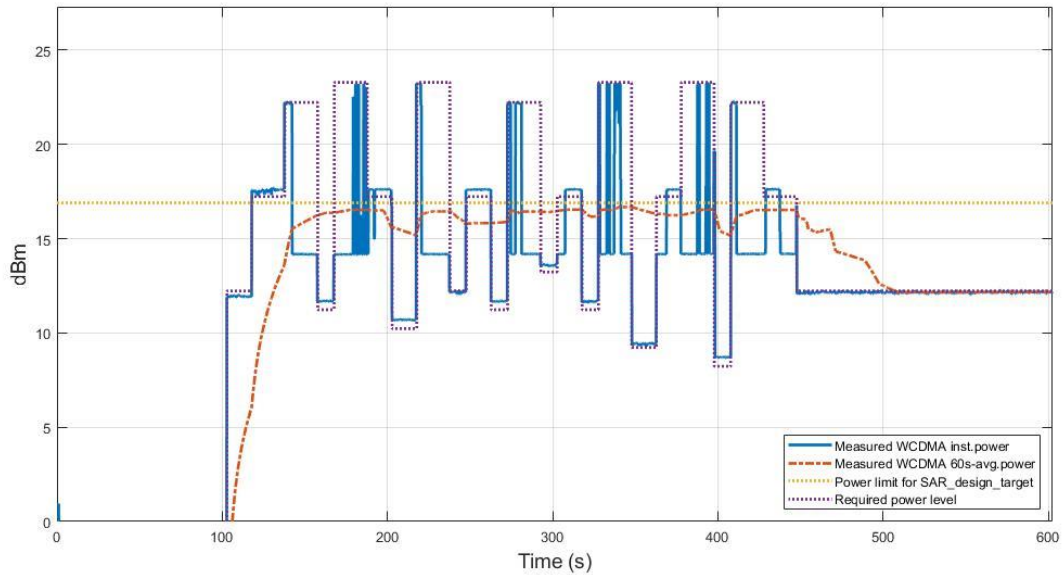

Figure 7.3-15 Conducted Tx power

Figure 7.3-15 shows the instantaneous and time-averaged Tx power with test sequence B. Figure 7.3-16 shows the plot of calculated time-averaged 1gSAR for this test demonstrating that exposure is well below the FCC limit of 1.6W/Kg.

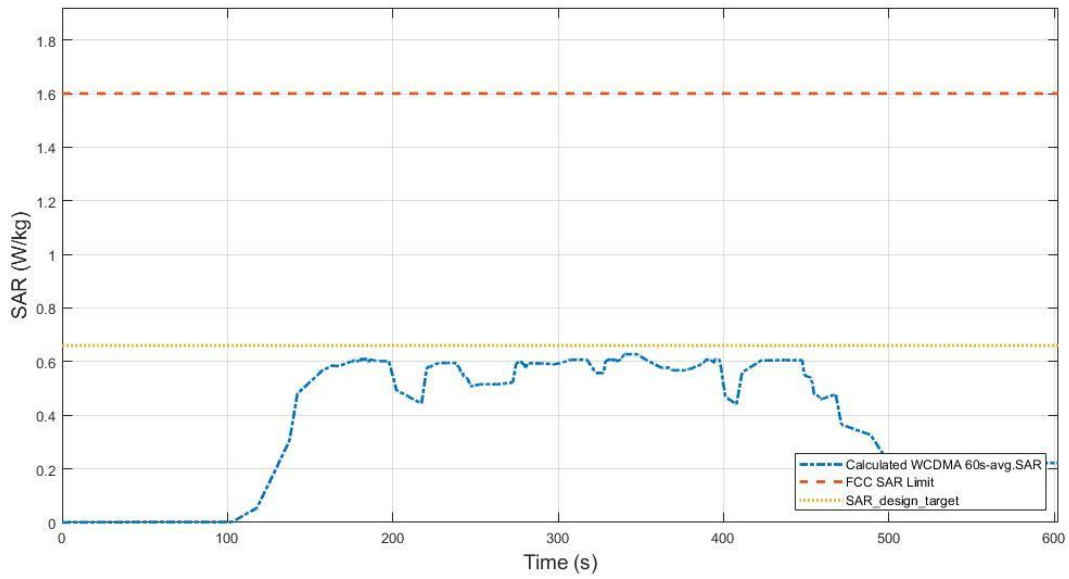

Figure 7.3-16 Total time-averaged SAR

FCC 1gSAR limit	1.6 W/kg
Max time average 1gSAR (blue curve)	0.631 W/kg
Device uncertainty	1.1 dB

7.3.9 TC09: LTE Band 41_Time_Varying_Tx_Power_Case_2

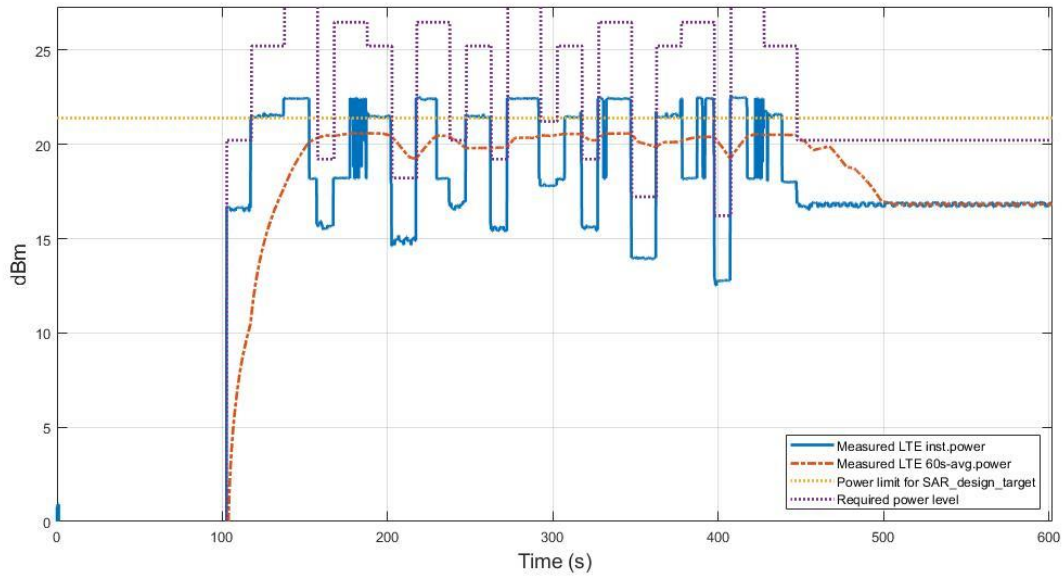

Figure 7.3-17 Conducted Tx power

Figure 7.3-17 shows the instantaneous and time-averaged Tx power with test sequence B. Figure 7.3-18 shows the plot of calculated time-averaged 1gSAR for this test demonstrating that exposure is well below the FCC limit of 1.6W/Kg.

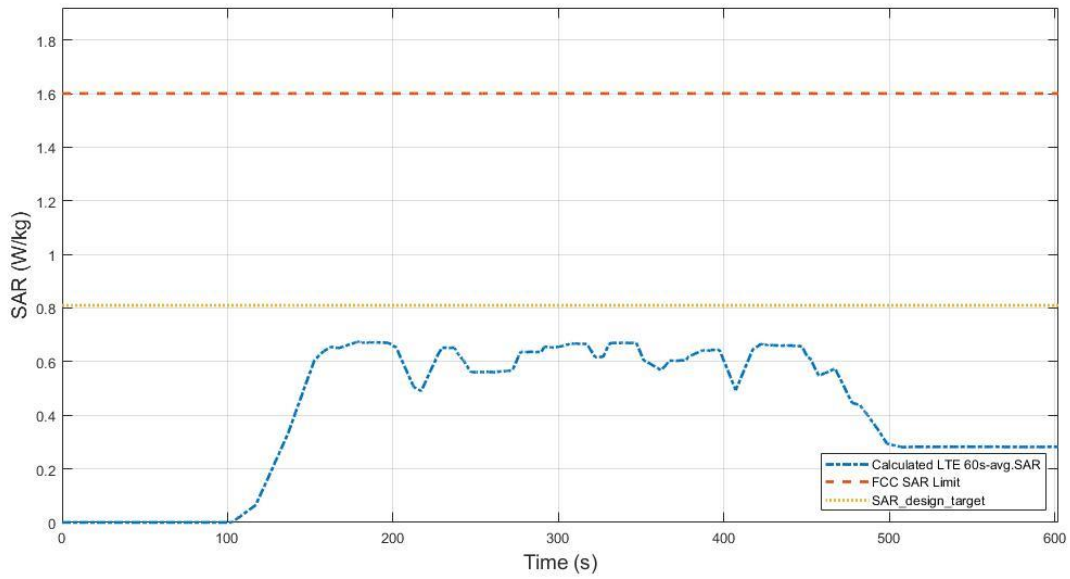

Figure 7.3-18 Total time-averaged SAR

FCC 1gSAR limit	1.6 W/kg
Max time average 1gSAR (blue curve)	0.675 W/kg
Device uncertainty	0.9 dB

7.3.10 TC10: LTE Band 7_Time_Varying_Tx_Power_Case_2

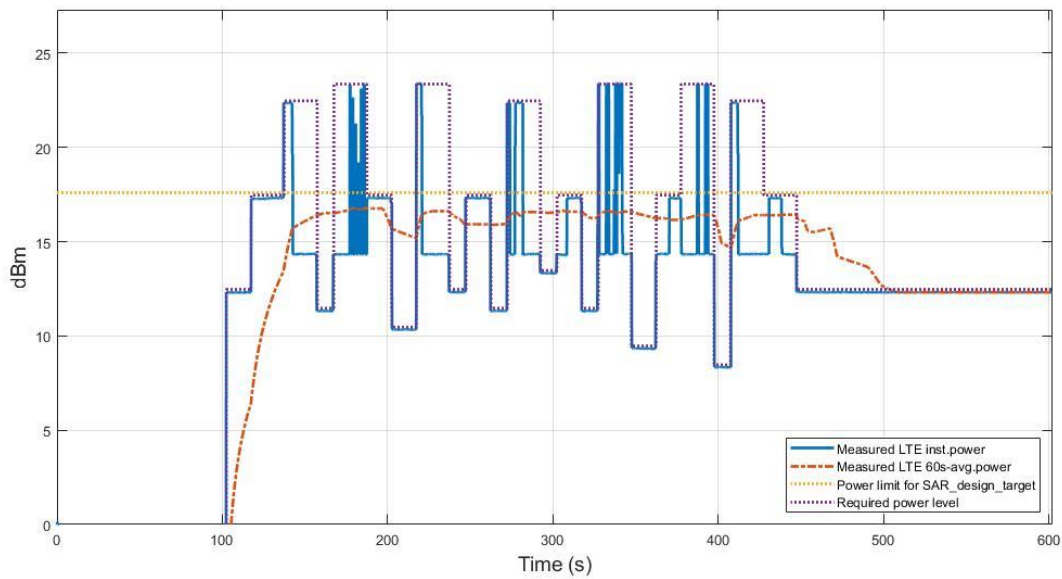

Figure 7.3-19 Conducted Tx power

Figure 7.3-19 shows the instantaneous and time-averaged Tx power with test sequence B. Figure 7.3-20 shows the plot of calculated time-averaged 1gSAR for this test demonstrating that exposure is well below the FCC limit of 1.6W/Kg.

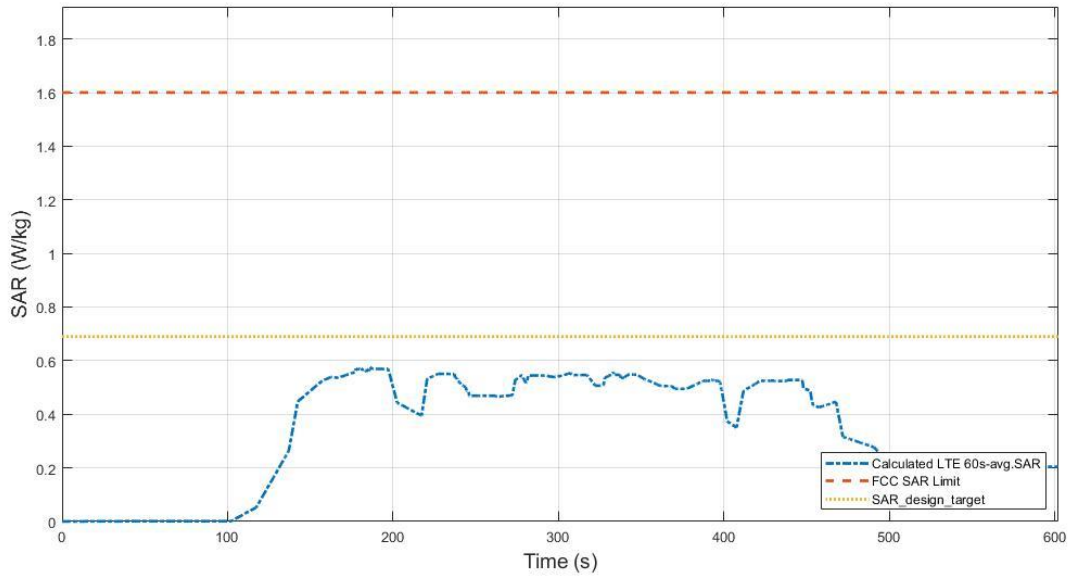

Figure 7.3-20 Total time-averaged SAR

FCC 1gSAR limit	1.6 W/kg
Max time average 1gSAR (blue curve)	0.580 W/kg
Device uncertainty	0.9 dB

7.3.11

TC11: FR1 n14 SA mode _Time_Varying_Tx_Power_Case_2

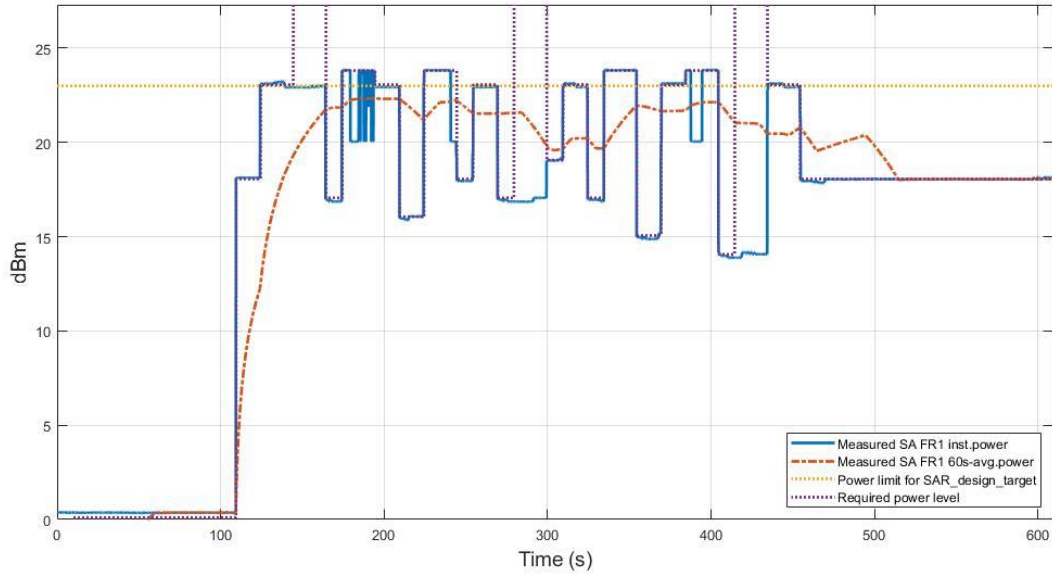

Figure 7.3-21 Conducted Tx power

Figure 7.3-21 shows the instantaneous and time-averaged Tx power with test sequence B. Figure 7.3-22 shows the plot of calculated time-averaged 1gSAR for this test demonstrating that exposure is well below the FCC limit of 1.6W/Kg.

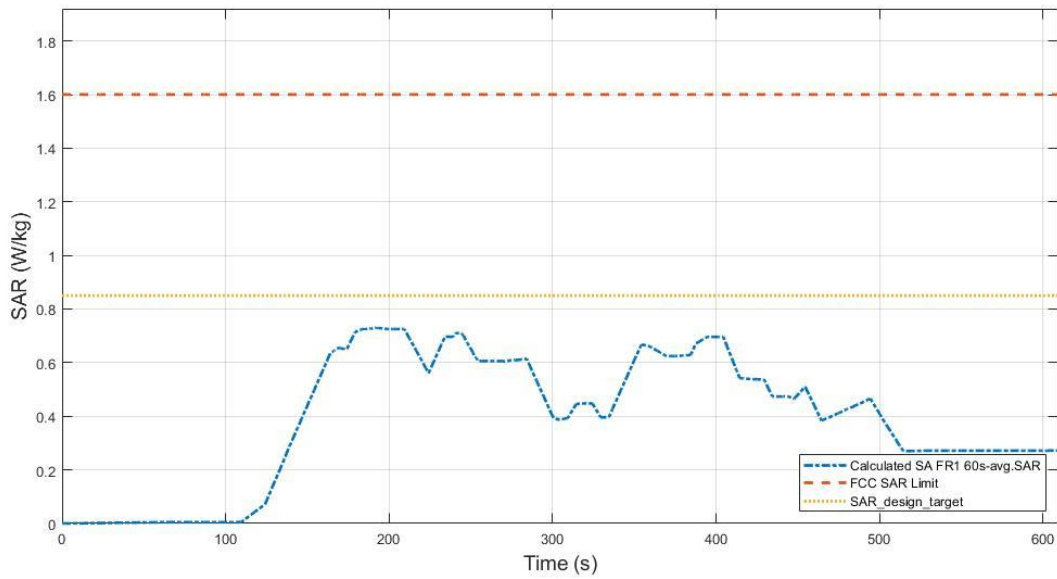

Figure 7.3-22 Total time-averaged SAR

FCC 1gSAR limit	1.6 W/kg
Max time average 1gSAR (blue curve)	0.731 W/kg
Device uncertainty	0.7 dB

7.3.12

TC12: FR1 n77 SA mode_Time_Varying_Tx_Power_Case_2

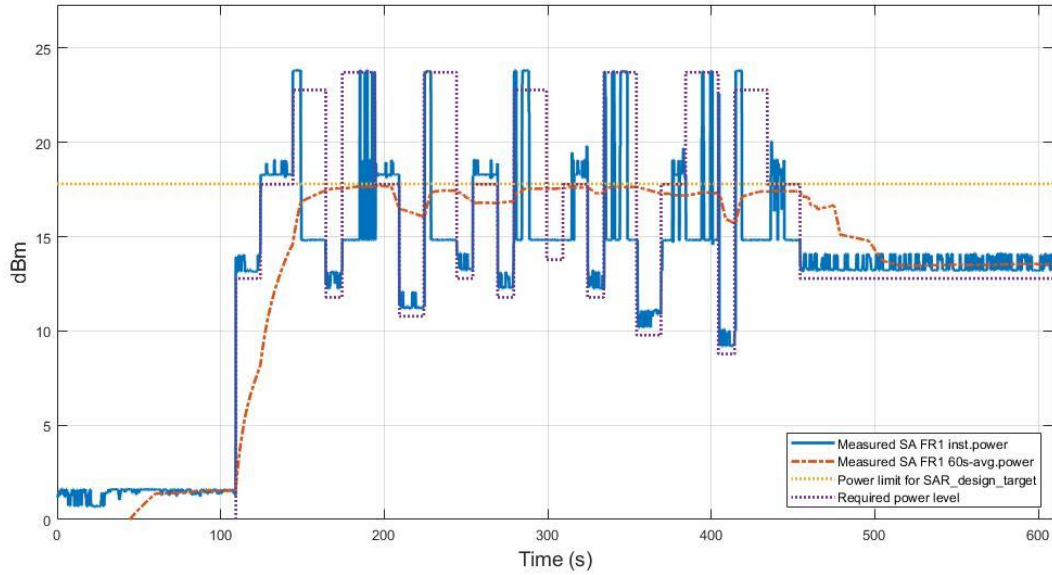

Figure 7.3-23 Conducted Tx power

Figure 7.3-23 shows the instantaneous and time-averaged Tx power with test sequence B. Figure 7.3-24 shows the plot of calculated time-averaged 1gSAR for this test demonstrating that exposure is well below the FCC limit of 1.6W/Kg.

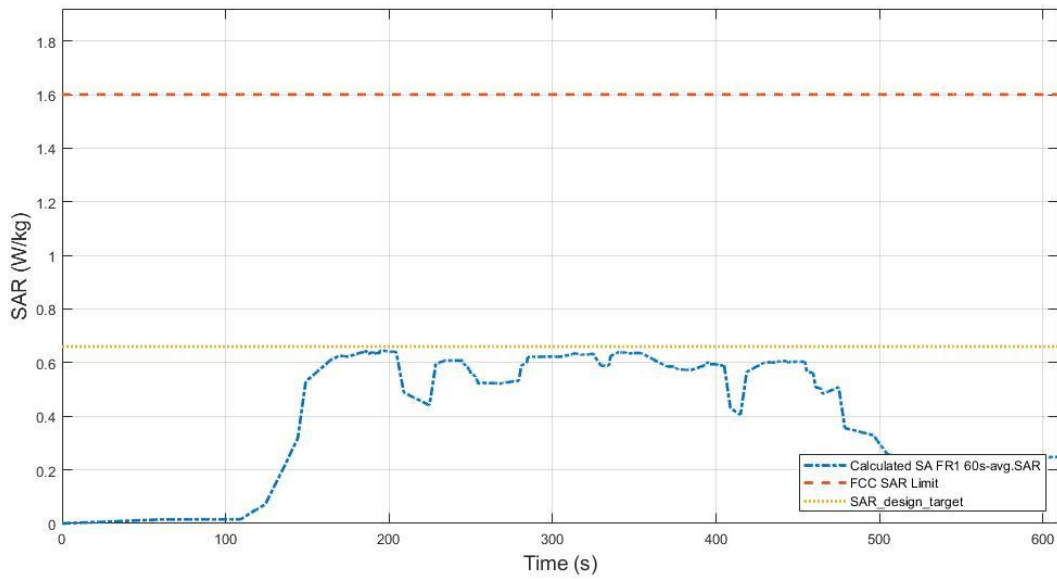

Figure 7.3-24 Total time-averaged SAR

FCC 1gSAR limit	1.6 W/kg
Max time average 1gSAR (blue curve)	0.646 W/kg
Device uncertainty	1.1 dB

7.4 Change operate states

The test results in this section are obtained following the procedure in Section 3. The test cases correspond to TC#13 in Table 7.2.1.

7.4.1 TC13: SA_FR1 n77_RF_SAR_Index_Change

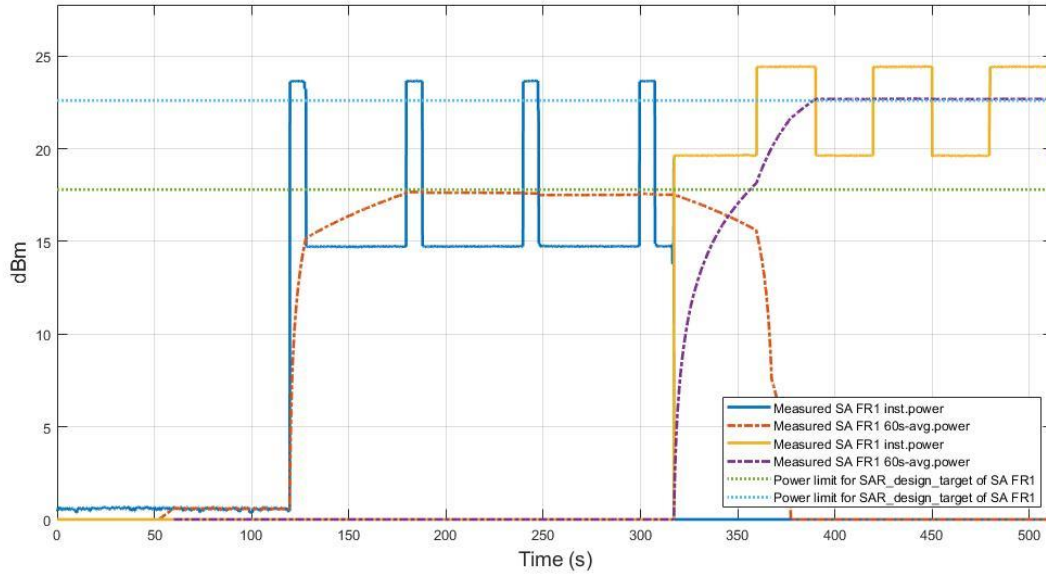

Figure 7.4-1 Conducted Tx power for SAR states change

Figure 7.4-1 shows the instantaneous and time-averaged conducted Tx power for both SA FR1 n77 for the duration of the test. Around time stamp of ~330s, the RFI value is changed from index 4 to index 3, resulting in reduction of target time-averaged power of SA FR1 n77. It can be seen that Plimit value of index 3 is lower than that of index 4, so in index 3 region, more Tx power is limited compared to index 4 region. Figure 7.4-2 shows the time-averaged 1gSAR value for each of index 3 and index 4 value, as well as the total SAR value.

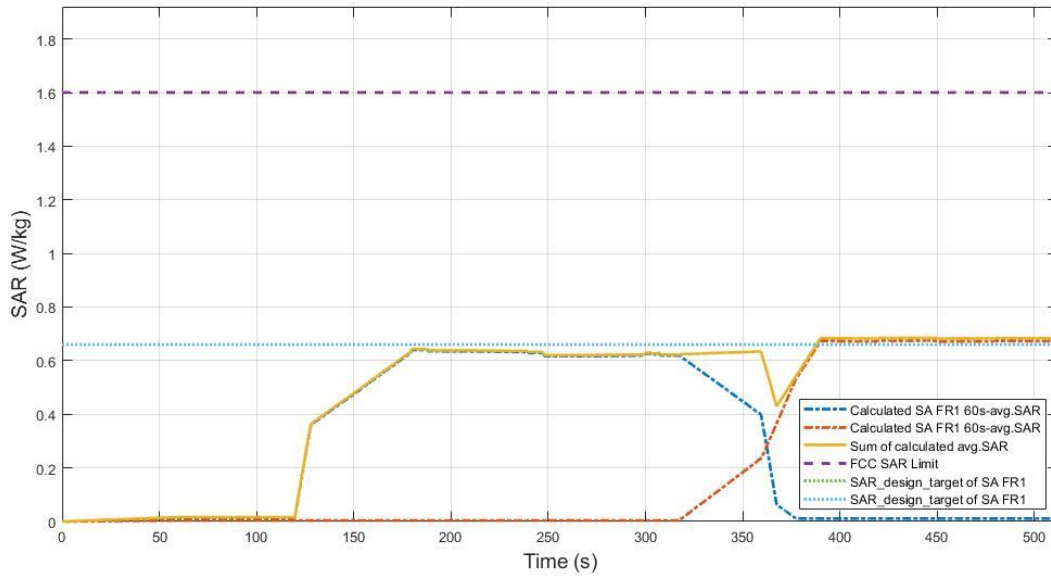

Figure 7.4-2 Total time-averaged SAR

FCC 1gSAR limit	1.6 W/kg
Max sum of calculated average SARs (yellow curve)	0.686 W/kg
Device uncertainty	1.1 dB

7.5 LTE Handover WCDMA results

The test results in this section are obtained following the procedure in Section 3. The test cases correspond to TC#14 in Table 7.2.1.

7.5.1 TC14: Wireless technology Handover

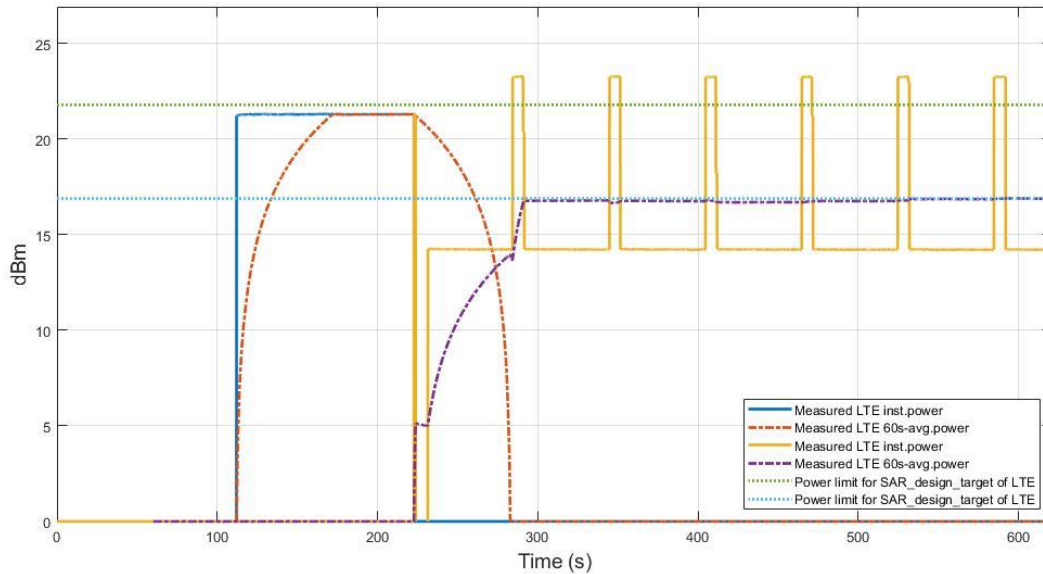

Figure 7.5-1 Conducted Tx power for Wireless technology Handover

Figure 7.5-1 shows the instantaneous and time-averaged conducted Tx power for both LTE B48 and WCDMA B2 for the duration of the test. Around time stamp of ~220s, a handover from LTE B48 to WCDMA B2 was executed, resulting in reduction of time-averaged power of LTE B48 and simultaneous increase in time- averaged power of WCDMA B2. Figure 7.5-2 shows the time-averaged 1gSAR value for each of LTE B48 and WCDMA B2, as well as the total SAR value.

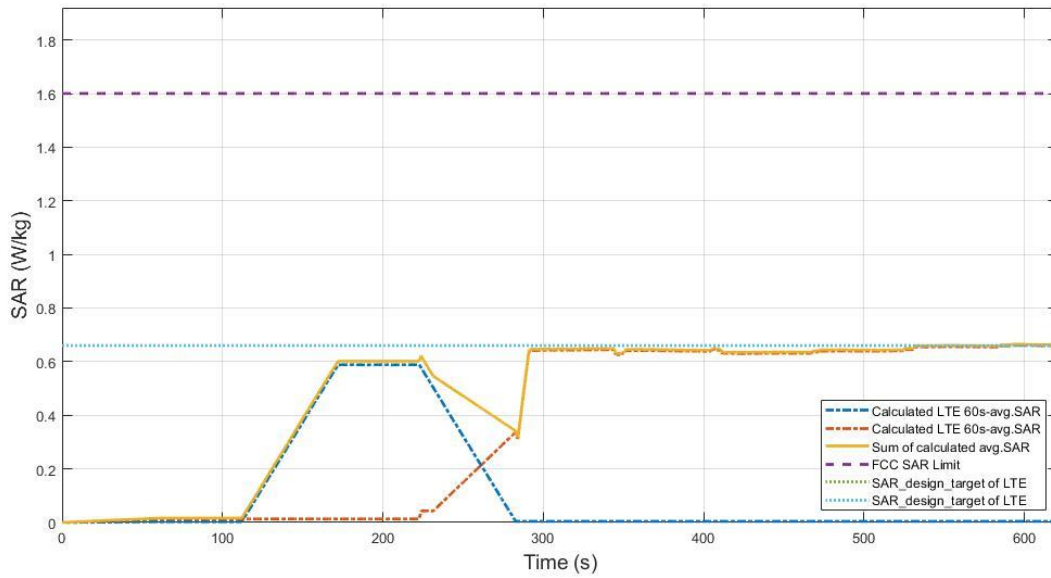

Figure 7.5-2 Total time-averaged SAR

FCC 1gSAR limit	1.6 W/kg
Max sum of calculated average SARs (yellow curve)	0.665 W/kg
Device uncertainty	1.1 dB

7.6 Change in call test results

The test results in this section are obtained following the procedure in Section 3. The test case corresponds to TC#15 in Table 7.2.1.

7.7.1 TC17: LTE Band 7_Call_Disconnect_Reestablishment

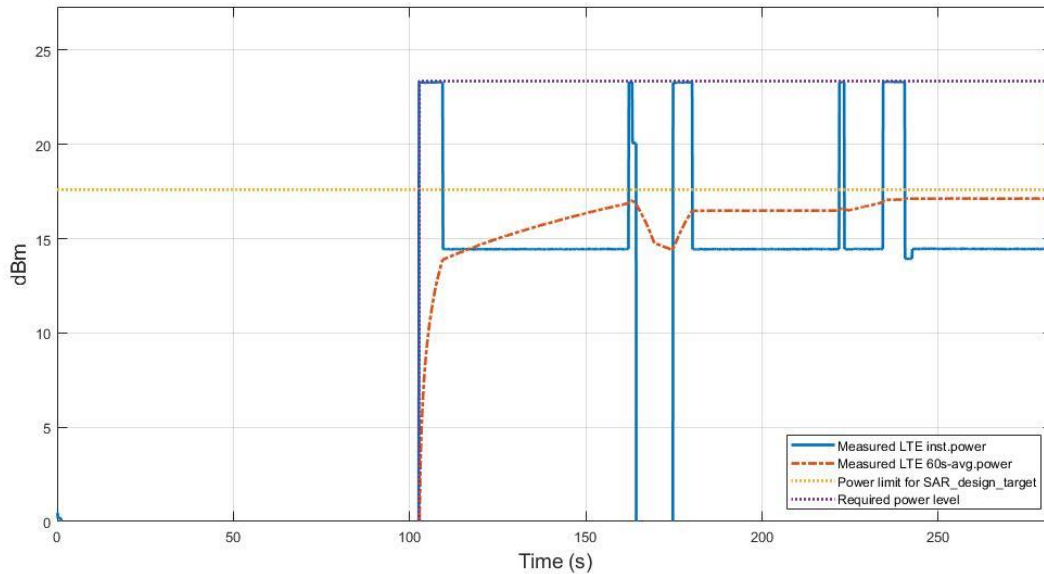

Figure 7.7-1 Conducted Tx power in Call_Disconnect_Reestablishment

Figure 7.7-1 shows the instantaneous and time-averaged Tx power for this test. The call disconnected around 170s and resumed after 10s. It is confirmed for time-average Tx power that the FCC limit was not exceeded, and that the averaged Tx power is lower than the value of P_{limit}. Figure 7.7-2 shows the plot of calculated time-averaged 1gSAR for this test demonstrating that exposure is well below the FCC limit of 1.6W/Kg. Looking at the results, it can be seen that even if transmission is stopped due to a call drop, the SAR value measured for a period of time window is stored in the window section and is continuously checked.

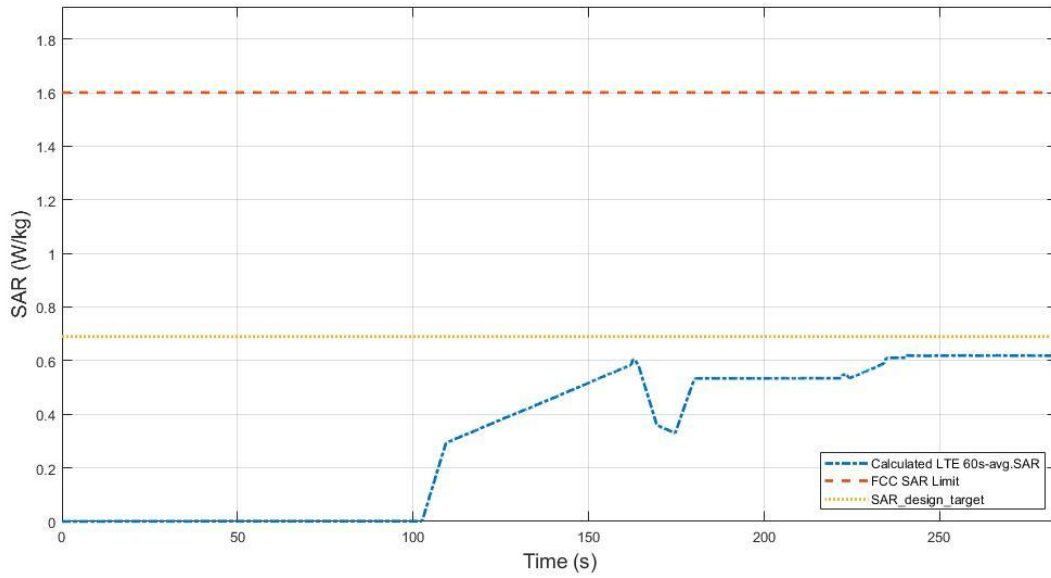

Figure 7.7-2 Total time-averaged SAR

FCC 1gSAR limit	1.6 W/kg
Max time average 1gSAR (blue curve)	0.576 W/kg
Device uncertainty	0.9 dB

7.7 Switch in SAR exposure test results

The test results in this section are obtained following the procedure in Section 3. The test cases correspond to TC#16 in Table 7.2.1.

7.8.1 TC18: NSA_FR1_Dominant_Power_Switching (ENDC LTE B7_FR1 n77)

In this LTE B7+FR1 n77 NSA scenario, we first establish LTE and NR call. In the first part of test, LTE is sent to lowest transmit power using “ALL DOWN” power control commands from call box while NR is sent to maximum power using “ALL UP” power control commands from call box. This would correspond to FR1 dominant SAR scenario and lasts about 110s. In the second part of test, LTE is sent “ALL UP” commands and transmissions are continued, resulting in LTE+FR1 SAR scenario lasting another 110s. In the third part of test, NR is sent “ALL DOWN” power control commands so that it becomes an FR1 dominant SAR scenario for 110s. Finally, both LTE and NR connections are released.

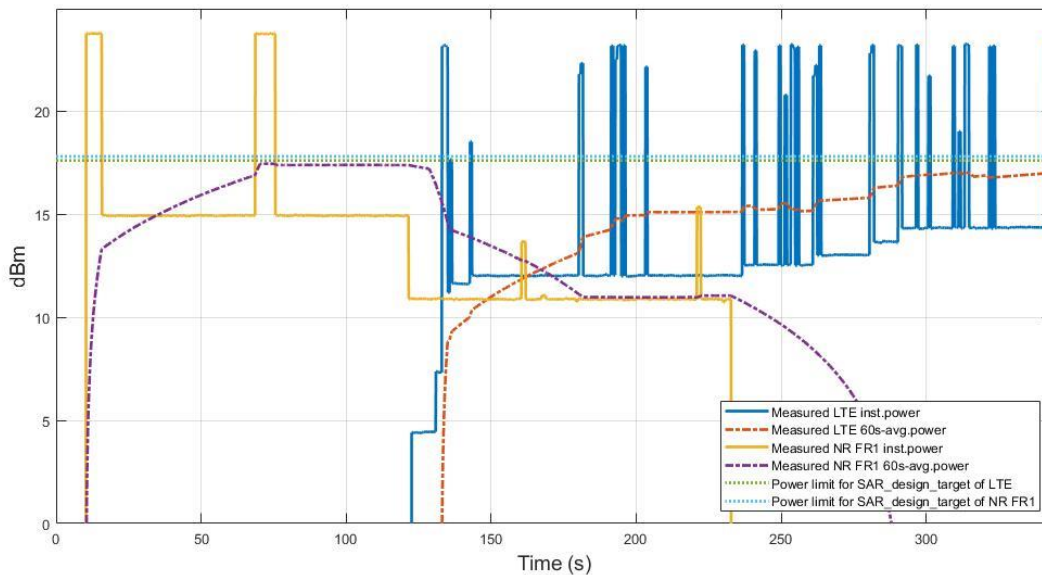

Figure 7.8-1 Time average SAR of LTE B7 and FR1 n77 in EN-DC case

Figure 7.8-1 shows the instantaneous and time-averaged Tx power for both LTE band B7 and NR FR1 band n77 versus time. When both LTE and FR1 operate, the SAR value was the highest instantaneously, but it can be seen that sum of average power in LTE and FR1 decreases again as soon as it is turned off. Figure 7.8-2 shows the computed time-averaged SAR value for LTE and FR1 as well as the sum. It was confirmed that algorithm operated under the SAR design target + total uncertainty, while also being under the FCC limit of 1.6W/Kg at all times. After the operation of FR1 is turned off, it can also be seen that the average power of LTE increases.

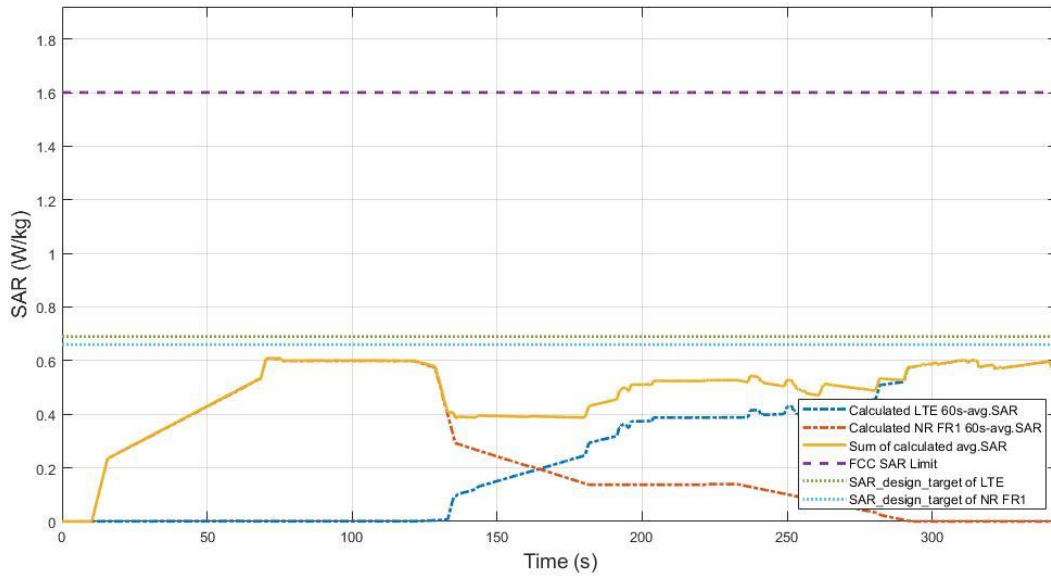

Figure 7.8-2 Total time-averaged SAR

FCC 1gSAR limit	1.6 W/kg
Max sum of calculated average SARs (yellow curve)	0.609 W/kg
Device uncertainty	1.1 dB

7.8 Re-selection in call test results

The test results in this section are obtained following the procedure in Section 3. The test cases correspond to TC#17 in Table 7.2.1.

7.9.1 TC19: FR1 n77 to LTE Band 7 IRAT Re-selection

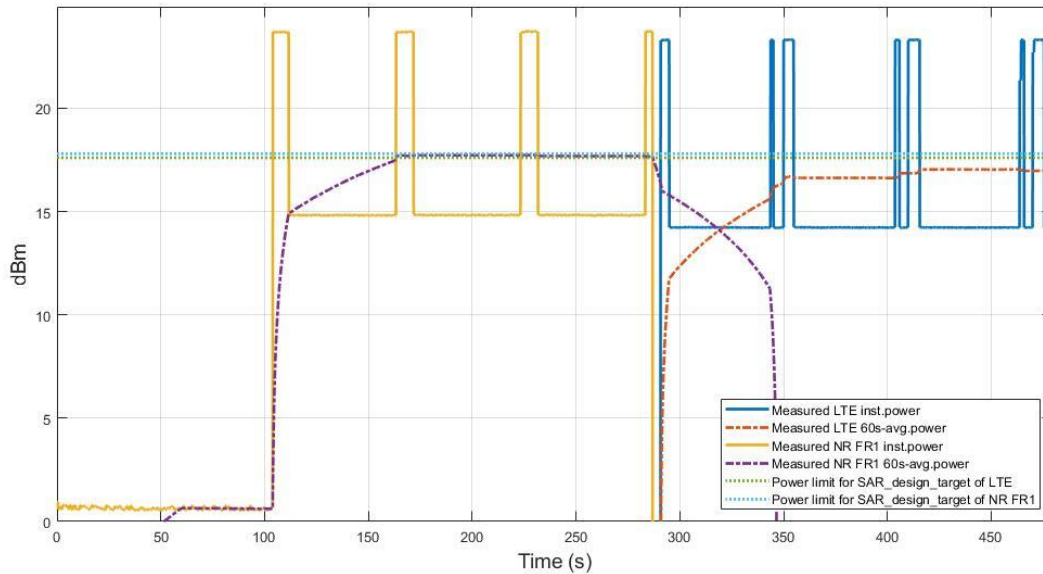

Figure 7.9-1 Conducted Tx power for SAR IRAT re-selection

Figure 7.9-1 shows the instantaneous and time-averaged conducted Tx power for both LTE Band 7 and NR FR1 n77 for the duration of the test. Around time stamp of ~310s, a RAT re-selection from LTE Band 7 to NR FR1 n77 was executed, resulting in reduction of time-averaged power of Band 7 and simultaneous increase in time-averaged power of n77. Figure 7.9-2 shows the time-averaged 1gSAR value for each of LTE Band 7 and NR FR1 n77, as well as the total SAR value.

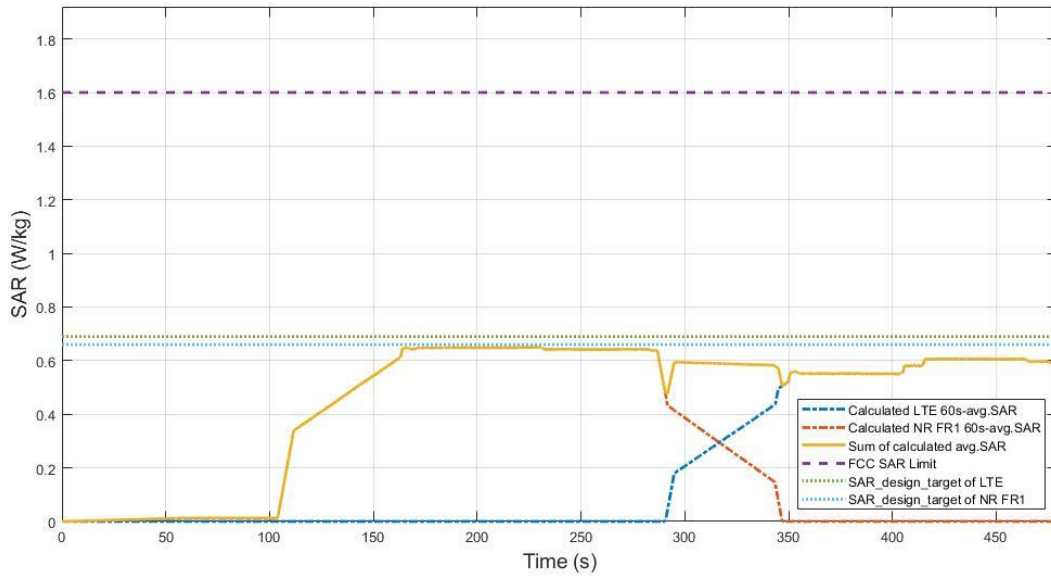

Figure 7.9-2 Total time-averaged SAR

FCC 1gSAR limit	1.6 W/kg
Max sum of calculated average SARs (yellow curve)	0.651 W/kg
Device uncertainty	1.1 dB

7.9 LTE Uplink CA

The test results in this section are obtained following the procedure in Section 3. The test cases correspond to TC#18 in Table 7.2.1.

7.10.1 TC20: LTE_UL_CA (LTE Band 7)

Figure 7.10-1 shows the conducted Tx power plot with calculated time-averaged power based on the measured instantaneous Tx power with 1gSAR FCC Limit value. In this test, SAR_design_target would be 0.69 W/kg at 17.6dBm. The setting value and measured values are described in Table 7.2.1. An MPR of 2dB is configured within this band so with 100% duty cycle the maximum power should be reaching 23.8dBm.

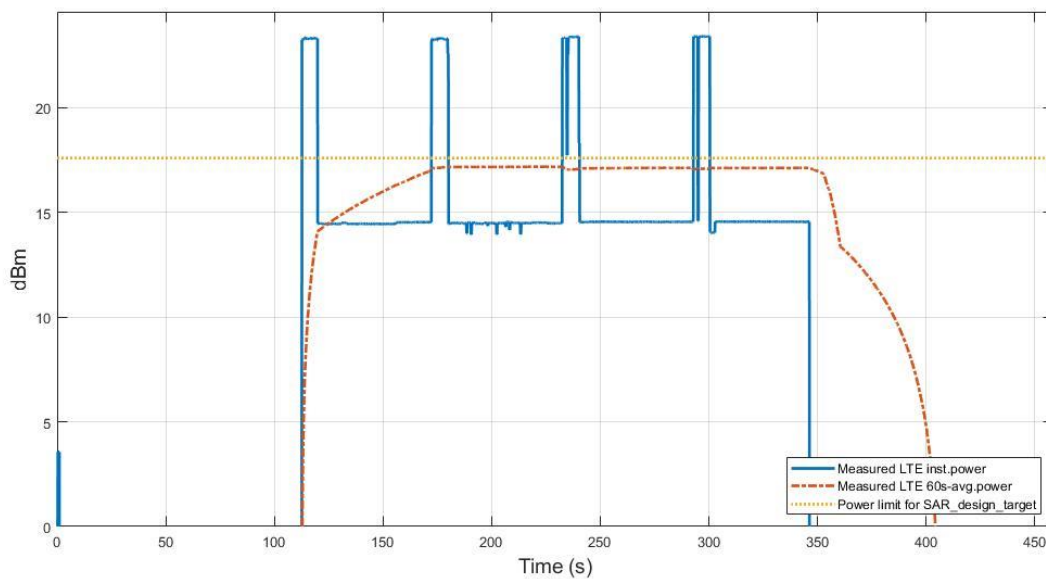

Figure 7.10-1 Conducted transmitted power of LTE Band 7 in UL CA

Next after 120s, an intra-band CA is configured (CA_7C) where a new CC is added and the transmission is continued for another 120s. As shown in Figure 7.10-1, the total power of the two CC is kept almost the same as in the single CC transmission. Average power in Figure 7.10-1 assures the compliance of the average power of the transmitted signal which is below 17.6dBm and consequently the average SAR in Figure 7.10-2 is below 1W/kg which is below the FCC limit of 1.6W/kg

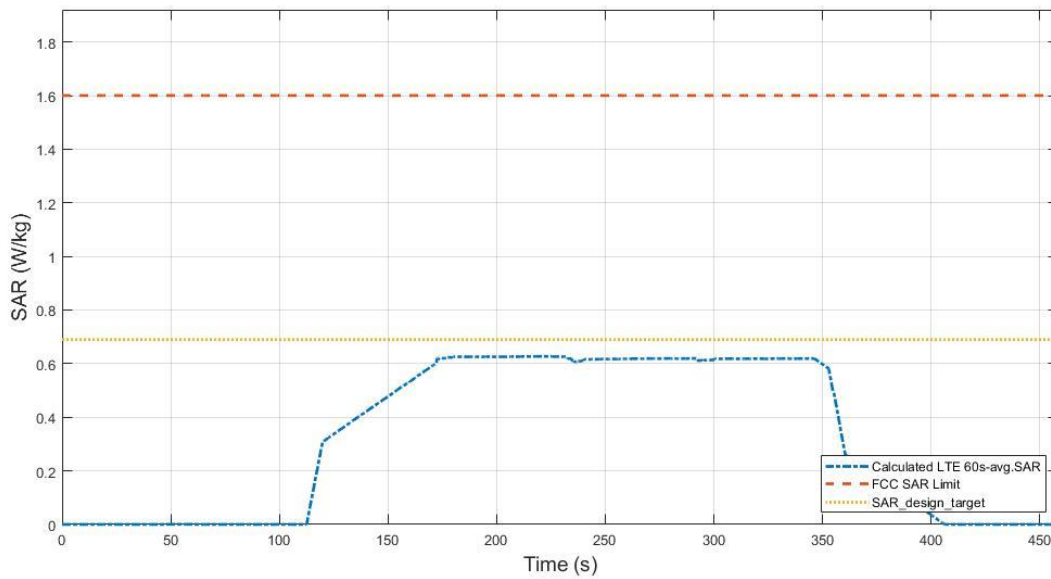

Figure 7.10-2 Total time-averaged SAR

FCC 1gSAR limit	1.6 W/kg
Max sum of calculated average SARs (yellow curve)	0.627 W/kg
Device uncertainty	0.9 dB

8. FR2 Radiated power Test Results for TAS validation

8.1 Measurement setup

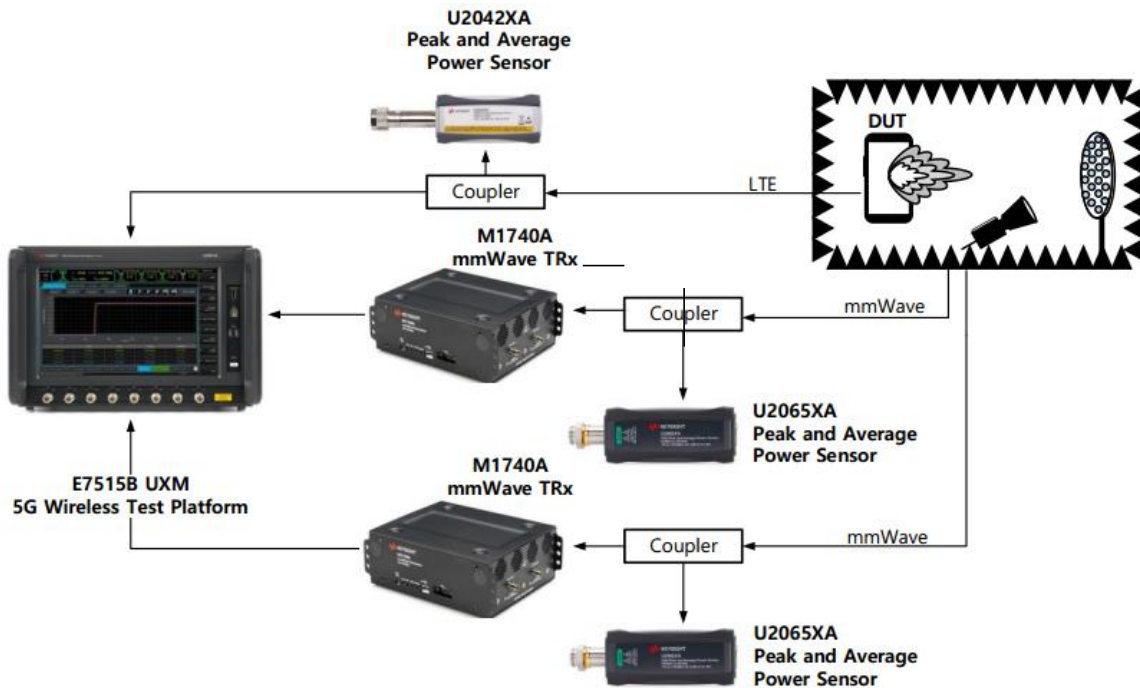

Figure 8.1-1 Test set-up for mmWave

In mmWave technology, we are not able to measure conducted power at antenna, so only radiated power in the form of EIRP (equivalent isotropically radiated power) will be measured in an anechoic chamber. The test setup is illustrated in Figure 8.1-1. For NSA (non-standalone) operation, legacy LTE technology will also be active and this connection can be done via a connected port of the DUT. A power sensor can be coupled to the LTE transmission. There is a concept of two orthogonal polarization measurements (horizontal and vertical) in mmWave, and so two additional power sensors are needed to measure both. There are remote radio-heads required to performance up/down-conversion of the mmWave signal from/to the call box. The Keysight UXM call box is capable of establishing both LTE and FR2 connections. The coupled power sensors in mmWave uplink will be logged along with the LTE power simultaneously for post-processing on the PC. The LTE power is then mapped to SAR, while the mmWave power readings will be mapped to PD using the characterization data. The direction of DUT is set to see the worst case corresponding to module and beam showing the highest PD in characterization as described in Section 5.3. By validation in this conservative worst PD case, all other cases can be regarded as to be validated as well.

In summary, PD test has to be executed as following procedure (more detailed procedure in Section 5.3).



1. Measure conduction sub 6GHz Tx power corresponds to SAR regulation and measure Tx EIRP corresponds to PD regulation. For mmWave, E-field PD measurement TE is used instead of EIRP measurements.
2. Set sub 6GHz and mmWave power level with some margin. And start the test.
3. Execute time-varying test scenarios. And record sub 6GHz power using sub 6GHz power meter equipment and EIRP value using mmWave power meter.
4. Plot the recorded results over measurement time. And evaluate the results for validation.

8.2 Time-varying Tx power measurement results

The results in this section were obtained following the procedure in Section 7.2 and corresponds to the test case I_TC01 in Table 7.2.1.

8.2.1 F_TC01: mmWave_Max_Tx_Power

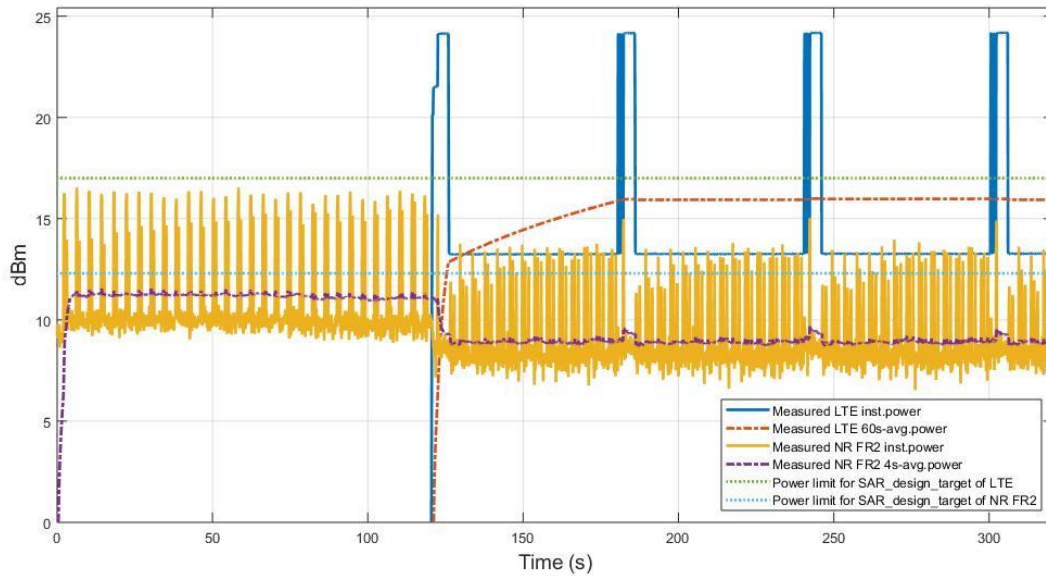

Figure 8.2-1 Conducted power of LTE B2 and radiated EIRP of FR2 n260 in EN-DC

Figure 8.2-1 shows the instantaneous and time-averaged conducted power for LTE and radiated power for NR FR2. In this test, we assumed that P_{limit} value for LTE is 17.4 dBm when SAR_{design target} is 0.71W/Kg, and the P_{limit} value of FR2 is 9.68 dBm when PD_{design target} is 4.42W/m². When LTE is operated, FR2 power would be decreased to maintain TER value. After the average power of LTE is saturated as target power, the average power of FR2 is not decreased any more. As a result, although LTE is turned on, the TER value doesn't increase or decrease. Figure 8.2-2 shows the computed normalized and time-averaged SAR and PD values for LTE and NR FR2, respectively, as well as their sum which is the TER value. We can see that the TER is always under the FCC compliance limit of 1, thus validating the TAS feature in this test case.

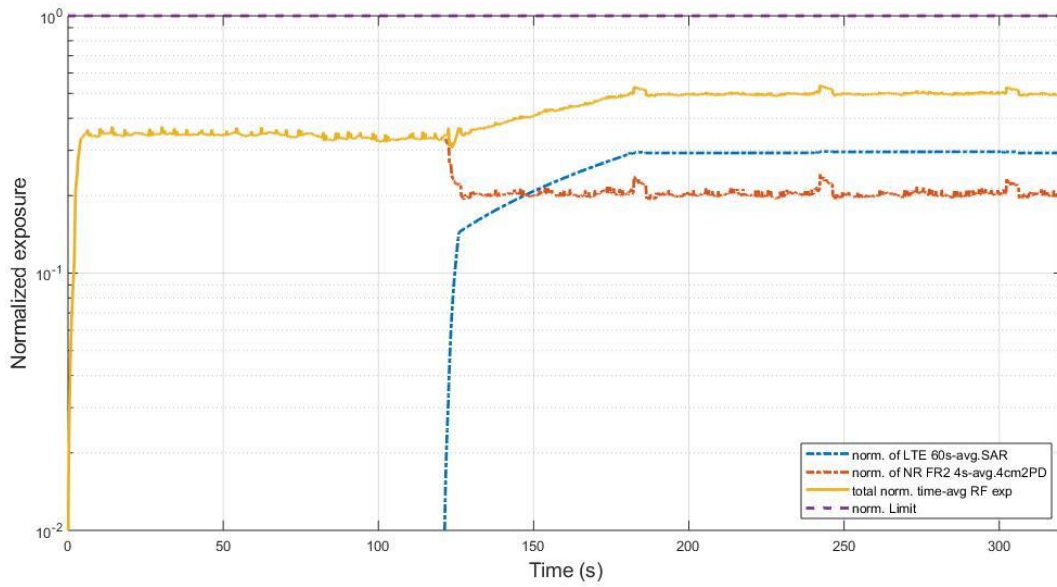

Figure 8.2-2 Total normalized time-average RF exposure in TC01

FCC requirement for total RF exposure (normalized)	1.0
Max total normalized time-averaged RF exposure (yellow curve)	0.539
Validated	

8.3 SAR vs. PD exposure switch

The results in this section were obtained following the procedure in Section 7.2 and corresponds to the test case F_TC02 in Table 7.2.1.

8.3.1 F_TC02: mmWave_Dominant_Power_Switching

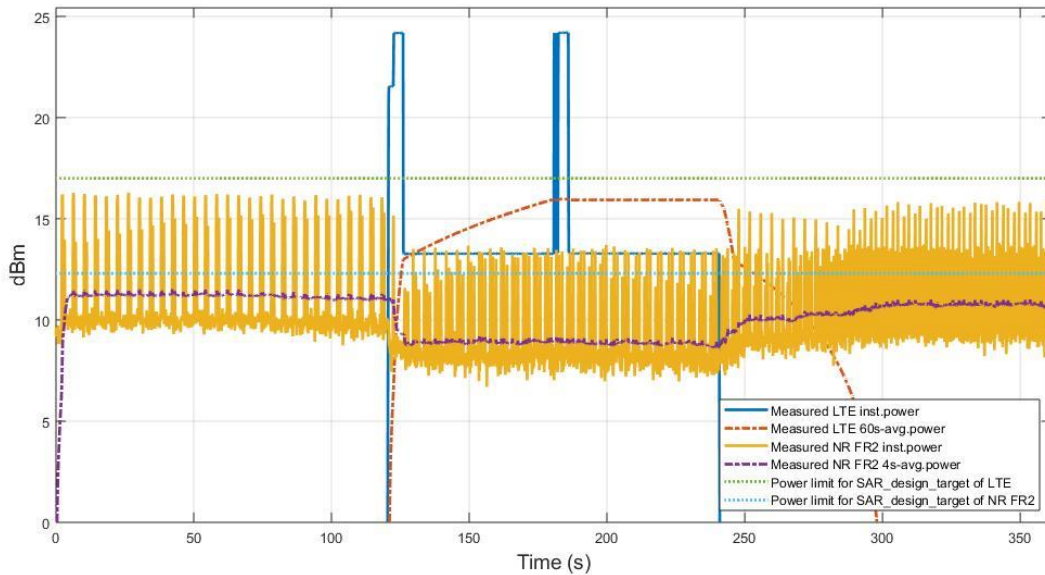

Figure 8.3-1 Conducted power of LTE B2 and radiated EIRP of FR2 n260 in EN-DC

Figure 8.3-1 shows the instantaneous and time-averaged conducted power for LTE and radiated power for NR FR2. In this test, we assumed that P_{limit} value for LTE is 17.4dBm when SAR_{design target} is 0.71 W/Kg, and the P_{limit} value of FR2 is 9.68 dBm when PD_{design target} is 4.42W/m². When LTE is operated, FR2 power would be decreased to maintain TER value. After the average power of LTE is saturated as target power, the average power of FR2 is not decreased any more. After LTE is turned off, the average power of FR2 is increased to restore the original target power. As a result, whether LTE is turned on or not, the TER value dramatically doesn't increase or decrease. Figure 8.3-2 shows the computed normalized and time-averaged SAR and PD values for LTE and NR FR2, respectively, as well as their sum which is the TER value. We can see that the TER is always under the FCC compliance limit of 1, thus validating the TAS feature in this test case.

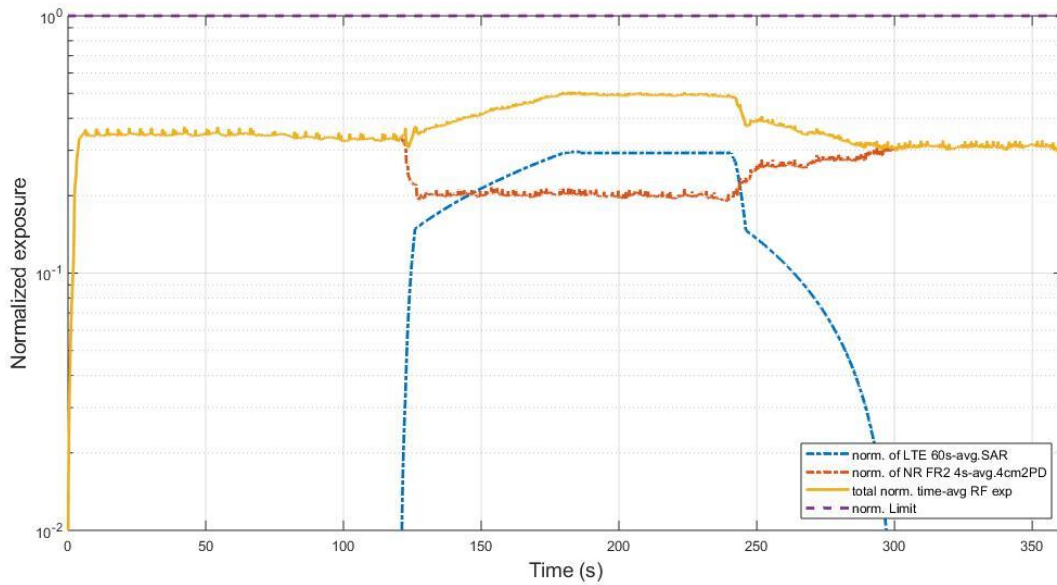

Figure 8.3-2 Total normalized time-average RF exposure in TC02

FCC requirement for total RF exposure (normalized)	1.0
Max total normalized time-averaged RF exposure (yellow curve)	0.508
Validated	

8.4 FR2 beam change

The results in this section were obtained following the procedure in Section 7.2 and corresponds to the test case F_TC03 in Table 7.2.1.

8.4.1 F_TC03: mmWave_Module_Beam_Change

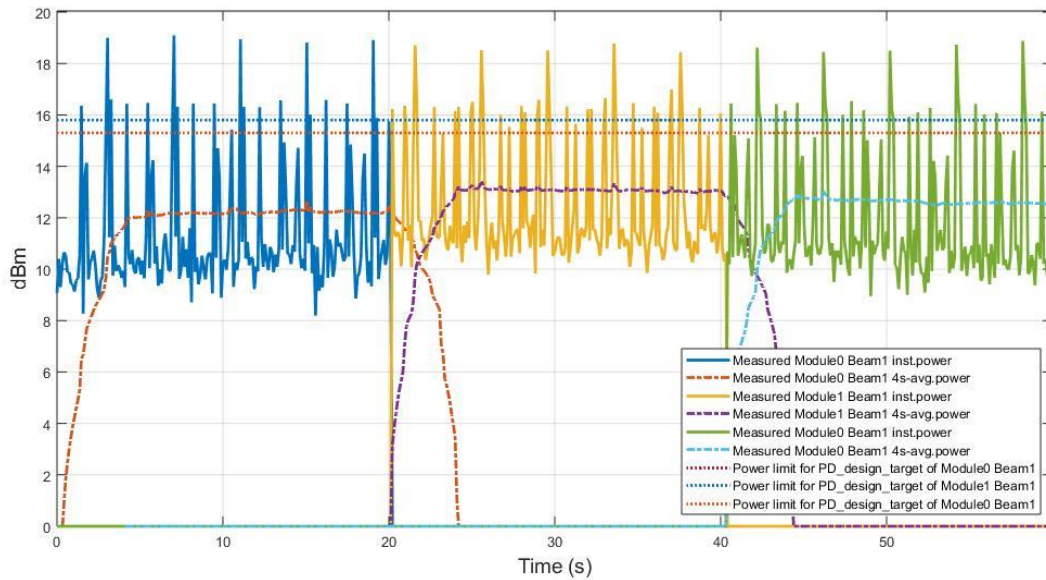

Figure 8.4-1 Measured radiated EIRP of FR2 n260 in mmWave Module beam change case TC03

Figure 8.4-1 shows the instantaneous and time-averaged radiated power for NR FR2. We don't show the LTE transmit power, since it would be at the lowest level and doesn't meaningfully contribute to the TER. In this test, we assumed that the Plimit value of FR2 is 9.68 dBm when PD_design_target is 4.42W/m2. Figure 8.4-2 shows the computed time-averaged PD for each selected module/beam setting as well as the total sum. When beam or module of FR2 would be changed, the sum of each beam/module is not higher than the target power limit. As a result, whether beam/module is changed or not, the TER value dramatically doesn't increase.

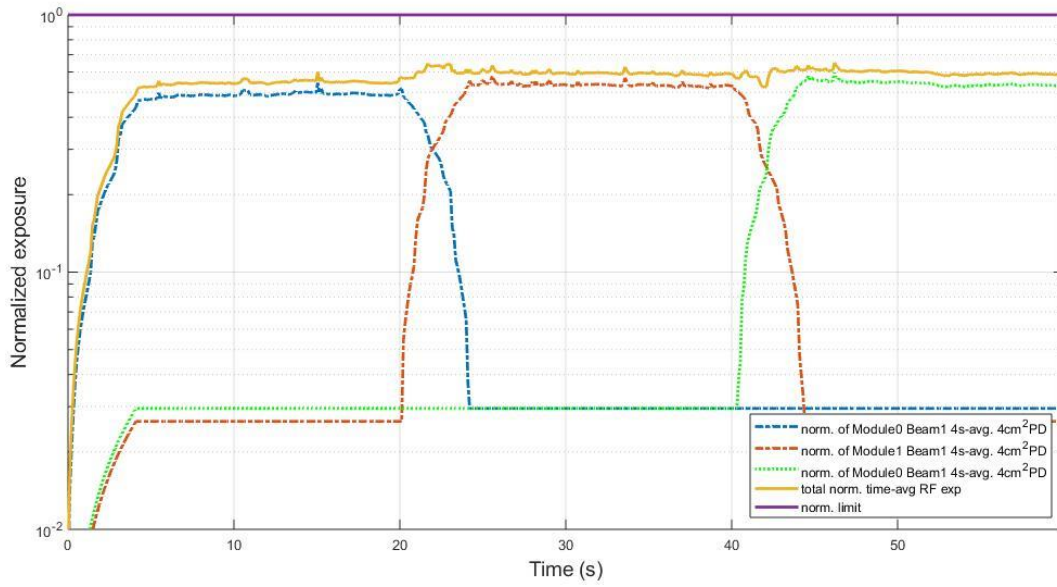

Figure 8.4-2 Total normalized time-average RF exposure

FCC requirement for total RF exposure (normalized)	1.0
Max total normalized time-averaged RF exposure (yellow curve)	0.652
Validated	



9. Conclusions

Samsung S.LSI TAS feature employed in this product has been validated through the conducted power measurement for sub-6, radiated power measurement for FR2 as demonstrated in this report, the power limiting enforcement is effective and the total normalized time-averaged RF exposure does not exceed 1.0 for all the transmission scenarios. Therefore, the EUT complies with FCC RF exposure requirement.

10. Annex

10.1 Test sequence is generated based on below parameters of the DUT:

1. Measured maximum power (Pmax)
2. Measured Tx power (Plimit) to satisfy SAR Compliance
3. Setup time to make SAR Remaining be full
4. Do test according to test sequence

10.2 Test Sequence A waveform:

- Based on the parameters above, the Test Sequence A is generated with two power levels. One is maximum power level and the other is lower power level. The lower power level is defined as 3dB lower value than maximum power level. At first, maximum power level is applied for 120 seconds (SAR_time_window x 1.2). After then, lower power level is used until this test is finished.



10.3 Test Sequence B waveform:

- Based on the parameters above, the Test Type B is generated with pre-defined power levels, which is described in Table 10.3.1.

Table 10.3.1 Table of test sequence B

Time duration (second)	Power level (dB)
15	Plimit - 5
20	Plimit
20	Plimit + 5
10	Plimit - 6
20	Pmax
15	Plimit
15	Plimit -7
20	Pmax
10	Plimit-5
15	Plimit
10	Plimit-6
20	Plimit + 5
10	Plimit - 4
15	Plimit
10	Plimit - 6
20	Pmax
15	Plimit-8
15	Plimit
20	Pmax
10	Plimit - 9
20	Plimit + 5
20	Plimit
15	Plimit - 5



11. Test Equipment List

Manufacturer	Name of Equipment	Type/Model	Serial Number	Calibration	
				Last Cal.	Due Date
Anritsu	Base Station	MT8821C	6201074414	Aug. 23, 2023	Aug. 22, 2024
Anritsu	Base Station	MT8000A	6262208374	Jan. 03, 2024	Jan. 02, 2025
Anritsu	Power Meter	ML2496A	2119003	Jul. 19, 2023	Jul. 18, 2024
Anritsu	Power Sensor	MA2411B	1911333	Jul. 19, 2023	Jul. 18, 2024
Anritsu	Power Sensor	MA2411B	1911334	Jul. 19, 2023	Jul. 18, 2024
Testo	Hygro meter	608-H1	45196600	Nov. 02, 2023	Nov. 01, 2024
Anritsu	Signal Generator	MG3710A	6201502524	Sep. 27, 2023	Sep. 26, 2024
Anritsu	Power Meter	ML2496A	2119003	Jul. 19, 2023	Jul. 18, 2024
Anritsu	Power Sensor	MA2411B	1911333	Jul. 19, 2023	Jul. 18, 2024
Keysight	CATR measurement antenna	SAF-2434231535-328-S1-280-DP	16920-01	Note ⁽¹⁾	
Warison	10-50 GHz Directional Coupler	WCOU-10-50S-10	WR889BMC4B1	Note ⁽¹⁾	
ATM	500M-18GHz Dual Directional Coupler	C122H-10	P610410z-02	Note ⁽¹⁾	
Woken	Attenuator 1	WK0602-XX	N/A	Note ⁽¹⁾	
Woken	Attenuator 2	PE7005-10	N/A	Note ⁽¹⁾	
Woken	Attenuator 3	PE7005- 3	N/A	Note ⁽¹⁾	

Note ⁽¹⁾: Prior to conducted or EIRP power measurement, the path loss from the EUT to the power meter, which includes the RF cable, attenuator and directional coupler, was measured and determined.