

# Antenna Report

FCC ID: A4RG2YBB

4/3/2024

Google LLC

## 1. Test Method

The antenna gains are obtained through measurements in a fully anechoic OTA chamber with a 3D positioner.

Measurements are taken in discrete steps in theta and phi direction. Data is recorded for both theta and phi polarizations at each position using Network Analyzer (passive) or Signal Analyzer(active). Step size is 15 deg along both axes.

Gain is derived from peak EIRP and conducted power measurements or directly through spatial averaging of VNA S21 measurements

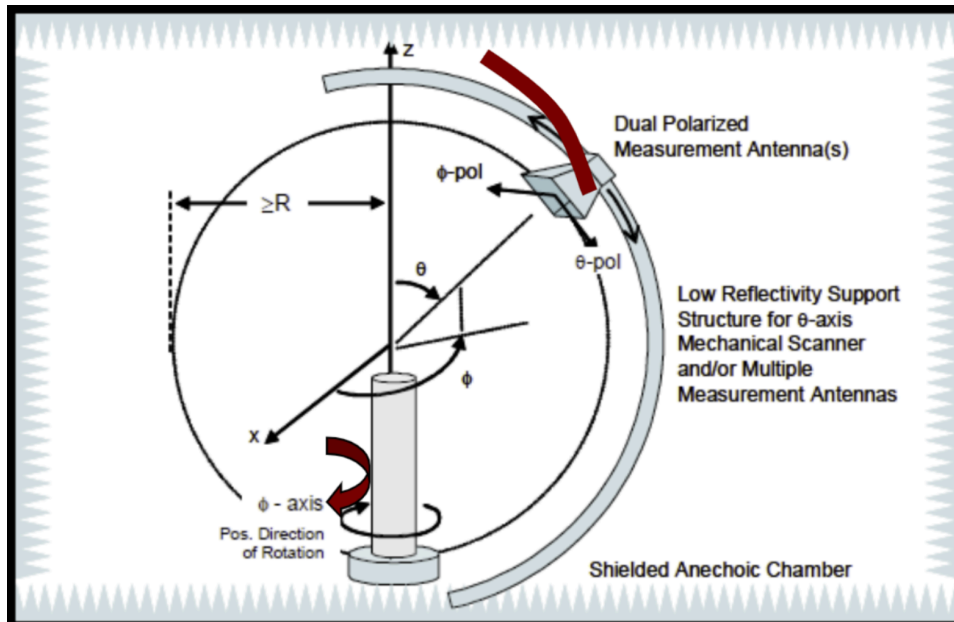

R=1.02m for WPTC-S

## 2. Test Equipment and Calibration

Antenna gain measurements were divided into two chambers (2.4GHz and 5-6 GHz (UNII-1 to UNII-8))

### a. Chamber 1: 2.4 GHz

Site Description	Chamber Manufacturer	Type
MVG SL 50GHz_50115-1014 Anechoic Chamber	MVG	Anechoic
Site location:	1383 Shorebird Way, Mountain View, CA 94043	

Description	Manufacturer	Model
Network Analyzer	Keysight	N5245B (PNA-X)

Equipment calibration status	- Calibration date: Se.16, 2022 - Due of next calibration: Sep.16, 2024
Test dates	- March. 11, 2024
Names of test personnel	- Aobo Li

### b. Chamber 2: 5-6GHz (UNII-1 to UNII-8)

Site Description	Chamber Manufacturer	Type
TS8991 OTA system (WPTC-S)	R&S	Anechoic
Site location:	1383 Shorebird Way, Mountain View, CA 94043	

Description	Manufacturer	Model
Signal Analyzer	R&S	FSV

Equipment calibration status	- Calibration date: Sep.18, 2022 - Due of next calibration: Sep.18, 2024
Test dates	- January. 17, 2024
Names of test personnel	- Patrick Choi

### 3. Site Path Loss

To provide accurate antenna gain values, the chamber is calibrated with the measured path loss. The block diagram below represents the setup of the site path loss. Path loss is provided for both polarities for all WLAN frequency ranges. Path losses were divided into two chambers (2.4GHz and 5-6GHz (UNII-1 to UNII-8))

#### a. Chamber 1: 2.4 GHz

Figure: Chamber 1 Block Diagram of Path Loss

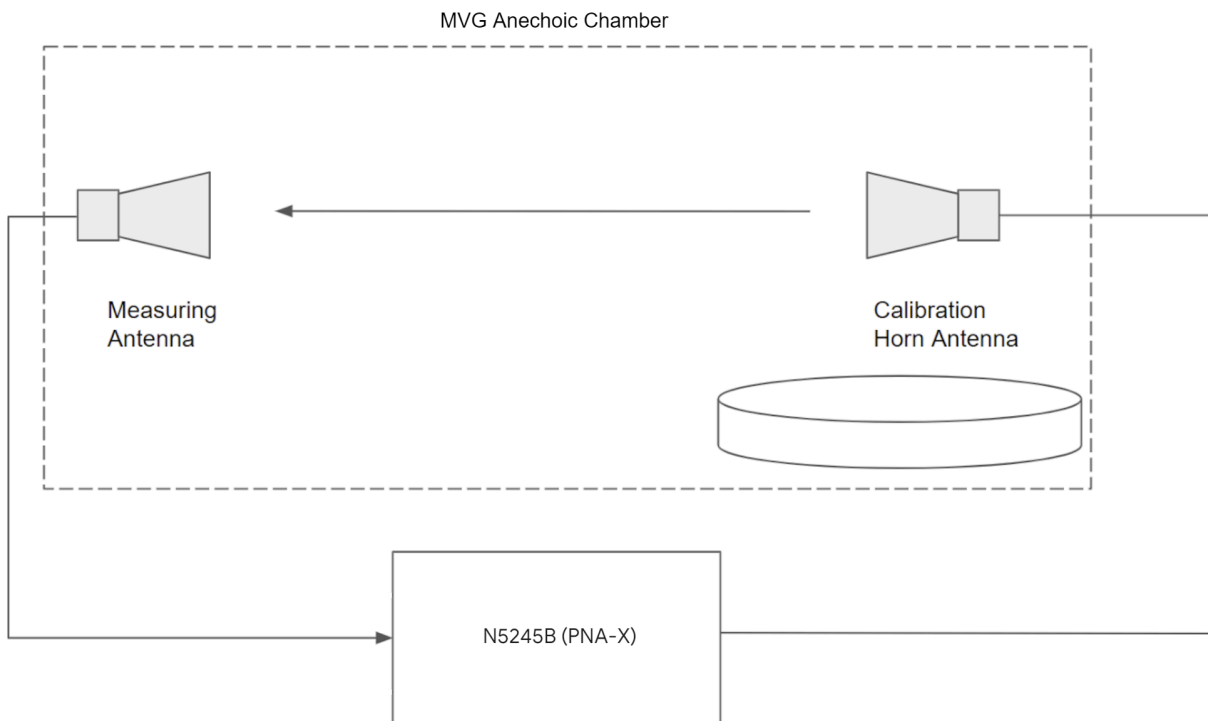

Frequency (MHz)	Path Loss
2402	-19.76
2412	-19.82
2437	-20.06
2462	-20.33
2480	-20.46

## b. Chamber 2: 5-6GHz (UNII-1 to UNII-8)

Figure: Chamber 2 Block Diagram of Path Loss

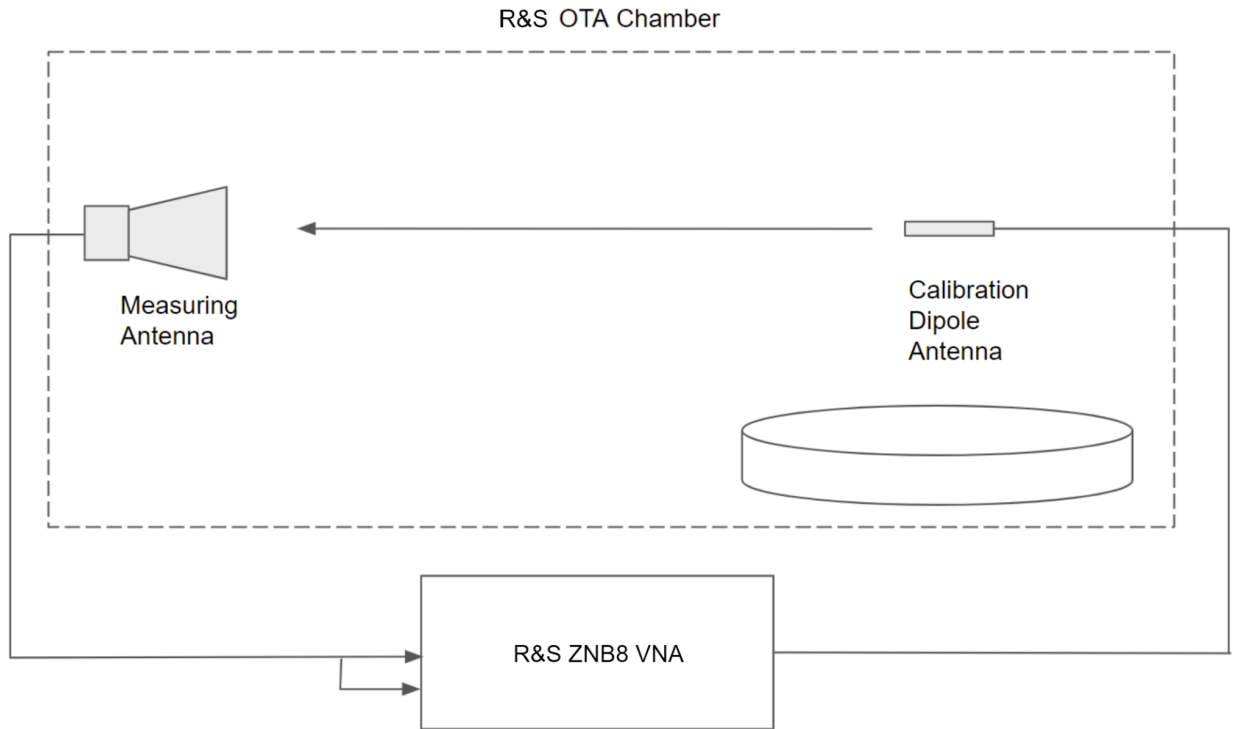

Frequency (MHz)	H-Pol Path Loss	V-Pol Path Loss
5180	-53.62	-52.53
5280	-53.47	-52.79
5500	-53.58	-53.32
5820	-54.47	-54.74
5887	-54.1	-54.13
6175	-54.94	-55.28
6475	-55.23	-55.13
6700	-55.6	-55.47
7000	-55.24	-55.74

#### 4. Test Setup

See separate appendix document for pictures of the test setup in this filing.

#### 5. Antenna Type

See description of antenna type below.

Antenna Name	Antenna Type
Ant3	IFA
Ant4	ILA

## 6. WLAN/BT Antennas

Ant	Band	Frequency Band	Peak Gain(dBi)
<b>Ant4</b>	2.4 GHz WiFi/BT/Thread	2400 - 2483.5 MHz	-1.1
	UNII-1	5180 MHz	-6.3
	UNII-2A	5280 MHz	-3.5
	UNII-2C	5500 MHz	-3.2
	UNII-3	5820 MHz	-3.5
	UNII-4	5887 MHz	-3.5
	UNII-5	6175 MHz	-3.8
	UNII-6	6475 MHz	-5.2
	UNII-7	6700 MHz	-5.5
	UNII-8	7000 MHz	-6.9
<b>Ant3</b>	2.4 GH WiFi/BT/Thread	2400 - 2483.5 MHz	0.9
	UNII-1	5180 MHz	-0.9
	UNII-2A	5280 MHz	-0.9
	UNII-2C	5500 MHz	-1.8
	UNII-3	5820 MHz	-1.1
	UNII-4	5887 MHz	-1.3
	UNII-5	6175 MHz	-2.2
	UNII-6	6475 MHz	-0.8
	UNII-7	6700 MHz	-1.5
	UNII-8	7000 MHz	-0.1

## 7. Radiation Plots

**Ant4:**

Ant4 Freq. 2.4GHz:

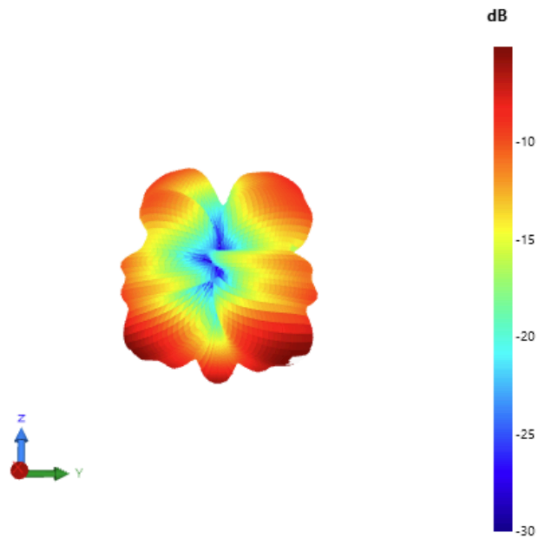

Ant4 Freq. 5180 MHz:

**Theta = 0, Phi = 0**

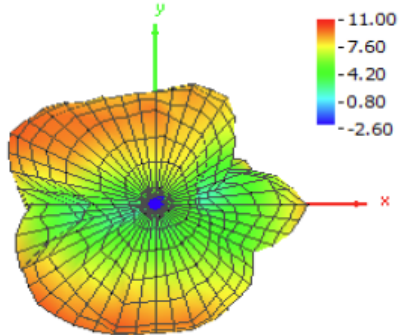

Ant4 Freq. 5280 MHz:

**Theta = 0, Phi = 0**

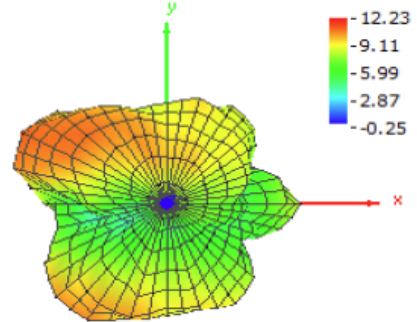



Ant4 Freq. 5500 MHz:

**Theta = 0, Phi = 0**

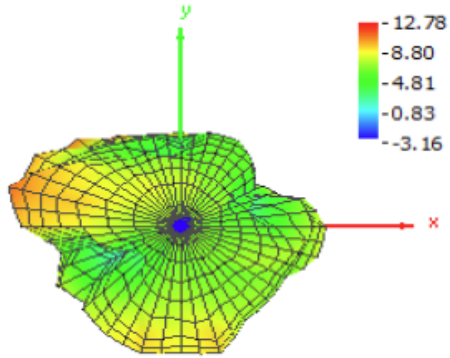

Ant4 Freq. 6175 MHz:

**Theta = 0, Phi = 0**

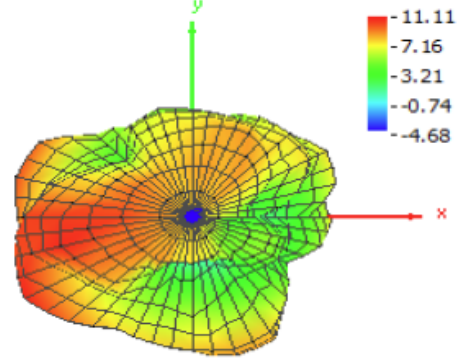

Ant4 Freq. 5820 MHz:

**Theta = 0, Phi = 0**

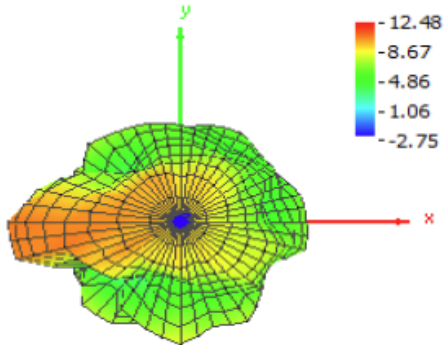

Ant4 Freq. 6475 MHz:

**Theta = 0, Phi = 0**

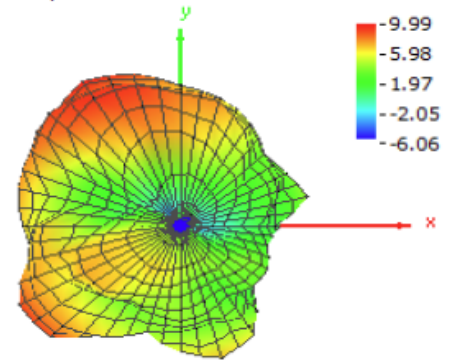

Ant4 Freq. 5887 MHz:

**Theta = 0, Phi = 0**

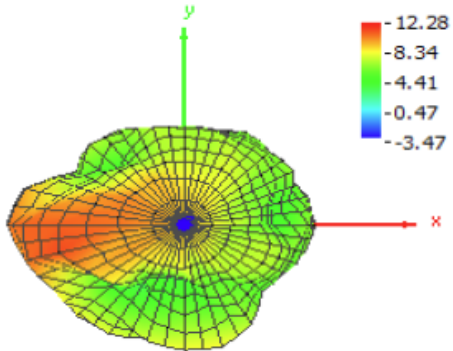

Ant4 Freq. 6700 MHz:

**Theta = 0, Phi = 0**

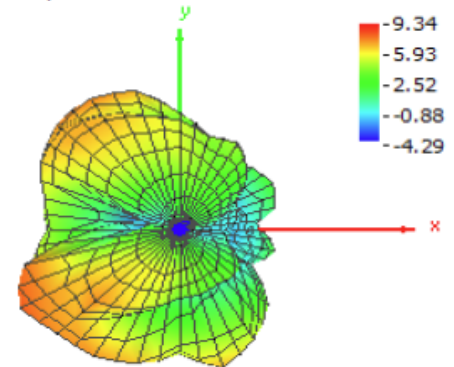

Ant4 Freq. 7000 MHz

**Theta = 0, Phi = 0**

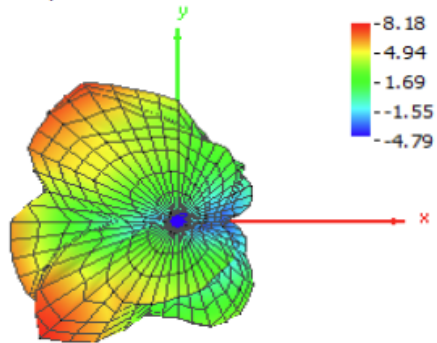

**Ant3:**

Ant3 Freq. 2.4GHz:

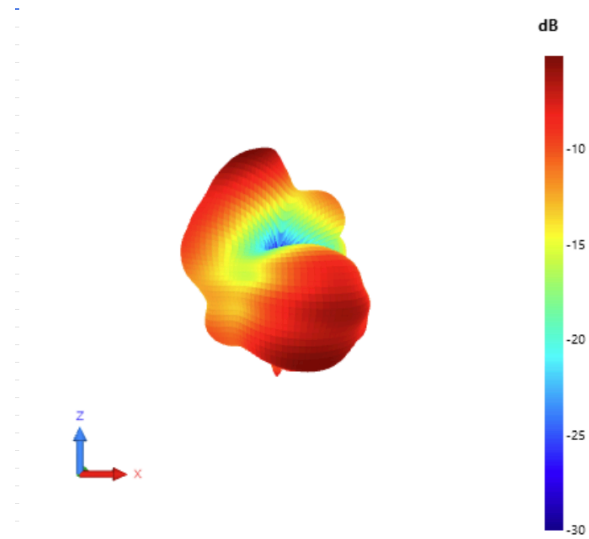

Ant3 Freq. 5180 MHz:

**Theta = 0, Phi = 0**

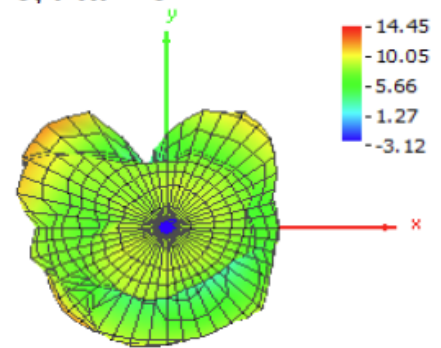

Ant3 Freq. 5280 MHz:

**Theta = 0, Phi = 0**

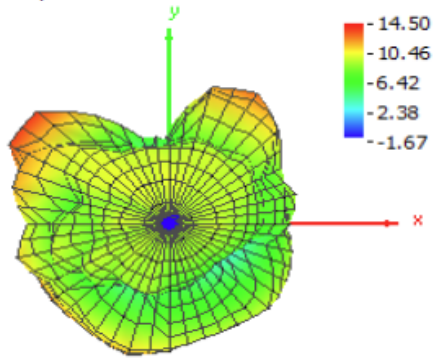

Ant3 Freq. 5887 MHz:

**Theta = 0, Phi = 0**

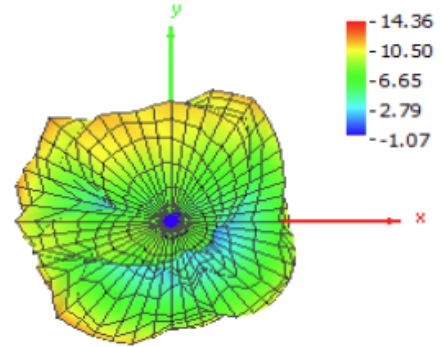

Ant3 Freq. 5500 MHz:

**Theta = 0, Phi = 0**

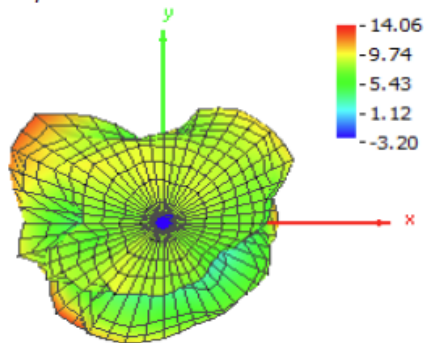

Ant3 Freq. 6175 MHz:

**Theta = 0, Phi = 0**

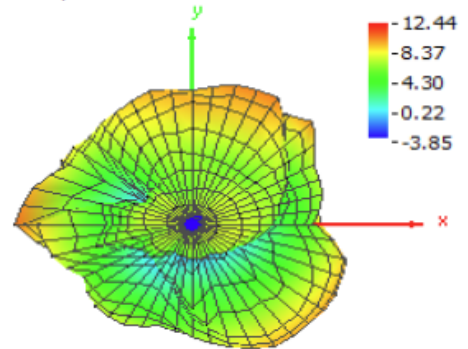

Ant3 Freq. 5820 MHz:

**Theta = 0, Phi = 0**

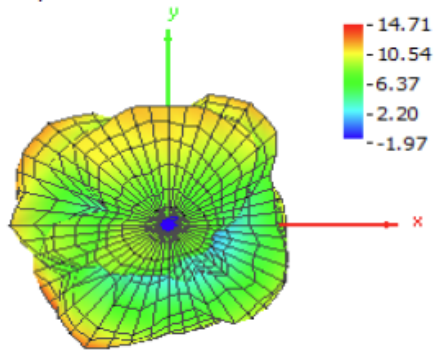

Ant3 Freq. 6475 MHz:

**Theta = 0, Phi = 0**

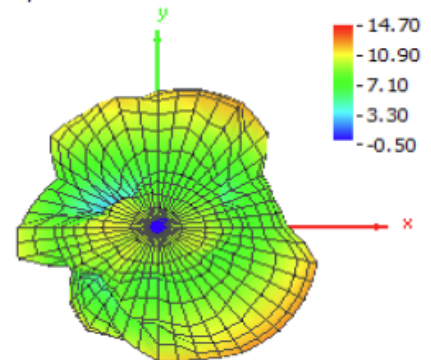

Ant3 Freq. 6700 MHz:

**Theta = 0, Phi = 0**

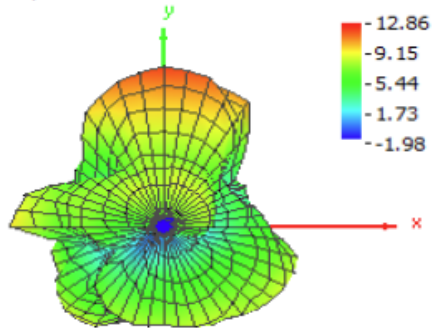

Ant3 Freq. 7000 MHz:

**Theta = 0, Phi = 0**

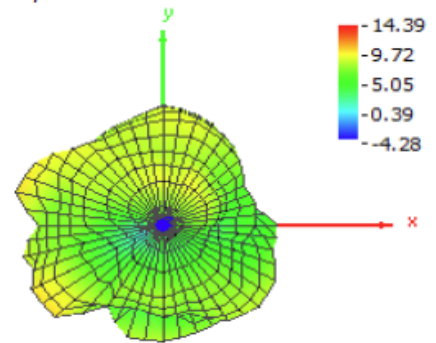

## 8. Report Signatory

---

Jason Qian  
RF Compliance Technical Program Manager  
Google LLC  
1600 Amphitheatre Parkway  
Mountain View, CA 94043