



FCC RADIO TEST REPORT

FCC ID : A4RG1MNW
Equipment : Phone
Model Name : G1MNW
Applicant : Google LLC
1600 Amphitheatre Parkway,
Mountain View, California, 94043 USA
Standard : FCC Part 15 Subpart C §15.247

The product was received on Feb. 06, 2023 and testing was performed from Apr. 11, 2023 to Jun 02, 2023. We, Sporton International Inc. Wensan Laboratory, would like to declare that the tested sample has been evaluated in accordance with the test procedures and has been in compliance with the applicable technical standards.

The test results in this report apply exclusively to the tested model / sample. Without written approval from Sporton International Inc. Wensan Laboratory, the test report shall not be reproduced except in full.

Approved by: Louis Wu

Sporton International Inc. Wensan Laboratory

No.58, Aly. 75, Ln. 564, Wenhua 3rd, Rd., Guishan Dist., Taoyuan City 333010, Taiwan (R.O.C.)



Table of Contents

History of this test report.....	3
Summary of Test Result.....	4
1 General Description.....	5
1.1 Product Feature of Equipment Under Test.....	5
1.2 Product Specification of Equipment Under Test.....	6
1.3 Modification of EUT	8
1.4 Testing Location	8
1.5 Applicable Standards.....	8
2 Test Configuration of Equipment Under Test.....	9
2.1 Carrier Frequency Channel	9
2.2 Test Mode.....	10
2.3 Connection Diagram of Test System.....	12
2.4 Support Unit used in test configuration and system	13
2.5 EUT Operation Test Setup	13
2.6 Measurement Results Explanation Example.....	13
3 Test Result.....	14
3.1 Number of Channel Measurement	14
3.2 Hopping Channel Separation Measurement	15
3.3 Dwell Time Measurement.....	16
3.4 20dB and 99% Bandwidth Measurement	17
3.5 Output Power Measurement.....	18
3.6 Conducted Band Edges Measurement.....	19
3.7 Conducted Spurious Emission Measurement	20
3.8 Radiated Band Edges and Spurious Emission Measurement	21
3.9 AC Conducted Emission Measurement.....	25
3.10 Antenna Requirements.....	27
4 List of Measuring Equipment	28
5 Measurement Uncertainty	29
Appendix A. Conducted Test Results	
Appendix B. AC Conducted Emission Test Result	
Appendix C. Radiated Spurious Emission	
Appendix D. Radiated Spurious Emission Plots	
Appendix E. Duty Cycle Plots	
Appendix F. Setup Photographs	



Summary of Test Result

Report Clause	Ref Std. Clause	Test Items	Result (PASS/FAIL)	Remark
3.1	15.247(a)(1)	Number of Channels	Pass	-
3.2	15.247(a)(1)	Hopping Channel Separation	Pass	-
3.3	15.247(a)(1)	Dwell Time of Each Channel	Pass	-
3.4	15.247(a)(1)	20dB Bandwidth	Pass	-
3.4	2.1049	99% Occupied Bandwidth	Reporting only	-
3.5	15.247(b)(1) 15.247(b)(4)	Peak Output Power	Pass	-
3.6	15.247(d)	Conducted Band Edges	Pass	-
3.7	15.247(d)	Conducted Spurious Emission	Pass	-
3.8	15.247(d)	Radiated Band Edges and Radiated Spurious Emission	Pass	7.96 dB under the limit at 58.13 MHz
3.9	15.207	AC Conducted Emission	Pass	10.52 dB under the limit at 1.55 MHz
3.10	15.203	Antenna Requirement	Pass	-

Conformity Assessment Condition:

1. The test results (PASS/FAIL) with all measurement uncertainty excluded are presented against the regulation limits or in accordance with the requirements stipulated by the applicant/manufacturer who shall bear all the risks of non-compliance that may potentially occur if measurement uncertainty is taken into account.
2. The measurement uncertainty please refer to each test result in the section "Measurement Uncertainty".

Disclaimer:

The product specifications of the EUT presented in the test report that may affect the test assessments are declared by the manufacturer who shall take full responsibility for the authenticity.

Reviewed by: William Chen
Report Producer: Cindy Fang



1 General Description

1.1 Product Feature of Equipment Under Test

Product Feature	
Equipment	Phone
Model Name	G1MNV
FCC ID	A4RG1MNV
EUT supports Radios application	GSM/EGPRS/WCDMA/HSPA/LTE/5G NR/NFC/GNSS/ WPT/UWB WLAN 11b/g/n HT20 WLAN 11a/n HT20/HT40 WLAN 11ac VHT20/VHT40/VHT80/VHT160 WLAN 11ax HE20/HE40/HE80/HE160 WLAN 11be EHT20/EHT40/EHT80/EHT160 Bluetooth BR/EDR/LE/HR

Remark: The EUT's information above is declared by manufacturer.

EUT Information List	
S/N	Performed Test Item
33141FDJG000Z1	RF Conducted Measurement
33141FDJG0003F	Radiated Spurious Emission
31101FDJG0003F	Conducted Emission



1.2 Product Specification of Equipment Under Test

Product Specification is subject to this standard	
Tx/Rx Frequency Range	2402 MHz ~ 2480 MHz
Number of Channels	79
Carrier Frequency of Each Channel	2402+n*1 MHz; n=0~78
Maximum Output Power to Antenna	<p><BR+EDR></p> <p><Ant. 3> Bluetooth BR (1Mbps): 20.81 dBm / 0.1205 W Bluetooth EDR (2Mbps): 20.71 dBm / 0.1178 W Bluetooth EDR (3Mbps): 20.70 dBm / 0.1175 W</p> <p><Ant. 4> Bluetooth BR (1Mbps): 19.95 dBm / 0.0989 W Bluetooth EDR (2Mbps): 20.68 dBm / 0.1191 W Bluetooth EDR (3Mbps): 20.78 dBm / 0.1197 W</p> <p><HR></p> <p><Ant. 3> Bluetooth HR(2Mbps):20.96 dBm / 0.1247 W</p> <p><Ant. 4> Bluetooth HR(2Mbps): 20.59 dBm / 0.1146 W</p> <p><TX BF Modes><BR+EDR></p> <p><Ant. 3+4> Bluetooth BR(1Mbps): 20.59 dBm / 0.1146 W Bluetooth EDR (2Mbps): 20.90 dBm / 0.1230 W Bluetooth EDR (3Mbps): 20.96 dBm / 0.1247 W</p> <p><TX BF Modes><HR></p> <p><Ant. 3+4> Bluetooth HR(2Mbps): 20.96 dBm (0.1247 W)</p>



Product Specification is subject to this standard																	
99% Occupied Bandwidth	<p><BR+EDR> <Ant. 3> Bluetooth BR (1Mbps): 0.955 MHz Bluetooth EDR (2Mbps): 1.191 MHz Bluetooth EDR (3Mbps): 1.167 MHz <Ant. 4> Bluetooth BR (1Mbps): 0.953 MHz Bluetooth EDR (2Mbps): 1.19 MHz Bluetooth EDR (3Mbps): 1.169 MHz <HR> <Ant. 3> Bluetooth HR(2Mbps): 1.199 MHz <Ant. 4> Bluetooth HR(2Mbps): 1.191 MHz <TX BF Modes><BR+EDR> <Ant. 3> Bluetooth BR(1Mbps): 0.949 MHz Bluetooth EDR (2Mbps): 1.191 MHz Bluetooth EDR (3Mbps): 1.167 MHz <TX BF Modes><BR+EDR> <Ant. 4> Bluetooth BR(1Mbps): 0.947 MHz Bluetooth EDR (2Mbps): 1.191 MHz Bluetooth EDR (3Mbps): 1.167 MHz <TX BF Modes><HR> <Ant. 3> Bluetooth HR(2Mbps): 1.197 MHz <Ant. 4> Bluetooth HR(2Mbps): 1.199 MHz</p>																
Antenna Type / Gain	<p><Ant. 3>: PIFA Antenna with gain -1.90 dBi <Ant. 4>: IFA Antenna with gain 1.10 dBi</p>																
Type of Modulation	<p>Bluetooth BR (1Mbps) : GFSK Bluetooth EDR (2Mbps) : $\pi/4$-DQPSK Bluetooth EDR (3Mbps) : 8-DPSK Bluetooth HR (2Mbps) : 8PSK</p>																
Antenna Function Description	<table border="1"> <thead> <tr> <th></th> <th>Ant. 3</th> <th>Ant. 4</th> </tr> </thead> <tbody> <tr> <td>Bluetooth</td> <td>V</td> <td>V</td> </tr> <tr> <td>Bluetooth TXBF</td> <td>V</td> <td>V</td> </tr> <tr> <td>Bluetooth HR</td> <td>V</td> <td>V</td> </tr> <tr> <td>Bluetooth HR TXBF</td> <td>V</td> <td>V</td> </tr> </tbody> </table>			Ant. 3	Ant. 4	Bluetooth	V	V	Bluetooth TXBF	V	V	Bluetooth HR	V	V	Bluetooth HR TXBF	V	V
	Ant. 3	Ant. 4															
Bluetooth	V	V															
Bluetooth TXBF	V	V															
Bluetooth HR	V	V															
Bluetooth HR TXBF	V	V															

Remark: The EUT's information above is declared by manufacturer. Please refer to Disclaimer in report summary.



1.3 Modification of EUT

No modifications made to the EUT during the testing.

1.4 Testing Location

Test Site	Sporton International Inc. EMC & Wireless Communications Laboratory
Test Site Location	No.52, Huaya 1st Rd., Guishan Dist., Taoyuan City 333, Taiwan (R.O.C.) TEL: +886-3-327-3456 FAX: +886-3-328-4978
Test Site No.	Sporton Site No. CO05-HY (TAF Code: 1190)
Remark	The AC Conducted Emission test item subcontracted to Sporton International Inc. EMC & Wireless Communications Laboratory

Note: The test site complies with ANSI C63.4 2014 requirement.

Test Site	Sporton International Inc. Wensan Laboratory
Test Site Location	No.58, Aly. 75, Ln. 564, Wenhua 3rd, Rd., Guishan Dist., Taoyuan City 333010, Taiwan (R.O.C.) TEL: +886-3-327-0868 FAX: +886-3-327-0855
Test Site No.	Sporton Site No. TH05-HY, 03CH22-HY

Note: The test site complies with ANSI C63.4 2014 requirement.

FCC designation No.: TW1190 and TW3786

1.5 Applicable Standards

According to the specifications declared by the manufacturer, the EUT must comply with the requirements of the following standards:

- ♦ FCC Part 15 Subpart C §15.247
- ♦ FCC KDB Publication No. 558074 D01 15.247 Meas Guidance v05r02
- ♦ FCC KDB 414788 D01 Radiated Test Site v01r01
- ♦ FCC KDB 662911 D01 Multiple Transmitter Output v02r01.
- ♦ ANSI C63.10-2013

Remark:

1. All the test items were validated and recorded in accordance with the standards without any modification during the testing.
2. The TAF code is not including all the FCC KDB listed without accreditation.



2 Test Configuration of Equipment Under Test

2.1 Carrier Frequency Channel

Frequency Band	Channel	Freq. (MHz)	Channel	Freq. (MHz)	Channel	Freq. (MHz)
2400-2483.5 MHz	0	2402	27	2429	54	2456
	1	2403	28	2430	55	2457
	2	2404	29	2431	56	2458
	3	2405	30	2432	57	2459
	4	2406	31	2433	58	2460
	5	2407	32	2434	59	2461
	6	2408	33	2435	60	2462
	7	2409	34	2436	61	2463
	8	2410	35	2437	62	2464
	9	2411	36	2438	63	2465
	10	2412	37	2439	64	2466
	11	2413	38	2440	65	2467
	12	2414	39	2441	66	2468
	13	2415	40	2442	67	2469
	14	2416	41	2443	68	2470
	15	2417	42	2444	69	2471
	16	2418	43	2445	70	2472
	17	2419	44	2446	71	2473
	18	2420	45	2447	72	2474
	19	2421	46	2448	73	2475
	20	2422	47	2449	74	2476
	21	2423	48	2450	75	2477
	22	2424	49	2451	76	2478
	23	2425	50	2452	77	2479
	24	2426	51	2453	78	2480
	25	2427	52	2454	-	-
	26	2428	53	2455	-	-



2.2 Test Mode

- a. The EUT has been associated with peripherals and configuration operated in a manner tended to maximize its emission characteristics in a typical application. Frequency range investigated: conduction emission (150 kHz to 30 MHz), radiation emission (9 kHz to the 10th harmonic of the highest fundamental frequency or to 40 GHz, whichever is lower). For radiated measurement, the measured emission level of the EUT was maximized by rotating the EUT on a turntable, adjusting the orientation of the EUT and EUT antenna in three orthogonal axis (X: flat, Y: portrait, Z: landscape), and accessory (Adapter or Earphone) and adjusting the measurement antenna orientation, following C63.10 exploratory test procedures and only the worst plane, and the worst mode of radiated spurious emissions is Bluetooth BR/EDR 1Mbps for Ant3 \ BR/EDR 3Mbps for Ant4 \ HR 2Mbps mode, and recorded in this report.

- b. AC power line Conducted Emission was tested under maximum output power.



The following summary table is showing all test modes to demonstrate in compliance with the standard.

Summary table of Test Cases			
Test Item	Data Rate / Modulation		
Conducted Test Cases	Bluetooth BR 1Mbps GFSK	Bluetooth EDR 2Mbps $\pi/4$-DQPSK	Bluetooth EDR 3Mbps 8-DPSK
	Mode 1: CH00_2402 MHz	Mode 4: CH00_2402 MHz	Mode 7: CH00_2402 MHz
	Mode 2: CH39_2441 MHz	Mode 5: CH39_2441 MHz	Mode 8: CH39_2441 MHz
	Mode 3: CH78_2480 MHz	Mode 6: CH78_2480 MHz	Mode 9: CH78_2480 MHz
	Bluetooth HR 2Mbps 8PSK		
	Mode 1: CH00_2402 MHz		
	Mode 2: CH39_2441 MHz Mode 3: CH78_2480 MHz		
Radiated Test Cases	Bluetooth BR/EDR 1Mbp / EDR 3Mbps 8-DPSK / HR 2Mbps 8PSK		
	Mode 1: CH00_2402 MHz Mode 2: CH39_2441 MHz Mode 3: CH78_2480 MHz		
AC Conducted Emission	Mode 1 :GSM850 Idle + WLAN (2.4GHz) Link + Bluetooth Link + USB cable 1 (Charging from Adapter 2)		
Remark:			
<ol style="list-style-type: none"> For Radiated Test Cases, the worst mode data rate BR/EDR 1Mbps for Ant3 · BR/EDR 3Mbps for Ant4 · HR 2Mbps was reported only since the highest RF output power in the preliminary tests. The conducted spurious emissions and conducted band edge measurement for other data rates were not worse than BR/EDR 3Mbps · HR 2Mbps, and no other significantly frequencies found in conducted spurious emission. For Radiated Test Cases, the tests were performed with Adapter 1 and USB Cable 1. During the preliminary test, both charging modes (Adapter mode and WPT Charging mode) were verified. It is determined that the adaptor mode is the worst case for official test. 			

2.3 Connection Diagram of Test System

<AC Conducted Emission Mode>

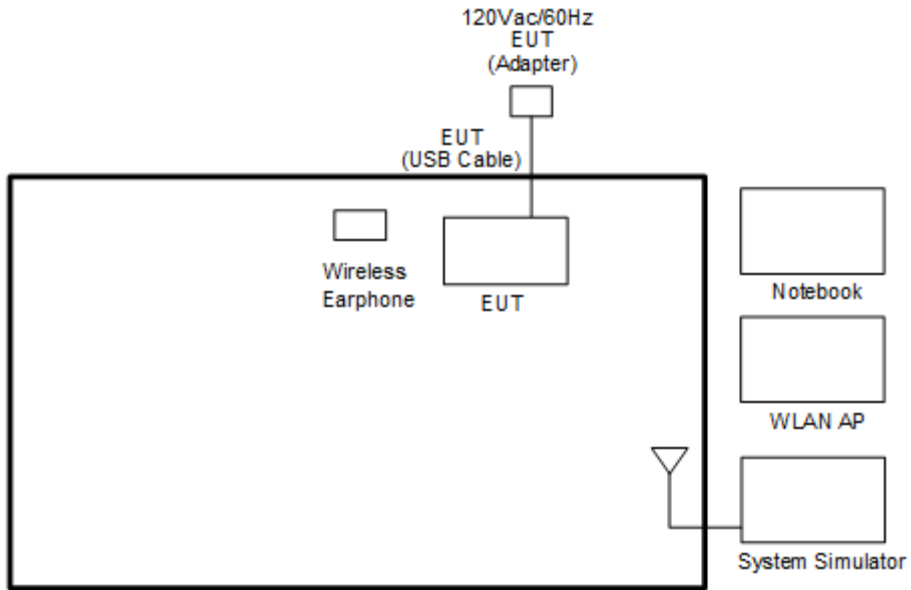

<Bluetooth Tx Mode>

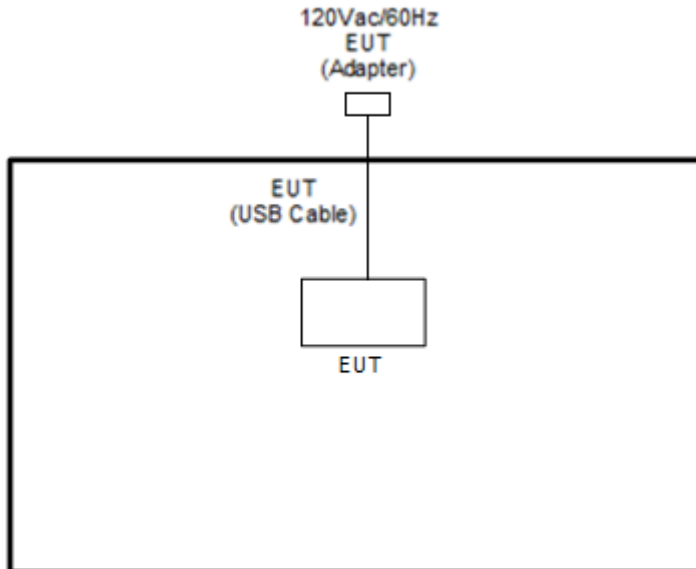



2.4 Support Unit used in test configuration and system

Item	Equipment	Brand Name	Model Name	FCC ID	Data Cable	Power Cord
1.	System Simulator	Anritsu	MT8820C	N/A	N/A	Unshielded, 1.8 m
2.	Wireless Earphone	Google	G1007/G1008	A4RG1007/ A4RG1008	N/A	N/A
3.	WLAN AP	ASUS	RT-AC66U	MSQ-RTAC66U	N/A	Unshielded, 1.8 m
4.	Notebook	DELL	Latitude 3420	FCC DoC	N/A	AC I/P: Unshielded, 1.2 m DC O/P: Shielded, 1.8 m

2.5 EUT Operation Test Setup

The RF test items, utility “cmd v1.0.32” was installed in Notebook which was programmed in order to make the EUT get into the engineering modes to provide channel selection, power level, data rate and the application type and for continuous transmitting signals.

2.6 Measurement Results Explanation Example

For all conducted test items:

The offset level is set in the spectrum analyzer to compensate the RF cable loss and attenuator factor between EUT conducted output port and spectrum analyzer. With the offset compensation, the spectrum analyzer reading level is exactly the EUT RF output level.

Example:

The spectrum analyzer offset is derived from RF cable loss and attenuator factor.

Offset = RF cable loss + attenuator factor.

Following shows an offset computation example with cable loss 4.2 dB and 10 dB attenuator.

$$\begin{aligned} \text{Offset(dB)} &= \text{RF cable loss(dB)} + \text{attenuator factor(dB)}. \\ &= 4.2 + 10 = 14.2 \text{ (dB)} \end{aligned}$$

3 Test Result

3.1 Number of Channel Measurement

3.1.1 Limits of Number of Hopping Frequency

Frequency hopping systems in the 2400-2483.5 MHz band shall use at least 15 channels.

3.1.2 Measuring Instruments

Please refer to the measuring equipment list in this test report.

3.1.3 Test Procedure

1. The testing follows ANSI C63.10-2013 clause 7.8.3.
2. The RF output of EUT is connected to the spectrum analyzer by RF cable and attenuator. The path loss is compensated to the results for each measurement.
3. Set the maximum power setting and enable the EUT to transmit continuously.
4. Enable the EUT hopping function.
5. Use the following spectrum analyzer settings: Span = the frequency band of operation; RBW = 300 kHz; VBW \geq RBW; Sweep = auto; Detector function = peak; Trace = max hold.
6. The number of hopping frequency used is defined as the number of total channel.
7. Record the measurement data derived from spectrum analyzer.

3.1.4 Test Setup

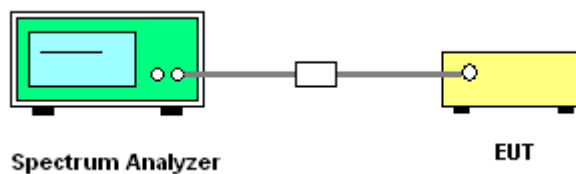

3.1.5 Test Result of Number of Hopping Frequency

Please refer to Appendix A.

3.2 Hopping Channel Separation Measurement

3.2.1 Limit of Hopping Channel Separation

Frequency hopping systems operating in the 2400-2483.5 MHz band may have hopping channel carrier frequencies that are separated by 25 kHz or two-thirds of the 20 dB bandwidth of the hopping channel, whichever is greater.

3.2.2 Measuring Instruments

Please refer to the measuring equipment list in this test report.

3.2.3 Test Procedures

1. The testing follows ANSI C63.10-2013 clause 7.8.2.
2. The RF output of EUT is connected to the spectrum analyzer by RF cable and attenuator. The path loss is compensated to the results for each measurement.
3. Set the maximum power setting and enable the EUT to transmit continuously.
4. Enable the EUT hopping function.
5. Use the following spectrum analyzer settings:
Span = wide enough to capture the peaks of two adjacent channels;
RBW = 300 kHz; VBW \geq RBW; Sweep = auto; Detector function = peak; Trace = max hold.
6. Measure and record the results in the test report.

3.2.4 Test Setup

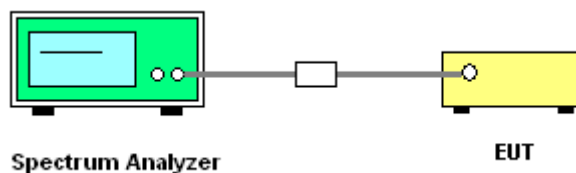

3.2.5 Test Result of Hopping Channel Separation

Please refer to Appendix A.

3.3 Dwell Time Measurement

3.3.1 Limit of Dwell Time

The average time of occupancy on any channel shall not be greater than 0.4 seconds within a period of 0.4 seconds multiplied by the number of hopping channels employed.

3.3.2 Measuring Instruments

Please refer to the measuring equipment list in this test report.

3.3.3 Test Procedures

1. The testing follows ANSI C63.10-2013 clause 7.8.4.
2. The RF output of EUT is connected to the spectrum analyzer by RF cable and attenuator. The path loss is compensated to the results for each measurement.
3. Set the maximum power setting and enable the EUT to transmit continuously.
4. Enable the EUT hopping function.
5. Use the following spectrum analyzer settings: Span = zero span, centered on a hopping channel; RBW = 1 MHz; VBW \geq RBW; Sweep = as necessary to capture the entire dwell time per hopping channel; Detector function = peak; Trace = max hold.
6. Measure and record the results in the test report.

3.3.4 Test Setup

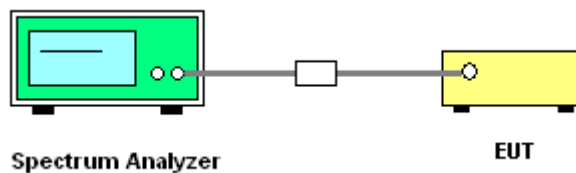

3.3.5 Test Result of Dwell Time

Please refer to Appendix A.

3.4 20dB and 99% Bandwidth Measurement

3.4.1 Limit of 20dB and 99% Bandwidth

Reporting only

3.4.2 Measuring Instruments

Please refer to the measuring equipment list in this test report.

3.4.3 Test Procedures

1. The testing follows ANSI C63.10-2013 clause 6.9.2 and 6.9.3.
2. The RF output of EUT is connected to the spectrum analyzer by RF cable and attenuator. The path loss is compensated to the results for each measurement.
3. Set the maximum power setting and enable the EUT to transmit continuously.
4. Use the following spectrum analyzer settings for 20 dB Bandwidth measurement.
Span = approximately 2 to 5 times the 20 dB bandwidth, centered on a hopping channel;
RBW \geq 1% of the 20 dB bandwidth; VBW \geq RBW; Sweep = auto; Detector function = peak;
Trace = max hold.
5. Use the following spectrum analyzer settings for 99 % Bandwidth measurement.
Span = approximately 1.5 to 5 times the 99% bandwidth, centered on a hopping channel;
RBW \geq 1-5% of the 99% bandwidth; VBW \geq 3 * RBW; Sweep = auto; Detector function = peak;
Trace = max hold.
6. Measure and record the results in the test report.

3.4.4 Test Setup

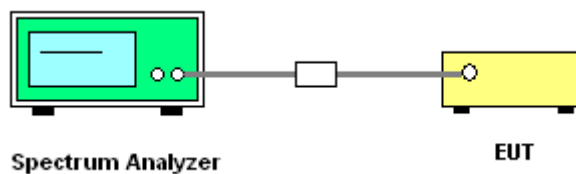

3.4.5 Test Result of 20dB Bandwidth

Please refer to Appendix A.

3.4.6 Test Result of 99% Occupied Bandwidth

Please refer to Appendix A.

3.5 Output Power Measurement

3.5.1 Limit of Output Power

The maximum peak conducted output power of the intentional radiator shall not exceed the following:
For frequency hopping systems operating in the 2400-2483.5 MHz band employing at least 75 non-overlapping hopping channels, and all frequency hopping systems in the 5725-5850 MHz band: 1 watt. For all other frequency hopping systems in the 2400-2483.5 MHz band 0.125 watts.
If directional gain of transmitting antennas is greater than 6 dBi, the power shall be reduced by the same level in dB comparing to gain minus 6 dBi.

3.5.2 Measuring Instruments

Please refer to the measuring equipment list in this test report.

3.5.3 Test Procedures

1. The testing follows ANSI C63.10-2013 clause 7.8.5.
2. The RF output of EUT is connected to the power meter by RF cable and attenuator. The path loss is compensated to the results for each measurement.
3. Set the maximum power setting and enable the EUT to transmit continuously.
4. Measure the conducted output power with cable loss and record the results in the test report.
5. Measure and record the results in the test report.

3.5.4 Test Setup

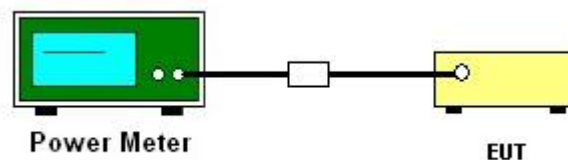

3.5.5 Test Result of Peak Output Power

Please refer to Appendix A.

3.5.6 Test Result of Average Output Power (Reporting Only)

Please refer to Appendix A.

3.6 Conducted Band Edges Measurement

3.6.1 Limit of Band Edges

In any 100 kHz bandwidth outside the intentional radiation frequency band, the radio frequency power shall be at least 20 dB below the highest level of the radiated power. In addition, radiated emissions which fall in the restricted bands must also comply with the radiated emission limits.

3.6.2 Measuring Instruments

Please refer to the measuring equipment list in this test report.

3.6.3 Test Procedures

1. The testing follows ANSI C63.10-2013 clause 7.8.6.
2. Set the maximum power setting and enable the EUT to transmit continuously.
3. Set RBW = 100 kHz, VBW = 300 kHz. Band edge emissions must be at least 20 dB down from the highest emission level within the authorized band as measured with a 100 kHz RBW. The attenuation shall be 30 dB instead of 20 dB when RMS conducted output power procedure is used.
4. Enable hopping function of the EUT and then repeat step 2 and 3.
5. Measure and record the results in the test report.

3.6.4 Test Setup



3.6.5 Test Result of Conducted Band Edges

Please refer to Appendix A.

3.6.6 Test Result of Conducted Hopping Mode Band Edges

Please refer to Appendix A.

3.7 Conducted Spurious Emission Measurement

3.7.1 Limit of Spurious Emission Measurement

In any 100 kHz bandwidth outside the intentional radiation frequency band, the radio frequency power shall be at least 20 dB below the highest level of the radiated power. In addition, radiated emissions which fall in the restricted bands must also comply with the radiated emission limits.

3.7.2 Measuring Instruments

Please refer to the measuring equipment list in this test report.

3.7.3 Test Procedure

1. The testing follows ANSI C63.10-2013 clause 7.8.8.
2. The RF output of EUT is connected to the spectrum analyzer by RF cable and attenuator. The path loss is compensated to the results for each measurement.
3. Set the maximum power setting and enable the EUT to transmit continuously.
4. Set RBW = 100 kHz, VBW = 300 kHz, scan up through 10th harmonic. All harmonics / spurious must be at least 20 dB down from the highest emission level within the authorized band as measured with a 100 kHz RBW.
5. Measure and record the results in the test report.
6. The RF fundamental frequency should be excluded against the limit line in the operating frequency band.

3.7.4 Test Setup



3.7.5 Test Result of Conducted Spurious Emission

Please refer to Appendix A.



3.8 Radiated Band Edges and Spurious Emission Measurement

3.8.1 Limit of Radiated Band Edges and Spurious Emission

In any 100 kHz bandwidth outside the intentional radiator frequency band, all harmonics / spurious must be at least 20 dB below the highest emission level within the authorized band. In addition, radiated emissions which fall in the restricted bands must also comply with the limits as below.

Frequency (MHz)	Field Strength (microvolts/meter)	Measurement Distance (meters)
0.009 – 0.490	2400/F(kHz)	300
0.490 – 1.705	24000/F(kHz)	30
1.705 – 30.0	30	30
30 – 88	100	3
88 – 216	150	3
216 - 960	200	3
Above 960	500	3

3.8.2 Measuring Instruments

Please refer to the measuring equipment list in this test report.



3.8.3 Test Procedures

1. The EUT is placed on a turntable with 0.8 meter for frequency below 1 GHz and 1.5 meter for frequency above 1 GHz respectively above ground.
2. The EUT is set 3 meters away from the receiving antenna, which is mounted on the top of a variable height antenna tower.
3. For each suspected emission, the EUT is arranged to its worst case and then tune the Antenna tower (from 1 m to 4 m) and turntable (from 0 degree to 360 degrees) to find the maximum reading. A pre-amp and a high pass filter are used for the test in order to get better signal level to comply with the guidelines.
4. Set the maximum power setting and enable the EUT to transmit continuously.
5. Use the following spectrum analyzer settings:
 - (1) Span shall wide enough to fully capture the emission being measured;
 - (2) Set RBW = 100 kHz for $f < 1$ GHz, RBW = 1 MHz for $f > 1$ GHz ; VBW \geq RBW; Sweep = auto; Detector function = peak; Trace = max hold for peak
 - (3) For average measurement: use duty cycle correction factor method per 15.35(c).
Duty cycle = On time/100 milliseconds
On time = $N_1 * L_1 + N_2 * L_2 + \dots + N_{n-1} * L_{n-1} + N_n * L_n$
Where N_1 is number of type 1 pulses, L_1 is length of type 1 pulses, etc.
Average Emission Level = Peak Emission Level + $20 * \log$ (Duty cycle)
6. Corrected Reading: Antenna Factor + Cable Loss + Read Level - Preamp Factor = Level
7. Radiated testing below 1 GHz is performed by adjusting the antenna tower from 1 m to 4 m and by rotating the turn table from 0 degree to 360 degrees to find the peak maximum hold reading. When there is no suspected emission found and the emission level is with at least 6 dB margin against QP limit line, the position is marked as “-“.
8. Radiated testing above 1 GHz is performed by adjusting the antenna tower from 1 m to 4 m and by rotating the turn table from 0 degree to 360 degrees to find the peak maximum hold reading for scanning all frequencies. When there is no suspected emission found and the harmonic emission level is with at least 6 dB margin against average limit line, the position is marked as “-“.

Note: The average levels are calculated from the peak level corrected with duty cycle correction factor (-24.79dB for BR+EDR /-24.67 dB for HR Ant. 3 and HR Ant. 4 / -24.76 dB for HR 2Mbps Ant. 3+4) derived from $20 \log$ (dwell time/100ms). This correction is only for signals that hop with the fundamental signal, such as band-edge and harmonic. Other spurious signals that are independent of the hopping signal would not use this correction.

3.8.4 Test Setup

For radiated test below 30MHz

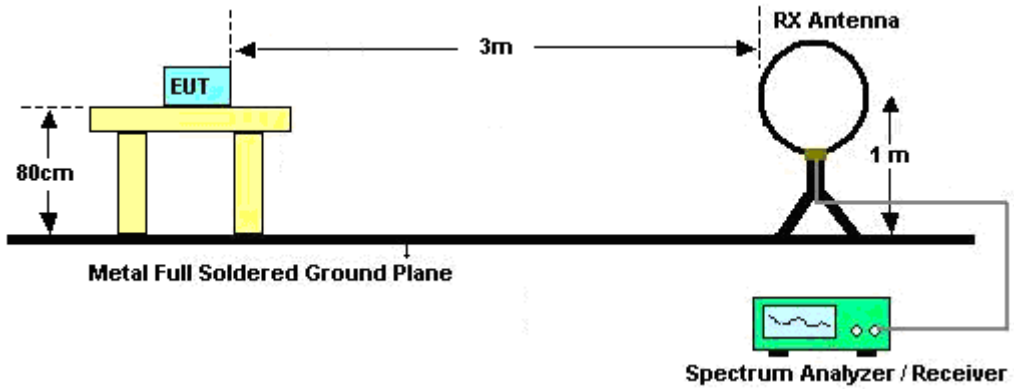

For radiated test from 30MHz to 1GHz

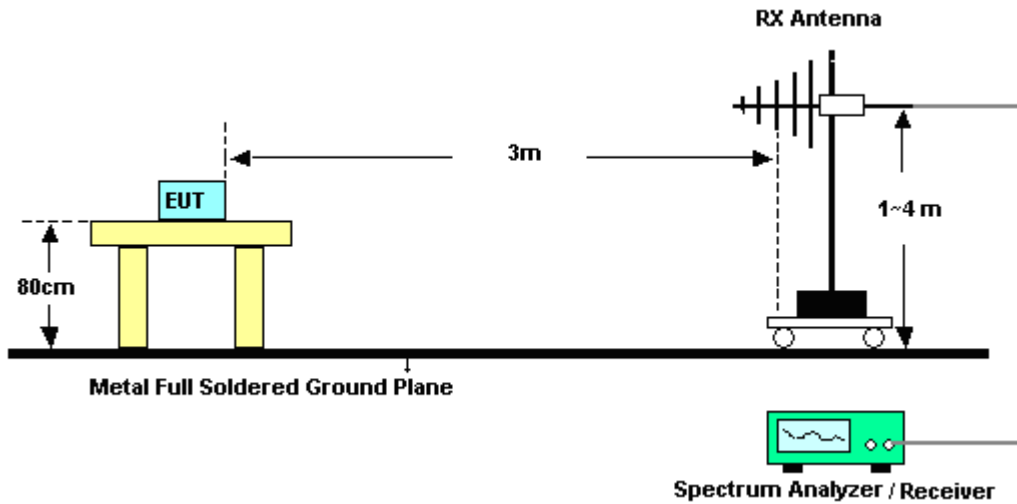

For radiated test from 1GHz to 18GHz

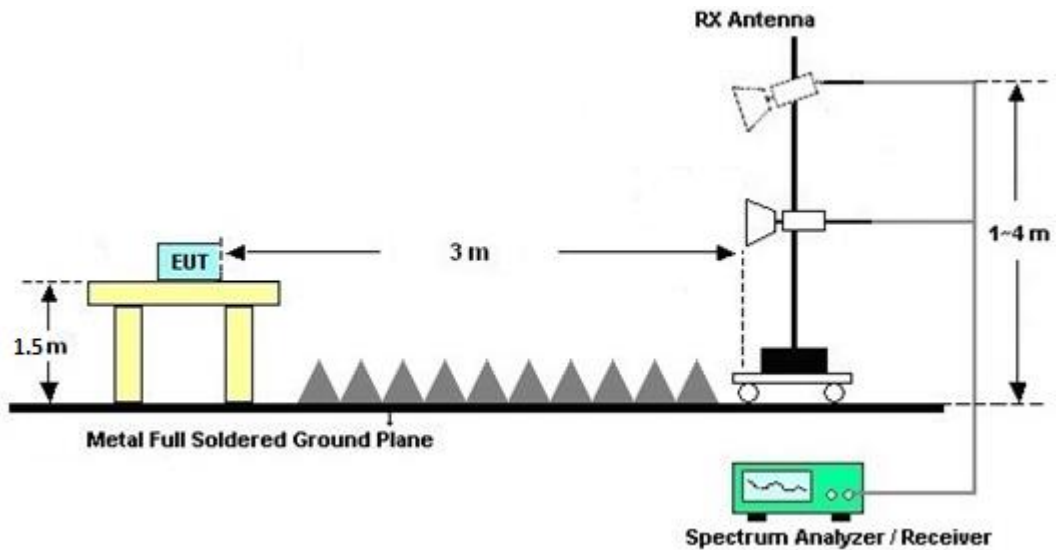

For radiated test above 18GHz

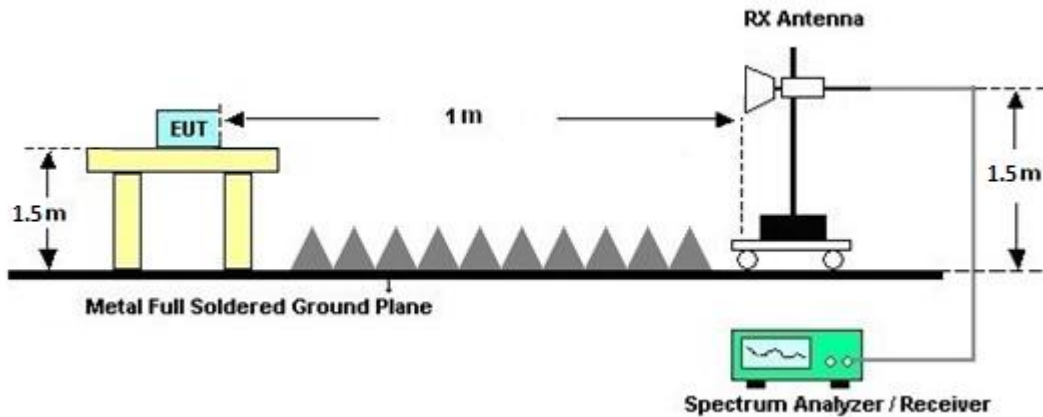

3.8.5 Test Results of Radiated Spurious Emissions (9 kHz ~ 30 MHz)

The low frequency, which starts from 9 kHz to 30 MHz, is pre-scanned and the result which is 20 dB lower than the limit line is not reported.

There is adequate comparison measurement of both open-field test site and alternative test site - semi-Anechoic chamber according to 414788 D01 Radiated Test Site v01r01, and the result comes out very similar.

3.8.6 Test Result of Radiated Spurious at Band Edges

Please refer to Appendix C and D.

3.8.7 Duty Cycle

Please refer to Appendix E.

3.8.8 Test Result of Radiated Spurious Emission (30MHz ~ 10th Harmonic)

Please refer to Appendix C and D.



3.9 AC Conducted Emission Measurement

3.9.1 Limit of AC Conducted Emission

For equipment that is designed to be connected to the public utility (AC) power line, the radio frequency voltage that is conducted back onto the AC power line on any frequency or frequencies within the band 150 kHz to 30 MHz shall not exceed the limits in the following table.

Frequency of emission (MHz)	Conducted limit (dB μ V)	
	Quasi-peak	Average
0.15-0.5	66 to 56*	56 to 46*
0.5-5	56	46
5-30	60	50

*Decreases with the logarithm of the frequency.

3.9.2 Measuring Instruments

Please refer to the measuring equipment list in this test report.

3.9.3 Test Procedures

1. The EUT is placed 0.4 meter away from the conducting wall of the shielding room, and is kept at least 80 centimeters from any other grounded conducting surface.
2. Connect EUT to the power mains through a line impedance stabilization network (LISN).
3. All the support units are connecting to the other LISN.
4. The LISN provides 50 ohm coupling impedance for the measuring instrument.
5. The FCC states that a 50 ohm, 50 microhenry LISN shall be used.
6. Both Line and Neutral shall be tested in order to find out the maximum conducted emission.
7. The frequency range from 150 kHz to 30 MHz is scanned.
8. Set the test-receiver system to Peak Detect Function and specified bandwidth (IF Bandwidth = 9 kHz) with Maximum Hold Mode. Then measurement is also conducted by Average Detector and Quasi-Peak Detector Function respectively.

3.9.4 Test Setup

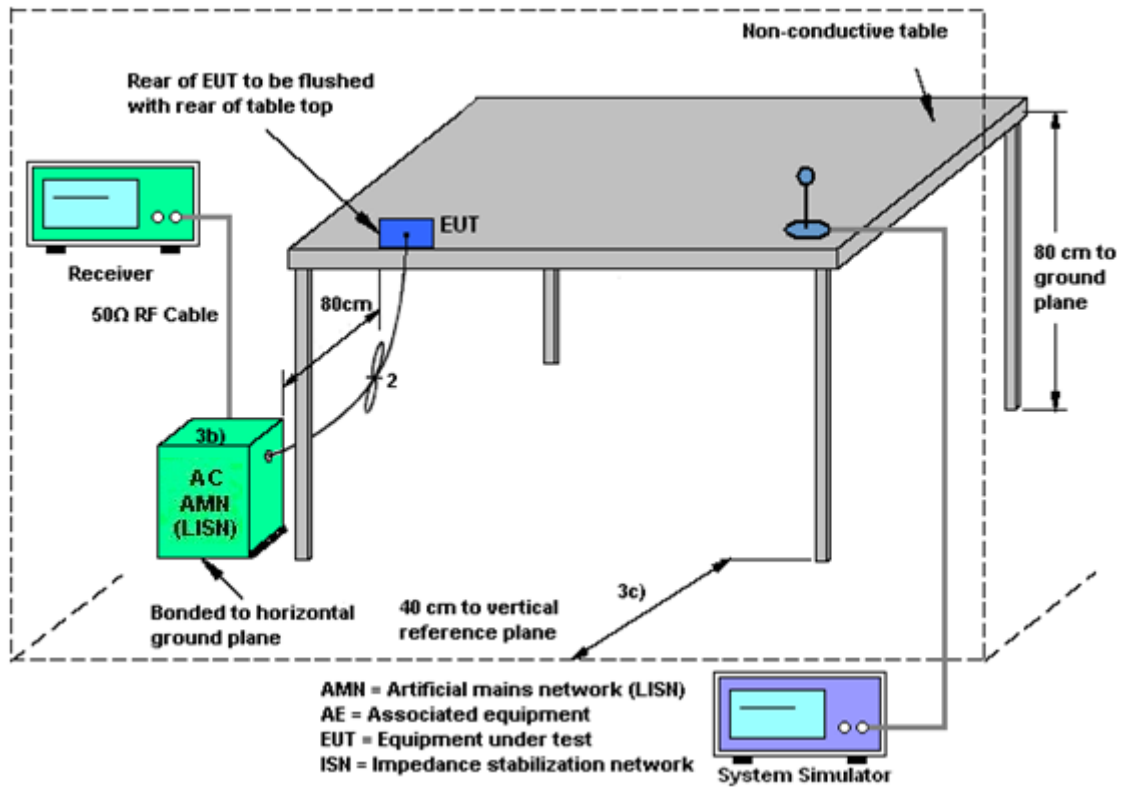

3.9.5 Test Result of AC Conducted Emission

Please refer to Appendix B.



3.10 Antenna Requirements

3.10.1 Standard Applicable

The use of a permanently attached antenna or of an antenna that uses a unique coupling to the intentional radiator shall be considered sufficient to comply with the rule.

3.10.2 Antenna Anti-Replacement Construction

An embedded-in antenna design is used.



4 List of Measuring Equipment

Instrument	Brand Name	Model No.	Serial No.	Characteristics	Calibration Date	Test Date	Due Date	Remark
AC Power Source	ChainTek	APC-1000W	N/A	N/A	N/A	May 17, 2023	N/A	Conduction (CO05-HY)
EMI Test Receiver	Rohde & Schwarz	ESR3	102388	9kHz~3.6GHz	Dec. 01, 2022	May 17, 2023	Nov. 30, 2023	Conduction (CO05-HY)
Hygrometer	Testo	608-H1	34913912	N/A	Nov. 17, 2022	May 17, 2023	Nov. 16, 2023	Conduction (CO05-HY)
LISN	Rohde & Schwarz	ENV216	100081	9kHz~30MHz	Nov. 17, 2022	May 17, 2023	Nov. 16, 2023	Conduction (CO05-HY)
Software	Rohde & Schwarz	EMC32	N/A	N/A	N/A	May 17, 2023	N/A	Conduction (CO05-HY)
Pulse Limiter	SCHWARZBECK	VTSD 9561-FN	00691	N/A	Aug. 01, 2022	May 17, 2023	Jul. 31, 2023	Conduction (CO05-HY)
LISN Cable	MVE	RG-400	260260	N/A	Dec. 29, 2022	May 17, 2023	Dec. 28, 2023	Conduction (CO05-HY)
Hygrometer	TECPEL	DTM-303A	TP201996	N/A	Nov. 17, 2022	May 16, 2023~Jun. 02, 2023	Nov. 16, 2023	Conducted (TH05-HY)
Power Meter	Anritsu	ML2495A	1036004	N/A	Aug. 08, 2022	May 16, 2023~Jun. 02, 2023	Aug. 07, 2023	Conducted (TH05-HY)
Power Sensor	Anritsu	MA2411B	1027253	300MHz~40GHz	Aug. 08, 2022	May 16, 2023~Jun. 02, 2023	Aug. 07, 2023	Conducted (TH05-HY)
Signal Analyzer	Rohde & Schwarz	FSV40	101905	10Hz - 40GHz(amp)	Aug. 03, 2022	May 16, 2023~Jun. 02, 2023	Aug. 02, 2023	Conducted (TH05-HY)
Loop Antenna	Rohde & Schwarz	HFH2-Z2	100488	9 kHz~30 MHz	Sep. 20, 2022	Apr. 11, 2023~Apr. 29, 2023	Sep. 19, 2023	Radiation (03CH22-HY)
Bilog Antenna with 6dB pad	TESEQ & WOKEN	CBL 6111D & 00802N1D-06	63304 & 002	N/A	Oct. 04, 2022	Apr. 11, 2023~Apr. 29, 2023	Oct. 03, 2023	Radiation (03CH22-HY)
Amplifier	SONOMA	310N	421581	N/A	Jul. 16, 2022	Apr. 11, 2023~Apr. 29, 2023	Jul. 15, 2023	Radiation (03CH22-HY)
Double Ridged Guide Horn Antenna	RFSPIN	DRH18-E	LE2C05A18EN	1GHz~18GHz	Jul. 06, 2022	Apr. 11, 2023~Apr. 29, 2023	Jul. 05, 2023	Radiation (03CH22-HY)
SHF-EHF Horn Antenna	SCHWARZBECK	BBHA9170	00991	18GHz-40GHz	May 14, 2022	Apr. 11, 2023~Apr. 29, 2023	May 13, 2023	Radiation (03CH22-HY)
Amplifier	EMEC	EM01G18GA	060877	N/A	Sep. 29, 2022	Apr. 11, 2023~Apr. 29, 2023	Sep. 28, 2023	Radiation (03CH22-HY)
Preamplifier	EMEC	EM18G40G	060872	18-40GHz	Sep. 28, 2022	Apr. 11, 2023~Apr. 29, 2023	Sep. 27, 2023	Radiation (03CH22-HY)
Signal Analyzer	Keysight	N9010B	MY60241058	N/A	Jul. 07, 2022	Apr. 11, 2023~Apr. 29, 2023	Jul. 06, 2023	Radiation (03CH22-HY)
Hygrometer	TECPEL	DTM-303B	TP140325	N/A	Nov. 07, 2022	Apr. 11, 2023~Apr. 29, 2023	Nov. 06, 2023	Radiation (03CH22-HY)
Controller	EMEC	EM1000	N/A	Control Turn table & Ant Mast	N/A	Apr. 11, 2023~Apr. 29, 2023	N/A	Radiation (03CH22-HY)
Antenna Mast	ChainTek	MBS-520-1	N/A	1m~4m	N/A	Apr. 11, 2023~Apr. 29, 2023	N/A	Radiation (03CH22-HY)
Turn Table	ChainTek	T-200-S-1	N/A	0~360 Degree	N/A	Apr. 11, 2023~Apr. 29, 2023	N/A	Radiation (03CH22-HY)
Software	Audix	E3 6.09824_2019122	RK-002347	N/A	N/A	Apr. 11, 2023~Apr. 29, 2023	N/A	Radiation (03CH22-HY)
RF Cable	HUBER + SUHNER	SUCOFLEX 102	803951/2	9kHz~30MHz	Mar. 07, 2023	Apr. 11, 2023~Apr. 29, 2023	Mar. 06, 2024	Radiation (03CH22-HY)
RF Cable	HUBER + SUHNER	SUCOFLEX 102	804390/2,804611/2,804615/2	N/A	Oct. 25, 2022	Apr. 11, 2023~Apr. 29, 2023	Oct. 24, 2023	Radiation (03CH22-HY)



5 Measurement Uncertainty

Uncertainty of Conducted Emission Measurement (150 kHz ~ 30 MHz)

Measuring Uncertainty for a Level of Confidence of 95% ($U = 2Uc(y)$)	3.50 dB
---	---------

Uncertainty of Radiated Emission Measurement (30 MHz ~ 1000 MHz)

Measuring Uncertainty for a Level of Confidence of 95% ($U = 2Uc(y)$)	5.92 dB
---	---------

Uncertainty of Radiated Emission Measurement (1000 MHz ~ 6000 MHz)

Measuring Uncertainty for a Level of Confidence of 95% ($U = 2Uc(y)$)	4.42 dB
---	---------

Uncertainty of Radiated Emission Measurement (6000 MHz ~ 18000 MHz)

Measuring Uncertainty for a Level of Confidence of 95% ($U = 2Uc(y)$)	4.40 dB
---	---------

Uncertainty of Radiated Emission Measurement (18000 MHz ~ 40000 MHz)

Measuring Uncertainty for a Level of Confidence of 95% ($U = 2Uc(y)$)	5.38 dB
---	---------

Appendix A. Test Result of Conducted Test Items

Test Engineer:	Derek Hsu	Temperature:	21~25	°C
Test Date:	2023/05/16~2023/06/01	Relative Humidity:	51~54	%

<BR+EDR Ant. 3>

TEST RESULTS DATA									
20dB and 99% Occupied Bandwidth and Hopping Channel Separation									
Mod.	Data Rate	NTX	CH.	Freq. (MHz)	20db BW (MHz)	99% Bandwidth (MHz)	Hopping Channel Separation Measurement (MHz)	Hopping Channel Separation Measurement Limit (MHz)	Pass/Fail
DH	1Mbps	1	0	2402	1.044	0.953	1.020	0.6957	Pass
DH	1Mbps	1	39	2441	1.048	0.951	1.324	0.6985	Pass
DH	1Mbps	1	78	2480	1.048	0.955	1.007	0.6985	Pass
2DH	2Mbps	1	0	2402	1.313	1.191	1.016	0.8753	Pass
2DH	2Mbps	1	39	2441	1.313	1.191	1.012	0.8753	Pass
2DH	2Mbps	1	78	2480	1.313	1.191	1.016	0.8753	Pass
3DH	3Mbps	1	0	2402	1.265	1.167	0.999	0.8435	Pass
3DH	3Mbps	1	39	2441	1.265	1.167	0.994	0.8435	Pass
3DH	3Mbps	1	78	2480	1.265	1.167	1.007	0.8435	Pass

TEST RESULTS DATA						
Dwell Time						
Mod.	Hopping Channel Number Rate	Hops Over Occupancy Time (hops)	Package Transfer Time (msec)	Dwell Time (sec)	Limits (sec)	Pass/Fail
3DH5	79	106.670	2.90	0.31	0.4	Pass
3DH5 (AFH)	20	53.330	2.90	0.15	0.4	Pass

TEST RESULTS DATA					
Peak Power Table					
DH	CH.	NTX	Peak Power (dBm)	Power Limit (dBm)	Test Result
DH1	0	1	20.81	20.97	Pass
	39	1	20.76	20.97	Pass
	78	1	20.63	20.97	Pass
2DH1	0	1	20.40	20.97	Pass
	39	1	20.69	20.97	Pass
	78	1	20.71	20.97	Pass
3DH1	0	1	20.45	20.97	Pass
	39	1	20.67	20.97	Pass
	78	1	20.70	20.97	Pass

TEST RESULTS DATA				
Average Power Table				
(Reporting Only)				
DH	CH.	NTX	Average Power (dBm)	Duty Factor (dB)
DH1	0	1	20.27	5.17
	39	1	20.24	5.17
	78	1	20.13	5.17
2DH1	0	1	17.56	5.06
	39	1	17.95	5.06
	78	1	17.96	5.06
3DH1	0	1	17.05	5.06
	39	1	17.46	5.06
	78	1	17.47	5.06

TEST RESULTS DATA			
Number of Hopping Frequency			
Number of Hopping (Channel)	Adaptive Frequency Hopping (Channel)	Limits (Channel)	Pass/Fail
79	20	> 15	Pass

<BR+EDR Ant. 4>

TEST RESULTS DATA									
20dB and 99% Occupied Bandwidth and Hopping Channel Separation									
Mod.	Data Rate	NTX	CH.	Freq. (MHz)	20db BW (MHz)	99% Bandwidth (MHz)	Hopping Channel Separation Measurement (MHz)	Hopping Channel Separation Measurement Limit (MHz)	Pass/Fail
DH	1Mbps	1	0	2402	1.044	0.953	1.007	0.6957	Pass
DH	1Mbps	1	39	2441	1.048	0.951	0.994	0.6985	Pass
DH	1Mbps	1	78	2480	1.048	0.953	1.016	0.6985	Pass
2DH	2Mbps	1	0	2402	1.313	1.191	0.986	0.8753	Pass
2DH	2Mbps	1	39	2441	1.313	1.191	1.003	0.8753	Pass
2DH	2Mbps	1	78	2480	1.313	1.191	0.999	0.8753	Pass
3DH	3Mbps	1	0	2402	1.270	1.167	0.999	0.8464	Pass
3DH	3Mbps	1	39	2441	1.265	1.167	0.947	0.8435	Pass
3DH	3Mbps	1	78	2480	1.265	1.169	1.003	0.8435	Pass

TEST RESULTS DATA						
Dwell Time						
Mod.	Hopping Channel Number Rate	Hops Over Occupancy Time (hops)	Package Transfer Time (msec)	Dwell Time (sec)	Limits (sec)	Pass/Fail
3DH5	79	106.670	2.90	0.31	0.4	Pass
3DH5 (AFH)	20	53.330	2.90	0.15	0.4	Pass

TEST RESULTS DATA					
Peak Power Table					
DH	CH.	NTX	Peak Power (dBm)	Power Limit (dBm)	Test Result
DH1	0	1	19.84	20.97	Pass
	39	1	19.85	20.97	Pass
	78	1	19.95	20.97	Pass
2DH1	0	1	20.61	20.97	Pass
	39	1	20.68	20.97	Pass
	78	1	20.59	20.97	Pass
3DH1	0	1	20.78	20.97	Pass
	39	1	20.70	20.97	Pass
	78	1	20.54	20.97	Pass

TEST RESULTS DATA				
Average Power Table (Reporting Only)				
DH	CH.	NTX	Average Power (dBm)	Duty Factor (dB)
DH1	0	1	19.28	5.17
	39	1	19.31	5.17
	78	1	19.38	5.17
2DH1	0	1	17.80	5.06
	39	1	17.98	5.06
	78	1	17.79	5.06
3DH1	0	1	17.52	5.09
	39	1	17.44	5.09
	78	1	17.34	5.09

TEST RESULTS DATA			
Number of Hopping Frequency			
Number of Hopping (Channel)	Adaptive Frequency Hopping (Channel)	Limits (Channel)	Pass/Fail
79	20	> 15	Pass

<HR 2Mbps Ant. 3>

TEST RESULTS DATA									
20dB and 99% Occupied Bandwidth and Hopping Channel Separation									
Mod.	Data Rate	NTX	CH.	Freq. (MHz)	20db BW (MHz)	99% Bandwidth (MHz)	Hopping Channel Separation Measurement (MHz)	Hopping Channel Separation Measurement Limit (MHz)	Pass/Fail
2DH	2Mbps	1	0	2402	1.317	1.199	1.120	0.8783	Pass
2DH	2Mbps	1	39	2441	1.317	1.199	1.012	0.8783	Pass
2DH	2Mbps	1	78	2480	1.317	1.199	1.098	0.8783	Pass

TEST RESULTS DATA						
Dwell Time						
Mod.	Hopping Channel Number Rate	Hops Over Occupancy Time (hops)	Package Transfer Time (msec)	Dwell Time (sec)	Limits (sec)	Pass/Fail
DH5	79	106.670	2.92	0.31	0.4	Pass
DH5 (AFH)	20	53.330	2.92	0.16	0.4	Pass

TEST RESULTS DATA					
Peak Power Table					
DH	CH.	NTX	Peak Power (dBm)	Power Limit (dBm)	Test Result
2DH1	0	1	20.67	20.97	Pass
	39	1	20.87	20.97	Pass
	78	1	20.96	20.97	Pass

TEST RESULTS DATA				
Average Power Table				
(Reporting Only)				
DH	CH.	NTX	Average Power (dBm)	Duty Factor (dB)
2DH1	0	1	17.82	4.74
	39	1	18.03	4.74
	78	1	18.12	4.74

TEST RESULTS DATA			
Number of Hopping Frequency			
Number of Hopping (Channel)	Adaptive Frequency Hopping (Channel)	Limits (Channel)	Pass/Fail
79	20	> 15	Pass

<HR 2Mbps Ant. 4>

TEST RESULTS DATA**20dB and 99% Occupied Bandwidth and Hopping Channel Separation**

Mod.	Data Rate	NTX	CH.	Freq. (MHz)	20db BW (MHz)	99% Bandwidth (MHz)	Hopping Channel Separation Measurement (MHz)	Hopping Channel Separation Measurement Limit (MHz)	Pass/Fail
2DH	2Mbps	1	0	2402	1.313	1.191	0.994	0.8753	Pass
2DH	2Mbps	1	39	2441	1.313	1.191	1.016	0.8753	Pass
2DH	2Mbps	1	78	2480	1.313	1.191	0.999	0.8753	Pass

TEST RESULTS DATA**Dwell Time**

Mod.	Hopping Channel Number Rate	Hops Over Occupancy Time (hops)	Package Transfer Time (msec)	Dwell Time (sec)	Limits (sec)	Pass/Fail
DH5	79	106.670	2.93	0.31	0.4	Pass
DH5 (AFH)	20	53.330	2.93	0.16	0.4	Pass

TEST RESULTS DATA**Peak Power Table**

DH	CH.	NTX	Peak Power (dBm)	Power Limit (dBm)	Test Result
2DH1	0	1	20.59	20.97	Pass
	39	1	20.43	20.97	Pass
	78	1	20.35	20.97	Pass

TEST RESULTS DATA**Average Power Table****(Reporting Only)**

DH	CH.	NTX	Average Power (dBm)	Duty Factor (dB)
2DH1	0	1	17.63	4.74
	39	1	17.54	4.74
	78	1	17.34	4.74

TEST RESULTS DATA**Number of Hopping Frequency**

Number of Hopping (Channel)	Adaptive Frequency Hopping (Channel)	Limits (Channel)	Pass/Fail
79	20	> 15	Pass

<TXBF BR+DER Ant. 3+4>

TEST RESULTS DATA													
20dB and 99% Occupied Bandwidth and Hopping Channel Separation													
Mod.	Data Rate	NTX	CH.	Freq. (MHz)	20db BW (MHz)		99% Bandwidth (MHz)		Hopping Channel Separation Measurement (MHz)		Hopping Channel Separation Measurement Limit (MHz)		Pass/Fail
					Ant 3	Ant 4	Ant 3	Ant 4	Ant 3	Ant 4	Ant 3	Ant 4	
DH	1Mbps	2	0	2402	1.043	1.043	0.949	0.947	0.999	0.994	0.6957	0.6957	Pass
DH	1Mbps	2	39	2441	1.048	1.043	0.947	0.945	0.999	1.003	0.6986	0.6957	Pass
DH	1Mbps	2	78	2480	1.043	1.043	0.947	0.947	1.003	0.999	0.6957	0.6957	Pass
2DH	2Mbps	2	0	2402	1.313	1.313	1.191	1.189	1.016	1.003	0.8754	0.8754	Pass
2DH	2Mbps	2	39	2441	1.313	1.313	1.191	1.189	0.990	1.003	0.8754	0.8754	Pass
2DH	2Mbps	2	78	2480	1.309	1.309	1.189	1.191	1.007	1.007	0.8725	0.8725	Pass
3DH	3Mbps	2	0	2402	1.265	1.265	1.165	1.167	1.003	1.003	0.8435	0.8435	Pass
3DH	3Mbps	2	39	2441	1.265	1.265	1.167	1.165	0.999	1.003	0.8435	0.8435	Pass
3DH	3Mbps	2	78	2480	1.265	1.265	1.165	1.167	1.007	1.007	0.8435	0.8435	Pass

TEST RESULTS DATA						
Dwell Time						
Mod.	Hopping Channel Number Rate	Hops Over Occupancy Time(hops)	Package Transfer Time (msec)	Dwell Time (sec)	Limits (sec)	Pass/Fail
Normal	79	106.67	2.90	0.31	0.4	Pass
AFH	20	53.33	2.90	0.15	0.4	Pass

TEST RESULTS DATA							
Peak Power Table							
DH	CH.	NTX	Peak Power Ant 3 (dBm)	Peak Power Ant 4 (dBm)	Peak Power Total (dBm)	Power Limit (dBm)	Test Result
DH1	0	2	17.88	17.06	20.50	20.97	Pass
	39	2	17.74	17.00	20.40	20.97	Pass
	78	2	17.92	17.21	20.59	20.97	Pass
2DH1	0	2	17.84	17.94	20.90	20.97	Pass
	39	2	18.00	17.70	20.86	20.97	Pass
	78	2	17.98	17.46	20.74	20.97	Pass
3DH1	0	2	17.93	17.97	20.96	20.97	Pass
	39	2	17.90	17.54	20.73	20.97	Pass
	78	2	17.72	17.32	20.53	20.97	Pass

TEST RESULTS DATA						
Average Power Table						
(Reporting Only)						
DH	CH.	NTX	Average Power Ant 3 (dBm)	Average Power Ant 4 (dBm)	Average Power Total (dBm)	Duty Factor (dB)
DH1	0	2	17.29	16.61	19.98	5.15
	39	2	17.22	16.60	19.94	5.15
	78	2	17.31	16.81	20.08	5.15
2DH1	0	2	15.17	15.31	18.25	5.05
	39	2	15.30	15.08	18.20	5.05
	78	2	15.36	14.87	18.13	5.05
3DH1	0	2	14.79	14.81	17.81	5.05
	39	2	14.76	14.52	17.65	5.05
	78	2	14.60	14.40	17.51	5.05

TEST RESULTS DATA			
Number of Hopping Frequency			
Number of Hopping (Channel)	Adaptive Frequency Hopping (Channel)	Limits (Channel)	Pass/Fail
79	20	> 15	Pass

TEST RESULTS DATA													
20dB and 99% Occupied Bandwidth and Hopping Channel Separation													
Mod.	Data Rate	NTX	CH.	Freq. (MHz)	20db BW (MHz)		99% Bandwidth (MHz)		Hopping Channel Separation Measurement (MHz)		Hopping Channel Separation Measurement Limit (MHz)		Pass/Fail
					Ant 3	Ant 4	Ant 3	Ant 4	Ant 3	Ant 4	Ant 3	Ant 4	
HR2	2Mbps	2	0	2402	1.317	1.313	1.197	1.197	1.012	1.007	0.8783	0.8754	Pass
HR2	2Mbps	2	39	2441	1.317	1.317	1.197	1.199	1.012	1.003	0.8783	0.8783	Pass
HR2	2Mbps	2	78	2480	1.317	1.313	1.197	1.199	1.007	1.007	0.8783	0.8753	Pass

TEST RESULTS DATA						
Dwell Time						
Mod.	Hopping Channel Number Rate	Hops Over Occupancy Time(hops)	Package Transfer Time (msec)	Dwell Time (sec)	Limits (sec)	Pass/Fail
Nomal	79	106.67	2.93	0.31	0.4	Pass
AFH	20	53.33	2.93	0.16	0.4	Pass

TEST RESULTS DATA							
Peak Power Table							
DH	CH.	NTX	Peak Power Ant 3 (dBm)	Peak Power Ant 4 (dBm)	Peak Power Total (dBm)	Power Limit (dBm)	Test Result
HR2 DH1	0	2	17.97	17.91	20.95	20.97	Pass
	39	2	18.10	17.80	20.96	20.97	Pass
	78	2	18.10	17.68	20.91	20.97	Pass

TEST RESULTS DATA						
Average Power Table						
(Reporting Only)						
DH	CH.	NTX	Average Power Ant 3 (dBm)	Average Power Ant 4 (dBm)	Average Power Total (dBm)	Duty Factor (dB)
HR2 DH1	0	2	15.20	15.14	18.18	5.05
	39	2	15.36	15.06	18.22	5.05
	78	2	15.36	14.75	18.07	5.05

TEST RESULTS DATA			
Number of Hopping Frequency			
Number of Hopping (Channel)	Adaptive Frequency Hopping (Channel)	Limits (Channel)	Pass/Fail
79	20	> 15	Pass



<BR+EDR Ant.3>

Number of Hopping Frequency

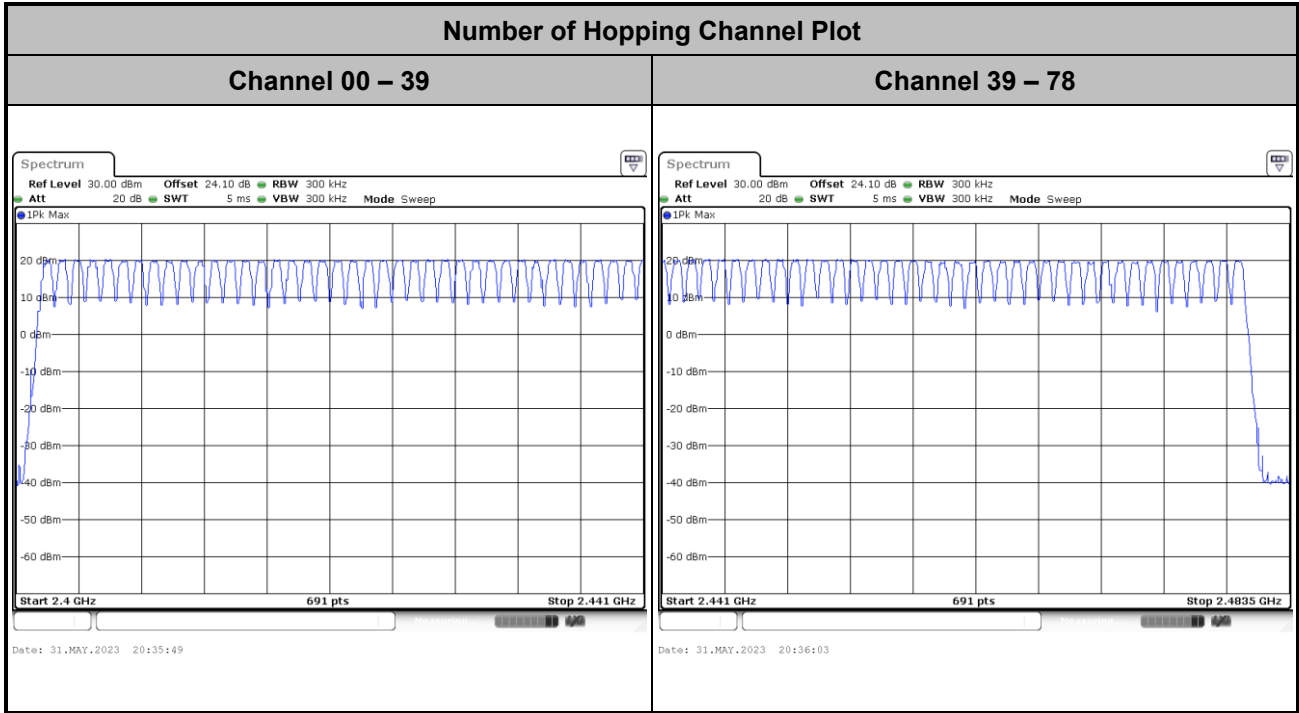



Hopping Channel Separation

<1Mbps>

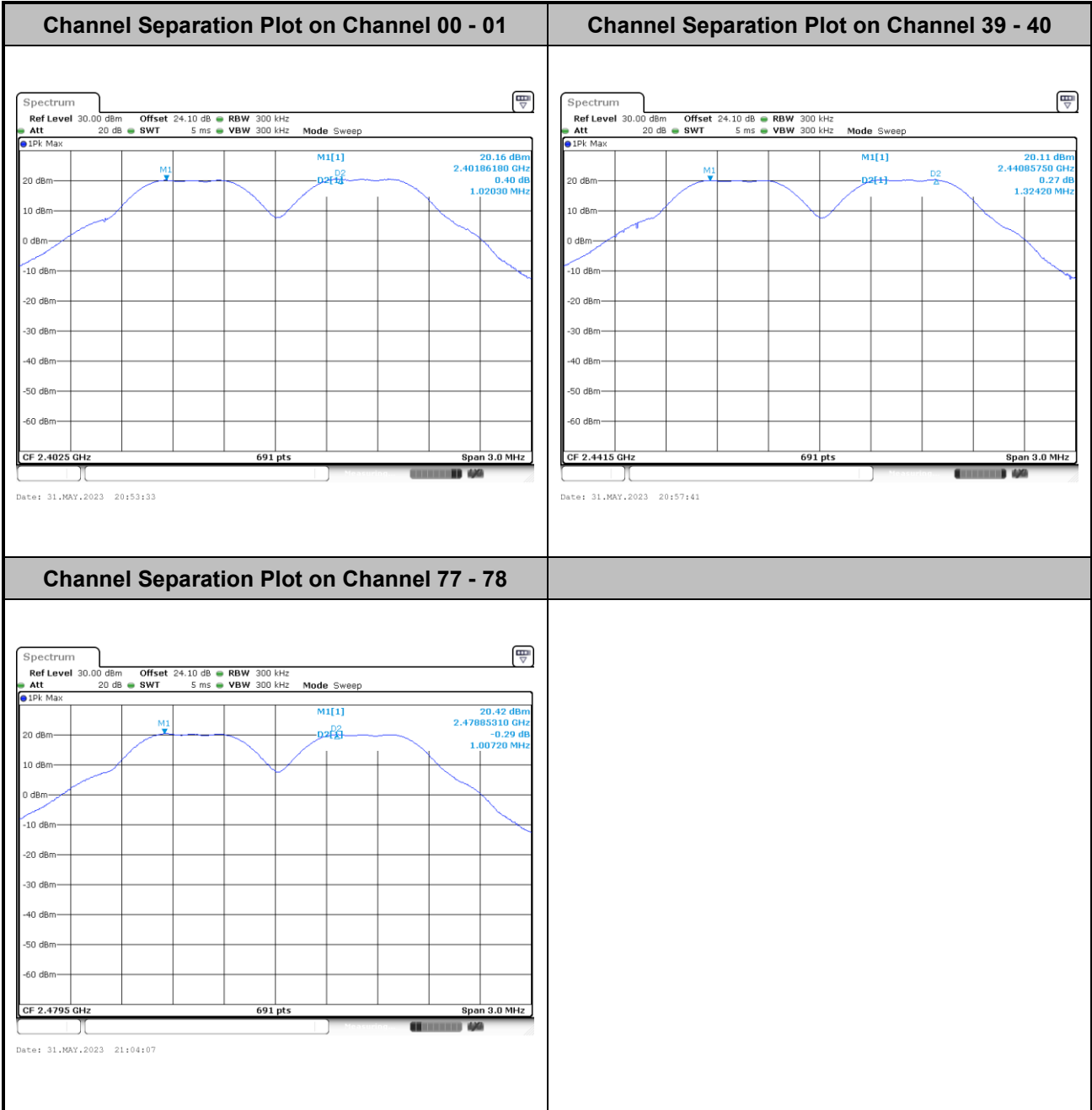



<2Mbps>

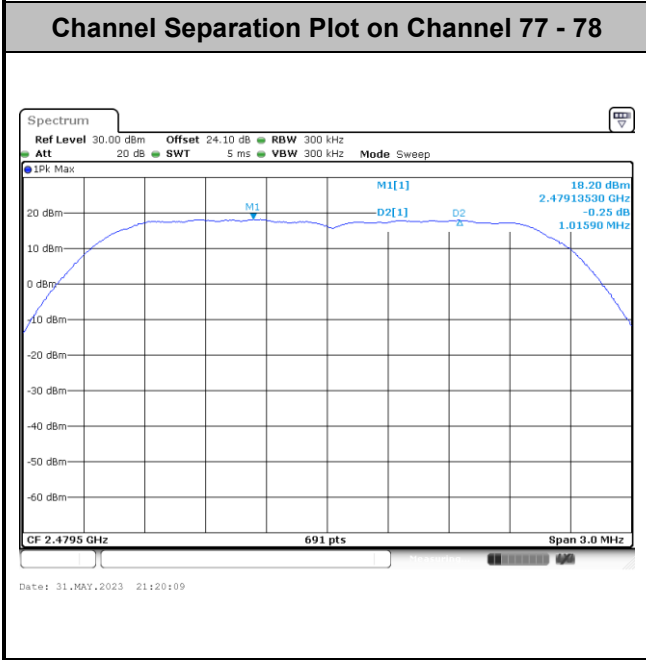
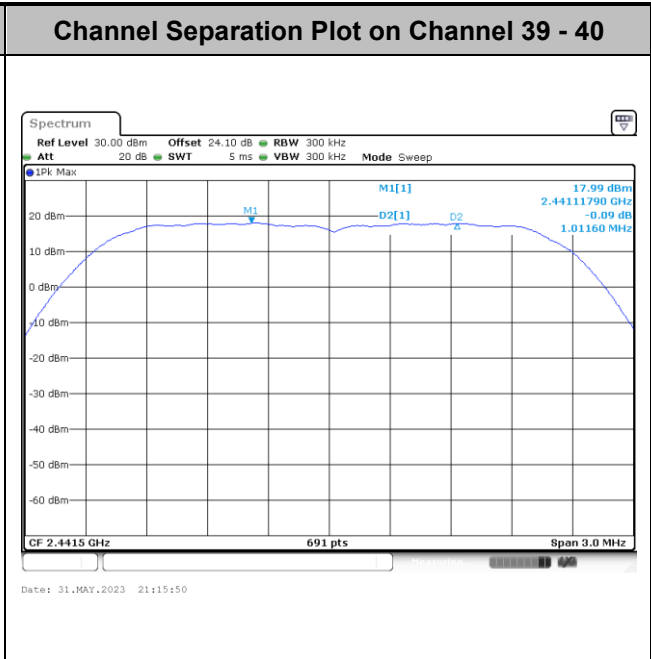
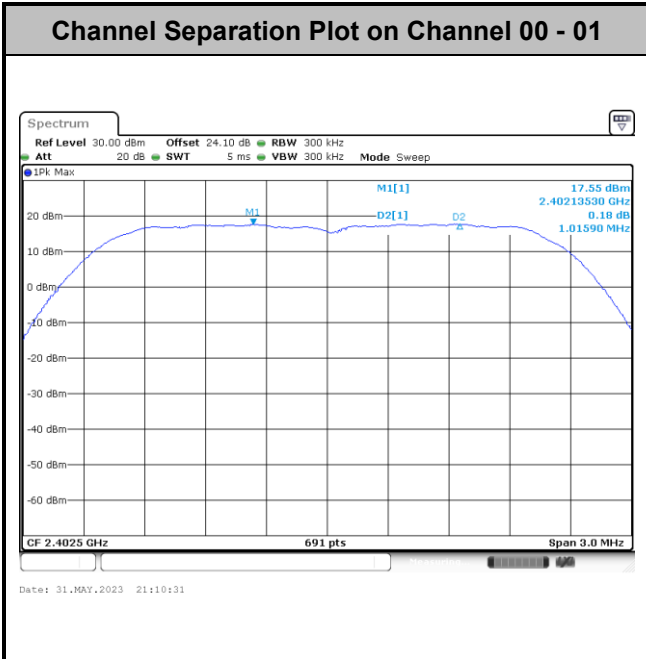



<3Mbps>

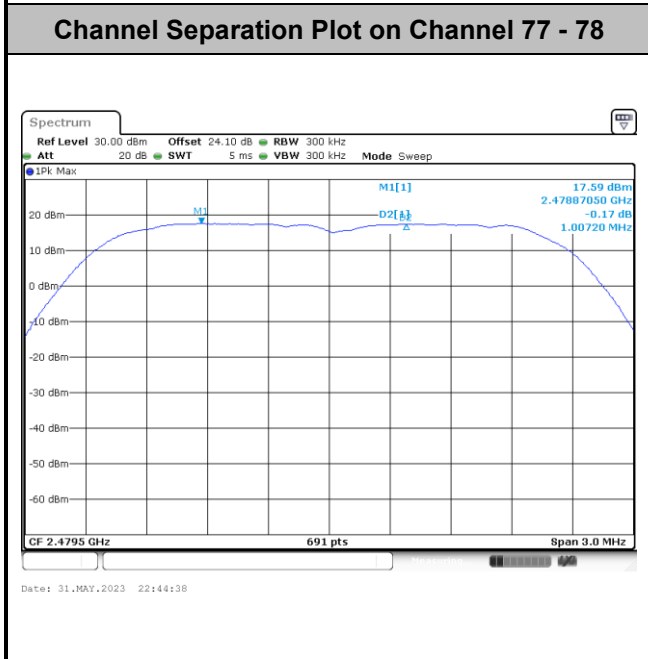
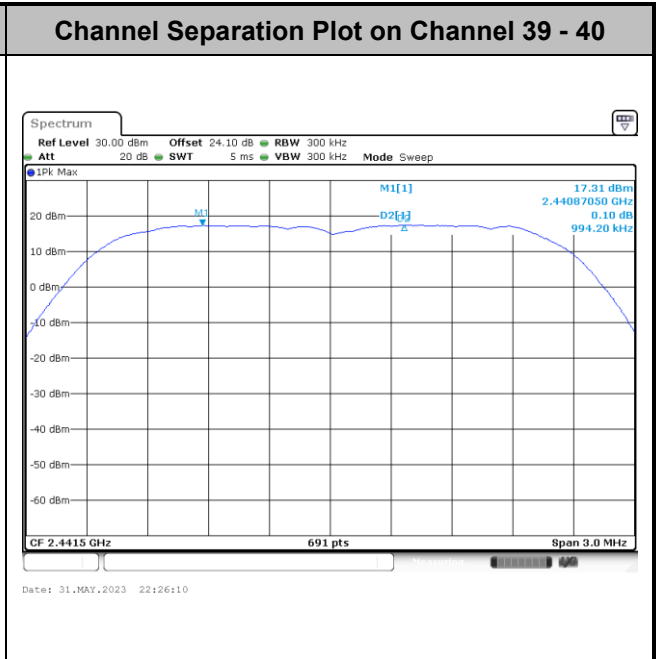
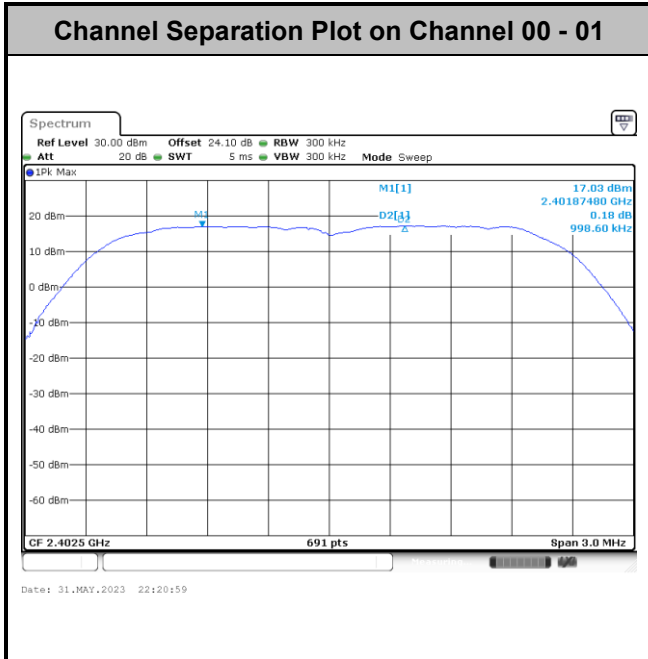



Dwell Time

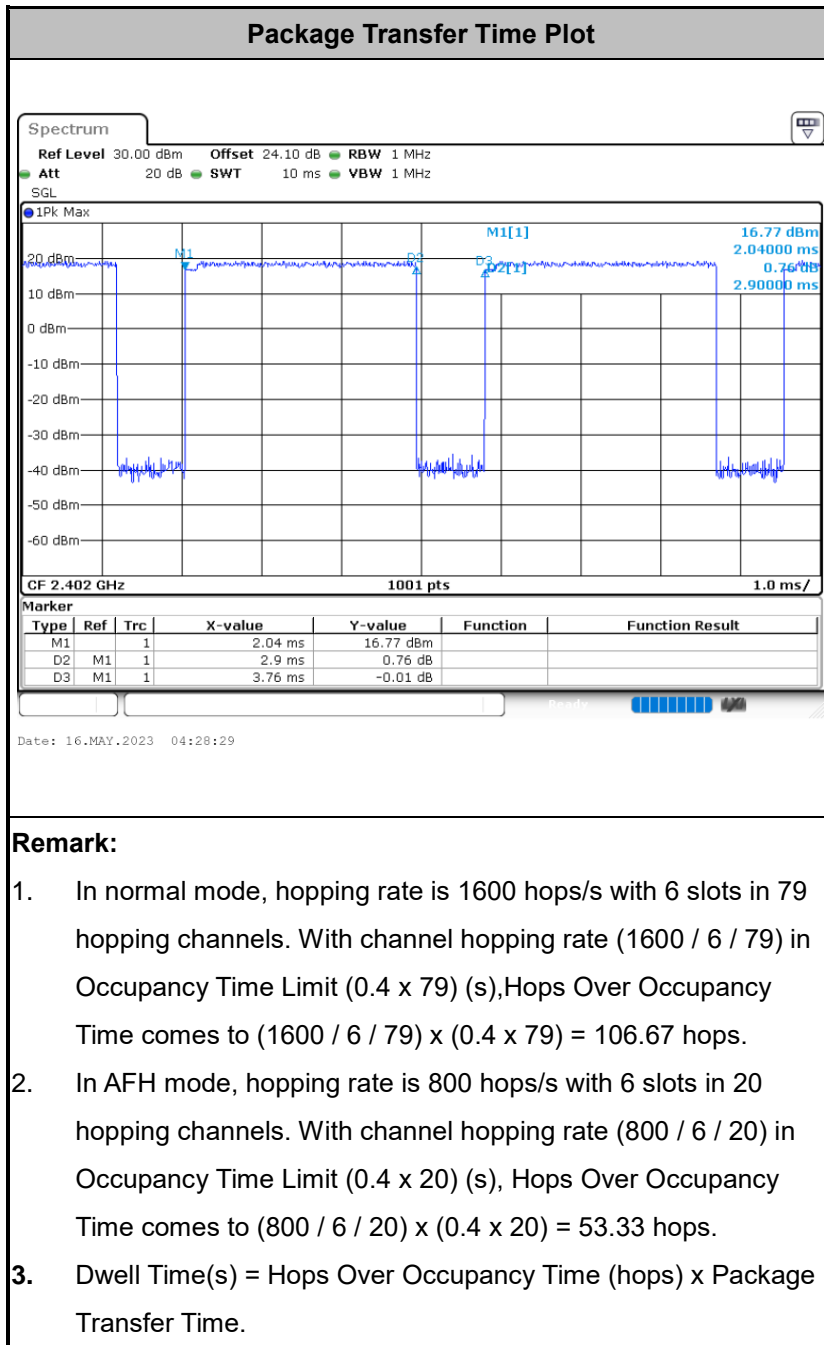



20dB Bandwidth

<1Mbps>

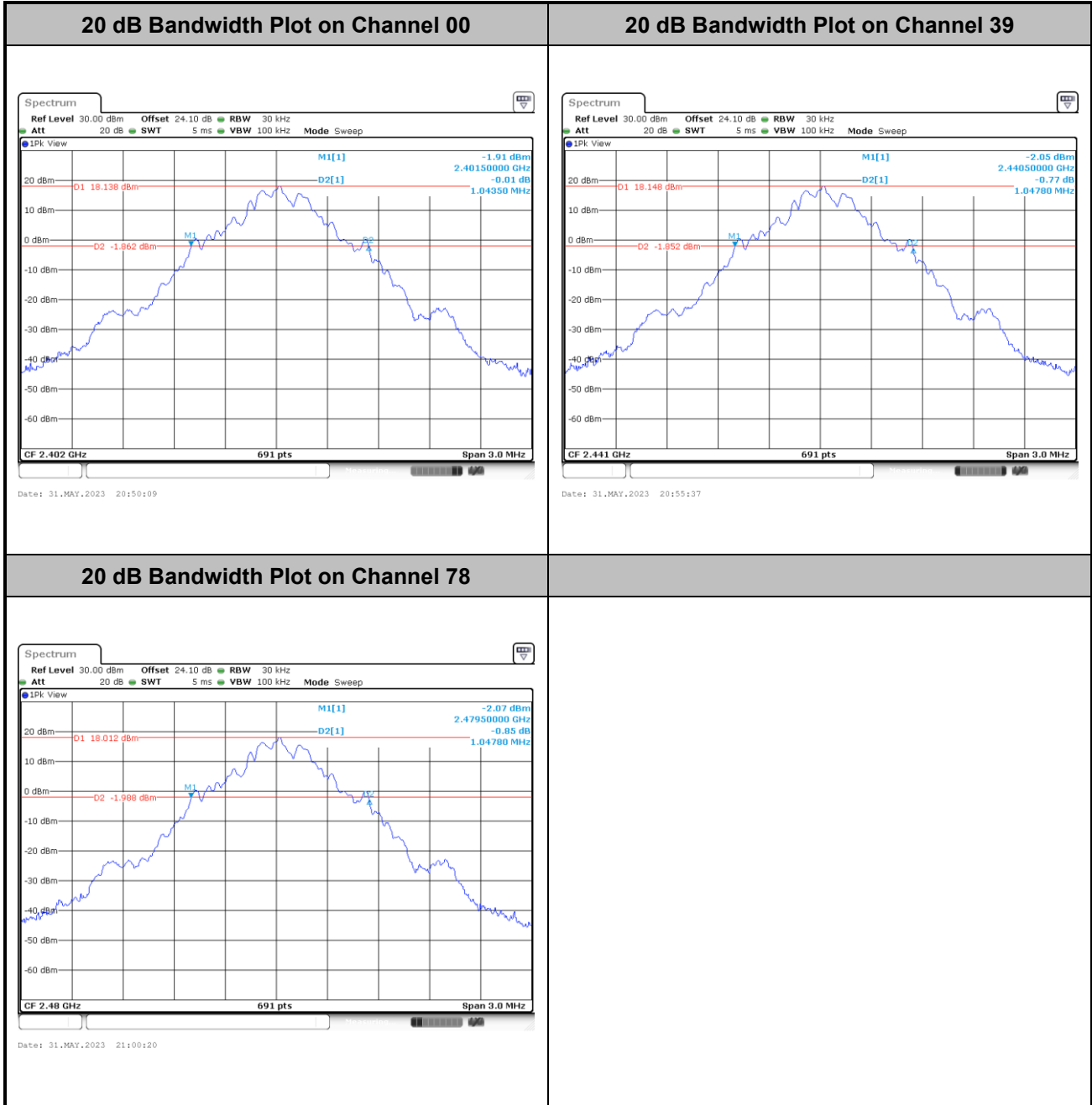



<2Mbps>

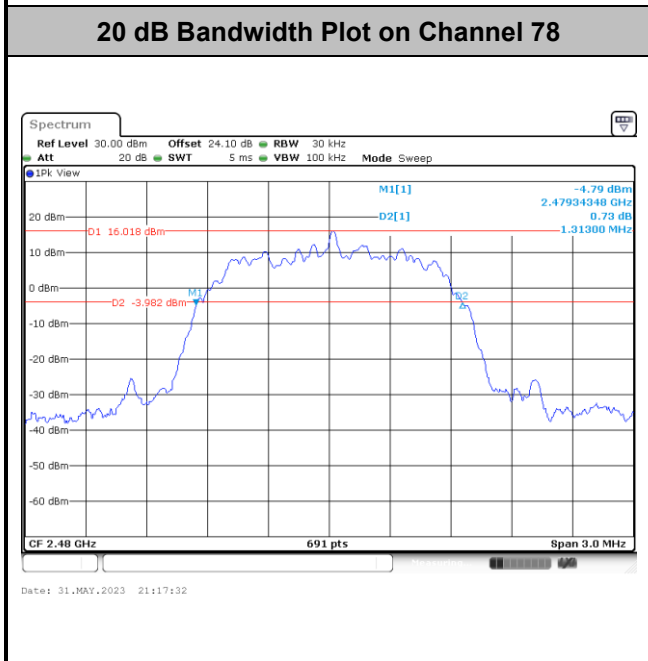
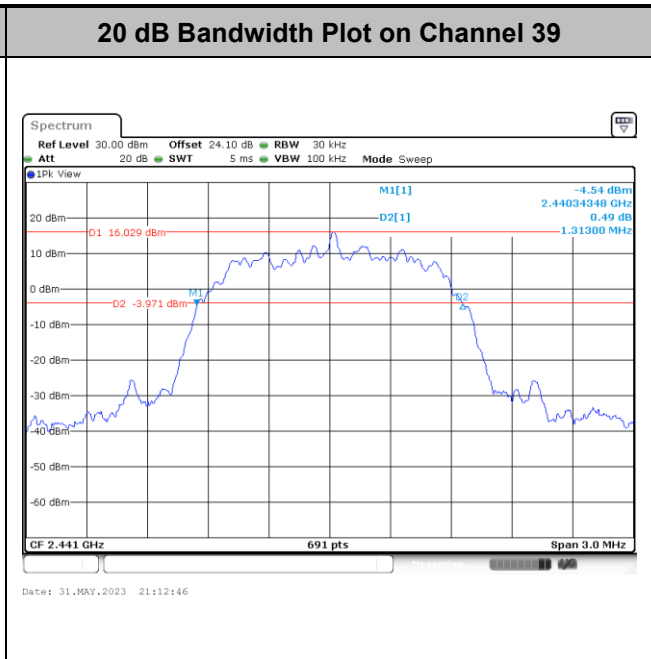
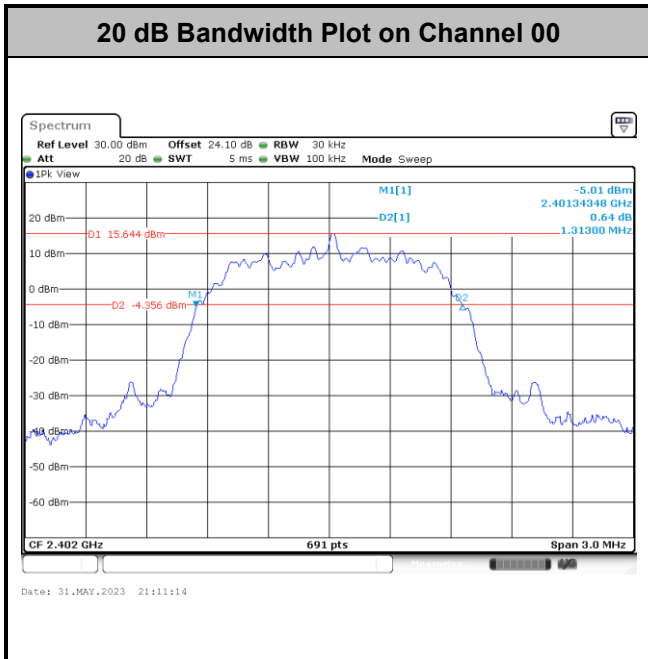



<3Mbps>

20 dB Bandwidth Plot on Channel 00

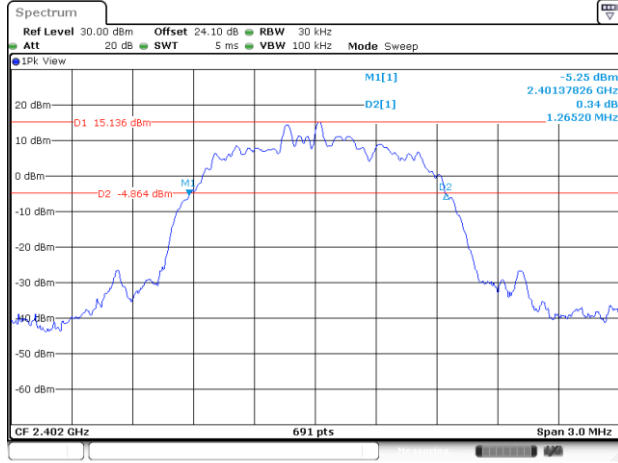

20 dB Bandwidth Plot on Channel 39

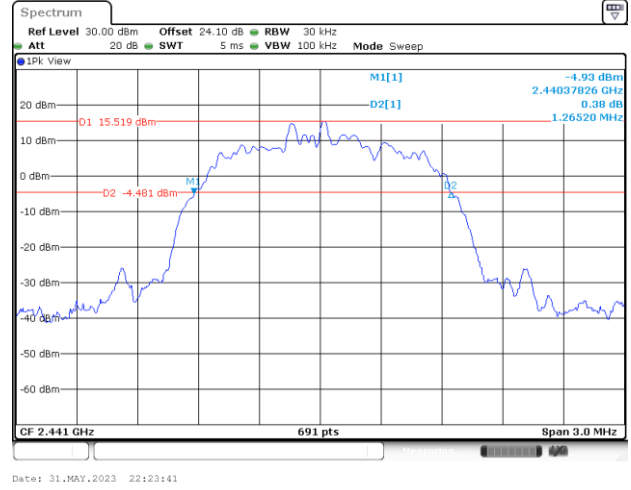

20 dB Bandwidth Plot on Channel 78

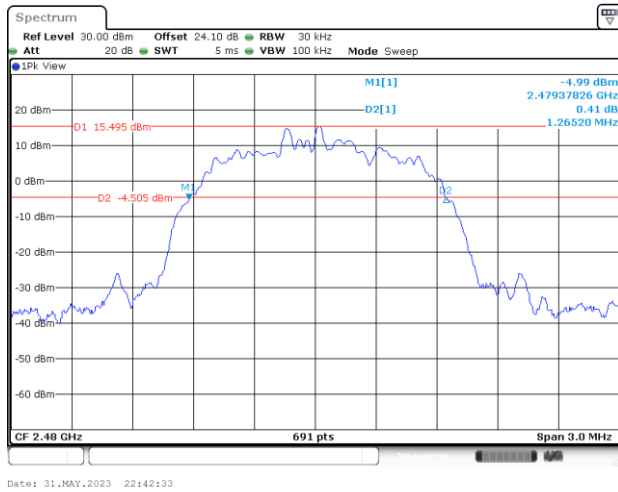



99% Occupied Bandwidth

<1Mbps>

99% Occupied Bandwidth on Channel 00

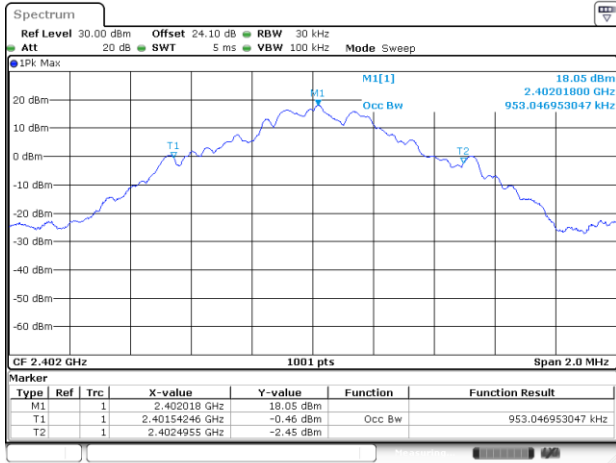

Date: 31.MAY.2023 20:46:32

99% Occupied Bandwidth on Channel 39

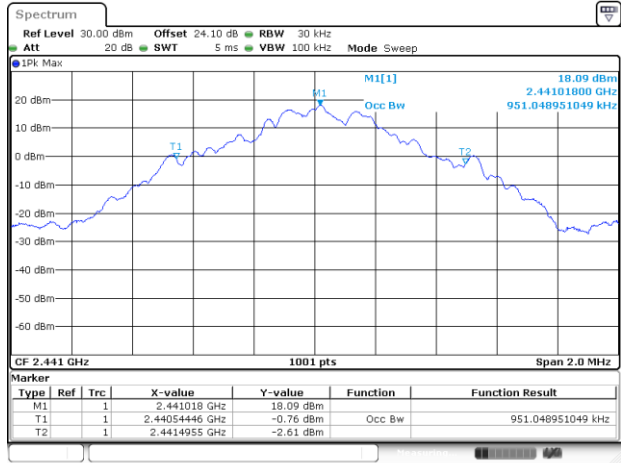

Date: 31.MAY.2023 20:55:00

99% Occupied Bandwidth on Channel 78

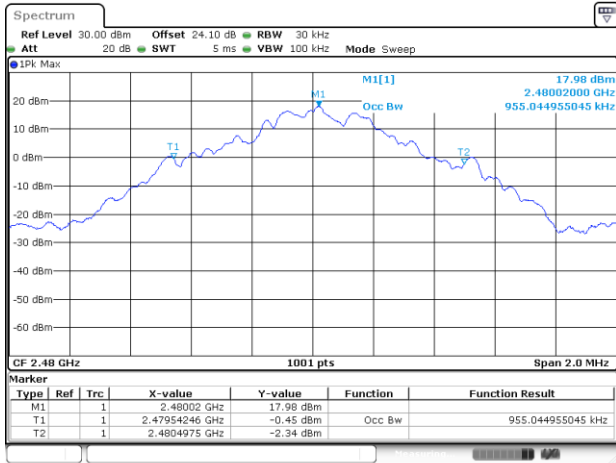

Date: 31.MAY.2023 20:58:49



<2Mbps>

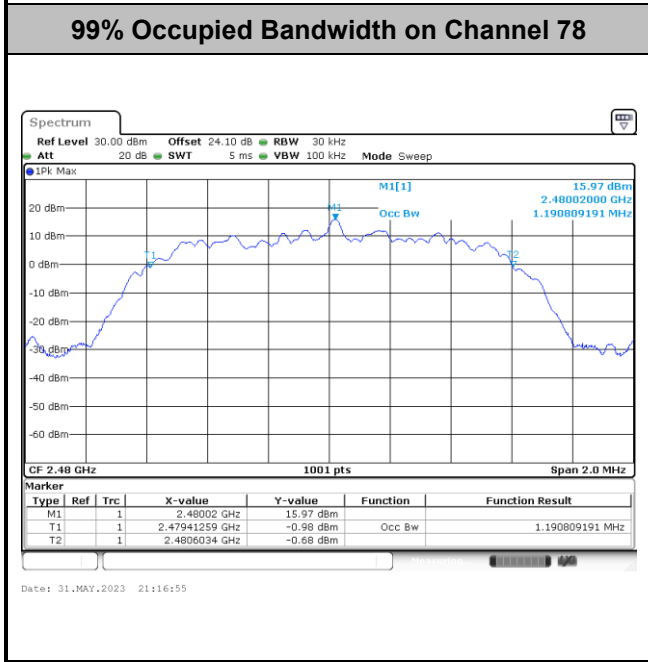
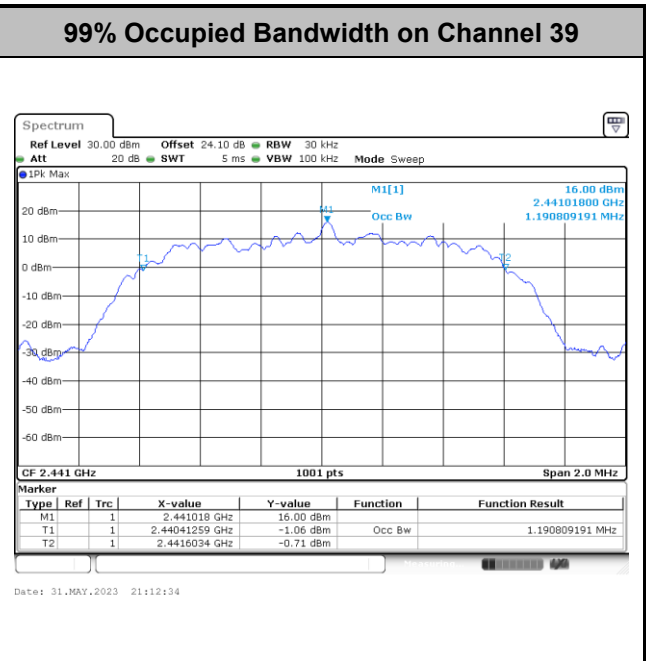
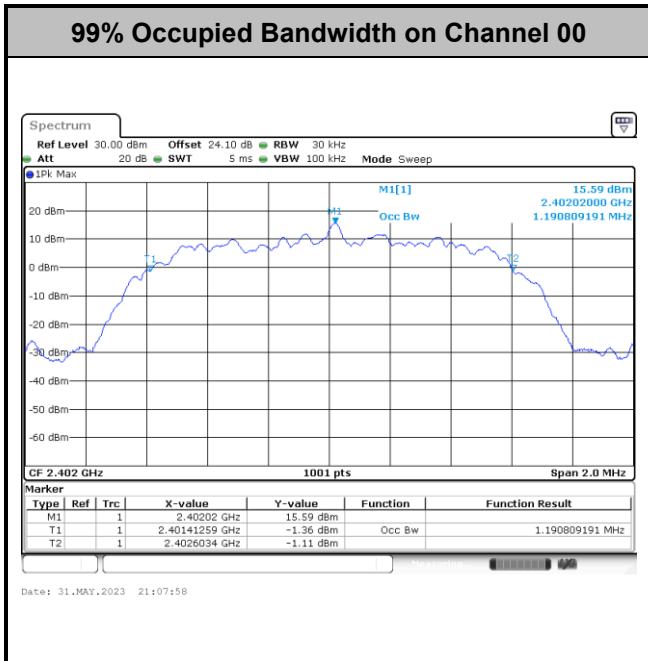



<3Mbps>

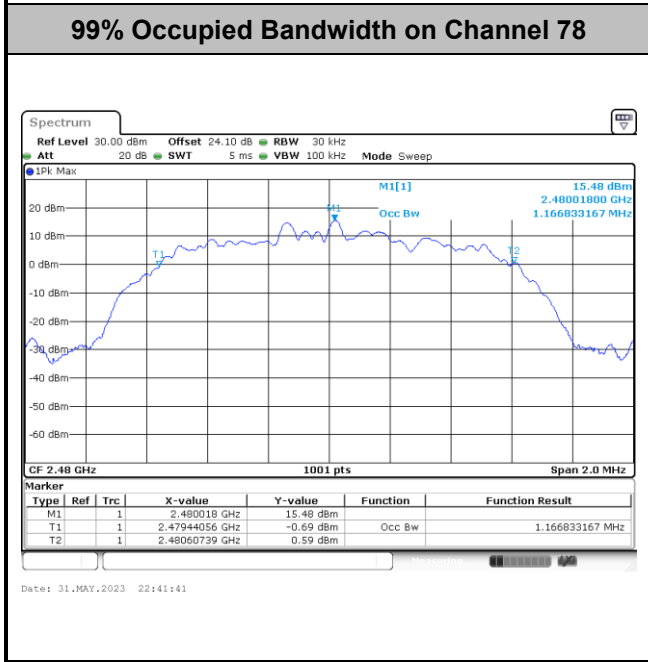
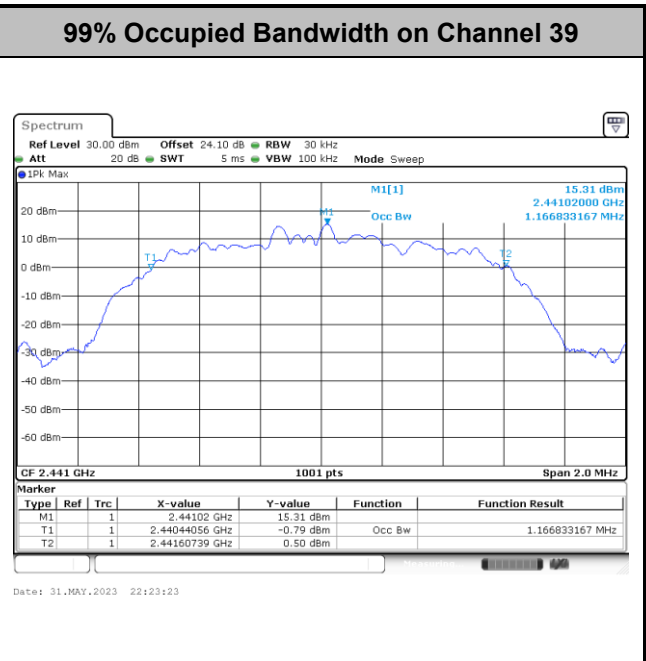
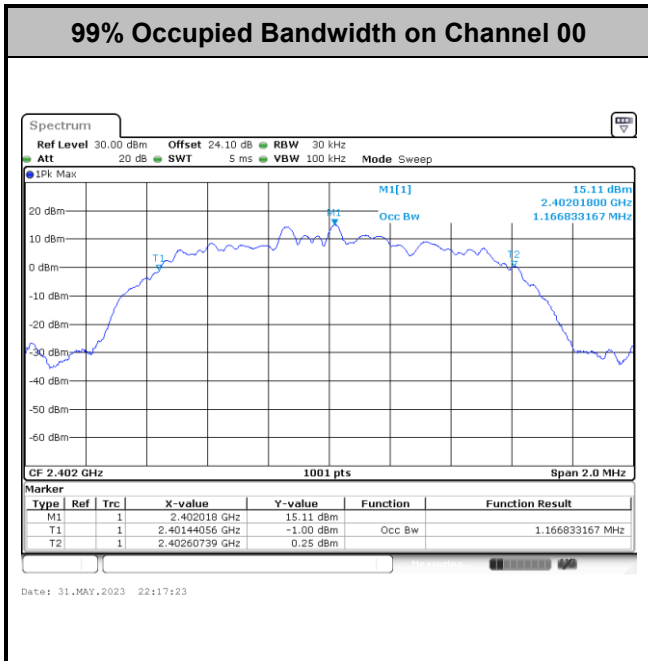

Note: The occupied channel bandwidth is maintained within the band of operation for all of the modulations.



Band Edges

<1Mbps>

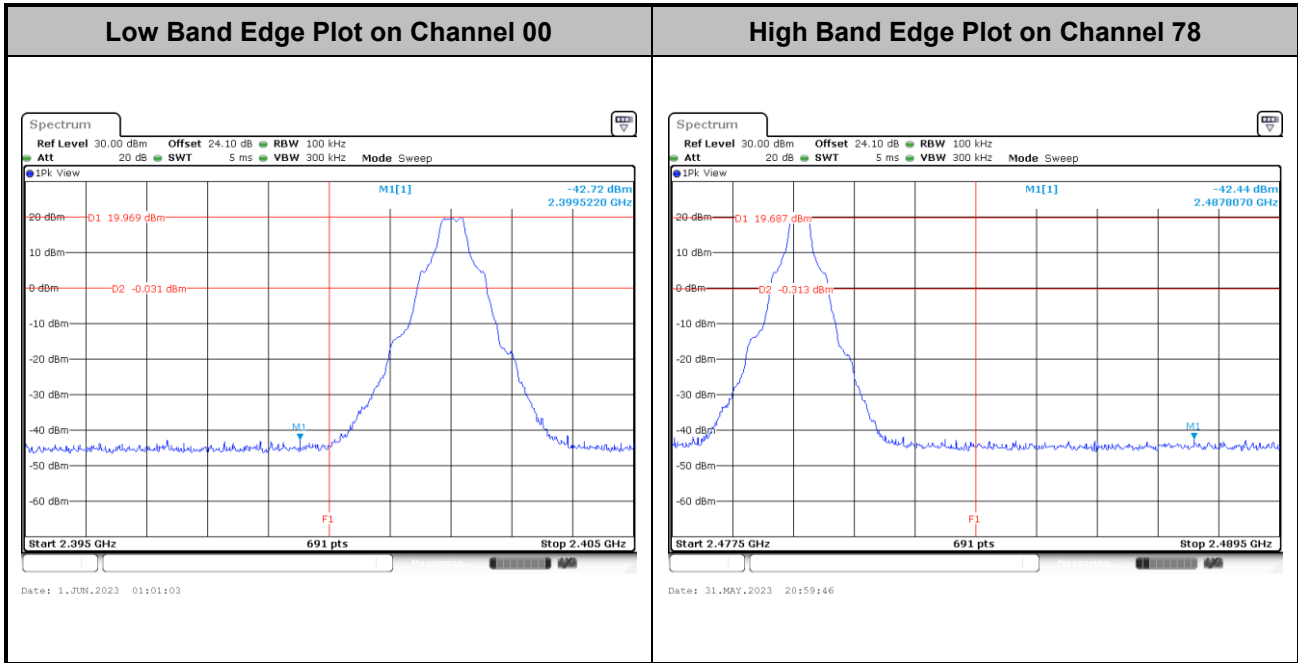

<2Mbps>

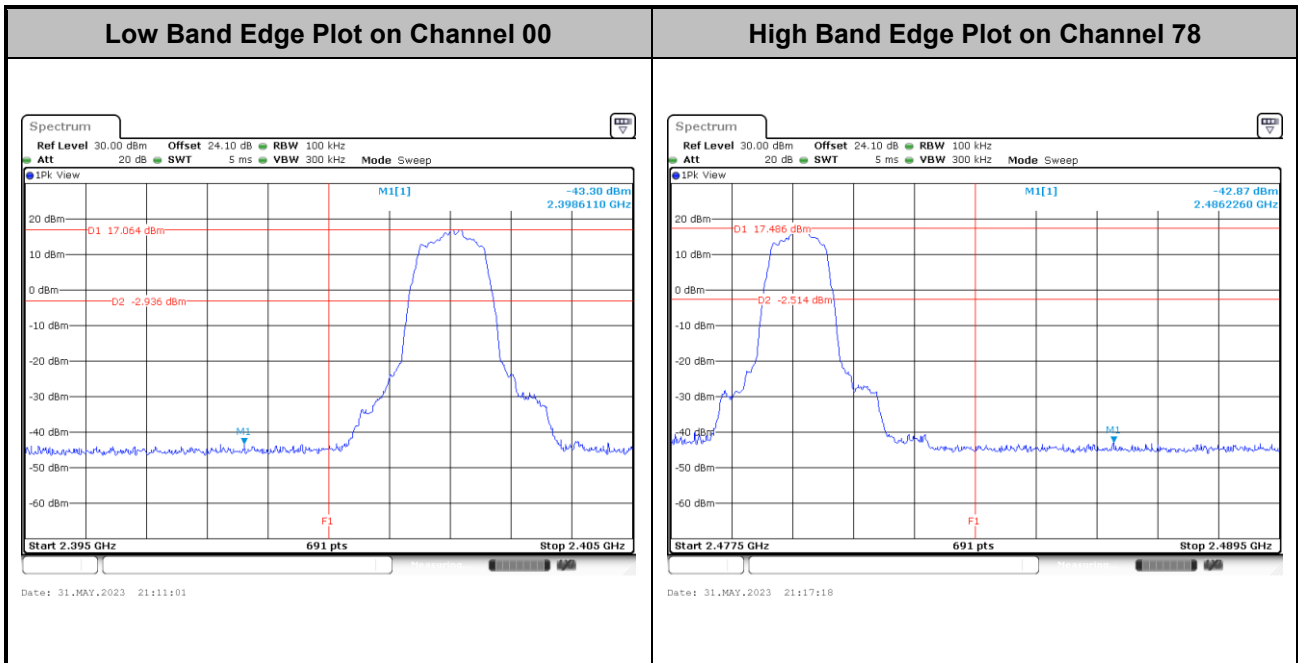



<3Mbps>

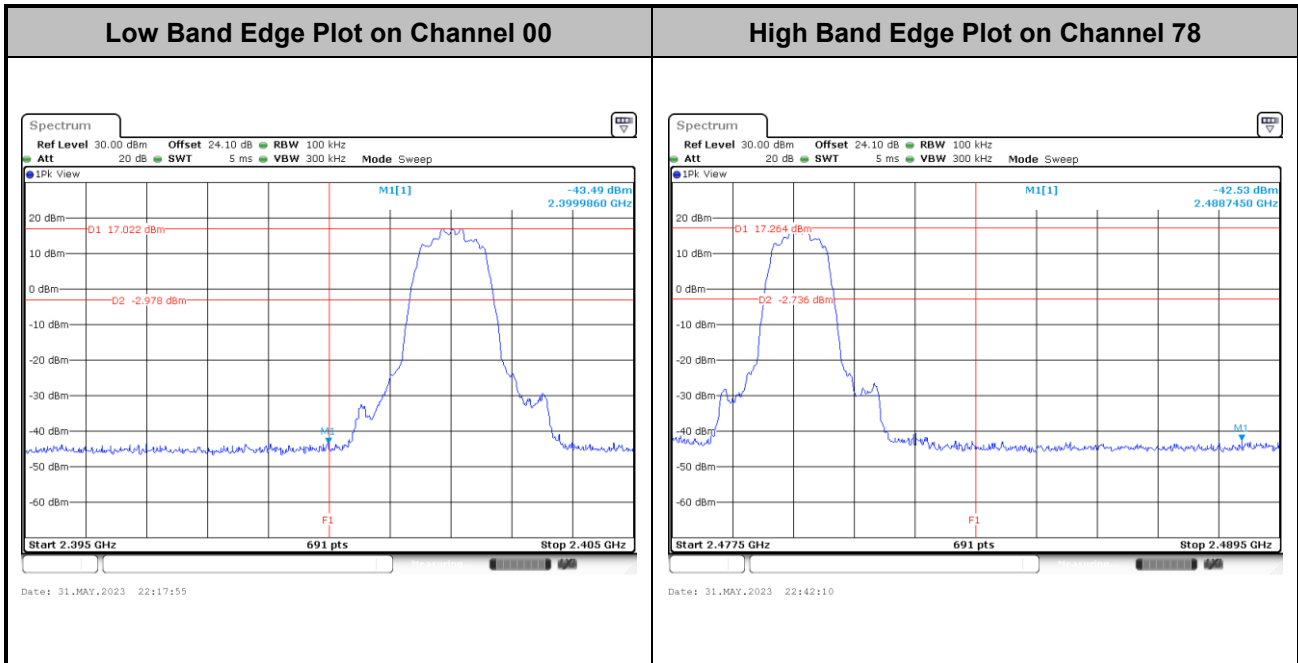



Hopping Mode Band Edges

<1Mbps>

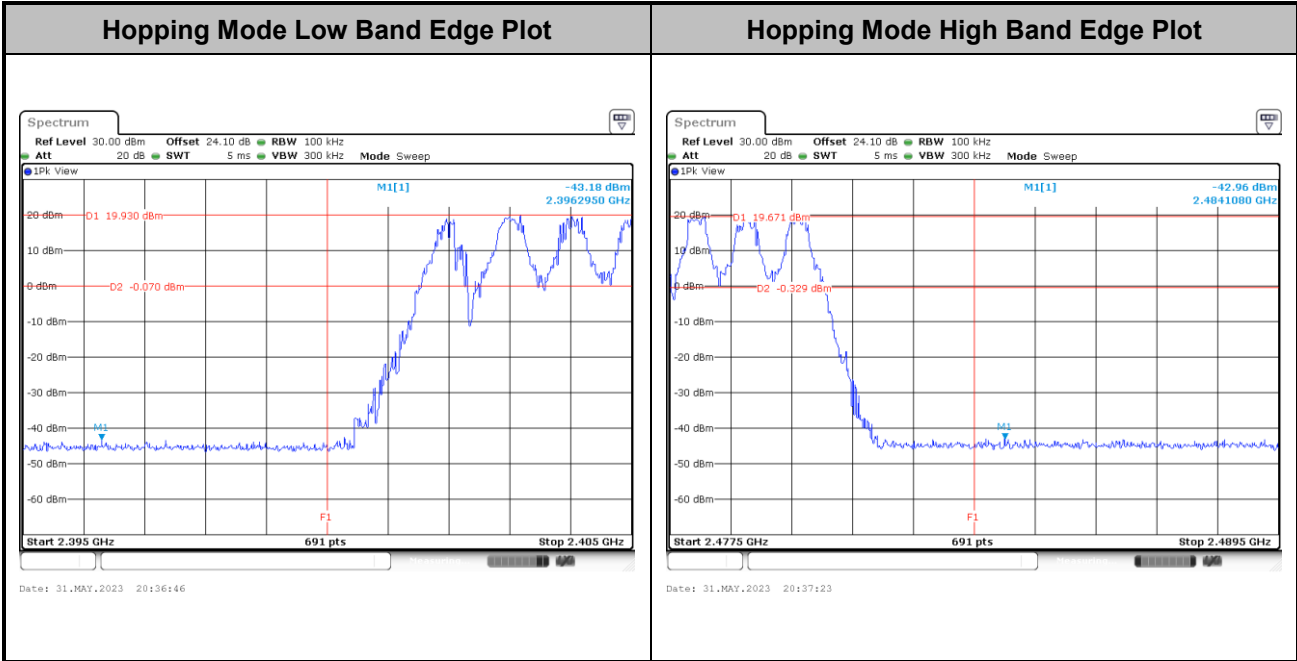

<2Mbps>

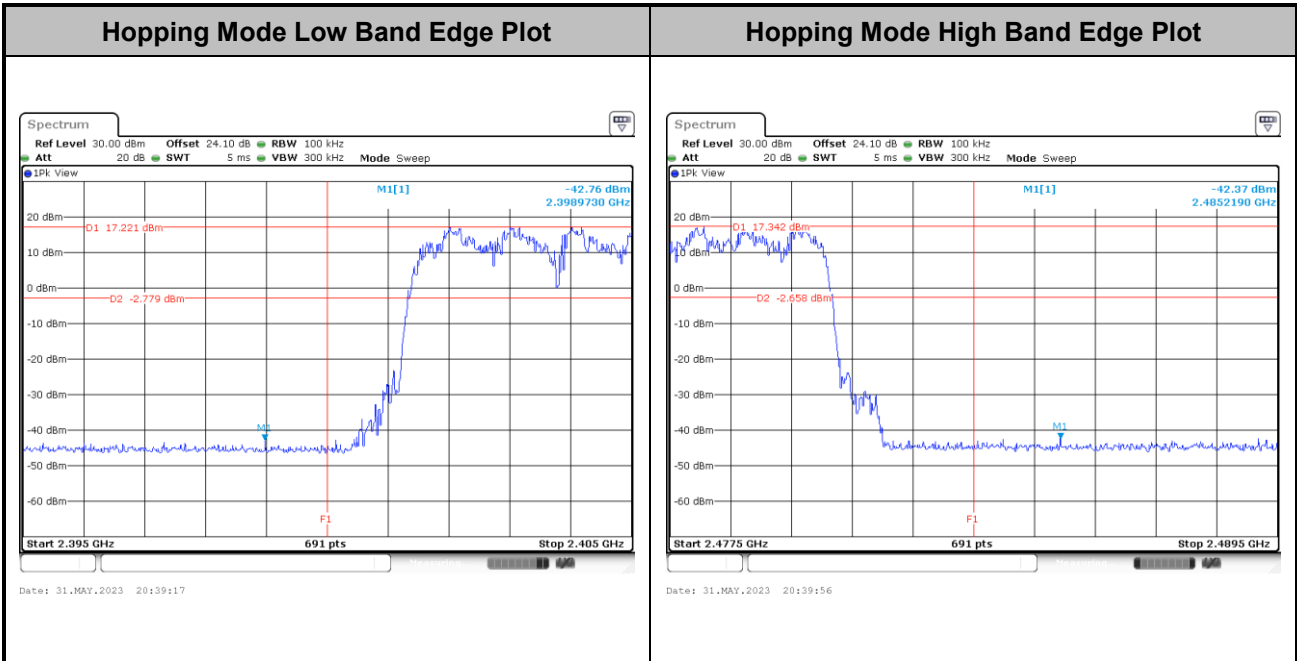



<3Mbps>

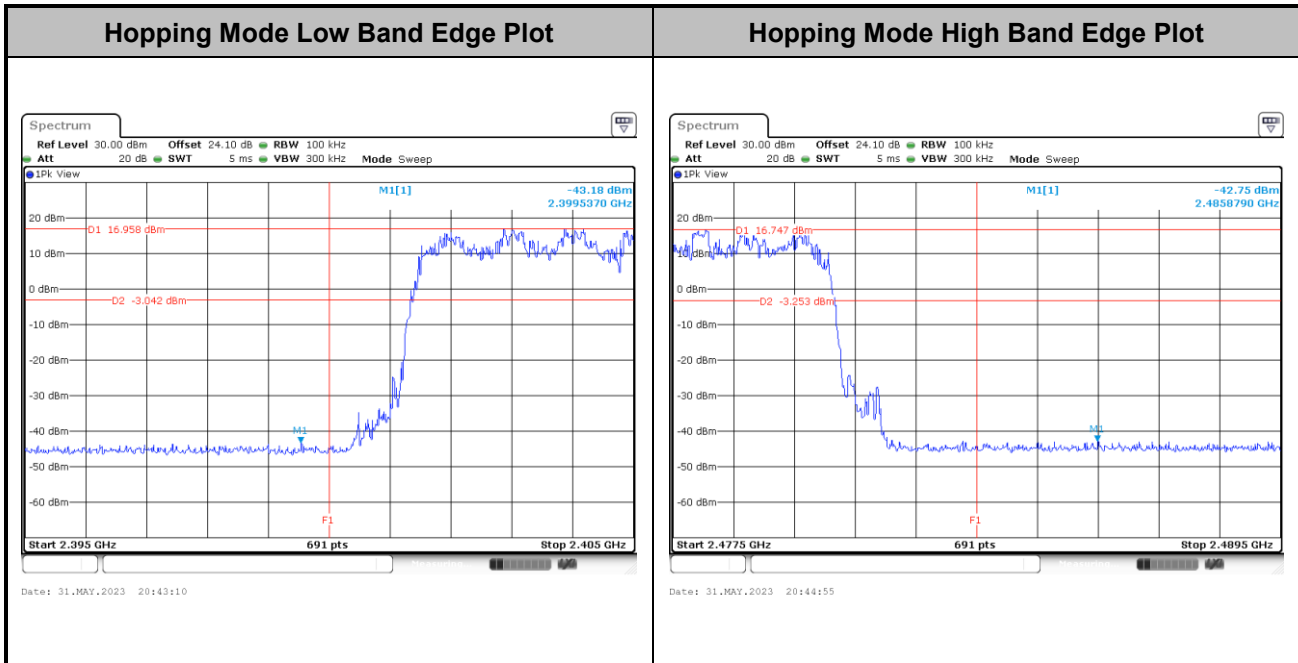



Conducted Spurious Emission

<1Mbps>

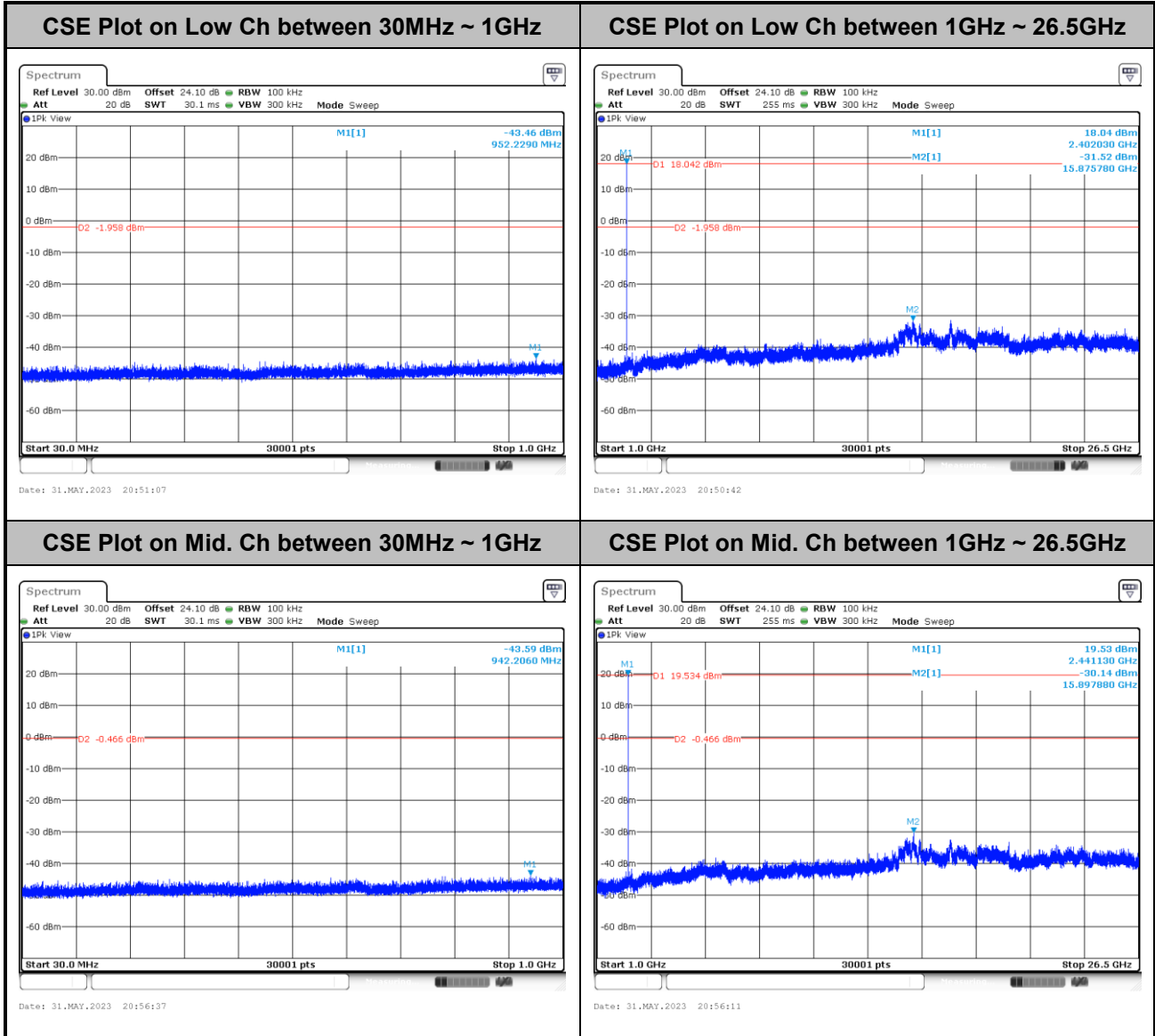

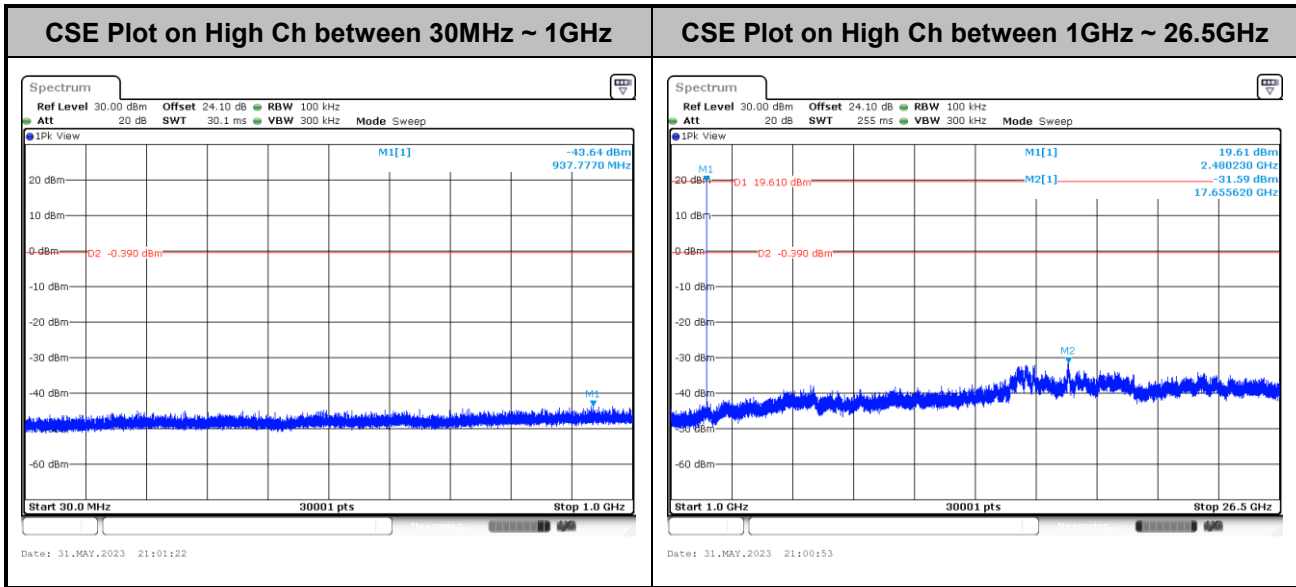



<2Mbps>

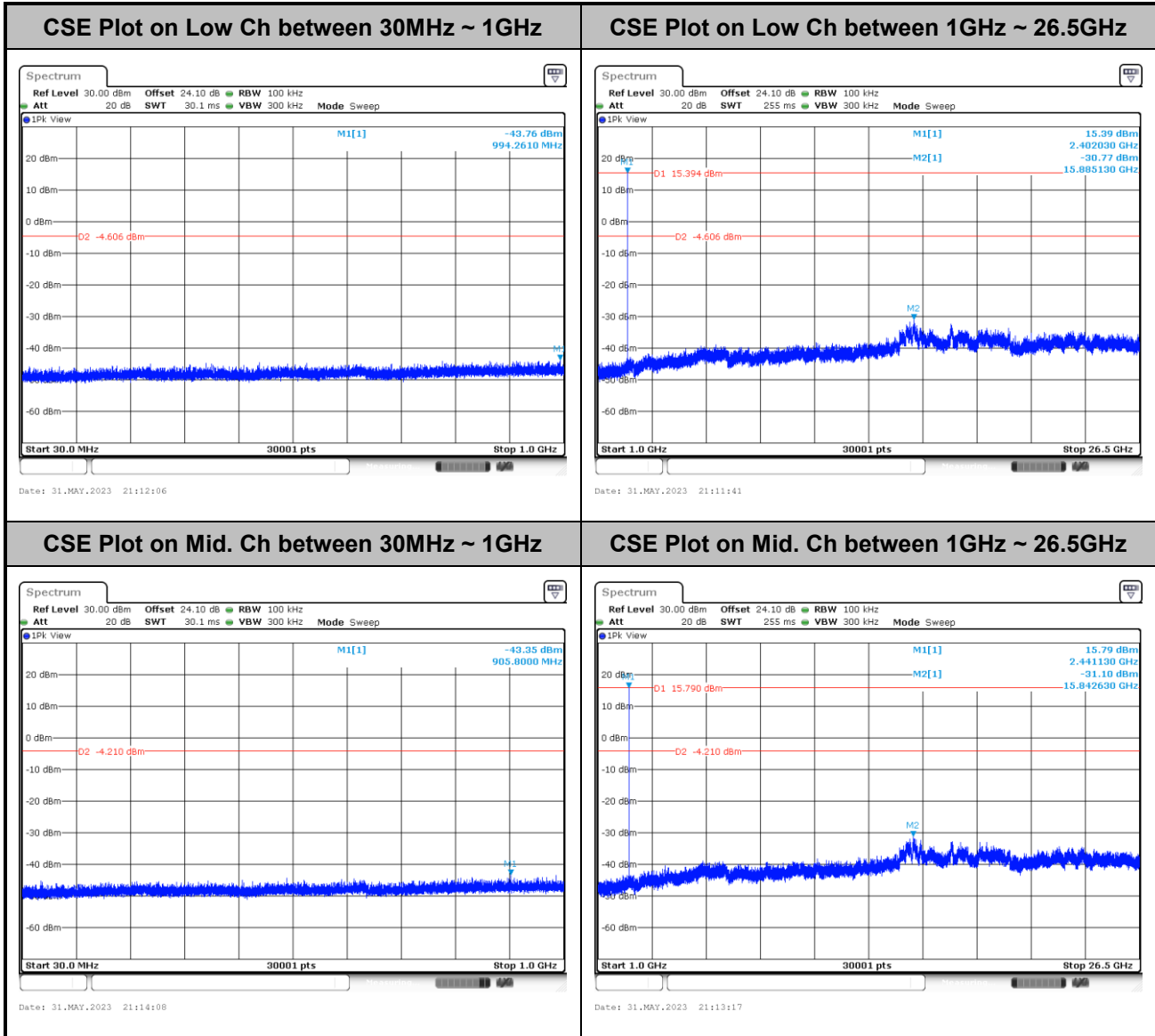

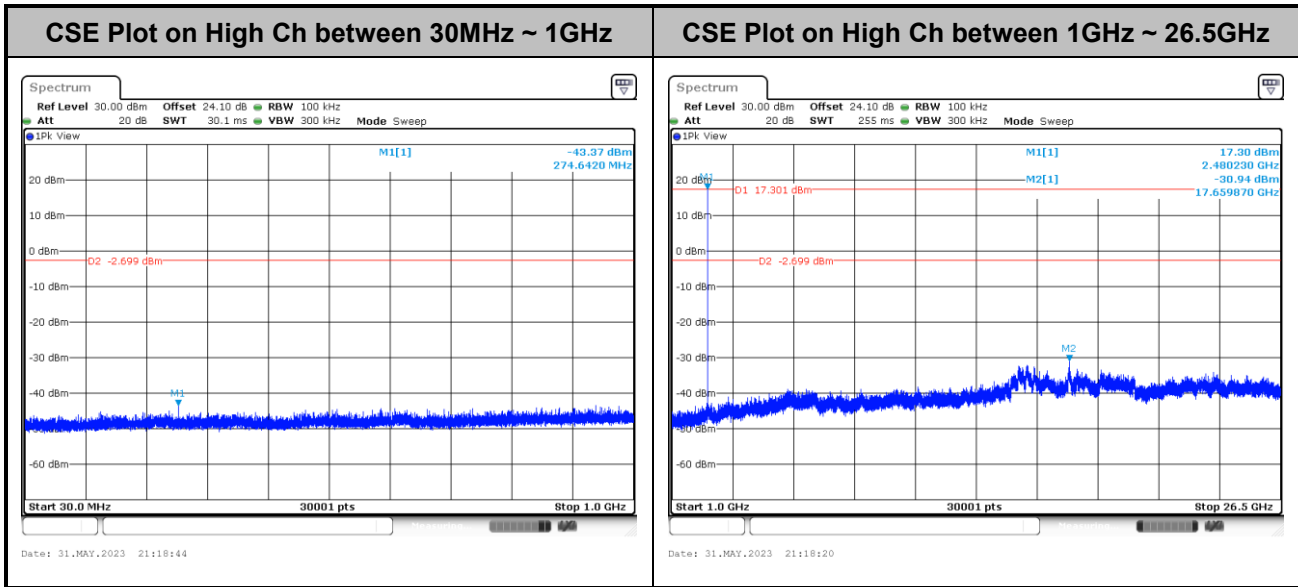



<3Mbps>

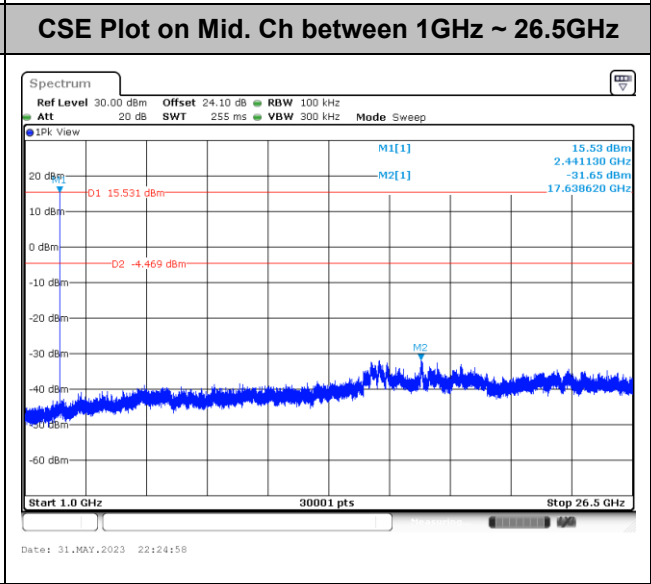
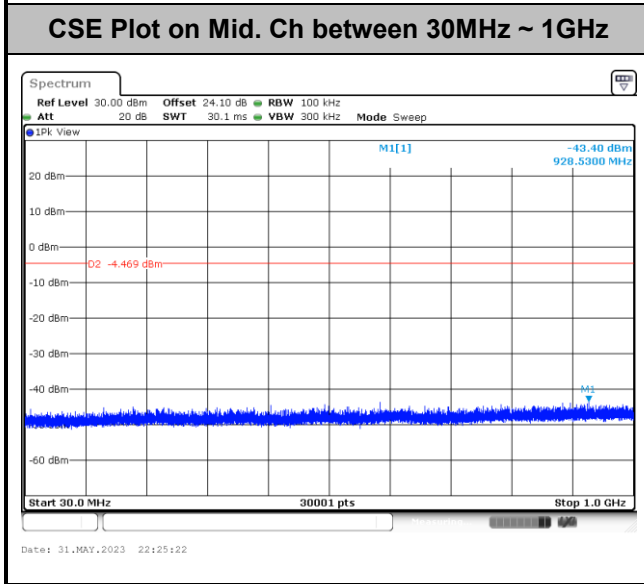
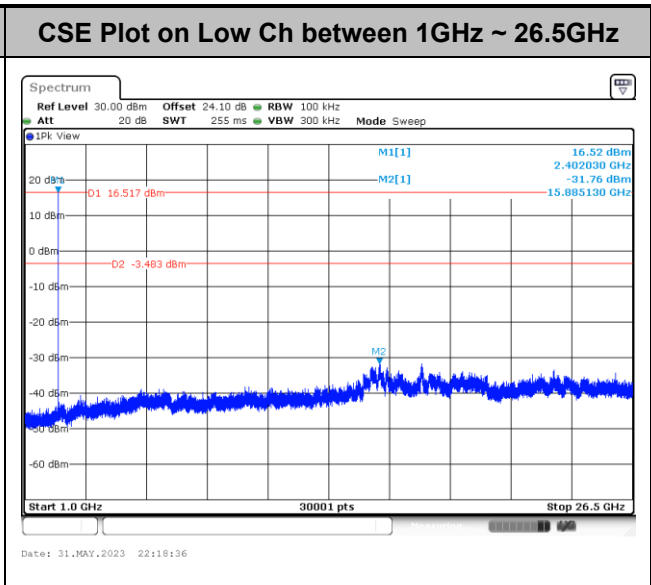
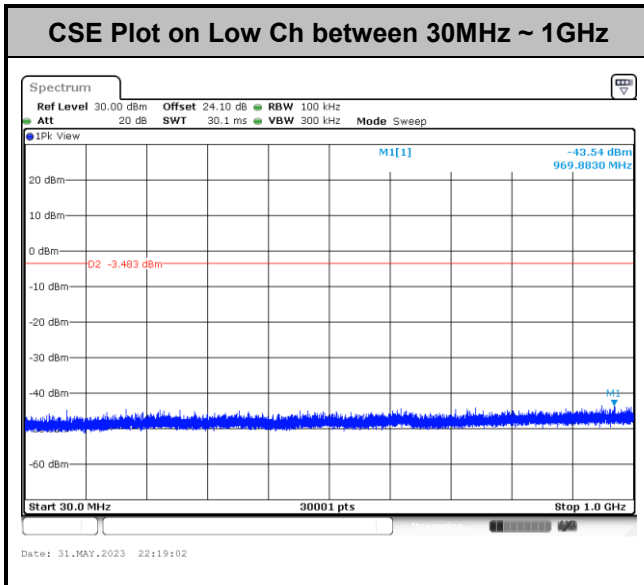

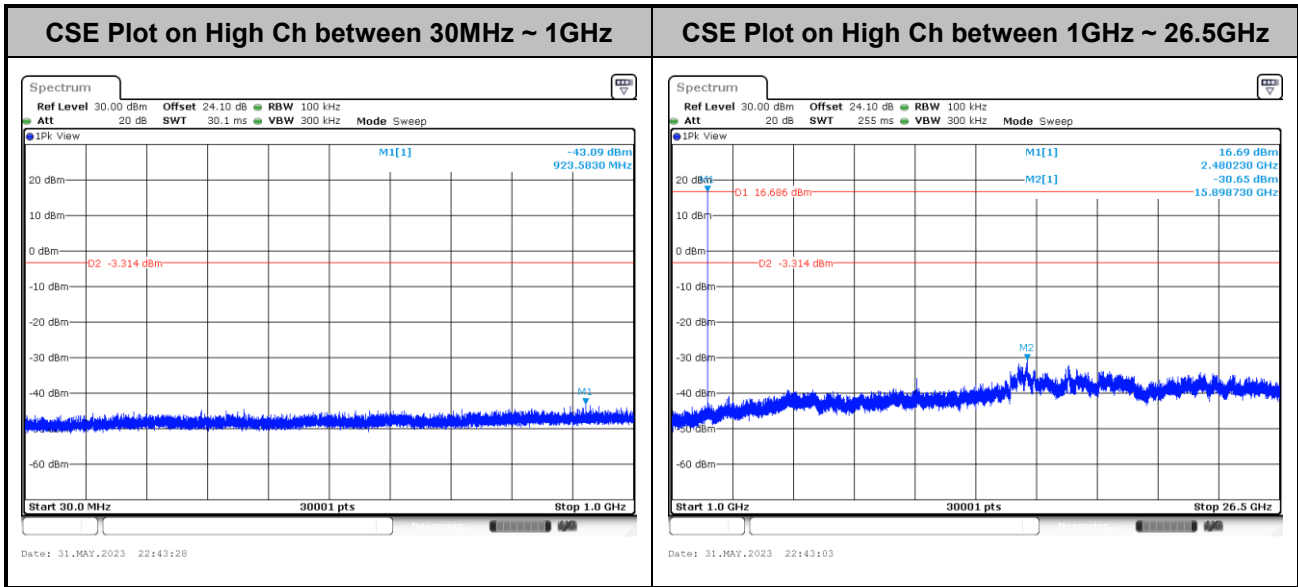



<HR 2Mbps Ant.3>

Number of Hopping Frequency

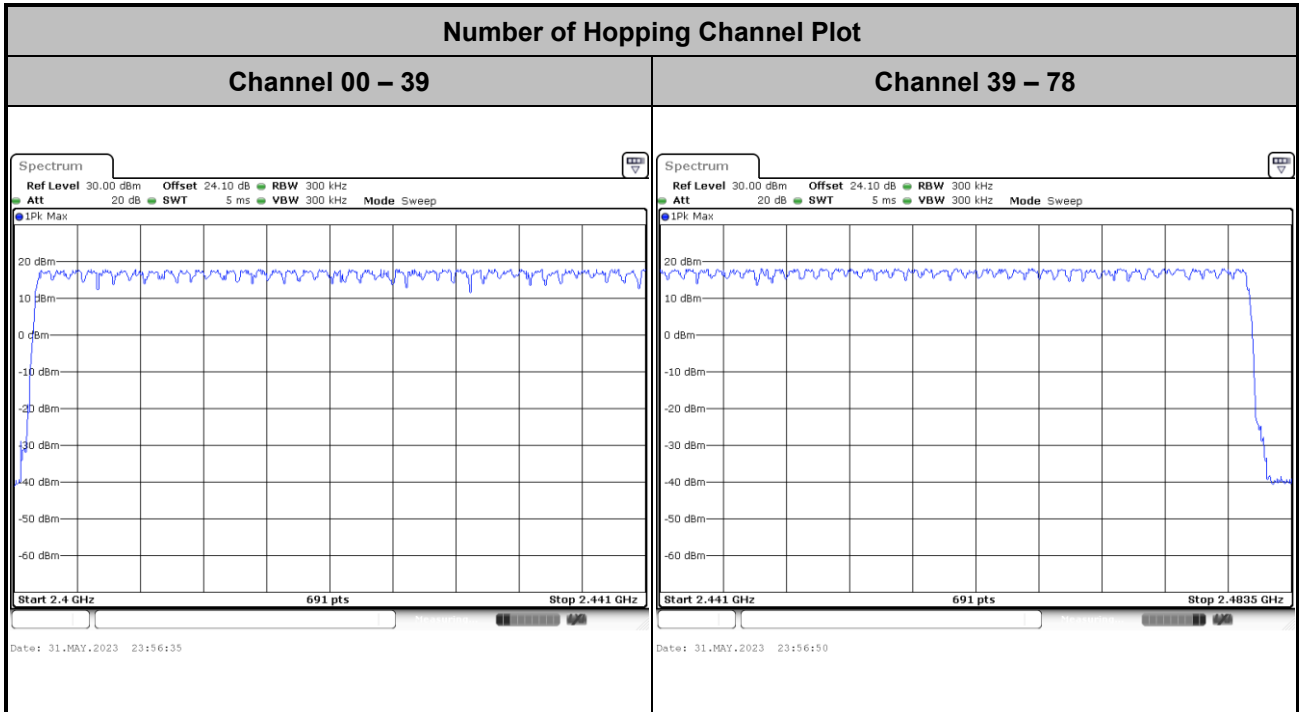



Hopping Channel Separation

<2Mbps>

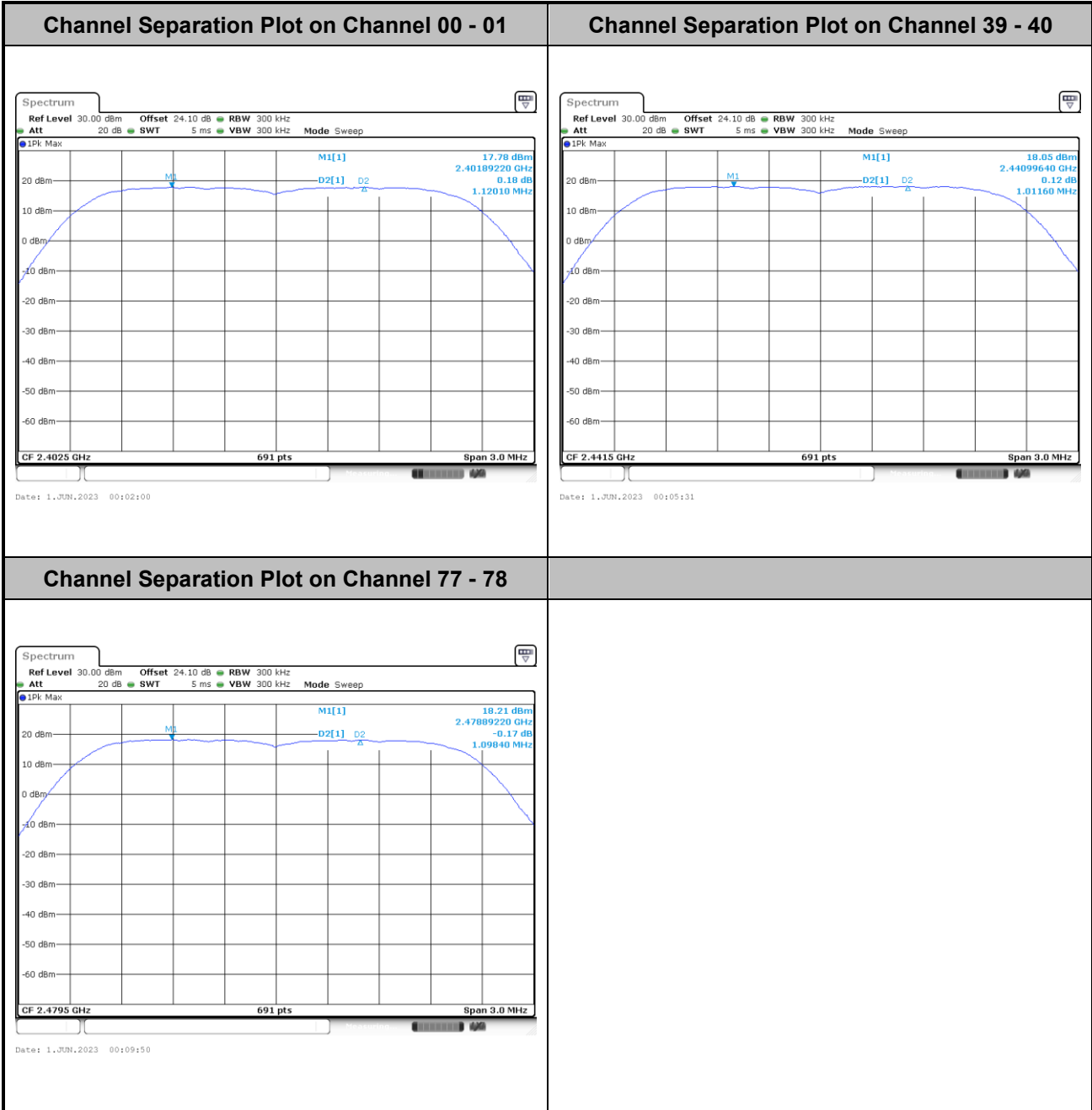



Dwell Time

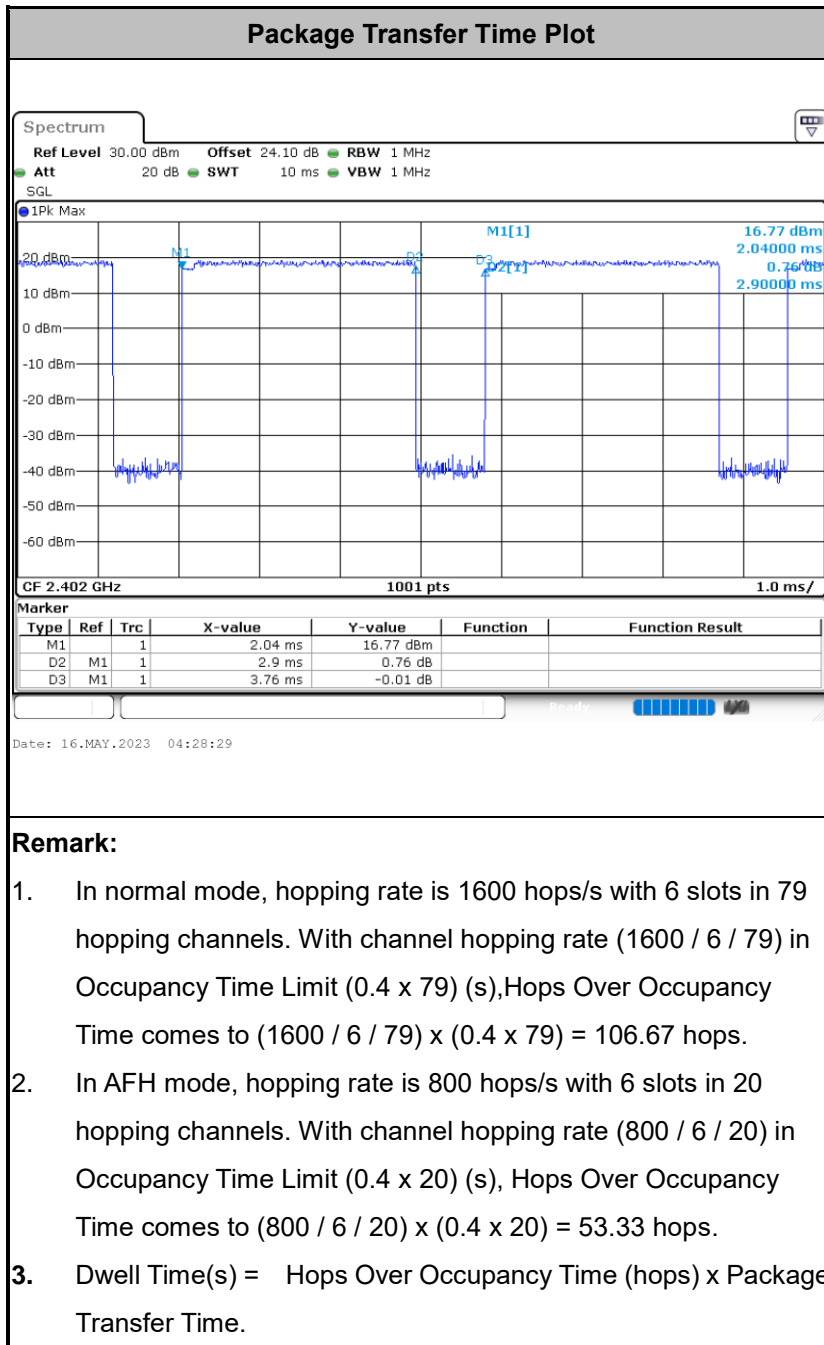



20dB Bandwidth

<2Mbps>

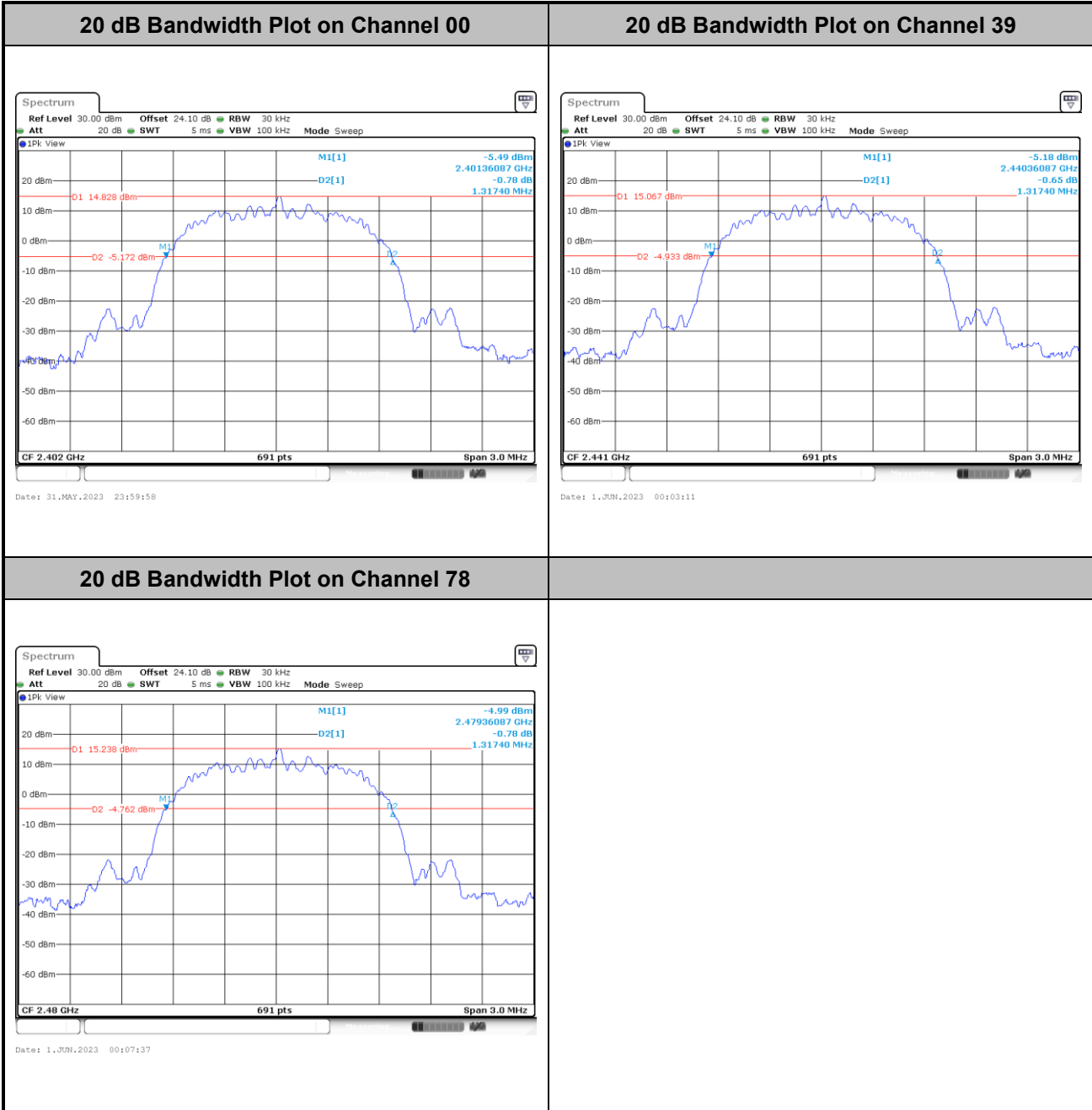



99% Occupied Bandwidth

<2Mbps>

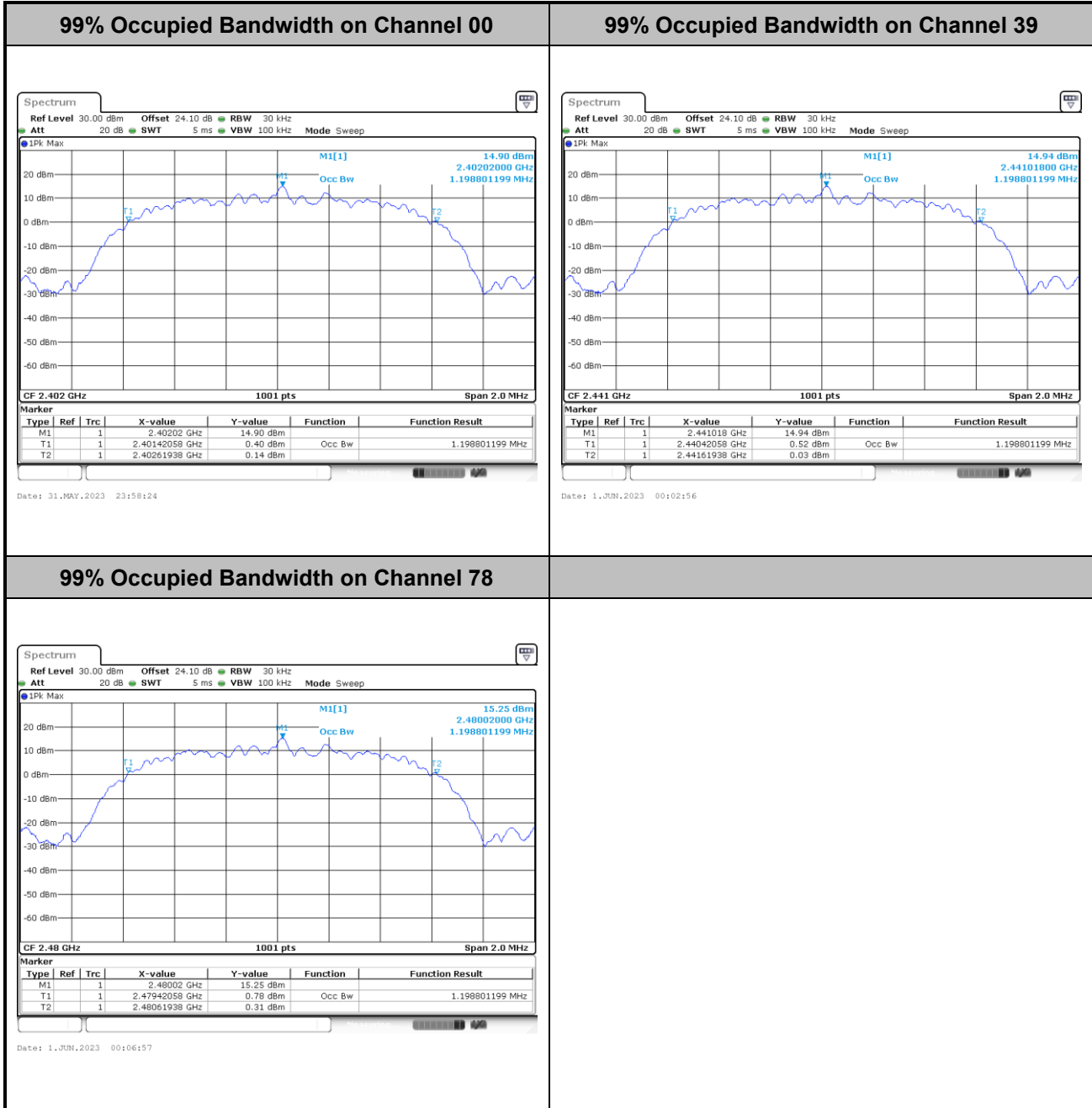

Note: The occupied channel bandwidth is maintained within the band of operation for all of the modulations.



Band Edges

<2Mbps>

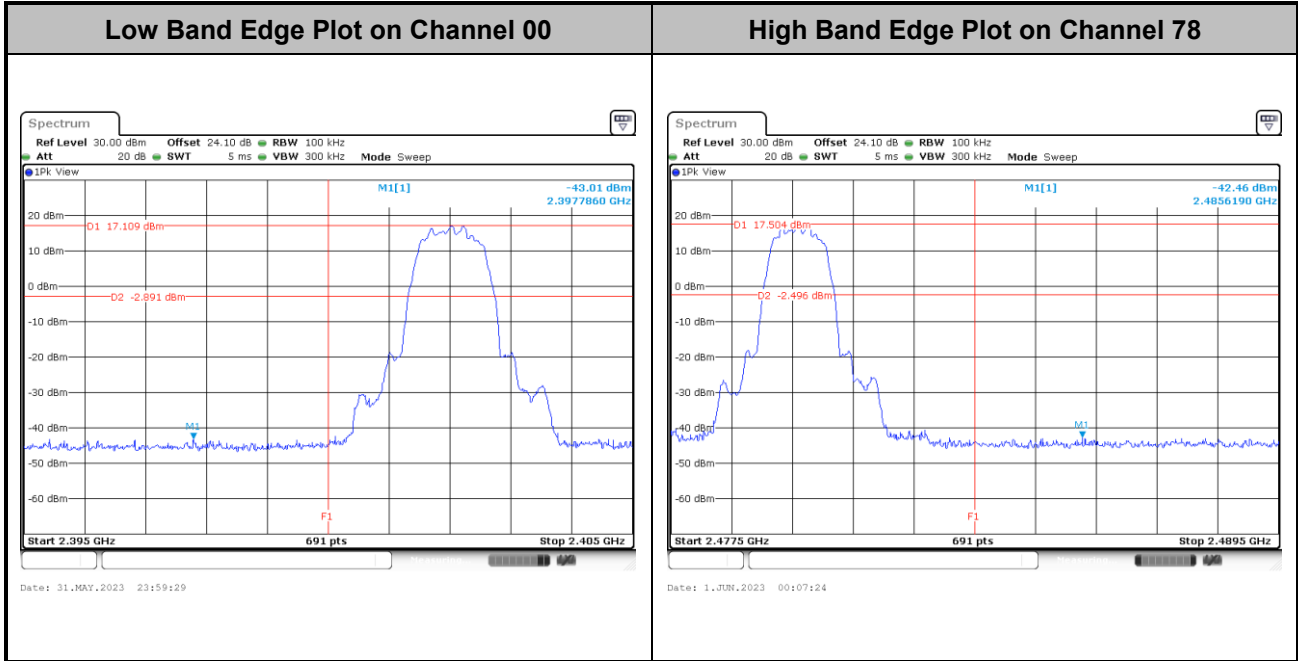



Hopping Mode Band Edges

<2Mbps>

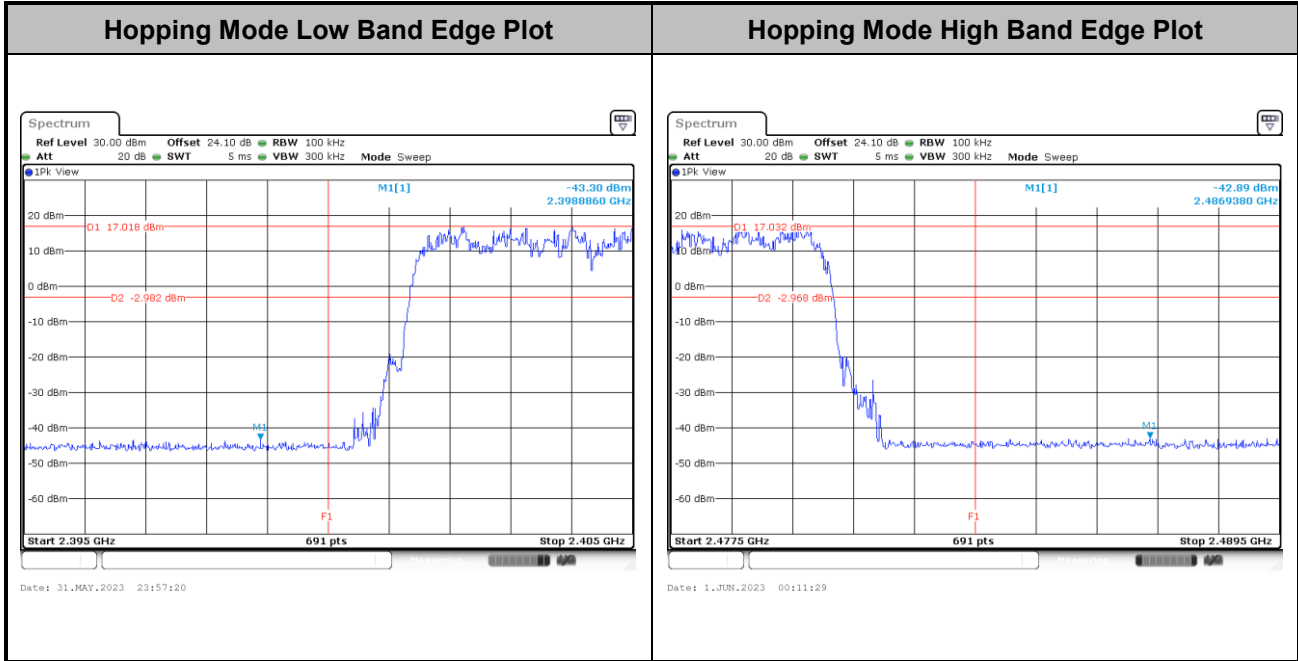



Conducted Spurious Emission

<2Mbps>

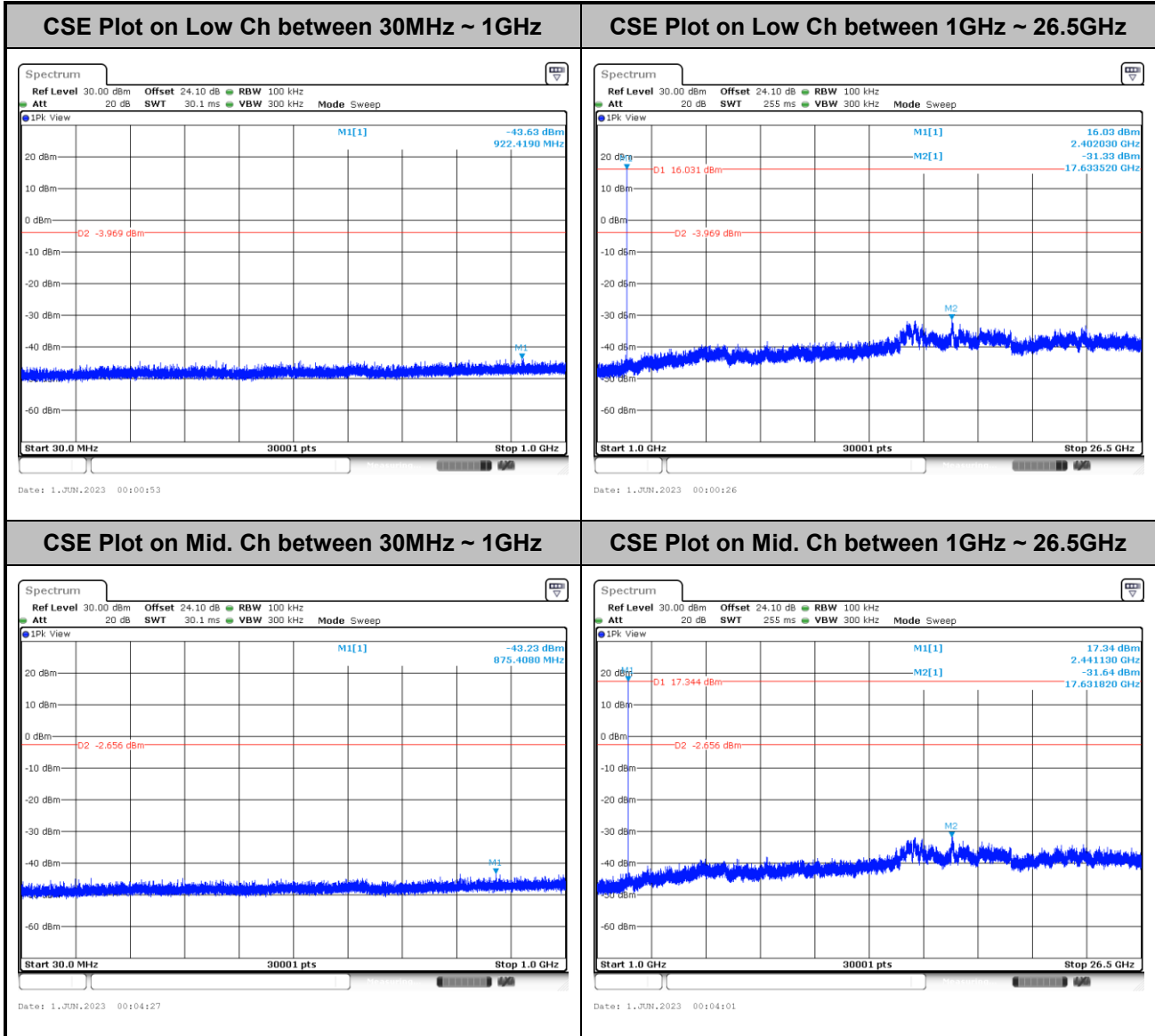

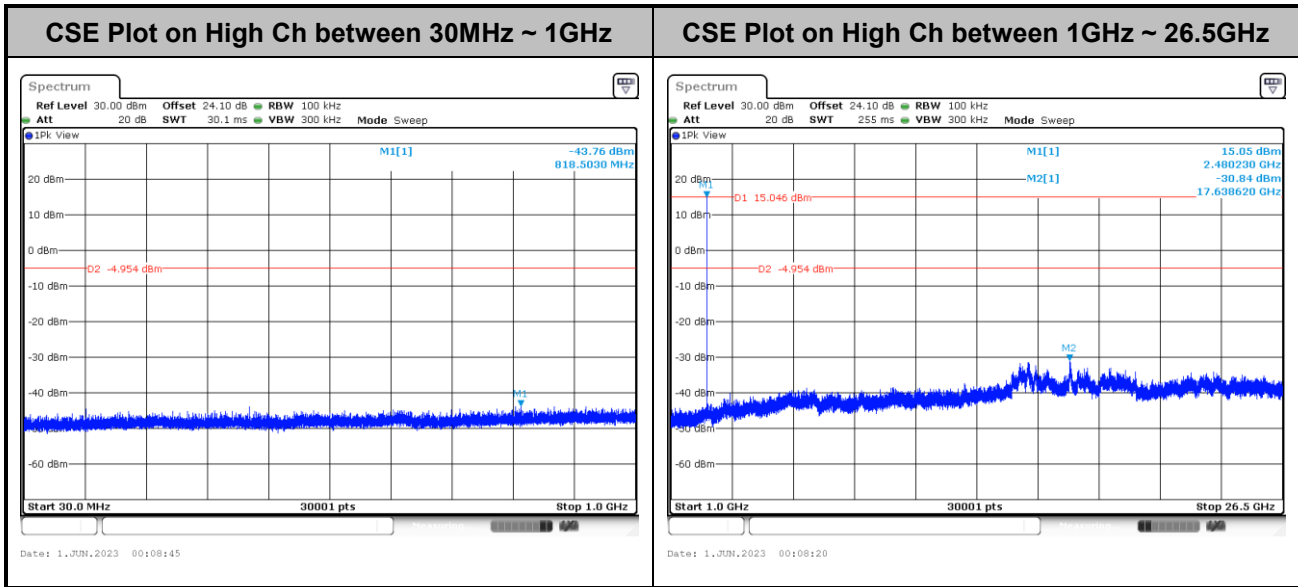



<BR+EDR Ant.4>

Number of Hopping Frequency

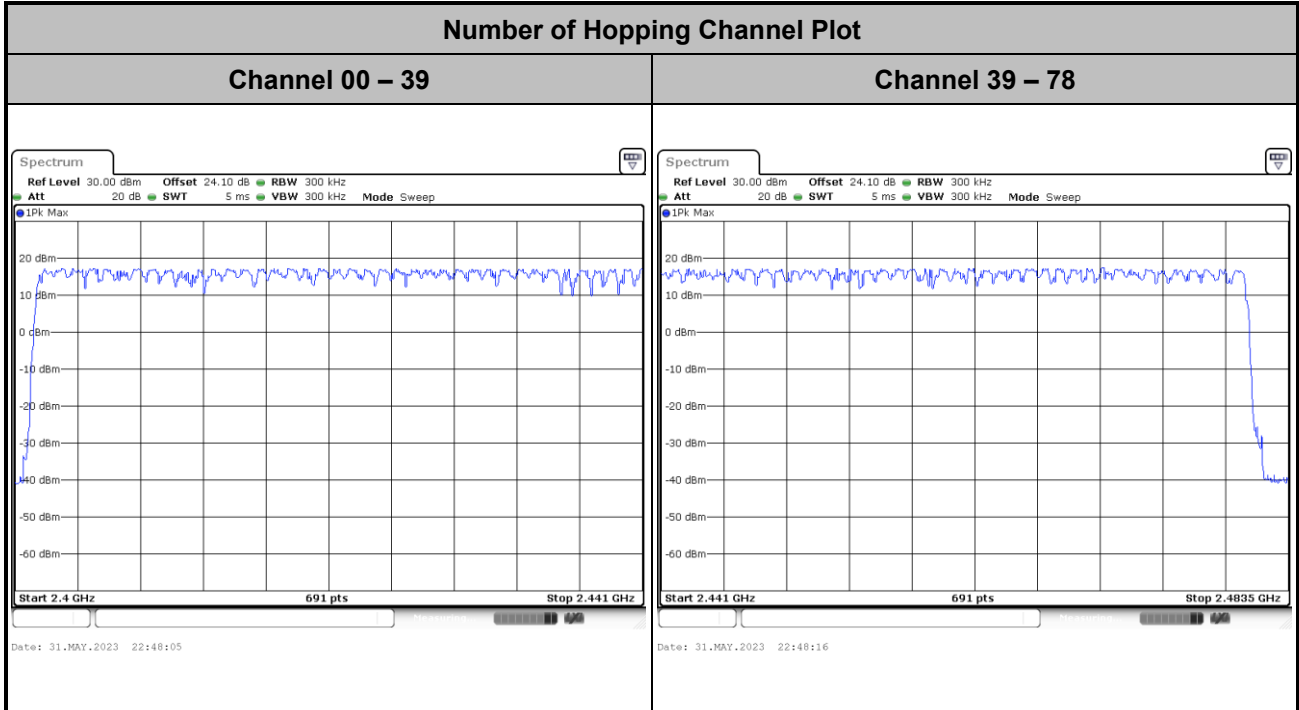



Hopping Channel Separation

<1Mbps>

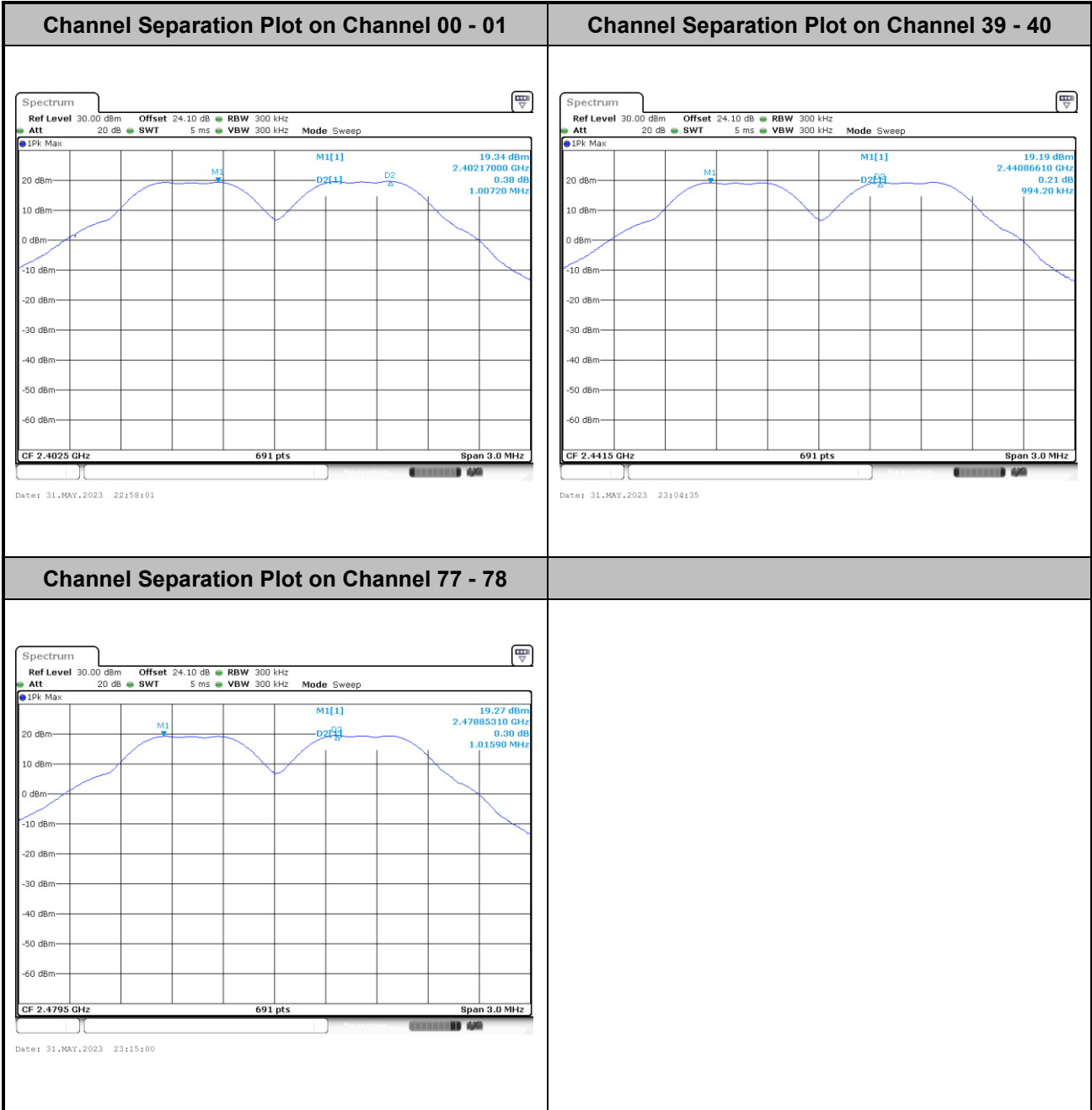



<2Mbps>

Channel Separation Plot on Channel 00 - 01

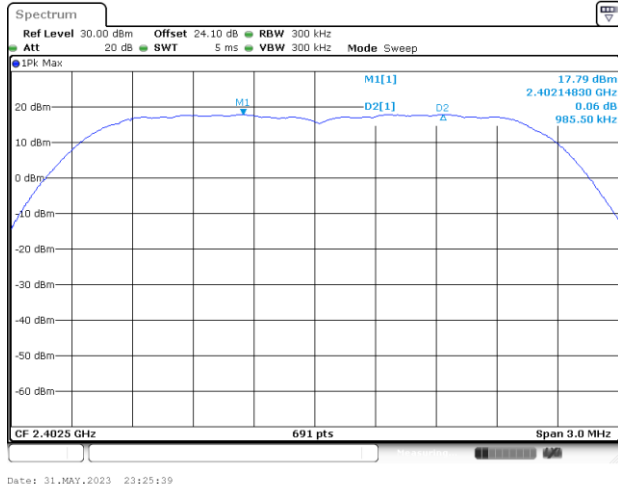

Channel Separation Plot on Channel 39 - 40

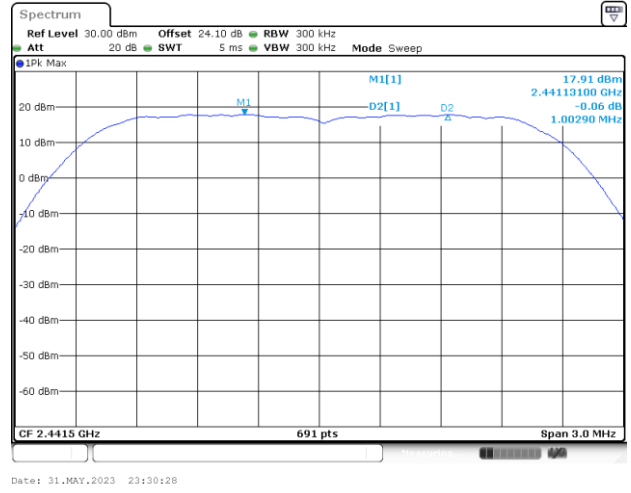

Channel Separation Plot on Channel 77 - 78

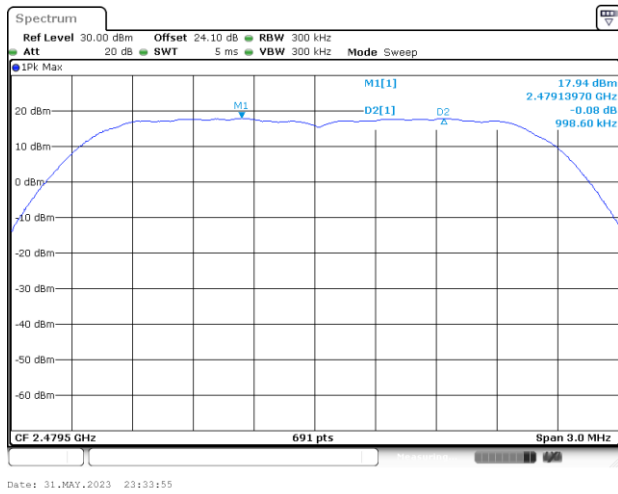



<3Mbps>

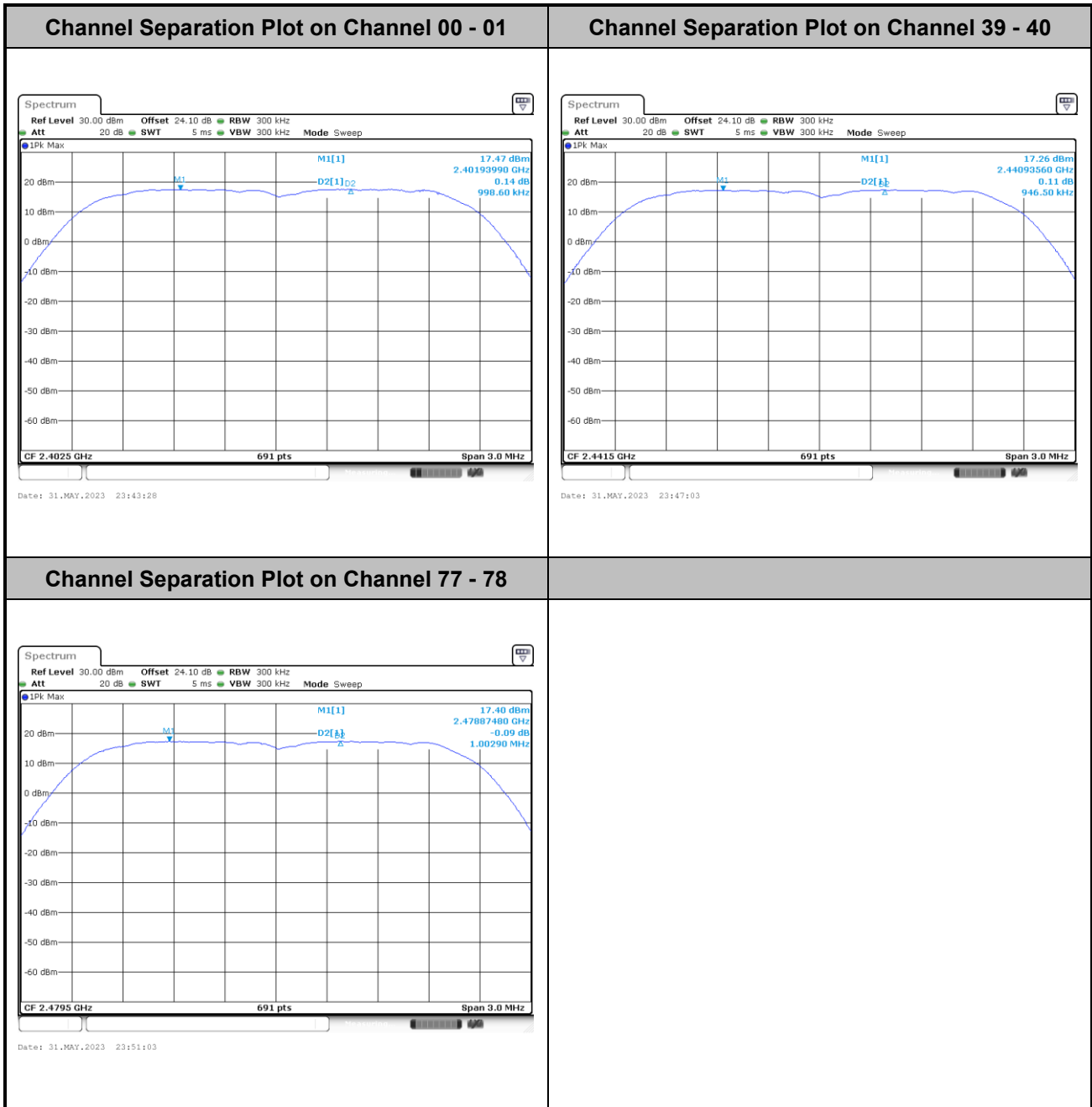



Dwell Time

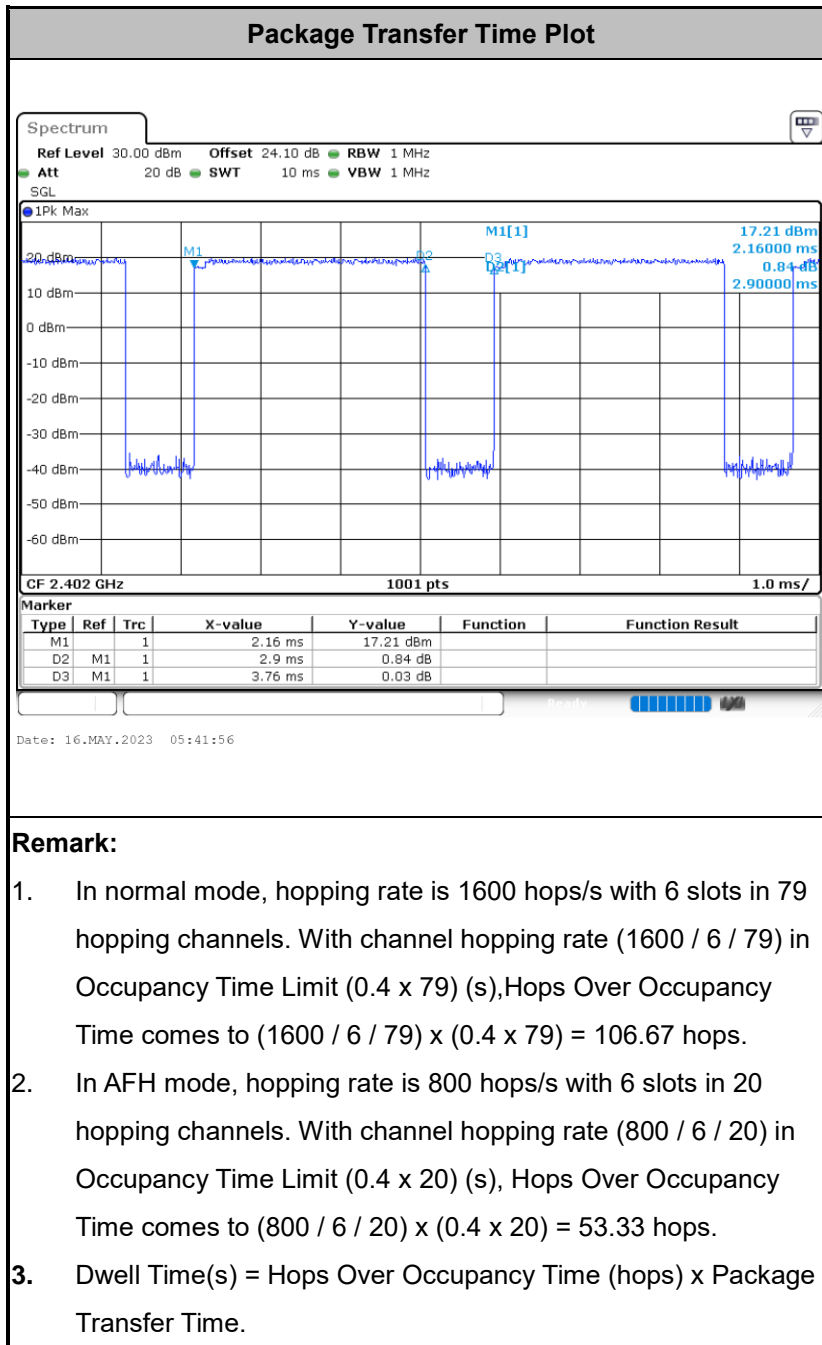



20dB Bandwidth

<1Mbps>

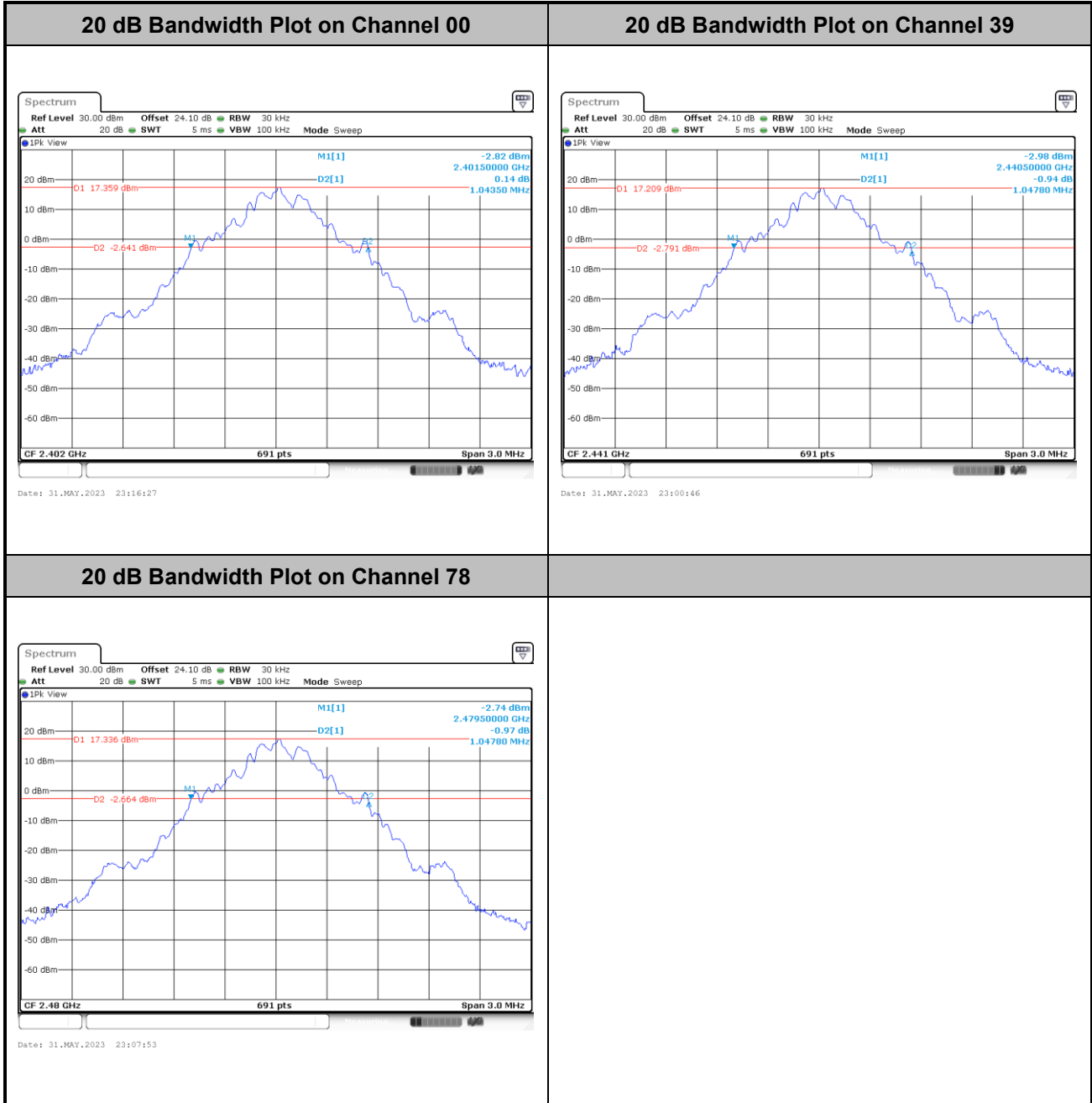



<2Mbps>

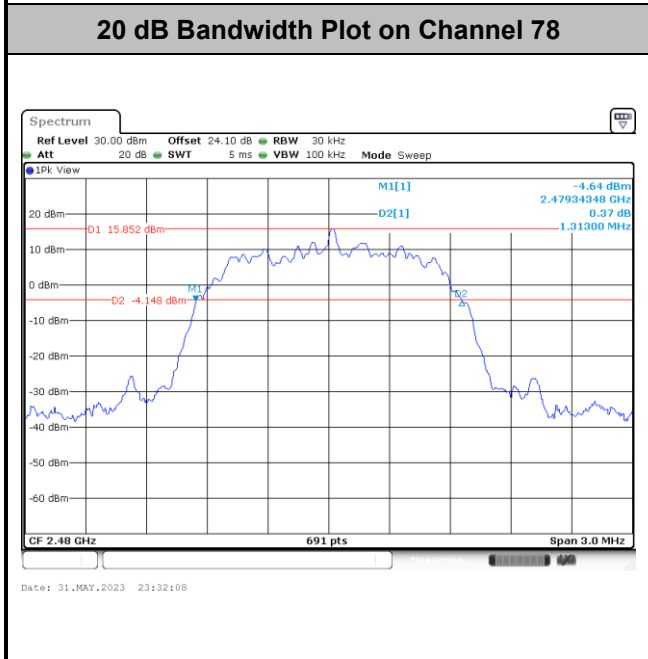
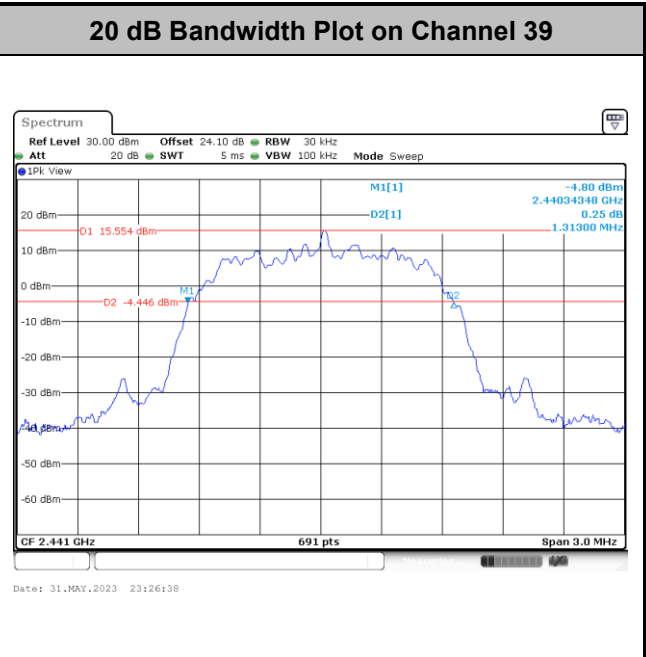
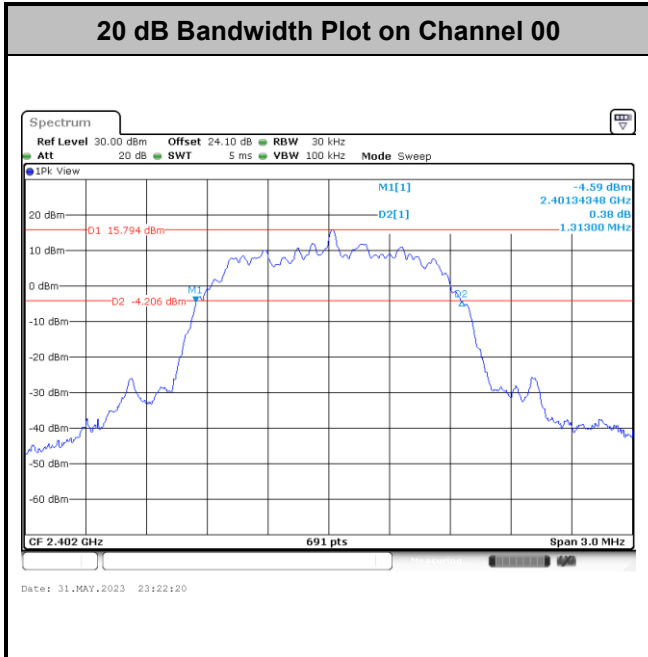



<3Mbps>

20 dB Bandwidth Plot on Channel 00

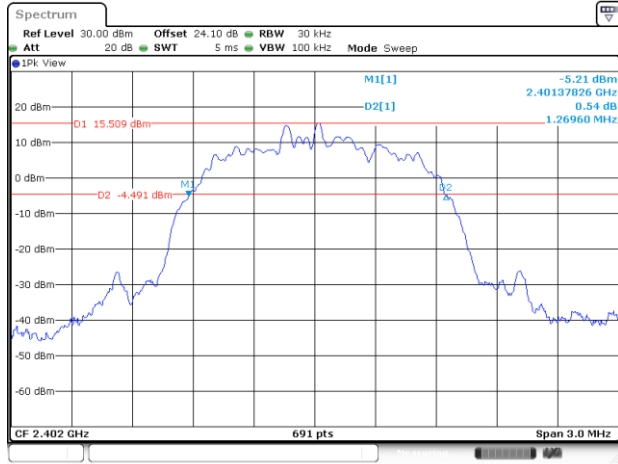

Date: 31.MAY.2023 23:37:29

20 dB Bandwidth Plot on Channel 39

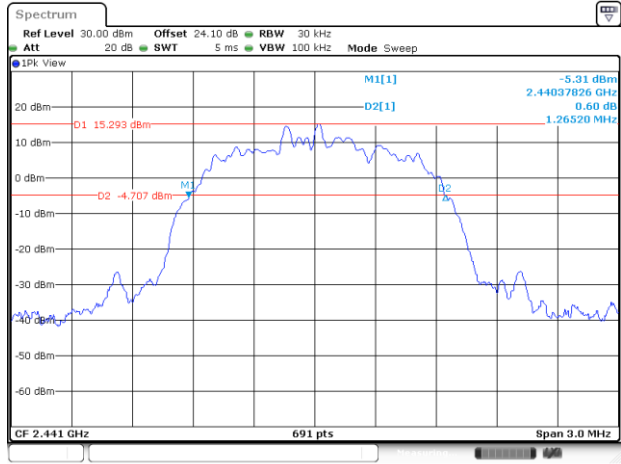

Date: 31.MAY.2023 23:45:19

20 dB Bandwidth Plot on Channel 78

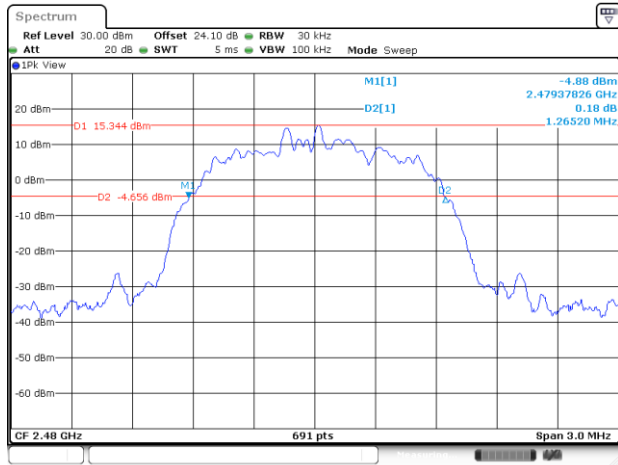

Date: 31.MAY.2023 23:49:08