



FCC RADIO TEST REPORT

FCC ID : A4RG020J
Equipment : Phone
Model name : G020J
Applicant : Google LLC
1600 Amphitheatre Parkway,
Mountain View, California, 94043 USA
Standard : FCC Part 15 Subpart E §15.407

The product was received on Nov. 07, 2018 and testing was started from Apr. 06, 2019 and completed on Jun. 26, 2019. We, SPORTON INTERNATIONAL INC., EMC & Wireless Communications Laboratory, would like to declare that the tested sample has been evaluated in accordance with the test procedures and has been in compliance with the applicable technical standards.

The report must not be used by the client to claim product certification, approval, or endorsement by TAF or any agency of government.

The test results in this report apply exclusively to the tested model / sample. Without written approval of SPORTON INTERNATIONAL INC. EMC & Wireless Communications Laboratory, the test report shall not be reproduced except in full.

Approved by: Jones Tsai

SPORTON INTERNATIONAL INC. EMC & Wireless Communications Laboratory
No. 52, Huaya 1st Rd., Guishan Dist., Taoyuan City, Taiwan (R.O.C.)



Table of Contents

History of this test report.....	3
Summary of Test Result.....	4
1 General Description	5
1.1 Product Feature of Equipment Under Test.....	5
1.2 Product Specification of Equipment Under Test.....	6
1.3 Modification of EUT	6
1.4 Testing Location	7
1.5 Applicable Standards.....	7
2 Test Configuration of Equipment Under Test	8
2.1 Carrier Frequency and Channel	8
2.2 Test Mode.....	9
2.3 Connection Diagram of Test System.....	10
2.4 Support Unit used in test configuration and system	12
2.5 EUT Operation Test Setup	12
2.6 Measurement Results Explanation Example.....	12
3 Test Result	13
3.1 6dB and 26dB and 99% Occupied Bandwidth Measurement	13
3.2 Maximum Conducted Output Power Measurement	16
3.3 Power Spectral Density Measurement	17
3.4 Unwanted Emissions Measurement.....	20
3.5 AC Conducted Emission Measurement.....	25
3.6 Automatically Discontinue Transmission	27
3.7 Antenna Requirements.....	29
4 List of Measuring Equipment.....	30
5 Uncertainty of Evaluation.....	32
Appendix A. Conducted Test Results	
Appendix B. AC Conducted Emission Test Result	
Appendix C. Radiated Spurious Emission	
Appendix D. Radiated Spurious Emission Plots	
Appendix E. Duty Cycle Plots	



History of this test report

Report No.	Version	Description	Issued Date
FR8N0620-05F	01	Initial issue of report	Jun. 28, 2019
FR8N0620-05F	02	Revise the antenna numbers in the report	Jul. 05, 2019



Summary of Test Result

Report Clause	Ref Std. Clause	Test Items	Result (PASS/FAIL)	Remark
3.1	15.403 (i)	6dB & 26dB Bandwidth	Pass	-
3.1	2.1049	99% Occupied Bandwidth	Reporting only	-
3.2	15.407 (a)	Maximum Conducted Output Power	Pass	-
3.3	15.407 (a)	Power Spectral Density	Pass	-
3.4	15.407(b)	Unwanted Emissions	Pass	Under limit 3.65 dB at 5639.000 MHz
3.5	15.207	AC Conducted Emission	Pass	Under limit 3.87 dB at 0.157 MHz
3.6	15.407 (c)	Automatically Discontinue Transmission	Pass	-
3.7	15.203 & 15.407 (a)	Antenna Requirement	Pass	-

Declaration of Conformity:

The test results with all measurement uncertainty excluded are presented in accordance with the regulation limits or requirements declared by manufacturers.

Comments and Explanations:

The declared of product specification for EUT presented in the report are provided by the manufacturer, and the manufacturer takes all the responsibilities for the accuracy of product specification.

Reviewed by: Wii Chang

Report Producer: Aileen Huang



1 General Description

1.1 Product Feature of Equipment Under Test

Product Feature	
Equipment	Phone
Model Name	G020J
FCC ID	A4RG020J
EUT supports Radios application	CDMA/EV-DO/GSM/EGPRS/WCDMA/HSPA/LTE/NFC/GNSS/WPC WLAN 11b/g/n HT20 WLAN 11a/n HT20/HT40 WLAN 11ac VHT20/VHT40/VHT80 Bluetooth BR/EDR/LE 60 GHz Low Power Transmitter
EUT Stage	Identical Prototype

Remark: The above EUT's information was declared by manufacturer.

EUT Information List	
No.	S/N
#1	94NBA009QB
#2	957BA00AEY
#3	957BA00AGL

1.2 Product Specification of Equipment Under Test

Standards-related Product Specification										
Tx/Rx Channel Frequency Range	5745 MHz ~ 5825 MHz									
Maximum Output Power	<p><Ant. 4> 802.11a : 20.50 dBm / 0.1122 W 802.11n HT20 : 20.50 dBm / 0.1122 W 802.11n HT40 : 20.40 dBm / 0.1096 W 802.11ac VHT20: 20.50 dBm / 0.1122 W 802.11ac VHT40: 20.30 dBm / 0.1072 W 802.11ac VHT80: 20.80 dBm / 0.1202 W</p> <p><Ant. 5> 802.11a : 20.60 dBm / 0.1148 W 802.11n HT20 : 20.50 dBm / 0.1122 W 802.11n HT40 : 20.70 dBm / 0.1175 W 802.11ac VHT20: 20.40 dBm / 0.1096 W 802.11ac VHT40: 20.60 dBm / 0.1148 W 802.11ac VHT80: 20.80 dBm / 0.1202 W</p> <p>MIMO <Ant. 4 + 5> 802.11a : 23.81 dBm / 0.2404 W 802.11n HT20 : 23.76 dBm / 0.2377 W 802.11n HT40 : 23.76 dBm / 0.2377 W 802.11ac VHT20: 23.66 dBm / 0.2323 W 802.11ac VHT40: 23.66 dBm / 0.2323 W 802.11ac VHT80: 23.67 dBm / 0.2328 W</p>									
99% Occupied Bandwidth	<p>MIMO<Ant. 4> 802.11a : 23.30 MHz 802.11n HT20 : 28.50 MHz 802.11n HT40 : 55.40 MHz 802.11ac VHT80 : 78.36 MHz</p> <p>MIMO<Ant. 5> 802.11a : 28.35 MHz 802.11n HT20 : 30.25 MHz 802.11n HT40 : 58.40 MHz 802.11ac VHT80 : 87.84 MHz</p>									
Type of Modulation	802.11a/n : OFDM (BPSK / QPSK / 16QAM / 64QAM) 802.11ac : OFDM (BPSK / QPSK / 16QAM / 64QAM / 256QAM)									
Antenna Type / Gain	<Ant. 4> : IFA Antenna with gain -5.6 dBi <Ant. 5> : ILA Antenna with gain -1.1 dBi									
Antenna Function Description	<table border="1"> <thead> <tr> <th></th> <th>Ant. 4</th> <th>Ant. 5</th> </tr> </thead> <tbody> <tr> <td>802.11 a/n/ac</td> <td>V</td> <td>V</td> </tr> <tr> <td>802.11 n/ac MIMO</td> <td>V</td> <td>V</td> </tr> </tbody> </table>		Ant. 4	Ant. 5	802.11 a/n/ac	V	V	802.11 n/ac MIMO	V	V
	Ant. 4	Ant. 5								
802.11 a/n/ac	V	V								
802.11 n/ac MIMO	V	V								

Remark: MIMO Ant. 4+5 is a calculated result from sum of the power MIMO Ant. 4 and MIMO Ant. 5.

1.3 Modification of EUT

No modifications are made to the EUT during all test items.



1.4 Testing Location

Test Site	SPORTON INTERNATIONAL INC., EMC & Wireless Communications Laboratory.	
Test Site Location	No.52, Huaya 1st Rd., Guishan Dist., Taoyuan City, Taiwan (R.O.C.) TEL: +886-3-327-3456 FAX: +886-3-328-4978	
Test Site No.	Sporton Site No.	
	TH05-HY	CO05-HY

Note: The test site complies with ANSI C63.4 2014 requirement.

Test Site	SPORTON INTERNATIONAL INC., EMC & Wireless Communications Laboratory.	
Test Site Location	No.58, Aly. 75, Ln. 564, Wenhua 3rd, Rd., Guishan Dist., Taoyuan City, Taiwan (R.O.C.) TEL: +886-3-327-0868 FAX: +886-3-327-0855	
Test Site No.	Sporton Site No.	
	03CH13-HY	

Note: The test site complies with ANSI C63.4 2014 requirement.

FCC designation No.: TW1190 and TW0007

1.5 Applicable Standards

According to the specifications of the manufacturer, the EUT must comply with the requirements of the following standards:

- ♦ FCC Part 15 Subpart E
- ♦ FCC KDB 789033 D02 General UNII Test Procedures New Rules v02r01.
- ♦ FCC KDB 414788 D01 Radiated Test Site v01r01.
- ♦ FCC KDB 662911 D01 Multiple Transmitter Output v02r01.
- ♦ ANSI C63.10-2013

Remark:

1. All test items were verified and recorded according to the standards and without any deviation during the test.
2. This EUT has also been tested and complied with the requirements of FCC Part 15, Subpart B, recorded in a separate test report.



2 Test Configuration of Equipment Under Test

- a. The EUT has been associated with peripherals and configuration operated in a manner tended to maximize its emission characteristics in a typical application. Frequency range investigated: conduction emission (150 kHz to 30 MHz), radiation emission (9 kHz to the 10th harmonic of the highest fundamental frequency or to 40 GHz, whichever is lower). For radiated measurement, pre-scanned in three orthogonal panels, X, Y, Z. The worst cases (Y plane with adapter; Z plane with WPC) were recorded in this report.

- b. AC power line Conducted Emission was tested under maximum output power.

2.1 Carrier Frequency and Channel

Frequency Band	Channel	Freq. (MHz)	Channel	Freq. (MHz)
5725-5850 MHz Band 4 (U-NII-3)	149	5745	157	5785
	151*	5755	159*	5795
	153	5765	161	5805
	155#	5775	165	5825

Note:

- 1. The above Frequency and Channel in "*" were 802.11n HT40 and 802.11ac VHT40.
- 2. The above Frequency and Channel in "#n" were 802.11ac VHT80.



2.2 Test Mode

Final test modes are considering the modulation and worse data rates as below table.

MIMO Mode

Modulation	Data Rate
802.11a	6 Mbps
802.11n HT20	MCS0
802.11n HT40	MCS0
802.11ac VHT20 (Covered by HT20)	MCS0
802.11ac VHT40 (Covered by HT40)	MCS0
802.11ac VHT80	MCS0

Test Cases	
AC Conducted Emission	Mode 1 : WLAN (5GHz) Link + Bluetooth Link + USB Cable (Type C) (Charging from AC Adapter 1) Mode 2 : WLAN (5GHz) Link + Bluetooth Link + Earphone (Type C) + Wireless Charging
Remark:	
1. The worst case of conducted emission is mode 2; only the test data of it was reported. 2. For Radiated Test Cases, the tests were performed with Adapter 1.	

Ch. #	Band IV : 5725-5850 MHz			
	802.11a	802.11n HT20	802.11n HT40	802.11ac VHT80
L Low	149	149	151	-
M Middle	157	157	-	155
H High	165	165	159	-

2.3 Connection Diagram of Test System

<WLAN Tx Mode>

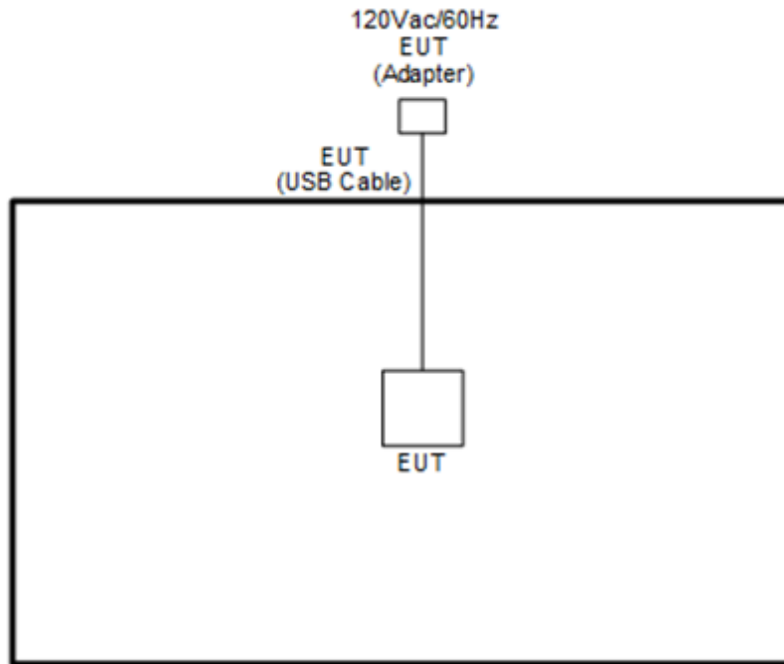

<WLAN Tx with WPC Charging Mode>

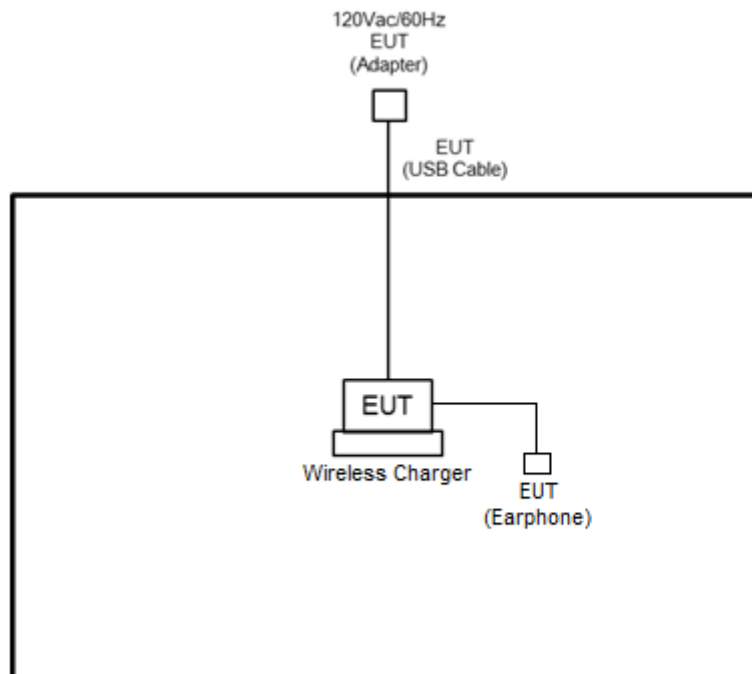

<AC Conducted Emissions Mode>

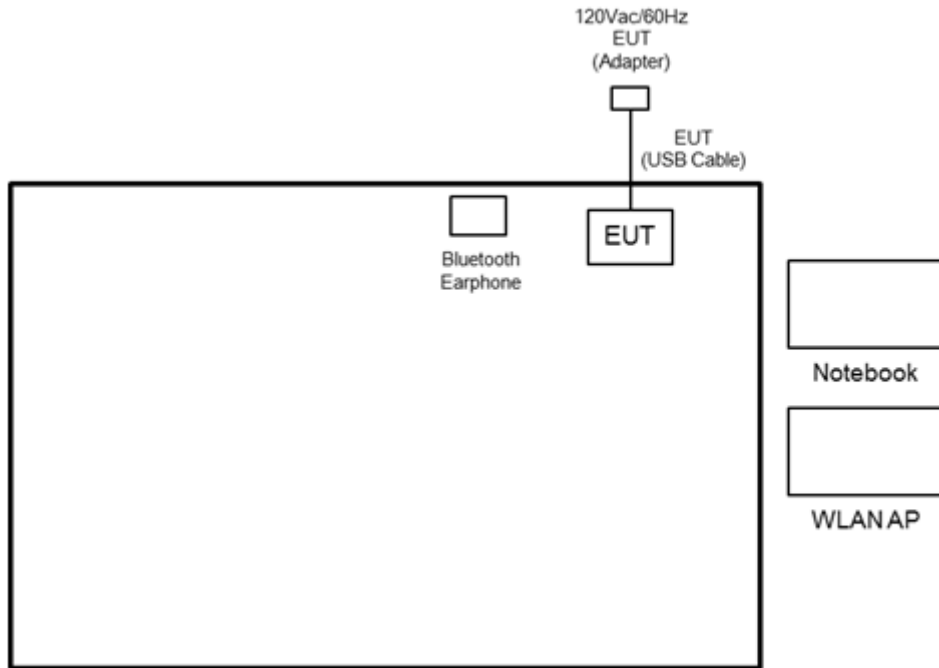

<AC Conducted Emissions with WPC Charging Mode>

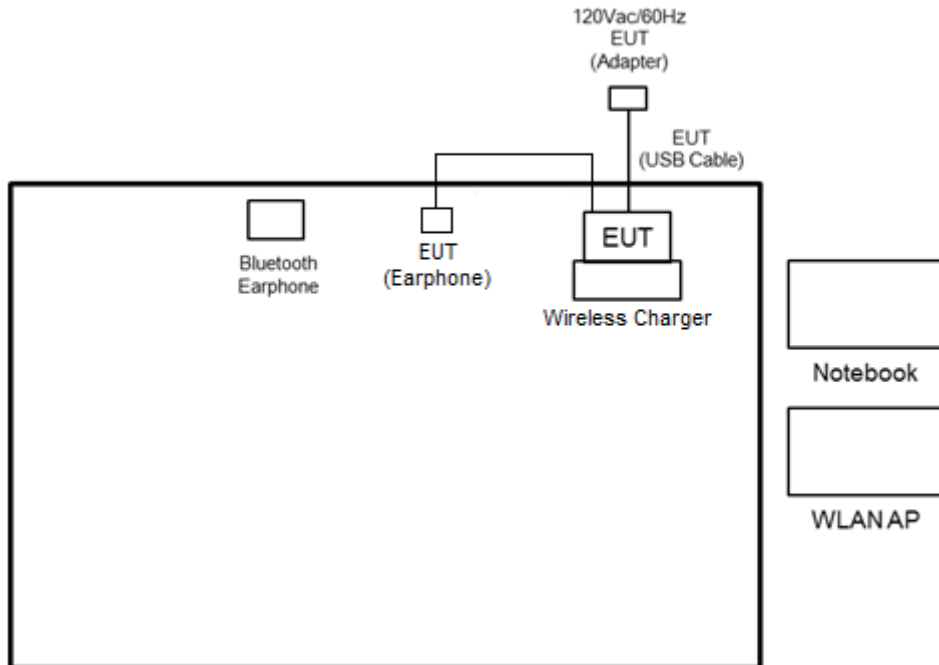



2.4 Support Unit used in test configuration and system

Item	Equipment	Trade Name	Model Name	FCC ID	Data Cable	Power Cord
1.	WLAN AP	ASUS	RT-AC66U	MSQ-RTAC66U	N/A	Unshielded, 1.8 m
2.	Notebook	DELL	Latitude E6320	FCC DoC/ Contains FCC ID: QDS-BRCM1054	N/A	AC I/P: Unshielded, 1.2 m DC O/P: Shielded, 1.8 m
3.	Bluetooth Earphone	Google	G015B	SZGG015B	N/A	N/A
4.	Wireless charger	Google	G019C	2APYSG019C	N/A	Unshielded, 1.95m

2.5 EUT Operation Test Setup

The RF test items, utility “QRCT version : 3.0.271.0” was installed in Notebook which was programmed in order to make the EUT get into the engineering modes to provide channel selection, power level, data rate and the application type and for continuous transmitting signals.

2.6 Measurement Results Explanation Example

For all conducted test items:

The offset level is set in the spectrum analyzer to compensate the RF cable loss and attenuator factor between EUT conducted output port and spectrum analyzer. With the offset compensation, the spectrum analyzer reading level is exactly the EUT RF output level.

Example :

The spectrum analyzer offset is derived from RF cable loss and attenuator factor.

Offset = RF cable loss + attenuator factor.

Following shows an offset computation example with cable loss 4.2 dB and 10dB attenuator.

$$\begin{aligned} \text{Offset}(dB) &= \text{RF cable loss}(dB) + \text{attenuator factor}(dB). \\ &= 4.2 + 10 = 14.2 \text{ (dB)} \end{aligned}$$

3 Test Result

3.1 6dB and 26dB and 99% Occupied Bandwidth Measurement

3.1.1 Description of 6dB and 26dB and 99% Occupied Bandwidth

The minimum 6 dB bandwidth shall be at least 500 kHz.

26dB and 99% Occupied bandwidth are reporting only.

3.1.2 Measuring Instruments

See list of measuring equipment of this test report.

3.1.3 Test Procedures

1. The testing follows FCC KDB 789033 D02 General UNII Test Procedures New Rules v02r01. Section C) Emission bandwidth for the band 5.725-5.85GHz
2. Set RBW = 100kHz.
3. Set the VBW $\geq 3 \times$ RBW.
4. Detector = Peak.
5. Trace mode = max hold
6. Measure the maximum width of the emission that is 6 dB down from the peak of the emission.
7. Measure and record the results in the test report.

3.1.4 Test Setup

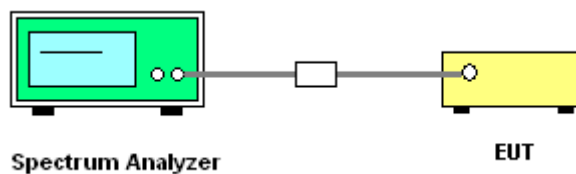

3.1.5 Test Result of 6dB and 26dB and 99% Occupied Bandwidth

Please refer to Appendix A.

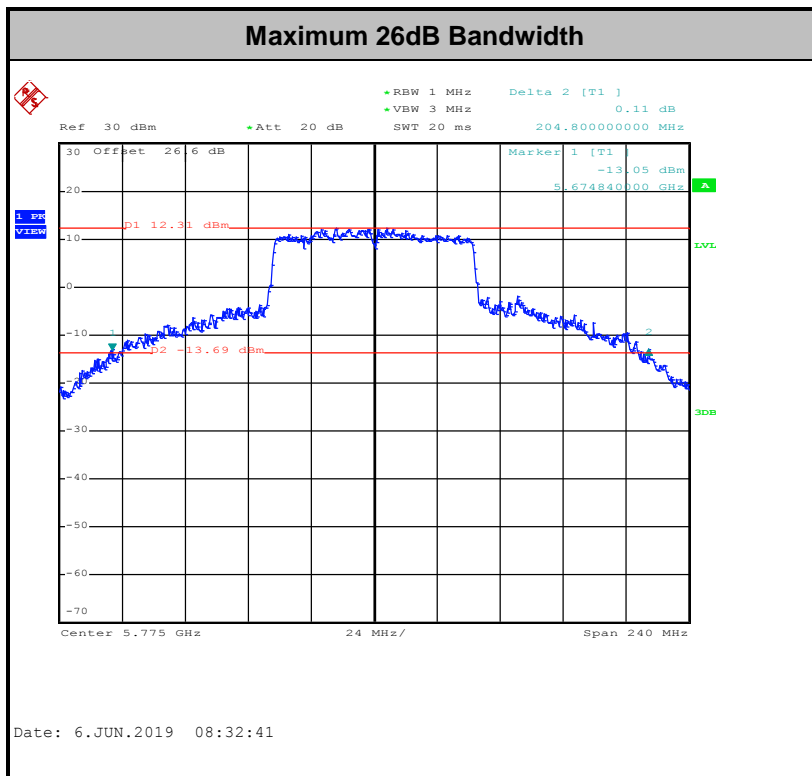
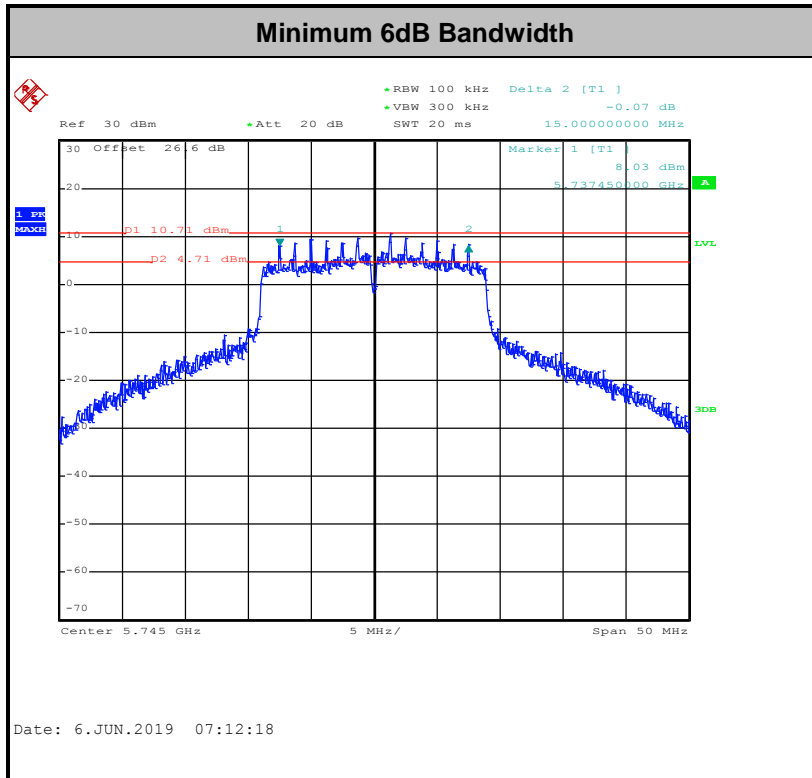

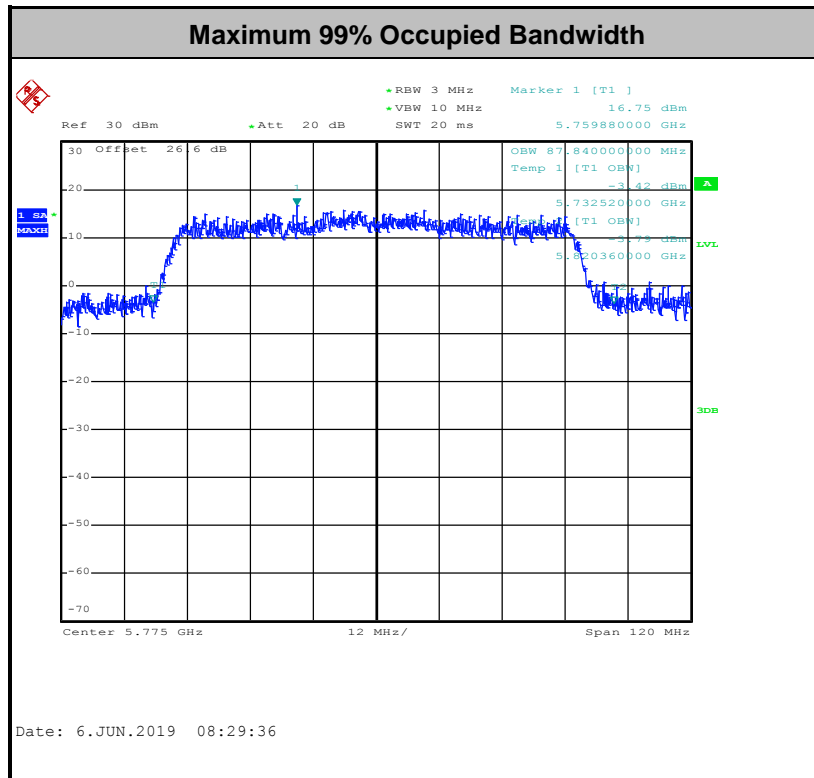

Note: The occupied channel bandwidth is maintained within the band of operation for all of the modulations.

3.2 Maximum Conducted Output Power Measurement

3.2.1 Limit of Maximum Conducted Output Power

For the band 5.725–5.85 GHz, the maximum conducted output power over the frequency band of operation shall not exceed 1 W.

If transmitting antennas of directional gain greater than 6 dBi are used, the peak output power shall be reduced by the amount in dB that the directional gain of the antenna exceeds 6 dBi.

3.2.2 Measuring Instruments

See list of measuring equipment of this test report.

3.2.3 Test Procedures

The testing follows Method PM of FCC KDB 789033 D02 General UNII Test Procedures New Rules v02r01.

Method PM (Measurement using an RF average power meter):

1. Measurement is performed using a wideband RF power meter.
2. The EUT is configured to transmit continuously with a consistent duty cycle at its maximum power control level.
3. Measure the average power of the transmitter, and the average power is corrected with duty factor, $10 \log(1/x)$, where x is the duty cycle.

3.2.4 Test Setup

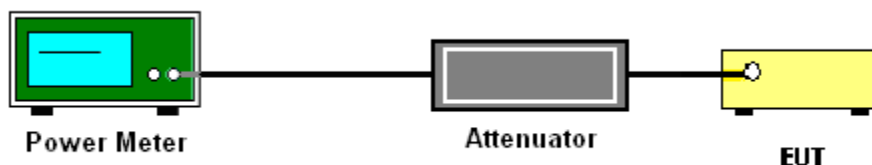

3.2.5 Test Result of Maximum Conducted Output Power

Please refer to Appendix A.



3.3 Power Spectral Density Measurement

3.3.1 Limit of Power Spectral Density

For the band 5.725–5.85 GHz, the maximum power spectral density shall not exceed 30 dBm in any 500-kHz band.

If transmitting antennas of directional gain greater than 6 dBi are used, the peak output power shall be reduced by the amount in dB that the directional gain of the antenna exceeds 6 dBi.

3.3.2 Measuring Instruments

See list of measuring equipment of this test report.

3.3.3 Test Procedures

The testing follows FCC KDB 789033 D02 General UNII Test Procedures New Rules v02r01. Section F) Maximum power spectral density.

Method SA-2

(trace averaging across on and off times of the EUT transmissions, followed by duty cycle correction).

- Measure the duty cycle.
- Set span to encompass the entire emission bandwidth (EBW) of the signal.
- Set RBW = 300 kHz.
- Set VBW \geq 1 MHz.
- Number of points in sweep \geq 2 Span / RBW.
- Sweep time = auto.
- Detector = RMS
- Trace average at least 100 traces in power averaging mode.
- Add $10 \log(500\text{kHz}/\text{RBW})$ to the test result.
- Add $10 \log(1/x)$, where x is the duty cycle, to the measured power in order to compute the average power during the actual transmission times. For example, add $10 \log(1/0.25) = 6$ dB if the duty cycle is 25 percent.

1. The RF output of EUT was connected to the spectrum analyzer by a low loss cable.
2. Each plot has already offset with cable loss, and attenuator loss. Measure the PPSD and record it.
3. For MIMO mode, calculation method follows FCC KDB 662911 D01 Multiple Transmitter Output v02r01.

Method (c): Measure and add $10 \log(N_{\text{ANT}})$ dB.

With this technique, spectrum measurements are performed at each output of the device, but rather than summing the spectra or the spectral peaks across the outputs, the quantity $10 \log(N_{\text{ANT}})$ dB is added to each spectrum value before comparing to the emission limit. The addition of $10 \log(N_{\text{ANT}})$ dB serves to apportion the emission limit among the N_{ANT} outputs so that each output is permitted to contribute no more than $1/N_{\text{ANT}}^{\text{th}}$ of the PSD limit.

3.3.4 Test Setup

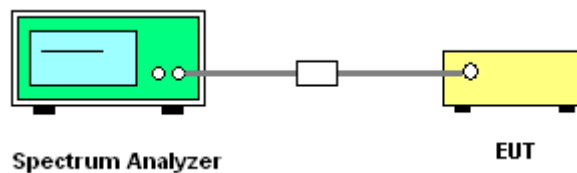

3.3.5 Test Result of Power Spectral Density

Please refer to Appendix A.



Worst Case Power Density (dBm/MHz) for MIMO Ant. 4

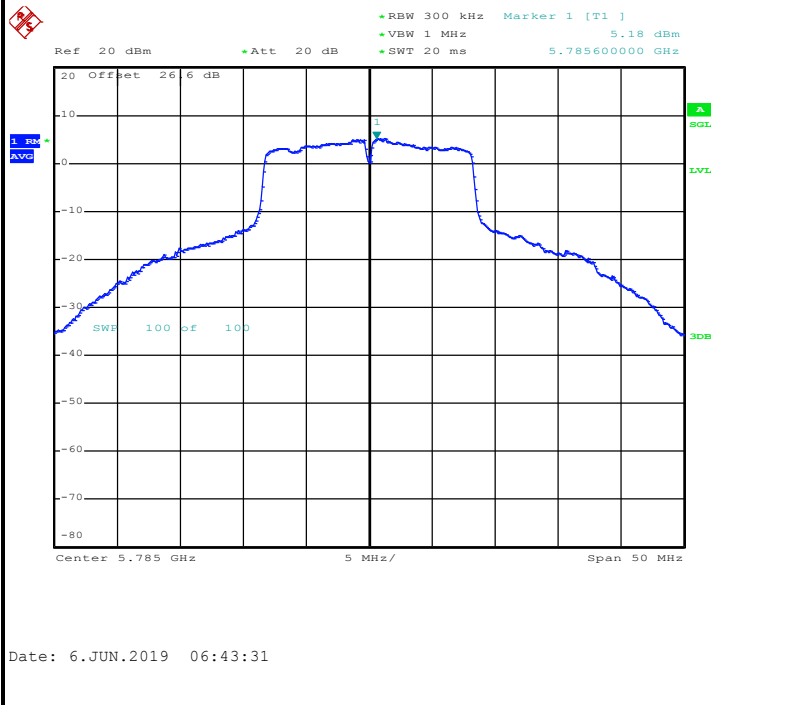

Worst Case Power Density (dBm/MHz) for MIMO Ant. 5

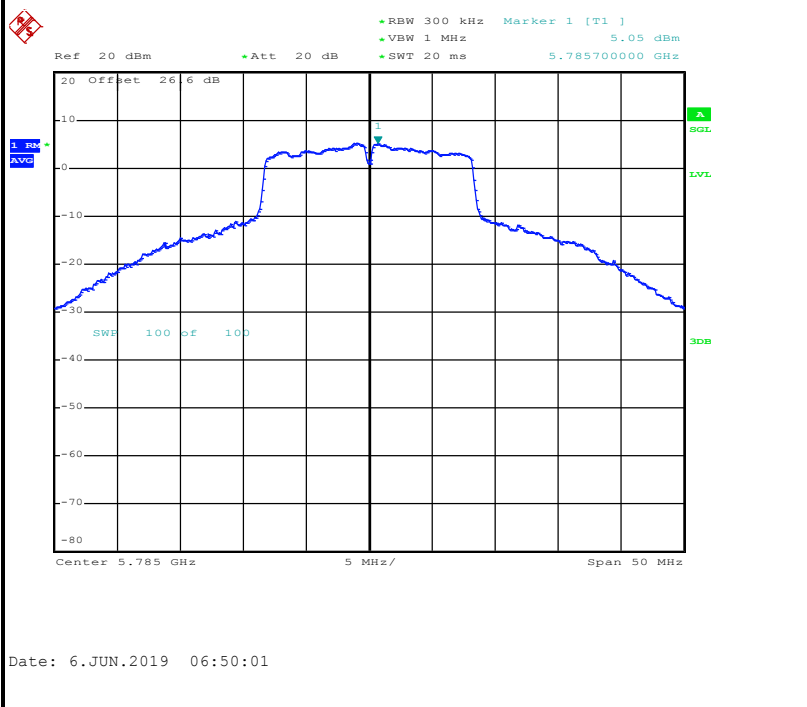



3.4 Unwanted Emissions Measurement

This section is to measure unwanted emissions through radiated measurement for band edge spurious emissions and out of band emissions measurement.

3.4.1 Limit of Unwanted Emissions

(1) For transmitters operating in the 5.725-5.85 GHz band:

15.407(b)(4)(i) All emissions shall be limited to a level of -27 dBm/MHz at 75 MHz or more above or below the band edge increasing linearly to 10 dBm/MHz at 25 MHz above or below the band edge, and from 25 MHz above or below the band edge increasing linearly to a level of 15.6 dBm/MHz at 5 MHz above or below the band edge, and from 5 MHz above or below the band edge increasing linearly to a level of 27 dBm/MHz at the band edge.

(2) Unwanted spurious emissions fallen in restricted bands shall comply with the general field strength limits as below table,

Frequency (MHz)	Field Strength (microvolts/meter)	Measurement Distance (meters)
0.009 – 0.490	2400/F(kHz)	300
0.490 – 1.705	24000/F(kHz)	30
1.705 – 30.0	30	30
30 – 88	100	3
88 – 216	150	3
216 - 960	200	3
Above 960	500	3

Note: The following formula is used to convert the EIRP to field strength.

$$E = \frac{1000000\sqrt{30P}}{3} \text{ } \mu\text{V/m, where P is the eirp (Watts)}$$

EIRP (dBm)	Field Strength at 3m (dBμV/m)
- 27	68.3



(3) KDB789033 D02 v02r01 G)2)c)

- (i) Section 15.407(b)(1) to (b)(3) specify the unwanted emission limits for the U-NII-1 and U-NII-2 bands. As specified, emissions above 1000 MHz that are outside of the restricted bands are subject to a peak emission limit of -27 dBm/MHz.³
- (ii) Section 15.407(b)(4) specifies the unwanted emission limit for the U-NII-3 band. A band emissions mask is specified in Section 15.407(b)(4)(i). The emission limits are in terms of a Peak detector. An alternative to the band emissions mask is specified in Section 15.407(b)(4)(ii). The alternative limits are based on the highest antenna gain specified in the filing. There are also marketing and importation restrictions for the devices using the alternative limit.⁴

Note 3: An out-of-band emission that complies with both the average and peak limits of Section 15.209 is not required to satisfy the -27 dBm/MHz peak emission limit.

Note 4: Only devices with antenna gains of 10 dBi or less may be approved using the emission limits specified in Section 15.247(d) till March 2, 2018; all other devices operating in this band must use the mask specified in Section 15.407(b)(4)(i).

3.4.2 Measuring Instruments

See list of measuring equipment of this test report.



3.4.3 Test Procedures

1. The testing follows FCC KDB 789033 D02 General UNII Test Procedures New Rules v02r01. Section G) Unwanted emissions measurement.
 - (1) Procedure for Unwanted Emissions Measurements Below 1000MHz
 - RBW = 120 kHz
 - VBW = 300 kHz
 - Detector = Peak
 - Trace mode = max hold
 - (2) Procedure for Peak Unwanted Emissions Measurements Above 1000 MHz
 - RBW = 1 MHz
 - VBW \geq 3 MHz
 - Detector = Peak
 - Sweep time = auto
 - Trace mode = max hold
 - (3) Procedures for Average Unwanted Emissions Measurements Above 1000MHz
 - RBW = 1 MHz
 - VBW = 10 Hz, when duty cycle is no less than 98 percent.
 - VBW \geq 1/T, when duty cycle is less than 98 percent where T is the minimum transmission duration over which the transmitter is on and is transmitting at its maximum power control level for the tested mode of operation.
2. The EUT was placed on a turntable with 0.8 meter for frequency below 1GHz and 1.5 meter for frequency above 1GHz respectively above ground.
3. The EUT was set 3 meters from the interference receiving antenna which was mounted on the top of a variable height antenna tower.
4. The antenna is a broadband antenna and its height is adjusted between one meter and four meters above ground to find the maximum value of the field strength for both horizontal polarization and vertical polarization of the antenna.
5. For each suspected emission, the EUT was arranged to its worst case and then adjust the antenna tower (from 1 m to 4 m) and turntable (from 0 degree to 360 degrees) to find the maximum reading.
6. For testing below 1GHz, if the emission level of the EUT in peak mode was 3 dB lower than the limit specified, then peak values of EUT will be reported, otherwise, the emissions will be repeated one by one using the CISPR quasi-peak method and reported.
7. For testing above 1GHz, the emission level of the EUT in peak mode was 20dB lower than average limit (that means the emission level in average mode also complies with the limit in average mode), then peak values of EUT will be reported, otherwise, the emissions will be measured in average mode again and reported.

3.4.4 Test Setup

For radiated emissions below 30MHz

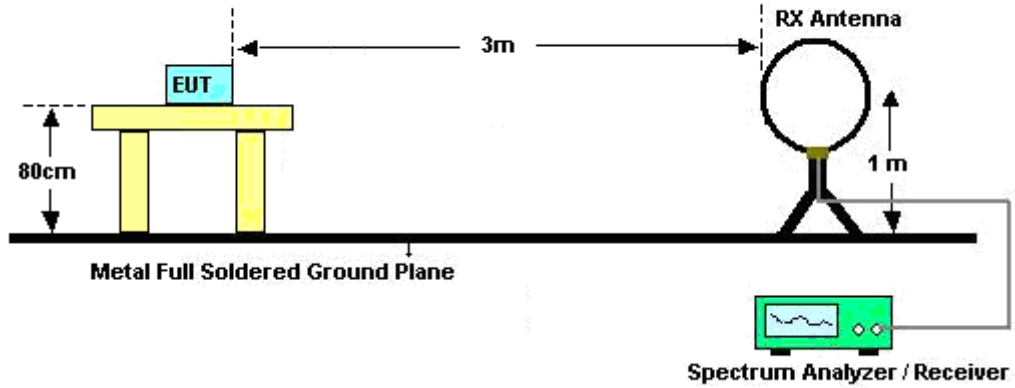

For radiated emissions from 30MHz to 1GHz

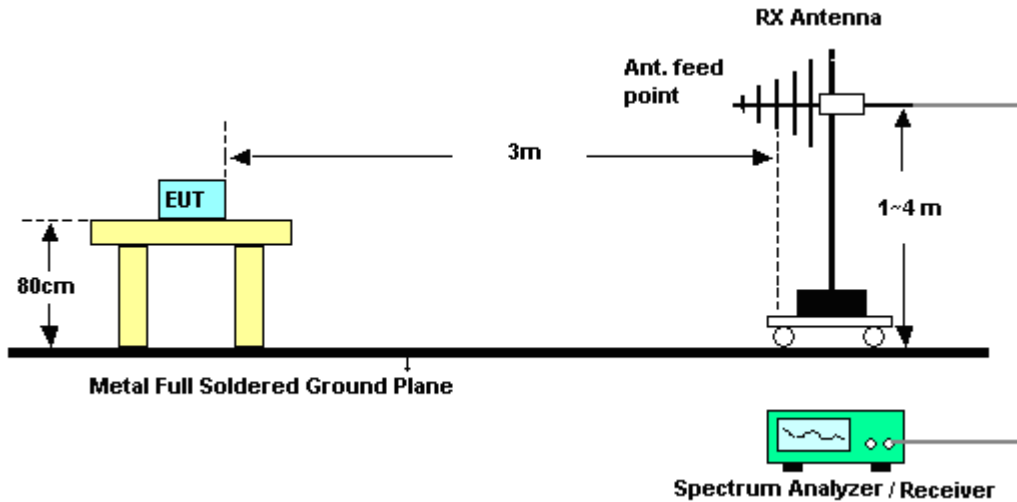

For radiated emissions above 1GHz

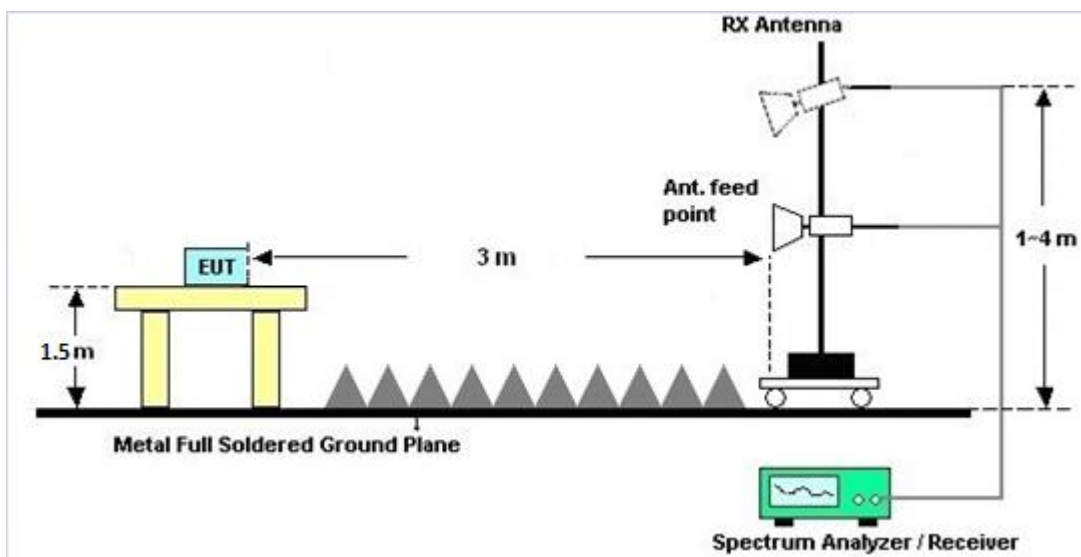



3.4.5 Test Results of Radiated Emissions (9 kHz ~ 30 MHz)

The low frequency, which started from 9 kHz to 30MHz, was pre-scanned and the result which was 20dB lower than the limit line was not reported.

There is a comparison data of both open-field test site and alternative test site - semi-Anechoic chamber according to 414788 D01 Radiated Test Site v01r01, and the result came out very similar.

3.4.6 Test Result of Radiated Band Edges

Please refer to Appendix C and D.

3.4.7 Duty Cycle

Please refer to Appendix E.

3.4.8 Test Result of Unwanted Radiated Emission (30MHz ~ 10th Harmonic)

Please refer to Appendix C and D.



3.5 AC Conducted Emission Measurement

3.5.1 Limit of AC Conducted Emission

For equipment that is designed to be connected to the public utility (AC) power line, the radio frequency voltage that is conducted back onto the AC power line on any frequency or frequencies within the band 150 kHz to 30 MHz shall not exceed the limits in the following table.

Frequency of emission (MHz)	Conducted limit (dB μ V)	
	Quasi-peak	Average
0.15-0.5	66 to 56*	56 to 46*
0.5-5	56	46
5-30	60	50

*Decreases with the logarithm of the frequency.

3.5.2 Measuring Instruments

See list of measuring equipment of this test report.

3.5.3 Test Procedures

1. The EUT was placed 0.4 meter from the conducting wall of the shielding room was kept at least 80 centimeters from any other grounded conducting surface.
2. Connect EUT to the power mains through a line impedance stabilization network (LISN).
3. All the support units are connecting to the other LISN.
4. The LISN provides 50 ohm coupling impedance for the measuring instrument.
5. The FCC states that a 50 ohm, 50 microhenry LISN should be used.
6. Both sides of AC line were checked for maximum conducted interference.
7. The frequency range from 150 kHz to 30 MHz was searched.
8. Set the test-receiver system to Peak Detect Function and specified bandwidth with Maximum Hold Mode.

3.5.4 Test Setup



3.5.5 Test Result of AC Conducted Emission

Please refer to Appendix B.



3.6 Automatically Discontinue Transmission

3.6.1 Limit of Automatically Discontinue Transmission

The device shall automatically discontinue transmission in case of either absence of information to transmit or operational failure. These provisions are not intended to preclude the transmission of control or signaling information or the use of repetitive codes used by certain digital technologies to complete frame or burst intervals. Applicants shall include in their application for equipment authorization to describe how this requirement is met.

3.6.2 Measuring Instruments

See list of measuring equipment of this test report.

3.6.3 Test Result of Automatically Discontinue Transmission

EUT is verified this characteristic during the function check of normal sample associated with an access point:

- A. Information start: make EUT supply information to the access point.
- B. Information stop: stop supplying information to the access point.

While the EUT is not transmitting any information, the EUT can automatically discontinue transmission and become standby mode for power saving.

- C. Information start: make EUT supply information to the access point again.

The EUT can detect the controlling signal of ACK message transmitting from remote device and verify whether it shall resend or discontinue transmission.

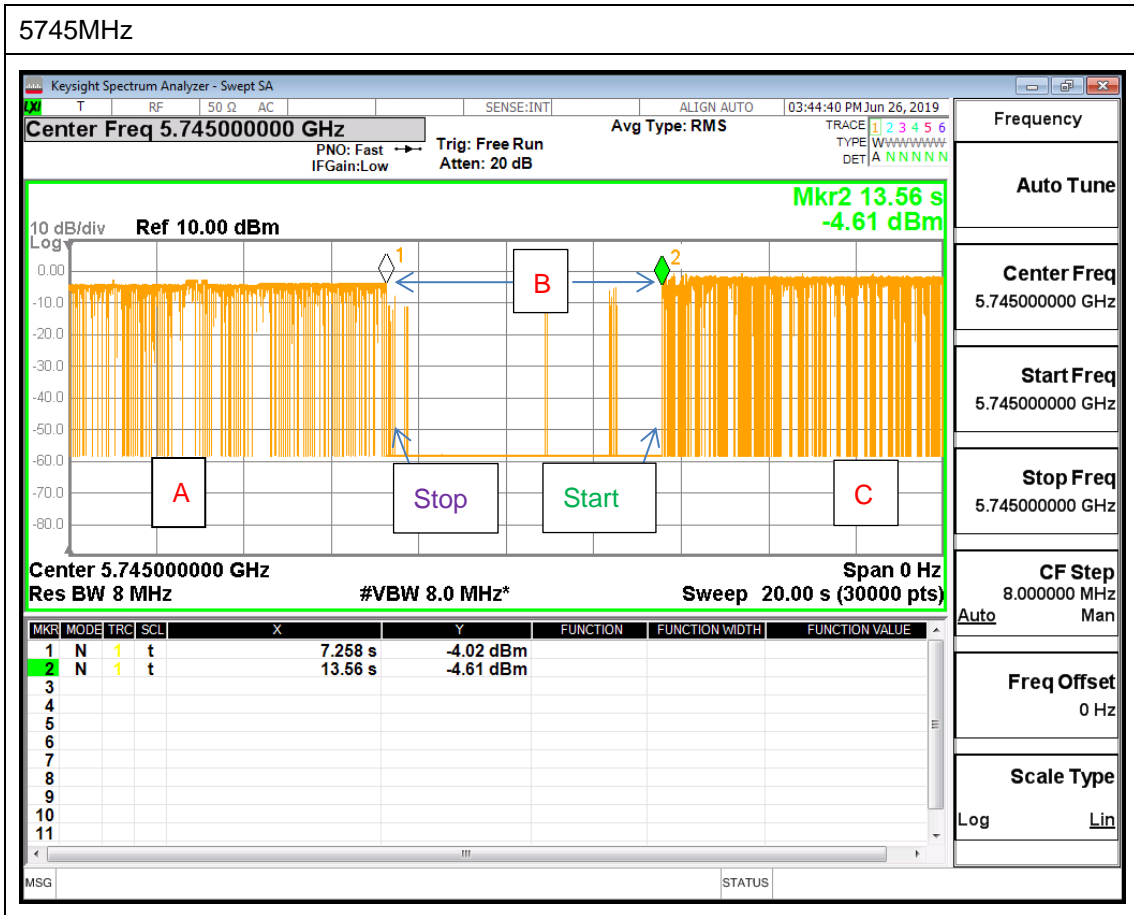

Note: The control / signaling information during the period B is precluded.



3.7 Antenna Requirements

3.7.1 Standard Applicable

If transmitting antenna directional gain is greater than 6 dBi, both the peak transmit power and the peak power spectral density shall be reduced by the amount in dB that the directional gain of the antenna exceeds 6 dBi.

3.7.2 Antenna Anti-Replacement Construction

An embedded-in antenna design is used.

3.7.3 Antenna Gain

<CDD Modes >

FCC KDB 662911 D01 Multiple Transmitter Output v02r01

For CDD transmissions, directional gain is calculated as

Directional gain = GANT + Array Gain, where Array Gain is as follows.

For power spectral density (PSD) measurements on all devices,

Array Gain = 10 log(NANT/NSS=1) dB.

For power measurements on IEEE 802.11 devices,

Array Gain = 0 dB (i.e., no array gain) for NANT ≤ 4.

Directional gain may be calculated by using the formulas applicable to equal gain antennas with GANT set equal to the gain of the antenna having the highest gain;

The EUT supports CDD mode.

For power, the directional gain GANT is set equal to the antenna having the highest gain, i.e., F)2)f)i).

For PSD, the directional gain calculation is following F)2)f)ii) of KDB 662911 D01 v02r01.

The power and PSD limit should be modified if the directional gain of EUT is over 6 dBi,

The directional gain "DG" is calculated as following table.

<CDD Modes>						
			DG	DG	Power	PSD
			for	for	Limit	Limit
	Ant. 4	Ant. 5	Power	PSD	Reduction	Reduction
	(dBi)	(dBi)	(dBi)	(dBi)	(dB)	(dB)
Band IV	-5.60	-1.10	-1.10	-0.05	0.00	0.00

Power Limit Reduction = DG(Power) – 6dBi, (min = 0)

PSD Limit Reduction = DG(PSD) – 6dBi, (min = 0)



4 List of Measuring Equipment

Instrument	Manufacturer	Model No.	Serial No.	Characteristics	Calibration Date	Test Date	Due Date	Remark
Loop Antenna	Rohde & Schwarz	HFH2-Z2	100488	9 kHz~30 MHz	Jan. 07, 2019	May 31, 2019~ Jun. 18, 2019	Jan. 06, 2020	Radiation (03CH13-HY)
Horn Antenna	SCHWARZBE CK	BBHA 9120 D	9120D-124 1	1GHz ~ 18GHz	Jun. 29, 2018	May 31, 2019~ Jun. 18, 2019	Jun. 28, 2019	Radiation (03CH13-HY)
Bilog Antenna	TESEQ	CBL 6111D&00800 N1D01N-06	37059&01	30MHz~1GHz	Oct. 13, 2018	May 31, 2019~ Jun. 18, 2019	Oct. 12, 2019	Radiation (03CH13-HY)
SHF-EHF Horn Antenna	SCHWARZBE CK	BBHA 9170	BBHA9170 584	18GHz- 40GHz	Dec. 05, 2018	May 31, 2019~ Jun. 18, 2019	Dec. 04, 2019	Radiation (03CH13-HY)
Preamplifier	Keysight	83017A	MY532700 80	1GHz~26.5GHz	Nov. 14, 2018	May 31, 2019~ Jun. 18, 2019	Nov. 13, 2020	Radiation (03CH13-HY)
Preamplifier	MITEQ	AMF-7D-0010 1800-30-10P	1590074	1GHz~18GHz	May 20, 2019	May 31, 2019~ Jun. 18, 2019	May 19, 2020	Radiation (03CH13-HY)
Amplifier	Sonoma-Instru ment	310 N	187282	9KHz~1GHz	Dec. 18, 2018	May 31, 2019~ Jun. 18, 2019	Dec. 17, 2019	Radiation (03CH13-HY)
Amplifier	MITEQ	TTA1840-35- HG	1871923	18GHz~40GHz, VSWR : 2.5:1 max	Jul. 16, 2018	May 31, 2019~ Jun. 18, 2019	Jul. 15, 2019	Radiation (03CH13-HY)
RF Cable	HUBER + SUHNER	SUCOFLEX 126E	0030/126E	30M-18G	Feb. 13, 2019	May 31, 2019~ Jun. 18, 2019	Feb. 12, 2020	Radiation (03CH13-HY)
RF Cable	HUBER + SUHNER	SUCOFLEX 104	804793/4	30M-18G	Feb. 13, 2019	May 31, 2019~ Jun. 18, 2019	Feb. 12, 2020	Radiation (03CH13-HY)
RF Cable	HUBER + SUHNER	SUCOFLEX 104	MY24961/ 4	30M-18G	Feb. 13, 2019	May 31, 2019~ Jun. 18, 2019	Feb. 12, 2020	Radiation (03CH13-HY)
RF Cable	HUBER + SUHNER	SUCOFLEX 102	MY2859/2	30M~40GHz	Mar. 13, 2019	May 31, 2019~ Jun. 18, 2019	Mar. 12, 2020	Radiation (03CH13-HY)
RF Cable	HUBER + SUHNER	SUCOFLEX 102	MY4274/2	30M~40GHz	Mar. 13, 2019	May 31, 2019~ Jun. 18, 2019	Mar. 12, 2020	Radiation (03CH13-HY)
Spectrum Analyzer	Keysight	N9010A	MY553705 26	10Hz~44GHz	Mar. 19, 2019	May 31, 2019~ Jun. 18, 2019	Mar. 18, 2020	Radiation (03CH13-HY)
Antenna Mast	EMEC	AM-BS-4500- B	N/A	1m~4m	N/A	May 31, 2019~ Jun. 18, 2019	N/A	Radiation (03CH13-HY)
Turn Table	EMEC	TT2000	N/A	0~360 Degree	N/A	May 31, 2019~ Jun. 18, 2019	N/A	Radiation (03CH13-HY)
Software	AUDIX	E3 6.2009-8-24c	RK-001124	N/A	N/A	May 31, 2019~ Jun. 18, 2019	N/A	Radiation (03CH13-HY)
EMI Test Receiver	Keysight	N9038A (MXE)	MY541300 85	20Hz ~ 8.4GHz	Nov. 01, 2018	May 31, 2019~ Jun. 18, 2019	Oct. 31, 2019	Radiation (03CH13-HY)
Filter	Wainwright	WHKX12-108 0-1200-15000 -60ST	SN3	1.2G Low Pass	Jul. 05, 2018	May 31, 2019~ Jun. 18, 2019	Jul. 04, 2019	Radiation (03CH13-HY)
Filter	Woken	WHKX8-5272. 5-6750-18000 -40ST	SN5	6.75G Highpass	Mar. 13, 2019	May 31, 2019~ Jun. 18, 2019	Mar. 12, 2020	Radiation (03CH13-HY)



Instrument	Manufacturer	Model No.	Serial No.	Characteristics	Calibration Date	Test Date	Due Date	Remark
Power Sensor	DARE	RPR3006W	13I00030S NO32	9kHz~6GHz	Dec. 03, 2018	Apr. 06, 2019~ Jun. 06, 2019	Dec. 02, 2019	Conducted (TH05-HY)
Spectrum Analyzer	Rohde & Schwarz	FSP40	100057	9kHz~40GHz	Nov. 21, 2018	Apr. 06, 2019~ Jun. 06, 2019	Nov. 20, 2019	Conducted (TH05-HY)
Spectrum Analyzer	Rohde & Schwarz	FSV 40	101397	10Hz~40GHz	Nov. 13, 2018	Apr. 06, 2019~ Jun. 06, 2019	Nov. 12, 2019	Conducted (TH05-HY)
Switch Box & RF Cable	Burgeon	ETF-058	EC120838 2	N/A	Mar. 27, 2019	Apr. 06, 2019~ Jun. 06, 2019	Mar. 26, 2020	Conducted (TH05-HY)
AC Power Source	ChainTek	APC-1000W	N/A	N/A	N/A	May 23, 2019	N/A	Conduction (CO05-HY)
EMI Test Receiver	Rohde & Schwarz	ESR3	102388	9KHz~3.6GHz	Nov. 12, 2018	May 23, 2019	Nov. 11, 2019	Conduction (CO05-HY)
LISN	Rohde & Schwarz	ENV216	100080	9kHz~30MHz	Nov. 14, 2018	May 23, 2019	Nov. 13, 2019	Conduction (CO05-HY)
LISN	Rohde & Schwarz	ENV216	100081	9kHz~30MHz	Nov. 09, 2018	May 23, 2019	Nov. 08, 2019	Conduction (CO05-HY)
Software	Rohde & Schwarz	EMC32 V10.30	N/A	N/A	N/A	May 23, 2019	N/A	Conduction (CO05-HY)
LF Cable	HUBER + SUHNER	RG-214/U	LF01	N/A	Dec. 31, 2018	May 23, 2019	Dec. 30, 2019	Conduction (CO05-HY)
Pulse Limiter	Rohde & Schwarz	ESH3-Z2	100851	N/A	Dec. 31, 2018	May 23, 2019	Dec. 30, 2019	Conduction (CO05-HY)
Spectrum Analyzer	Keysight	N9010A	MY560704 12	10Hz~7GHz	Aug. 16, 2018	Jun. 26, 2019	Aug. 15, 2019	DFS (DFS02-HY)



5 Uncertainty of Evaluation

Uncertainty of Conducted Emission Measurement (150kHz ~ 30MHz)

Measuring Uncertainty for a Level of Confidence of 95% ($U = 2Uc(y)$)	2.2
---	-----

Uncertainty of Radiated Emission Measurement (30 MHz ~ 1000 MHz)

Measuring Uncertainty for a Level of Confidence of 95% ($U = 2Uc(y)$)	4.9
---	-----

Uncertainty of Radiated Emission Measurement (1000 MHz ~ 18000 MHz)

Measuring Uncertainty for a Level of Confidence of 95% ($U = 2Uc(y)$)	5.4
---	-----

Uncertainty of Radiated Emission Measurement (18000 MHz ~ 40000 MHz)

Measuring Uncertainty for a Level of Confidence of 95% ($U = 2Uc(y)$)	4.3
---	-----

Appendix A. Test Result of Conducted Test Items

Test Engineer:	Nick Yu / Rebecca Li /Richard Qiu	Temperature:	21~25	°C
Test Date:	2019/4/06~2019/6/6	Relative Humidity:	51~54	%

TEST RESULTS DATA
6dB and 26dB EBW and 99% OBW

Band IV												
Mod.	Data Rate	NTX	CH.	Freq. (MHz)	99% Bandwidth (MHz)		26dB Bandwidth (MHz)		6 dB Bandwidth (MHz)		6 dB Bandwidth Min. Limit (MHz)	Pass/Fail
					Ant 4	Ant 5	Ant 4	Ant 5	Ant 4	Ant 5		
11a	6Mbps	2	149	5745	18.85	26.20	38.50	43.85	15.10	15.75	0.5	Pass
11a	6Mbps	2	157	5785	23.30	25.90	42.50	43.20	15.45	15.40	0.5	Pass
11a	6Mbps	2	165	5825	22.10	28.35	40.85	44.60	15.15	16.00	0.5	Pass
HT20	MCS0	2	149	5745	18.50	27.35	40.40	48.10	15.00	16.50	0.5	Pass
HT20	MCS0	2	157	5785	24.65	30.25	46.76	48.12	15.95	16.50	0.5	Pass
HT20	MCS0	2	165	5825	28.50	29.45	48.12	49.68	15.30	17.55	0.5	Pass
HT40	MCS0	2	151	5755	38.50	57.10	79.89	95.76	35.10	35.00	0.5	Pass
HT40	MCS0	2	159	5795	55.40	58.40	86.73	97.68	35.00	35.00	0.5	Pass
VHT80	MCS0	2	155	5775	78.36	87.84	169.92	204.80	75.12	75.00	0.5	Pass

TEST RESULTS DATA
Average Power Table

Band IV												
Mod.	Data Rate	NTX	CH.	Freq. (MHz)	Average Conducted Power (dBm)			FCC Conducted Power Limit (dBm)		DG (dBi)		Pass/Fail
					Ant 4	Ant 5	SUM	Ant 4	Ant 5	Ant 4	Ant 5	
11a	6Mbps	1	149	5745	20.50	20.60		30.00	30.00	-5.60	-1.10	Pass
11a	6Mbps	1	157	5785	20.40	20.40		30.00	30.00	-5.60	-1.10	Pass
11a	6Mbps	1	165	5825	20.50	20.50		30.00	30.00	-5.60	-1.10	Pass
HT20	MCS0	1	149	5745	20.40	20.50		30.00	30.00	-5.60	-1.10	Pass
HT20	MCS0	1	157	5785	20.40	20.30		30.00	30.00	-5.60	-1.10	Pass
HT20	MCS0	1	165	5825	20.50	20.40		30.00	30.00	-5.60	-1.10	Pass
HT40	MCS0	1	151	5755	20.40	20.70		30.00	30.00	-5.60	-1.10	Pass
HT40	MCS0	1	159	5795	20.30	20.50		30.00	30.00	-5.60	-1.10	Pass
VHT20	MCS0	1	149	5745	20.40	20.40		30.00	30.00	-5.60	-1.10	Pass
VHT20	MCS0	1	157	5785	20.30	20.30		30.00	30.00	-5.60	-1.10	Pass
VHT20	MCS0	1	165	5825	20.50	20.30		30.00	30.00	-5.60	-1.10	Pass
VHT40	MCS0	1	151	5755	20.30	20.60		30.00	30.00	-5.60	-1.10	Pass
VHT40	MCS0	1	159	5795	20.30	20.40		30.00	30.00	-5.60	-1.10	Pass
VHT80	MCS0	1	155	5775	20.80	20.80		30.00	30.00	-5.60	-1.10	Pass
11a	6Mbps	2	149	5745	20.50	20.80	23.66	30.00		-1.10		Pass
11a	6Mbps	2	157	5785	20.70	20.70	23.71	30.00		-1.10		Pass
11a	6Mbps	2	165	5825	20.80	20.80	23.81	30.00		-1.10		Pass
HT20	MCS0	2	149	5745	20.50	20.80	23.66	30.00		-1.10		Pass
HT20	MCS0	2	157	5785	20.70	20.60	23.66	30.00		-1.10		Pass
HT20	MCS0	2	165	5825	20.80	20.70	23.76	30.00		-1.10		Pass
HT40	MCS0	2	151	5755	20.50	20.90	23.71	30.00		-1.10		Pass
HT40	MCS0	2	159	5795	20.70	20.80	23.76	30.00		-1.10		Pass
VHT20	MCS0	2	149	5745	20.40	20.70	23.56	30.00		-1.10		Pass
VHT20	MCS0	2	157	5785	20.60	20.50	23.56	30.00		-1.10		Pass
VHT20	MCS0	2	165	5825	20.70	20.60	23.66	30.00		-1.10		Pass
VHT40	MCS0	2	151	5755	20.40	20.80	23.61	30.00		-1.10		Pass
VHT40	MCS0	2	159	5795	20.60	20.70	23.66	30.00		-1.10		Pass
VHT80	MCS0	2	155	5775	20.40	20.90	23.67	30.00		-1.10		Pass

TEST RESULTS DATA
Power Spectral Density

Band IV																
Mod.	Data Rate	NTX	CH.	Freq. (MHz)	Duty Factor (dB)		10log (500kHz /RBW) Factor (dB)		Average Power Density (dBm/500kHz)			Average PSD Limit (dBm/500kHz)		DG (dBi)		Pass /Fail
					Ant 4	Ant 5	Ant 4	Ant 5	Ant 4	Ant 5	SUM	Ant 4	Ant 5	Ant 4	Ant 5	
11a	6Mbps	2	149	5745	0.08	0.06	2.22	7.09	7.12	10.13	30.00		-0.05		Pass	
11a	6Mbps	2	157	5785	0.08	0.06	2.22	7.48	7.33	10.49	30.00		-0.05		Pass	
11a	6Mbps	2	165	5825	0.08	0.06	2.22	7.27	7.43	10.44	30.00		-0.05		Pass	
HT20	MCS0	2	149	5745	0.09	0.09	2.22	6.62	6.73	9.74	30.00		-0.05		Pass	
HT20	MCS0	2	157	5785	0.09	0.09	2.22	6.87	6.98	9.99	30.00		-0.05		Pass	
HT20	MCS0	2	165	5825	0.09	0.09	2.22	7.24	6.83	10.25	30.00		-0.05		Pass	
HT40	MCS0	2	151	5755	0.16	0.16	2.22	3.66	3.50	6.67	30.00		-0.05		Pass	
HT40	MCS0	2	159	5795	0.16	0.16	2.22	3.63	3.59	6.64	30.00		-0.05		Pass	
VHT80	MCS0	2	155	5775	0.32	0.32	2.22	0.77	0.59	3.78	30.00		-0.05		Pass	

Note: PSD Sum = Max PSD(Ant. 4, Ant. 5) + 10 log (n)



Appendix B. AC Conducted Emission Test Results

Test Engineer :	Jimmy Chang	Temperature :	24~26°C
		Relative Humidity :	51~54%

EUT Information

Report NO : 8N0620-05
 Test Mode : Mode 2
 Test Voltage : 120Vac/60Hz
 Phase : Line

Full Spectrum

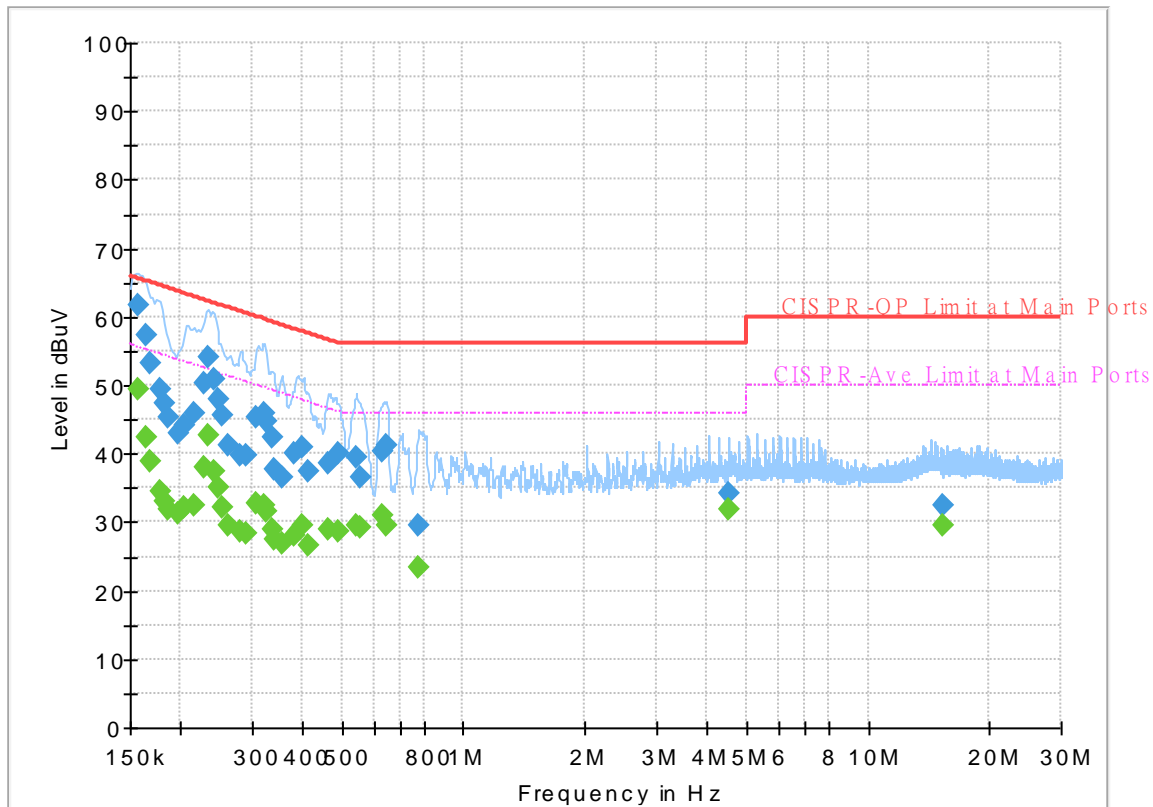

Final Result

Frequency (MHz)	QuasiPeak (dBuV)	CAverage (dBuV)	Limit (dBuV)	Margin (dB)	Line	Filter	Corr. (dB)
0.156750	---	49.31	55.63	6.32	L1	OFF	19.5
0.156750	61.76	---	65.63	3.87	L1	OFF	19.5
0.163500	---	42.31	55.28	12.97	L1	OFF	19.5
0.163500	57.41	---	65.28	7.87	L1	OFF	19.5
0.168000	---	38.84	55.06	16.22	L1	OFF	19.5
0.168000	53.21	---	65.06	11.85	L1	OFF	19.5
0.177000	---	34.47	54.63	20.16	L1	OFF	19.5
0.177000	49.51	---	64.63	15.12	L1	OFF	19.5
0.181500	---	33.14	54.42	21.28	L1	OFF	19.5
0.181500	47.49	---	64.42	16.93	L1	OFF	19.5
0.186000	---	32.01	54.21	22.20	L1	OFF	19.5
0.186000	45.29	---	64.21	18.92	L1	OFF	19.5
0.197250	---	31.22	53.73	22.51	L1	OFF	19.5
0.197250	43.10	---	63.73	20.63	L1	OFF	19.5
0.204000	---	32.07	53.45	21.38	L1	OFF	19.5
0.204000	44.16	---	63.45	19.29	L1	OFF	19.5
0.215250	---	32.57	53.00	20.43	L1	OFF	19.5
0.215250	45.98	---	63.00	17.02	L1	OFF	19.5
0.228750	---	38.14	52.50	14.36	L1	OFF	19.5
0.228750	50.40	---	62.50	12.10	L1	OFF	19.5
0.233250	---	42.61	52.33	9.72	L1	OFF	19.5

0.233250	54.13	---	62.33	8.20	L1	OFF	19.5
0.242250	---	37.41	52.02	14.61	L1	OFF	19.5
0.242250	50.84	---	62.02	11.18	L1	OFF	19.5
0.246750	---	34.95	51.87	16.92	L1	OFF	19.5
0.246750	48.00	---	61.87	13.87	L1	OFF	19.5
0.253500	---	32.30	51.64	19.34	L1	OFF	19.5
0.253500	45.48	---	61.64	16.16	L1	OFF	19.5
0.262500	---	29.43	51.35	21.92	L1	OFF	19.5
0.262500	41.14	---	61.35	20.21	L1	OFF	19.5
0.280500	---	28.65	50.80	22.15	L1	OFF	19.5
0.280500	39.63	---	60.80	21.17	L1	OFF	19.5
0.289500	---	28.50	50.54	22.04	L1	OFF	19.5
0.289500	39.70	---	60.54	20.84	L1	OFF	19.5
0.307500	---	32.77	50.04	17.27	L1	OFF	19.5
0.307500	45.23	---	60.04	14.81	L1	OFF	19.5
0.323250	---	32.42	49.62	17.20	L1	OFF	19.5
0.323250	45.86	---	59.62	13.76	L1	OFF	19.5
0.325500	---	31.64	49.57	17.93	L1	OFF	19.5
0.325500	44.60	---	59.57	14.97	L1	OFF	19.5
0.336750	---	28.90	49.28	20.38	L1	OFF	19.5
0.336750	42.32	---	59.28	16.96	L1	OFF	19.5
0.341250	---	27.55	49.17	21.62	L1	OFF	19.5
0.341250	37.72	---	59.17	21.45	L1	OFF	19.5
0.357000	---	26.83	48.80	21.97	L1	OFF	19.5
0.357000	36.67	---	58.80	22.13	L1	OFF	19.5
0.384000	---	28.17	48.19	20.02	L1	OFF	19.5
0.384000	39.96	---	58.19	18.23	L1	OFF	19.5
0.399750	---	29.56	47.86	18.30	L1	OFF	19.5
0.399750	41.08	---	57.86	16.78	L1	OFF	19.5
0.415500	---	26.48	47.54	21.06	L1	OFF	19.5
0.415500	37.38	---	57.54	20.16	L1	OFF	19.5
0.462750	---	28.92	46.64	17.72	L1	OFF	19.5
0.462750	38.50	---	56.64	18.14	L1	OFF	19.5
0.489750	---	28.54	46.17	17.63	L1	OFF	19.5
0.489750	40.09	---	56.17	16.08	L1	OFF	19.5
0.543750	---	29.58	46.00	16.42	L1	OFF	19.5
0.543750	39.55	---	56.00	16.45	L1	OFF	19.5
0.557250	---	29.33	46.00	16.67	L1	OFF	19.5
0.557250	36.47	---	56.00	19.53	L1	OFF	19.5
0.627000	---	30.86	46.00	15.14	L1	OFF	19.6
0.627000	40.49	---	56.00	15.51	L1	OFF	19.6
0.642750	---	29.51	46.00	16.49	L1	OFF	19.6
0.642750	41.36	---	56.00	14.64	L1	OFF	19.6
0.773250	---	23.49	46.00	22.51	L1	OFF	19.6
0.773250	29.53	---	56.00	26.47	L1	OFF	19.6
4.537500	---	31.93	46.00	14.07	L1	OFF	19.7
4.537500	34.12	---	56.00	21.88	L1	OFF	19.7
15.378000	---	29.64	50.00	20.36	L1	OFF	20.1
15.378000	32.57	---	60.00	27.43	L1	OFF	20.1

EUT Information

Report NO : 8N0620-05
 Test Mode : Mode 2
 Test Voltage : 120Vac/60Hz
 Phase : Neutral

Full Spectrum

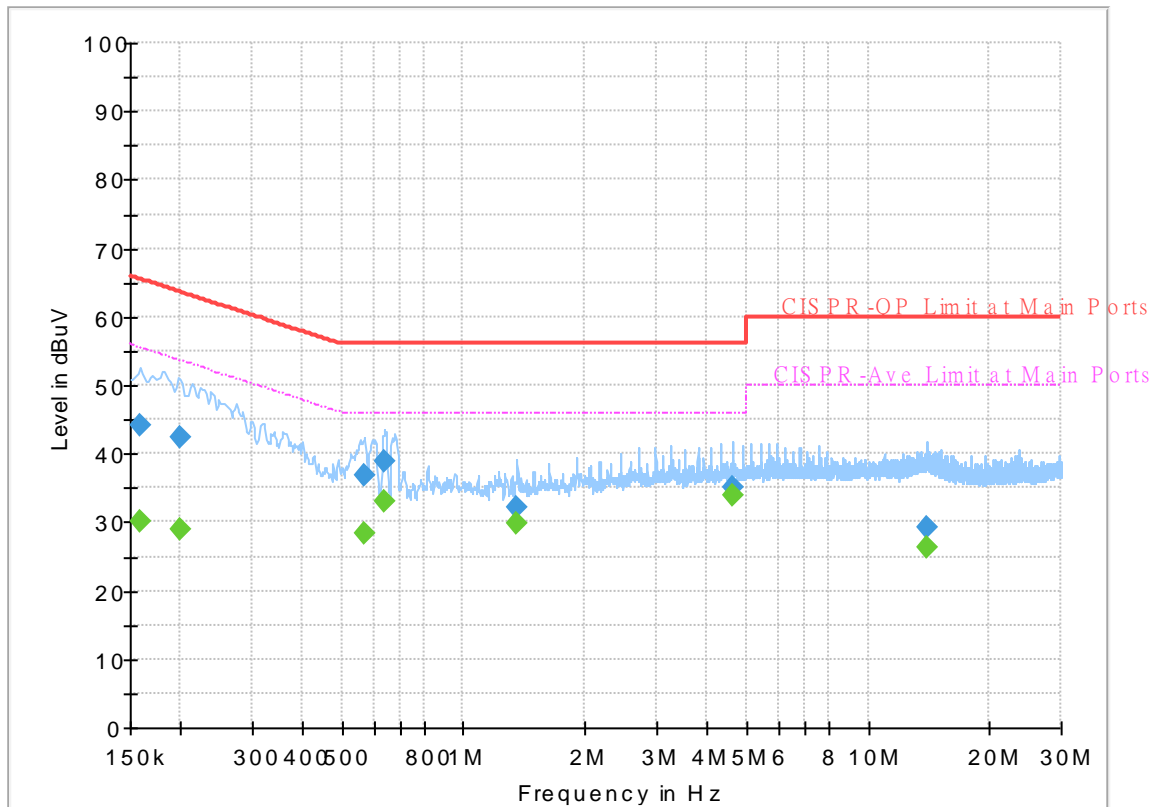

Final_Result

Frequency (MHz)	QuasiPeak (dBuV)	CAverage (dBuV)	Limit (dBuV)	Margin (dB)	Line	Filter	Corr. (dB)
0.159000	---	30.21	55.52	25.31	N	OFF	19.5
0.159000	44.11	---	65.52	21.41	N	OFF	19.5
0.199500	---	29.08	53.63	24.55	N	OFF	19.5
0.199500	42.46	---	63.63	21.17	N	OFF	19.5
0.568500	---	28.24	46.00	17.76	N	OFF	19.5
0.568500	36.93	---	56.00	19.07	N	OFF	19.5
0.638250	---	32.93	46.00	13.07	N	OFF	19.6
0.638250	38.81	---	56.00	17.19	N	OFF	19.6
1.356000	---	29.86	46.00	16.14	N	OFF	19.6
1.356000	32.13	---	56.00	23.87	N	OFF	19.6
4.609500	---	33.94	46.00	12.06	N	OFF	19.7
4.609500	35.19	---	56.00	20.81	N	OFF	19.7
14.032500	---	26.46	50.00	23.54	N	OFF	20.1
14.032500	29.26	---	60.00	30.74	N	OFF	20.1



Appendix C. Radiated Spurious Emission

Test Engineer :	Andy Yang, JC Liang and Wilson Wu	Temperature :	25~25°C
		Relative Humidity :	48~50%

<Adapter Mode>

Band 4 - 5725~5850MHz

WIFI 802.11a (Band Edge @ 3m)

WIFI Ant.	Note	Frequency	Level	Over Limit	Limit Line	Read Level	Antenna Factor	Path Loss	Preamp Factor	Ant Pos	Table Pos	Peak Avg.	Pol.	
4+5		(MHz)	(dBμV/m)	(dB)	(dBμV/m)	(dBμV)	(dB/m)	(dB)	(dB)	(cm)	(deg)	(P/A)	(H/V)	
802.11a CH 149 5745MHz		5621.2	49.3	-18.9	68.2	40.45	32.07	6.33	29.55	206	325	P	H	
		5699.2	54.32	-50.29	104.61	45.34	32.17	6.36	29.55	206	325	P	H	
		5719	66.58	-43.94	110.52	57.55	32.21	6.37	29.55	206	325	P	H	
		5724.8	75.62	-46.12	121.74	66.59	32.21	6.37	29.55	206	325	P	H	
	*	5745	110.23	-	-	101.16	32.24	6.38	29.55	206	325	P	H	
	*	5745	103.08	-	-	94.01	32.24	6.38	29.55	206	325	A	H	
														H
														H
			5640.6	49.87	-18.33	68.2	40.99	32.09	6.34	29.55	300	354	P	V
			5700	54.68	-50.52	105.2	45.7	32.17	6.36	29.55	300	354	P	V
			5714.6	62.29	-47	109.29	53.28	32.19	6.37	29.55	300	354	P	V
			5725	70.39	-51.81	122.2	61.36	32.21	6.37	29.55	300	354	P	V
	*		5745	107.88	-	-	98.81	32.24	6.38	29.55	300	354	P	V
	*		5745	100.63	-	-	91.56	32.24	6.38	29.55	300	354	A	V
														V
													V	



WIFI Ant. 4+5	Note	Frequency (MHz)	Level (dBμV/m)	Over Limit (dB)	Limit Line (dBμV/m)	Read Level (dBμV)	Antenna Factor (dB/m)	Path Loss (dB)	Preamp Factor (dB)	Ant Pos (cm)	Table Pos (deg)	Peak Avg. (P/A)	Pol. (H/V)
		5641.6	49.09	-19.11	68.2	40.21	32.09	6.34	29.55	207	330	P	H
		5673.8	49.34	-36.51	85.85	40.4	32.14	6.35	29.55	207	330	P	H
		5714.2	52.31	-56.87	109.18	43.3	32.19	6.37	29.55	207	330	P	H
		5724.2	51.63	-68.75	120.38	42.6	32.21	6.37	29.55	207	330	P	H
	*	5785	110.69	-	-	101.57	32.29	6.39	29.56	207	330	P	H
	*	5785	103.55	-	-	94.43	32.29	6.39	29.56	207	330	A	H
		5853.8	50.58	-62.96	113.54	41.29	32.41	6.44	29.56	207	330	P	H
		5860	50.37	-59.03	109.4	41.07	32.41	6.45	29.56	207	330	P	H
		5907	49.44	-32.04	81.48	40.03	32.48	6.49	29.56	207	330	P	H
		5925.8	48.92	-19.28	68.2	39.48	32.5	6.5	29.56	207	330	P	H
													H
													H
802.11a													
CH 157													
5785MHz		5633.6	48.73	-19.47	68.2	39.86	32.09	6.33	29.55	326	351	P	V
		5691	48.49	-50.07	98.56	39.51	32.17	6.36	29.55	326	351	P	V
		5718.2	50.37	-59.93	110.3	41.34	32.21	6.37	29.55	326	351	P	V
		5724.6	50.47	-70.82	121.29	41.44	32.21	6.37	29.55	326	351	P	V
	*	5785	107.25	-	-	98.13	32.29	6.39	29.56	326	351	P	V
	*	5785	100.34	-	-	91.22	32.29	6.39	29.56	326	351	A	V
		5850.8	48.62	-71.76	120.38	39.36	32.38	6.44	29.56	326	351	P	V
		5864.8	48.97	-59.08	108.05	39.67	32.41	6.45	29.56	326	351	P	V
		5909.2	49.76	-30.1	79.86	40.35	32.48	6.49	29.56	326	351	P	V
		5939.8	49.29	-18.91	68.2	39.81	32.53	6.51	29.56	326	351	P	V
													V
													V



WiFi Ant. 4+5	Note	Frequency (MHz)	Level (dBμV/m)	Over Limit (dB)	Limit Line (dBμV/m)	Read Level (dBμV)	Antenna Factor (dB/m)	Path Loss (dB)	Preamp Factor (dB)	Ant Pos (cm)	Table Pos (deg)	Peak Avg. (P/A)	Pol. (H/V)	
802.11a CH 165 5825MHz	*	5825	110.5	-	-	101.28	32.36	6.42	29.56	200	326	P	H	
	*	5825	103.32	-	-	94.1	32.36	6.42	29.56	200	326	A	H	
		5851.2	71.95	-47.51	119.46	62.69	32.38	6.44	29.56	200	326	P	H	
		5855.8	64.57	-46.01	110.58	55.28	32.41	6.44	29.56	200	326	P	H	
		5876.2	54.33	-49.98	104.31	45	32.43	6.46	29.56	200	326	P	H	
		5930	48.45	-19.75	68.2	39.01	32.5	6.5	29.56	200	326	P	H	
														H
														H
	*	5825	106.97	-	-	97.75	32.36	6.42	29.56	321	349	P	V	
	*	5825	99.47	-	-	90.25	32.36	6.42	29.56	321	349	A	V	
		5852.4	62.56	-54.17	116.73	53.3	32.38	6.44	29.56	321	349	P	V	
		5863	59.07	-49.49	108.56	49.77	32.41	6.45	29.56	321	349	P	V	
		5880	50.25	-51.24	101.49	40.92	32.43	6.46	29.56	321	349	P	V	
		5949.8	48.37	-19.83	68.2	38.88	32.53	6.52	29.56	321	349	P	V	
														V
														V
														V
	Remark	1. No other spurious found. 2. All results are PASS against Peak and Average limit line.												



Band 4 5725~5850MHz
WIFI 802.11a (Harmonic @ 3m)

WIFI Ant. 4+5	Note	Frequency (MHz)	Level (dBμV/m)	Over Limit (dB)	Limit Line (dBμV/m)	Read Level (dBμV)	Antenna Factor (dB/m)	Path Loss (dB)	Preamp Factor (dB)	Ant Pos (cm)	Table Pos (deg)	Peak Avg. (P/A)	Pol. (H/V)	
802.11a CH 149 5745MHz		11490	47.47	-26.53	74	53.39	39.92	10.46	56.3	100	0	P	H	
		17235	51.12	-17.08	68.2	53.9	40.84	12.95	56.57	100	0	P	H	
													H	
													H	
			11490	47.25	-26.75	74	53.17	39.92	10.46	56.3	100	0	P	V
			17235	50.41	-17.79	68.2	53.19	40.84	12.95	56.57	100	0	P	V
														V
802.11a CH 157 5785MHz		11570	45.8	-28.2	74	51.84	39.76	10.5	56.3	100	0	P	H	
		17355	51.34	-16.86	68.2	53.81	41.26	13.08	56.81	100	0	P	H	
													H	
													H	
			11570	45.6	-28.4	74	51.64	39.76	10.5	56.3	100	0	P	V
			17355	51.79	-16.41	68.2	54.26	41.26	13.08	56.81	100	0	P	V
														V
802.11a CH 165 5825MHz		11650	46.98	-27.02	74	53.12	39.62	10.54	56.3	100	0	P	H	
		17475	51.73	-16.47	68.2	53.89	41.68	13.21	57.05	100	0	P	H	
													H	
													H	
			11650	45.85	-28.15	74	51.99	39.62	10.54	56.3	100	0	P	V
			17475	51.76	-16.44	68.2	53.92	41.68	13.21	57.05	100	0	P	V
														V
Remark	1. No other spurious found.													
	2. All results are PASS against Peak and Average limit line.													



Band 4 5725~5850MHz
WIFI 802.11n HT20 (Band Edge @ 3m)

WIFI Ant. 4+5	Note	Frequency (MHz)	Level (dBμV/m)	Over Limit (dB)	Limit Line (dBμV/m)	Read Level (dBμV)	Antenna Factor (dB/m)	Path Loss (dB)	Preamp Factor (dB)	Ant Pos (cm)	Table Pos (deg)	Peak Avg. (P/A)	Pol. (H/V)	
802.11n HT20 CH 149 5745MHz		5629.8	49.32	-18.88	68.2	40.47	32.07	6.33	29.55	233	358	P	H	
		5699.8	55.82	-49.23	105.05	46.84	32.17	6.36	29.55	233	358	P	H	
		5720	69.02	-41.78	110.8	59.99	32.21	6.37	29.55	233	358	P	H	
		5724.4	81.92	-38.91	120.83	72.89	32.21	6.37	29.55	233	358	P	H	
	*	5745	110	-	-	100.93	32.24	6.38	29.55	233	358	P	H	
	*	5745	102.91	-	-	93.84	32.24	6.38	29.55	233	358	A	H	
														H
														H
			5620.6	49.1	-19.1	68.2	40.25	32.07	6.33	29.55	397	338	P	V
			5698.2	52.7	-51.17	103.87	43.72	32.17	6.36	29.55	397	338	P	V
			5720	67.29	-43.51	110.8	58.26	32.21	6.37	29.55	397	338	P	V
			5724.8	78.39	-43.35	121.74	69.36	32.21	6.37	29.55	397	338	P	V
	*		5745	107.81	-	-	98.74	32.24	6.38	29.55	397	338	P	V
	*		5745	100.31	-	-	91.24	32.24	6.38	29.55	397	338	A	V
													V	
													V	



WIFI Ant. 4+5	Note	Frequency (MHz)	Level (dBµV/m)	Over Limit (dB)	Limit Line (dBµV/m)	Read Level (dBµV)	Antenna Factor (dB/m)	Path Loss (dB)	Preamp Factor (dB)	Ant Pos (cm)	Table Pos (deg)	Peak Avg. (P/A)	Pol. (H/V)
		5628.4	48.81	-19.39	68.2	39.96	32.07	6.33	29.55	232	358	P	H
		5686.2	49.36	-45.66	95.02	40.39	32.17	6.35	29.55	232	358	P	H
		5704.8	51.67	-54.88	106.55	42.67	32.19	6.36	29.55	232	358	P	H
		5723.4	52.96	-65.59	118.55	43.93	32.21	6.37	29.55	232	358	P	H
	*	5785	110.37	-	-	101.25	32.29	6.39	29.56	232	358	P	H
	*	5785	103.37	-	-	94.25	32.29	6.39	29.56	232	358	A	H
		5853.2	50.56	-64.34	114.9	41.3	32.38	6.44	29.56	232	358	P	H
		5866.8	51	-56.49	107.49	41.7	32.41	6.45	29.56	232	358	P	H
		5923.6	49.25	-19.98	69.23	39.81	32.5	6.5	29.56	232	358	P	H
		5941	48.5	-19.7	68.2	39.02	32.53	6.51	29.56	232	358	P	H
802.11n													H
HT20													H
CH 157		5606	48.2	-20	68.2	39.39	32.04	6.32	29.55	392	340	P	V
5785MHz		5666.6	48.8	-31.72	80.52	39.86	32.14	6.35	29.55	392	340	P	V
		5717.4	49.03	-61.04	110.07	40.02	32.19	6.37	29.55	392	340	P	V
		5723.4	49.56	-68.99	118.55	40.53	32.21	6.37	29.55	392	340	P	V
	*	5785	107.3	-	-	98.18	32.29	6.39	29.56	392	340	P	V
	*	5785	100	-	-	90.88	32.29	6.39	29.56	392	340	A	V
		5852.4	47.89	-68.84	116.73	38.63	32.38	6.44	29.56	392	340	P	V
		5855.2	50.01	-60.73	110.74	40.72	32.41	6.44	29.56	392	340	P	V
		5916.8	49.58	-24.67	74.25	40.17	32.48	6.49	29.56	392	340	P	V
		5928.6	48.37	-19.83	68.2	38.93	32.5	6.5	29.56	392	340	P	V
													V
													V



WIFI Ant. 4+5	Note	Frequency (MHz)	Level (dBμV/m)	Over Limit (dB)	Limit Line (dBμV/m)	Read Level (dBμV)	Antenna Factor (dB/m)	Path Loss (dB)	Preamp Factor (dB)	Ant Pos (cm)	Table Pos (deg)	Peak Avg. (P/A)	Pol. (H/V)	
802.11n HT20 CH 165 5825MHz	*	5825	109.94	-	-	100.72	32.36	6.42	29.56	223	358	P	H	
	*	5825	103.05	-	-	93.83	32.36	6.42	29.56	223	358	A	H	
		5850	74.28	-47.92	122.2	65.02	32.38	6.44	29.56	223	358	P	H	
		5855	66.11	-44.69	110.8	56.82	32.41	6.44	29.56	223	358	P	H	
		5883.6	54.08	-44.73	98.81	44.74	32.43	6.47	29.56	223	358	P	H	
		5941.4	48.43	-19.77	68.2	38.95	32.53	6.51	29.56	223	358	P	H	
														H
														H
	*	5825	106.34	-	-	97.12	32.36	6.42	29.56	388	339	P	V	
	*	5825	99.16	-	-	89.94	32.36	6.42	29.56	388	339	A	V	
		5853.2	61.22	-53.68	114.9	51.96	32.38	6.44	29.56	388	339	P	V	
		5856.2	58.4	-52.06	110.46	49.11	32.41	6.44	29.56	388	339	P	V	
		5881.6	51.41	-48.89	100.3	42.07	32.43	6.47	29.56	388	339	P	V	
		5944	49.43	-18.77	68.2	39.94	32.53	6.52	29.56	388	339	P	V	
														V
													V	
Remark	1. No other spurious found. 2. All results are PASS against Peak and Average limit line.													



**Band 4 5725~5850MHz
WIFI 802.11n HT20 (Harmonic @ 3m)**

WIFI Ant. 4+5	Note	Frequency (MHz)	Level (dBµV/m)	Over Limit (dB)	Limit Line (dBµV/m)	Read Level (dBµV)	Antenna Factor (dB/m)	Path Loss (dB)	Preamp Factor (dB)	Ant Pos (cm)	Table Pos (deg)	Peak Avg. (P/A)	Pol. (H/V)	
802.11n HT20 CH 149 5745MHz		11490	46.96	-27.04	74	52.88	39.92	10.46	56.3	100	0	P	H	
		17235	48.48	-19.72	68.2	51.26	40.84	12.95	56.57	100	0	P	H	
													H	
													H	
			11490	46.34	-27.66	74	52.26	39.92	10.46	56.3	100	0	P	V
			17235	48.5	-19.7	68.2	51.28	40.84	12.95	56.57	100	0	P	V
														V
802.11n HT20 CH 157 5785MHz		11570	45.84	-28.16	74	51.88	39.76	10.5	56.3	100	0	P	H	
		17355	49.63	-18.57	68.2	52.1	41.26	13.08	56.81	100	0	P	H	
													H	
													H	
			11570	46.81	-27.19	74	52.85	39.76	10.5	56.3	100	0	P	V
			17355	50.01	-18.19	68.2	52.48	41.26	13.08	56.81	100	0	P	V
														V
802.11n HT20 CH 165 5825MHz		11650	45.37	-28.63	74	51.51	39.62	10.54	56.3	100	0	P	H	
		17475	49.62	-18.58	68.2	51.78	41.68	13.21	57.05	100	0	P	H	
													H	
													H	
			11650	46.08	-27.92	74	52.22	39.62	10.54	56.3	100	0	P	V
			17475	48.97	-19.23	68.2	51.13	41.68	13.21	57.05	100	0	P	V
														V
Remark	1. No other spurious found.													
	2. All results are PASS against Peak and Average limit line.													



Band 4 5725~5850MHz
WIFI 802.11n HT40 (Band Edge @ 3m)

WIFI Ant. 4+5	Note	Frequency (MHz)	Level (dBμV/m)	Over Limit (dB)	Limit Line (dBμV/m)	Read Level (dBμV)	Antenna Factor (dB/m)	Path Loss (dB)	Preamp Factor (dB)	Ant Pos (cm)	Table Pos (deg)	Peak Avg. (P/A)	Pol. (H/V)
		5649.2	53.13	-15.07	68.2	44.25	32.09	6.34	29.55	208	327	P	H
		5698.8	64.45	-39.87	104.32	55.47	32.17	6.36	29.55	208	327	P	H
		5715.2	80.24	-29.22	109.46	71.23	32.19	6.37	29.55	208	327	P	H
		5723.8	83.07	-36.39	119.46	74.04	32.21	6.37	29.55	208	327	P	H
	*	5755	108.21	-	-	99.13	32.26	6.38	29.56	208	327	P	H
	*	5755	101.21	-	-	92.13	32.26	6.38	29.56	208	327	A	H
		5850	52.56	-69.64	122.2	43.3	32.38	6.44	29.56	208	327	P	H
		5866	52.24	-55.48	107.72	42.94	32.41	6.45	29.56	208	327	P	H
		5886.8	50.29	-46.15	96.44	40.95	32.43	6.47	29.56	208	327	P	H
		5925.8	48.8	-19.4	68.2	39.36	32.5	6.5	29.56	208	327	P	H
802.11n													H
HT40													H
CH 151		5648.2	51.03	-17.17	68.2	42.15	32.09	6.34	29.55	398	342	P	V
5755MHz		5697.4	60.08	-43.2	103.28	51.1	32.17	6.36	29.55	398	342	P	V
		5720	77.02	-33.78	110.8	67.99	32.21	6.37	29.55	398	342	P	V
		5722	79.11	-36.25	115.36	70.08	32.21	6.37	29.55	398	342	P	V
	*	5755	105.82	-	-	96.74	32.26	6.38	29.56	398	342	P	V
	*	5755	98.67	-	-	89.59	32.26	6.38	29.56	398	342	A	V
		5850	49.63	-72.57	122.2	40.37	32.38	6.44	29.56	398	342	P	V
		5855.4	49.73	-60.96	110.69	40.44	32.41	6.44	29.56	398	342	P	V
		5923	49.72	-19.95	69.67	40.28	32.5	6.5	29.56	398	342	P	V
		5932.6	48.84	-19.36	68.2	39.39	32.5	6.51	29.56	398	342	P	V
													V
													V



WIFI Ant. 4+5	Note	Frequency (MHz)	Level (dBμV/m)	Over Limit (dB)	Limit Line (dBμV/m)	Read Level (dBμV)	Antenna Factor (dB/m)	Path Loss (dB)	Preamp Factor (dB)	Ant Pos (cm)	Table Pos (deg)	Peak Avg. (P/A)	Pol. (H/V)
		5648.8	49.79	-18.41	68.2	40.91	32.09	6.34	29.55	201	325	P	H
		5693	55.57	-44.47	100.04	46.59	32.17	6.36	29.55	201	325	P	H
		5711.6	63.05	-45.4	108.45	54.05	32.19	6.36	29.55	201	325	P	H
		5724.2	60.15	-60.23	120.38	51.12	32.21	6.37	29.55	201	325	P	H
	*	5795	107.99	-	-	98.84	32.31	6.4	29.56	201	325	P	H
	*	5795	101.18	-	-	92.03	32.31	6.4	29.56	201	325	A	H
		5852	67.9	-49.74	117.64	58.64	32.38	6.44	29.56	201	325	P	H
		5855.2	63.59	-47.15	110.74	54.3	32.41	6.44	29.56	201	325	P	H
		5890.2	57.34	-36.58	93.92	47.97	32.46	6.47	29.56	201	325	P	H
		5927.8	51.86	-16.34	68.2	42.42	32.5	6.5	29.56	201	325	P	H
802.11n													H
HT40													H
CH 159		5646.2	49.21	-18.99	68.2	40.33	32.09	6.34	29.55	389	342	P	V
5795MHz		5699.2	54.49	-50.12	104.61	45.51	32.17	6.36	29.55	389	342	P	V
		5716.8	58.09	-51.82	109.91	49.08	32.19	6.37	29.55	389	342	P	V
		5720	56.9	-53.9	110.8	47.87	32.21	6.37	29.55	389	342	P	V
	*	5795	104.64	-	-	95.49	32.31	6.4	29.56	389	342	P	V
	*	5795	97.8	-	-	88.65	32.31	6.4	29.56	389	342	A	V
		5855	58.7	-52.1	110.8	49.41	32.41	6.44	29.56	389	342	P	V
		5855	58.7	-52.1	110.8	49.41	32.41	6.44	29.56	389	342	P	V
		5881.4	54.88	-45.57	100.45	45.54	32.43	6.47	29.56	389	342	P	V
		5947.6	48.65	-19.55	68.2	39.16	32.53	6.52	29.56	389	342	P	V
													V
													V
Remark	1. No other spurious found. 2. All results are PASS against Peak and Average limit line.												



**Band 4 5725~5850MHz
WIFI 802.11n HT40 (Harmonic @ 3m)**

WIFI Ant. 4+5	Note	Frequency (MHz)	Level (dBµV/m)	Over Limit (dB)	Limit Line (dBµV/m)	Read Level (dBµV)	Antenna Factor (dB/m)	Path Loss (dB)	Preamp Factor (dB)	Ant Pos (cm)	Table Pos (deg)	Peak Avg. (P/A)	Pol. (H/V)
802.11n HT40 CH 151 5755MHz		11510	46.65	-27.35	74	52.58	39.9	10.47	56.3	100	0	P	H
		17265	48.4	-19.8	68.2	51.09	40.96	12.98	56.63	100	0	P	H
													H
													H
		11510	46.76	-27.24	74	52.69	39.9	10.47	56.3	100	0	P	V
		17265	49.1	-19.1	68.2	51.79	40.96	12.98	56.63	100	0	P	V
													V
													V
802.11n HT40 CH 159 5795MHz		11590	45.59	-28.41	74	51.65	39.73	10.51	56.3	100	0	P	H
		17385	50.35	-17.85	68.2	52.73	41.38	13.11	56.87	100	0	P	H
													H
													H
		11590	45.95	-28.05	74	52.01	39.73	10.51	56.3	100	0	P	V
		17385	49.66	-18.54	68.2	52.04	41.38	13.11	56.87	100	0	P	V
													V
													V
Remark	1. No other spurious found. 2. All results are PASS against Peak and Average limit line.												



Band 4 5725~5850MHz
WIFI 802.11ac VHT80 (Band Edge @ 3m)

WIFI Ant. 4+5	Note	Frequency (MHz)	Level (dBμV/m)	Over Limit (dB)	Limit Line (dBμV/m)	Read Level (dBμV)	Antenna Factor (dB/m)	Path Loss (dB)	Preamp Factor (dB)	Ant Pos (cm)	Table Pos (deg)	Peak Avg. (P/A)	Pol. (H/V)	
		5639	64.55	-3.65	68.2	55.67	32.09	6.34	29.55	202	326	P	H	
		5692.2	79.39	-20.06	99.45	70.41	32.17	6.36	29.55	202	326	P	H	
		5718.8	84.09	-26.37	110.46	75.06	32.21	6.37	29.55	202	326	P	H	
		5723.4	82.66	-35.89	118.55	73.63	32.21	6.37	29.55	202	326	P	H	
	*	5775	105.45	-	-	96.33	32.29	6.39	29.56	202	326	P	H	
	*	5775	98.18	-	-	89.06	32.29	6.39	29.56	202	326	A	H	
		5850	80.52	-41.68	122.2	71.26	32.38	6.44	29.56	202	326	P	H	
		5855	76.53	-34.27	110.8	67.24	32.41	6.44	29.56	202	326	P	H	
		5878.8	69.1	-33.28	102.38	59.77	32.43	6.46	29.56	202	326	P	H	
		5928.6	60	-8.2	68.2	50.56	32.5	6.5	29.56	202	326	P	H	
802.11ac VHT80 CH 155 5775MHz													H	
													H	
			5641.8	59.81	-8.39	68.2	50.93	32.09	6.34	29.55	374	343	P	V
			5698.8	75.02	-29.3	104.32	66.04	32.17	6.36	29.55	374	343	P	V
			5718.8	78.78	-31.68	110.46	69.75	32.21	6.37	29.55	374	343	P	V
			5720.8	79.02	-33.6	112.62	69.99	32.21	6.37	29.55	374	343	P	V
		*	5775	101.57	-	-	92.45	32.29	6.39	29.56	374	343	P	V
		*	5775	94.99	-	-	85.87	32.29	6.39	29.56	374	343	A	V
			5854.6	70.63	-41.08	111.71	61.34	32.41	6.44	29.56	374	343	P	V
			5857.2	70.94	-39.24	110.18	61.64	32.41	6.45	29.56	374	343	P	V
			5876.4	67.98	-36.18	104.16	58.65	32.43	6.46	29.56	374	343	P	V
			5936.8	53.79	-14.41	68.2	44.34	32.5	6.51	29.56	374	343	P	V
														V
														V
	Remark	1. No other spurious found. 2. All results are PASS against Peak and Average limit line.												



**Band 4 5725~5850MHz
WIFI 802.11ac VHT80 (Harmonic @ 3m)**

WIFI Ant. 4+5	Note	Frequency (MHz)	Level (dBμV/m)	Over Limit (dB)	Limit Line (dBμV/m)	Read Level (dBμV)	Antenna Factor (dB/m)	Path Loss (dB)	Preamp Factor (dB)	Ant Pos (cm)	Table Pos (deg)	Peak Avg. (P/A)	Pol. (H/V)	
802.11ac VHT80 CH 155 5775MHz		11550	46.34	-27.66	74	52.35	39.8	10.49	56.3	100	0	P	H	
		17325	49.82	-18.38	68.2	52.39	41.14	13.04	56.75	100	0	P	H	
													H	
													H	
			11550	45.33	-28.67	74	51.34	39.8	10.49	56.3	100	0	P	V
			17325	49.16	-19.04	68.2	51.73	41.14	13.04	56.75	100	0	P	V
														V
														V
Remark	1. No other spurious found. 2. All results are PASS against Peak and Average limit line.													



<WPC Charging Mode>

Band 4 - 5725~5850MHz

WIFI 802.11ac VHT80 (Band Edge @ 3m)

WIFI Ant.	Note	Frequency	Level	Over Limit	Limit Line	Read Level	Antenna Factor	Path Loss	Preamp Factor	Ant Pos	Table Pos	Peak Avg.	Pol.
4+5		(MHz)	(dBμV/m)	(dB)	(dBμV/m)	(dBμV)	(dB/m)	(dB)	(dB)	(cm)	(deg)	(P/A)	(H/V)
		5648.6	59.12	-9.08	68.2	50.24	32.09	6.34	29.55	118	29	P	H
		5698.6	76.76	-27.41	104.17	67.78	32.17	6.36	29.55	118	29	P	H
		5719.2	79.41	-31.17	110.58	70.38	32.21	6.37	29.55	118	29	P	H
		5723.2	81.1	-37	118.1	72.07	32.21	6.37	29.55	118	29	P	H
	*	5775	104.15	-	-	95.03	32.29	6.39	29.56	118	29	P	H
	*	5775	96.76	-	-	87.64	32.29	6.39	29.56	118	29	A	H
		5851.4	71.87	-47.14	119.01	62.61	32.38	6.44	29.56	118	29	P	H
		5863.4	73.16	-35.29	108.45	63.86	32.41	6.45	29.56	118	29	P	H
		5880.6	64.55	-36.49	101.04	55.22	32.43	6.46	29.56	118	29	P	H
		5938	51.91	-16.29	68.2	42.46	32.5	6.51	29.56	118	29	P	H
802.11ac													H
VHT80													H
CH 155		5643.8	61.26	-6.94	68.2	52.38	32.09	6.34	29.55	161	21	P	V
5775MHz		5690	75.44	-22.39	97.83	66.46	32.17	6.36	29.55	161	21	P	V
		5719	81.52	-29	110.52	72.49	32.21	6.37	29.55	161	21	P	V
		5724	80.5	-39.42	119.92	71.47	32.21	6.37	29.55	161	21	P	V
	*	5775	105.62	-	-	96.5	32.29	6.39	29.56	161	21	P	V
	*	5775	98.3	-	-	89.18	32.29	6.39	29.56	161	21	A	V
		5850	78.04	-44.16	122.2	68.78	32.38	6.44	29.56	161	21	P	V
		5868.4	75.69	-31.36	107.05	66.39	32.41	6.45	29.56	161	21	P	V
		5875	67.61	-37.59	105.2	58.28	32.43	6.46	29.56	161	21	P	V
		5926.4	56.26	-11.94	68.2	46.82	32.5	6.5	29.56	161	21	P	V
													V
													V
Remark	1. No other spurious found. 2. All results are PASS against Peak and Average limit line.												



**Band 4 5725~5850MHz
WIFI 802.11ac VHT80 (Harmonic @ 3m)**

WIFI Ant. 4+5	Note	Frequency (MHz)	Level (dBµV/m)	Over Limit (dB)	Limit Line (dBµV/m)	Read Level (dBµV)	Antenna Factor (dB/m)	Path Loss (dB)	Preamp Factor (dB)	Ant Pos (cm)	Table Pos (deg)	Peak Avg. (P/A)	Pol. (H/V)	
802.11ac VHT80 CH 155 5775MHz		11550	45.87	-28.13	74	51.88	39.8	10.49	56.3	100	0	P	H	
		17325	49.17	-19.03	68.2	51.74	41.14	13.04	56.75	100	0	P	H	
													H	
													H	
			11550	45.56	-28.44	74	51.57	39.8	10.49	56.3	100	0	P	V
			17325	49.43	-18.77	68.2	52	41.14	13.04	56.75	100	0	P	V
														V
														V
Remark	1. No other spurious found. 2. All results are PASS against Peak and Average limit line.													



Emission below 1GHz

5GHz WIFI 802.11ac VHT80 (LF @ 3m)

WIFI	Note	Frequency	Level	Over	Limit	Read	Antenna	Path	Preamp	Ant	Table	Peak	Pol.	
Ant.				Limit	Line	Level	Factor	Loss	Factor	Pos	Pos	Avg.		
4+5		(MHz)	(dBμV/m)	(dB)	(dBμV/m)	(dBμV)	(dB/m)	(dB)	(dB)	(cm)	(deg)	(P/A)	(H/V)	
5GHz 802.11ac VHT80 LF		30	23.31	-16.69	40	30.44	24.7	0.45	32.29	-	-	P	H	
		129.91	32.26	-11.24	43.5	46.17	17.3	0.91	32.19	100	0	P	H	
		183.26	32.05	-11.45	43.5	48.52	14.5	1.07	32.15	-	-	P	H	
		316.15	27.07	-18.93	46	38.61	19.12	1.4	32.15	-	-	P	H	
		831.22	33.27	-12.73	46	34.14	28.32	2.39	31.74	-	-	P	H	
		946.65	33.78	-12.22	46	31.83	30.3	2.45	31.01	-	-	P	H	
														H
														H
														H
														H
														H
														H
														H
			39.7	33.2	-6.8	40	45.36	19.61	0.48	32.29	100	0	P	V
			62.98	31.84	-8.16	40	51.99	11.5	0.59	32.27	-	-	P	V
			124.09	29.71	-13.79	43.5	43.74	17.2	0.89	32.19	-	-	P	V
			676.99	29.8	-16.2	46	33.65	26.04	2.11	32.12	-	-	P	V
			835.1	33.02	-12.98	46	33.77	28.4	2.41	31.72	-	-	P	V
		882.63	33.22	-12.78	46	33.49	28.6	2.45	31.49	-	-	P	V	
													V	
													V	
													V	
													V	
													V	
													V	
Remark	1. No other spurious found. 2. All results are PASS against limit line.													



Note symbol

*	Fundamental Frequency which can be ignored. However, the level of any unwanted emissions shall not exceed the level of the fundamental frequency.
!	Test result is over limit line.
P/A	Peak or Average
H/V	Horizontal or Vertical



A calculation example for radiated spurious emission is shown as below:

WIFI	Note	Frequency	Level	Over	Limit	Read	Antenna	Path	Preamp	Ant	Table	Peak	Pol.
Ant.				Limit	Line	Level	Factor	Loss	Factor	Pos	Pos	Avg.	
4+5		(MHz)	(dBμV/m)	(dB)	(dBμV/m)	(dBμV)	(dB/m)	(dB)	(dB)	(cm)	(deg)	(P/A)	(H/V)
802.11b		2390	55.45	-18.55	74	54.51	32.22	4.58	35.86	103	308	P	H
CH 01													
2412MHz		2390	43.54	-10.46	54	42.6	32.22	4.58	35.86	103	308	A	H

1. Path Loss(dB) = Cable loss(dB) + Filter loss(dB) + Attenuator loss(dB)
2. Level(dBμV/m) = Antenna Factor(dB/m) + Path Loss(dB) + Read Level(dBμV) - Preamp Factor(dB)
3. Over Limit(dB) = Level(dBμV/m) – Limit Line(dBμV/m)

For Peak Limit @ 2390MHz:

1. Level(dBμV/m)
= Antenna Factor(dB/m) + Path Loss(dB) + Read Level(dBμV) - Preamp Factor(dB)
= 32.22(dB/m) + 4.58(dB) + 54.51(dBμV) – 35.86 (dB)
= 55.45 (dBμV/m)
2. Over Limit(dB)
= Level(dBμV/m) – Limit Line(dBμV/m)
= 55.45(dBμV/m) – 74(dBμV/m)
= -18.55(dB)

For Average Limit @ 2390MHz:

1. Level(dBμV/m)
= Antenna Factor(dB/m) + Path Loss(dB) + Read Level(dBμV) - Preamp Factor(dB)
= 32.22(dB/m) + 4.58(dB) + 42.6(dBμV) – 35.86 (dB)
= 43.54 (dBμV/m)
2. Over Limit(dB) = Level(dBμV/m) – Limit Line(dBμV/m)
= 43.54(dBμV/m) – 54(dBμV/m)
= -10.46(dB)

Both peak and average measured complies with the limit line, so test result is “PASS”.



Appendix D. Radiated Spurious Emission Plots

Test Engineer :	Andy Yang, JC Liang and Wilson Wu	Temperature :	25~25°C
		Relative Humidity :	48~50%

<Adapter Mode>

Band 4 - 5725~5850MHz
WIFI 802.11a (Band Edge @ 3m)

WIFI	Band 4 5725~5850MHz Band Edge @ 3m	
ANT	802.11a CH149 5745MHz	
4+5	Horizontal	Fundamental
Peak	<p>Site : 03CH13-HY Condition : PEAK_BE(84)_16-24 3m HORN_91200_1241 HORIZONTAL Detector : Peak Project : 8N0620-05 Mode : 36 Power : 21</p>	<p>Site : 03CH13-HY Condition : PEAK(UNIT) 3m HORN_91200_1241 HORIZONTAL Detector : Peak Project : 8N0620-05 Mode : 36 Power : 21</p>

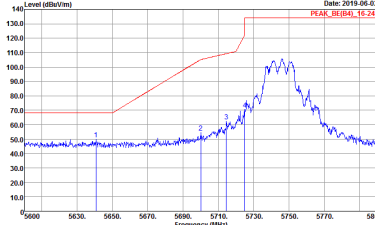
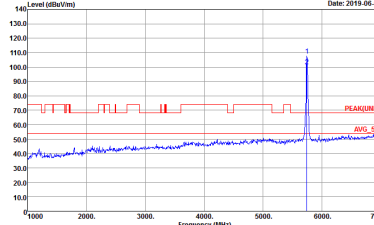

WIFI	Band 4 5725~5850MHz Band Edge @ 3m	
ANT	802.11a CH149 5745MHz	
4+5	Vertical	Fundamental
Peak	 <p>Date: 2019-06-02 PEAK: 8E(84)_16-24</p> <p>Site : 03CH13-HY Condition : PEAK_8E(84)_16-24 3m HORN_91200_1241 VERTICAL RBW:1000.000KHz VBW:3000.000KHz SWT:Auto Detector : Peak Project : 8N0620-05 Mode : 36 Power : 21</p>	 <p>Date: 2019-06-02 PEAK: UN(II)_3m</p> <p>Site : 03CH13-HY Condition : PEAK(UN(II)) 3m HORN_91200_1241 VERTICAL RBW:1000.000KHz VBW:3000.000KHz SWT:Auto Detector : Peak Project : 8N0620-05 Mode : 36 Power : 21</p>



WIFI	Band 4 5725~5850MHz Band Edge @ 3m	
ANT	802.11a CH157 5785MHz	
4+5	Horizontal	Fundamental
Peak	<p>Site : 03CH13-HY Condition : PEAK_BE(B4)_16-24 3m HORN_91200_1241 HORIZONTAL Detector : Peak Project : 8N0620-05 Mode : 37 Power : 21.5</p>	<p>Site : 03CH13-HY Condition : PEAK(UNII) 3m HORN_91200_1241 HORIZONTAL Detector : Peak Project : 8N0620-05 Mode : 37 Power : 21.5</p>
Peak	<p>Site : 03CH13-HY Condition : PEAK_BE(B4)_16-24 3m HORN_91200_1241 HORIZONTAL Detector : Peak Project : 8N0620-05 Mode : 37 Power : 21.5</p>	Left blank



WIFI	Band 4 5725~5850MHz Band Edge @ 3m	
ANT	802.11a CH157 5785MHz	
4+5	Vertical	Fundamental
Peak	<p>Site : 03CH13-HY Condition : PEAK_BE(B4)_16-24 3m HORN_91200_1241 VERTICAL RBW:1000.000KHz VBW:3000.000KHz SWT:Auto Detector : Peak Project : 8N0620-05 Mode : 37 Power : 21.5</p>	<p>Site : 03CH13-HY Condition : PEAK(UNII) 3m HORN_91200_1241 VERTICAL RBW:1000.000KHz VBW:3000.000KHz SWT:Auto Detector : Peak Project : 8N0620-05 Mode : 37 Power : 21.5</p>
Peak	<p>Site : 03CH13-HY Condition : PEAK_BE(B4)_16-24 3m HORN_91200_1241 VERTICAL RBW:1000.000KHz VBW:3000.000KHz SWT:Auto Detector : Peak Project : 8N0620-05 Mode : 37 Power : 21.5</p>	Left blank

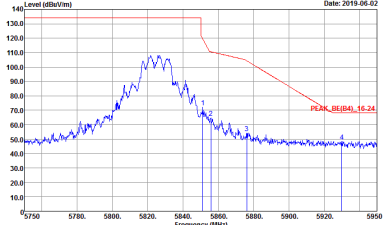
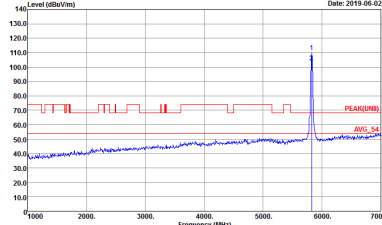

WIFI	Band 4 5725~5850MHz Band Edge @ 3m	
ANT	802.11a CH165 5825MHz	
4+5	Horizontal	Fundamental
Peak	 <p>Site : 03CH13-HY Condition : PEAK_BE(B4)_16-24 3m HORN_91200_1241 HORIZONTAL RBW:1000.000KHz VBW:3000.000KHz SWT:Auto Detector : Peak Project : 8N0620-05 Mode : 38 Power : 21.5</p>	 <p>Site : 03CH13-HY Condition : PEAK(U)B 3m HORN_91200_1241 HORIZONTAL RBW:1000.000KHz VBW:3000.000KHz SWT:Auto Detector : Peak Project : 8N0620-05 Mode : 38 Power : 21.5</p>

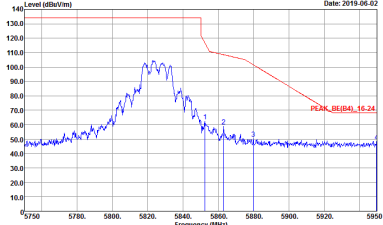
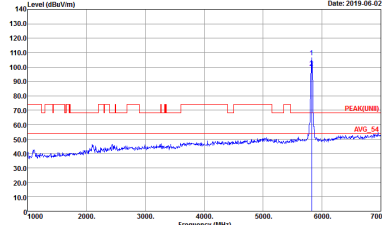

WIFI	Band 4 5725~5850MHz Band Edge @ 3m	
ANT	802.11a CH165 5825MHz	
4+5	Vertical	Fundamental
Peak	 <p>Site : 03CH13-HY Condition : PEAK_8E(84)_16-24 3m HORN_91200_1241 VERTICAL RBW:1000.000KHz VBW:3000.000KHz SWT:Auto Detector : Peak Project : 8N0620-05 Mode : 38 Power : 21.5</p>	 <p>Site : 03CH13-HY Condition : PEAK(UNII) 3m HORN_91200_1241 VERTICAL RBW:1000.000KHz VBW:3000.000KHz SWT:Auto Detector : Peak Project : 8N0620-05 Mode : 38 Power : 21.5</p>



Band 4 5725~5850MHz
WIFI 802.11n HT20 (Band Edge @ 3m)

WIFI	Band 4 5725~5850MHz Band Edge @ 3m	
ANT	802.11n HT20 CH149 5745MHz	
4+5	Horizontal	Fundamental
Peak	<p>Site : 03CH13-HY Condition : PEAK_BE(B4)_16-24 3m HORN_91200_1241 HORIZONTAL Detector : Peak Project : 8N0620-05 Mode : 39 Power : 21</p>	<p>Site : 03CH13-HY Condition : PEAK(UNI) 3m HORN_91200_1241 HORIZONTAL Detector : Peak Project : 8N0620-05 Mode : 39 Power : 21</p>



WIFI	Band 4 5725-5850MHz Band Edge @ 3m	
ANT	802.11n HT20 CH149 5745MHz	
4+5	Vertical	Fundamental
Peak	<p>Date: 2019-06-02 PEAK: 8E(84)_16-24</p> <p>Site : 03CH13-HY Condition : PEAK_8E(84)_16-24 3m HORN_91200_1241 VERTICAL RBW:1000.000KHz VBW:3000.000KHz SWT:Auto Detector : Peak Project : 8N0620-05 Mode : 39 Power : 21</p>	<p>Date: 2019-06-02 PEAK: 8E(84)_16-24</p> <p>Site : 03CH13-HY Condition : PEAK(UNII) 3m HORN_91200_1241 VERTICAL RBW:1000.000KHz VBW:3000.000KHz SWT:Auto Detector : Peak Project : 8N0620-05 Mode : 39 Power : 21</p>



WIFI	Band 4 5725~5850MHz Band Edge @ 3m	
ANT	802.11n HT20 CH157 5785MHz	
4+5	Horizontal	Fundamental
<p>Peak</p>	<p>Date: 2019-06-02 PEAK_BE(04)_15-21</p> <p>Site : 03CH13-HY Condition : PEAK_BE(04)_16-24 3m HORN_91200_1241 HORIZONTAL Detector : Peak Project : BN0620-05 Mode : 40 Power : 21.5</p>	<p>Date: 2019-06-02 PEAK(04)</p> <p>Site : 03CH13-HY Condition : PEAK(UNII) 3m HORN_91200_1241 HORIZONTAL Detector : Peak Project : BN0620-05 Mode : 40 Power : 21.5</p>
<p>Peak</p>	<p>Date: 2019-06-02 PEAK_BE(04)_15-24</p> <p>Site : 03CH13-HY Condition : PEAK_BE(04)_16-24 3m HORN_91200_1241 HORIZONTAL Detector : Peak Project : BN0620-05 Mode : 40 Power : 21.5</p>	<p>Left blank</p>

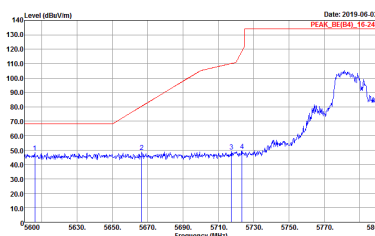
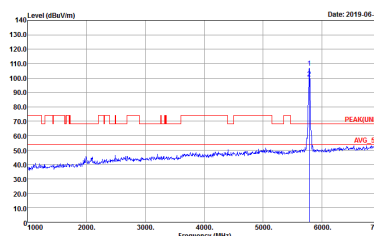
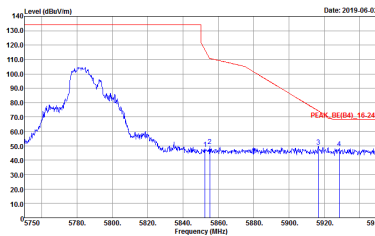

WIFI	Band 4 5725~5850MHz Band Edge @ 3m	
ANT	802.11n HT20 CH157 5785MHz	
4+5	Vertical	Fundamental
<p>Peak</p>	 <p>Date: 2019-06-02 PEAK_BE(84)_16-24</p> <p>Site : 03CH13-HY Condition : PEAK_BE(84)_16-24 3m HORN_91200_1241 VERTICAL RBW:1000.000kHz VBW:3000.000kHz SWT:Auto Detector : Peak Project : 8N0620-05 Mode : 40 Power : 21.5</p>	 <p>Date: 2019-06-02 PEAK_BE(84)_16-24</p> <p>Site : 03CH13-HY Condition : PEAK(UNII) 3m HORN_91200_1241 VERTICAL RBW:1000.000kHz VBW:3000.000kHz SWT:Auto Detector : Peak Project : 8N0620-05 Mode : 40 Power : 21.5</p>
<p>Peak</p>	 <p>Date: 2019-06-02 PEAK_BE(84)_16-24</p> <p>Site : 03CH13-HY Condition : PEAK_BE(84)_16-24 3m HORN_91200_1241 VERTICAL RBW:1000.000kHz VBW:3000.000kHz SWT:Auto Detector : Peak Project : 8N0620-05 Mode : 40 Power : 21.5</p>	<p>Left blank</p>



WIFI	Band 4 5725~5850MHz Band Edge @ 3m	
ANT	802.11n HT20 CH165 5825MHz	
4+5	Horizontal	Fundamental
Peak	<p>Site : 03CH13-HY Condition : PEAK_BE(B4)_16-24 3m HORN_91200_1241 HORIZONTAL Detector : Peak Project : 8N0620-05 Mode : 41 Power : 21.5</p>	<p>Site : 03CH13-HY Condition : PEAK(FB) 3m HORN_91200_1241 HORIZONTAL Detector : Peak Project : 8N0620-05 Mode : 41 Power : 21.5</p>



WIFI	Band 4 5725~5850MHz Band Edge @ 3m	
ANT	802.11n HT20 CH165 5825MHz	
4+5	Vertical	Fundamental
Peak	<p>Site : 03CH13-HY Condition : PEAK_BE(B4)_16-24 3m HORN_91200_1241 VERTICAL RBW:1000.000KHz VBW:3000.000KHz SWT:Auto Detector : Peak Project : 8N0620-05 Mode : 41 Power : 21.5</p>	<p>Site : 03CH13-HY Condition : PEAK(U)B 3m HORN_91200_1241 VERTICAL RBW:1000.000KHz VBW:3000.000KHz SWT:Auto Detector : Peak Project : 8N0620-05 Mode : 41 Power : 21.5</p>

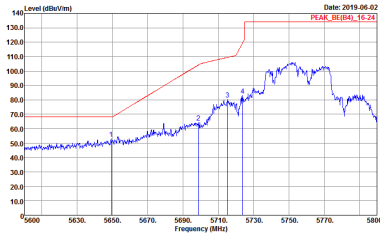
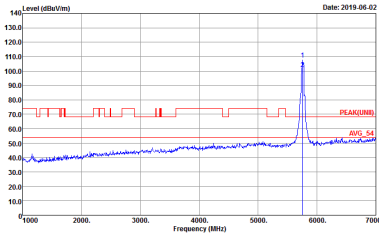
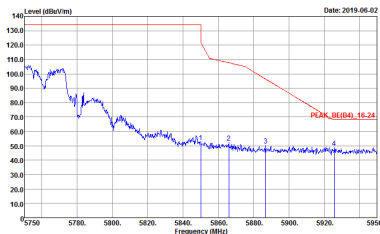

**Band 4 5725~5850MHz
WIFI 802.11n HT40 (Band Edge @ 3m)**

WIFI	Band 4 5725~5850MHz Band Edge @ 3m	
ANT	802.11n HT40 CH151 5755MHz	
4+5	Horizontal	Fundamental
<p align="center">Peak</p>	 <p>Date: 2019-06-02 PEAK_BE(84)_16-24</p> <p>Site : 03CH13-HY Condition : PEAK_BE(84)_16-24 3m HORN_91200_1241 HORIZONTAL RBW:1000.000KHz VBW:3000.000KHz SWT:Auto Detector : Peak Project : BN0620-05 Mode : 42 Power : 20.5</p>	 <p>Date: 2019-06-02 PEAK(UNIT) AVG_54</p> <p>Site : 03CH13-HY Condition : PEAK(UNIT) 3m HORN_91200_1241 HORIZONTAL RBW:1000.000KHz VBW:3000.000KHz SWT:Auto Detector : Peak Project : BN0620-05 Mode : 42 Power : 20.5</p>
<p align="center">Peak</p>	 <p>Date: 2019-06-02 PEAK_BE(84)_16-24</p> <p>Site : 03CH13-HY Condition : PEAK_BE(84)_16-24 3m HORN_91200_1241 HORIZONTAL RBW:1000.000KHz VBW:3000.000KHz SWT:Auto Detector : Peak Project : BN0620-05 Mode : 42 Power : 20.5</p>	<p align="center">Left blank</p>



WIFI	Band 4 5725~5850MHz Band Edge @ 3m	
ANT	802.11n HT40 CH151 5755MHz	
4+5	Vertical	Fundamental
Peak	<p>Site : 03CH13-HY Condition : PEAK_BE(B4)_16-24 3m HORN_91200_1241 VERTICAL Detector : Peak Project : 8N0620-05 Mode : 42 Power : 20.5</p>	<p>Site : 03CH13-HY Condition : PEAK(UNII) 3m HORN_91200_1241 VERTICAL Detector : Peak Project : 8N0620-05 Mode : 42 Power : 20.5</p>
Peak	<p>Site : 03CH13-HY Condition : PEAK_BE(B4)_16-24 3m HORN_91200_1241 VERTICAL Detector : Peak Project : 8N0620-05 Mode : 42 Power : 20.5</p>	Left blank



WIFI	Band 4 5725~5850MHz Band Edge @ 3m	
ANT	802.11n HT40 CH159 5795MHz	
4+5	Horizontal	Fundamental
Peak	<p>Site : 03CH13-HY Condition : PEAK_BE(84)_16-24 3m HORN_91200_1241 HORIZONTAL RBW:1000.000KHz VBW:3000.000KHz SWT:Auto Detector : Peak Project : 8N0620-05 Mode : 43 Power : 21</p>	<p>Site : 03CH13-HY Condition : PEAK(UNII) 3m HORN_91200_1241 HORIZONTAL RBW:1000.000KHz VBW:3000.000KHz SWT:Auto Detector : Peak Project : 8N0620-05 Mode : 43 Power : 21</p>
Peak	<p>Site : 03CH13-HY Condition : PEAK_BE(84)_16-24 3m HORN_91200_1241 HORIZONTAL RBW:1000.000KHz VBW:3000.000KHz SWT:Auto Detector : Peak Project : 8N0620-05 Mode : 43 Power : 21</p>	Left blank



WIFI	Band 4 5725~5850MHz Band Edge @ 3m	
ANT	802.11n HT40 CH159 5795MHz	
4+5	Vertical	Fundamental
Peak	<p>Site : 03CH13-HY Condition : PEAK_BE(B4)_16-24 3m HORN_91200_1241 VERTICAL RBW:1000.000KHz VBW:3000.000KHz SWT:Auto Detector : Peak Project : 8N0620-05 Mode : 43 Power : 21</p>	<p>Site : 03CH13-HY Condition : PEAK(UNII) 3m HORN_91200_1241 VERTICAL RBW:1000.000KHz VBW:3000.000KHz SWT:Auto Detector : Peak Project : 8N0620-05 Mode : 43 Power : 21</p>
Peak	<p>Site : 03CH13-HY Condition : PEAK_BE(B4)_16-24 3m HORN_91200_1241 VERTICAL RBW:1000.000KHz VBW:3000.000KHz SWT:Auto Detector : Peak Project : 8N0620-05 Mode : 43 Power : 21</p>	Left blank



Band 4 5725~5850MHz
WIFI 802.11ac VHT80 (Band Edge @ 3m)

WIFI	Band 4 5725~5850MHz Band Edge @ 3m	
ANT	802.11ac VHT80 CH155 5775MHz	
4+5	Horizontal	Fundamental
Peak	<p>Site : 03CH13-HY Condition : PEAK_BE(B4)_16-24 3m HORN_91200_1241 HORIZONTAL Detector : Peak Project : 8N0620-05 Mode : 44 Power : 20.5</p>	<p>Site : 03CH13-HY Condition : PEAK(UNIT) 3m HORN_91200_1241 HORIZONTAL Detector : Peak Project : 8N0620-05 Mode : 44 Power : 20.5</p>
Peak	<p>Site : 03CH13-HY Condition : PEAK_BE(B4)_16-24 3m HORN_91200_1241 HORIZONTAL Detector : Peak Project : 8N0620-05 Mode : 44 Power : 20.5</p>	Left blank



WIFI	Band 4 5725~5850MHz Band Edge @ 3m	
ANT	802.11ac VHT80 CH155 5775MHz	
4+5	Vertical	Fundamental
<p>Peak</p>	<p>Date: 2019-06-02 PEAK_BE(04)_15-21</p> <p>Site : 03CH13-HY Condition : PEAK_BE(04)_16-24 3m HORN_91200_1241 VERTICAL RBW:1000.000KHz VBW:3000.000KHz SWT:Auto Detector : Peak Project : 8N0620-05 Mode : 44 Power : 20.5</p>	<p>Date: 2019-06-02 PEAK_BE(04)_15-21</p> <p>Site : 03CH13-HY Condition : PEAK_BE(04)_16-24 3m HORN_91200_1241 VERTICAL RBW:1000.000KHz VBW:3000.000KHz SWT:Auto Detector : Peak Project : 8N0620-05 Mode : 44 Power : 20.5</p>
<p>Peak</p>	<p>Date: 2019-06-02 PEAK_BE(04)_16-24</p> <p>Site : 03CH13-HY Condition : PEAK_BE(04)_16-24 3m HORN_91200_1241 VERTICAL RBW:1000.000KHz VBW:3000.000KHz SWT:Auto Detector : Peak Project : 8N0620-05 Mode : 44 Power : 20.5</p>	<p>Left blank</p>



Band 4 - 5725~5850MHz
WIFI 802.11a (Harmonic @ 3m)

WIFI	Band 4 5725~5850MHz Harmonic @ 3m	
ANT	802.11a CH149 5745MHz	
4+5	Horizontal	Vertical
Peak Avg.	<p>Site : 03CH13-HY Condition : PEAK(UNII) 3m HORN_91200_1241 HORIZONTAL Detector : Peak Project : 8N0620-05 Mode : 36 Power : 21</p>	<p>Site : 03CH13-HY Condition : PEAK(UNII) 3m HORN_91200_1241 VERTICAL Detector : Peak Project : 8N0620-05 Mode : 36 Power : 21</p>

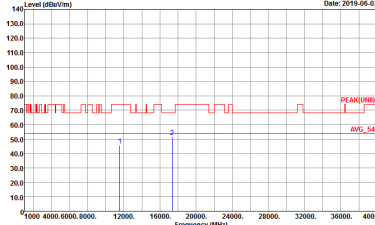
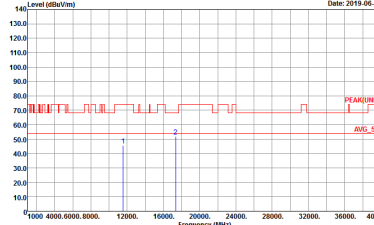

WIFI	Band 4 5725~5850MHz Harmonic @ 3m	
ANT	802.11a CH157 5785MHz	
4+5	Horizontal	Vertical
<p>Peak</p> <p>Avg.</p>	 <p>Date: 2019-06-03</p> <p>Site : 03CH13-HY Condition : PEAK(UNII) 3m HORN_91200_1241 HORIZONTAL Detector : Peak Project : BN0620-05 Mode : 37 Power : 21.5</p>	 <p>Date: 2019-06-03</p> <p>Site : 03CH13-HY Condition : PEAK(UNII) 3m HORN_91200_1241 VERTICAL Detector : Peak Project : BN0620-05 Mode : 37 Power : 21.5</p>



WIFI	Band 4 5725~5850MHz Harmonic @ 3m	
ANT	802.11a CH165 5825MHz	
4+5	Horizontal	Vertical
Peak Avg.	<p>Site : 03CH13-HY Condition : PEAK(UNII) 3m HORN_91200_1241 HORIZONTAL Detector : Peak Project : BN0620-05 Mode : 38 Power : 21.5</p>	<p>Site : 03CH13-HY Condition : PEAK(UNII) 3m HORN_91200_1241 VERTICAL Detector : Peak Project : BN0620-05 Mode : 38 Power : 21.5</p>



**Band 4 5725~5850MHz
WIFI 802.11n HT20 (Harmonic @ 3m)**

WIFI	Band 4 5725~5850MHz Harmonic @ 3m	
ANT	802.11n HT20 CH149 5745MHz	
4+5	Horizontal	Vertical
Peak Avg.	<p>Site : 03CH13-HY Condition : PEAK(LINE) 3m HORN_91200_1241 HORIZONTAL Detector : Peak Project : BN0620-05 Mode : 39 Power : 21</p>	<p>Site : 03CH13-HY Condition : PEAK(LINE) 3m HORN_91200_1241 VERTICAL Detector : Peak Project : BN0620-05 Mode : 39 Power : 21</p>

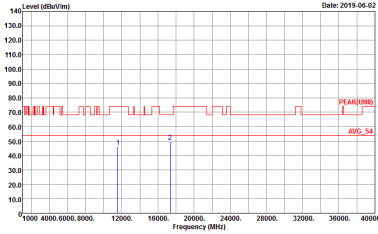
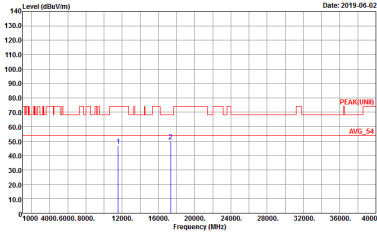

WIFI	Band 4 5725~5850MHz Harmonic @ 3m	
ANT	802.11n HT20 CH157 5785MHz	
4+5	Horizontal	Vertical
<p>Peak</p> <p>Avg.</p>	 <p>Site : 03CH13-HY Condition : PEAK(UNII) 3m HORN_91200_1241 HORIZONTAL Detector : Peak Project : BN0620-05 Mode : 40 Power : 21.5</p>	 <p>Site : 03CH13-HY Condition : PEAK(UNII) 3m HORN_91200_1241 VERTICAL Detector : Peak Project : BN0620-05 Mode : 40 Power : 21.5</p>



WIFI	Band 4 5725~5850MHz Harmonic @ 3m	
ANT	802.11n HT20 CH165 5825MHz	
4+5	Horizontal	Vertical
Peak Avg.	<p>Site : 03CH13-HV Condition : PEAK(UNII) 3m HORN_91200_1241 HORIZONTAL Detector : Peak Project : BN0620-05 Mode : 41 Power : 21.5</p>	<p>Site : 03CH13-HV Condition : PEAK(UNII) 3m HORN_91200_1241 VERTICAL Detector : Peak Project : BN0620-05 Mode : 41 Power : 21.5</p>



**Band 4 5725~5850MHz
WIFI 802.11n HT40 (Harmonic @ 3m)**

WIFI	Band 4 5725~5850MHz Harmonic @ 3m	
ANT	802.11n HT40 CH151 5755MHz	
4+5	Horizontal	Vertical
Peak Avg.	<p>Site : 03CH13-HY Condition : PEAK(LINE) 3m HORN_91200_1241 HORIZONTAL Detector : Peak Project : BN0620-05 Mode : 42 Power : 20.5</p>	<p>Site : 03CH13-HY Condition : PEAK(LINE) 3m HORN_91200_1241 VERTICAL Detector : Peak Project : BN0620-05 Mode : 42 Power : 20.5</p>



WIFI	Band 4 5725~5850MHz Harmonic @ 3m	
ANT	802.11n HT40 CH159 5795MHz	
4+5	Horizontal	Vertical
Peak Avg.	<p>Site : 03CH13-HV Condition : PEAK(UNII) 3m HORN_91200_1241 HORIZONTAL Detector : Peak Project : BN0620-05 Mode : 43 Power : 21</p>	<p>Site : 03CH13-HV Condition : PEAK(UNII) 3m HORN_91200_1241 VERTICAL Detector : Peak Project : BN0620-05 Mode : 43 Power : 21</p>



**Band 4 5725~5850MHz
WIFI 802.11ac VHT80 (Harmonic @ 3m)**

WIFI	Band 4 5725~5850MHz Harmonic @ 3m	
ANT	802.11ac VHT80 CH155 5775MHz	
4+5	Horizontal	Vertical
Peak Avg.	<p>Site : 03CH13-HY Condition : PEAK(LINE) 3m HORN_91200_1241 HORIZONTAL Detector : Peak Project : BN0620-05 Mode : 44 Power : 20.5</p>	<p>Site : 03CH13-HY Condition : PEAK(LINE) 3m HORN_91200_1241 VERTICAL Detector : Peak Project : BN0620-05 Mode : 44 Power : 20.5</p>

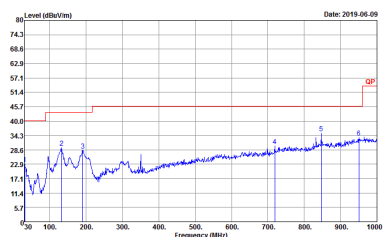
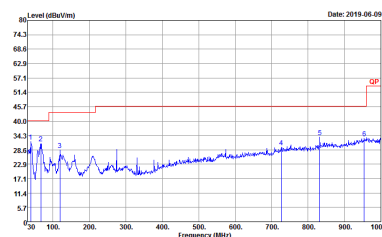

Emission below 1GHz
5GHz WIFI 802.11ac VHT80 (LF)

WIFI	5GHz 5725~5850MHz	
ANT	802.11ac VHT80 LF	
4+5	Horizontal	Vertical
QP / Peak	 <p>Site : 03CH13-HY Condition : QP 3m BTL0G_40103 HORIZONTAL Detector : Peak Project : 8N0620-05 Mode : 45</p>	 <p>Site : 03CH13-HY Condition : QP 3m BTL0G_40103 VERTICAL Detector : Peak Project : 8N0620-05 Mode : 45</p>



<WPC Charging Mode>

Band 4 - 5725~5850MHz

WIFI 802.11ac VHT80 (Band Edge @ 3m)

WIFI	Band 4 5725~5850MHz Band Edge @ 3m	
ANT	802.11ac VHT80 CH155 5775MHz	
4+5	Horizontal	Fundamental
Peak	<p>Site : 03CH13-HY Condition : PEAK_BE(B4)_16-24 3m HORN_91200_1241 HORIZONTAL RBW:1000.000KHz VBW:3000.000KHz SWT:Auto Detector : Peak Project : 8N0620-05 Mode : 46 Power : 20.5</p>	<p>Site : 03CH13-HY Condition : PEAK(LINII) 3m HORN_91200_1241 HORIZONTAL RBW:1000.000KHz VBW:3000.000KHz SWT:Auto Detector : Peak Project : 8N0620-05 Mode : 46 Power : 20.5</p>
Peak	<p>Site : 03CH13-HY Condition : PEAK_BE(B4)_16-24 3m HORN_91200_1241 HORIZONTAL RBW:1000.000KHz VBW:3000.000KHz SWT:Auto Detector : Peak Project : 8N0620-05 Mode : 46 Power : 20.5</p>	Left blank



WIFI	Band 4 5725~5850MHz Band Edge @ 3m	
ANT	802.11ac VHT80 CH155 5775MHz	
4+5	Vertical	Fundamental
Peak	<p>Date: 2019-06-09 PEAK_BE(84)_15-21</p> <p>Site : 03CH13-HY Condition : PEAK_BE(84)_16-24 3m HORN_91200_1241 VERTICAL RBW:1000.000KHz VBW:3000.000KHz SWT:Auto Detector : Peak Project : 8N0620-05 Mode : 46 Power : 20.5</p>	<p>Date: 2019-06-09 PEAK_BE(84)_15-21</p> <p>Site : 03CH13-HY Condition : PEAK(UNII) 3m HORN_91200_1241 VERTICAL RBW:1000.000KHz VBW:3000.000KHz SWT:Auto Detector : Peak Project : 8N0620-05 Mode : 46 Power : 20.5</p>
Peak	<p>Date: 2019-06-09 PEAK_BE(84)_16-24</p> <p>Site : 03CH13-HY Condition : PEAK_BE(84)_16-24 3m HORN_91200_1241 VERTICAL RBW:1000.000KHz VBW:3000.000KHz SWT:Auto Detector : Peak Project : 8N0620-05 Mode : 46 Power : 20.5</p>	Left blank



Band 4 - 5725~5850MHz
WIFI 802.11ac VHT80 (Harmonic @ 3m)

WIFI	Band 4 5725~5850MHz Harmonic @ 3m	
ANT	802.11ac VHT80 CH155 5775MHz	
4+5	Horizontal	Vertical
Peak Avg.	<p>Site : 03CH13-HY Condition : PEAK(UNII) 3m HORN_91200_1241 HORIZONTAL Detector : Peak Project : 8N0620-05 Mode : 45 Power : 20.5</p>	<p>Site : 03CH13-HY Condition : PEAK(UNII) 3m HORN_91200_1241 VERTICAL Detector : Peak Project : 8N0620-05 Mode : 45 Power : 20.5</p>

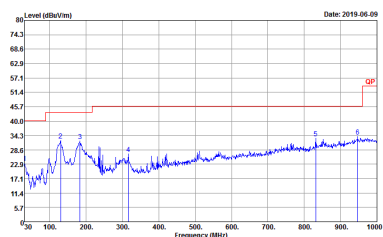
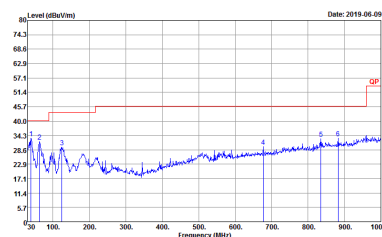

Emission below 1GHz
5GHz WIFI 802.11ac VHT80 (LF)

WIFI	5GHz 5725-5850MHz	
ANT	802.11ac VHT80 LF	
4+5	Horizontal	Vertical
QP / Peak	 <p>Site : 03CH13-HY Condition : QP 3m B1LOG_40103 HORIZONTAL Detector : Peak Project : 8N0620-05 Mode : -46</p>	 <p>Site : 03CH13-HY Condition : QP 3m B1LOG_40103 VERTICAL Detector : Peak Project : 8N0620-05 Mode : -46</p>



Appendix E. Duty Cycle Plots

Antenna	Band	Duty Cycle(%)	T(us)	1/T(kHz)	VBW Setting	Duty Factor(dB)
4+5	5GHz 802.11a for Ant. 4	98.10	-	-	10Hz	0.08
4+5	5GHz 802.11a for Ant. 5	98.57	-	-	10Hz	0.06
4+5	5GHz 802.11n HT20 for Ant. 4	97.96	1920	0.52	1kHz	0.09
4+5	5GHz 802.11n HT20 for Ant. 5	97.97	1930	0.52	1kHz	0.09
4+5	5GHz 802.11n HT40 for Ant. 4	96.45	950	1.05	3kHz	0.16
4+5	5GHz 802.11n HT40. for Ant. 5	96.43	945	1.06	3kHz	0.16
4+5	5GHz 802.11ac VHT80 for Ant. 4	92.81	465	2.15	3kHz	0.32
4+5	5GHz 802.11ac VHT80 for Ant. 5	92.81	465	2.15	3kHz	0.32

MIMO <Ant. 4>

802.11a

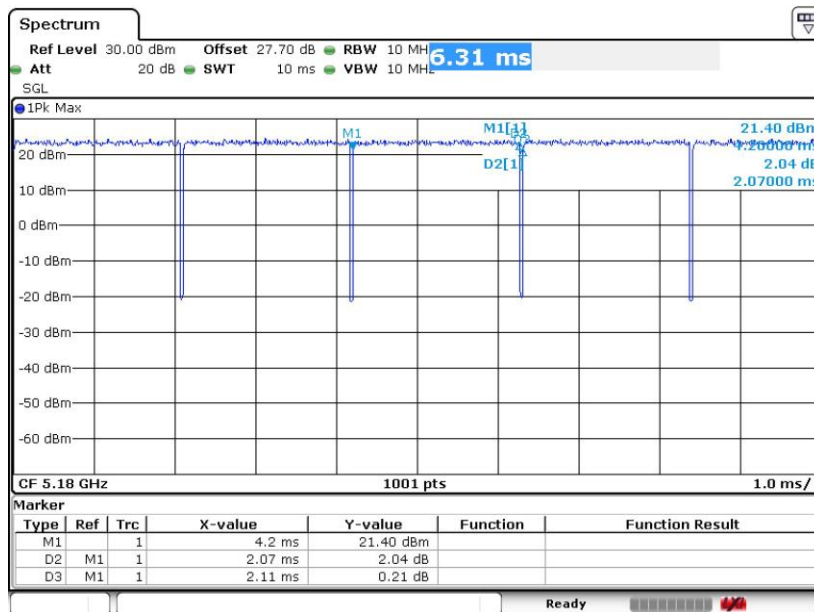

Date: 6.APR.2019 11:49:59



802.11n HT20

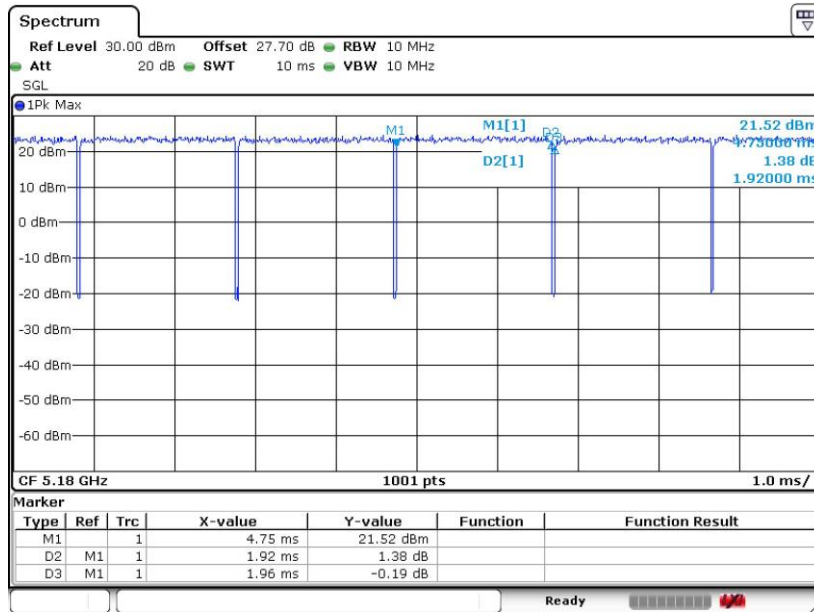

Date: 6.APR.2019 11:53:41

802.11n HT40

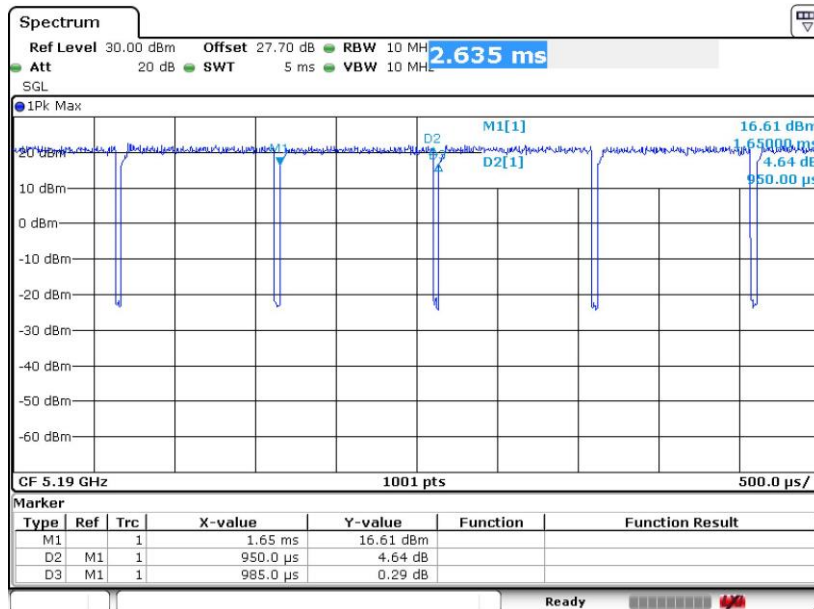

Date: 6.APR.2019 12:01:59



802.11ac VHT80

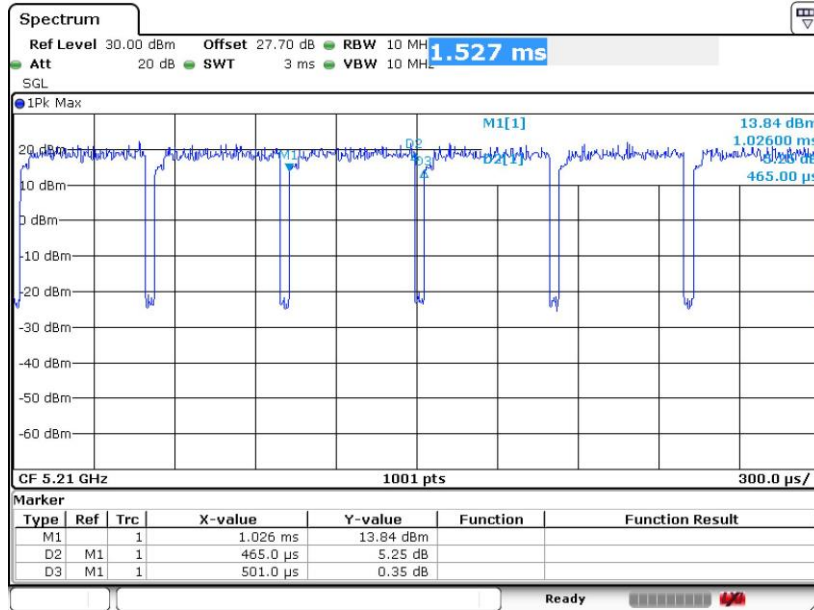

Date: 6.APR.2019 12:49:19

MIMO <Ant. 5>

802.11a

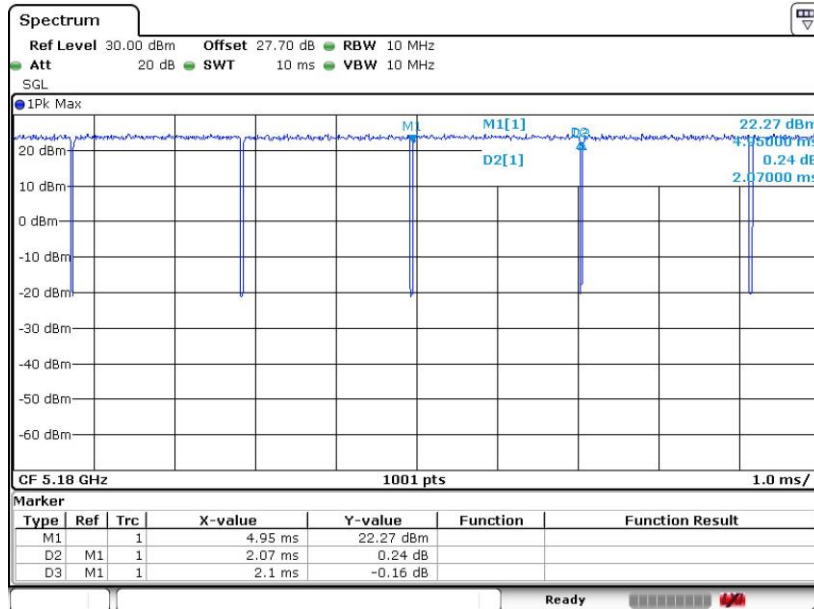

Date: 6.APR.2019 11:50:27



802.11n HT20

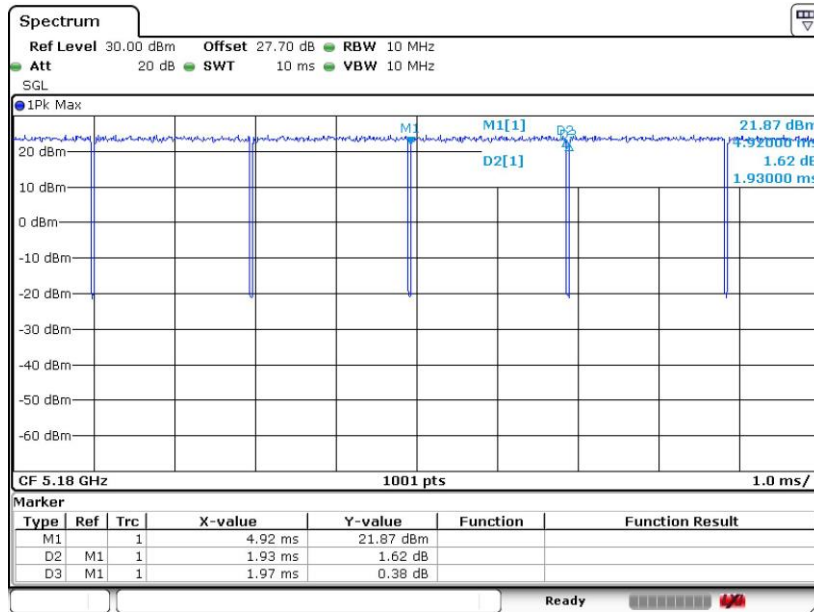

Date: 6 APR 2019 11:54:10

802.11n HT40

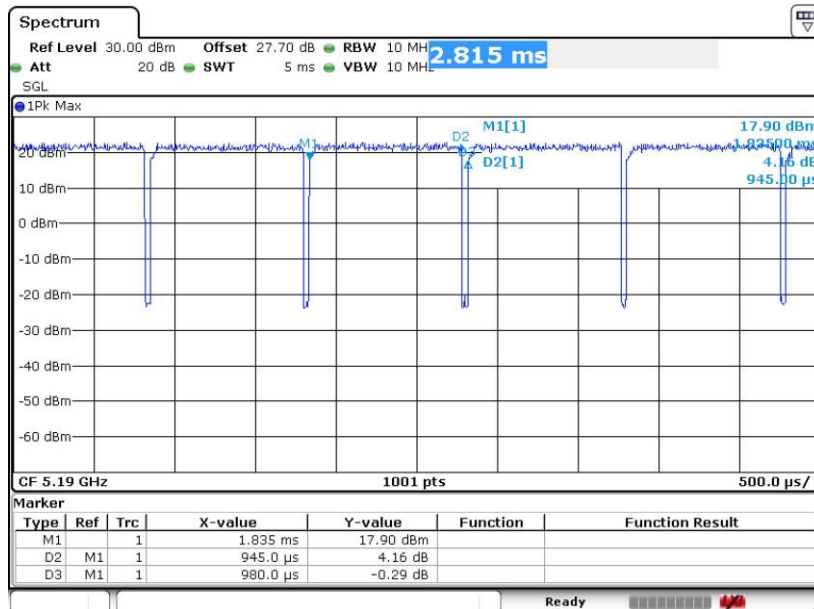

Date: 6 APR 2019 12:19:36



802.11ac VHT80

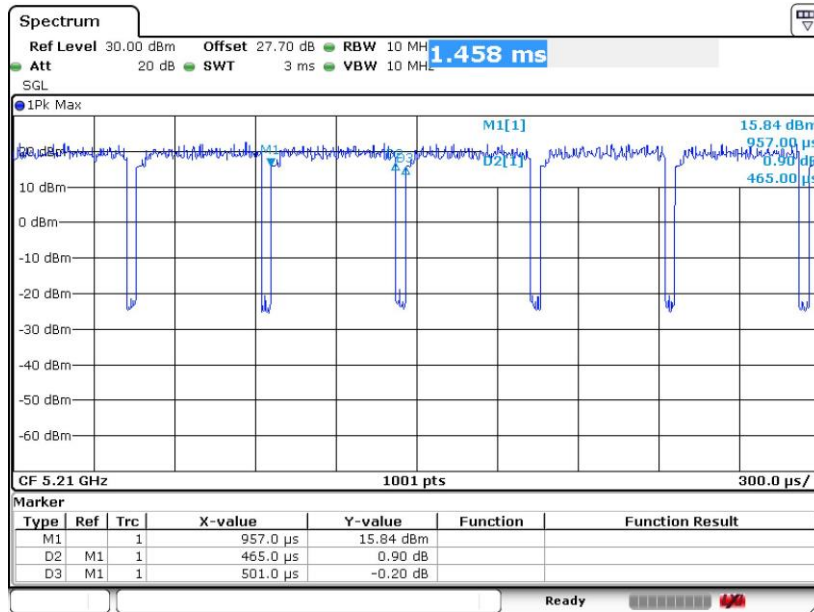

Date: 6.APR.2019 12:50:11

—THE END—