



# FCC RADIO TEST REPORT

**FCC ID** : A4RG020MN  
**Equipment** : Phone  
**Model Name** : G020M, G020N  
**Applicant** : Google LLC  
1600 Amphitheatre Parkway,  
Mountain View, California, 94043 USA  
**Standard** : FCC 47 CFR Part 2, and 90(S)

The product was received on Nov. 06, 2018 and testing was started from Apr. 25, 2019 and completed on Jun. 29, 2019. We, SPORTON INTERNATIONAL INC. EMC & Wireless Communications Laboratory, would like to declare that the tested sample has been evaluated in accordance with the test procedures given in ANSI / TIA-603-E and has been in compliance with the applicable technical standards.

The report must not be used by the client to claim product certification, approval, or endorsement by TAF or any agency of government.

The test results in this report apply exclusively to the tested model / sample. Without written approval of SPORTON INTERNATIONAL INC. EMC & Wireless Communications Laboratory, the test report shall not be reproduced except in full.

Approved by: Jones Tsai

**SPORTON INTERNATIONAL INC. EMC & Wireless Communications Laboratory**  
No. 52, Huaya 1st Rd., Guishan Dist., Taoyuan City, Taiwan (R.O.C.)



## Table of Contents

History of this test report.....	3
Summary of Test Result.....	4
<b>1 General Description .....</b>	<b>5</b>
1.1 Feature of Equipment Under Test.....	5
1.2 Product Specification of Equipment Under Test .....	5
1.3 Modification of EUT .....	5
1.4 Testing Site.....	6
1.5 Applied Standards .....	6
<b>2 Test Configuration of Equipment Under Test .....</b>	<b>7</b>
2.1 Test Mode.....	7
2.2 Connection Diagram of Test System .....	8
2.3 Support Unit used in test configuration and system.....	8
2.4 Measurement Results Explanation Example .....	9
2.5 Frequency List of Low/Middle/High Channels.....	9
<b>3 Conducted Test Items.....</b>	<b>10</b>
3.1 Measuring Instruments.....	10
3.2 Conducted Output Power Measurement and ERP Measurement .....	11
3.3 Peak-to-Average Ratio .....	12
3.4 99% Occupied Bandwidth and 26dB Bandwidth Measurement.....	13
3.5 Emissions Mask Measurement .....	14
3.6 Emissions Mask – Out Of Band Emissions Measurement.....	15
3.7 Frequency Stability Measurement.....	16
3.8 Field Strength of Spurious Radiation Measurement .....	17
<b>4 List of Measuring Equipment.....</b>	<b>19</b>
<b>5 Uncertainty of Evaluation .....</b>	<b>21</b>
<b>Appendix A. Test Results of Conducted Test</b>	
<b>Appendix B. Test Results of ERP and Radiated Test</b>	



### History of this test report

Report No.	Version	Description	Issued Date
FG8N0616-06C	01	Initial issue of report	Jul. 04, 2019



### Summary of Test Result

Report Clause	Ref Std. Clause	Test Items	Result (PASS/FAIL)	Remark
3.2	§2.1046 §90.635	Conducted Output Power and Effective Radiated Power	Pass	-
3.3	-	Peak-to-Average Ratio	Reporting only	-
3.4	§2.1049 §90.209	Occupied Bandwidth and 26dB Bandwidth	Reporting only	-
3.5	§2.1051 §90.691	Emission masks – In-band emissions	Pass	-
3.6	§2.1051 §90.691	Emission masks – Out of band emissions	Pass	-
3.7	§2.1055 §90.213	Frequency Stability for Temperature & Voltage	Pass	-
3.8	§2.1053 §90.691	Field Strength of Spurious Radiation	Pass	Under limit 33.51 dB at 2472.000 MHz

**Declaration of Conformity:**

The test results with all measurement uncertainty excluded are presented in accordance with the regulation limits or requirements declared by manufacturers.

**Comments and Explanations:**

The declared of product specification for EUT presented in the report are provided by the manufacturer, and the manufacturer takes all the responsibilities for the accuracy of product specification.

**Reviewed by: Wii Chang**

**Report Producer: Elise Chang**

# 1 General Description

## 1.1 Feature of Equipment Under Test

Product Feature	
Equipment	Phone
Model Name	G020M, G020N
FCC ID	A4RG020MN
EUT supports Radios application	GSM/EGPRS/WCDMA/HSPA/LTE/NFC/GNSS/WPC WLAN 11b/g/n HT20 WLAN 11a/n HT20/HT40 WLAN 11ac VHT20/VHT40/VHT80 Bluetooth BR/EDR/LE 60 GHz Low Power Transmitter
EUT Stage	Identical Prototype

Remark: The above EUT's information was declared by manufacturer.

EUT Information List	
No.	S/N
#1	934AZ06902
#2	934AZ06899

## 1.2 Product Specification of Equipment Under Test

Product Specification subjective to this standard	
Tx Frequency	814.7 ~ 823.3 MHz
Rx Frequency	859.7 ~ 868.3 MHz
Bandwidth	1.4MHz / 3MHz / 5MHz / 10MHz / 15MHz
Maximum Output Power to Antenna	24.58 dBm
Antenna Type / Gain	<Ant. 0_A> LTE Band 26 : ILA Antenna type with gain -3.5 dBi <Ant. 1> LTE Band 26 : ILA Antenna type with gain -4.6 dBi
Type of Modulation	QPSK / 16QAM / 64QAM

## 1.3 Modification of EUT

No modifications are made to the EUT during all test items.



## 1.4 Testing Site

<b>Test Site</b>	SPORTON INTERNATIONAL INC. EMC & Wireless Communications Laboratory	
<b>Test Site Location</b>	No.52, Huaya 1st Rd., Guishan Dist., Taoyuan City, Taiwan (R.O.C.) TEL: +886-3-327-3456 FAX: +886-3-328-4978	
<b>Test Site No.</b>	<b>Sporton Site No.</b>	
	TH05-HY	03CH07-HY
<b>Test Engineer</b>	Jacky Wang	Jesse Wang, Stan Hsieh, Troye Hsieh, Ken Wu
<b>Temperature</b>	22~24°C	21~26°C
<b>Relative Humidity</b>	54~58%	58~54%

**Note:** The test site complies with ANSI C63.4 2014 requirement.

FCC Designation No.: TW1190

## 1.5 Applied Standards

According to the specifications of the manufacturer, the EUT must comply with the requirements of the following standards:

- ♦ FCC 47 CFR Part 2, 90
- ♦ ANSI / TIA-603-E
- ♦ ANSI C63.26-2015
- ♦ FCC KDB 971168 D01 Power Meas. License Digital Systems v03r01
- ♦ FCC KDB 412172 D01 Determining ERP and EIRP v01r01
- ♦ Interim Guidance for Equipment Authorization of Devices with Channel Bandwidths Combined Across Two Contiguous Service Rule Allocations OET/Lab/EACB, June 6, 2013

**Remark:**

1. All test items were verified and recorded according to the standards and without any deviation during the test.
2. This EUT has also been tested and complied with the requirements of FCC Part 15, Subpart B, recorded in a separate test report.



## 2 Test Configuration of Equipment Under Test

### 2.1 Test Mode

During all testing, EUT is in link mode with base station emulator at maximum power level.

For radiated measurement, pre-scanned in three orthogonal panels, X, Y, Z. The worst cases (Z plane with adapter for Ant. 0\_A ; X plane with adapter for Ant. 1) were recorded in this report.

Frequency range investigated for radiated emission is 30 MHz to 9000 MHz.

Conducted Test Cases	Band	Bandwidth (MHz)						Modulation			RB #			Test Channel		
		1.4	3	5	10	15	20	QPSK	16QAM	64QAM	1	Half	Full	L	M	H
Max. Output Power	26	v	v	v	v	v	-	v	v	v	v	v	v	v	v	v
Peak-to-Average Ratio	26				v		-	v	v	v	v		v		v	
26dB and 99% Bandwidth	26	v	v	v	v	v	-	v	v	v			v	v	v	v
Emission masks In-band emissions	26	v	v	v	v	v	-	v	v	v	v		v	v		v
Emission masks – Out of band emissions	26	v	v	v	v	v	-	v	v	v	v			v	v	v
Frequency Stability	26				v	v	-	v					v	v	v	
E.R.P.	26					v	-	v	v	v	v			v		
Radiated Spurious Emission	26	Worst Case											v	v	v	
Remark	<ol style="list-style-type: none"> <li>The mark "v " means that this configuration is chosen for testing</li> <li>The mark "- " means that this bandwidth is not supported.</li> <li>LTE Band26 transmit frequency for part22 rule is 824MHz-849MHz, for part90 rule is 814MHz-824MHz. ERP over 15MHz bandwidth complies the ERP limit line of part22 rule, therefore ERP of the partial frequency spectrum which falls within part 22 also complies.</li> <li>All the radiated test cases were performed with Adapter 1.</li> </ol>															

## 2.2 Connection Diagram of Test System

<For Adapter Mode>

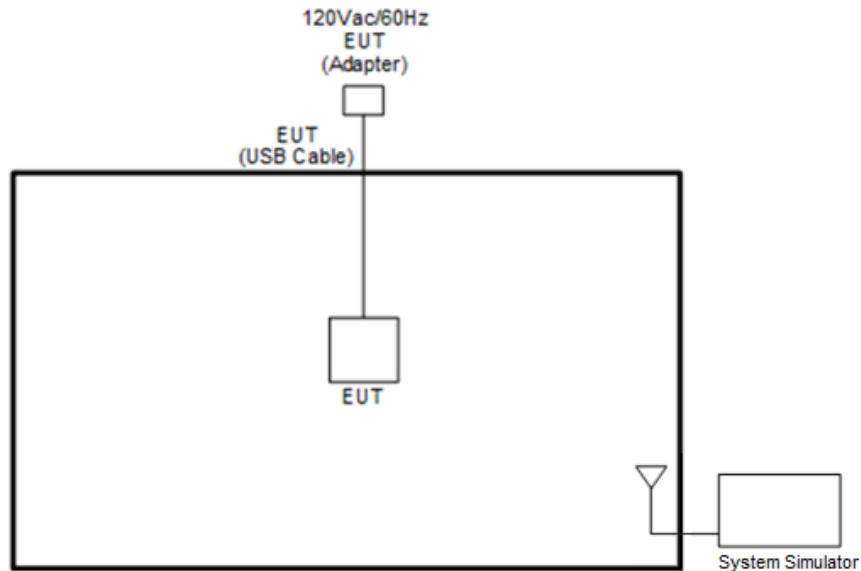

<For WPC Charging Mode>

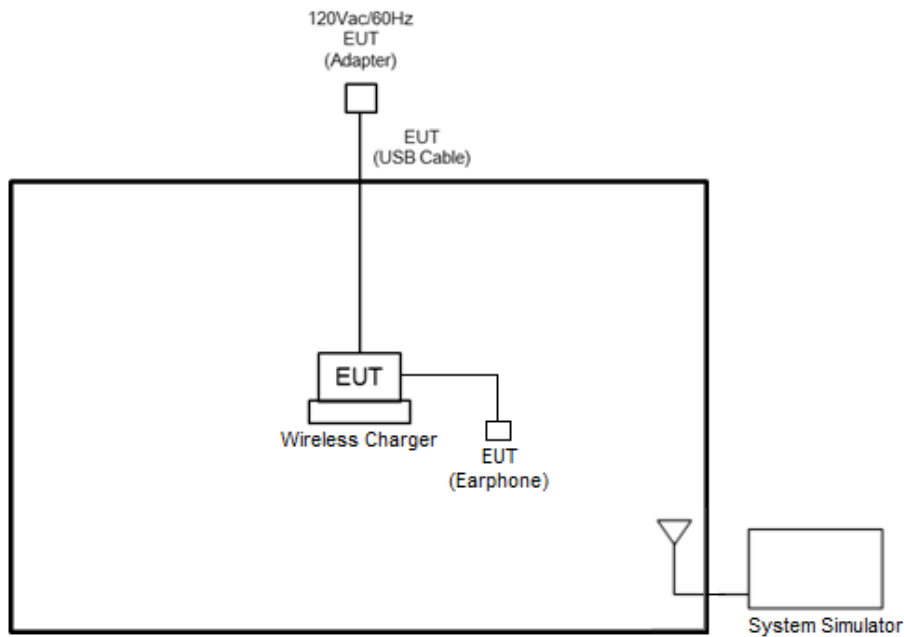

## 2.3 Support Unit used in test configuration and system

Item	Equipment	Trade Name	Model No.	FCC ID	Data Cable	Power Cord
1.	System Simulator	Anritsu	MT8821C	N/A	N/A	Unshielded, 1.8 m





## 2.4 Measurement Results Explanation Example

**For all conducted test items:**

The offset level is set in the spectrum analyzer to compensate the RF cable loss and attenuator factor between RF conducted output port and spectrum analyzer. With the offset compensation, the spectrum analyzer reading level will be exactly the RF output level.

The spectrum analyzer offset is derived from RF cable loss and attenuator factor.

$$\text{Offset} = \text{RF cable loss} + \text{attenuator factor}.$$

The following shows an offset computation example with RF cable loss 4.2 dB and a 10dB attenuator.

Example :

$$\begin{aligned} \text{Offset(dB)} &= \text{RF cable loss(dB)} + \text{attenuator factor(dB)}. \\ &= 4.2 + 10 = 14.2 \text{ (dB)} \end{aligned}$$

## 2.5 Frequency List of Low/Middle/High Channels

LTE Band 26 Channel and Frequency List				
BW [MHz]	Channel/Frequency(MHz)	Lowest	Middle	Highest
15	Channel	26765	-	-
	Frequency	821.5	-	-
10	Channel	-	26740	-
	Frequency	-	819	-
5	Channel	26715	26740	26765
	Frequency	816.5	819	821.5
3	Channel	26705	26740	26775
	Frequency	815.5	819	822.5
1.4	Channel	26697	26740	26783
	Frequency	814.7	819	823.3

### 3 Conducted Test Items

#### 3.1 Measuring Instruments

See list of measuring instruments of this test report.

##### 3.1.1 Test Setup

##### 3.1.2 Conducted Output Power

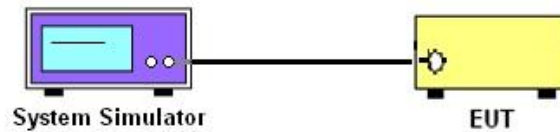

##### 3.1.3 Peak-to-Average Ratio, Occupied Bandwidth, Conducted Band-Edge, Emission Mask, Emissions Mask – Out Of Band Emissions, and Conducted Spurious Emission

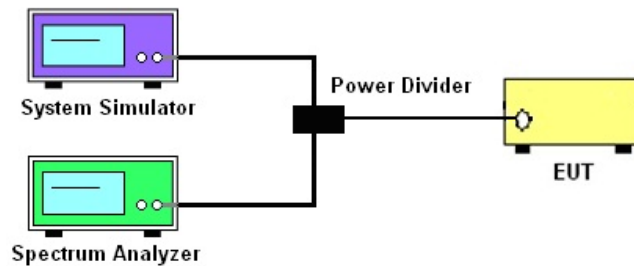

##### 3.1.4 Frequency Stability

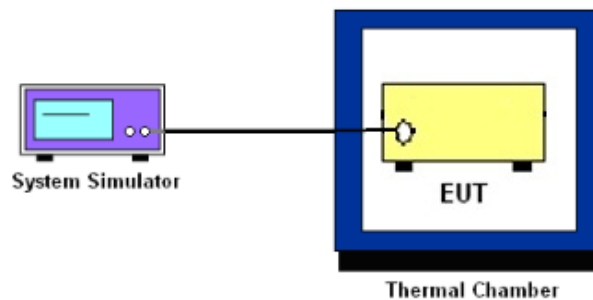

##### 3.1.5 Test Result of Conducted Test

Please refer to Appendix A.



## 3.2 Conducted Output Power Measurement and ERP Measurement

### 3.2.1 Description of the Conducted Output Power Measurement and ERP Measurement

A system simulator was used to establish communication with the EUT. Its parameters were set to enforce EUT transmitting at the maximum power. The measured power in the radio frequency on the transmitter output terminals shall be reported.

The ERP of mobile transmitters must not exceed 7 Watts for LTE Band 26.

According to KDB 412172 D01 Power Approach,

$EIRP = P_T + G_T - L_C$ , where

$P_T$  = transmitter output power in dBm

$G_T$  = gain of the transmitting antenna in dBi

$L_C$  = signal attenuation in the connecting cable between the transmitter and antenna in dB

### 3.2.2 Test Procedures

1. The transmitter output port was connected to the system simulator.
2. Set EUT at maximum power through system simulator.
3. Select lowest, middle, and highest channels for each band and different modulation.
4. Measure and record the power level from the system simulator.



### **3.3 Peak-to-Average Ratio**

#### **3.3.1 Description of the PAR Measurement**

Reporting only

#### **3.3.2 Test Procedures**

1. The EUT was connected to spectrum and system simulator via a power divider.
2. Set the CCDF (Complementary Cumulative Distribution Function) option in spectrum analyzer.
3. The highest RF powers were measured and recorded the maximum PAPR level associated with a probability of 0.1 %.
4. Record the deviation as Peak to Average Ratio.



## **3.4 99% Occupied Bandwidth and 26dB Bandwidth Measurement**

### **3.4.1 Description of (Occupied) Bandwidth Limitations Measurement**

The 99% occupied bandwidth is the width of a frequency band such that, below the lower and above the upper frequency limits, the mean powers emitted are each equal to a specified percentage 0.5% of the total mean transmitted power.

The emission bandwidth is defined as the width of the signal between two points, located at the 2 sides of the carrier frequency, outside of which all emissions are attenuated at least 26 dB below the transmitter power.

### **3.4.2 Test Procedures**

1. The EUT was connected to spectrum analyzer and system simulator via a power divider.
2. The 26dB and 99% occupied bandwidth (BW) of the middle channel for the highest RF power with full RB sizes were measured.



### 3.5 Emissions Mask Measurement

#### 3.5.1 Description of Emissions Mask Measurement

Equipment used in this licensed to EA or non-EA systems shall comply with the emission mask provisions of FCC Part 90.691.(a)

(a) Out-of-band emission requirement shall apply only to the “outer” channels included in an EA license and to spectrum adjacent to interior channels used by incumbent licensees. The emission limits are as follows:

(1) For any frequency removed from the EA licensee's frequency block by up to and including 37.5 kHz, the power of any emission shall be attenuated below the transmitter power (P) in watts by at least  $116 \text{ Log}_{10}(f/6.1)$  decibels or  $50 + 10 \text{ Log}_{10}(P)$  decibels or 80 decibels, whichever is the lesser attenuation, where f is the frequency removed from the center of the outer channel in the block in kilohertz and where f is greater than 12.5 kHz.

(2) For any frequency removed from the EA licensee's frequency block greater than 37.5 kHz, the power of any emission shall be attenuated below the transmitter power (P) in watts by at least  $43 + 10 \text{ Log}_{10}(P)$  decibels or 80 decibels, whichever is the lesser attenuation, where f is the frequency removed from the center of the outer channel in the block in kilohertz and where f is greater than 37.5 kHz.

#### 3.5.2 Test Procedures

1. The EUT was connected to spectrum analyzer and base station via power divider.
2. The emissions mask of low and high channels for the highest RF powers were measured.
3. Set RBW and VBW 3 times of RBW to make the measurement with the spectrum analyzer's, and according to KDB 971168 D02 Misc Rev Approve License Devices v02r01 standards, set RBW = 300 Hz to make offsets less than 37.5 kHz from a channel edge , RBW = 100 kHz to make offsets greater than 37.5 kHz, that is allowed.
4. The test results were shown below plots with a correction offset factor including cable loss, insertion loss of power divider.



## 3.6 Emissions Mask – Out Of Band Emissions Measurement

### 3.6.1 Description of Conducted Emissions Out of band emissions measurement

The power of any emission FCC Part 90.691 (a)(2) on any frequency removed from the assigned frequency by out of the authorized bandwidth at least  $43 + 10 \log (P)$  dB. It is measured by means of a calibrated spectrum analyzer and scanned from 30 MHz up to a frequency including its 10<sup>th</sup> harmonic.

### 3.6.2 Test Procedures

1. The EUT was connected to spectrum analyzer and system simulator via a power divider.
2. The RF output of EUT was connected to the spectrum analyzer by RF cable and attenuator. The path loss was compensated to the results for each measurement.
3. The middle channel for the highest RF power within the transmitting frequency was measured.
4. The conducted spurious emission for the whole frequency range was taken.
5. For testing below 1GHz, make the measurement with the spectrum analyzer's RBW = 100 kHz, VBW = 3MHz, taking the record of maximum spurious emission.
6. For testing above 1GHz, make the measurement with the spectrum analyzer's RBW = 1MHz, VBW = 3MHz, taking the record of maximum spurious emission.
7. The RF fundamental frequency should be excluded against the limit line in the operating frequency band.
8. The limit line is derived from  $43 + 10\log(P)$ dB below the transmitter power P(Watts)



## **3.7 Frequency Stability Measurement**

### **3.7.1 Description of Frequency Stability Measurement**

The frequency stability shall be sufficient to ensure that the fundamental emission stays within the authorized frequency block.

### **3.7.2 Measuring Instruments**

The measuring equipment is listed in the section 4 of this test report.

### **3.7.3 Test Procedures for Temperature Variation**

1. The EUT was set up in the thermal chamber and connected with the base station.
2. With power OFF, the temperature was decreased to -30°C and the EUT was stabilized for three hours. Power was applied and the maximum change in frequency was recorded within one minute.
3. With power OFF, the temperature was raised in 10°C step up to 50°C. The EUT was stabilized at each step for at least half an hour. Power was applied and the maximum frequency change was recorded within one minute.

### **3.7.4 Test Procedures for Voltage Variation**

1. The EUT was placed in a temperature chamber at 20±5° C and connected with the base station.
2. The power supply voltage to the EUT was varied from BEP to 115% of the nominal value measured at the input to the EUT.
3. The variation in frequency was measured for the worst case.





## 3.8 Field Strength of Spurious Radiation Measurement

### 3.8.1 Description of Field Strength of Spurious Radiated Measurement

The radiated spurious emission was measured by substitution method according to ANSI / TIA-603-E. The power of any emission FCC Part 90.691 on any frequency removed from the assigned frequency by more than 250 percent of the authorized bandwidth at least  $43 + 10 \log (P)$  dB. The spectrum is scanned from 30 MHz up to a frequency including its 10th harmonic.

The power of any emission outside of the authorized operating frequency ranges must be attenuated below the transmitter power (P) by a factor of at least  $43+10\log_{10}(P[\text{Watts}])$  dB. The spectrum is scanned from 30 MHz up to a frequency including its 10th harmonic.

### 3.8.2 Test Procedures

1. The EUT was placed on a turntable with 0.8 meter for frequency below 1GHz and 1.5 meter for frequency above 1GHz respectively above ground.
2. The EUT was set 3 meters from the receiving antenna, which was mounted on the antenna tower.
3. The table was rotated 360 degrees to determine the position of the highest spurious emission.
4. The height of the receiving antenna is varied between one meter and four meters to search the maximum spurious emission for both horizontal and vertical polarizations.
5. For testing below 1GHz, make the measurement with the spectrum analyzer's RBW = 100 kHz, VBW = 3MHz, Sweep = 500ms, Taking the record of maximum spurious emission.
6. For testing above 1GHz, make the measurement with the spectrum analyzer's RBW = 1MHz, VBW = 3MHz, Sweep = 500ms, Taking the record of maximum spurious emission.
7. A horn antenna was substituted in place of the EUT and was driven by a signal generator.
8. Tune the output power of signal generator to the same emission level with EUT maximum spurious emission.
9. Taking the record of output power at antenna port.
10. Repeat step 7 to step 8 for another polarization.
11.  $\text{EIRP (dBm)} = \text{S.G. Power} - \text{Tx Cable Loss} + \text{Tx Antenna Gain}$
12.  $\text{ERP (dBm)} = \text{EIRP} - 2.15$
13. The RF fundamental frequency should be excluded against the limit line in the operating frequency band.
14. The limit line is derived from  $43 + 10\log(P)$  dB below the transmitter power P(Watts)

### 3.8.3 Test Setup

For radiated test from 30MHz to 1GHz

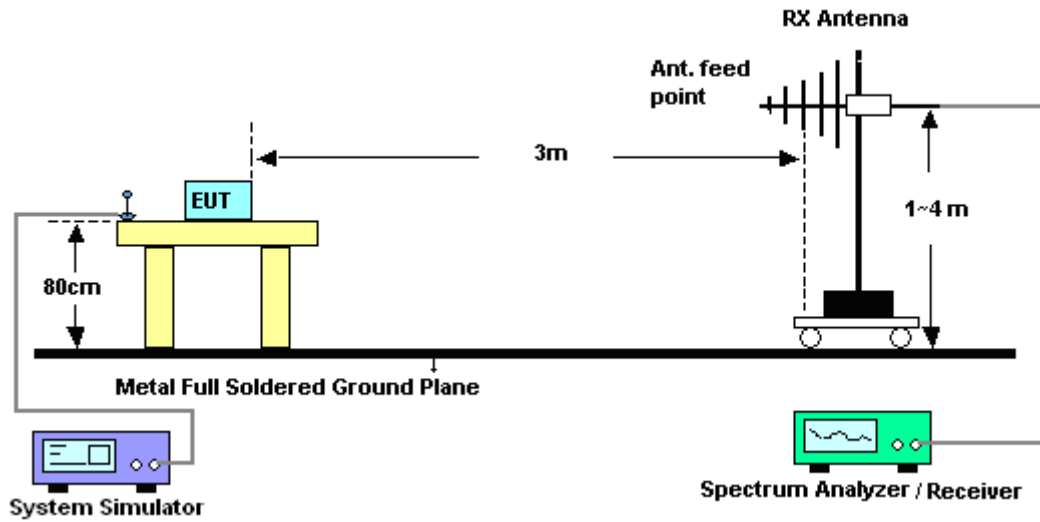

For radiated test above 1GHz

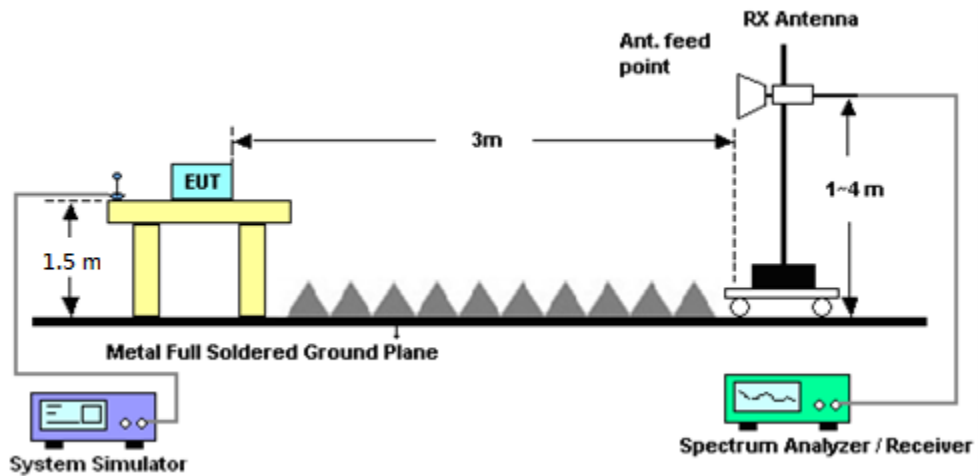

### 3.8.4 Test Result of Field Strength of Spurious Radiated

Please refer to Appendix B.



## 4 List of Measuring Equipment

Instrument	Manufacturer	Model No.	Serial No.	Characteristics	Calibration Date	Test Date	Due Date	Remark
Bilog Antenna	TESEQ	CBL 6111D & 00800N1D01N-06	35419 & 03	30MHz~1GHz	Apr. 30, 2019	May 03, 2019 ~ Jun. 29, 2019	Apr. 29, 2020	Radiation (03CH07-HY)
Double Ridge Horn Antenna	ESCO	3117	00075962	1GHz ~ 18GHz	Dec. 02, 2018	May 03, 2019 ~ Jun. 29, 2019	Dec. 03, 2019	Radiation (03CH07-HY)
EMI Test Receiver	Agilent	N9038A(MXE)	MY53290053	20Hz~26.5GHz	Jan. 23, 2019	May 03, 2019 ~ Jun. 29, 2019	Jan. 22, 2020	Radiation (03CH07-HY)
Preamplifier	MITEQ	AMF-7D-0010 1800-30-10P	1590075	1GHz~18GHz	Apr. 24, 2019	May 03, 2019 ~ Jun. 29, 2019	Apr. 23, 2020	Radiation (03CH07-HY)
Preamplifier	COM-POWER	PA-103A	161241	10MHz~1GHz	May 21, 2018	May 03, 2019 ~ May 19, 2019	May 20, 2019	Radiation (03CH07-HY)
Preamplifier	COM-POWER	PA-103A	161241	10MHz~1GHz	May 20, 2019	May 20, 2019 ~ Jun. 29, 2019	May 19, 2020	Radiation (03CH07-HY)
Preamplifier	Agilent	8449B	3008A02362	1GHz~26.5GHz	Nov. 02, 2018	May 03, 2019 ~ Jun. 29, 2019	Nov. 01, 2019	Radiation (03CH07-HY)
Filter	Microwave	H1G013G1	SN477215	1GHz High Pass Filter	Nov. 02, 2018	May 03, 2019 ~ Jun. 29, 2019	Nov. 01, 2019	Radiation (03CH07-HY)
Filter	Microwave	H3G018G1	SN477220	3GHz High Pass Filter	Nov. 02, 2018	May 03, 2019 ~ Jun. 29, 2019	Nov. 01, 2019	Radiation (03CH07-HY)
Filter	Wainwright	WHKX8-5272. 5-6750-18000-40ST	SN3	6.75GHz High Pass Filter	Aug. 23, 2018	May 03, 2019 ~ Jun. 29, 2019	Aug. 22, 2019	Radiation (03CH07-HY)
RF Cable	HUBER + SUHNER	SUCOFLEX 104	MY28655/4, MY24971/4, MY15682/4	30MHz~1GHz	Feb. 26, 2019	May 03, 2019 ~ Jun. 29, 2019	Feb. 25, 2020	Radiation (03CH07-HY)
RF Cable	HUBER + SUHNER	SUCOFLEX 104	MY28655/4, MY24971/4, MY15682/4	1GHz~18GHz	Feb. 26, 2019	May 03, 2019 ~ Jun. 29, 2019	Feb. 25, 2020	Radiation (03CH07-HY)
RF Cable	HUBER + SUHNER	SUCOFLEX 102	MY2858/2	18GHz~40GHz	Feb. 27, 2018	May 03, 2019 ~ Jun. 29, 2019	Feb. 26, 2019	Radiation (03CH07-HY)
Antenna Mast	Max-Full	MFA520BS	N/A	1m~4m	N/A	May 03, 2019 ~ Jun. 29, 2019	N/A	Radiation (03CH07-HY)
SHF-EHF Horn Antenna	SCHWARZBECK	BBHA 9170	BBHA9170251	18GHz~40GHz	Nov. 20, 2018	May 03, 2019 ~ Jun. 29, 2019	Nov. 19, 2019	Radiation (03CH07-HY)
SHF-EHF Horn Antenna	SCHWARZBECK	BBHA 9170	BBHA9170584	18GHz~40GHz	Dec. 05, 2018	May 03, 2019 ~ Jun. 29, 2019	Dec. 04, 2019	Radiation (03CH07-HY)
Horn Antenna	ESCO	3117	00066584	1GHz~18GHz	Sep. 17, 2018	May 03, 2019 ~ Jun. 29, 2019	Sep. 16, 2019	Radiation (03CH07-HY)
Spectrum Analyzer	Agilent	N9010A	MY53470118	10Hz~44GHz	Apr. 18, 2019	May 03, 2019 ~ Jun. 29, 2019	Apr. 17, 2020	Radiation (03CH07-HY)
Preamplifier	EMEC	EM18G40G	060715	18GHz~40GHz	Dec. 06, 2018	May 03, 2019 ~ Jun. 29, 2019	Dec. 05, 2019	Radiation (03CH07-HY)
Signal Generator	Anritsu	MG3694C	163401	0.1Hz~40GHz	Jan. 21, 2019	May 03, 2019 ~ Jun. 29, 2019	Jan. 20, 2020	Radiation (03CH07-HY)
Software	Audix	E3 6.2009-8-24	80504004656 H	N/A	N/A	May 03, 2019 ~ Jun. 29, 2019	N/A	Radiation (03CH07-HY)



Instrument	Manufacturer	Model No.	Serial No.	Characteristics	Calibration Date	Test Date	Due Date	Remark
Base Station (Measure)	Anritsu	MT8821C	6201664755	GSM / GPRS /WCDMA / LTE FDD/TDD with 44) /LTE-3CC DLCA,2CC ULCA	Mar. 03, 2019	Apr. 25, 2019 ~ Jun. 08, 2019	Mar. 02, 2020	Conducted (TH05-HY)
Spectrum Analyzer	Rohde & Schwarz	FSV40	101397	10Hz~40GHz	Nov. 13, 2018	Apr. 25, 2019 ~ Jun. 08, 2019	Nov. 12, 2019	Conducted (TH05-HY)
Temperature Chamber	ESPEC	SH-641	92013720	-40℃~90℃	Aug. 29, 2018	Apr. 25, 2019 ~ Jun. 08, 2019	Aug. 28, 2019	Conducted (TH05-HY)
Programmable Power Supply	GW Instek	PSS-2005	EL890094	1V~20V 0.5A~5A	Oct. 02, 2018	Apr. 25, 2019 ~ Jun. 08, 2019	Oct. 01, 2019	Conducted (TH05-HY)
Coupler	Warison	20dB 25W SMA Directional Coupler	#A	1-18GHz	Jan. 14, 2019	Apr. 25, 2019 ~ Jun. 08, 2019	Jan. 13, 2020	Conducted (TH05-HY)



## 5 Uncertainty of Evaluation

### Uncertainty of Radiated Emission Measurement (30 MHz ~ 1000 MHz)

Measuring Uncertainty for a Level of Confidence of 95% ( $U = 2Uc(y)$ )	3.05
---	------

### Uncertainty of Radiated Emission Measurement (1 GHz ~ 18 GHz)

Measuring Uncertainty for a Level of Confidence of 95% ( $U = 2Uc(y)$ )	3.44
---	------

### Uncertainty of Radiated Emission Measurement (18 GHz ~ 40 GHz)

Measuring Uncertainty for a Level of Confidence of 95% ( $U = 2Uc(y)$ )	3.95
---	------



## Appendix A. Test Results of Conducted Test

### Conducted Output Power(Average power)

LTE Band 26 Maximum Average Power [dBm]						
BW [MHz]	RB Size	RB Offset	Mod	Lowest	Middle	Highest
15	1	0	QPSK	24.55	-	-
15	1	37		24.51	-	-
15	1	74		24.58	-	-
15	36	0		23.68	-	-
15	36	20		23.71	-	-
15	36	39		23.67	-	-
15	75	0		23.68	-	-
15	1	0	16-QAM	23.89	-	-
15	1	37		23.75	-	-
15	1	74		23.91	-	-
15	36	0		22.70	-	-
15	36	20		22.72	-	-
15	36	39		22.70	-	-
15	75	0		22.69	-	-
15	1	0	64-QAM	22.61	-	-
15	1	37		22.75	-	-
15	1	74		22.76	-	-
15	36	0		21.54	-	-
15	36	20		21.74	-	-
15	36	39		21.29	-	-
15	75	0		21.42	-	-
10	1	0	QPSK	-	24.57	-
10	1	25		-	24.46	-
10	1	49		-	24.40	-
10	25	0		-	23.56	-
10	25	12		-	23.59	-
10	25	25		-	23.56	-
10	50	0		-	23.56	-
10	1	0	16-QAM	-	23.81	-
10	1	25		-	23.77	-
10	1	49		-	23.75	-
10	25	0		-	22.56	-
10	25	12		-	22.62	-
10	25	25		-	22.59	-
10	50	0		-	22.58	-
10	1	0	64-QAM	-	22.77	-
10	1	25		-	22.72	-
10	1	49		-	22.68	-
10	25	0		-	21.60	-
10	25	12		-	21.62	-
10	25	25		-	21.63	-
10	50	0		-	21.58	-



LTE Band 26 Maximum Average Power [dBm]						
BW [MHz]	RB Size	RB Offset	Mod	Lowest	Middle	Highest
5	1	0	QPSK	24.32	24.37	24.35
5	1	12		24.42	24.47	24.38
5	1	24		24.48	24.45	24.37
5	12	0		23.49	23.51	23.44
5	12	7		23.61	23.60	23.53
5	12	13		23.54	23.57	23.47
5	25	0		23.52	23.53	23.44
5	1	0	16-QAM	23.63	23.67	23.64
5	1	12		23.77	23.77	23.71
5	1	24		23.73	23.75	23.58
5	12	0		22.53	22.53	22.46
5	12	7		22.65	22.61	22.52
5	12	13		22.61	22.59	22.51
5	25	0		22.59	22.55	22.44
5	1	0	64-QAM	22.16	22.68	22.36
5	1	12		22.50	22.73	22.39
5	1	24		22.70	22.74	22.14
5	12	0		21.10	21.62	21.29
5	12	7		21.40	21.69	21.31
5	12	13		21.55	21.69	21.19
5	25	0		21.28	21.54	21.20
3	1	0	QPSK	24.30	24.40	24.42
3	1	8		24.48	24.53	24.40
3	1	14		24.36	24.42	24.30
3	8	0		23.47	23.48	23.45
3	8	4		23.56	23.59	23.47
3	8	7		23.52	23.56	23.46
3	15	0		23.51	23.46	23.44
3	1	0	16-QAM	23.58	23.67	23.65
3	1	8		23.80	23.82	23.65
3	1	14		23.68	23.70	23.58
3	8	0		22.58	22.62	22.58
3	8	4		22.71	22.68	22.54
3	8	7		22.64	22.63	22.51
3	15	0		22.59	22.52	22.48
3	1	0	64-QAM	22.13	22.67	22.42
3	1	8		22.35	22.78	22.36
3	1	14		22.53	22.68	22.13
3	8	0		21.05	21.60	21.30
3	8	4		21.13	21.69	21.26
3	8	7		21.20	21.63	21.18
3	15	0		21.06	21.55	21.22



LTE Band 26 Maximum Average Power [dBm]						
BW [MHz]	RB Size	RB Offset	Mod	Lowest	Middle	Highest
1.4	1	0	QPSK	24.33	24.35	24.27
1.4	1	3		24.43	24.48	24.37
1.4	1	5		24.30	24.36	24.24
1.4	3	0		24.38	24.36	24.30
1.4	3	1		24.43	24.40	24.32
1.4	3	3		24.40	24.42	24.27
1.4	6	0		23.47	23.42	23.40
1.4	1	0	16-QAM	23.65	23.63	23.51
1.4	1	3		23.77	23.77	23.59
1.4	1	5		23.64	23.67	23.54
1.4	3	0		23.47	23.44	23.32
1.4	3	1		23.51	23.45	23.41
1.4	3	3		23.47	23.45	23.33
1.4	6	0		22.61	22.55	22.45
1.4	1	0	64-QAM	22.04	22.60	22.13
1.4	1	3		22.10	22.72	22.09
1.4	1	5		22.08	22.65	21.96
1.4	3	0		22.03	22.59	22.05
1.4	3	1		22.09	22.65	22.09
1.4	3	3		22.06	22.63	21.99
1.4	6	0		20.87	21.48	20.92





# LTE Band 26\_Part 90S

## Peak-to-Average Ratio

Mode	LTE Band 26 / 10MHz				
Mod.	QPSK		16QAM		Limit: 13dB
RB Size	1RB	Full RB	1RB	Full RB	Result
Lowest CH	-	-	-	-	<b>PASS</b>
Middle CH	3.71	5.10	4.26	6.03	
Highest CH	-	-	-	-	
Mode	LTE Band 26 / 10MHz				
Mod.	64QAM				Limit: 13dB
RB Size	1RB	Full RB			Result
Lowest CH	-	-	-	-	<b>PASS</b>
Middle CH	5.25	6.58	-	-	
Highest CH	-	-	-	-	



LTE Band 26 / 10MHz / QPSK

Middle Channel / 1RB

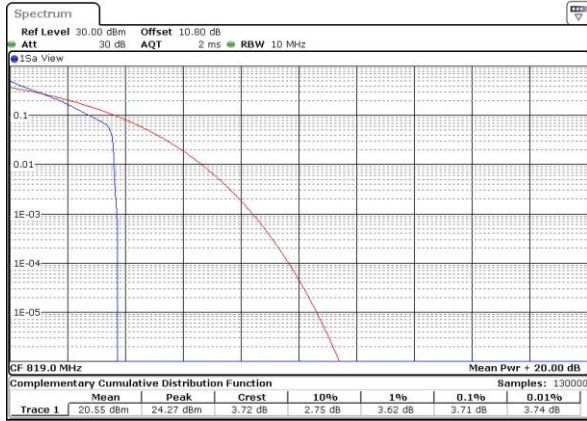

Date: 1 MAY 2019 03:13:01

Middle Channel / Full RB

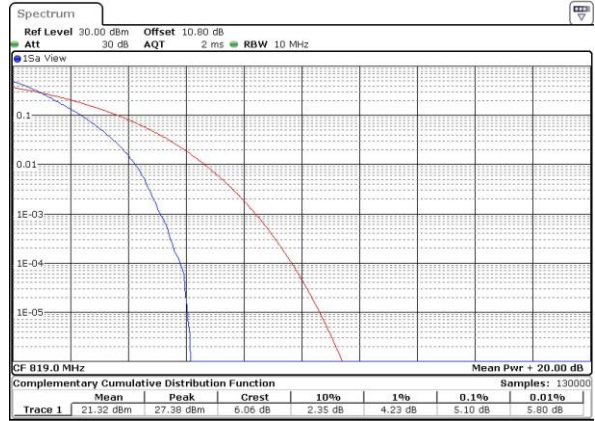

Date: 1 MAY 2019 03:13:35

LTE Band 26 / 10MHz / 16QAM

Middle Channel / 1RB



Date: 1 MAY 2019 03:13:12

Middle Channel / Full RB

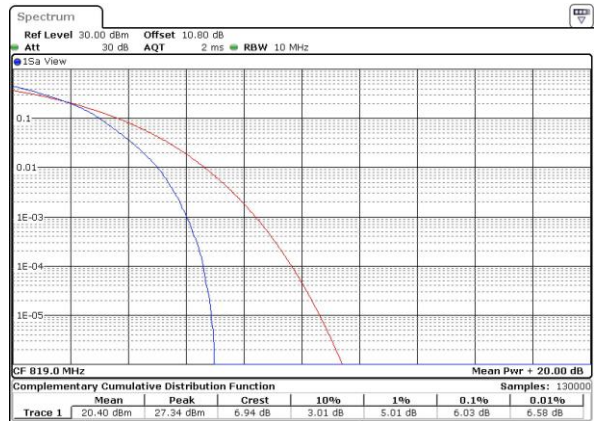

Date: 1 MAY 2019 03:13:24



LTE Band 26 / 10MHz / 64QAM

Middle Channel / 1RB

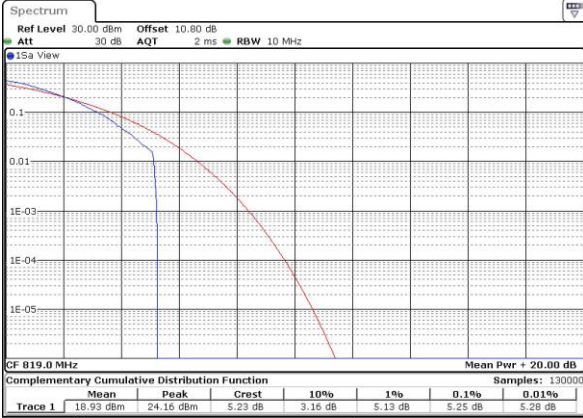

Date: 1 MAY 2019 03:13:48

Middle Channel / Full RB

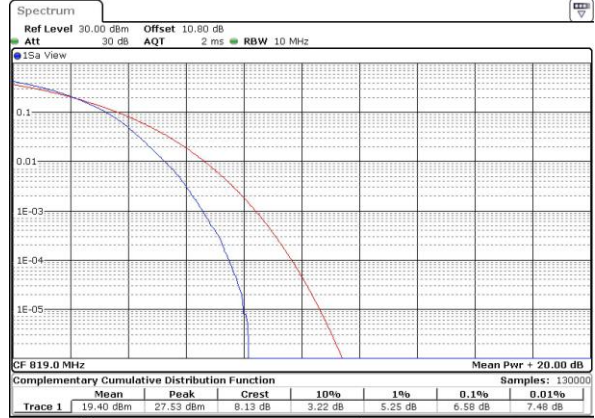

Date: 1 MAY 2019 03:13:59



**26dB Bandwidth**

Mode	LTE Band 26 : 26dB BW(MHz)											
BW	1.4MHz		3MHz		5MHz		10MHz		15MHz		20MHz	
Mod.	QPSK	16QAM	QPSK	16QAM	QPSK	16QAM	QPSK	16QAM	QPSK	16QAM	QPSK	16QAM
Lowest CH	1.23	1.23	3.04	3.03	4.83	4.91	-	-	14.36	14.18	-	-
Middle CH	1.24	1.22	3.03	3.03	4.90	4.89	9.71	9.79	-	-	-	-
Highest CH	1.23	1.21	3.02	2.97	4.93	4.87	-	-	-	-	-	-
Mode	LTE Band 26 : 26dB BW(MHz)											
BW	1.4MHz		3MHz		5MHz		10MHz		15MHz		20MHz	
Mod.	64QAM		64QAM		64QAM		64QAM		64QAM		64QAM	
Lowest CH	1.24	-	3.03	-	4.88	-	-	-	14.36	-	-	-
Middle CH	1.21	-	2.97	-	4.92	-	9.85	-	-	-	-	-
Highest CH	1.23	-	2.98	-	4.92	-	-	-	-	-	-	-



LTE Band 26

Lowest Channel / 1.4MHz / QPSK

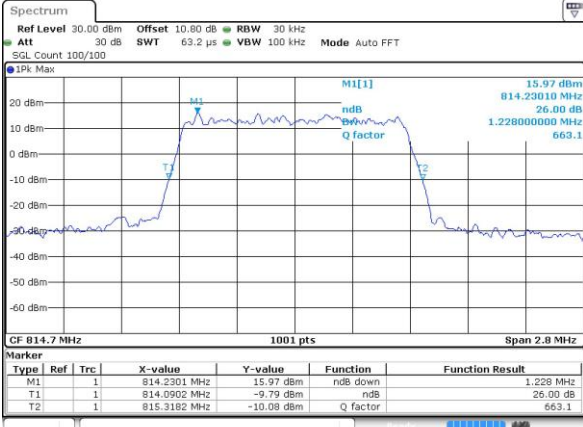

Date: 1 MAY 2019 03:10:33

Lowest Channel / 1.4MHz / 16QAM

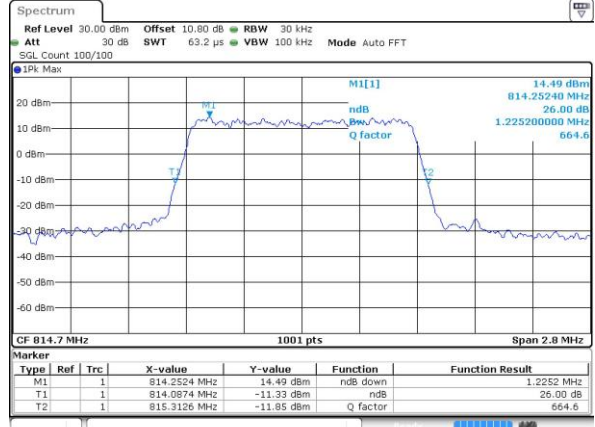

Date: 1 MAY 2019 03:10:21

Middle Channel / 1.4MHz / QPSK

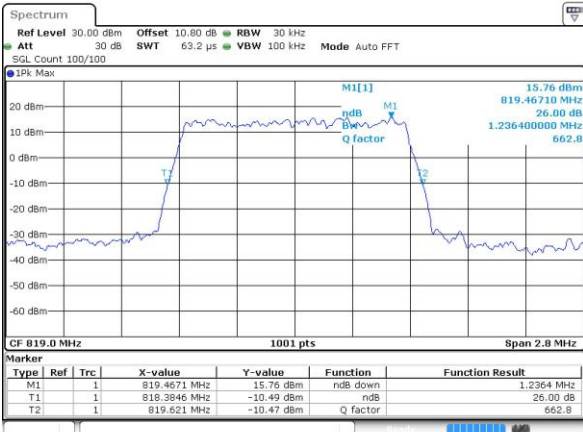

Date: 1 MAY 2019 03:11:10

Middle Channel / 1.4MHz / 16QAM

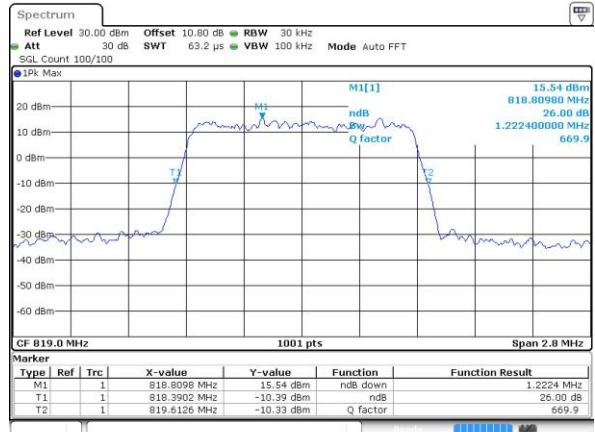

Date: 1 MAY 2019 03:11:22

Highest Channel / 1.4MHz / QPSK

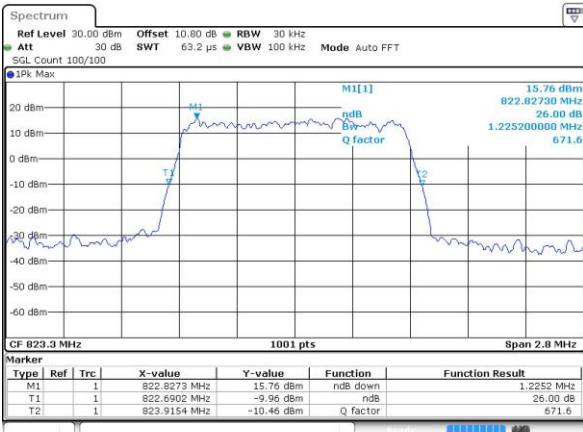

Date: 1 MAY 2019 03:11:59

Highest Channel / 1.4MHz / 16QAM

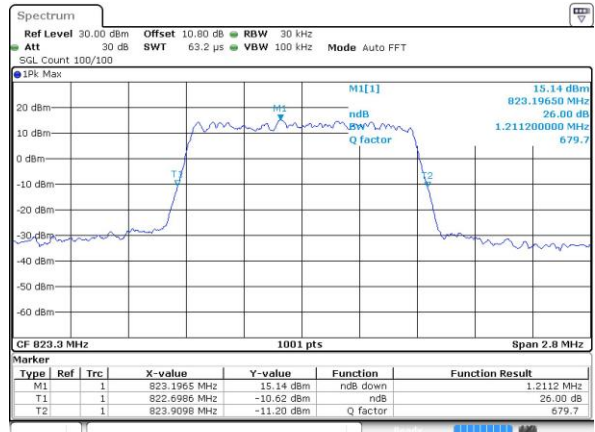

Date: 1 MAY 2019 03:12:11



LTE Band 26

Lowest Channel / 3MHz / QPSK

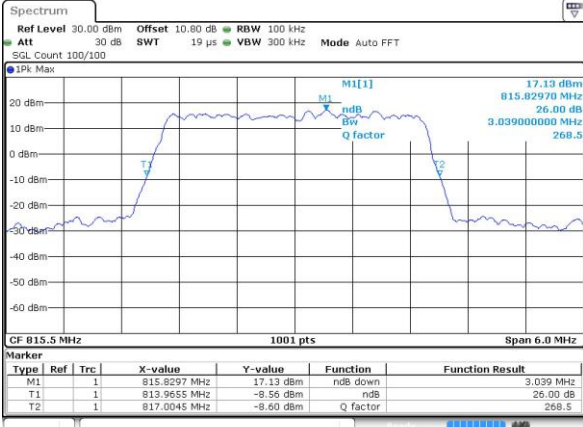

Date: 1 MAY 2019 03:02:11

Lowest Channel / 3MHz / 16QAM

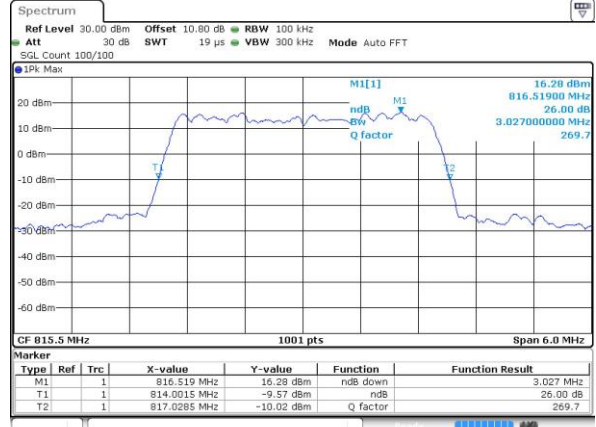

Date: 1 MAY 2019 03:02:23

Middle Channel / 3MHz / QPSK

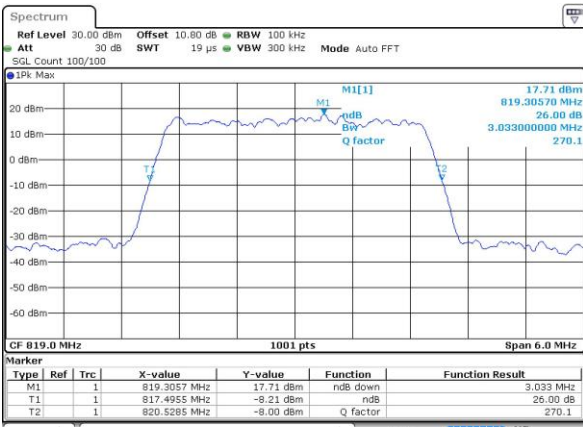

Date: 1 MAY 2019 03:03:00

Middle Channel / 3MHz / 16QAM

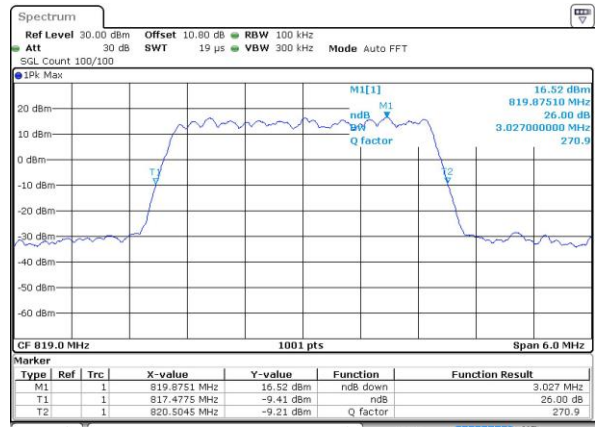

Date: 1 MAY 2019 03:03:12

Highest Channel / 3MHz / QPSK

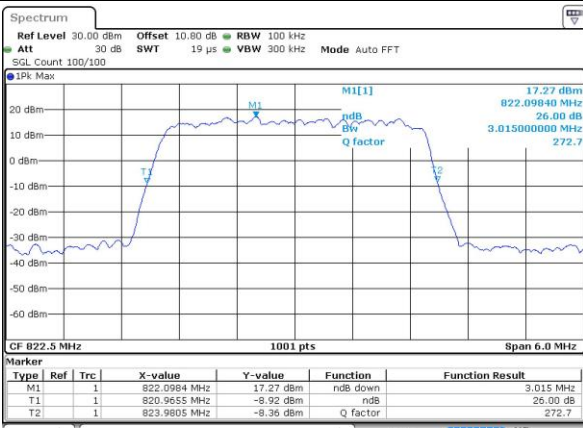

Date: 1 MAY 2019 03:03:49

Highest Channel / 3MHz / 16QAM

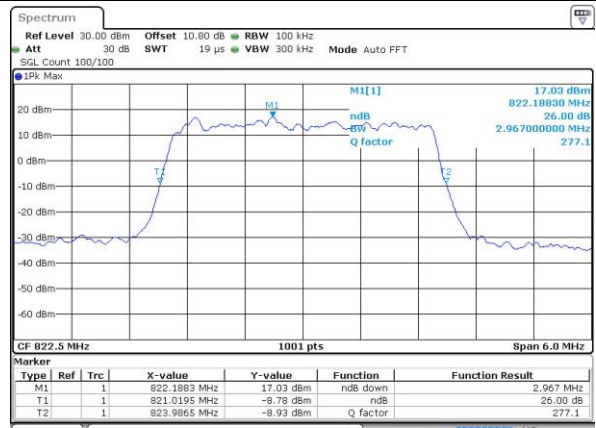

Date: 1 MAY 2019 03:04:01



LTE Band 26

Lowest Channel / 5MHz / QPSK

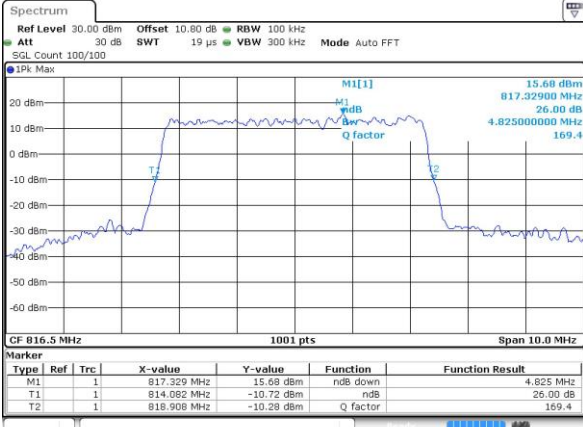

Date: 1 MAY 2019 03:04:38

Lowest Channel / 5MHz / 16QAM

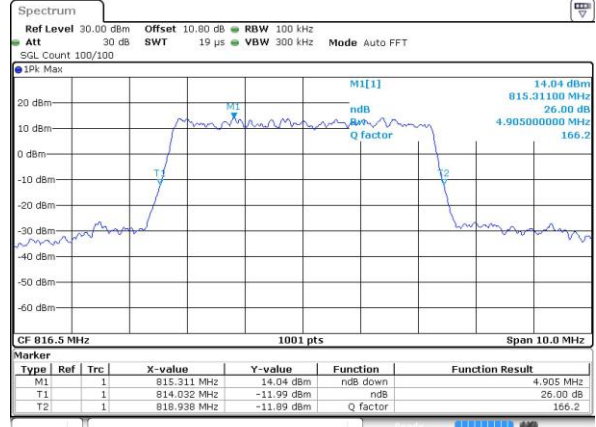

Date: 1 MAY 2019 03:04:51

Middle Channel / 5MHz / QPSK

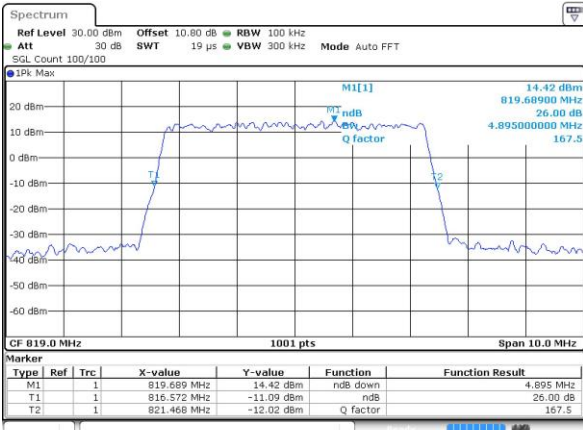

Date: 1 MAY 2019 03:05:27

Middle Channel / 5MHz / 16QAM

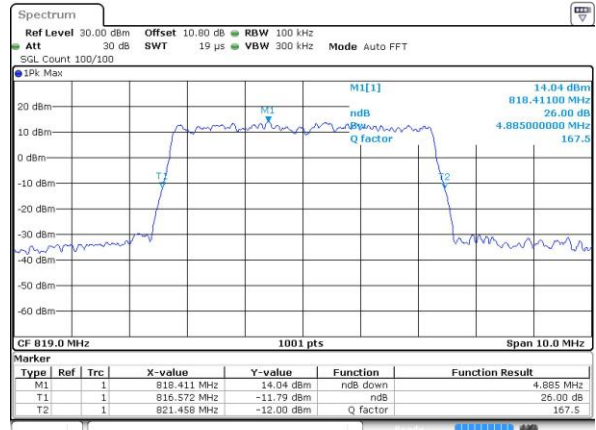

Date: 1 MAY 2019 03:05:40

Highest Channel / 5MHz / QPSK

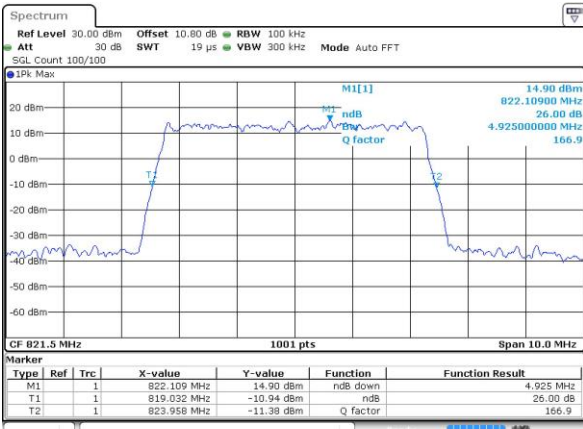

Date: 1 MAY 2019 03:06:16

Highest Channel / 5MHz / 16QAM

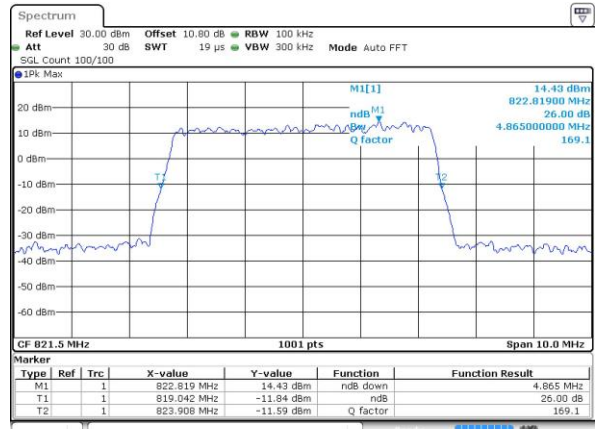

Date: 1 MAY 2019 03:06:29



LTE Band 26

Middle Channel / 10MHz / QPSK

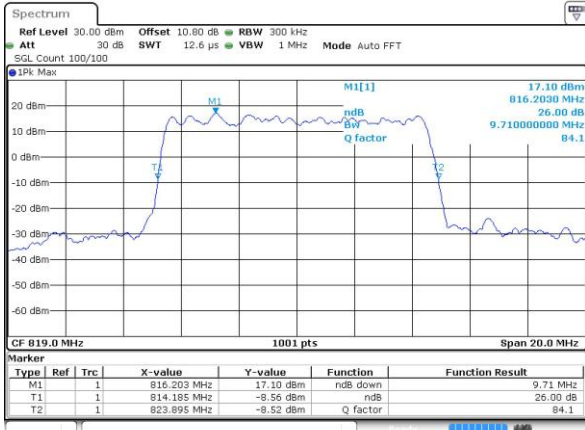

Date: 1 MAY 2019 03:07:06

Middle Channel / 10MHz / 16QAM

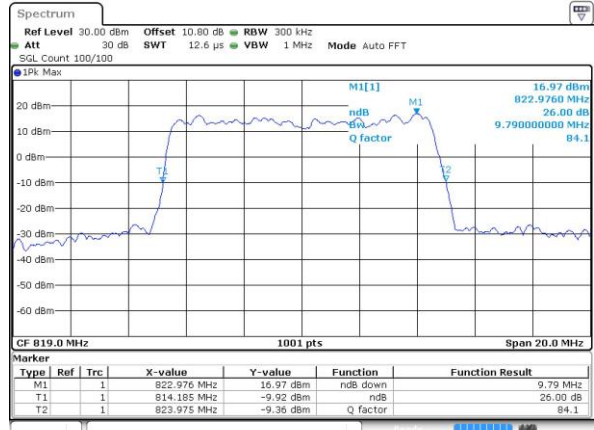

Date: 1 MAY 2019 03:07:18

Lowest Channel / 15MHz / QPSK

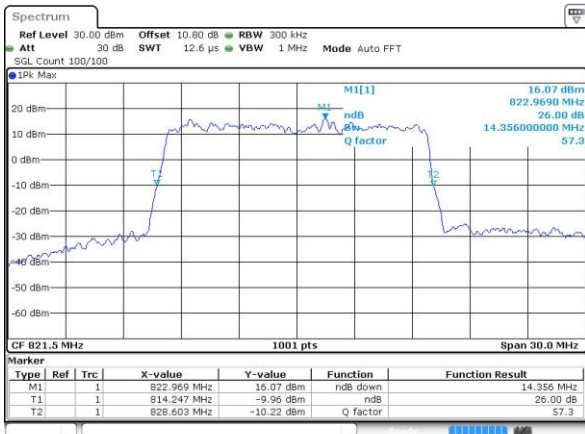

Date: 1 MAY 2019 03:08:53

Lowest Channel / 15MHz / 16QAM

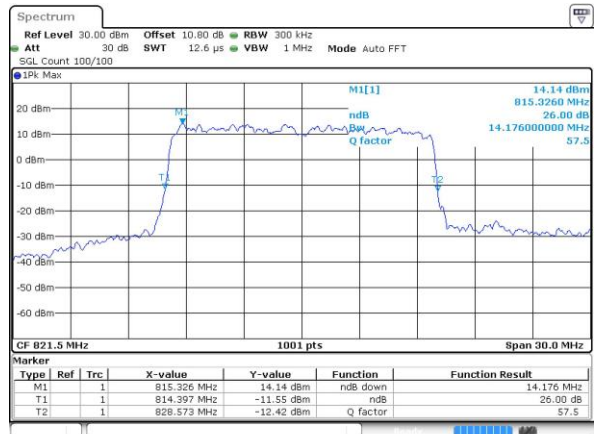

Date: 1 MAY 2019 03:08:05





LTE Band 26

Lowest Channel / 1.4MHz / 64QAM

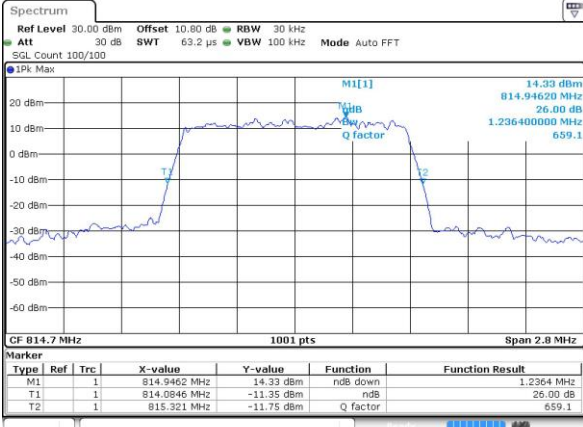

Date: 1 MAY 2019 03:00:45

Lowest Channel / 3MHz / 64QAM

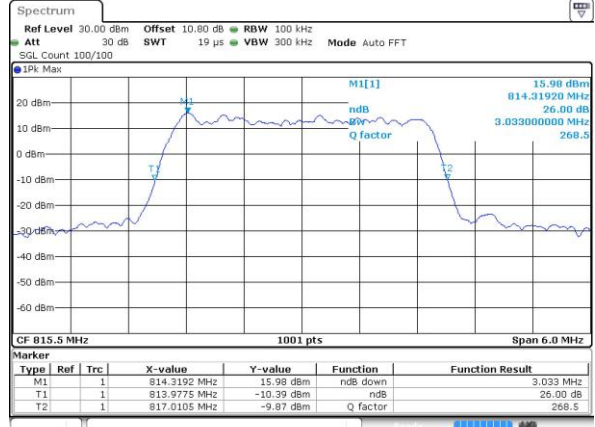

Date: 1 MAY 2019 02:56:38

Middle Channel / 1.4MHz / 64QAM

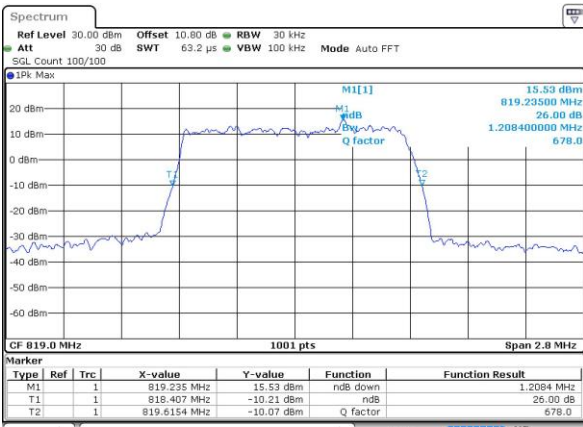

Date: 1 MAY 2019 03:01:09

Middle Channel / 3MHz / 64QAM

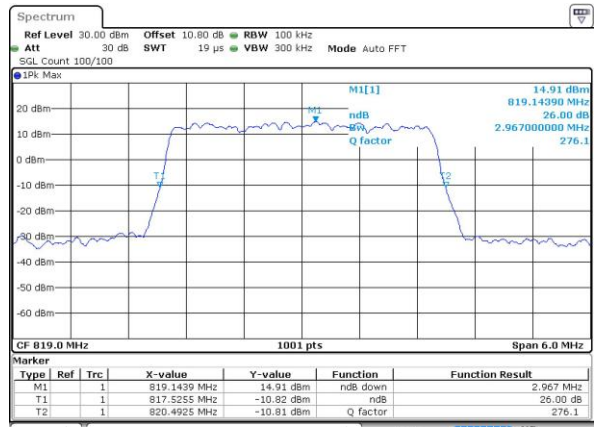

Date: 1 MAY 2019 02:57:03

Highest Channel / 1.4MHz / 64QAM

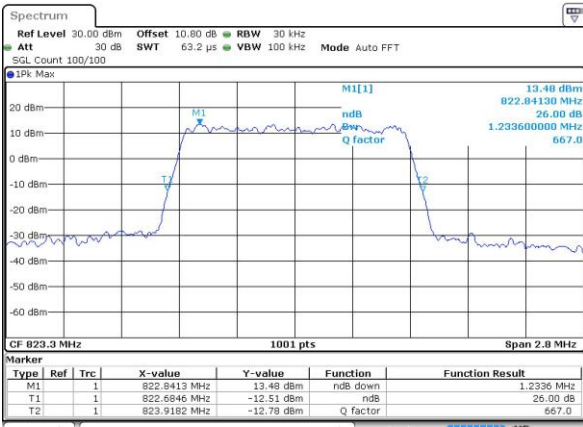

Date: 1 MAY 2019 03:01:33

Highest Channel / 3MHz / 64QAM

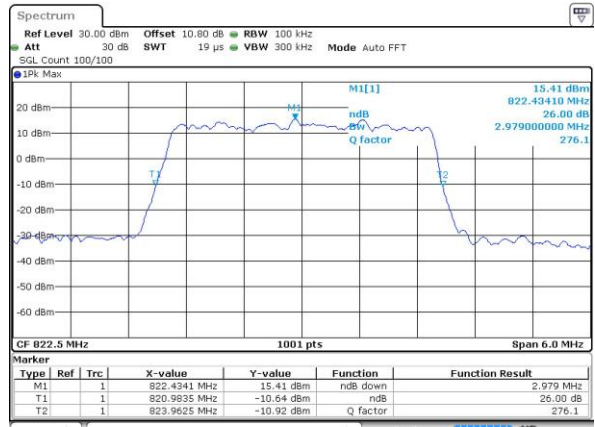

Date: 1 MAY 2019 02:57:27



LTE Band 26

Lowest Channel / 5MHz / 64QAM

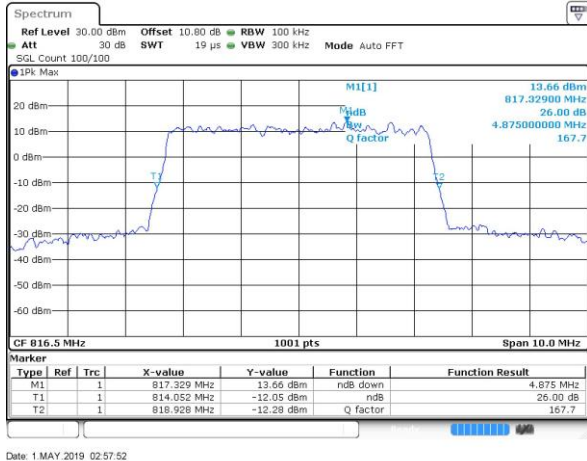

Date: 1 MAY 2019 02:57:52

Middle Channel / 5MHz / 64QAM

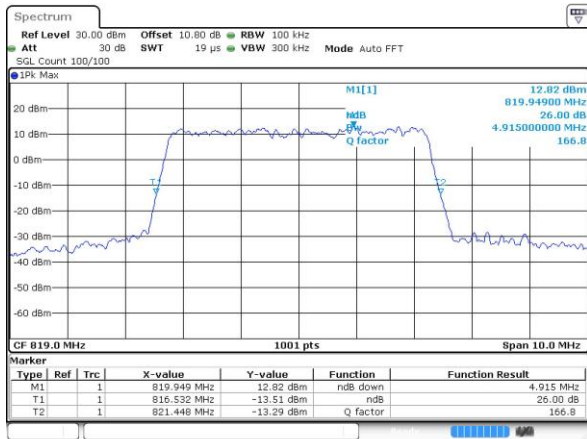

Date: 1 MAY 2019 02:58:16

Middle Channel / 10MHz / 64QAM

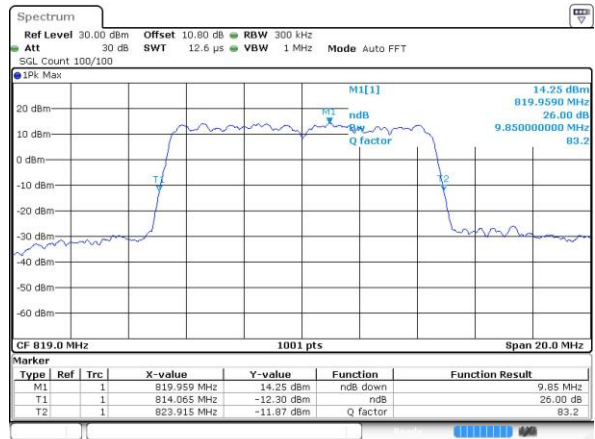

Date: 1 MAY 2019 02:59:05

Highest Channel / 5MHz / 64QAM

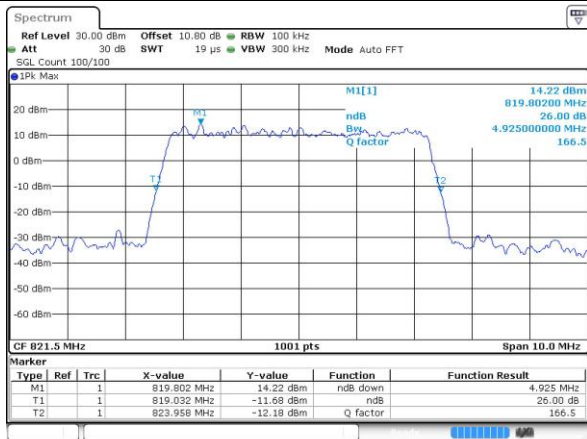

Date: 1 MAY 2019 02:58:40



LTE Band 26

Lowest Channel / 15MHz / 64QAM

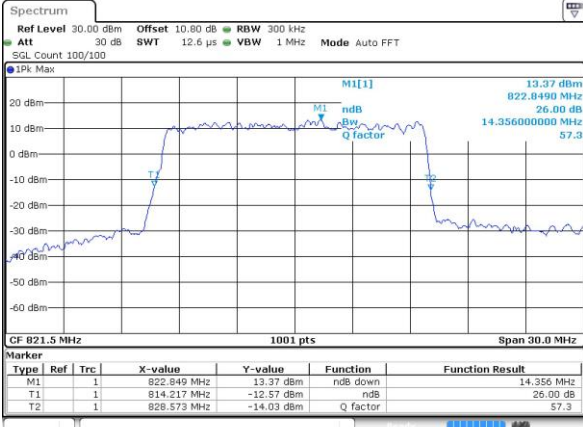

Date: 1 MAY 2019 02:59:30



**Occupied Bandwidth**

Mode	LTE Band 26 : 99%OBW(MHz)											
BW	1.4MHz		3MHz		5MHz		10MHz		15MHz		20MHz	
Mod.	QPSK	16QAM	QPSK	16QAM	QPSK	16QAM	QPSK	16QAM	QPSK	16QAM	QPSK	16QAM
Lowest CH	1.09	1.10	2.71	2.72	4.50	4.50	-	-	13.40	13.40	-	-
Middle CH	1.09	1.09	2.72	2.73	4.50	4.48	8.97	8.99	-	-	-	-
Highest CH	1.09	1.09	2.70	2.70	4.49	4.50	-	-	-	-	-	-
Mode	LTE Band 26 : 99%OBW(MHz)											
BW	1.4MHz		3MHz		5MHz		10MHz		15MHz		20MHz	
Mod.	64QAM		64QAM		64QAM		64QAM		64QAM		64QAM	
Lowest CH	1.08	-	2.73	-	4.50	-	-	-	13.34	-	-	-
Middle CH	1.09	-	2.71	-	4.50	-	9.03	-	-	-	-	-
Highest CH	1.08	-	2.72	-	4.50	-	-	-	-	-	-	-



LTE Band 26

Lowest Channel / 1.4MHz / QPSK

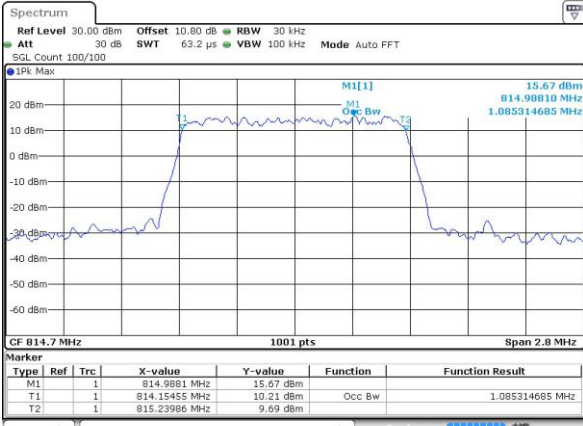

Date: 1 MAY 2019 03:09:57

Lowest Channel / 1.4MHz / 16QAM

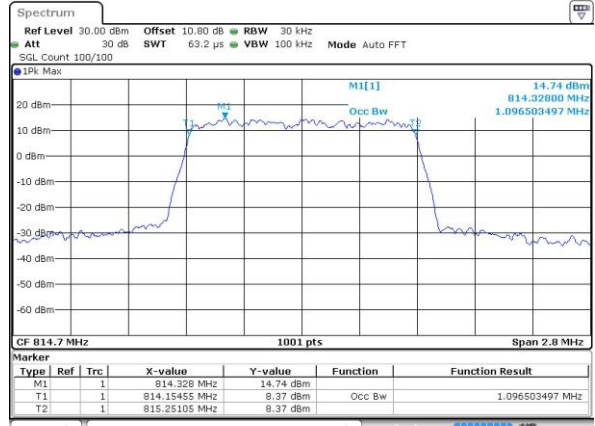

Date: 1 MAY 2019 03:10:09

Middle Channel / 1.4MHz / QPSK

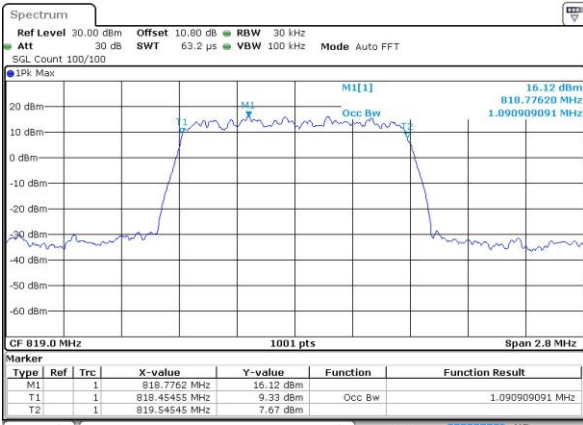

Date: 1 MAY 2019 03:10:46

Middle Channel / 1.4MHz / 16QAM

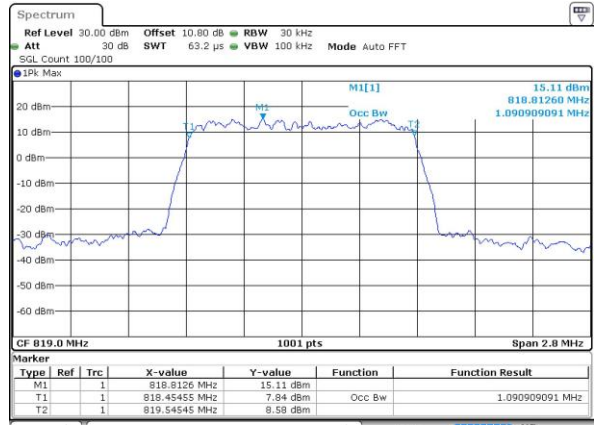

Date: 1 MAY 2019 03:10:58

Highest Channel / 1.4MHz / QPSK

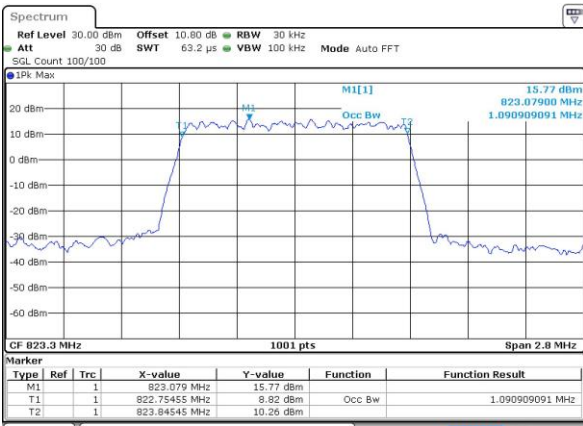

Date: 1 MAY 2019 03:11:35

Highest Channel / 1.4MHz / 16QAM

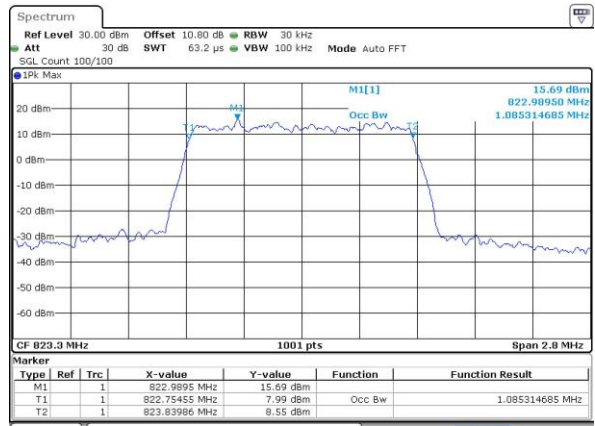

Date: 1 MAY 2019 03:11:47



LTE Band 26

Lowest Channel / 3MHz / QPSK

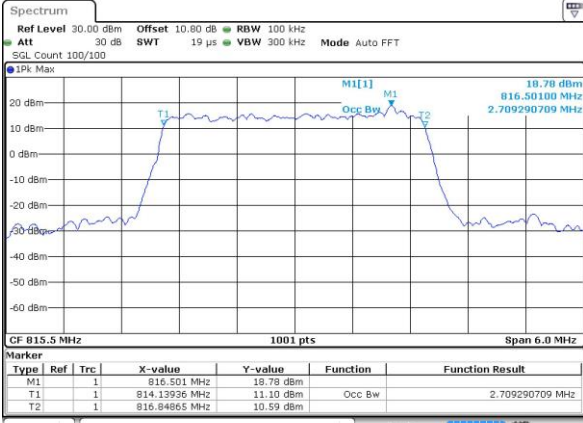

Date: 1 MAY 2019 03:01:46

Lowest Channel / 3MHz / 16QAM

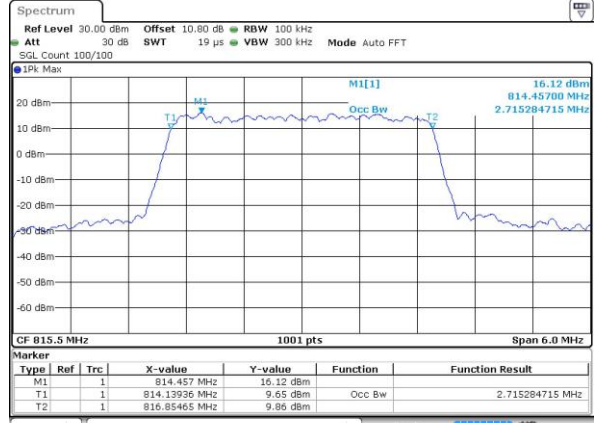

Date: 1 MAY 2019 03:01:59

Middle Channel / 3MHz / QPSK

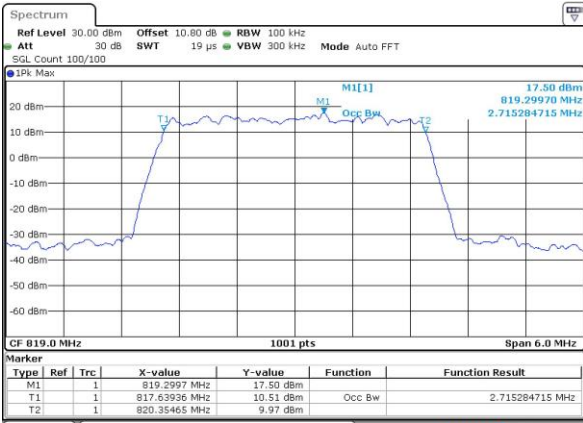

Date: 1 MAY 2019 03:02:35

Middle Channel / 3MHz / 16QAM

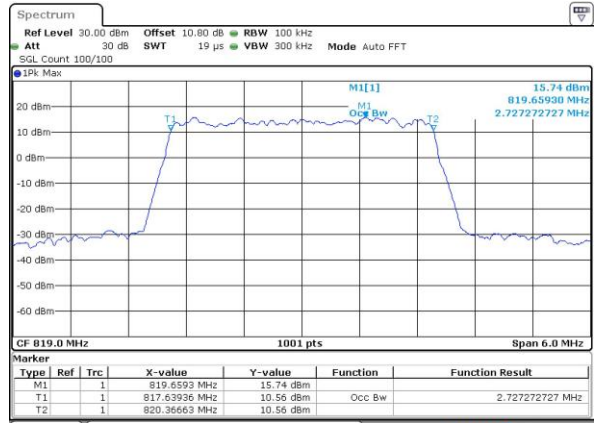

Date: 1 MAY 2019 03:02:47

Highest Channel / 3MHz / QPSK

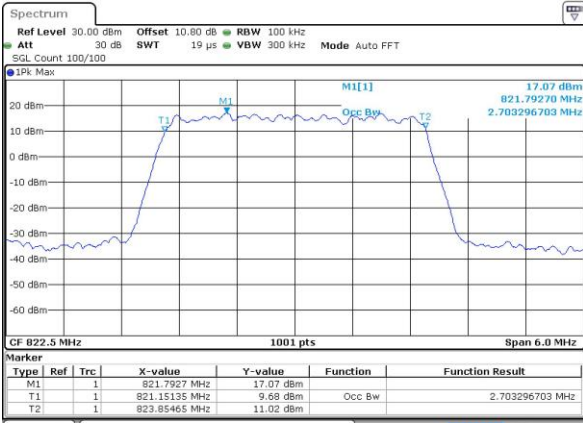

Date: 1 MAY 2019 03:03:24

Highest Channel / 3MHz / 16QAM

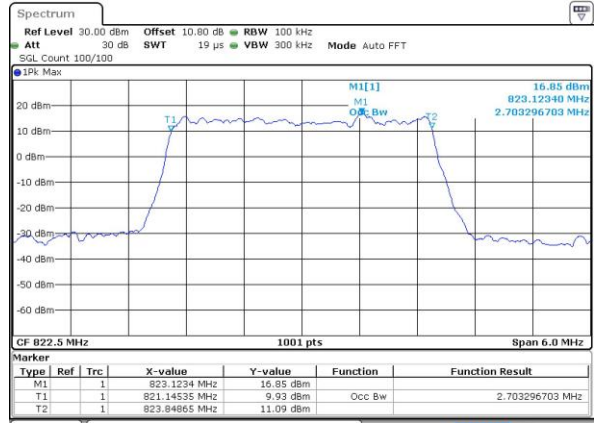

Date: 1 MAY 2019 03:03:36



LTE Band 26

Lowest Channel / 5MHz / QPSK

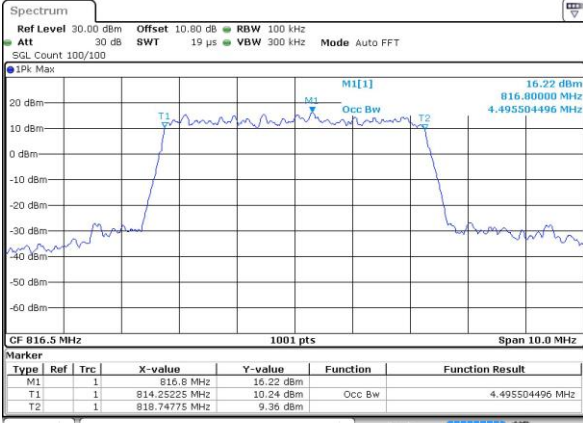

Date: 1 MAY 2019 03:04:14

Lowest Channel / 5MHz / 16QAM

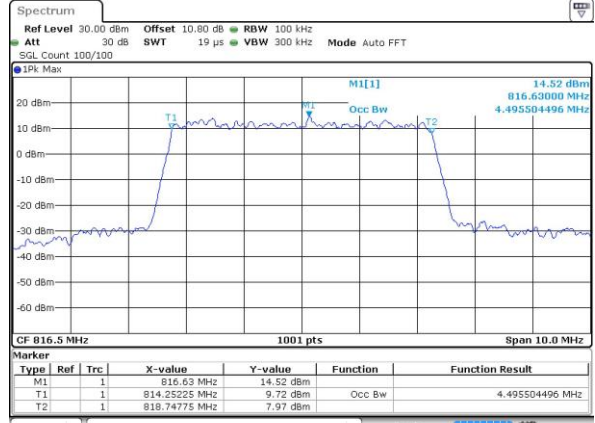

Date: 1 MAY 2019 03:04:26

Middle Channel / 5MHz / QPSK

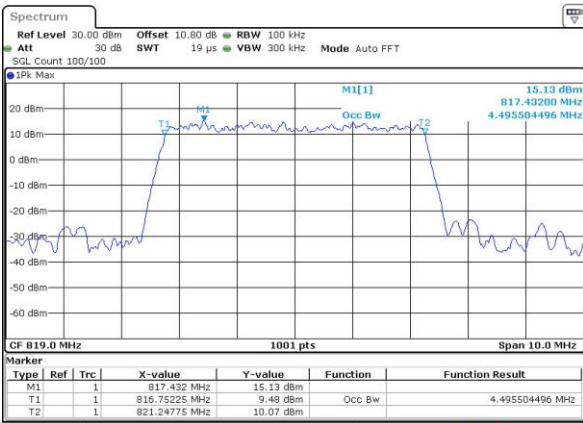

Date: 1 MAY 2019 03:05:03

Middle Channel / 5MHz / 16QAM

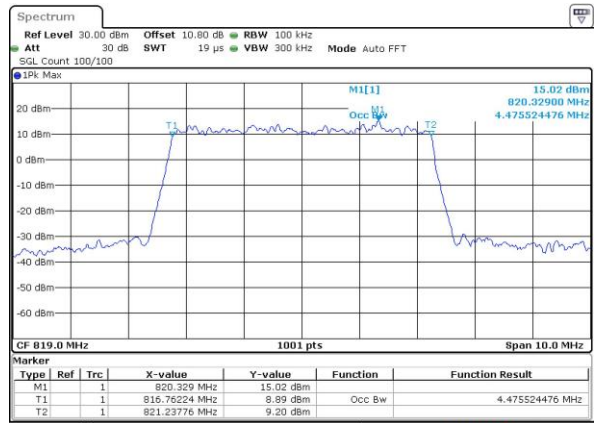

Date: 1 MAY 2019 03:05:15

Highest Channel / 5MHz / QPSK

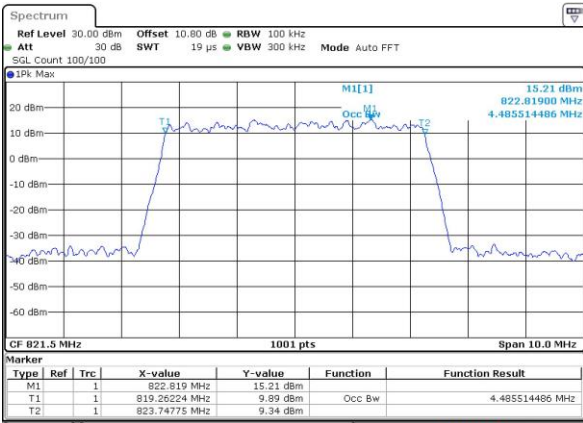

Date: 1 MAY 2019 03:05:52

Highest Channel / 5MHz / 16QAM

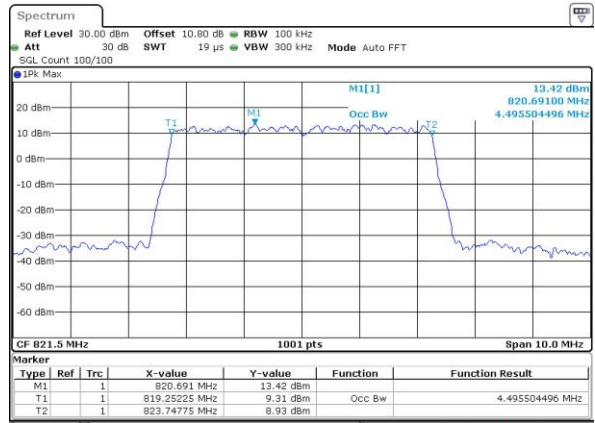

Date: 1 MAY 2019 03:06:04



LTE Band 26

Middle Channel / 10MHz / QPSK

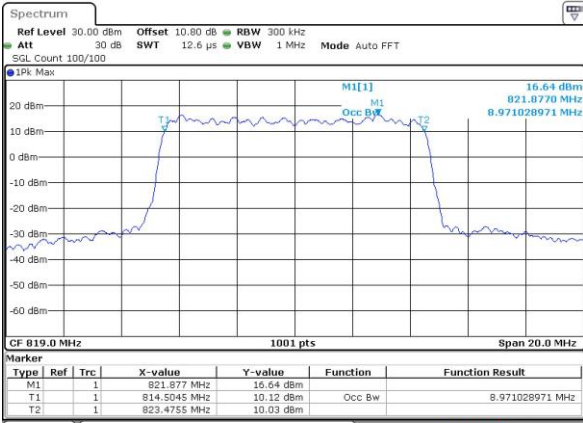

Date: 1 MAY 2019 03:06:41

Middle Channel / 10MHz / 16QAM

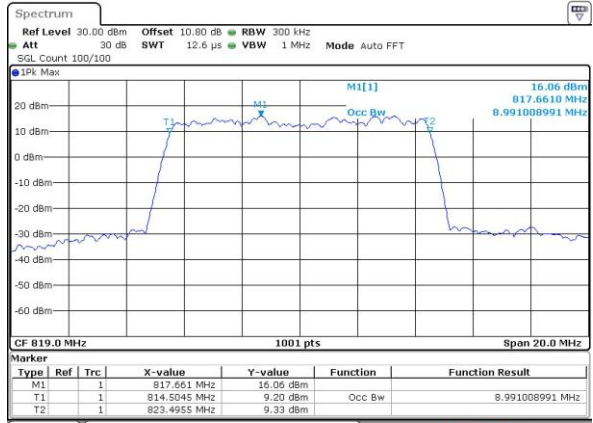

Date: 1 MAY 2019 03:06:54

LTE Band 26

Lowest Channel / 15MHz / QPSK

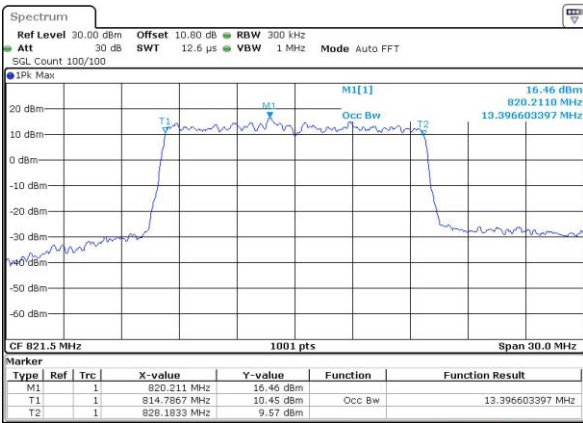

Date: 1 MAY 2019 03:08:28

Lowest Channel / 15MHz / 16QAM

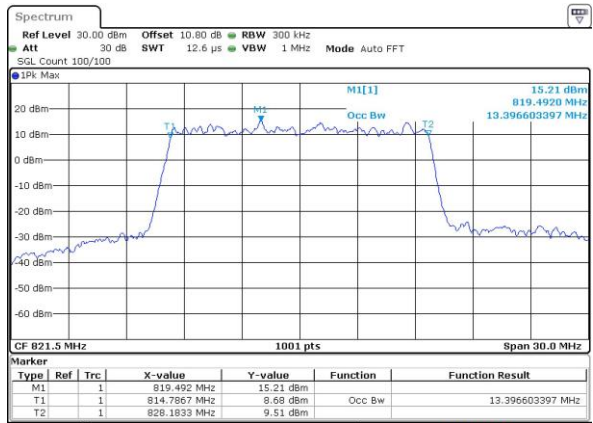

Date: 1 MAY 2019 03:08:41





LTE Band 26

Lowest Channel / 1.4MHz / 64QAM

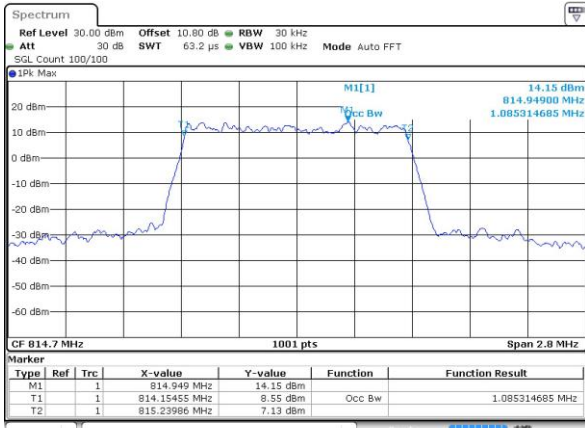

Lowest Channel / 3MHz / 64QAM

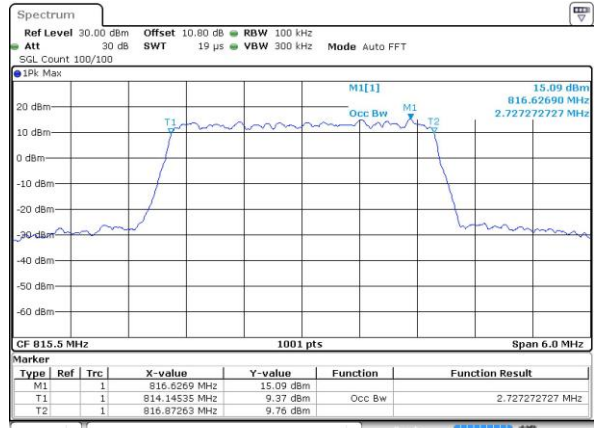

Middle Channel / 1.4MHz / 64QAM

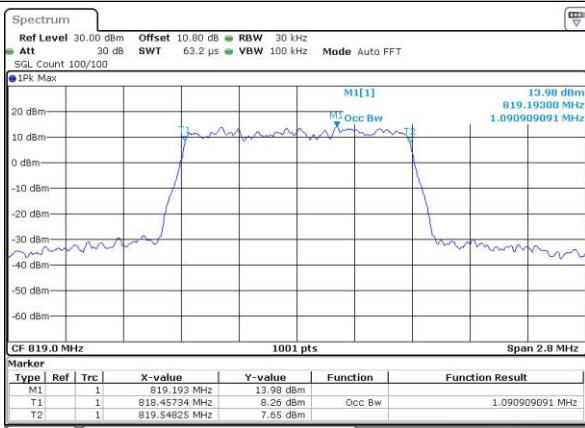

Middle Channel / 3MHz / 64QAM

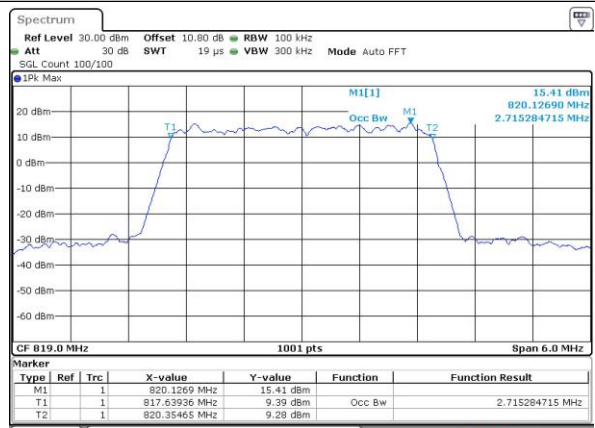

Highest Channel / 1.4MHz / 64QAM

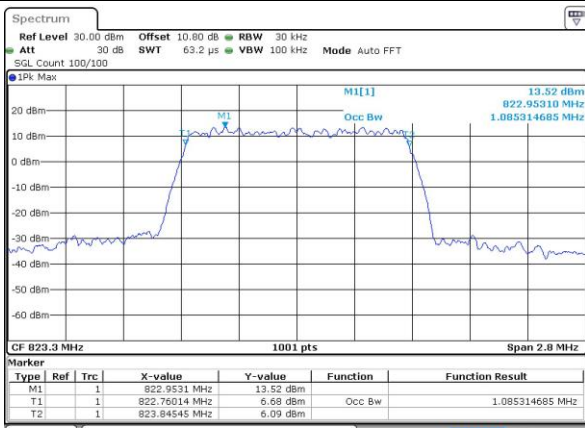

Highest Channel / 3MHz / 64QAM

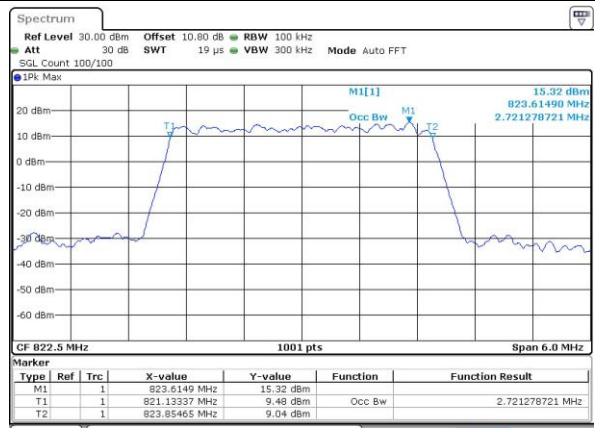



LTE Band 26

Lowest Channel / 5MHz / 64QAM

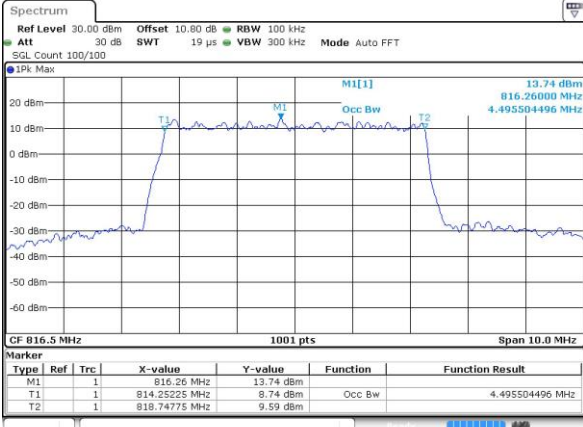

Date: 1 MAY 2019 02:57:40

Middle Channel / 5MHz / 64QAM

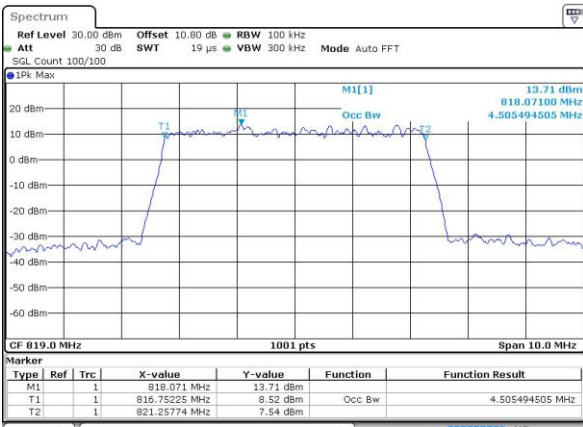

Date: 1 MAY 2019 02:58:04

Middle Channel / 10MHz / 64QAM

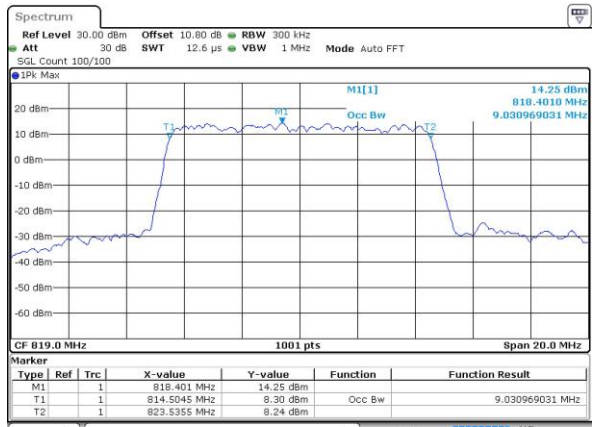

Date: 1 MAY 2019 02:58:53

Highest Channel / 5MHz / 64QAM

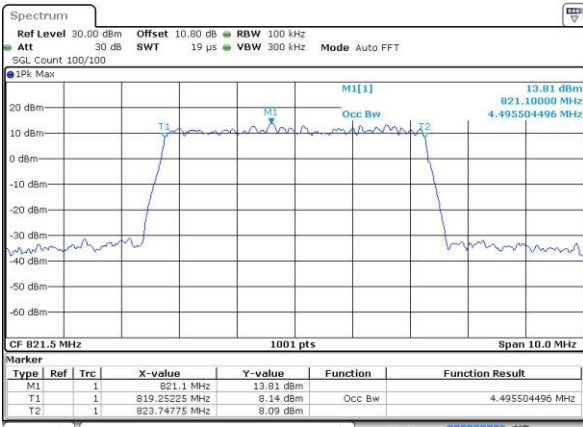

Date: 1 MAY 2019 02:58:28



LTE Band 26

Lowest Channel / 15MHz / 64QAM

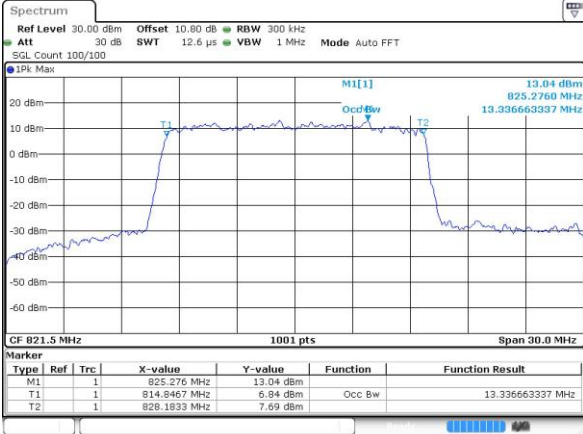



Emission masks – In-band emissions

