



FCC CO-LOCATION RADIO TEST REPORT

FCC ID : A4RG020I
Equipment : Phone
Model Name : G020I
Applicant : Google LLC
1600 Amphitheatre Parkway,
Mountain View, California, 94043 USA
Standard : FCC Part 15 Subpart E §15.407

The product was received on Nov. 06, 2018 and testing was started from Apr. 15, 2019 and completed on Apr. 28, 2019. We, SPORTON INTERNATIONAL INC. EMC & Wireless Communications Laboratory, would like to declare that the tested sample has been evaluated in accordance with the test procedures and has been in compliance with the applicable technical standards.

The report must not be used by the client to claim product certification, approval, or endorsement by TAF or any agency of government.

The test results in this report apply exclusively to the tested model / sample. Without written approval of SPORTON INTERNATIONAL INC. EMC & Wireless Communications Laboratory, the test report shall not be reproduced except in full.

Approved by: Jones Tsai

SPORTON INTERNATIONAL INC. EMC & Wireless Communications Laboratory
No. 52, Huaya 1st Rd., Guishan Dist., Taoyuan City, Taiwan (R.O.C.)



Table of Contents

History of this test report.....	3
Summary of Test Result.....	4
1 General Description	5
1.1 Product Feature of Equipment Under Test.....	5
1.2 Product Specification of Equipment Under Test.....	5
1.3 Modification of EUT	5
1.4 Testing Location	6
1.5 Applicable Standards.....	6
2 Test Configuration of Equipment Under Test	7
2.1 Carrier Frequency and Channel	7
2.2 Test Mode.....	7
2.3 Connection Diagram of Test System.....	8
2.4 Support Unit used in test configuration and system	9
2.5 EUT Operation Test Setup	9
3 Test Result	10
3.1 Unwanted Emissions Measurement.....	10
3.2 Antenna Requirements	14
4 List of Measuring Equipment.....	15
5 Uncertainty of Evaluation	16
Appendix A. Radiated Spurious Emission	
Appendix B. Radiated Spurious Emission Plots	
Appendix C. Duty Cycle Plots	



History of this test report

Report No.	Version	Description	Issued Date
FR8N0616-05G	01	Initial issue of report	Jun. 25, 2019
FR8N0616-05G	02	Revise the antenna numbers in the report	Jul. 08, 2019



Summary of Test Result

Report Clause	Ref Std. Clause	Test Items	Result (PASS/FAIL)	Remark
3.1	15.407(b)	Unwanted Emissions	Pass	Under limit 2.58 dB at 5150.000 MHz
3.2	15.203 15.407(a)	Antenna Requirement	Pass	-

Declaration of Conformity:

The test results with all measurement uncertainty excluded are presented in accordance with the regulation limits or requirements declared by manufacturers.

Comments and Explanations:

The declared of product specification for EUT presented in the report are provided by the manufacturer, and the manufacturer takes all the responsibilities for the accuracy of product specification.

Reviewed by: Wii Chang

Report Producer: Maggie Chiang



1 General Description

1.1 Product Feature of Equipment Under Test

Product Feature	
Equipment	Phone
Model Name	G020I
FCC ID	A4RG020I
EUT supports Radios application	CDMA/EV-DO/GSM/EGPRS/WCDMA/HSPA/LTE/NFC/GNSS/WPC WLAN 11b/g/n HT20 WLAN 11a/n HT20/HT40 WLAN 11ac VHT20/VHT40/VHT80 Bluetooth BR/EDR/LE 60 GHz Low Power Transmitter
EUT Stage	Identical Prototype

Remark: The above EUT's information was declared by manufacturer.

EUT Information List	
No.	S/N
#1	935AZ06969
#2	935AZ06999

1.2 Product Specification of Equipment Under Test

Standards-related Product Specification	
Tx/Rx Frequency Range	2400 MHz ~ 2483.5 MHz 5180 MHz ~ 5240 MHz
Antenna Type / Gain	<Bluetooth> IFA Antenna type with gain -0.50 dBi <2400 MHz ~ 2483.5 MHz> Ant. 2 : IFA Antenna type with gain -0.50 dBi Ant. 3 : ILA Antenna type with gain -1.00 dBi <5180 MHz ~ 5240 MHz> Ant. 2 : IFA Antenna type with gain 2.80 dBi Ant. 5 : ILA Antenna type with gain -1.50 dBi
Type of Modulation	Bluetooth EDR (3Mbps) : 8-DPSK Bluetooth LE : GFSK 802.11b : DSSS (DBPSK / DQPSK / CCK) 802.11a : OFDM (BPSK / QPSK / 16QAM / 64QAM)

1.3 Modification of EUT

No modifications are made to the EUT during all test items.



1.4 Testing Location

Test Site	SPORTON INTERNATIONAL INC. EMC & Wireless Communications Laboratory
Test Site Location	No.58, Aly. 75, Ln. 564, Wenhua 3rd, Rd., Guishan Dist., Taoyuan City, Taiwan (R.O.C.) TEL: +886-3-327-0868 FAX: +886-3-327-0855
Test Site No.	Sporton Site No. 03CH13-HY

Note: The test site complies with ANSI C63.4 2014 requirement.

FCC Designation No. TW0007

1.5 Applicable Standards

According to the specifications of the manufacturer, the EUT must comply with the requirements of the following standards:

- ♦ FCC Part 15 Subpart E
- ♦ FCC KDB 789033 D02 General UNII Test Procedures New Rules v02r01.
- ♦ FCC KDB 414788 D01 Radiated Test Site v01r01.
- ♦ FCC KDB 662911 D01 Multiple Transmitter Output v02r01.
- ♦ FCC KDB Publication No. 558074 D01 DTS Meas. Guidance v05r02
- ♦ ANSI C63.10-2013

Remark:

1. All test items were verified and recorded according to the standards and without any deviation during the test.
2. This EUT has also been tested and complied with the requirements of FCC Part 15, Subpart B, recorded in a separate test report.



2 Test Configuration of Equipment Under Test

The EUT has been associated with peripherals and configuration operated in a manner tended to maximize its emission characteristics in a typical application. Frequency range investigated: radiation emission (9 kHz to the 10th harmonic of the highest fundamental frequency or to 40 GHz, whichever is lower). For radiated measurement, pre-scanned in three orthogonal panels, X, Y, Z. The worst cases (X plane) were recorded in this report.

2.1 Carrier Frequency and Channel

2400-2483.5 MHz Bluetooth 8-DPSK		2400-2483.5 MHz Bluetooth – LE	
Channel	Freq. (MHz)	Channel	Freq. (MHz)
78	2480	39	2480

2400-2483.5 MHz 802.11b		5150~5250 MHz 802.11a	
Channel	Freq. (MHz)	Channel	Freq. (MHz)
11	2462	36	5180

2.2 Test Mode

Final test modes are considering the modulation and worse data rates as below table.

<Co-Location>

Modulation	Data Rate
Bluetooth EDR + 5GHz 802.11a for MIMO Ant. 2+5	3Mbps + 6Mbps
Bluetooth – LE + 5GHz 802.11a for MIMO Ant. 2+5	2Mbps + 6Mbps
2.4GHz 802.11b for Ant. 2 + 5GHz 802.11a for Ant. 5	1Mbps + 6Mbps

Remark: For Radiated Test Cases, the tests were performed with Adapter 1.

2.3 Connection Diagram of Test System

<Bluetooth Tx Mode>

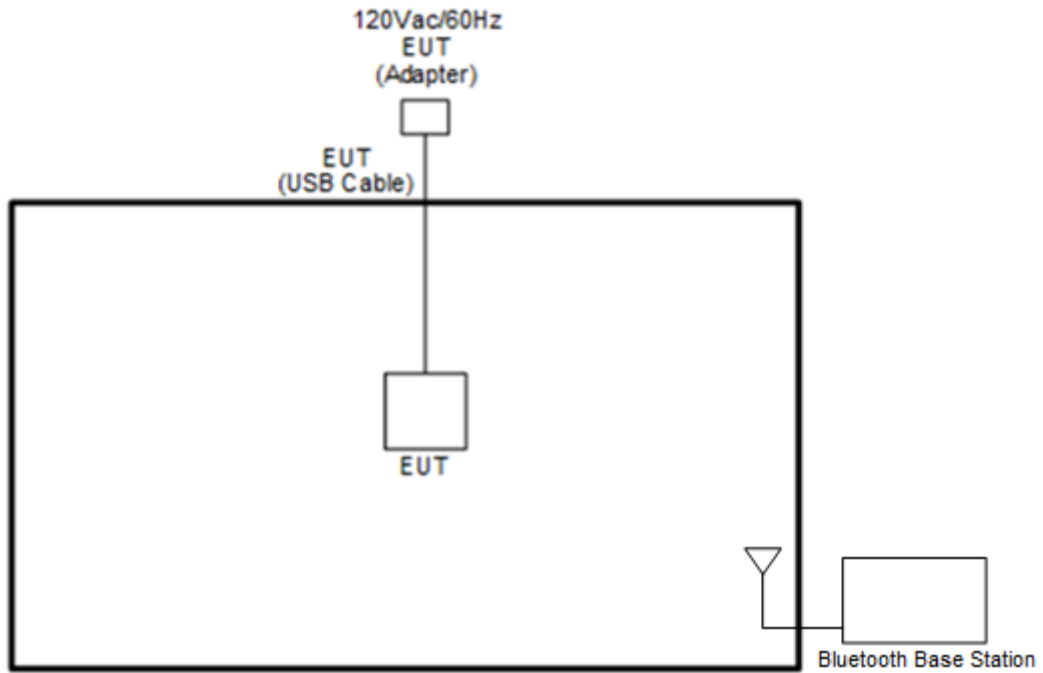

<Bluetooth-LE and WLAN Tx Mode>

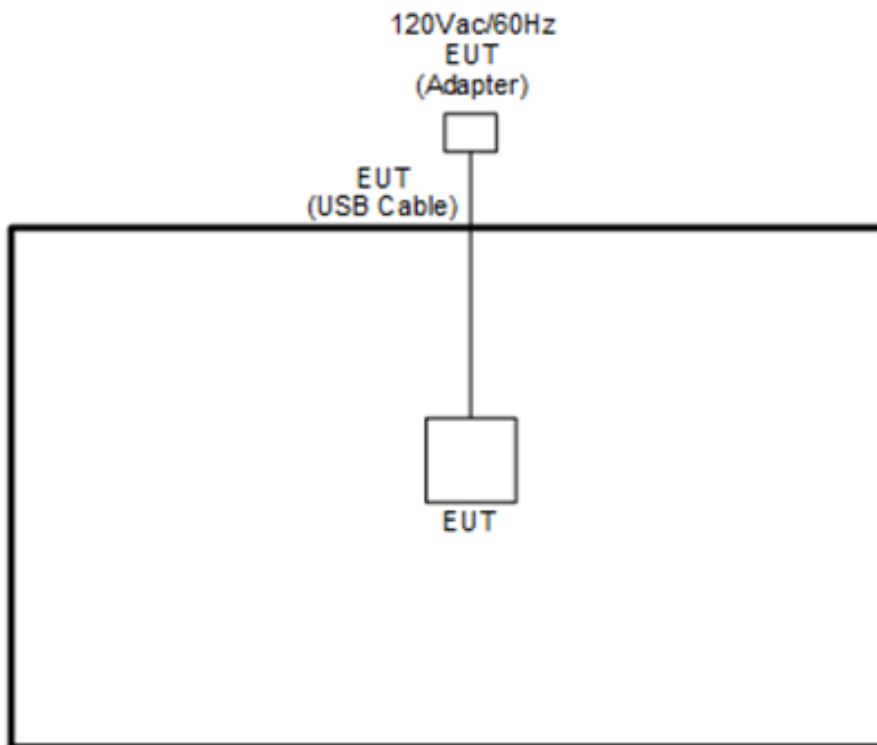



2.4 Support Unit used in test configuration and system

Item	Equipment	Trade Name	Model Name	FCC ID	Data Cable	Power Cord
1.	Bluetooth Base Station	R&S	CBT32	N/A	N/A	Unshielded, 1.8 m

2.5 EUT Operation Test Setup

The RF test items, utility “Qualcomm Radio Control Toolkit version : 3.0.298.0” was installed in Notebook which was programmed in order to make the EUT get into the engineering modes to provide channel selection, power level, data rate and the application type and for continuous transmitting signals.



3 Test Result

3.1 Unwanted Emissions Measurement

This section is to measure unwanted emissions through radiated measurement for band edge spurious emissions and out of band emissions measurement.

3.1.1 Limit of Unwanted Emissions

(1) Unwanted spurious emissions fallen in restricted bands shall comply with the general field strength limits as below table,

Frequency (MHz)	Field Strength (microvolts/meter)	Measurement Distance (meters)
0.009 – 0.490	2400/F(kHz)	300
0.490 – 1.705	24000/F(kHz)	30
1.705 – 30.0	30	30
30 – 88	100	3
88 – 216	150	3
216 - 960	200	3
Above 960	500	3

Note: The following formula is used to convert the EIRP to field strength.

$$E = \frac{1000000\sqrt{30P}}{3} \mu\text{V/m, where P is the eirp (Watts)}$$

EIRP (dBm)	Field Strength at 3m (dBμV/m)
- 27	68.3

(2) KDB789033 D02 v02r01 G)2)c)

- (i) Section 15.407(b)(1) to (b)(3) specify the unwanted emission limits for the U-NII-1 and U-NII-2 bands. As specified, emissions above 1000 MHz that are outside of the restricted bands are subject to a peak emission limit of -27 dBm/MHz.³
- (ii) Section 15.407(b)(4) specifies the unwanted emission limit for the U-NII-3 band. A band emissions mask is specified in Section 15.407(b)(4)(i). The emission limits are in terms of a Peak detector. An alternative to the band emissions mask is specified in Section 15.407(b)(4)(ii). The alternative limits are based on the highest antenna gain specified in the filing. There are also marketing and importation restrictions for the devices using the alternative limit.⁴

Note 3: An out-of-band emission that complies with both the average and peak limits of Section 15.209 is not required to satisfy the -27 dBm/MHz peak emission limit.

Note 4: Only devices with antenna gains of 10 dBi or less may be approved using the emission limits specified in Section 15.247(d) till March 2, 2018; all other devices operating in this band must use the mask specified in Section 15.407(b)(4)(i).



3.1.2 Measuring Instruments

See list of measuring equipment of this test report.

3.1.3 Test Procedures

1. The testing follows FCC KDB 789033 D02 General UNII Test Procedures New Rules **v02r01**.
Section G) Unwanted emissions measurement.
 - (1) Procedure for Unwanted Emissions Measurements Below 1000MHz
 - RBW = 120 kHz
 - VBW = 300 kHz
 - Detector = Peak
 - Trace mode = max hold
 - (2) Procedure for Peak Unwanted Emissions Measurements Above 1000 MHz
 - RBW = 1 MHz
 - VBW \geq 3 MHz
 - Detector = Peak
 - Sweep time = auto
 - Trace mode = max hold
 - (3) Procedures for Average Unwanted Emissions Measurements Above 1000MHz
 - RBW = 1 MHz
 - VBW = 10 Hz, when duty cycle is no less than 98 percent.
 - VBW \geq 1/T, when duty cycle is less than 98 percent where T is the minimum transmission duration over which the transmitter is on and is transmitting at its maximum power control level for the tested mode of operation.
2. The EUT was placed on a turntable with 0.8 meter for frequency below 1GHz and 1.5 meter for frequency above 1GHz respectively above ground.
3. The EUT was set 3 meters from the interference receiving antenna which was mounted on the top of a variable height antenna tower.
4. The antenna is a broadband antenna and its height is adjusted between one meter and four meters above ground to find the maximum value of the field strength for both horizontal polarization and vertical polarization of the antenna.
5. For each suspected emission, the EUT was arranged to its worst case and then adjust the antenna tower (from 1 m to 4 m) and turntable (from 0 degree to 360 degrees) to find the maximum reading.
6. For testing below 1GHz, if the emission level of the EUT in peak mode was 3 dB lower than the limit specified, then peak values of EUT will be reported, otherwise, the emissions will be repeated one by one using the CISPR quasi-peak method and reported.
7. For testing above 1GHz, the emission level of the EUT in peak mode was 20dB lower than average limit (that means the emission level in average mode also complies with the limit in average mode), then peak values of EUT will be reported, otherwise, the emissions will be measured in average mode again and reported.

3.1.4 Test Setup

For radiated emissions below 30MHz

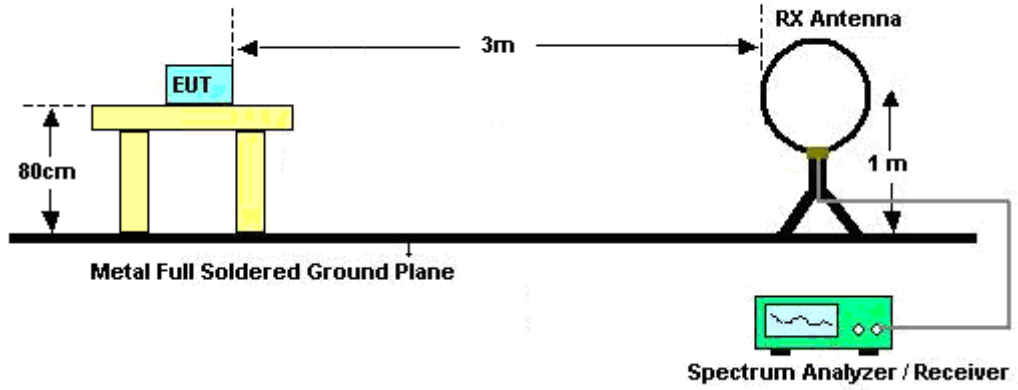

For radiated emissions from 30MHz to 1GHz

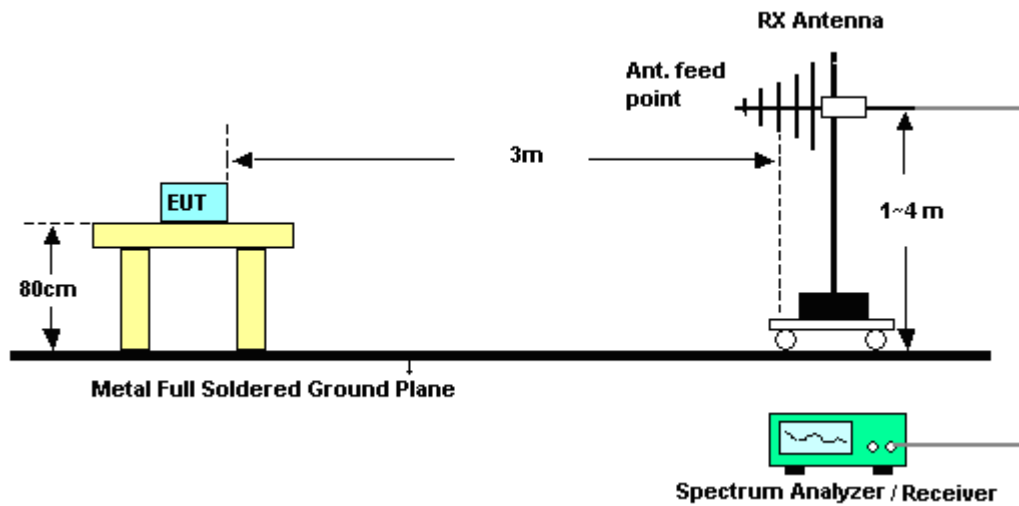

For radiated emissions above 1GHz

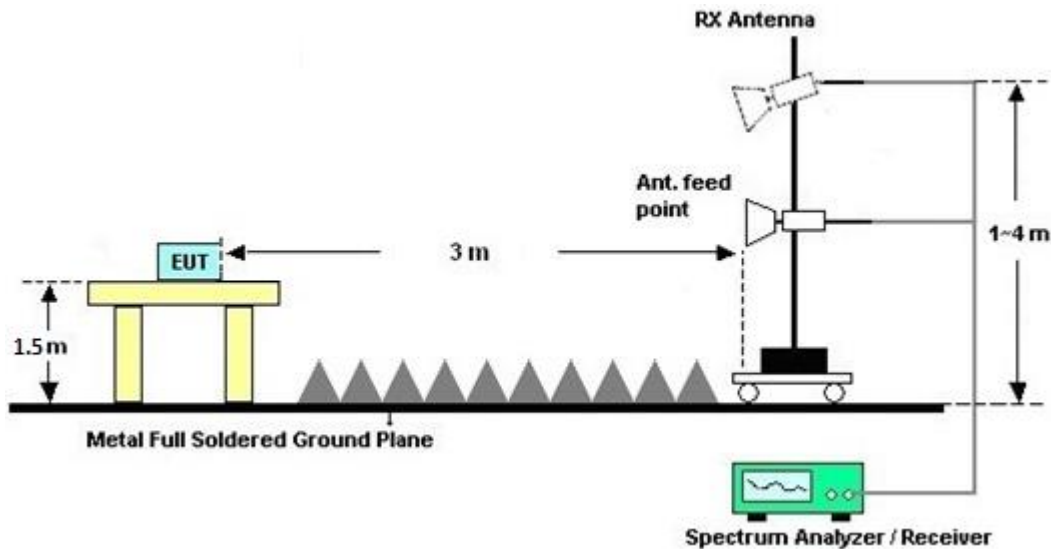

3.1.5 Test Results of Radiated Spurious Emissions (9 kHz ~ 30 MHz)

The low frequency, which started from 9 kHz to 30MHz, was pre-scanned and the result which was 20dB lower than the limit line was not reported.

There is a comparison data of both open-field test site and alternative test site - semi-Anechoic chamber according to 414788 D01 Radiated Test Site v01r01, and the result came out very similar.

3.1.6 Test Result of Radiated Spurious at Band Edges

Please refer to Appendix A and B.

3.1.7 Duty Cycle

Please refer to Appendix C.

3.1.8 Test Result of Radiated Spurious Emissions (30MHz ~ 10th Harmonic)

Please refer to Appendix A and B.



3.2 Antenna Requirements

3.2.1 Standard Applicable

If transmitting antenna directional gain is greater than 6 dBi, both the peak transmit power and the peak power spectral density shall be reduced by the amount in dB that the directional gain of the antenna exceeds 6 dBi.

3.2.2 Antenna Anti-Replacement Construction

An embedded-in antenna design is used.

3.2.3 Antenna Gain

The antenna peak gain of EUT is less than 6 dBi. Therefore, it is not necessary to reduce maximum peak output power limit.



4 List of Measuring Equipment

Instrument	Manufacturer	Model No.	Serial No.	Characteristics	Calibration Date	Test Date	Due Date	Remark
Loop Antenna	Rohde & Schwarz	HFH2-Z2	100488	9 kHz~30 MHz	Jan. 07, 2019	Apr. 15, 2019 ~ Apr. 28, 2019	Jan. 06, 2020	Radiation (03CH13-HY)
Horn Antenna	SCHWARZBECK	BBHA 9120 D	9120D-1241	1GHz ~ 18GHz	Jun. 29, 2018	Apr. 15, 2019 ~ Apr. 28, 2019	Jun. 28, 2019	Radiation (03CH13-HY)
Bilog Antenna	TESEQ	CBL 6111D&00800 N1D01N-06	37059&01	30MHz~1GHz	Oct. 13, 2018	Apr. 15, 2019 ~ Apr. 28, 2019	Oct. 12, 2019	Radiation (03CH13-HY)
SHF-EHF Horn Antenna	SCHWARZBECK	BBHA 9170	BBHA9170584	18GHz- 40GHz	Dec. 05, 2018	Apr. 15, 2019 ~ Apr. 28, 2019	Dec. 04, 2019	Radiation (03CH13-HY)
Preamplifier	Keysight	83017A	MY53270080	1GHz~26.5GHz	Nov. 14, 2018	Apr. 15, 2019 ~ Apr. 28, 2019	Nov. 13, 2020	Radiation (03CH13-HY)
Preamplifier	MITEQ	AMF-7D-0010 1800-30-10P	1590074	1GHz~18GHz	May 21, 2018	Apr. 15, 2019 ~ Apr. 28, 2019	May 20, 2019	Radiation (03CH13-HY)
Amplifier	Sonoma-Instrument	310 N	187282	9KHz~1GHz	Dec. 18, 2018	Apr. 15, 2019 ~ Apr. 28, 2019	Dec. 17, 2019	Radiation (03CH13-HY)
Amplifier	MITEQ	TTA1840-35-HG	1871923	18GHz~40GHz, VSWR : 2.5:1 max	Jul. 16, 2018	Apr. 15, 2019 ~ Apr. 28, 2019	Jul. 15, 2019	Radiation (03CH13-HY)
RF Cable	HUBER + SUHNER	SUCOFLEX 126E	0030/126E	30M-18G	Feb. 13, 2019	Apr. 15, 2019 ~ Apr. 28, 2019	Feb. 12, 2020	Radiation (03CH13-HY)
RF Cable	HUBER + SUHNER	SUCOFLEX 104	804793/4	30M-18G	Feb. 13, 2019	Apr. 15, 2019 ~ Apr. 28, 2019	Feb. 12, 2020	Radiation (03CH13-HY)
RF Cable	HUBER + SUHNER	SUCOFLEX 104	MY24961/4	30M-18G	Feb. 13, 2019	Apr. 15, 2019 ~ Apr. 28, 2019	Feb. 12, 2020	Radiation (03CH13-HY)
RF Cable	HUBER + SUHNER	SUCOFLEX 102	MY2859/2	30M~40GHz	Mar. 13, 2019	Apr. 15, 2019 ~ Apr. 28, 2019	Mar. 12, 2020	Radiation (03CH13-HY)
RF Cable	HUBER + SUHNER	SUCOFLEX 102	MY4274/2	30M~40GHz	Mar. 13, 2019	Apr. 15, 2019 ~ Apr. 28, 2019	Mar. 12, 2020	Radiation (03CH13-HY)
Spectrum Analyzer	Keysight	N9010A	MY55370526	10Hz~44GHz	Mar. 19, 2019	Apr. 15, 2019 ~ Apr. 28, 2019	Mar. 18, 2020	Radiation (03CH13-HY)
Antenna Mast	EMEC	AM-BS-4500-B	N/A	1m~4m	N/A	Apr. 15, 2019 ~ Apr. 28, 2019	N/A	Radiation (03CH13-HY)
Turn Table	EMEC	TT2000	N/A	0~360 Degree	N/A	Apr. 15, 2019 ~ Apr. 28, 2019	N/A	Radiation (03CH13-HY)
Software	AUDIX	E3 6.2009-8-24c	RK-001124	N/A	N/A	Apr. 15, 2019 ~ Apr. 28, 2019	N/A	Radiation (03CH13-HY)
EMI Test Receiver	Keysight	N9038A(MXE)	MY54130085	20Hz ~ 8.4GHz	Nov. 01, 2018	Apr. 15, 2019 ~ Apr. 28, 2019	Oct. 31, 2019	Radiation (03CH13-HY)
Filter	Woken	WHKX8-5272. 5-6750-18000 -40ST	SN5	6.75G Highpass	Mar. 13, 2019	Apr. 15, 2019 ~ Apr. 28, 2019	Mar. 12, 2020	Radiation (03CH13-HY)
Filter	Wainwright	WHKX12-108 0-1200-15000 -60ST	SN3	1.2G Low Pass	Jul. 05, 2018	Apr. 15, 2019 ~ Apr. 28, 2019	Jul. 04, 2019	Radiation (03CH13-HY)
Filter	Wainwright	WHKX12-270 0-3000-18000 -60SS	SN2	3G High Pass	Jul. 16, 2018	Apr. 15, 2019 ~ Apr. 28, 2019	Jul. 15, 2019	Radiation (03CH13-HY)



5 Uncertainty of Evaluation

Uncertainty of Radiated Emission Measurement (30 MHz ~ 1000 MHz)

Measuring Uncertainty for a Level of Confidence of 95% ($U = 2Uc(y)$)	4.9
---	-----

Uncertainty of Radiated Emission Measurement (1000 MHz ~ 18000 MHz)

Measuring Uncertainty for a Level of Confidence of 95% ($U = 2Uc(y)$)	5.4
---	-----

Uncertainty of Radiated Emission Measurement (18000 MHz ~ 40000 MHz)

Measuring Uncertainty for a Level of Confidence of 95% ($U = 2Uc(y)$)	4.3
---	-----



Appendix A. Radiated Spurious Emission

Test Engineer :	Alex Jheng, JC Liang, and Wilson Wu	Temperature :	24.8~25.2°C
		Relative Humidity :	50~51%

2.4GHz 2400~2483.5MHz + Band 1 - 5150~5250MHz

Ant 2_BT_Tx_Ch78 + Ant 2+5_11a_Tx_Ch36_Co-location (Band Edge @ 3m)

BT+WIFI Ant.	Note	Frequency (MHz)	Level (dBμV/m)	Over Limit (dB)	Limit Line (dBμV/m)	Read Level (dBμV)	Antenna Factor (dB/m)	Path Loss (dB)	Preamp Factor (dB)	Ant Pos (cm)	Table Pos (deg)	Peak Avg. (P/A)	Pol. (H/V)	
BT CH78 2480MHz	*	2480	108.56	-	-	106.6	27.46	4.07	29.57	329	79	P	H	
	*	2480	83.8	-	-	-	-	-	-	-	-	A	H	
		2483.52	60.58	-13.42	74	58.62	27.46	4.07	29.57	329	79	P	H	
		2483.52	35.82	-18.18	54	-	-	-	-	-	-	A	H	
													H	
	*	2480	105.77	-	-	103.81	27.46	4.07	29.57	330	136	P	V	
	*	2480	81.01	-	-	-	-	-	-	-	-	-	A	V
		2483.52	56.21	-17.79	74	54.25	27.46	4.07	29.57	330	136	P	V	
		2483.52	31.45	-22.55	54	-	-	-	-	-	-	-	A	V
														V
802.11a CH 36 5180MHz		5147.42	57.54	-16.46	74	49.26	31.69	6.08	29.49	260	80	P	H	
		5150	50.51	-3.49	54	42.23	31.69	6.08	29.49	260	80	A	H	
	*	5180	111.48	-	-	103.16	31.71	6.1	29.49	260	80	P	H	
	*	5180	104.13	-	-	95.81	31.71	6.1	29.49	260	80	A	H	
													H	
		5149.5	54.24	-19.76	74	45.96	31.69	6.08	29.49	400	84	P	V	
		5149.5	46.54	-7.46	54	38.26	31.69	6.08	29.49	400	84	A	V	
	*	5180	108.57	-	-	100.25	31.71	6.1	29.49	400	84	P	V	
	*	5180	101.48	-	-	93.16	31.71	6.1	29.49	400	84	A	V	
													V	
Remark	1. No other spurious found. 2. All results are PASS against Peak and Average limit line.													



Ant 2_BT_Tx_Ch78 + Ant 2+5_11a_Tx_Ch36_Co-location (Harmonic @ 3m)

WIFI Ant.	Note	Frequency (MHz)	Level (dBμV/m)	Over Limit (dB)	Limit Line (dBμV/m)	Read Level (dBμV)	Antenna Factor (dB/m)	Cable Loss (dB)	Preamp Factor (dB)	Ant Pos (cm)	Table Pos (deg)	Peak Avg. (P/A)	Pol. (H/V)	
Co-location		4960	49.81	-24.19	74	41.33	31.53	5.92	29.44	100	0	P	H	
		7440	43.09	-30.91	74	55.43	36.49	7.8	57.43	100	0	P	H	
		10360	46.76	-21.44	68.2	54.05	39.76	9.37	56.96	100	0	P	H	
		15540	44.75	-29.25	74	50.13	38.62	11.89	56.65	100	0	P	H	
													H	
													H	
													H	
													H	
			4960	49.5	-24.5	74	41.02	31.53	5.92	29.44	100	0	P	V
			7440	44.34	-29.66	74	56.68	36.49	7.8	57.43	100	0	P	V
			10360	46.75	-21.45	68.2	54.04	39.76	9.37	56.96	100	0	P	V
			15540	44.44	-29.56	74	49.82	38.62	11.89	56.65	100	0	P	V
													V	
													V	
													V	
													V	
Remark	1. No other spurious found. 2. All results are PASS against Peak and Average limit line.													



2.4GHz 2400~2483.5MHz + Band 1 - 5150~5250MHz

Ant 2_BLE_Tx_Ch39 + Ant 2+5_11a_Tx_Ch36_Co-location (Band Edge @ 3m)

BT+WIFI Ant.	Note	Frequency (MHz)	Level (dBμV/m)	Over Limit (dB)	Limit Line (dBμV/m)	Read Level (dBμV)	Antenna Factor (dB/m)	Path Loss (dB)	Preamp Factor (dB)	Ant Pos (cm)	Table Pos (deg)	Peak Avg. (P/A)	Pol. (H/V)	
BLE CH39 2480MHz	*	2480	102.53	-	-	90.64	27.46	4.07	29.57	338	69	P	H	
	*	2480	101.05	-	-	89.16	27.46	4.07	29.57	338	69	A	H	
		2483.64	55.2	-18.8	74	43.31	27.46	4.07	29.57	338	69	P	H	
		2483.52	47.03	-6.97	54	35.14	27.46	4.07	29.57	338	69	A	H	
													H	
														H
	*	2480	98.4	-	-	86.51	27.46	4.07	29.57	373	104	P	V	
	*	2480	97.02	-	-	85.13	27.46	4.07	29.57	373	104	A	V	
		2483.6	53.64	-20.36	74	41.75	27.46	4.07	29.57	373	104	P	V	
		2487.92	45.28	-8.72	54	33.35	27.5	4.07	29.57	373	104	A	V	
														V
														V
802.11a CH 36 5180MHz		5150	59.9	-14.1	74	51.62	31.69	6.08	29.49	300	66	P	H	
		5150	51.42	-2.58	54	43.14	31.69	6.08	29.49	300	66	A	H	
	*	5180	110.22	-	-	101.9	31.71	6.1	29.49	300	66	P	H	
	*	5180	103.16	-	-	94.84	31.71	6.1	29.49	300	66	A	H	
													H	
													H	
		5146.9	53.26	-20.74	74	44.98	31.69	6.08	29.49	400	88	P	V	
		5150	45.56	-8.44	54	37.28	31.69	6.08	29.49	400	88	A	V	
	*	5180	108.24	-	-	99.92	31.71	6.1	29.49	400	88	P	V	
	*	5180	100.86	-	-	92.54	31.71	6.1	29.49	400	88	A	V	
														V
														V
Remark	1. No other spurious found. 2. All results are PASS against Peak and Average limit line.													



Ant 2_BLE_Tx_Ch39 + Ant 2+5_11a_Tx_Ch36_Co-location (Harmonic @ 3m)

WIFI Ant.	Note	Frequency (MHz)	Level (dBμV/m)	Over Limit (dB)	Limit Line (dBμV/m)	Read Level (dBμV)	Antenna Factor (dB/m)	Cable Loss (dB)	Preamp Factor (dB)	Ant Pos (cm)	Table Pos (deg)	Peak Avg. (P/A)	Pol. (H/V)	
Co-location		4960	49.88	-24.12	74	41.4	31.53	5.92	29.44	100	0	P	H	
		7440	43	-31	74	55.34	36.49	7.8	57.43	100	0	P	H	
		10360	46.86	-21.34	68.2	54.15	39.76	9.37	56.96	100	0	P	H	
		15540	44.69	-29.31	74	50.07	38.62	11.89	56.65	100	0	P	H	
													H	
													H	
													H	
													H	
			4960	49.21	-24.79	74	40.73	31.53	5.92	29.44	100	0	P	V
			7440	43.23	-30.77	74	55.57	36.49	7.8	57.43	100	0	P	V
			10360	46.6	-21.6	68.2	53.89	39.76	9.37	56.96	100	0	P	V
			15540	44.79	-29.21	74	50.17	38.62	11.89	56.65	100	0	P	V
													V	
													V	
													V	
													V	
Remark	1. No other spurious found. 2. All results are PASS against Peak and Average limit line.													



Emission below 1GHz

Co-location (LF @ 3m)

WIFI Ant.	Note	Frequency (MHz)	Level (dBμV/m)	Over Limit (dB)	Limit Line (dBμV/m)	Read Level (dBμV)	Antenna Factor (dB/m)	Cable Loss (dB)	Preamp Factor (dB)	Ant Pos (cm)	Table Pos (deg)	Peak Avg. (P/A)	Pol. (H/V)	
Co-location LF		30.97	23.54	-16.46	40	31.63	23.74	0.45	32.29	-	-	P	H	
		68.8	23.59	-16.41	40	43.12	12.08	0.62	32.26	-	-	P	H	
		162.89	31.84	-11.66	43.5	46.56	16.36	0.99	32.17	-	-	P	H	
		271.53	28.52	-17.48	46	40.15	19.12	1.3	32.15	-	-	P	H	
		778.84	31.04	-14.96	46	32.44	28.14	2.24	31.93	-	-	P	H	
		959.26	35.18	-10.82	46	32.57	30.84	2.46	30.91	100	0	P	H	
														H
														H
														H
														H
														H
														H
			41.64	31.88	-8.12	40	45.25	18.4	0.48	32.29	-	-	P	V
			48.43	33.37	-6.63	40	50.1	15.03	0.51	32.29	100	0	P	V
			103.72	31.6	-11.9	43.5	46.57	16.38	0.8	32.21	-	-	P	V
			169.68	29.9	-13.6	43.5	45.26	15.68	1.02	32.16	-	-	P	V
			564.47	28.01	-17.99	46	32.33	25.87	1.94	32.22	-	-	P	V
			855.47	32.58	-13.42	46	32.39	29.19	2.46	31.62	-	-	P	V
													V	
													V	
													V	
													V	
													V	
													V	
Remark	1. No other spurious found. 2. All results are PASS against limit line.													



2.4GHz 2400~2483.5MHz + Band 1 - 5150~5250MHz

Ant 2_11b_Tx_Ch11 + Ant 5_11a_Tx_Ch36_Co-location (Band Edge @ 3m)

BT+WIFI Ant.	Note	Frequency (MHz)	Level (dBμV/m)	Over Limit (dB)	Limit Line (dBμV/m)	Read Level (dBμV)	Antenna Factor (dB/m)	Path Loss (dB)	Preamp Factor (dB)	Ant Pos (cm)	Table Pos (deg)	Peak Avg. (P/A)	Pol. (H/V)	
802.11b CH 11 2462MHz	*	2462	110.01	-	-	98.19	27.41	4.05	29.57	335	73	P	H	
	*	2462	106.81	-	-	94.99	27.41	4.05	29.57	335	73	A	H	
		2486.04	53.63	-20.37	74	41.74	27.46	4.07	29.57	335	73	P	H	
		2486	43.86	-10.14	54	31.97	27.46	4.07	29.57	335	73	A	H	
													H	
														H
	*	2462	105.55	-	-	93.73	27.41	4.05	29.57	378	114	114	P	V
	*	2462	102.25	-	-	90.43	27.41	4.05	29.57	378	114	114	A	V
		2487.4	52.86	-21.14	74	40.97	27.46	4.07	29.57	378	114	114	P	V
		2485.92	42.61	-11.39	54	30.72	27.46	4.07	29.57	378	114	114	A	V
														V
														V
802.11a CH 36 5180MHz		5150	57.69	-16.31	74	49.41	31.69	6.08	29.49	100	121	P	H	
		5150	48.06	-5.94	54	39.78	31.69	6.08	29.49	100	121	A	H	
	*	5180	103.4	-	-	95.08	31.71	6.1	29.49	100	121	P	H	
	*	5180	95.03	-	-	86.71	31.71	6.1	29.49	100	121	A	H	
														H
														H
		5148.46	56.18	-17.82	74	47.9	31.69	6.08	29.49	104	197	197	P	V
		5150	48.81	-5.19	54	40.53	31.69	6.08	29.49	104	197	197	A	V
	*	5180	103.49	-	-	95.17	31.71	6.1	29.49	104	197	197	P	V
	*	5180	95.28	-	-	86.96	31.71	6.1	29.49	104	197	197	A	V
														V
														V
Remark	1. No other spurious found. 2. All results are PASS against Peak and Average limit line.													



Ant 2_11b_Tx_Ch11 + Ant 5_11a_Tx_Ch36_Co-location (Harmonic @ 3m)

WIFI Ant.	Note	Frequency (MHz)	Level (dBμV/m)	Over Limit (dB)	Limit Line (dBμV/m)	Read Level (dBμV)	Antenna Factor (dB/m)	Cable Loss (dB)	Preamp Factor (dB)	Ant Pos (cm)	Table Pos (deg)	Peak Avg. (P/A)	Pol. (H/V)	
Co-location		4924	48.88	-25.12	74	41.01	31.46	5.84	29.43	100	0	P	H	
		7386	47.61	-26.39	74	60.04	36.37	7.76	57.36	100	0	P	H	
		10360	46.02	-22.18	68.2	53.31	39.76	9.37	56.96	100	0	P	H	
		15540	44.66	-29.34	74	50.04	38.62	11.89	56.65	100	0	P	H	
													H	
													H	
													H	
														H
			4924	47.99	-26.01	74	40.12	31.46	5.84	29.43	100	0	P	V
			7386	52.36	-21.64	74	64.79	36.37	7.76	57.36	100	146	P	V
			7386	47.34	-6.66	54	59.77	36.37	7.76	57.36	100	146	A	V
			10360	47.16	-21.04	68.2	54.45	39.76	9.37	56.96	100	0	P	V
			15540	44.45	-29.55	74	49.83	38.62	11.89	56.65	100	0	P	V
														V
														V
														V
Remark	1. No other spurious found. 2. All results are PASS against Peak and Average limit line.													



Note symbol

*	Fundamental Frequency which can be ignored. However, the level of any unwanted emissions shall not exceed the level of the fundamental frequency.
!	Test result is over limit line.
P/A	Peak or Average
H/V	Horizontal or Vertical



A calculation example for radiated spurious emission is shown as below:

WIFI	Note	Frequency	Level	Over	Limit	Read	Antenna	Cable	Preamp	Ant	Table	Peak	Pol.
Ant.				Limit	Line	Level	Factor	Loss	Factor	Pos	Pos	Avg.	
1+2		(MHz)	(dBμV/m)	(dB)	(dBμV/m)	(dBμV)	(dB/m)	(dB)	(dB)	(cm)	(deg)	(P/A)	(H/V)
802.11b		2390	55.45	-18.55	74	54.51	32.22	4.58	35.86	103	308	P	H
CH 01													
2412MHz		2390	43.54	-10.46	54	42.6	32.22	4.58	35.86	103	308	A	H

1. $Level(dB\mu V/m) =$

$Antenna\ Factor(dB/m) + Cable\ Loss(dB) + Read\ Level(dB\mu V) - Preamp\ Factor(dB)$

2. $Over\ Limit(dB) = Level(dB\mu V/m) - Limit\ Line(dB\mu V/m)$

For Peak Limit @ 2390MHz:

1. $Level(dB\mu V/m)$

$= Antenna\ Factor(dB/m) + Cable\ Loss(dB) + Read\ Level(dB\mu V) - Preamp\ Factor(dB)$

$= 32.22(dB/m) + 4.58(dB) + 54.51(dB\mu V) - 35.86(dB)$

$= 55.45(dB\mu V/m)$

2. $Over\ Limit(dB)$

$= Level(dB\mu V/m) - Limit\ Line(dB\mu V/m)$

$= 55.45(dB\mu V/m) - 74(dB\mu V/m)$

$= -18.55(dB)$

For Average Limit @ 2390MHz:

1. $Level(dB\mu V/m)$

$= Antenna\ Factor(dB/m) + Cable\ Loss(dB) + Read\ Level(dB\mu V) - Preamp\ Factor(dB)$

$= 32.22(dB/m) + 4.58(dB) + 42.6(dB\mu V) - 35.86(dB)$

$= 43.54(dB\mu V/m)$

2. $Over\ Limit(dB)$

$= Level(dB\mu V/m) - Limit\ Line(dB\mu V/m)$

$= 43.54(dB\mu V/m) - 54(dB\mu V/m)$

$= -10.46(dB)$

Both peak and average measured complies with the limit line, so test result is "PASS".



Appendix B. Radiated Spurious Emission Plots

Test Engineer :	Alex Jheng, JC Liang, and Wilson Wu	Temperature :	24.8~25.2°C
		Relative Humidity :	50~51%

Note symbol

-L	Low channel location
-R	High channel location

2.4GHz 2400~2483.5MHz

BT (Band Edge @ 3m)

BT	2.4GHz 2400~2483.5MHz Band Edge @ 3m	
	BT CH78 2480MHz	
	Horizontal	Fundamental
Peak	<p>Site : 03CH13-HV Condition : PEAK_BE_74 3m HORN_91200_1241 HORIZONTAL : RBW:1000.000KHz VBW:3000.000KHz SWT:Auto Detector : Peak Project : BN0616-05 Mode : 49</p>	<p>Site : 03CH13-HV Condition : PEAK_74 3m HORN_91200_1241 HORIZONTAL : RBW:1000.000KHz VBW:3000.000KHz SWT:Auto Detector : Peak Project : BN0616-05 Mode : 49</p>

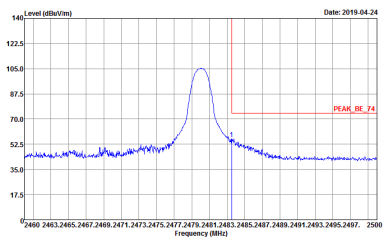
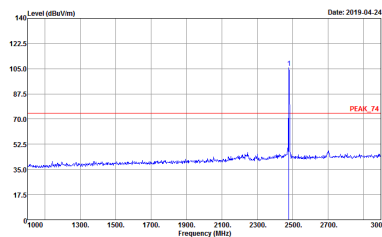

BT	2.4GHz 2400~2483.5MHz Band Edge @ 3m	
	BT CH78 2480MHz	
	Vertical	Fundamental
Peak	 <p>Site : 03CH13-HY Condition : PEAK_BE_74 3m HORN_91200_1241 VERTICAL RBW:1000.000KHz VBW:3000.000KHz SWT:Auto Detector : Peak Project : BN0616-05 Mode : 49</p>	 <p>Site : 03CH13-HY Condition : PEAK_74 3m HORN_91200_1241 VERTICAL RBW:1000.000KHz VBW:3000.000KHz SWT:Auto Detector : Peak Project : BN0616-05 Mode : 49</p>



Band 1 - 5150~5250MHz
WIFI 802.11a (Band Edge @ 3m)

WIFI	Band 1 5150~5250MHz Band Edge @ 3m	
ANT	802.11a CH36 5180MHz	
2+5	Horizontal	Fundamental
Peak	<p>Site : 03CH13-HY Condition : PEAK_BE_74 3m HORN_91200_1241 HORIZONTAL RBW:1000.000KHz VBW:3000.000KHz SWT:Auto Detector : Peak Project : 8N0616-05 Mode : 49 Power : 19</p>	<p>Site : 03CH13-HY Condition : PEAK(UNIT) 3m HORN_91200_1241 HORIZONTAL RBW:1000.000KHz VBW:3000.000KHz SWT:Auto Detector : Peak Project : 8N0616-05 Mode : 49 Power : 19</p>
Avg.	<p>Site : 03CH13-HY Condition : AVG_BE_54 3m HORN_91200_1241 HORIZONTAL RBW:1000.000KHz VBW:1000KHz SWT:Auto Detector : Peak Project : 8N0616-05 Mode : 49 Power : 19</p>	Left blank

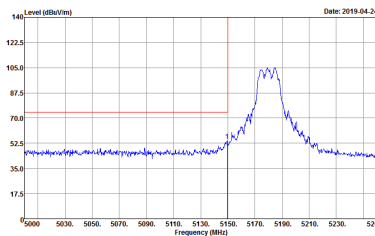
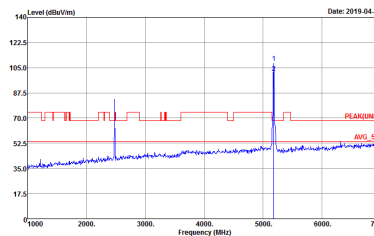
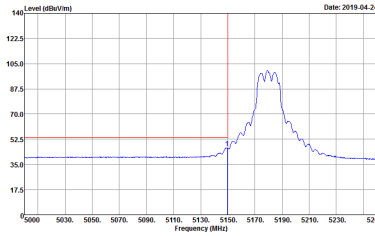

WIFI	Band 1 5150~5250MHz Band Edge @ 3m	
ANT	802.11a CH36 5180MHz	
2+5	Vertical	Fundamental
Peak	 <p>Site : 03CH13-HY Condition : PEAK_BE_74 3m HORN_91200_1241 VERTICAL RBW:1000.000KHz VBW:3000.000KHz SWT:Auto Detector : Peak Project : BN0616-05 Mode : 49 Power : 19</p>	 <p>Site : 03CH13-HY Condition : PEAK(UNIT) 3m HORN_91200_1241 VERTICAL RBW:1000.000KHz VBW:3000.000KHz SWT:Auto Detector : Peak Project : BN0616-05 Mode : 49 Power : 19</p>
Avg.	 <p>Site : 03CH13-HY Condition : AVG_BE_54 3m HORN_91200_1241 VERTICAL RBW:1000.000KHz VBW:1.000KHz SWT:Auto Detector : Peak Project : BN0616-05 Mode : 49 Power : 19</p>	Left blank



Ant 2_BT_Tx_Ch78 + Ant 2+5_11a_Tx_Ch36_Co-location

Ant 2_BT_Tx_Ch78 + Ant 2+5_11a_Tx_Ch36_Co-location		
	Horizontal	Vertical
<p>Peak Avg.</p>	<p>Site : 03CH13-44Y Condition : PEAK(LINE1) 3m HORN_9120D_1241 HORIZONTAL Detector : Peak Project : 8N0616-05 Mode : 49 BT_Ch78 : default 11a_Ch36 : 19</p>	<p>Site : 03CH13-44Y Condition : PEAK(LINE1) 3m HORN_9120D_1241 VERTICAL Detector : Peak Project : 8N0616-05 Mode : 49 BT_Ch78 : default 11a_Ch36 : 19</p>



2.4GHz 2400~2483.5MHz

BLE (Band Edge @ 3m)

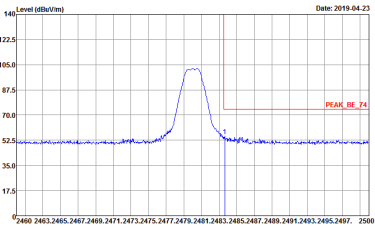
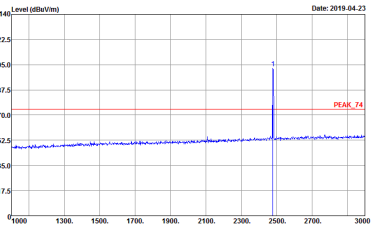
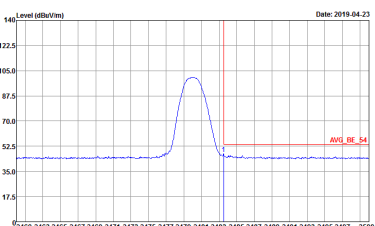
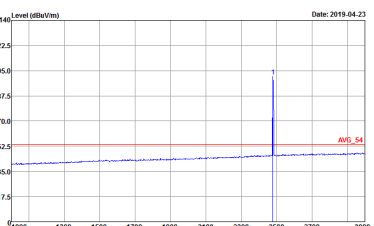
BLE	2.4GHz 2400~2483.5MHz Band Edge @ 3m	
	BLE CH39 2480MHz	
	Horizontal	Fundamental
Peak	 <p>Site : 03CH13-HY Condition : PEAK_BE_74 3m HORN_91200_1241 HORIZONTAL RBW:1000.000kHz VBW:3000.000kHz SWT:Auto Detector : Peak Project : BN0616-05 Mode : S2</p>	 <p>Site : 03CH13-HY Condition : PEAK_74 3m HORN_91200_1241 HORIZONTAL RBW:1000.000kHz VBW:3000.000kHz SWT:Auto Detector : Peak Project : BN0616-05 Mode : S2</p>
Avg.	 <p>Site : 03CH13-HY Condition : AVG_BE_54 3m HORN_91200_1241 HORIZONTAL RBW:1000.000kHz VBW:10.000kHz SWT:Auto Detector : Peak Project : BN0616-05 Mode : S2</p>	 <p>Site : 03CH13-HY Condition : AVG_54 3m HORN_91200_1241 HORIZONTAL RBW:1000.000kHz VBW:10.000kHz SWT:Auto Detector : Peak Project : BN0616-05 Mode : S2</p>

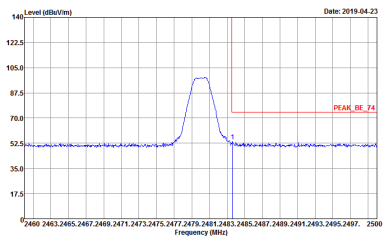
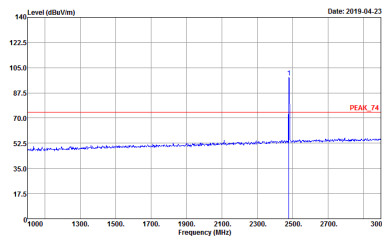
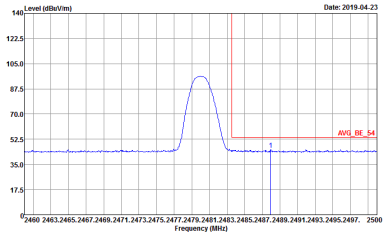
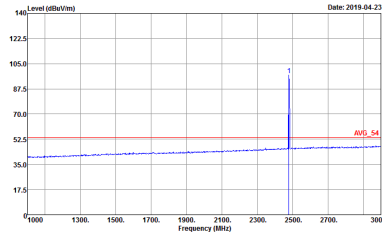

BLE	2.4GHz 2400~2483.5MHz Band Edge @ 3m	
	BLE CH39 2480MHz	
	Vertical	Fundamental
<p>Peak</p>	 <p>Site : 03CH13-IHY Condition : PEAK_BE_74 3m HORN_91200_1241 VERTICAL RBW:1000.000KHz VBW:3000.000KHz SWT:Auto Detector : Peak Project : BN0616-05 Mode : S2</p>	 <p>Site : 03CH13-IHY Condition : PEAK_74 3m HORN_91200_1241 VERTICAL RBW:1000.000KHz VBW:3000.000KHz SWT:Auto Detector : Peak Project : BN0616-05 Mode : S2</p>
<p>Avg</p>	 <p>Site : 03CH13-IHY Condition : AVG_BE_54 3m HORN_91200_1241 VERTICAL RBW:1000.000KHz VBW:10.000KHz SWT:Auto Detector : Peak Project : BN0616-05 Mode : S2</p>	 <p>Site : 03CH13-IHY Condition : AVG_54 3m HORN_91200_1241 VERTICAL RBW:1000.000KHz VBW:10.000KHz SWT:Auto Detector : Peak Project : BN0616-05 Mode : S2</p>



Band 1 - 5150~5250MHz
WIFI 802.11a (Band Edge @ 3m)

WIFI	Band 1 5150~5250MHz Band Edge @ 3m	
ANT	802.11a CH36 5180MHz	
2+5	Horizontal	Fundamental
Peak	<p>Site : 03CH13-HY Condition : PEAK_BE_74 3m HORN_91200_1241 HORIZONTAL RBW:1000.000KHz VBW:3000.000KHz SWT:Auto Detector : Peak Project : 8N0616-05 Mode : 52 Power : 19</p>	<p>Site : 03CH13-HY Condition : PEAK(UNIT) 3m HORN_91200_1241 HORIZONTAL RBW:1000.000KHz VBW:3000.000KHz SWT:Auto Detector : Peak Project : 8N0616-05 Mode : 52 Power : 19</p>
Avg.	<p>Site : 03CH13-HY Condition : AVG_BE_54 3m HORN_91200_1241 HORIZONTAL RBW:1000.000KHz VBW:1.000KHz SWT:Auto Detector : Peak Project : 8N0616-05 Mode : 52 Power : 19</p>	Left blank

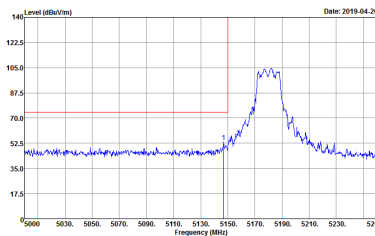
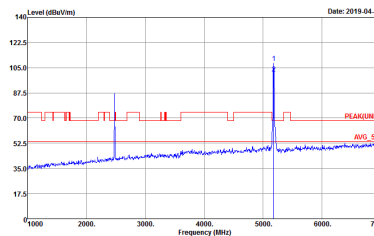
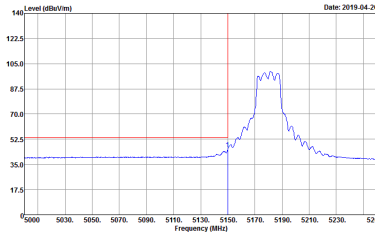

WIFI	Band 1 5150~5250MHz Band Edge @ 3m	
ANT	802.11a CH36 5180MHz	
2+5	Vertical	Fundamental
<p>Peak</p>	 <p>Site : 03CH13-HY Condition : PEAK_BE_74 3m HORN_91200_1241 VERTICAL RBW:1000.000KHz VBW:3000.000KHz SWT:Auto Detector : Peak Project : BN0616-05 Mode : 52 Power : 19</p>	 <p>Site : 03CH13-HY Condition : PEAK(UNIT) 3m HORN_91200_1241 VERTICAL RBW:1000.000KHz VBW:3000.000KHz SWT:Auto Detector : Peak Project : BN0616-05 Mode : 52 Power : 19</p>
<p>Avg.</p>	 <p>Site : 03CH13-HY Condition : AVG_BE_54 3m HORN_91200_1241 VERTICAL RBW:1000.000KHz VBW:1.000KHz SWT:Auto Detector : Peak Project : BN0616-05 Mode : 52 Power : 19</p>	<p>Left blank</p>



Ant 2_BLE_Tx_Ch39 + Ant 2+5_11a_Tx_Ch36_Co-location

Ant 2_BLE_Tx_Ch39 + Ant 2+5_11a_Tx_Ch36_Co-location		
	Horizontal	Vertical
<p>Peak</p> <p>Avg.</p>	<p>Site : 03CH13-11Y Condition : PEAK(LINE) 3m HORN_9120D_1241 HORIZONTAL Detector : Peak Project : 8N0616-05 Mode : 52 BLE_Ch39 : Default 11a_Ch36 : 19</p>	<p>Site : 03CH13-11Y Condition : PEAK(LINE) 3m HORN_9120D_1241 VERTICAL Detector : Peak Project : 8N0616-05 Mode : 52 BLE_Ch39 : Default 11a_Ch36 : 19</p>



Co-location_LF

Co-location_LF		
	Horizontal	Vertical
<p>QP / Peak</p>	<p>Site : 03CH13-HY Condition : QP 3m BILOG_37059401 HORIZONTAL Detector : Peak Project : 8N0616-05 Mode : 52</p>	<p>Site : 03CH13-HY Condition : QP 3m BILOG_37059401 VERTICAL Detector : Peak Project : 8N0616-05 Mode : 52</p>

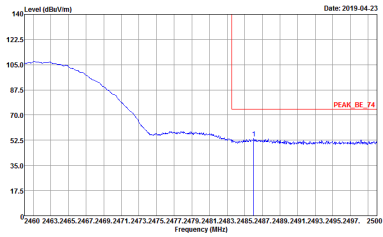
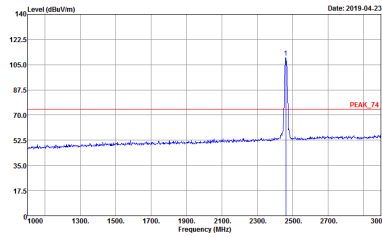
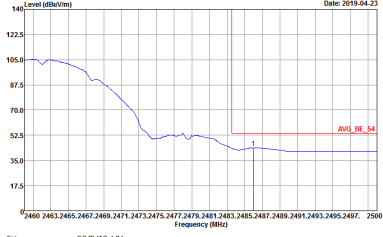
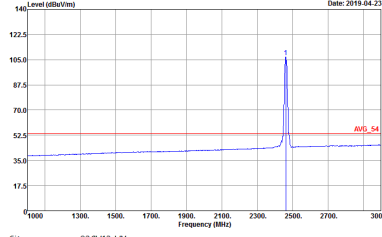

2.4GHz 2400~2483.5MHz
WIFI 802.11b (Band Edge @ 3m)

WIFI	2.4GHz 2400~2483.5MHz Band Edge @ 3m	
ANT	802.11b CH11 2462MHz	
2	Horizontal	Fundamental
Peak	 <p>Site : 03CH13-HY Condition : PEAK_BE_74 3m HORN_91200_1241 HORIZONTAL RBW:1000.000KHz VBW:3000.000KHz SWT:Auto Detector : Peak Project : 8N0616-05 Mode : 53 Power : 23</p>	 <p>Site : 03CH13-HY Condition : PEAK_74 3m HORN_91200_1241 HORIZONTAL RBW:1000.000KHz VBW:3000.000KHz SWT:Auto Detector : Peak Project : 8N0616-05 Mode : 53 Power : 23</p>
	 <p>Site : 03CH13-HY Condition : AVG_BE_54 3m HORN_91200_1241 HORIZONTAL RBW:1000.000KHz VBW:0.010KHz SWT:Auto Detector : Peak Project : 8N0616-05 Mode : 53 Power : 23</p>	 <p>Site : 03CH13-HY Condition : AVG_54 3m HORN_91200_1241 HORIZONTAL RBW:1000.000KHz VBW:0.010KHz SWT:Auto Detector : Peak Project : 8N0616-05 Mode : 53 Power : 23</p>

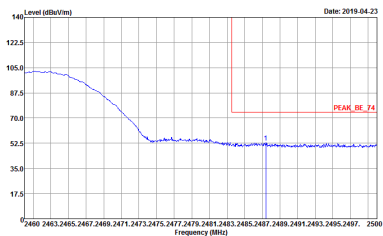
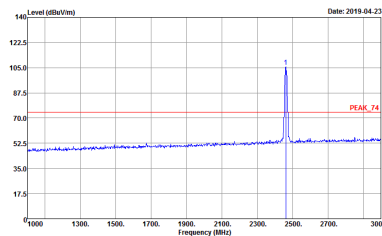
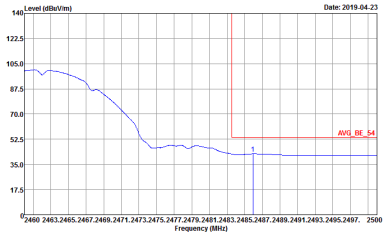
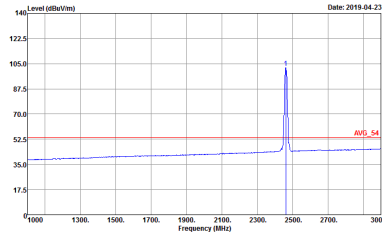

WIFI	2.4GHz 2400~2483.5MHz Band Edge @ 3m	
ANT	802.11b CH11 2462MHz	
2	Vertical	Fundamental
Peak	 <p>Site : 03CH13-HY Condition : PEAK_BE_74 3m HORN_91200_1241 VERTICAL RBW:1000.000KHz VBW:3000.000KHz SWT:Auto Detector : Peak Project : BN0616-05 Mode : 53 Power : 23</p>	 <p>Site : 03CH13-HY Condition : PEAK_74 3m HORN_91200_1241 VERTICAL RBW:1000.000KHz VBW:3000.000KHz SWT:Auto Detector : Peak Project : BN0616-05 Mode : 53 Power : 23</p>
Avg.	 <p>Site : 03CH13-HY Condition : AVG_BE_54 3m HORN_91200_1241 VERTICAL RBW:1000.000KHz VBW:0.010KHz SWT:Auto Detector : Peak Project : BN0616-05 Mode : 53 Power : 23</p>	 <p>Site : 03CH13-HY Condition : AVG_54 3m HORN_91200_1241 VERTICAL RBW:1000.000KHz VBW:0.010KHz SWT:Auto Detector : Peak Project : BN0616-05 Mode : 53 Power : 23</p>



Band 1 - 5150~5250MHz
WIFI 802.11a (Band Edge @ 3m)

WIFI	Band 1 5150~5250MHz Band Edge @ 3m	
ANT	802.11a CH36 5180MHz	
5	Horizontal	Fundamental
Peak	<p>Site : 03CH13-HY Condition : PEAK_BE_74 3m HORN_91200_1241 HORIZONTAL RBW:1000.000KHz VBW:3000.000KHz SWT:Auto Detector : Peak Project : 8N0616-05 Mode : 53 Power : 20.5</p>	<p>Site : 03CH13-HY Condition : PEAK(UNIT) 3m HORN_91200_1241 HORIZONTAL RBW:1000.000KHz VBW:3000.000KHz SWT:Auto Detector : Peak Project : 8N0616-05 Mode : 53 Power : 20.5</p>
Avg.	<p>Site : 03CH13-HY Condition : AVG_BE_54 3m HORN_91200_1241 HORIZONTAL RBW:1000.000KHz VBW:1000KHz SWT:Auto Detector : Peak Project : 8N0616-05 Mode : 53 Power : 20.5</p>	Left blank

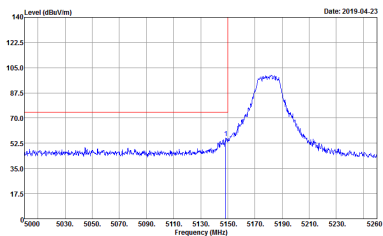
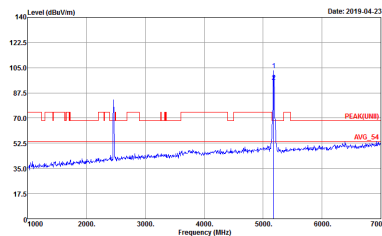
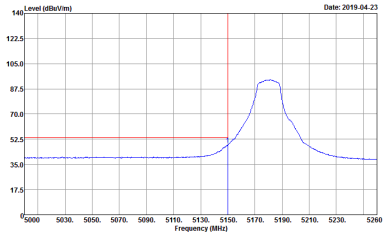

WIFI	Band 1 5150~5250MHz Band Edge @ 3m	
ANT	802.11a CH36 5180MHz	
5	Vertical	Fundamental
Peak	 <p>Site : 03CH13-HY Condition : PEAK_BE_74 3m HORN_91200_1241 VERTICAL RBW:1000.000KHz VBW:3000.000KHz SWT:Auto Detector : Peak Project : BN0616-05 Mode : 53 Power : 20.5</p>	 <p>Site : 03CH13-HY Condition : PEAK(UNIT) 3m HORN_91200_1241 VERTICAL RBW:1000.000KHz VBW:3000.000KHz SWT:Auto Detector : Peak Project : BN0616-05 Mode : 53 Power : 20.5</p>
Avg.	 <p>Site : 03CH13-HY Condition : AVG_BE_54 3m HORN_91200_1241 VERTICAL RBW:1000.000KHz VBW:1.000KHz SWT:Auto Detector : Peak Project : BN0616-05 Mode : 53 Power : 20.5</p>	Left blank



Ant 2_11b_Tx_Ch11 + Ant 5_11a_Tx_Ch36_Co-location

Ant 2_11b_Tx_Ch11 + Ant 5_11a_Tx_Ch36_Co-location		
	Horizontal	Vertical
<p>Peak Avg.</p>	<p>Site : 03CH13-HY Condition : PEAK(UNB) 3m HORN_9120D_1241 HORIZONTAL Detector : Peak Project : 8N0616-05 Mode : 53 11b_Ch11 : 23 11a_Ch36 : 20.5</p>	<p>Site : 03CH13-HY Condition : PEAK(UNB) 3m HORN_9120D_1241 VERTICAL Detector : Peak Project : 8N0616-05 Mode : 53 11b_Ch11 : 23 11a_Ch36 : 20.5</p>

Appendix C. Duty Cycle Plots

3DH5 on time (One Pulse) Plot on Channel 39

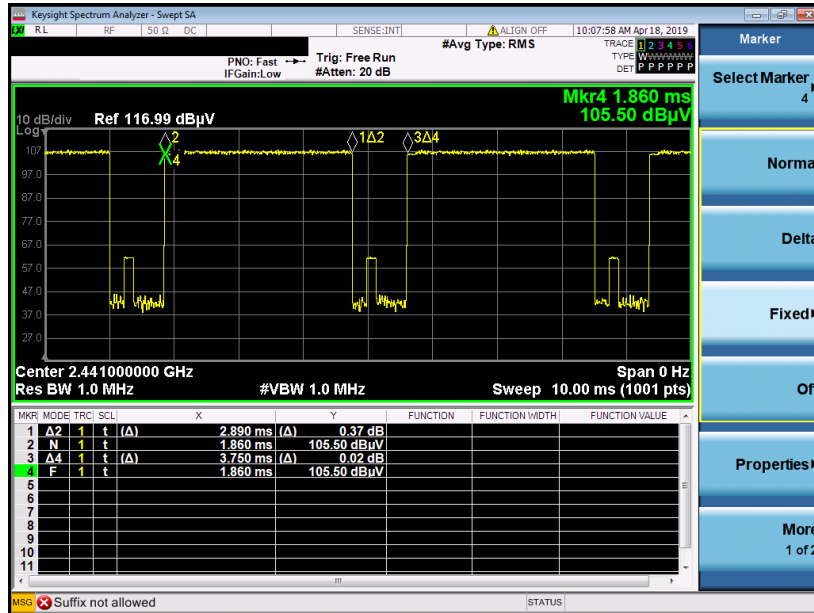

on time (Count Pulses) Plot on Channel 39

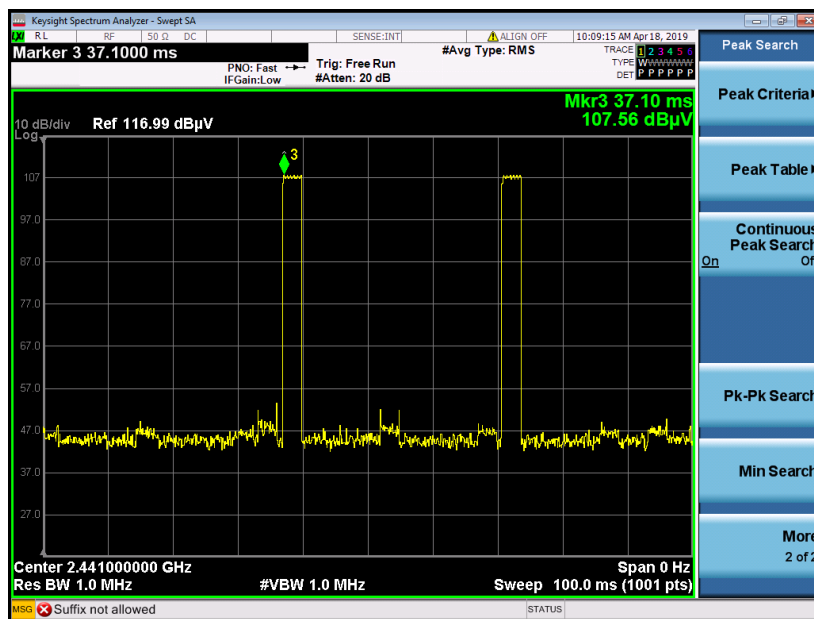

Note:

1. Worst case Duty cycle = on time/100 milliseconds = $2 * 2.89 / 100 = 5.78 \%$
2. Worst case Duty cycle correction factor = $20 * \log(\text{Duty cycle}) = -24.76 \text{ dB}$
3. **3DH5** has the highest duty cycle worst case and is reported.



Antenna	Band	Duty Cycle(%)	T(us)	1/T(kHz)	VBW Setting	Duty Factor(dB)
2	Bluetooth –LE for 1Mbps	62.18	388	2.58	3kHz	2.06
2	Bluetooth –LE for 2Mbps	32.48	204	4.90	10kHz	4.88
2+3	802.11b for Ant. 2	98.96	-	-	10Hz	0.05
2+5	5GHz 802.11a for Ant. 2	97.57	2048	0.49	1kHz	0.11
2+5	5GHz 802.11a for Ant. 5	97.26	2057	0.49	1kHz	0.12

Bluetooth - LE

<1Mbps>

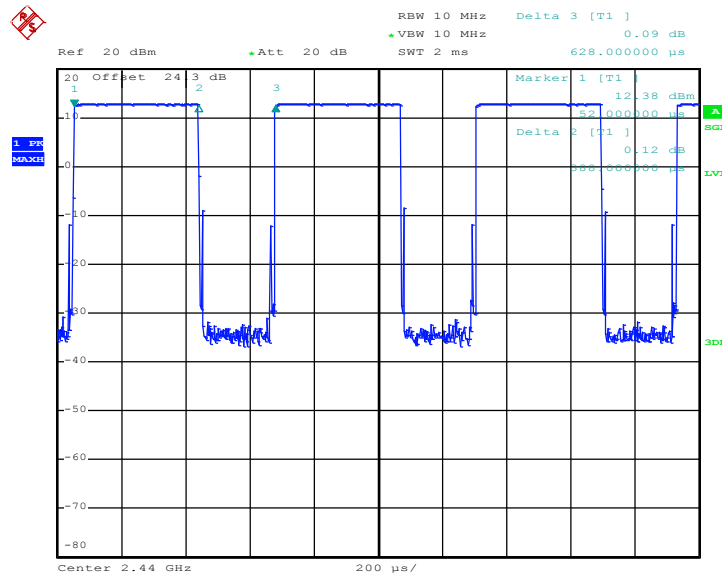

Date: 8.MAY.2019 10:43:30



<2Mbps>

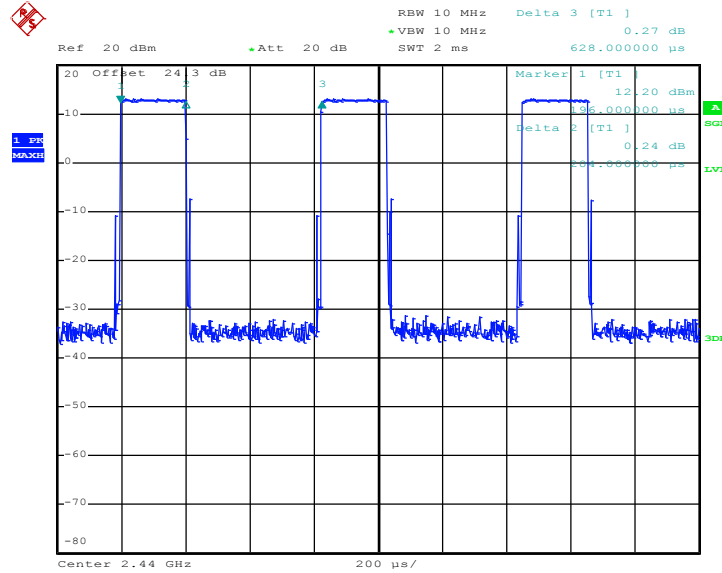

Date: 8.MAY.2019 10:58:32

MIMO <Ant. 2>

802.11b

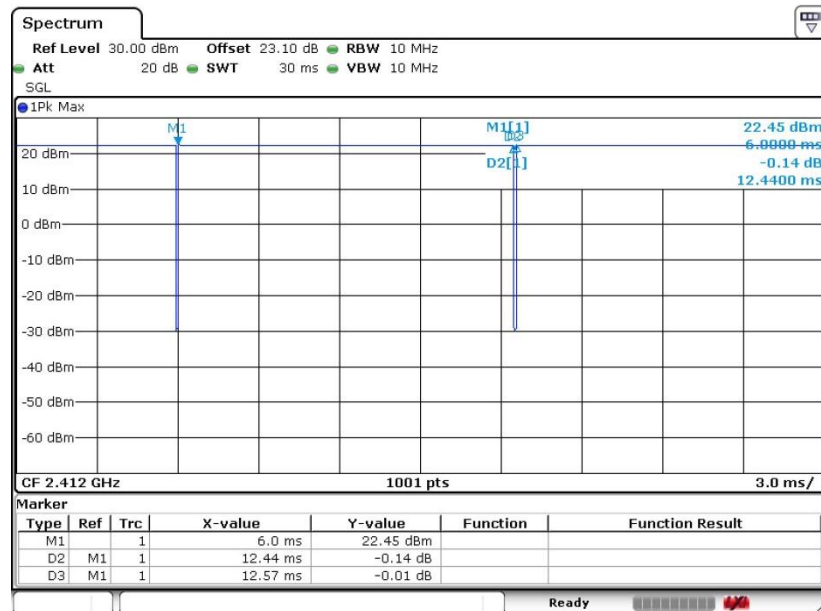

Date: 6.APR.2019 14:35:21



MIMO <Ant. 2>

802.11a

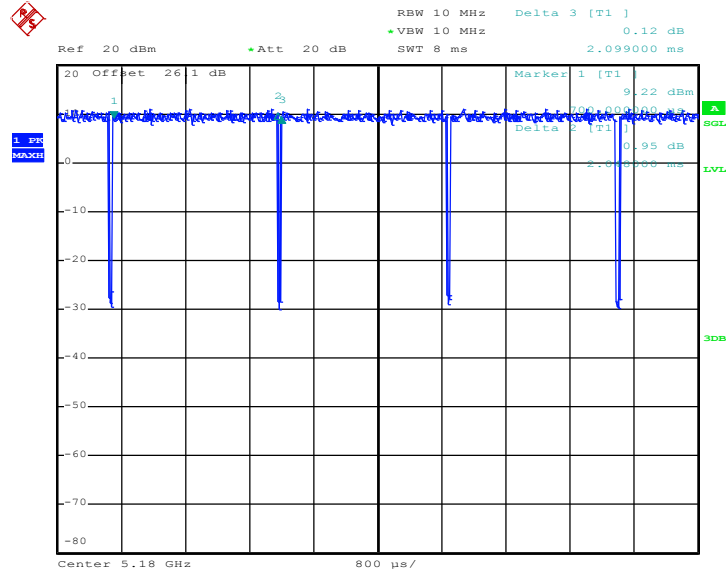

Date: 13.APR.2019 11:50:03

MIMO <Ant. 5>

802.11a

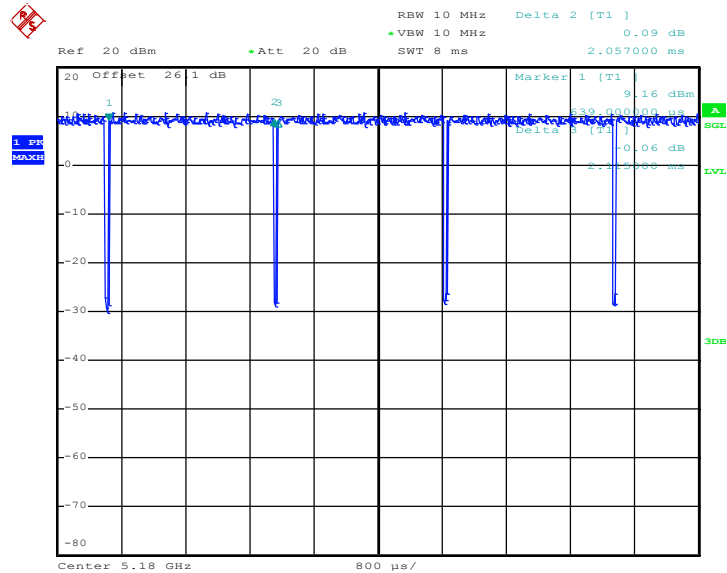

Date: 13.APR.2019 11:53:39

THE END